

SONY®

Data Projector

Operating Instructions

VPL-CS7

VPL-ES2

WARNING

To prevent fire or shock hazard, do not expose the unit to rain or moisture.

To avoid electrical shock, do not open the cabinet. Refer servicing to qualified personnel only.

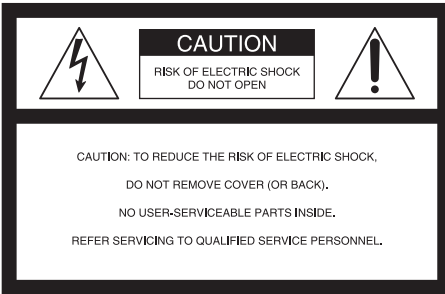

This symbol is intended to alert the user to the presence of uninsulated “dangerous voltage” within the product’s enclosure that may be of sufficient magnitude to constitute a risk of electric shock to persons.



This symbol is intended to alert the user to the presence of important operating and maintenance (servicing) instructions in the literature accompanying the appliance.

For the customers in the USA

If you have any questions about this product, you may call:

Sony Customer Information Service Center
1-800-222-7669 or <http://www.sony.com/>
The number below is for FCC related matters only.

Declaration of Conformity

Trade Name: SONY

Model No.: VPL-CS7/VPL-ES2

Responsible Party: Sony Electronics Inc.

Address: 16450 W. Bernardo Dr, San Diego, CA 92127 U.S.A.

Telephone Number: 858-942-2230

This device complies with Part 15 of the FCC Rules. Operation is subject to the following two conditions: (1) This device may not cause harmful interference, and (2) this device must accept any interference received, including interference that may cause undesired operation.

This equipment has been tested and found to comply with the limits for a Class B digital device, pursuant to Part 15 of the FCC Rules. These limits are designed to provide reasonable protection against harmful interference in a residential installation.

This equipment generates, uses, and can radiate radio frequency energy and, if not installed and used in accordance with the instructions, may cause harmful interference to radio communications. However, there is no guarantee that interference will not occur in a particular installation. If this equipment does cause harmful interference to radio or television reception, which can be determined by turning the equipment off and on, the user is encouraged to try to correct the interference by one or more of the following measures:

- Reorient or relocate the receiving antenna.
- Increase the separation between the equipment and receiver.
- Connect the equipment into an outlet on a circuit different from that to which the receiver is connected.
- Consult the dealer or an experienced radio/TV technician for help.

You are cautioned that any changes or modifications not expressly approved in this manual could void your authority to operate this equipment.

For the customers in Canada

This Class B digital apparatus complies with Canadian ICES-003.

Voor de klanten in Nederland



Gooi de batterij niet weg
maar lever deze in als klein
chemisch afval (KCA).

The socket-outlet should be installed near
the equipment and be easily accessible.

CAUTION

RISK OF EXPLOSION IF BATTERY IS
REPLACED BY AN INCORRECT TYPE.
DISPOSE OF USED BATTERIES
ACCORDING TO THE
INSTRUCTIONS.

Table of Contents

Overview

Precautions	6
Notes on Installation and Usage	7
Features	9
Location and Function of Controls ..	11
Top/Front/Left Side	11
Rear/Right Side/Bottom	11
Control Panel	12
Connector Panel	13
Remote Commander	14

Projecting the Picture

Installing the Projector	16
Connecting the Projector	17
Connecting with a Computer	17
Connecting with a VCR	18
Connecting with a Monitor Equipment (VPL-CS7 only)	19
Projecting	19
Turning Off the Power	21

Convenient Function

Selecting the Menu Language	23
Security Lock	24
Other Functions	25
Off & Go Function (VPL-CS7 only)	25
Effective Tools for Your Presentation	26

Adjustments and Settings Using the Menu

Using the MENU	27
The PICTURE SETTING Menu	29
The INPUT SETTING Menu	31
The SET SETTING Menu	33
The MENU SETTING Menu	35
The INSTALL SETTING Menu	36
The INFORMATION Menu	38

Maintenance

Replacing the Lamp	40
Cleaning the Air Filter	42

Others

Troubleshooting	43
Messages List	46
Specifications	48
Index	52

Precautions

On safety

- Check that the operating voltage of your unit is identical with the voltage of your local power supply.
- Should any liquid or solid object fall into the cabinet, unplug the unit and have it checked by qualified personnel before operating it further.
- Unplug the unit from the wall outlet if it is not to be used for several days.
- To disconnect the cord, pull it out by the plug. Never pull the cord itself.
- The wall outlet should be near the unit and easily accessible.
- The unit is not disconnected to the AC power source (mains) as long as it is connected to the wall outlet, even if the unit itself has been turned off.
- Do not look into the lens while the lamp is on.
- Do not place your hand or objects near the ventilation holes. The air coming out is hot.
- Be careful not to have your fingers caught by the adjuster. The powered tilt adjuster of this unit automatically extends when the power is turned on, and is put away automatically when the power is turned off. Do not touch the unit while the adjuster is in operation. Adjust the powered tilt adjuster carefully after its automatic operation is completed.
- Do not spread a cloth or paper under the unit.

On illumination

- To obtain the best picture, the front of the screen should not be exposed to direct lighting or sunlight.
- Ceiling-mounted spot lighting is recommended. Use a cover over fluorescent lamps to avoid lowering the contrast ratio.
- Cover any windows that face the screen with opaque draperies.
- It is desirable to install the projector in a room where floor and walls are not of

light-reflecting material. If the floor and walls are of reflecting material, it is recommended that the carpet and wall paper be changed to a dark color.

On preventing internal heat build-up

After you turn off the power with the I /  key, do not disconnect the unit from the wall outlet while the cooling fan is still running.

Caution

The projector is equipped with ventilation holes (intake) and ventilation holes (exhaust). Do not block or place anything near these holes, or internal heat build-up may occur, causing picture degradation or damage to the projector.

On cleaning

- To keep the cabinet looking new, periodically clean it with a soft cloth. Stubborn stains may be removed with a cloth lightly dampened with a mild detergent solution. Never use strong solvents, such as thinner, benzene, or abrasive cleansers, since these will damage the cabinet.
- Avoid touching the lens. To remove dust on the lens, use a soft dry cloth. Do not use a damp cloth, detergent solution, or thinner.
- Clean the filter at regular intervals.

On LCD data projector

- The LCD data projector is manufactured using high-precision technology. You may, however, see tiny black points and/or bright points (red, blue, or green) that continuously appear on the LCD data projector. This is a normal result of the manufacturing process and does not indicate a malfunction.

Notes on Installation and Usage

Unsuitable Installation

Do not install the projector in the following situations. **These installations may cause a malfunction or damage** to the projector.

Poorly ventilated

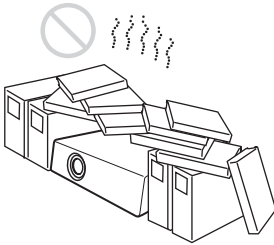

- Allow adequate air circulation to prevent internal heat build-up. Do not place the unit on surfaces (rugs, blankets, etc.) or near materials (curtains, draperies) that may block the ventilation holes. When the internal heat builds up due to the block-up, the temperature sensor will function with the message “High temp.! Lamp off in 1 min.” The power will be turned off automatically after one minute.
- Leave space of more than 30 cm (11 ⁷/₈ inches) around the unit.
- Be careful that the ventilation holes may inhale tininess such as a piece of paper.

Highly heated and humid



- Avoid installing the unit in a location where the temperature or humidity is very high, or temperature is very low.

- To avoid moisture condensation, do not install the unit in a location where the temperature may rise rapidly.

Subject to direct cool or warm air from an air-conditioner

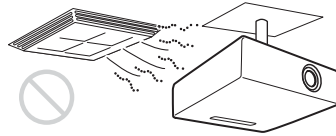

Installing in such a location may cause malfunction of the unit due to moisture condensation or rise in temperature.

Near a heat or smoke sensor

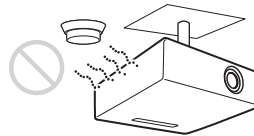

Malfunction of the sensor may be caused.

Very dusty, extremely smoky

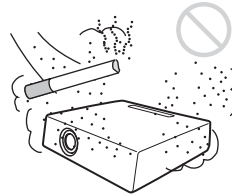

Avoid installing the unit in a very dusty or extremely smoky environment. Otherwise, the air filter will become obstructed, and this may cause a malfunction of the unit or damage it. Dust preventing the air passing through the filter may cause a rise in the internal temperature of the unit. Clean the filter periodically.

Unsuitable Conditions

Do not use the projector under the following conditions.

Topping the unit

Avoid using as the unit topples over on its side. It may cause malfunction.

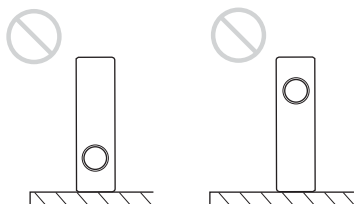

Tilting the unit out of the range of the adjuster setting



Avoid using when the unit is tilted out of the range of the adjuster setting. Such installation may cause color shading or shorten excessively the lamp life.

Tilting the unit to the right or left

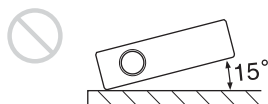

Avoid tilting the unit to an angle of 15°, and avoid installing the unit in any way other than placing on the floor or suspending from the ceiling. Such installation may cause color shading or shorten the lamp life excessively.

Blocking the ventilation holes

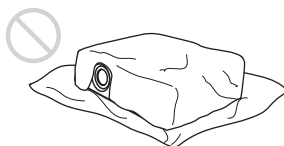

Avoid using something to cover over the ventilation holes (exhaust/intake); otherwise, the internal heat may build up.

For details on the ventilation holes (intake/exhaust), see “Location and Function of Controls” on page 11.

Usage in High Altitude

When using the projector at an altitude of 1,500 m or higher, turn on “High Altitude Mode” in the INSTALL SETTING menu. Failing to set this mode when using the projector at high altitudes could have adverse effects, such as reducing the reliability of certain components.

Note on carrying the projector

The unit is manufactured using high-precision technology. When transporting the unit stored in the soft case, do not drop the unit or subject it to shock, as this may cause damage. When storing the unit in the soft case, disconnect the AC power cord and all other connecting cables, and store the supplied accessories in a pocket of the soft case.

Note on the screen

When using a screen with an uneven surface, stripes pattern may rarely appear on the screen depending on the distance between the screen and the projector or the zooming magnifications. This is not a malfunction of the projector.

Features

High brightness, high picture quality

- **High brightness**

This projector is equipped with a high-efficiency optical system made possible by adopting Sony's proprietary optical system that is equipped with a newly developed LCD panel.

Because the VPL-CS7 utilizes a 185 W UHP lamp, it can reproduce bright images at 1800 ANSI lumen, while the VPL-ES2 utilizes a 157 W UHP lamp, that can reproduce bright images at 1500 ANSI lumen.

- **High resolution**

Three superhigh-aperture 0.62-inch SVGA panels with approximately 480,000 pixels provide a resolution of 800 × 600 dots (horizontal/vertical) for RGB input, and 600 horizontal TV lines for video input.

High operability

- **Intelligent Auto-setup function**

Simply press the power key, and the projector automatically performs the setups required before use. The projector opens the lens protector, corrects the V Keystone, and sets optimum conditions for projection. This function is called Intelligent Auto-setup.

For easier operations, the keys that will be used frequently are allocated on the top of the projector.

Short focus lens equipped

This projector is equipped with a short focus lens that allows outputting to a larger screen even in a limited space.

Various picture modes (VPL-ES2 only)

The best image can be projected by choosing the mode suitable for the type of program or room environment from among six picture modes.

Accepts various input signals

- **Scan converter loaded**

This projector has a build-in scan converter that converts the input signal within 800 × 600 dots.

- **Compatible input signals**

This projector accepts video signals of composite, S video, component and DTV as well as VGA, SVGA and XGA signals, which all can be displayed.

- **Compatible with six color systems**

NTSC, PAL, SECAM, NTSC^{4.43}*, PAL-M, or PAL-N color system can be selected automatically.

Easy presentation

- **Simple setup with external equipment**

This projector is preset for 32 kinds of input signals. You can project images from an external signal source just by connecting the equipment with the supplied cable.

* NTSC^{4.43} is the color system used when playing back a video recorded on NTSC on a NTSC^{4.43} system VCR.

- Windows is a registered trademark of Microsoft Corporation in the United States and/or other countries.
- VGA, SVGA and XGA are registered trademarks of the International Business Machines Corporation, U.S.A.
- Kensington is a registered trademark of Kensington Technology Group.
- Macintosh is a registered trademark of Apple Computer, Inc.
- VESA is a registered trademark of Video Electronics Standard Association.
- Display Data Channel is a trademark of Video Electronics Standard Association.

Easy-to-use Remote Commander

The Remote Commander is equipped with various convenient keys, including the D ZOOM key for zooming in on the image and the FREEZE key for keeping the image projected even if the equipment is disconnected.

High portability

- **Light weight/small size/simple design**

This projector has been miniaturized to approx. 2.8 kg (6 lb 3 oz) (VPL-ES2)/ approx. 2.9 kg (6 lb 6 oz) (VPL-CS7) in weight and B5-file size.

Its simple yet sophisticated design fits comfortably in your office.

Off & Go function (VPL-CS7 only)

The cooling fan built in the projector will work even after turning the power off and the power cord is disconnected. This enables you to move the projector to another location immediately after turning it off.

Security functions

Security lock

This function makes it possible to project no picture on the screen unless the required password is entered when the projector is turned on.

Panel key lock

This function locks all the operation keys on the control panel of the projector, allowing use of the keys on the Remote Commander. This prevents the projector from operating incorrectly.

Location and Function of Controls

Top/Front/Left Side

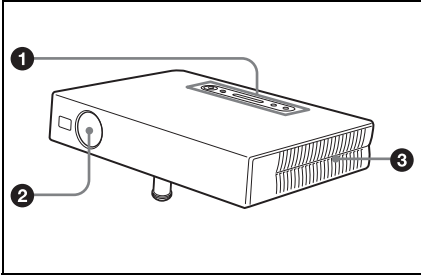

Rear/Right Side/Bottom

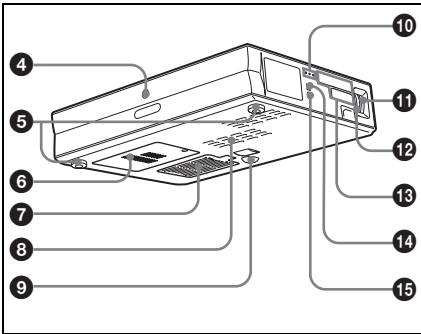

1 Control panel

For details, see “Control Panel” on page 12.

2 Lens protector (lens cover)

The lens protector automatically opens when the power is turned on.

3 Ventilation holes (exhaust)

4 Remote control detector

5 Adjuster (hind pad)

Turn the adjuster to the right or left for minor tilt adjustment of the projected picture.

6 Ventilation holes (intake)/Lamp cover

7 Ventilation holes (intake)/air filter cover

Notes

- Do not place anything near the ventilation holes as it may cause internal heat build-up.
- Do not place your hand or objects near the ventilation holes as it may cause the air coming out heat build-up.
- To maintain optimal performance, clean the air filter every 500 hours.

For details, see “Cleaning the Air Filter” on page 42.

8 Ventilation holes (intake)

9 Powered tilt adjuster

10 Indicators

POWER SAVING

Lights up when the projector is in power saving mode.

TEMP (Temperature)/FAN

Lights up or flashes under the following conditions:

- Lights up when temperature inside the projector becomes unusually high.
- Flashes when the fan is broken.

LAMP/COVER

Lights up or flashes under the following conditions:

- Lights up when the lamp has reached the end of its life or becomes a high temperature.
- Flashes when the lamp cover is not secured firmly.

For details, see pages 34, 45.

11 Focus ring

Adjusts the picture focus.

12 Zoom ring

Adjusts the picture size.

13 Connector panel

For details, see “Connector Panel” on page 13.

14 Speaker

15 Security lock

Connects to an optional security cable (Kensington’s).

Web page address:

<http://www.kensington.com/>

Control Panel

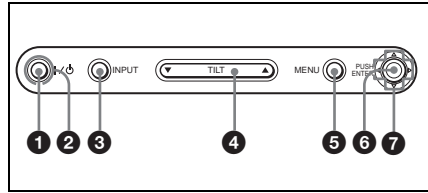

1 I / ⏻ (on/standby) key

Turns on the projector when the projector is in standby mode. The ON/STANDBY indicator around the I / ⏻ key lights in green when the power is turned on.

2 ON/STANDBY indicator (located around the I / ⏻ key)

Lights up or flashes under the following conditions:

- Lights in red when a AC power cord is plugged into a wall outlet. Once in standby mode, you can turn on the projector with the I / ⏻ key.
- Lights in green when the power is turned on.
- Flashes in green while the cooling fan runs for about 90 seconds (VPL-ES2)/ for about 70 seconds (VPL-CS7) after the power is turned off with the I / ⏻ key.

For details, see page 21.

3 INPUT key

4 TILT adjustment key

For details, see “Projecting” on page 19.

5 MENU key

Displays the on-screen menu. Press again to clear the menu.

6 ENTER key

Enters the settings of items in the menu system.

7 Arrow keys (Δ/▽/◀/▶)

Select the menu or to make various adjustments.

Connector Panel

VPL-CS7

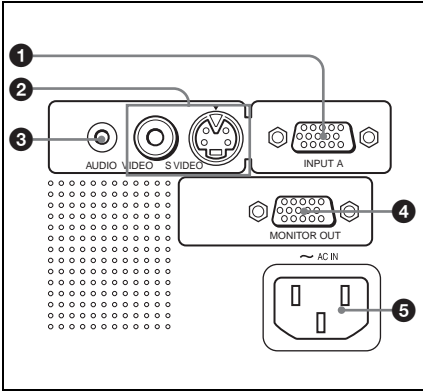

VPL-ES2

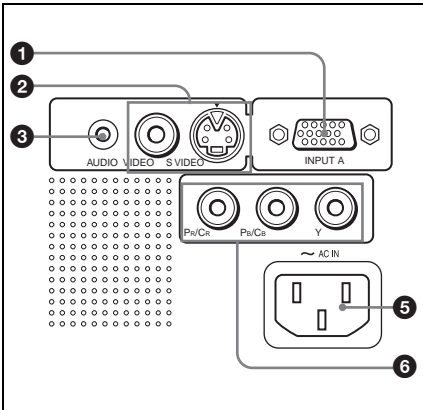

1 INPUT A connector (HD D-sub 15-pin, female)

Connect to external equipment such as a computer.

Connects to the monitor output on a computer using the supplied cable. When inputting a component or 15k RGB signal, use an optional cable.

For details, see "To connect to a video GBR/component output connector" on page 18.

2 Video input connector

Connect to external video equipment such as a VCR.

- **VIDEO (phono type):** Connects to the composite video output of video equipment.
- **S VIDEO (mini DIN 4-pin):** Connects to the S video output (Y/C video output) of video equipment.

3 AUDIO (stereo minijack) connector

When listening to sound output from the computer, connect to the audio output of the computer.

When listening to sound output from the VCR, connect to the audio output of the VCR.

4 Monitor output connector (VPL-CS7 only)

Connects to the monitor input on a monitor. Outputs the signal from a computer connected to INPUT A.

5 AC IN socket

Connects the supplied AC power cord.

6 Component input connector (for VPL-ES2 only)

According to the connected equipment, component (Y/CB/CR), HDTV or DTV (Y/PB/PR) signal is selected.

Remote Commander

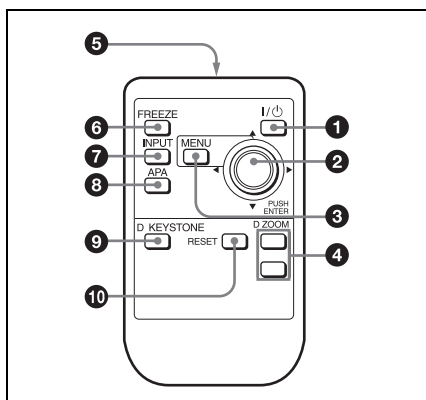

- 1 I / ⏻ (on/standby) key**
- 2 ENTER/arrow key (▲/▼/◀/▶)**
Press the center of the key to use ENTER.
- 3 MENU key**
- 4 D ZOOM +/- key**
Enlarges the image at a desired location on the screen.
- 5 Infrared transmitter**
- 6 FREEZE key**
Used to freeze the picture projected. To cancel the freeze function, press the key again.
- 7 INPUT key**
- 8 APA (Auto Pixel Alignment) key**
Adjusts a picture clearest automatically while a signal is input from a computer.
For details, see “Smart APA” in the SET SETTING menu on page 33.
- 9 D KEYSTONE key**
Used to adjust the tilt of the projector, or the trapezoidal distortion of the image manually. Each time you press this key, the Tilt menu and the V Keystone menu is displayed alternately. Use the arrow key (▲/▼/◀/▶) for the adjustment.

10 RESET key

Resets the value of an item back to its factory preset value or returns the enlarged image back to its original size. This key functions when the menu or a setting item is displayed on the screen.

Before using the Remote Commander

Pull out the clear film from the lithium battery holder.

To replace battery

- 1 Release the lock of the lithium battery holder by picking it, and pull out the holder from the Remote Commander.

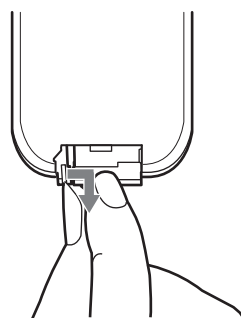

- 2 Install the lithium battery.

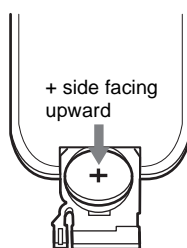

- 3 Put the lithium battery holder back into the Remote Commander.

Notes on the lithium battery

- Keep the lithium battery out of the reach of children.
- Should the battery be swallowed, immediately consult a doctor.

Notes on Remote Commander operation

- Make sure that nothing obstructs the infrared beam between the Remote Commander and the remote control detector on the projector. Direct the Remote Commander toward the remote control detector.
- The operation range is limited. The shorter the distance between the Remote Commander and the remote control detector is, the wider the angle within which the commander can control the projector becomes.

Installing the Projector

This section describes how to install the projector.

The distance between the lens and the screen varies depending on the size of the screen. Use the following table as a guide.

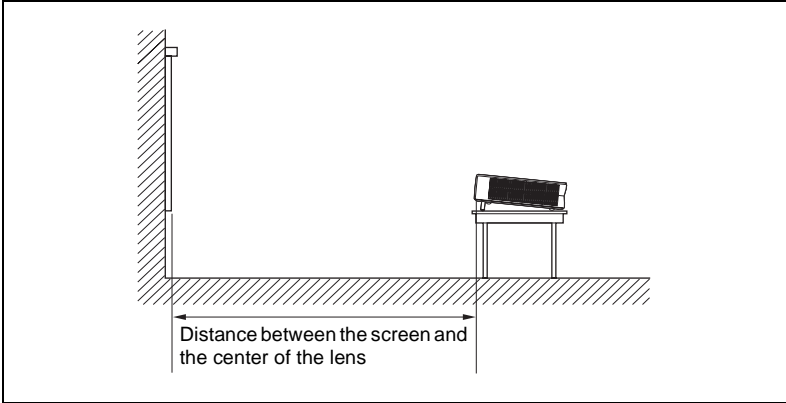

Unit: m (feet)

Screen size (inches)	40	60	80	100	120	150	200	300
Minimum Distance	1.1 (3.6)	1.7 (5.6)	2.3 (7.5)	2.9 (9.5)	3.5 (11.5)	4.4 (14.4)	5.9 (19.4)	8.8 (28.9)
Maximum Distance	1.4 (4.6)	2.1 (6.9)	2.8 (9.2)	3.5 (11.5)	4.2 (13.8)	5.3 (17.4)	7.0 (23)	10.6 (34.8)

There may be a slight difference between the actual value and the design value shown in the table above.

Connecting the Projector

When you connect the projector, make sure to:

- Turn off all equipment before making any connections.
- Use the proper cables for each connection.
- Insert the cable plugs firmly; loose connections may increase noise and reduce performance of picture signals. When pulling out a cable, be sure to pull it out from the plug, not the cable itself

Connecting with a Computer

This section describes how to connect the projector to a computer. For more information, refer to the computer's instruction manual.

To connect a computer

Ex. VPL-CS7

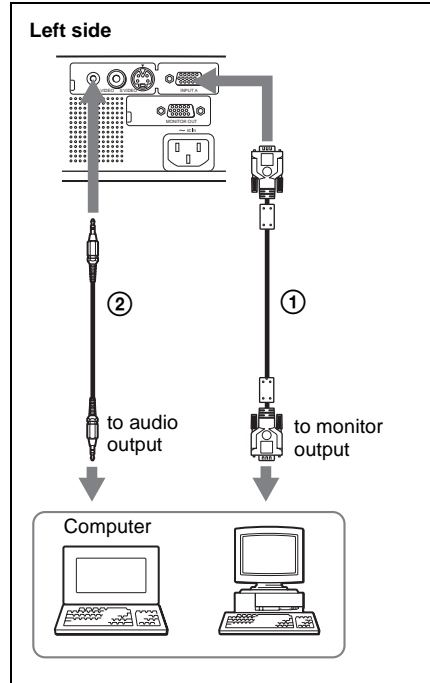

- ① HD D-sub 15-pin cable (supplied)
- ② Stereo audio connecting cable (not supplied)
(Use a no-resistance cable)

Notes

- The projector accepts VGA, SVGA, XGA signals. However, we recommend that you set the output mode of your computer to SVGA mode for the external monitor.
- If you set your computer, such as a notebook type, to output the signal to both your computer's display and the external monitor, the picture of the external monitor may not appear properly. Set your computer to output the signal to only the external monitor.

For details, refer to the computer's operating instructions supplied with your computer.

Note

To connect a Macintosh computer equipped with video output connector of a type having two rows of pins, use a commercially available plug adaptor.

Connecting with a VCR

This section describes how to connect the projector to a VCR.

For more information, refer to the instruction manuals of the equipment you are connecting.

To connect to a video or S video output connector

Ex. VPL-CS7

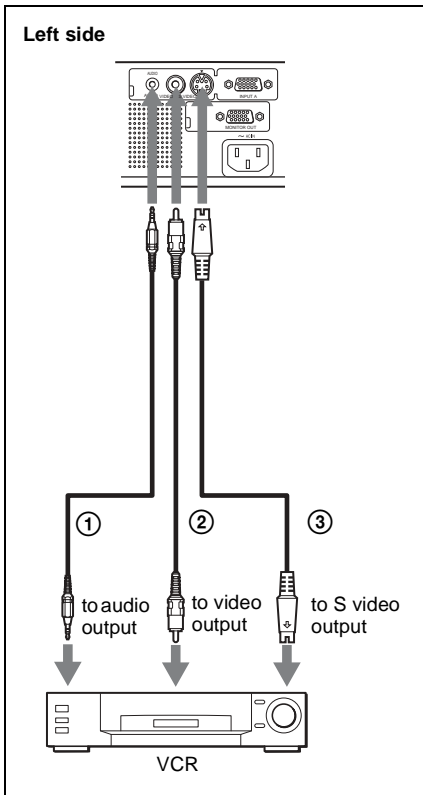

- ① Stereo audio connecting cable (not supplied)
(Use a no-resistance cable)
- ② Video cable (not supplied) or
- ③ S-Video cable (not supplied)

To connect to a video GBR/ component output connector

Ex. VPL-ES2

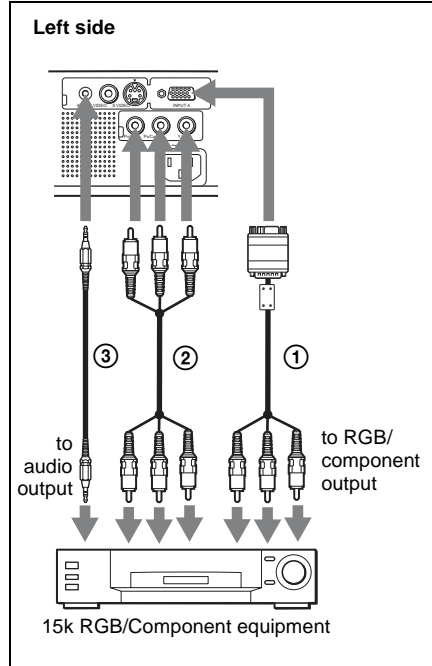

- ① SMF-402 Signal Cable (not supplied)
HD D-sub 15-pin (male) ↔ 3 × phono plug
or
- ② Component video (3 × phono plug ↔ 3 ×
phono plug (not supplied) (Use a 75 Ω
coaxial cable) (VPL-ES2 only))
- ③ Stereo audio connecting cable (not supplied)
(Use a no-resistance cable)

Notes

- Set the aspect ratio using “Wide Mode” in the INPUT SETTING menu according to the input signal.
- When you connect the INPUT A connector on the unit to a video GBR output connector, select “Video GBR,” or when you connect it to a component output connector, select “component” with the “Input-A Signal Sel.” setting in the SET SETTING menu. The input selection must be performed before inputting the signal.
- Use the composite sync signal when you input the external sync signal from video GBR/component equipment.

Connecting with a Monitor Equipment (VPL-CS7 only)

This section describes how to connect the projector to a monitor equipment. For more information, refer to the instruction manuals of the equipment you are connecting.

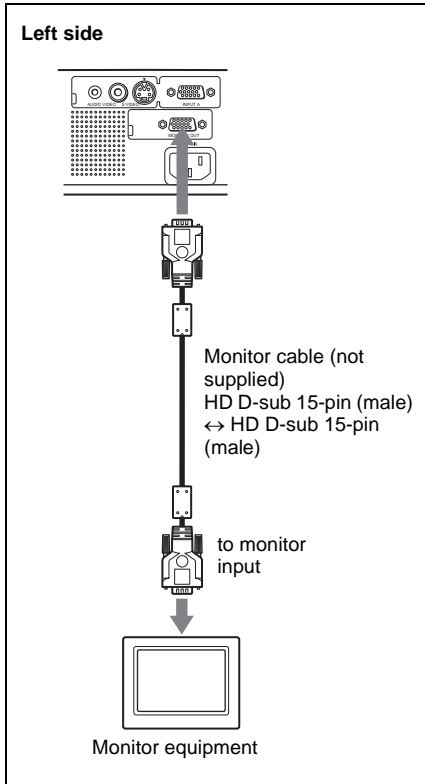

* This projector is not guaranteed for connecting more than 2 monitors in loop-through connection.

Projecting

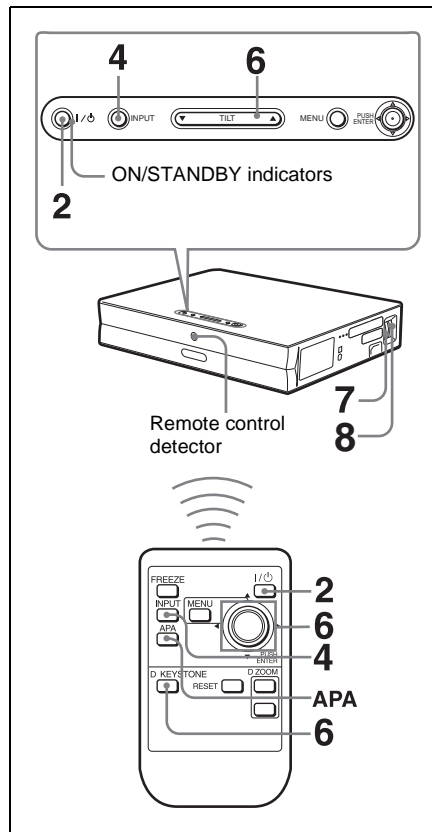

Projecting the Picture

- 1 Plug the AC power cord into a wall outlet, then connect all equipment. The ON/STANDBY indicator lights in red and the projector goes into standby mode.
- 2 Press the I / ⏻ key. The ON/STANDBY indicator lights in green and the Intelligent Auto-setup starts. The lens protector opens, and the powered tilt adjuster rises and stops at the previously adjusted position.
- 3 Turn on the equipment connected to the projector.

4 Press the INPUT key to select the input source.

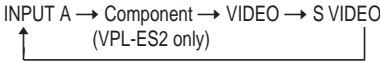

Each time you press the key, the input signal switches as follows:



To input from	Press INPUT to display
Computer connected to the INPUT A connector	INPUT A
Equipment connected to the component connector	Component (VPL-ES2 only)
Video equipment connected to the VIDEO input connector	VIDEO
Video equipment connected to the S VIDEO input connector	S VIDEO

Smart APA (Auto Pixel Alignment) adjusts the picture of the connected equipment so that it is projected clearly.

5 Switch the equipment to be connected to output to the projector.

Depending on the type of your computer, for example a notebook, or an all-in-one LCD type, you may have to switch the computer to output to the projector by pressing certain keys (e.g., LCD/VGA, , , etc.), or by changing your computer's settings.

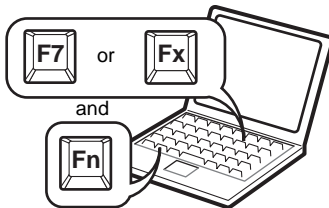

Fx:"x" indicate an optional numerical value. The Fx key varies depending on a computer's makers.

Notes

- If "Auto Input Search" is set to "On," the projector searches for the signals from the connected equipment and displays the input channel where the input signals are found.

For details, see "Auto Input Search" in the SET SETTING menu on page 33.

- The Smart APA is effective for the input signal from a computer only.

6 Adjust the position of the picture.

To adjust using the Remote Commander

To adjust the position of the picture, using the Remote Commander, press the D KEYSTONE key on the Remote Commander to display the Tilt menu and adjust the tilt using the ▲/▼/◀/▶ keys.

To adjust using the Control Panel

Press Δ on ▽ of the TILT key to adjust the tilt of the projector.

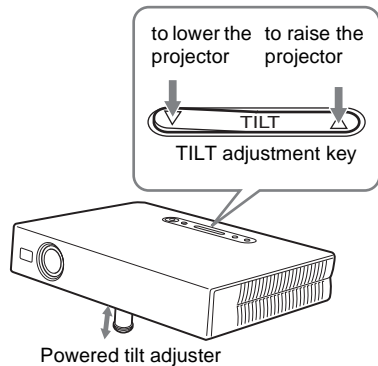

Notes

- When you adjust the powered tilt adjuster with the TILT key, the V keystone adjustment is performed at the same time. If you do not want to perform the automatic keystone adjustment, set the V Keystone menu to "Manual." (See page 36.)
- If you set the "V Keystone" adjustment to "Auto," the "V Keystone" correction is automatically adjusted. However, it may not be perfectly adjusted depending

on the room temperature or the screen angle. In this case, adjust it manually. Press the D KEYSTONE key on the Remote Commander until “V Keystone” appears on the screen, and adjust the value with the ▲/▼/▲/► key. The corrected value is effective until the power turn off.

- Be careful not to let the projector down on your fingers.
- Do not push hard on the top of the projector with the powered tilt adjuster out. It may be occurred malfunction.

7 Turn the zoom ring to adjust the size of the picture.

8 Turn the focus ring to adjust the focus.

Attention

Looking into the lens when projecting may cause injury to your eyes.

Turning Off the Power

- 1** Press the I / ⏻ key.
“POWER OFF? Please press I / ⏻ key again.” appears to confirm that you want to turn off the power.

Note

A message disappears if you press any key except the I / ⏻ key, or if you do not press any key for five seconds.

- 2** Press the I / ⏻ key again.
The powered tilt adjuster is put away in the projector and the lens protector closes. The ON/STANDBY indicator flashes in green and the fan continues to run for about 70 seconds (VPL-CS7)/for about 90 seconds (VPL-ES2) to reduce the internal heat. Also, the ON/STANDBY indicator flashes quickly for the first 60 seconds. During this time, you will not be able to light up again the ON/STANDBY indicator with the I / ⏻ key.

- 3** Unplug the AC power cord from the wall outlet after the fan has stopped running and the ON/STANDBY indicator has light in red.

When you cannot confirm the on-screen message

When you cannot confirm the on-screen message in a certain condition, you can turn off the power by holding the I / ⏻ key for about two seconds.

Notes

- **Do not unplug the AC power cord while the fan is still running;** otherwise, the fan will stop even though the internal heat is still high, which could result in a breakdown of the projector. (VPL-ES2 only)
- The internal circuitry of the Off & Go function may cause the fan to continue to operate for a short time even after the I /  key is pressed to turn off the power and the ON/STANDBY indicator changes to red. (VPL-CS7 only)

For details, see “Off & Go Function (VPL-CS7 only)” on page 25.

Selecting the Menu Language

You can select one of fifteen languages for displaying the menu and other on-screen displays. The factory setting is English. To change the menu language, proceed as follows:

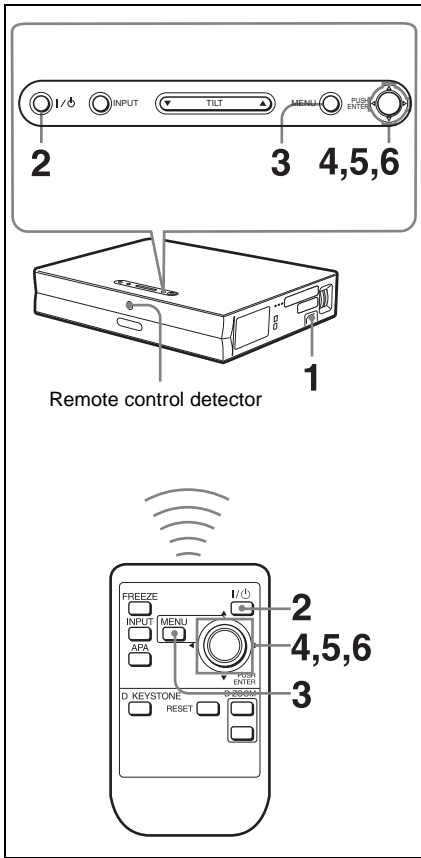

- 1 Plug the AC power cord into a wall outlet.
- 2 Press the I / \odot key to turn on the projector.
- 3 Press the MENU key. The menu appears.

The menu presently selected is shown as a yellow button.

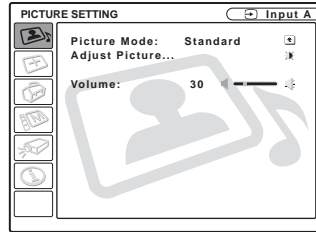

- 4 Press the \blacktriangle or \blacktriangledown key to select the MENU SETTING menu, then press the \blacktriangleright or ENTER key. The selected menu appears.

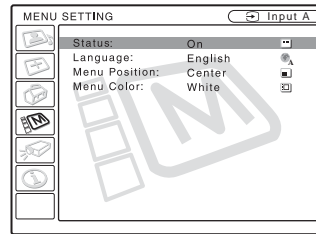

- 5 Press the \blacktriangle or \blacktriangledown key to select "Language," then press the \blacktriangleright or ENTER key.

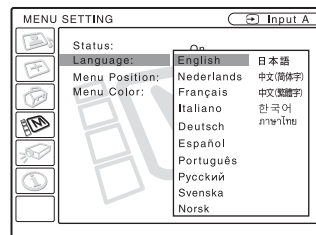

- 6 Press the \blacktriangle , \blacktriangledown , \blacktriangleleft or \blacktriangleright key to select a language, then press the ENTER key. The menu changes to the selected language.

To clear the menu

Press the MENU key. The menu disappears automatically if a key is not pressed for one minute.

Security Lock

The projector is equipped with a security lock function. When you turn the power of the projector on, you are required to input the previously set password. If you do not input the correct password, you will not be able to project the picture.

Note

You will not be able to use the projector if you forget your password and the password administrator is not available. Be please aware that using the security lock can prevent valid usage in such cases.

To use the security lock

1 Press the MENU key and then, in the INSTALL SETTING menu, turn on the “Security Lock” setting.

2 Enter the password.

Use the MENU, ▲/▼/◀/▶, and ENTER keys to enter the four-digit password. (The default setting is “ENTER, ENTER, ENTER, ENTER.” Input “ENTER” four times when you use the projector for the first time.)

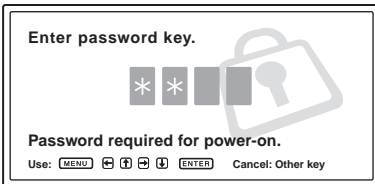

Next, the screen for entering a new password is displayed. (Enter the current password at this screen if you want to keep it.)

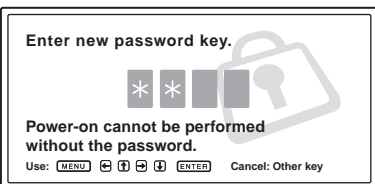

3 Enter the password again to confirm.



The security lock is completed when the following message appears.

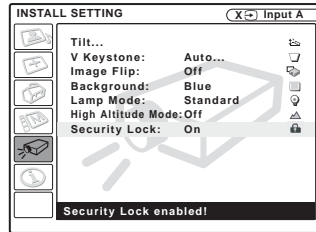

If the menu screen displays an “Invalid Password!” message, do over again from step 1.

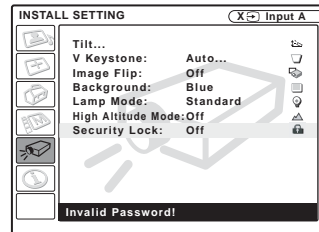

4 Turn the main power off and disconnect the AC power cord.

The security lock is set to on, then it becomes effective. The screen for entering the password is displayed when the power is turned on the next time.

Security certification

When the screen for entering the password is displayed, enter the password that was set. If you fail to enter the correct password after three tries, the projector cannot be used. In this case, press the I / ⏻ key to turn off the power.

To cancel the security lock

- 1 Press the MENU key, then turn off the “Security Lock” setting in the INSTALL SETTING menu.
- 2 Enter the password.
Enter the password that was set.

Note

If you call the customer service center because you have forgotten the password, you will need to be able to verify the projector’s serial number and your identity. (This process may differ in other countries.) Once your identity has been confirmed, we will provide you with the password.

Other Functions

Off & Go Function (VPL-CS7 only)

If you are leaving the conference room immediately, turn the projector off, the powered tilt adjuster is put away in the projector, and then, after the lens protector closes, you can unplug the AC power cord. After the AC power cord is unplugged, the fan runs for a certain time automatically.

Notes

- When unplugging the AC power cord, ensure that the powered tilt adjuster is put away in the projector and the lens protector closes. Moving the projector with the powered tilt adjuster raised may damage the adjuster.
- Turn off the projector according to the procedure in “Turning off the power”, then cool it down when storing the projector in the carrying case.
- However, if the unit has been on for less than 15 minutes, the fan might not begin to turn as a result of inadequate charging. In that case, follow the procedure for turning off the power as described in “Turning Off the Power” on page 21.



Effective Tools for Your Presentation

To enlarge the image (Digital Zoom function)

You can select a point in the image to enlarge. This function works when a signal from a computer is input.

This function does not work when a video signal is input.

- 1 Project a normal image, and press the D ZOOM + key on the Remote Commander.

The digital zoom icon appears in the center of the image.

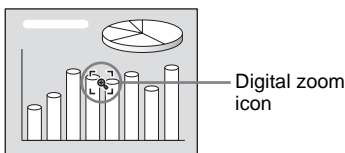

- 2 Move the icon to the point on the image you want to enlarge. Use the arrow key (▲/▼/◀/▶) to move the icon.

- 3 Press the D ZOOM + key again.
The image where the icon is located is enlarged. The enlargement ratio is displayed on the screen for a few seconds.
By pressing the + key repeatedly, the image size increases (ratio of enlargement: max. 4 times.)

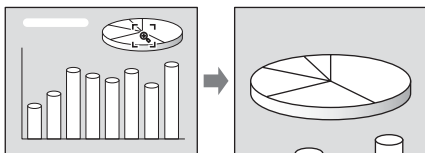

Use the arrow key (▲/▼/◀/▶) to scroll the enlarged image.

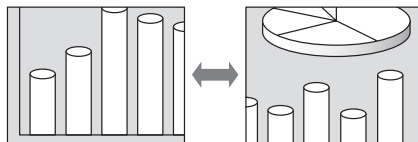

To return the image back to its original size

Press the D ZOOM – key.

Just pressing the RESET key returns the image back to its original size immediately.

To freeze the image projected (Freeze function)

Press the FREEZE key. “Freeze” appears when the key is pressed. This function works when a signal from a computer is input. To restore the original screen, press the FREEZE key again.

Using the MENU

The projector is equipped with an on-screen menu for making various adjustments and settings.

Display items

Input signal indicator



Input signal setting indicator

Picture adjustment menu

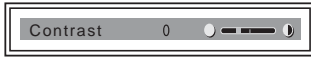

Input signal indicator

Shows the selected input channel. x(→) is displayed when no signal is input. You can hide this indicator using “Status” in the MENU SETTING menu.

Input signal setting indicator

For Input A: Shows “Computer,” “Component” or “Video GBR.”
For Video/S Video input: Shows “Auto” or the “Color System” setting in the SET SETTING menu.

1 Press the MENU key.

The menu appears.

The menu presently selected is shown as a yellow button.

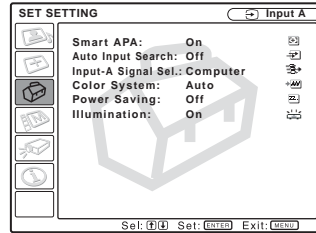

2 Use the ▲ or ▼ key to select a menu, then press the ► or ENTER key.

The selected menu appears.

3 Select an item.

Use the ▲ or ▼ key to select the item, then press the ► or ENTER key.

The setting items are displayed in a pop-up menu or in a sub menu.

Pop-up menu

Menu Setting items Selected input signal

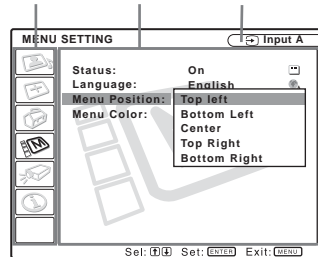

Sub menu

Menu Setting items

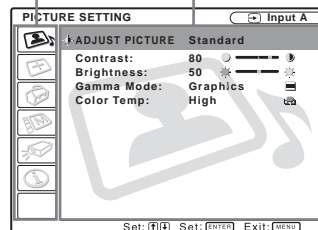

- 4** Make the setting or adjustment on an item.
- When changing the adjustment level:
To increase the number, press the ▲ or ► key.
To decrease the number, press the ▼ or ◀ key.
Press the ENTER key to restore the previous screen.
 - When changing the setting:
Press the ▲ or ▼ key to change the setting.
Press the ENTER or ◀ key to restore the previous screen.

When setting the Menu Language, see “Selecting the Menu Language” on page 23.

To clear the menu

Press the MENU key.

The menu disappears automatically if a key is not pressed for one minute.

To reset items that have been adjusted

Press the RESET key on the Remote Commander.

“Complete!” appears on the screen and **the settings appearing on the screen are reset to their factory preset values.**

Items that can be reset are:

- “Contrast,” “Brightness,” “Color,” “Hue,” and “Sharpness” in the Adjust Picture... menu.
- “Dot Phase,” “H Size,” and “Shift” in the Adjust Signal... menu

About the memory of the settings

The settings are automatically stored in the projector memory.

If no signal is input

If there is no input signal, “Cannot adjust this item.” appears on the screen.

About unadjustable items

Items that cannot be adjusted depending on the input signal are not displayed in the menu.

For details, see page 39.

The PICTURE SETTING Menu

The PICTURE SETTING menu is used for adjusting the picture or volume.

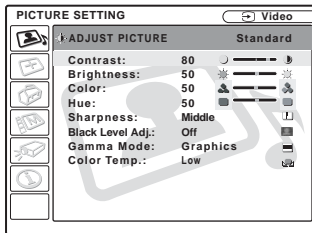
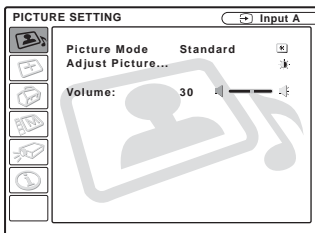

Setting items	Functions	Initial setting value
Picture Mode	<p>Selects the picture mode.</p> <ul style="list-style-type: none"> • Dynamic: Emphasizes the contrast to produce a “dynamic” picture. • Standard: Normally select this setting. If the picture has roughness with the “Dynamic” setting, this setting reduces the roughness. The following picture mode can be used for VPL-ES2 only. • Game: Select for viewing game picture. • Living: Select for viewing sports, music, digital video camera picture. • Cinema: Select for viewing film-like picture. • Presentation: Select for viewing presentation files 	according to an input signal
Volume	Adjusts the volume.	30
Adjust Picture...	The unit can store the setting values of the following sub menu items for each “Dynamic,” “Standard” or “Game,” “Living,” “Cinema,” “Presentation” (VPL-ES2 only) picture mode separately.	
Contrast	Adjusts the picture contrast.	according to an input signal
Brightness	Adjusts the picture brightness.	according to an input signal
Color	Adjusts color intensity.	according to an input signal
Hue	Adjusts color tones. The higher the setting, the picture becomes greenish. The lower the setting, the picture becomes purplish.	50
Sharpness	Selects the picture sharpness from among “High,” “Middle” and “Low.” The “High” setting makes the picture sharp; the “Low” setting makes it soft.	according to an input signal

Setting items	Functions	Initial setting value
	Black Level Adj. (VPL-ES2 only)	Using black level adjustment results in a vivid image with clearly defined light and dark areas. Set the black compensation in accordance with the image source. High: Strong black compensation Low: Weak black compensation Off: No black compensation
	Gamma Mode	Selects a gamma correction curve. <ul style="list-style-type: none"> • Graphics: Improves the reproduction of halftones. Photos can be reproduced in natural tones. • Text: Contrasts black and white. Suitable for images that contain lots of text.
	Color Temp.	Adjusts the color temperature. <ul style="list-style-type: none"> • High: Makes the white color bluish. • Low: Makes the white color reddish.

The INPUT SETTING Menu

The INPUT SETTING menu is used to adjust the input signal.

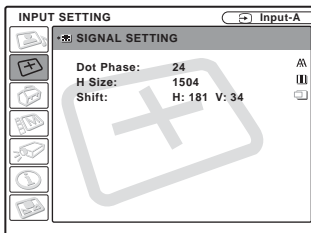
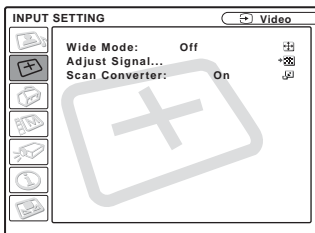

Setting items	Functions	Initial setting value
Wide Mode	Sets the aspect ratio of the picture. <ul style="list-style-type: none"> • Off: When the picture with ratio 4:3 is input. • On: When the picture with ratio 16:9 (squeezed) is input from equipment such as a DVD player. 	according to a picture mode
Adjust Signal...		
Dot Phase	Adjusts the dot phase of the LCD panel and the signal output from a computer. Adjust the picture further for finer picture after the picture is adjusted by pressing the APA key.	according to an input signal
H Size	Adjusts the horizontal size of picture output from a connector. Adjust the setting according to the dots of the input signal. For details, see page 50.	according to an input signal
Shift	Adjusts the position of the picture. H adjusts the horizontal position of the picture. V adjusts the vertical position of the picture. As the setting for H increases, the picture moves to the right, and as the setting decreases, the picture moves to the left. As the setting for V increases, the picture moves up, and as the setting decreases, the picture moves down. Use the ◀ or the ▶ key to adjust the horizontal position and the ▲ and ▼ key for the vertical position.	according to an input signal
Scan Converter	Converts the signal to display the picture according to the screen size. When set to "Off," displays the picture while matching one pixel of input picture element to that of the LCD. The picture will be clear but the picture size will be smaller.	On

Notes

- When SVGA or XGA signal is input, “Scan Converter” will not be displayed.
- Note that if the projector is used for profit or for public viewing, modifying the original picture by switching to the wide mode may constitute an infringement of the rights of authors or producers, which are legally protected.

About the Preset Memory No.

This projector has 32 types of preset data for input signals (the preset memory). When a preset signal is input, the projector automatically detects the signal type and recalls the data for the signal from the preset memory to adjust it to an optimum picture. The memory number and signal type of that signal are displayed in the INFORMATION menu (See page 38). You can also adjust the preset data through the INPUT SETTING menu. This projector has 20 types of user memories for INPUT-A into which you can save the setting of the adjusted data for an unpreset input signal.

When an unpreset signal is input for the first time, a memory number is displayed as 0. When you adjust the data of the signal in the INPUT SETTING menu, it will be registered to the projector. If more than 20 user memories are registered, the newest memory always overwrites the oldest one.

See the chart on page 50 to find if the signal is registered to the preset memory.

Since the data is recalled from the preset memory about the following signals, you can use these preset data by adjusting “H Size.” Make fine adjustment by adjusting “Shift.”

Signal	Memory No.	SIZE
Super Mac-2	23	1312
SGI-1	23	1320
Macintosh 19"	25	1328

Note

When the aspect ratio of input signal is other than 4:3, a part of the screen is displayed in black.

The SET SETTING Menu

The SET SETTING menu is used for changing the settings of the projector.

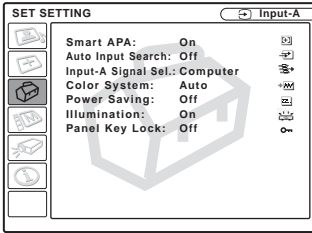

Setting items	Functions	Initial setting value
Smart APA	<p>The APA (Auto Pixel Alignment) automatically adjusts “Dot Phase,” “H Size” and “Shift” in the INPUT SETTING menu for the input signal from a computer.</p> <ul style="list-style-type: none"> • On: When a signal is input from a computer, the APA functions automatically so that the picture can be seen clearly. Once the specified input signal has been adjusted by the “Smart APA,” it will not be readjusted even when the cable is disconnected and connected again or the input channel is changed. You can adjust the picture by pressing APA key on the Remote Commander even if the “Smart APA” set to “On.” • Off: The APA functions when you press the APA key on the Remote Commander. 	On
Auto Input Search	When set to “On,” the projector detects input signals in the following order: Input-A/Component (VPL-ES2 only) /Video/S-Video. It indicates the input channel when the power is turned on or the INPUT key is pressed.	Off
Input-A Signal Sel.	Selects the “Computer,” “Component” or “Video GBR” signal input from the INPUT A connector.	Computer
Color System	<p>Selects the color system of the input signal. If you select “Auto,” the projector detects the color system of the input signal automatically. If the picture is distorted or colorless, select the color system according to the input signal.</p> <p>When the color system of the input signal is PAL60, select “PAL.” If “Auto” is selected, the color system cannot be detected.</p>	Auto

Setting items	Functions	Initial setting value
Power Saving	When set to “On,” the projector goes into power saving mode if no signal is input for 10 minutes. Although the lamp goes out, the cooling fan keeps running. The power saving mode is canceled when a signal is input or any key is pressed. In power saving mode, any key does not function for the first 60 seconds after the lamp goes out.	Off
Illumination	Selects whether the SONY logo on the top panel of the projector lights when the projector is on.	On
Panel Key Lock	Locks all the control panel keys on the rear and side panels of the projector so that the projector can be operated only with the Remote Commander. To lock the control panel keys, set to “On.” When it is set to “On,” keeping the I/⏻ key on the control panel pressed for 10 seconds turns the projector on when it is in standby mode, and turns the projector to standby mode when the power is on. If you keep pressing the MENU key for about 10 seconds when the power is on, the lock will be released and “Panel Key Lock” is automatically set to “Off.”	Off

Notes

- Press the APA key when the full image is displayed on the screen. If the projected image includes much black portion around it, the APA function will not work properly and some parts of the image may not be displayed on the screen.
- You can cancel the adjustment by pressing the APA key again while “Adjusting” appears on the screen.
- The picture may not be adjusted properly depending on the kinds of input signals.
- Adjust the items “Dot Phase,” “H Size” and “Shift” in the INPUT SETTING menu when you adjust the picture manually.

The MENU SETTING Menu

The MENU SETTING menu is used for changing the menu displays.

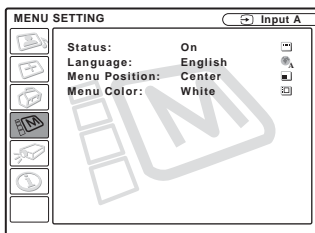

Setting items	Functions	Initial setting value
Status (on-screen display)	Sets up the on-screen display. When set to “Off,” turns off the on-screen displays except for the menus, a message when turning off the power, and warning messages.	On
Language	Selects the language used in the menu and on-screen displays. Available languages are: English, Nederlands, Français, Italiano, Deutsch, Español, Português, Русский, Svenska, Norsk, 日本語, 中文(简体字), 中文(繁體字), 한국어 and ภาษาไทย.	English
Menu Position	Selects the display position of the menu from “Top Left,” “Bottom Left,” “Center,” “Top Right” and “Bottom Right.”	Center
Menu Color	Selects the tone of the menu display from “Black” or “White.”	White

The INSTALL SETTING Menu

The INSTALL SETTING menu is used for changing the settings of the projector.

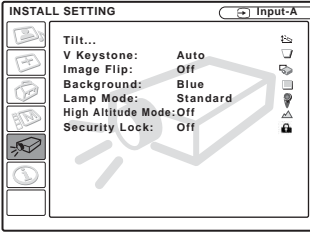

Setting items	Functions	Initial setting value
Tilt...	Adjusts the position (height) of the projected picture.	
V Keystone	<p>Corrects the trapezoidal distortion caused by the projection angle. Select “Auto” for automatic correction, or “Manual” for manual correction using the ◀/▶/▼ key on the Remote Commander.</p> <p>When the bottom of the trapezoid is longer than the top <input type="checkbox"/> : Sets a lower value.</p> <p>When the top of the trapezoid is longer than the bottom <input type="checkbox"/> : Sets a higher value.</p>	Auto
Image Flip	<p>Flips the image on the screen horizontally and/or vertically.</p> <ul style="list-style-type: none"> • Off: The image does not flip. • HV: Flips the image horizontally and vertically. • H: Flips the image horizontally. • V: Flips the image vertically. 	Off
Background	<p>Select the background color of the screen when no signal is input to the projector. Select “Black” or “Blue.” Normally, set to “Blue.”</p>	Blue
Lamp Mode	<p>Sets the lamp brightness in the projection.</p> <ul style="list-style-type: none"> • High: Illuminates the projected image brightly. • Standard: Reduces fan noise and power consumption. The brightness of the projected image will be lower compared with the “High” setting. 	Standard
High Altitude Mode	<p>Set to “On” when the projector is used at an altitude of 1,500 m or higher.</p>	Off
Security Lock	<p>Turns on the projector’s security lock function. When set to “On,” turns on the security lock function, which locks the projector once a password has been set. For details, see “Security Lock” on page 24.</p>	Off

Notes

- The auto V Keystone adjustment may not correct the trapezoidal distortion perfectly, depending on the room temperature or the screen angle.
- When the Image Flip is set to “HV” or “V,” the Lamp Mode works with “Standard” setting.

The INFORMATION Menu

The INFORMATION menu displays the horizontal and vertical frequencies of the input signal and the used time of the lamp.

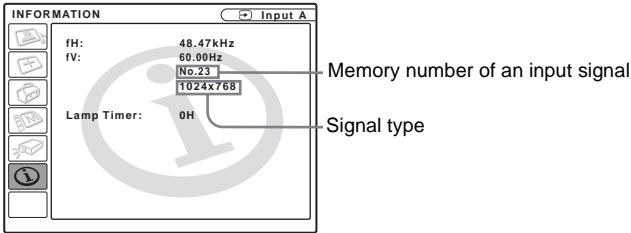

Setting items	Functions	Initial setting value
fH	Displays the horizontal frequency of the input signal. The displayed value is approximate.	/
fV	Displays the vertical frequency of the input signal. The displayed value is approximate.	
Lamp Timer	Indicates how long the lamp has been turned on.	

Note

These only display on the screen. You cannot alter the display.

Input signals and adjustable/setting items

Adjust Picture... menu

Item	Input signal			
	Video or S video (Y/C)	Component	Video GBR	Computer
Contrast	●	●	●	●
Brightness	●	●	●	●
Color	● (except black and white signal)	●	●	—
Hue	● (except black and white signal) (NTSC 3.58/4.43 only)	●	●	—
Sharpness	●	●	●	—
Black Level Adj. (VPL-ES2 only)	●	●	●	—
Gamma Mode	—	—	● (preset memory no.3,4 only)	●
Color Temp.	●	●	●	●
Volume	●	●	●	●

● : Adjustable/can be set

— : Not adjustable/cannot be set

INPUT SETTING menu

Item	Input signal			
	Video or S video (Y/C)	Component	Video GBR	Computer
Dot Phase	—	—	—	●
H Size	—	●*1	●*1	●
Shift	—	●*1	●*1	●
Scan Converter	—	—	—	● (lower than VGA)
Wide Mode	●	●*2	●*2	—

● : Adjustable/can be set

— : Not adjustable/cannot be set

*1: Except preset memory no. 3, 4

*2: Except preset memory no. 5, 45, 47, 48, 50

Replacing the Lamp

Replace the lamp with a new one in the following case.

- When the lamp has burnt out or dims
 - “Please replace the LAMP.” appears on the screen
 - The LAMP/COVER indicator lights up
- The lamp life varies depending on conditions of use.

Use LMP-E180 (VPL-CS7) / LMP-E150 (VPL-ES2) Projector Lamp as the replacement lamp. Use of any other lamps than the LMP-E180 or the LMP-E150 may cause damage of the projector.

Caution

The lamp becomes a high temperature after turning off the projector with the I / ⏻ key. **If you touch the lamp, you may scald your finger. When you replace the lamp, wait for at least an hour for the lamp to cool.**

Notes

- **If the lamp breaks, consult with customer service center.**
- Pull out the lamp by holding the handle. If you touch the lamp, you may be burned or injured.
- When removing the lamp, make sure it remains horizontal, then pull straight up. Do not tilt the lamp. If you pull out the lamp while tilted and if the lamp breaks, the pieces may scatter, causing injury.

- 1 Turn off the projector, and disconnect the AC power cord from the AC outlet.

Note

When replacing the lamp after using the projector, wait for at least an hour for the lamp to cool.

- 2 Place a protective sheet (cloth) beneath the projector. Turn the

projector over so you can see its underside.

Note

Be sure that the projector is stable after turning it over.

- 3 Open the lamp cover by loosening a screw with the Phillips screwdriver.

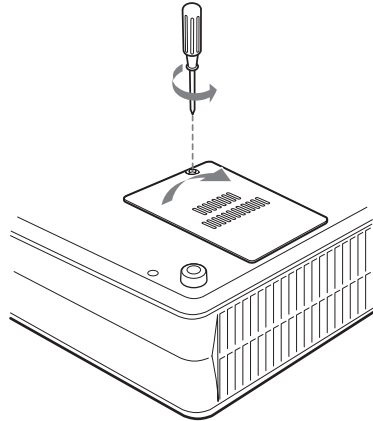

Note

For safety sake, do not loosen any other screws.

- 4 Loosen the two screws on the lamp unit with the Phillips screwdriver (1). Fold out the handle (2), pull out the lamp unit by the handle (3).

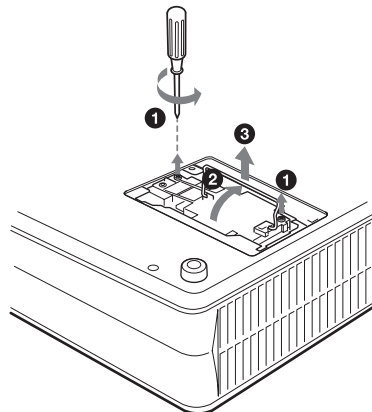

- 5 Insert the new lamp all the way in until it is securely in place (1). Tighten the two screws (2). Fold the handle (3).

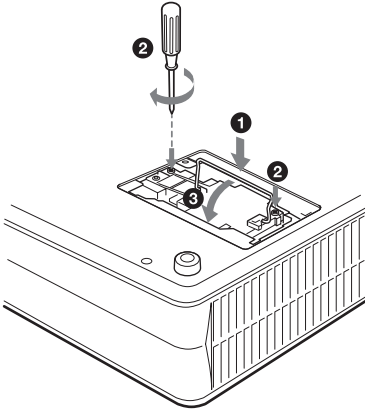

Notes

- Be careful not to touch the glass surface of the lamp.
- The power will not turn on if the lamp is not secured properly.

- 6 Close the lamp cover and tighten the screws.
- 7 Turn the projector back over.
- 8 Connect the power cord. The ON/STANDBY indicator around the I/O key lights in red.
- 9 Press the following keys on the remote commander in the following order for less than five seconds each: RESET, ◀, ▶, ENTER.

Note

Do not put your hands into the lamp replacement spot, or not fall any liquid or object into it **to avoid electrical shock or fire**

Disposal of the used lamp

For the customers in the USA

This product contains mercury. Disposal of this product may be regulated if sold in the United States. For disposal or recycling information, please contact your local

authorities or Electronics Industries Alliance (<http://www.eiae.org>).

Cleaning the Air Filter

The air filter should be cleaned every 500 hours.

Remove dust from the outside of the ventilation holes with a vacuum cleaner when the message “Please clean the filter” appears in the display.

500 hours are approximate. This value varies depending on the environment or how the projector is used.

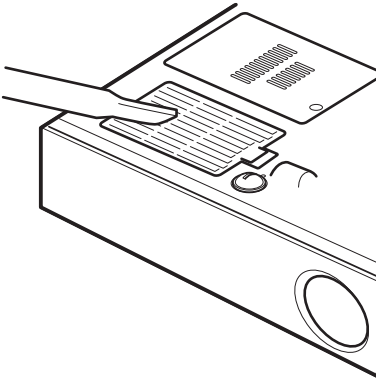

When it becomes difficult to remove the dust from the filter with a vacuum cleaner, remove the air filter and wash it.

- 1 Turn off the power and unplug the power cord.
- 2 Place a protective sheet (cloth) beneath the projector and turn the projector over.

- 3 Remove the air filter cover.

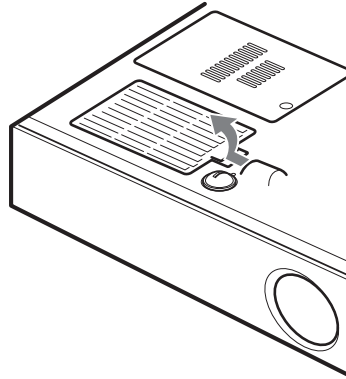

- 4 Remove the air filter.

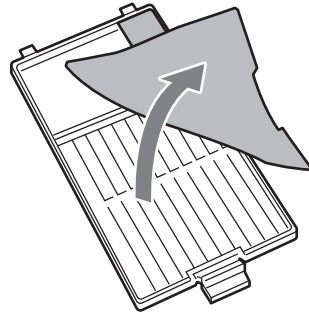

- 5 Wash the air filter with a mild detergent solution and dry it in a shaded place.

- 6 Attach the air filter and replace the cover.

Notes

- If you neglect to clean the air filter, dust may accumulate, clogging it. As a result, the temperature may rise inside the unit, leading to a possible malfunction or fire.
- If the dust cannot be removed from the air filter, replace the air filter with the supplied new one.
- Be sure to attach the air filter cover firmly. Otherwise, dust may accumulate inside the projector, leading to a possible malfunction.

Troubleshooting

If the projector appears to be operating erratically, try to diagnose and correct the problem using the following instructions. If the problem persists, consult with qualified Sony personnel.

Power

Symptom	Cause and Remedy
The power is not turned on.	<ul style="list-style-type: none"> • The power has been turned off and on with the I / ⏻ key at a short interval. → Wait for about 90 seconds before turning on the power (see page 22). • The lamp cover is detached. → Close the lamp cover securely (see page 41).
Both the LAMP/COVER and TEMP/FAN indicators light up.	<ul style="list-style-type: none"> • The electrical system breaks down. → Consult with qualified Sony personnel.
The powered tilt adjuster and the lens protector do not close.	<ul style="list-style-type: none"> • The AC power cord is unplugged with the power of the projector turned on. → Connect the power cord plug to the AC outlet again, then turn off the power of the projector.
The powered tilt adjuster and the lens protector do not work at all.	<ul style="list-style-type: none"> • The electrical system breaks down. → Consult with qualified Sony personnel. If it is necessary to use the projector in case of emergency, use it in the emergency mode (see page 47).

Picture

Symptom	Cause and Remedy
No picture.	<ul style="list-style-type: none"> • Cable is disconnected or the connections are wrong. → Check that the proper connections have been made (see page 17). • The connections are wrong. → This projector is compatible with a DDC2B (Display Data Channel 2B). If your computer is compatible with a DDC, turn the projector on according to the following procedures. <ol style="list-style-type: none"> 1 Connect the projector to the computer. 2 Turn the projector on. 3 Start the computer. • Input selection is incorrect. → Select the input source correctly using the INPUT key (see page 20). • The computer signal is not set to output to an external monitor or set to output both to an external monitor and a LCD monitor of a computer. → Set the computer signal to output only to an external monitor (see page 17). → Depending on the type of your computer, for example a notebook, or an all-in-one LCD type, you may have to switch the computer to output to the projector by pressing certain keys or by changing your computer's settings. (See page 20) <i>For details, refer to the computer's operating instructions supplied with your computer.</i>

Symptom	Cause and Remedy
The picture is noisy.	<ul style="list-style-type: none"> Noise may appear on the background depending on the combination of the numbers of dot input from the connector and numbers of pixel on the LCD panel. → Change the desktop pattern on the connected computer.
The picture from INPUT A connector is colored strange.	<ul style="list-style-type: none"> Setting of “Input-A Signal Sel.” in the SET SETTING menu is incorrect. → Select “Computer,” “Video GBR” or “Component” correctly according to the input signal (see page 33).
“Please check Input-A Signal Sel.” appears in spite of inputting the correct signal from INPUT A.	<ul style="list-style-type: none"> Setting of “Input-A Signal Sel.” in the SET SETTING menu is incorrect. → Select “Computer,” “Video GBR” or “Component” correctly according to the input signal (see page 33).
On-screen display does not appear.	<ul style="list-style-type: none"> “Status” in the MENU SETTING menu has been set to “Off.” → Set “Status” in the MENU SETTING menu to “On” (see page 35).
Color balance is incorrect.	<ul style="list-style-type: none"> Picture has not been adjusted properly. → Adjust the picture (see page 29). Projector is set to wrong color system. → Set “Color System” in the SET SETTING menu to match the color system being input (see page 33).
The picture is too dark.	<ul style="list-style-type: none"> “Contrast” or “Brightness” has not been adjusted properly. → Adjust the contrast or brightness in the “Adjust Picture...” menu properly (see page 29). The lamp has burnt or dims. → Replace the lamp with a new one (see page 40).
The picture is not clear.	<ul style="list-style-type: none"> Picture is out of focus. → Adjust the focus (see page 21). Condensation has occurred on the lens. → Leave the projector for about two hours with the power on .
The image extends beyond the screen.	<ul style="list-style-type: none"> The APA key is pressed although there are black edges around the image. → Display the full image on the screen and press the APA key. → Adjust “Shift” in the INPUT SETTING menu properly (see page 31).
The picture flickers.	<ul style="list-style-type: none"> “Dot Phase” in the INPUT SETTING menu has not been adjusted properly. → Adjust “Dot Phase” in the INPUT SETTING menu properly (see page 31).

Sound

Symptom	Cause and Remedy
No sound.	<ul style="list-style-type: none"> Cable is disconnected or the connections are wrong. → Check that the proper connections have been made (see page 17). The audio connecting cable is incorrect. → Use a no-resistance stereo audio cable (see page 17). The sound is not adjusted properly. → Adjust the volume (see page 29).

Remote Commander

Symptom	Cause and Remedy
The Remote Commander does not work.	<ul style="list-style-type: none"> The Remote Commander batteries are dead. → Replace with a new battery (page 14).

Others

Symptom	Cause and Remedy
The control panel keys do not function.	<ul style="list-style-type: none"> The control panel keys are locked. → Unlock the control panel keys (see page 34).

Indicators

Symptom	Cause and Remedy
The LAMP/COVER indicator flashes.	<ul style="list-style-type: none"> The lamp cover is detached. → Attach the cover securely (see page 41). The lens protector does not open due to a problem. → Consult with qualified Sony personnel. If it is necessary to use the projector in case of emergency, use it in the emergency mode (see page 47).
The LAMP/COVER indicator lights up.	<ul style="list-style-type: none"> The lamp has reached the end of its life. → Replace the lamp (see page 40). The lamp becomes a high temperature. → Wait for 90 seconds to cool down the lamp and turn on the power again (see page 21).
The TEMP/FAN indicator flashes.	<ul style="list-style-type: none"> The fan is broken. → Consult with qualified Sony personnel.
The TEMP/FAN indicator lights up.	<ul style="list-style-type: none"> The internal temperature is unusually high. → Check to see if anything is blocking the ventilation holes. → Check to see whether or not the projector is being used at high altitudes.
Both the LAMP/COVER and TEMP/FAN indicators light up.	<ul style="list-style-type: none"> The electrical system breaks down. → Consult with qualified Sony personnel.

Messages List

Warning Messages

Use the list below to check the meaning of the messages displayed on the screen.

Message	Meaning and Remedy
High temp.! Probably use in high altitude. Switch to high altitude mode on? Yes ↑ No ↓	<ul style="list-style-type: none">• Internal temperature is too high.<ul style="list-style-type: none">→ When using the projector at an altitude of 1,500 m or higher, set the setting of “High Altitude Mode” in the INSTALL SETTING menu to on. (see page 36)• If this message appears on the screen when using the projector at normal altitudes, check to see if anything is blocking the ventilation holes (exhaust).
High temp.! Lamp off in 1 min.	<ul style="list-style-type: none">• Internal temperature is too high.<ul style="list-style-type: none">→ Turn off the power.→ Check to see if anything is blocking the ventilation holes.
Frequency is out of range!	<ul style="list-style-type: none">• This input signal cannot be projected as the frequency is out of the acceptable range of the projector.<ul style="list-style-type: none">→ Input a signal that is within the range of the frequency.• The resolution setting of the output signal of a computer is too high.<ul style="list-style-type: none">→ Set the setting of output to SVGA (see page 17).
Please check Input-A Signal Sel.	<ul style="list-style-type: none">• You have input RGB signal from the computer when “Input-A Signal Sel.” in the SET SETTING menu is set to “Component.”<ul style="list-style-type: none">→ Set “Input-A Signal Sel.” correctly (see page 33).
Please replace the LAMP.	<ul style="list-style-type: none">• It is time to replace the lamp.<ul style="list-style-type: none">→ Replace the lamp. (see page 40)
Please clean the filter.	<ul style="list-style-type: none">• It is time to clean the filter.• Clean the filter. (see page 42)

Caution Messages

Use the list below to check the meaning of the messages displayed on the screen.

Message	Meaning and Remedy
Not applicable!	<ul style="list-style-type: none">• You have pressed the wrong key.<ul style="list-style-type: none">→ Press the appropriate key.
The panel keys are locked !	<ul style="list-style-type: none">• “Panel Key Lock” in the INSTALL SETTING menu is set to “On.”<ul style="list-style-type: none">→ All the keys on the control panel of the projector are locked. Operate the projector with the keys on the Remote Commander (see page 34).

On the emergency mode

Before performing the following procedure, try to diagnose the problem using the instructions described in “Troubleshooting” on page 43. If the problem persists, read and following procedure thoroughly and then proceed.

The projector is equipped with the emergency mode for the lens protector and the powered tilt adjuster. If the powered function does not work, you can operate the lens protector and the tilt adjuster (emergency mode) manually.

Note

Perform this procedure only in an emergency case. You cannot recover the powered function yourself if you perform this procedure. After you use the projector in the emergency mode, consult with qualified Sony personnel immediately.

To switch to the emergency mode, follow the steps below.

- 1 Place a protective sheet (cloth) beneath the projector. Turn the projector over so you can see its underside.

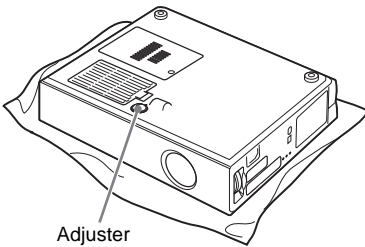

- 2 Slide switch **A** in the slit in front of the adjuster in the direction of the arrow with the small minus screwdriver.
The lens protector and the tilt adjuster are switched to the emergency mode.

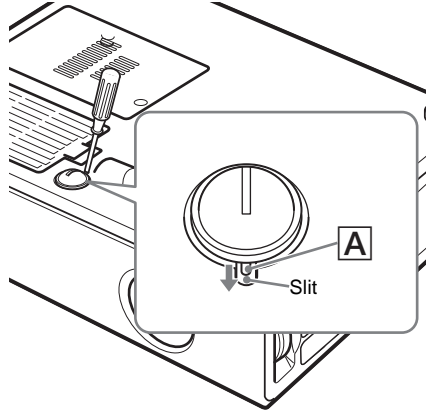

- 3 When opening/closing the lens protector, turn the groove of the adjuster with a coin.
When the lens protector is left open, or the tilt adjuster is extended, turn the groove counterclockwise (in direction of the arrow).

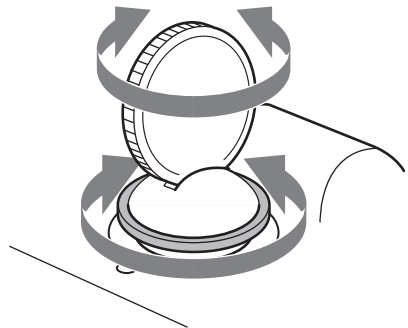

Note

Turn the projector on when the lens protector on the front of the projector is completely open.

Specifications

Optical characteristics

Projection system	3 LCD panels, 1 lens, projection system
LCD panel	Superhigh-aperture 0.62-inch SVGA panel, 1,440,000 pixels (480,000 pixels × 3)
Lens	1.2 times zoom lens (manual) f 18.0 to 21.6 mm/F 2.2 to 2.4
Lamp	VPL-CS7: 185 W UHP VPL-ES2: 157 W UHP
Projection picture size	Range: 40 to 300 inches (diagonal measure)
Light output	VPL-CS7: 1800 ANSI ¹⁾ lm VPL-ES2: 1500 ANSI ¹⁾ lm (When the Lamp Mode is set to “High”)
Throwing distance (When placing on the floor)	When the SVGA signal is input: 40-inch: 1.1 to 1.4 m (3.6 to 4.6 feet) 60-inch: 1.7 to 2.1 m (5.6 to 6.9 feet) 80-inch: 2.3 to 2.8 m (7.5 to 9.2 feet) 100-inch: 2.9 to 3.5 m (9.5 to 11.5 feet) 120-inch: 3.5 to 4.2 m (11.5 to 13.8 feet) 150-inch: 4.4 to 5.3 m (14.4 to 17.4 feet) 200-inch: 5.9 to 7.0 m (19.4 to 28.9 feet) 300-inch: 8.8 to 10.6 m (23 to 34.8 feet)

There may be a slight difference between the actual value and the design value shown above.

Electrical characteristics

Color system	NTSC _{3.58} /PAL/SECAM/ NTSC _{4.43} /PAL-M/PAL-N/ PAL60 system, switched automatically/manually
Resolution	600 horizontal TV lines (Video input) 800 × 600 dots (RGB input)

Acceptable computer signals²⁾

fH: 19 to 72 kHz

fV: 48 to 92 Hz

(Maximum input signal resolution:

XGA 1024 × 768

fV: 85 Hz)

Applicable video signals

15 kHz RGB/Component 50/60 Hz, Progressive Component 50/60 Hz, DTV (480/60i, 575/50i, 1080/60i, 480/60p, 575/50p, 1080/50i 720/60p, 720/50p, 540/60p), Composite video, Y/C video

Speaker Monaural speaker system, 40 × 20 mm (1 ⁵/₈ × 1³/₁₆ inches), max. 1 W

Input/Output

Video input	VIDEO: phono type Composite video: 1 V _{p-p} ±2 dB sync negative (75 ohms terminated) S VIDEO: Y/C mini DIN 4-pin type Y (luminance): 1 V _{p-p} ±2 dB sync negative (75 ohms terminated) C (chrominance): burst 0.286 V _{p-p} ±2 dB (NTSC) (75 ohms terminated), burst 0.3 V _{p-p} ±2 dB (PAL) (75 ohms terminated)
INPUT A	HD D-sub15-pin (female) Analog RGB/component: R/R-Y: 0.7 V _{p-p} ±2 dB (75 ohms terminated) G: 0.7 V _{p-p} ±2 dB (75 ohms terminated) G with sync/Y: 1 V _{p-p} ±2 dB sync negative (75 ohms terminated) B/B-Y: 0.7 V _{p-p} ±2 dB (75 ohms terminated) SYNC/HD: Composite sync input: 1-5 V _{p-p} high impedance, positive/negative Horizontal sync input: 1-5 V _{p-p} high impedance, positive/negative

1) ANSI lumen is a measuring method of American National Standard IT 7.228.

2) Set the resolution and the frequency of the signal of the connected computer within the range of acceptable preset signals of the projector.

VD:
Vertical sync input: 1-5 Vp-p
high impedance, positive/
negative

Y Pb/Cb Pr/Cr (VPL-ES2 only)
Component phono plug
sync/Y: 1 Vp-p \pm 2 dB sync
negative (75 ohms terminated)
Cb/Pb: 0.7 Vp-p \pm 2 dB (75 ohms
terminated)
Cr/Pr: 0.7 Vp-p \pm 2 dB (75 ohms
terminated)

AUDIO Stereo minijack
500 mVrms, impedance more
than 47 kilohms

OUTPUT MONITOR OUT (VPL-CS7
only): HD D-sub 15-pin
(female)
R, G, B: Gain Unity: 75 ohms
SYNC/HD, VD: 4 Vp-p (open),
1 Vp-p (75 ohms)

Safety regulations
UL60950, cUL (CSA No. 60950),
FCC Class B, IC Class B,
NEMKO (EN60950), CE
(LVD, EMC), C-Tick

AC power cord (1)
Air filter (for replacement) (1)
Operating Instructions (CD-ROM)
(1)
Quick Reference Manual (1)
Security Label (1)

Design and specifications are subject to change
without notice.

Optional accessories

Projector Lamp (for replacement)
LMP-E180 (for VPL-CS7 only)
LMP-E150 (for VPL-ES2 only)

Signal Cable SMF-402 (HD D-sub 15-pin
(male) \leftrightarrow 3 \times phono type
(male))

Pin assignment

INPUT A connector (HD D-sub 15-pin, female)

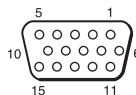

1	R/R-Y	9	N.C.
2	G/Y	10	GND
3	B/B-Y	11	GND
4	GND	12	DDC/SDA
5	GND	13	HD/C.Sync
6	GND (R)	14	VD
7	GND (G)	15	DDC/SCL
8	GND (B)		

General

Dimensions 295 \times 78 \times 238 mm (11 $\frac{5}{8}$ \times
3 $\frac{1}{8}$ \times 9 $\frac{3}{8}$ inches) (w/h/d)
(without the projection parts)

Mass VPL-CS7: Approx. 2.9 kg (6 lb 6
oz)
VPL-ES2: Approx. 2.8 kg (6 lb 3
oz)

Power requirements
AC 100 to 240 V, 50/60 Hz

Power consumption
VPL-CS7: Max. 250 W
VPL-ES2: Max. 220 W
(Standby mode: 4.6 W)

Heat dissipation
VPL-CS7: 853.1 BTU
VPL-ES2: 750.7 BTU

Operating temperature
0°C to 35°C (32°F to 95°F)

Operating humidity
35% to 85% (no condensation)

Storage temperature
-20°C to +60°C (-4°F to 140°F)

Storage humidity
10% to 90%

Supplied accessories
Remote Commander (1)
Lithium battery CR2025 (1)
HD D-sub 15 pin cable (2 m) (1)
(1-791-992-21)
Soft case (1)

Others

Preset signals

Memory No.	Preset signal		fH (kHz)	fV (Hz)	Sync	SIZE
1	Video 60 Hz		15.734	59.940		
2	Video 50 Hz		15.625	50.000		
3	15k RGB/Component 60 Hz		15.734	59.940	S on G/Y or Composite Sync	
4	15k RGB/Component 50 Hz		15.625	50.000	S on G/Y or Composite Sync	
5	1080/60i		33.75	60.0	S on G/Y or Composite Sync	
6	640 × 350	VGA mode 1	31.469	70.086	H-pos, V-neg	800
7		VGA VESA 85 Hz	37.861	85.080	H-pos, V-neg	832
8	640 × 400	PC-9801 Normal	24.823	56.416	H-neg, V-neg	848
9		VGA mode 2	31.469	70.086	H-neg, V-pos	800
10		VGA VESA 85 Hz	37.861	85.080	H-neg, V-pos	832
11	640 × 480	VGA mode 3	31.469	59.940	H-neg, V-neg	800
12		Macintosh 13"	35.000	66.667	H-neg, V-neg	864
13		VGA VESA 72 Hz	37.861	72.809	H-neg, V-neg	832
14		VGA VESA 75 Hz	37.500	75.000	H-neg V-neg	840
15		VGA VESA 85 Hz	43.269	85.008	H-neg V-neg	832
16	800 × 600	SVGA VESA 56 Hz	35.156	56.250	H-pos, V-pos	1024
17		SVGA VESA 60 Hz	37.879	60.317	H-pos, V-pos	1056
18		SVGA VESA 72 Hz	48.077	72.188	H-pos, V-pos	1040
19		SVGA VESA 75 Hz	46.875	75.000	H-pos, V-pos	1056
20		SVGA VESA 85 Hz	53.674	85.061	H-pos, V-pos	1048
21	832 × 624	Macintosh 16"	49.724	74.550	H-neg, V-neg	1152
22*	1024 × 768	XGA VESA 43 Hz	35.524	86.958	H-pos, V-pos	1264
23		XGA VESA 60 Hz	48.363	60.004	H-neg V-neg	1344
24		XGA VESA 70 Hz	56.476	69.955	H-neg V-neg	1328
25		XGA VESA 75 Hz	60.023	75.029	H-pos, V-pos	1312
26		XGA VESA 85 Hz	68.677	84.997	H-pos, V-pos	1150
43	480/60p (Progressive component)		31.470	60.000	Son G	
44	575/50p (Progressive component)		31.250	50.000	Son G	
45	1080/50i (DTV)		28.130	50.000		
47	720/60p (DTV)		45.000	60.000		
48	720/50p (DTV)		37.500	50.000		
50	546/60p		33.750	60.000		

Notes

- When a signal other than the preset signals shown above is input, the picture may not appear properly.
- Memory No. 22* shows the interlace signal.

Warning on power connection

Use a proper power cord for your local power supply.

	The United States, Canada		Continental Europe		UK, Ireland, Australia, New Zealand	Japan
Plug type	VM0233	290B	YP-12A	COX-07	_(1)	YP332
Connector type	VM0089	386A	YC-13B	COX-02	VM0310B	YC-13
Cord type	SJT	SJT	H05VV-F	H05VV-F	N13237/ CO-228	VCTF
Rated Voltage & Current	10A/125V	10A/125V	10A/250V	10A/250V	10A/250V	7A/125V
Safety approval	UL/CSA	UL/CSA	VDE	VDE	VDE	DENAN
Cord length (max.)	4.5 m (14 feet 9 inches)		-			

(1) Use an appropriate rating plug which is applied to local regulations.

Index

A

Adjusting	
memory of the settings	28
the picture	29
the picture size/shift	31
Air filter	42
Auto Input Search	33

B

Background	36
Black Level Adj.	30
Brightness	29

C

Color	29
Color System	33
Color Temp.	30
Component connector	18
Connections	
computer	17
VCR	18
Contrast	29

D

Digital Zoom function	26
Dot Phase	31

F

fH (Horizontal Frequency)	38
fV (Vertical Frequency)	38

G

Gamma Mode	30
------------	----

H

H Size	31
High Altitude Mode	36
Hue	29

I

Illumination	34
Image Flip	36
INPUT A connector	13
pin assignment	49
Input-A Signal Sel.	33

Installation examples	16
notes	7
unsuitable conditions	8
unsuitable installation	7

L

Lamp Mode	36
Lamp replacement	40
Lamp Timer	38
Language	35
selecting the menu language	23
Lens protector	11
Lithium battery	14
Location and function of controls	
connector panel	13
control panel	12
rear/right side/bottom	11
top/front/left side	11

M

Menu	
clearing the menu display	28
INFORMATION Menu	38
INPUT SETTING menu	31
INSTALL SETTING menu	36
MENU SETTING menu	35
PICTURE SETTING menu	29
SET SETTING menu	33
using the menu	27
Menu Color	35
Menu Position	35
Message	
caution	46
warning	46

O

Off & Go function	25
Optional accessories	49

P

Panel Key Lock	34
Picture Mode	29
Pin assignment	49
Power	
turn on	19
Power Saving	11, 34
Power tilt adjuster	20
Precautions	6

R

Remote Commander	14
location and function of controls	14
Remote control detector	11
Reset	
resettable items	28
resetting the item	28

S

Scan Converter	31
Screen size	16, 48
Security Lock	36
Sharpness	29
Shift	31
Smart APA	33
Specifications	48
Status	35
Supplied accessories	49

T

Tilt... ..	36
Troubleshooting	43

V

V Keystone	36
Volume	29

W

Wide Mode	31
-----------------	----

<http://www.sony.net/>

Sony Corporation
