



Table of Contents

Table of Contents	1
Usage Notice.....	2
Safety Information	2
Precautions.....	3
Eye Safety Warnings.....	5
Product Features.....	5
Introduction.....	6
Package Overview.....	6
Product Overview	7
Main Unit.....	7
Control Panel	8
Input / Output Connections	9
Remote Control.....	10
Installation	11
Connecting the Projector.....	11
Connect to Computer/Notebook	11
Connect to Video Sources	12
Powering On/Off the Projector.....	13
Powering On the Projector.....	13
Powering Off the projector	14
Warning Indicator.....	14
Adjusting the Projected Image.....	15
Adjusting the Projector's Height.....	15
Adjusting the Projector's Zoom / Focus	16
Adjusting Projected Image Size	16
User Controls	17
Control Panel & Remote Control	17
Control Panel	17
Remote Control.....	18
On-screen Display Menus	20
How to operate	20
Menu Tree.....	21
Image	22
Display	26
Setup.....	29
Options.....	36
Appendices.....	39
Troubleshooting.....	39
Image Problems	39
Other Problems	42
Projector Status Indication	42
Remote Control Problems	43
Replacing the Lamp.....	44
Compatibility Modes	46
RS232 Commands	48
Ceiling Mount Installation	51
Optoma Global Offices	52
Regulation & Safety notices	54

Safety Information

	The lightning flash with arrow head within an equilateral triangle is intended to alert the user to the presence of uninsulated "dangerous voltage" within the product's enclosure that may be of sufficient magnitude to constitute a risk of electric shock to persons.
	The exclamation point within an equilateral triangle is intended to alert the user to the presence of important operating and maintenance (servicing) instructions in the literature accompanying the appliance.

WARNING: TO REDUCE THE RISK OF FIRE OR ELECTRIC SHOCK, DO NOT EXPOSE THIS APPLIANCE TO RAIN OR MOISTURE. DANGEROUS HIGH VOLTAGES ARE PRESENT INSIDE THE ENCLOSURE. DO NOT OPEN THE CABINET. REFER SERVICING TO QUALIFIED PERSONNEL ONLY.

Class B emissions limits

This Class B digital apparatus meets all requirements of the Canadian Interference-Causing Equipment Regulations.

Important Safety Instruction

1. Do not block any ventilation openings. To ensure reliable operation of the projector and to protect from over heating, it is recommended to install the projector in a location that does not block ventilation. As an example, do not place the projector on a crowded coffee table, sofa, bed, etc. Do not put the projector in an enclosure such as a book case or a cabinet that restricts air flow.
2. Do not use the projector near water or moisture. To reduce the risk of fire and/or electric shock, do not expose the projector to rain or moisture.
3. Do not install near heat sources such as radiators, heaters, stoves or any other apparatus such as amplifiers that emits heat.
4. Clean only with dry cloth.
5. Only use attachments/accessories specified by the manufacturer.
6. Do not use the unit if it has been physically damaged or abused.
Physical damage/abuse would be (but not limited to):
 - Unit has been dropped.
 - Power supply cord or plug has been damaged.
 - Liquid has been spilled on to the projector.
 - Projector has been exposed to rain or moisture.
 - Something has fallen in the projector or something is loose inside.Do not attempt to service the unit yourself. Opening or removing covers may expose you to dangerous voltages or other hazards. Please call Optoma before you send the unit for repair.
7. Do not let objects or liquids enter the projector. They may touch dangerous voltage points and short out parts that could result in fire or electric shock.
8. See projector enclosure for safety related markings.
9. The unit should only be repaired by appropriate service personnel.

Precautions



Please follow all warnings, precautions and maintenance as recommended in this user's guide.

- Warning- Do not look into the projector's lens when the lamp is on. The bright light may hurt your eyes.
- Warning- To reduce the risk of fire or electric shock, do not expose this projector to rain or moisture.
- Warning- Please do not open or disassemble the projector as this may cause electric shock.
- Warning- When replacing the lamp, please allow the unit to cool down. Follow instructions as described on pages 44-45.
- Warning- This projector will detect the life of the lamp itself. Please be sure to change the lamp when it shows warning messages.
- Warning- Reset the "Lamp Reset" function from the on-screen display "Options|Lamp Settings" menu after replacing the lamp module (refer to page 38).
- Warning- When switching the projector off, please ensure the cooling cycle has been completed before disconnecting power. Allow 90 seconds for the projector to cool down.
- Warning- Do not use lens cap when projector is in operation.
- Warning- When the lamp is approaching to the end of its life time, the message "Lamp Warning: Lamp life exceeded." will show on the screen. Please contact your local reseller or service center to change the lamp as soon as possible.



- ❖ When the lamp reaches the end of its life, the projector will not turn back on until the lamp module has been replaced. To replace the lamp, follow the procedures listed under "Replacing the Lamp" section on pages 44-45.

Usage Notice

Do:

- ❖ Turn off and unplug the power plug from the AC outlet before cleaning the product.
- ❖ Use a soft dry cloth with mild detergent to clean the display housing.
- ❖ Disconnect the power plug from AC outlet if the product is not being used for a long period of time.

Do not:

- ❖ Block the slots and openings on the unit provided for ventilation.
- ❖ Use abrasive cleaners, waxes or solvents to clean the unit.
- ❖ Use under the following conditions:
 - In extremely hot, cold or humid environments.
 - ▶ Ensure that the ambient room temperature is within 5 - 35°C.
 - ▶ Relative Humidity is 5 - 35°C, 80% (Max.), non-condensing.
 - In areas susceptible to excessive dust and dirt.
 - Near any appliance generating a strong magnetic field.
 - In direct sunlight.

Eye Safety Warnings



- Avoid staring/facing directly into the projector beam at all times. Keep your back to the beam as much as possible.
- When projector is used in a classroom, adequately supervise students when they are asked to point out something on the screen.
- In order to minimize the lamp power, use room blinds to reduce ambient light levels.

Product Features

- XGA (1024x768) / SVGA (800x600) Native resolution
- One built-in speaker with 2 watt amplifier
- HDTV compatible (720P, 1080i/p)
- VGA monitor Loop Thru
(works on standby mode > 1W)
- BrilliantColor™ Technology
- Security Bar and Kensington Lock
- RS232 control
- Rapid shutdown

Introduction

Package Overview

Unpack and inspect the box contents to ensure all parts listed below are in the box. If something is missing, please contact your nearest customer service center.



Projector with lens cap

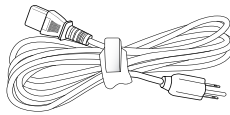

Power Cord 1.8m

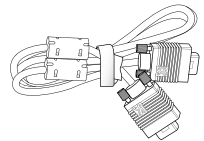

VGA Cable 1.8m



IR Remote Control



2 × AAA Batteries



Carrying case
(Option)



❖ Due to different applications in each country, some regions may have different accessories.

Documentation :

- User's Manual
- Warranty Card
- Quick Start Card
- WEEE Card
(for EMEA only)

Introduction

Product Overview

Main Unit

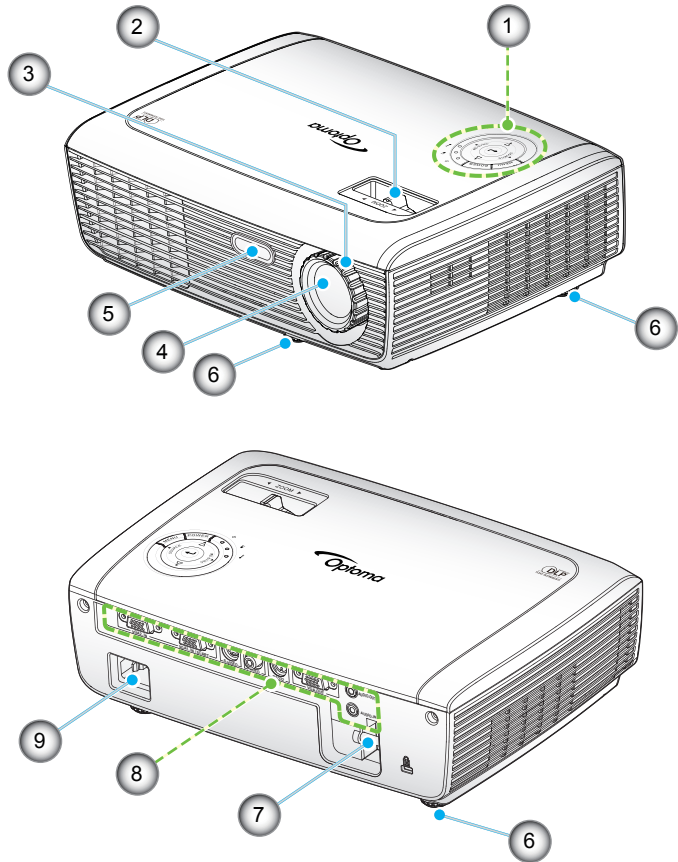

- | | |
|------------------|-------------------------------|
| 1. Control Panel | 6. Tilt-Adjustment Feet |
| 2. Zoom Ring | 7. Security Bar |
| 3. Focus Ring | 8. Input / Output Connections |
| 4. Zoom Lens | 9. Power Socket |
| 5. IR Receiver | |

Introduction

Control Panel

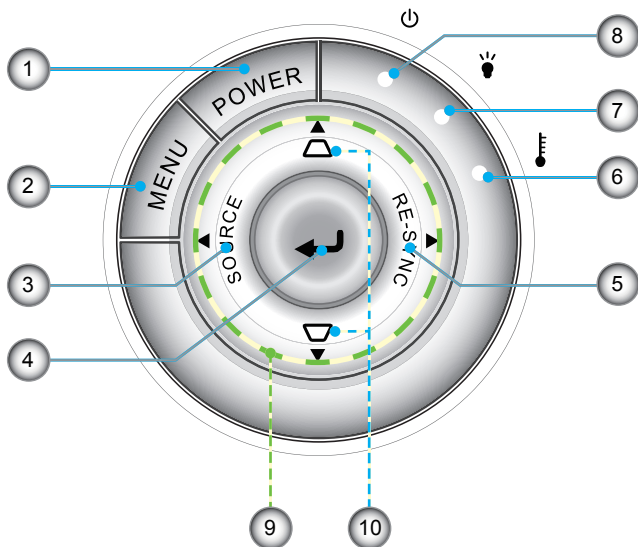

1. Power/Standby
2. Menu
3. Source
4. Enter
5. Re-Sync
6. Temp LED
7. Lamp Fail LED
8. Power LED
9. Four Directional Select Keys
10. Keystone Correction

Introduction

Input / Output Connections

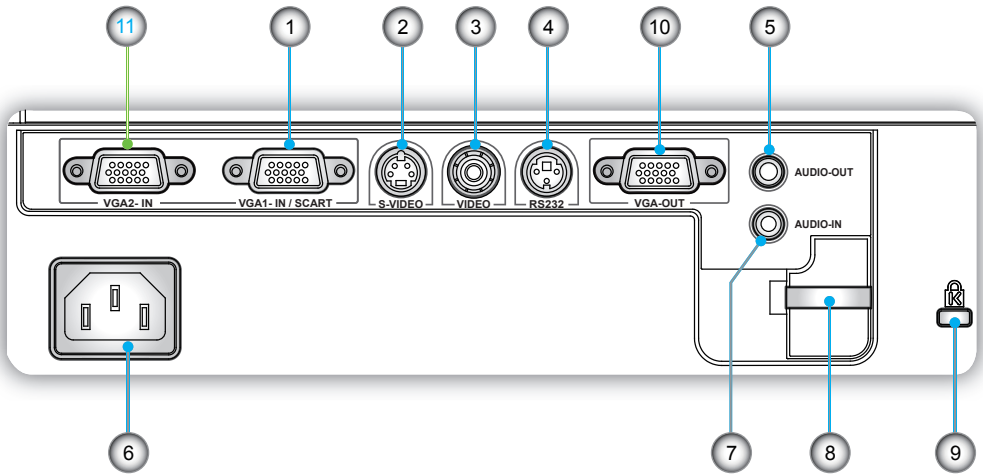

1. VGA1-In/SCART Connector
(PC Analog Signal/Component Video Input/HDTV/SCART)
2. S-Video Input Connector
3. Composite Video Input Connector
4. RS-232 Connector (3-pin)
5. Audio Output Connector (3.5mm Mini Jack)
6. Power Socket
7. Audio Input Connector (3.5mm Mini Jack)
8. Security Bar
9. Kensington™ Lock Port
10. VGA-Out Connector (Monitor Loop-through Output)

The items below are only for models that operate with XGA model:

11. VGA2-In Connector
(PC Analog Signal/Component Video Input/HDTV)

Introduction

Remote Control

1. LED Indicator
2. Power On/Off
3. No Function on this model
4. No Function on this model
5. Four Directional Select Keys
6. Re-Sync
7. No Function on this model
8. Volume +/-
9. Zoom
10. AV mute
11. Video
12. VGA
13. Freeze
14. S-Video
15. Contrast
16. Brightness
17. Menu
18. Keystone +/-
19. Source
20. Enter
21. Video
22. VGA
23. Numbered keypad (for password input)

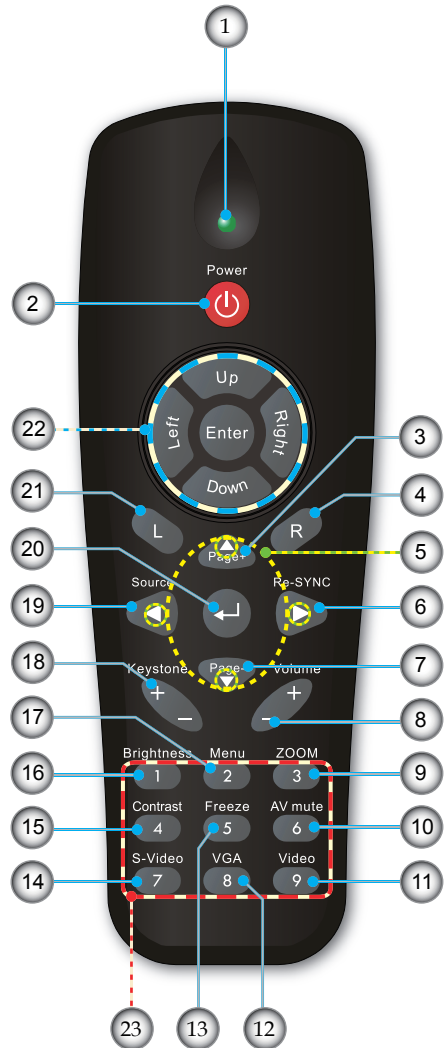

Installation

Connecting the Projector

Connect to Computer/Notebook



- ❖ Due to the difference in applications for each country, some regions may have different accessories.
- ❖ (*) Optional accessory

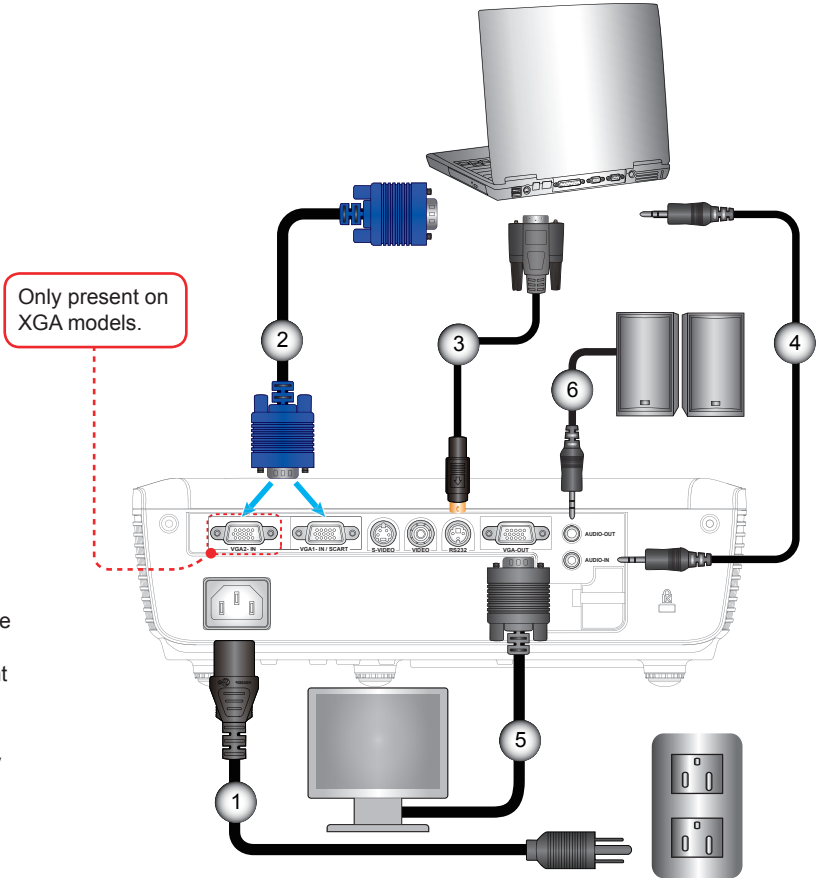

- | | |
|--------|---------------------|
| 1..... | Power Cord |
| 2..... | VGA Cable |
| 3..... | *RS232 Cable |
| 4..... | *Audio Input Cable |
| 5..... | *VGA Output Cable |
| 6..... | *Audio Output Cable |

Installation

Connect to Video Sources

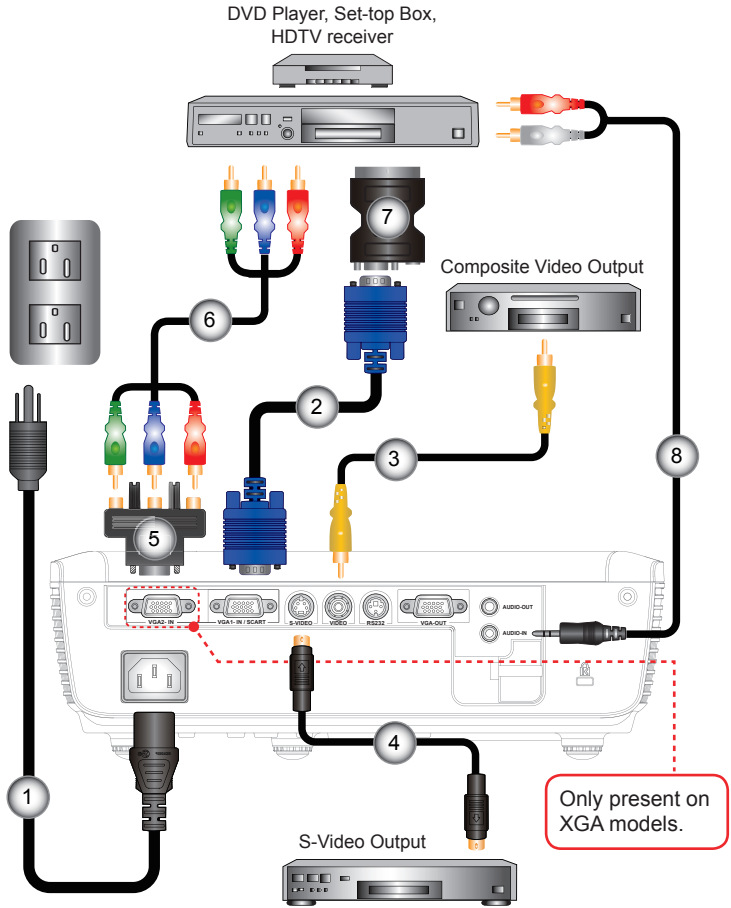

- | | |
|--------|---|
| 1..... | Power Cord |
| 2..... | VGA Cable |
| 3..... | *Composite Video Cable |
| 4..... | *S-Video Cable |
| 5..... | *15-Pin to 3 RCA Component/HDTV Adaptor |
| 6..... | *3 RCA Component Cable |
| 7..... | *SCART/VGA Adaptor |
| 8..... | *Audio Cable Jack/RCA |

Powering On/Off the Projector

Powering On the Projector

1. Remove the lens cap. ❶
2. Securely connect the power cord and signal cable. When connected, the Power LED will turn red.
3. Turn on the lamp by pressing “POWER” button either on the top of the projector or on the remote. The Power LED will now turn Green. ❷

The startup screen will display in approximately 10 seconds. The first time you use the projector, you can select your preferred language from quick menu after the startup screen displays.

4. Turn on and connect the source that you want to display on the screen (computer, notebook, video player, etc). The projector will detect the source automatically. If not, push menu button and go to “OPTIONS”.
Make sure that the “Source Lock” has been set to “Off”.
- ❖ If you connect multiple sources at the same time, press the “SOURCE” button on the control panel or direct source keys on the remote control to switch between inputs.

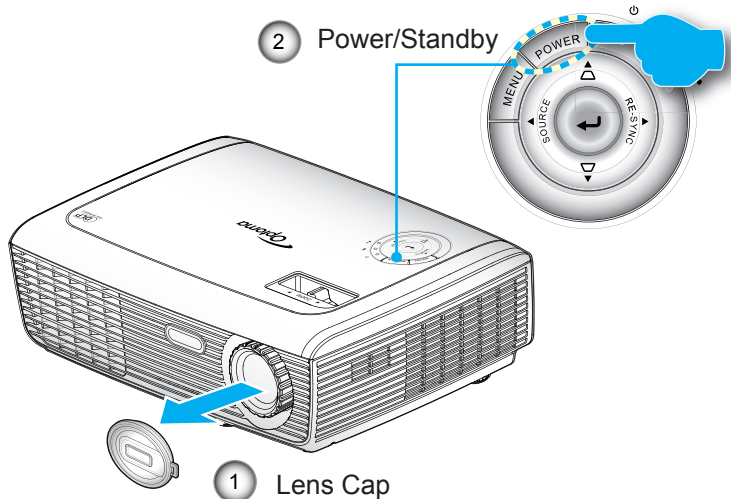

- ❖ Turn on the projector first and then select the signal sources.

Powering Off the Projector

1. Press the “POWER” button to turn off the projector lamp. The following message will be displayed on the screen.

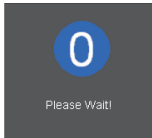
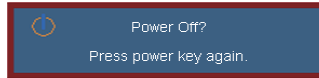

Press the “POWER” button again to confirm, otherwise the message will disappear after 15 seconds. When you press the “POWER” button a second time, the system will show the countdown timer on the screen.

2. The cooling fans continue to operate for about 10 seconds for cooling cycle. When the Power LED turns Red, the projector has entered standby mode.

If you wish to turn the projector back on, you must wait until the projector has completed the cooling cycle and has entered standby mode. Once in standby mode, simply press “POWER” button to restart the projector.

3. Disconnect the power cord from the electrical outlet and the projector.
4. Do not turn on the projector immediately following a power off procedure.

Warning Indicator



❖ Contact the nearest service center if the projector displays these symptoms. See pages 52-53 for more information.

- ❖ When the “LAMP” indicator lights red (“POWER” indicator flashes red), the projector will automatically shut down. Please call the nearest Optoma facility for assistance.
- ❖ When the “TEMP” indicator lights red (“POWER” indicator flashes red), it indicates the projector has overheated. The projector will shut down automatically. Under normal conditions, the projector can be switched on again after it has cooled down.
- ❖ When the “TEMP” indicator flashes red (“POWER” indicator flashes red), it indicates the fan has failed.

Adjusting the Projected Image

Adjusting the Projector's Height

The projector is equipped with elevator feet for adjusting the image height.

1. Locate the adjustable foot you wish to modify on the underside of the projector.
2. Rotate the three adjustable rings counter clockwise to raise the projector or clockwise to lower it. Repeat with the remaining feet as needed.

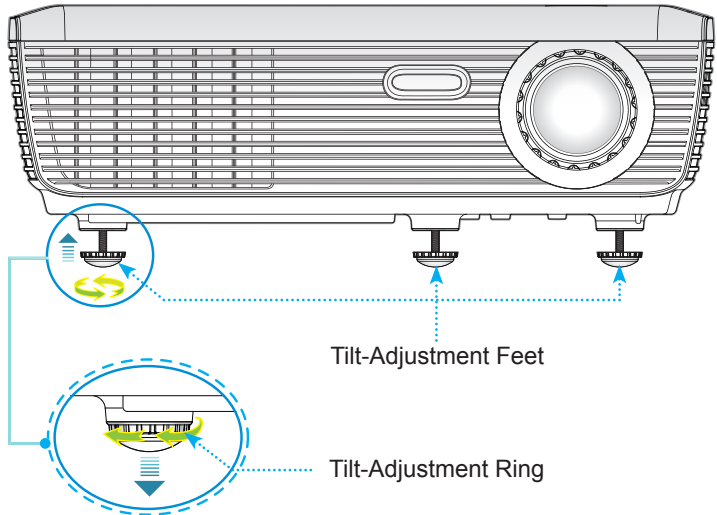

Installation

Adjusting the Projector's Zoom / Focus

You may turn the zoom ring to zoom in or out. To focus the image, rotate the focus ring until the image is clear. The projector will focus at distances from 3.9 to 39.4 feet (1.2 to 12.0 meters).

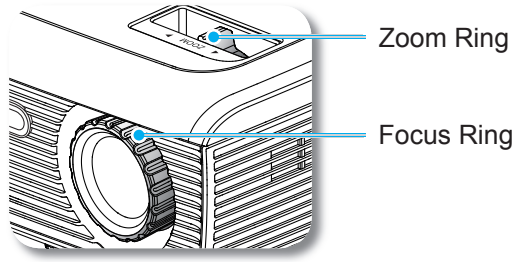

Adjusting Projection Image Size

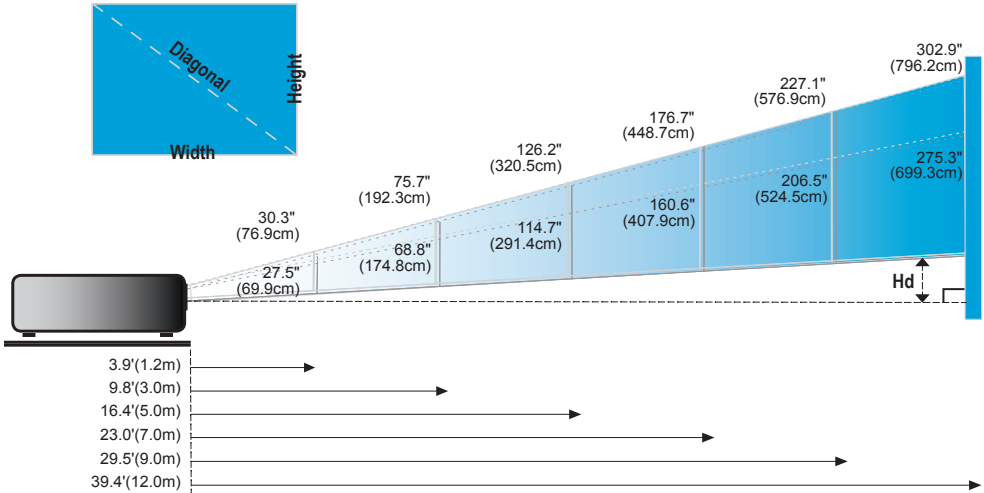

Screen (Diagonal)	Max.	30.3" (76.9cm)	75.7" (192.3cm)	126.2" (320.5cm)	176.7" (448.7cm)	227.1" (576.9cm)	302.9" (769.2cm)
	Min.	27.5" (69.9cm)	68.8" (174.8cm)	114.7" (291.4cm)	160.6" (407.9cm)	206.5" (524.5cm)	275.3" (699.3cm)
Screen Size	Max. (WxH)	24.2" x 18.2"	60.6" x 45.4"	101.0" x 75.7"	141.3" x 106.0"	181.7" x 136.3"	242.3" x 181.7"
	Min. (WxH)	55.9 x 42.0cm	139.9 x 104.9cm	233.1 x 174.8cm	326.3 x 244.8cm	419.6 x 314.7cm	559.4 x 419.6cm
Hd	Max.	2.73" (6.9cm)	6.81" (17.3cm)	11.36" (28.8cm)	15.9" (40.4cm)	20.44" (51.9cm)	27.26" (69.2cm)
	Min.	2.48" (6.3cm)	6.19" (15.7cm)	10.32" (26.2cm)	14.45" (36.7cm)	18.58" (47.2cm)	24.78" (62.9cm)
Distance		3.9' (1.2m)	9.8' (3.0m)	16.4' (5.0m)	23.0' (7.0m)	29.5' (9.0m)	39.4' (12.0m)

❖ This graph is for user's reference only.

User Controls







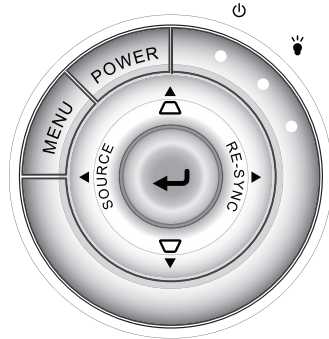



Control Panel & Remote Control

There are two ways for you to control the functions:
Control Panel and Remote Control.

Control Panel



Using the Control Panel



POWER	Refer to the “Power On/Off the Projector” section on pages 13-14.
MENU	Press “MENU” to launch the on-screen display (OSD) menu. To exit OSD, Press “MENU” again.
	Confirm your item selection.
RE-SYNC	Automatically synchronize the projector to the input source.
SOURCE	Press “SOURCE” to select an input signal.
Four Directional Select Keys	Use     to select items or make adjustments to your selection.
Keystone	Use   to adjust image distortion caused by tilting the projector. (± 40 degrees)
 Lamp LED	Indicate the projector’s lamp status.
 Temp LED	Indicate the projector’s temperature status.
 Power LED	Indicate the projector’s status.

User Controls

Remote Control



Using the Remote Control

Power 	Refer to the “Power On/Off the Projector” section on pages 13-14.
	Confirm your item selection.
Source	Press “SOURCE” to select an input signal.
Re-SYNC	Automatically synchronizes the projector to the input source.
Four Directional Select Keys	Use ▲ ▼ ◀ ▶ to select items or make adjustments to your selection.
Keystone +/-	Adjust image distortion caused by tilting the projector.
Volume +/-	Adjust to increase / decrease the volume.
Brightness	Adjust the brightness of the image.
Menu	Press “Menu” to launch the on-screen display (OSD) menu. To exit OSD, press “Menu” again.
ZOOM	Zoom in on an image. Press ◀ ▶ buttons to alter zoom.



User Controls

Remote Control



Using the Remote Control

Contrast	Control the degree of difference between the lightest and darkest parts of the picture.
Freeze	Press "Freeze" to pause the screen image. Press this button again to unlock.
AV mute	Momentarily turns off/on the audio and video.
S-Video	Press "S-Video" to choose S-Video source.
VGA	Press "VGA" to choose VGA sources.
Video	Press "Video" to choose Composite video source.

On-screen Display Menus

The Projector has multilingual On-screen Display menus that allow you to make image adjustments and change a variety of settings. The projector will automatically detect the source.

How to operate

1. To open the OSD menu, press “MENU” on the Remote Control or Projector Keypad.
2. When OSD is displayed, use ◀▶ keys to select any item in the main menu. While making a selection on a particular page, press ▼ or “Enter” key to enter sub menu.
3. Use ▲ ▼ keys to select the desired item and adjust the settings by ◀▶ key.
4. Select the next item to be adjusted in the sub menu and adjust as described above.
5. Press “Enter” to confirm, and the screen will return to the main menu.
6. To exit, press “MENU” again. The OSD menu will close and the projector will automatically save the new settings.

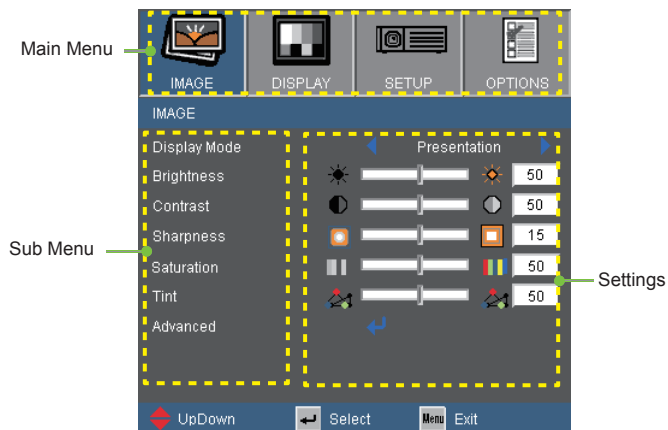

User Controls

Menu Tree

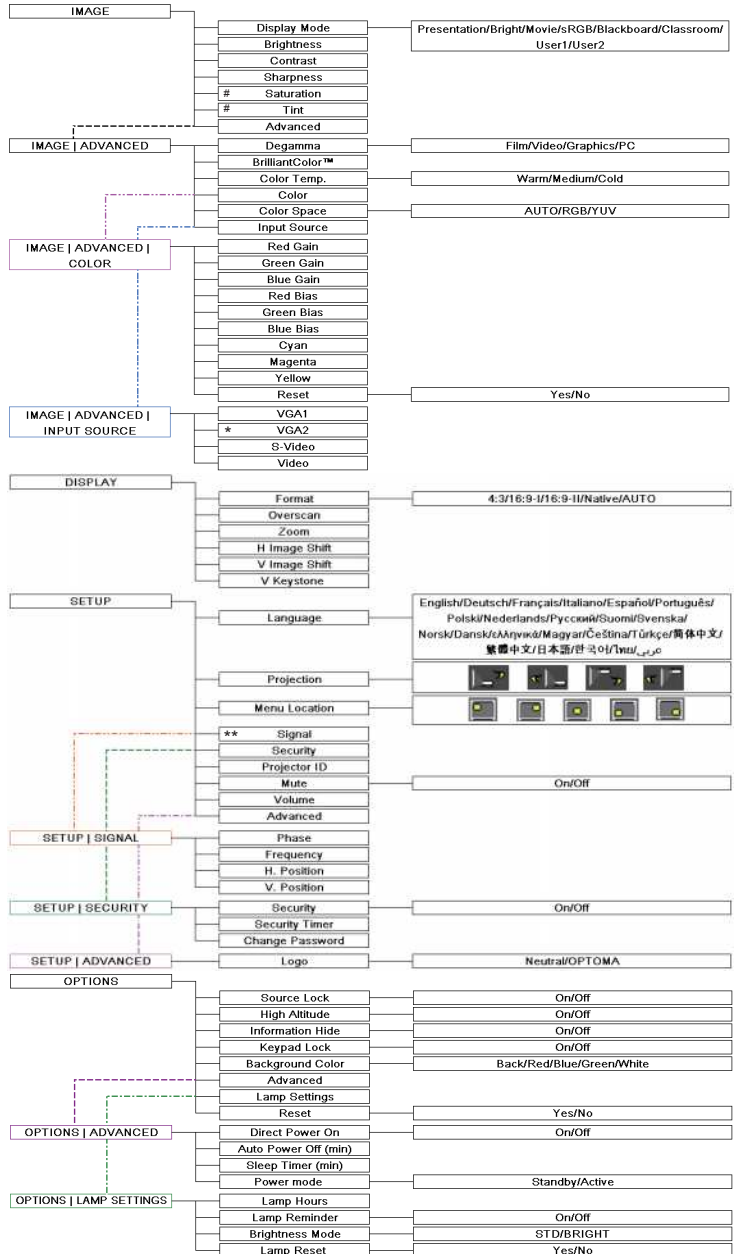

- ❖ (#) “Saturation” and “Tint” are only supported in Video mode.
- ❖ (*) “VGA2” is only supported in XGA mode.
- ❖ (**) “Signal” is only supported in Analog VGA (RGB) signal.

IMAGE

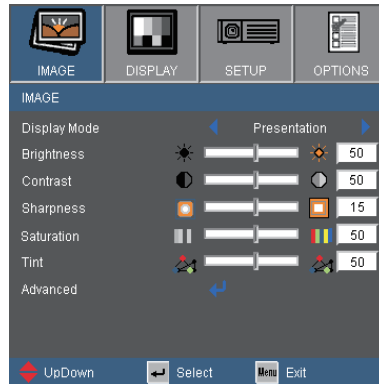

Display Mode

There are many factory presets optimized for various types of images.

- ▶ Presentation: Good color and brightness from PC input.
- ▶ Bright: Maximum brightness from PC input.
- ▶ Movie: For home theater.
- ▶ sRGB: Standardised accurate color.
- ▶ Blackboard: This mode should be selected to achieve optimum color settings when projecting onto a blackboard (green).
- ▶ Classroom: This mode is recommended for projecting in a classroom.
- ▶ User1: User's settings.
- ▶ User2: The initial default settings of this mode is from Movie mode. Any further adjustments by the user in User2 will be saved in this mode for future use.

Brightness

Adjust the brightness of the image.

- ▶ Press the ◀ to darken image.
- ▶ Press the ▶ to lighten the image.

IMAGE

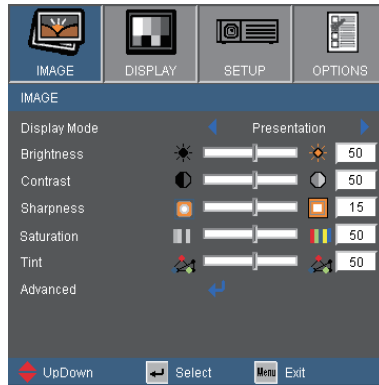

Contrast

The contrast controls the degree of difference between the lightest and darkest parts of the picture. Adjusting the contrast changes the amount of black and white in the image.

- ▶ Press the ◀ to decrease the contrast.
- ▶ Press the ▶ to increase the contrast.

Sharpness

Adjust the sharpness of the image.

- ▶ Press the ◀ to decrease the sharpness.
- ▶ Press the ▶ to increase the sharpness.

Saturation

Adjust a video image from black and white to fully saturated color.

- ▶ Press the ◀ to decrease the amount of saturation in the image.
- ▶ Press the ▶ to increase the amount of saturation in the image.



- ❖ “Saturation” and “Tint” functions are only supported under Video mode.

Tint

Adjust the color balance of red and green.

- ▶ Press the ◀ to increase the amount of green in the image.
- ▶ Press the ▶ to increase the amount of red in the image.

IMAGE | Advanced

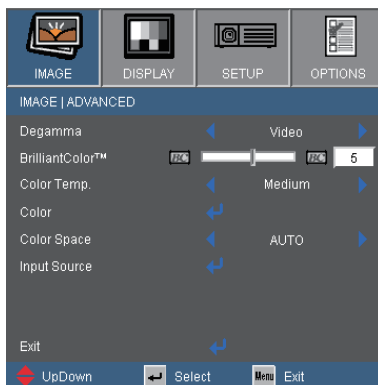

Degamma

This allows you to choose a degamma table that has been fine-tuned to bring out the best image quality for the input.

- ▶ Film: for home theater.
- ▶ Video: for video or TV source.
- ▶ Graphics: for image source.
- ▶ PC: for PC or computer source.

BrilliantColor™

This adjustable item utilizes a new color-processing algorithm and system level enhancements to enable higher brightness while providing true, more vibrant colors in picture. The range is from “0” to “10”. If you prefer a stronger enhanced image, adjust toward the maximum setting. For a smoother, more natural image, adjust toward the minimum setting.

Color Temp

If set to cold temperature, the image looks more blue. (cold image)
If set to warm temperature, the image looks more red.
(warm image)

Color Space

Select an appropriate color matrix type from AUTO, RGB or YUV.

Advanced | Color

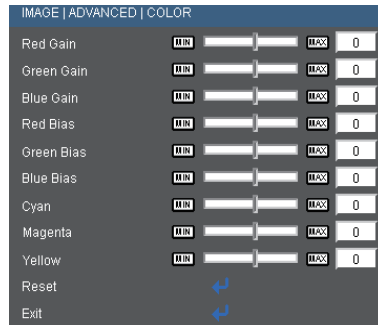

Color

Use these settings for advanced adjustment of the individual Red, Green, Blue, Cyan, Magenta and Yellow Colors.

Reset

Choose “Yes” to return the factory default settings for color adjustments.

Advanced | Input Source



Input Source

Use this option to enable / disable input sources. Press ↵ to enter the sub menu and select which sources you require. Press “Enter” to finalize the selection. The projector will not search for inputs that are not selected.

DISPLAY

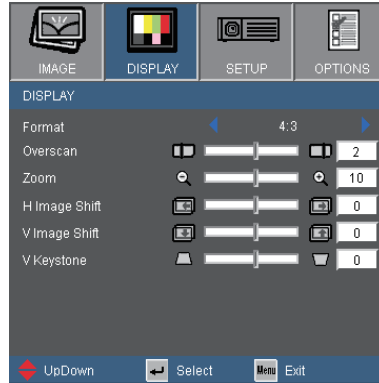

Format

Use this function to choose your desired aspect ratio.

- ▶ 4:3: This format is for 4×3 input sources.
- ▶ 16:9-I: This format is for 16×9 input sources, like HDTV and DVD enhanced for Wide screen TV. (576i/p)
- ▶ 16:9-II: This format is for 16×9 input sources, like HDTV and DVD enhanced for Wide screen TV. (480i/p)
- ▶ Native: This format displays the original image without any scaling.
- ▶ AUTO: Automatically selects the appropriate display format.

Aspect ratio (source detected)	Resize image	
	SVGA model	XGA model
4:3	800 x 600 center	1024 x 768 center
16:9-I	800 x 450 center	1024 x 576 center
16:9-II	854 x 480 catch 800 x 480 center	854 x 480 center
Native	1:1 mapping center	768 x 576 center

DISPLAY

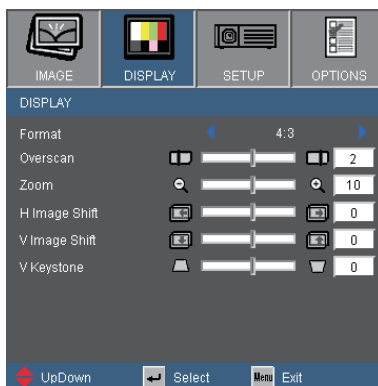

Overscan

Overscan function removes the noise in a video image. Overscan the image to remove video encoding noise on the edge of video source.

Zoom

- ▶ Press the ◀ to reduce the size of an image.
- ▶ Press the ▶ to magnify an image on the projection screen.

H Image Shift

Shift the projected image position horizontally.

V Image Shift

Shift the projected image position vertically.

V Keystone

Press the ◀ or ▶ to adjust image distortion vertically and makes a rectangular image.

SETUP | Language



Language

Choose the multilingual OSD menu. Press ◀ or ▶ into the sub menu and then use the ▲ or ▼ key to select your preferred language. Press “Enter” to finalize the selection.

SETUP

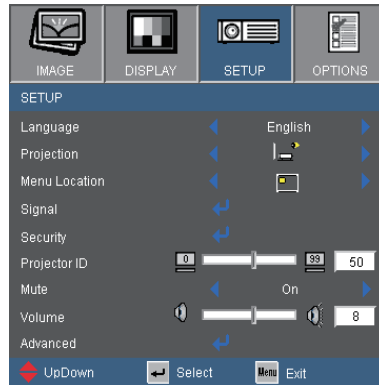

- ❖ Rear-Desktop and Rear-Ceiling are to be used with a translucent screen.

Projection



Front-Desktop

This is the default selection. The image is projected straight on the screen.



Rear-Desktop

When selected, the image will appear reversed.



Front-Ceiling

When selected, the image will turn upside down.



Rear-Ceiling

When selected, the image will appear reversed in upside down position.

SETUP

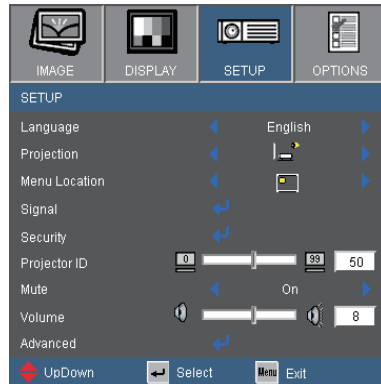

Menu Location

Choose the menu location on the display screen.

Projector ID

ID definition can be set up by menu (range 0~99), and allow user control an individual projector by RS232. Refer to page 48 for the complete list of RS232 commands.

Mute

- ▶ Choose the “On” to turn mute on.
- ▶ Choose the “Off” to turn mute off.

Volume

- ▶ Press the ◀ to decrease the volume.
- ▶ Press the ▶ to increase the volume.

SETUP | Signal

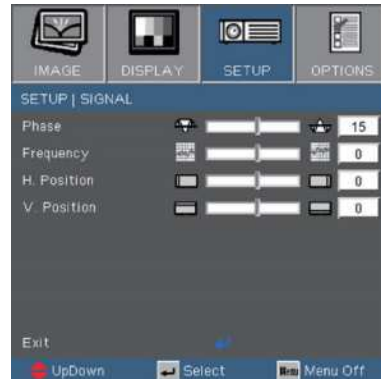

- ❖ “Signal” is only supported in Analog VGA (RGB) signal.

Phase

Synchronize the signal timing of the display with the graphic card. If the image appears to be unstable or flickers, use this function to correct it.

Frequency

Change the display data frequency to match the frequency of your computer’s graphic card. Use this function only if the image appears to flicker vertically.

H. Position

- ▶ Press the ◀ to move the image left.
- ▶ Press the ▶ to move the image right.

V. Position

- ▶ Press the ◀ to move the image down.
- ▶ Press the ▶ to move the image up.

SETUP | Security

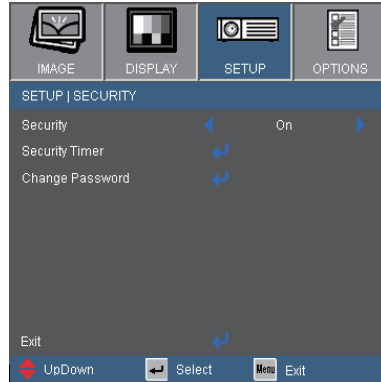

Security

- ▶ On: Choose "On" to use security verification when the turning on the projector.
- ▶ Off: Choose "Off" to be able to switch on the projector without password verification.

Security Timer

Can be select the time (Month/Day/Hour) function to set the number of hours the projector can be used. Once this time has elapsed you will be requested to enter your password again.



SETUP | Security

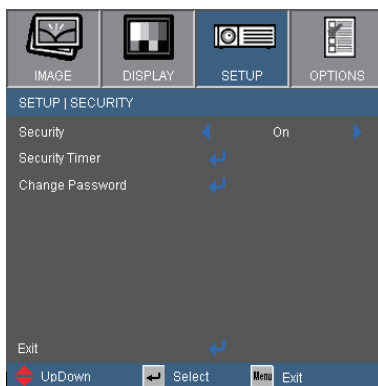

❖ Pass-code default value is “1234” (first time).



Change Password

▶ First time:

1. Press “←” to set the password.
2. The password has to be 4 digits.
3. Use number button on the remote to enter your new password and then press “←” key to confirm your password.

▶ Change Password:

1. Press “←” to input old password.
 2. Use number button to enter current password and then press “←” to confirm.
 3. Enter new password (4 digits in length) using the number buttons on the remote, then press “←” to confirm.
 4. Enter new password again and press “←” to confirm.
- ▶ If you have forgotten your password, please contact your local office for support.

SETUP | Advanced

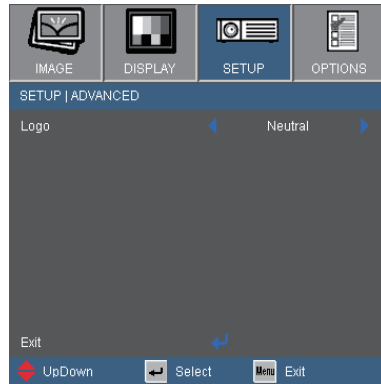

Logo

Use this function to set the desired startup screen. If changes are made they will take effect the next time the projector is powered on.

- ▶ Optoma: The default startup screen.
- ▶ Neutral: No logo is displayed.

OPTIONS

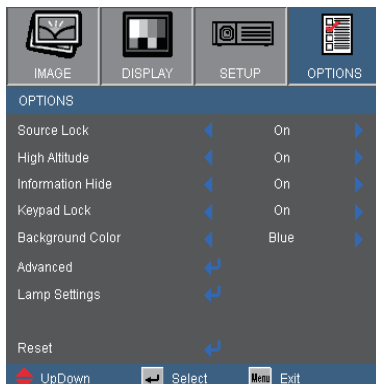

Source Lock

- ▶ On: The projector will search specified connection port.
- ▶ Off: The projector will search for other signals if the current input signal is lost.

High Altitude

When “On” is selected, the fans will spin faster. This feature is useful in high altitude areas where the air is thin.

Information Hide

- ▶ On: Choose “On” to hide the “searching” message.
- ▶ Off: Choose “Off” to show the “searching” message.

Keypad Lock

When the keypad lock function is “On”, the control panel will be locked however, the projector can be operated by the remote control. By selecting “Off”, you will be able to reuse the control panel.

Background Color

Use this feature to display a “Black”, “Red”, “Blue”, “Green” or “White”, screen when no signal is available.

Reset

Choose “Yes” to return the display parameters on all menus to the factory default settings.



- ❖ To turn off the keypad lock, press and hold “Enter” key on top of the projector for 5 seconds.

OPTIONS | Advanced

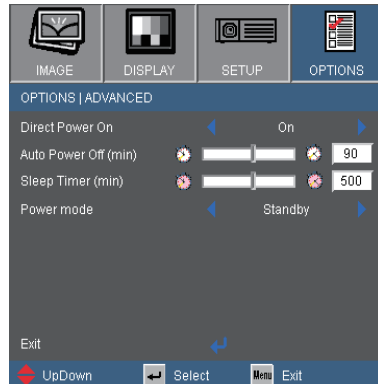

Direct Power On

Choose “On” to activate Direct Power mode. The projector will automatically power on when AC power is supplied, without pressing the “Power” key on the projector control panel or “Power” key on the remote control.

Auto Power Off (min)

Sets the countdown timer interval. The countdown timer will start, when there is no signal being sent to the projector. The projector will automatically power off when the countdown has finished (in minutes).

Sleep Timer (min)

Sets the countdown timer interval. The countdown timer will start, with or without a signal being sent to the projector. The projector will automatically power off when the countdown has finished (in minutes).



❖ This disables VGA out and RJ45 control when the projector is in standby mode (<1W).

Power mode

- ▶ Standby: Choose “Standby” to save power dissipation further < 1W.
- ▶ Active: Choose “Active” to return to normal standby mode and the VGA out port will be enabled.

OPTIONS | Lamp Settings

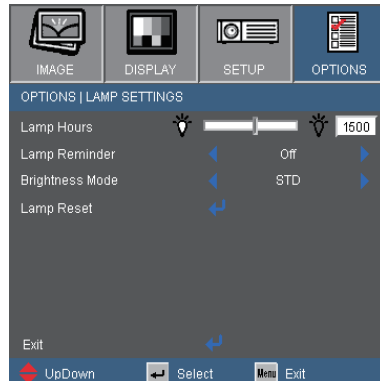

Lamp Hours

Display the projection time.

Lamp Reminder

Choose this function to show or to hide the warning message when the changing lamp message is displayed.

The message will appear 30 hours before suggested replacement of lamp.

Brightness Mode

- ▶ STD: Choose “STD” to dim the projector lamp which will lower power consumption and extend the lamp life by up to 130%.
- ▶ BRIGHT: Choose “BRIGHT” to increase the brightness.

Lamp Reset

Reset the lamp hour counter after replacing the lamp.

Troubleshooting

If you experience a problem with your projector, please refer to the following information. If a problem persists, please contact your local reseller or service center.

Image Problems

[?] No image appears on-screen

- ▶ Ensure all the cables and power connections are correctly and securely connected as described in the “Installation” section.
- ▶ Ensure all the pins of connectors are not bent or broken.
- ▶ Check if the projection lamp has been securely installed. Please refer to the “Replacing the lamp” section.
- ▶ Make sure you have removed the lens cap and the projector is switched on.
- ▶ Ensure that the “AV mute” feature is not turned on.

[?] Partial, scrolling or incorrectly displayed image

- ▶ Press “RE-SYNC” on the remote.
- ▶ If you are using a PC:

For Windows 95, 98, 2000, XP:

1. Open the “My Computer” icon, the “Control Panel” folder, and then double click on the “Display” icon.
2. Select the “Settings” tab.
3. Verify that your display resolution setting is lower than or equal to UXGA (1600 × 1200).
4. Click on the “Advanced Properties” button.

If the projector is still not projecting the whole image, you will also need to change the monitor display you are using. Refer to the following steps.

5. Verify the resolution setting is lower than or equal to UXGA (1600 × 1200).
6. Select the “Change” button under the “Monitor” tab.

Appendices

7. Click on “Show all devices”. Next, select “Standard monitor types” under the SP box; choose the resolution mode you need under the “Models” box.
 8. Verify that the resolution setting of the monitor display is lower than or equal to UXGA (1600 × 1200).
- ▶ If you are using a Notebook:
1. First, follow the steps above to adjust resolution of the computer.
 2. Press the appropriate keys listed below for your notebook manufacturer to send signal out from notebook to projector.
Example: [Fn]+[F4]

Acer ⇨	[Fn]+[F5]	IBM/Lenovo ⇨	[Fn]+[F7]
Asus ⇨	[Fn]+[F8]	HP/Compaq ⇨	[Fn]+[F4]
Dell ⇨	[Fn]+[F8]	NEC ⇨	[Fn]+[F3]
Gateway ⇨	[Fn]+[F4]	Toshiba ⇨	[Fn]+[F5]

Mac Apple:
System Preference ⇨ Display ⇨ Arrangement ⇨ Mirror display

- ▶ If you experience difficulty changing resolutions or your monitor freezes, restart all equipment including the projector.

[?] The screen of the Notebook or PowerBook computer is not displaying your presentation

- ▶ If you are using a Notebook PC
Some Notebook PCs may deactivate their own screens when a second display device is in use. Each has a different way to be reactivated. Refer to your computer’s manual for detailed information.

[?] Image is unstable or flickering

- ▶ Use “Phase” to correct it. See page 32 for more information.
▶ Change the monitor color setting on your computer.

[?] Image has vertical flickering bar

- ▶ Use “Frequency” to make an adjustment. See page 32 for more information.
▶ Check and reconfigure the display mode of your graphic card to make it compatible with the projector.

[?] Image is out of focus

- ▶ Make sure the lens cap is removed.
- ▶ Adjust the Focus Ring on the projector lens.
- ▶ Make sure the projection screen is between the required distance 3.9 to 39.4 feet (1.2 to 12.0 meters) from the projector.
See page 16.



[?] The image is stretched when displaying 16:9 DVD title

- ▶ When you play anamorphic DVD or 16:9 DVD, the projector will show the best image in 16:9 format on projector side.
- ▶ If you play 4:3 format DVD titles, please change the format to 4:3 in the projector OSD.
- ▶ If the image is still stretched, you will also need to adjust the aspect ratio by referring to the following:
- ▶ Please setup the display format as 16:9 (wide) aspect ratio type on your DVD player.

[?] Image is too small or too large

- ▶ Adjust the Zoom Ring on the top of the projector.
- ▶ Move the projector closer to or further from the screen.
- ▶ Press “MENU” button on the remote control or projector panel, go to “Display → Format” and try the different settings.

[?] Image has slanted sides

- ▶ If possible, reposition the projector so that it is horizontally centered on the screen and below the bottom of the screen.
- ▶ Press “Keystone +/-” button on the remote control or press “ / 

❖ Use of Keystone is not recommended.

[?] Image is reversed

- ▶ Select “SETUP → Projection” from the OSD and adjust the projection direction.

Other Problems

[?] The projector stops responding to all controls

- ▶ If possible, turn off the projector, then unplug the power cord and wait at least 60 seconds before reconnecting power.
- ▶ Check that “Keypad Lock” is not activated by trying to control the projector with the remote control.

[?] Lamp burns out or makes a popping sound

- ▶ When the lamp reaches its end of life, it will burn out and may make a loud popping sound. If this happens, the projector will not turn on until the lamp module has been replaced. To replace the lamp, follow the procedures in the “Replacing the Lamp” section on pages 44-45.

Projector Status Indication

[?] LED lighting message

Message	Power LED	Temp-LED	Lamp-LED
	(Green/Red)	(Red)	(Red)
Standby State (Input power cord)	Red	○	○
Power on (Warming)	Flashing Green	○	○
Lamp lighting	Green	○	○
Power off (Cooling)	Flashing Green	○	○
Error (Over Temp.)	Flashing Red	☀	○
Error (Fan fail)	Flashing Red	Flashing	○
Error (Lamp fail)	Flashing Red	○	☀



Steady light ⇔ ☀

No light ⇔ ○

? On Screen Messages

▶ Temperature warning:

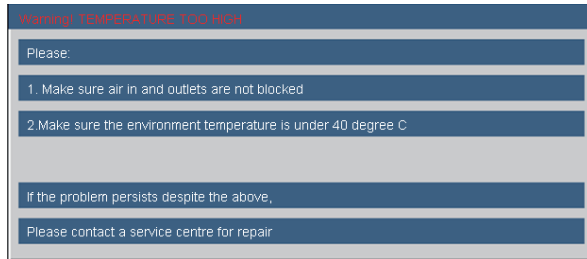

▶ Fan failed:



▶ Lamp warning:

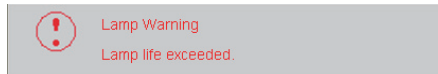

▶ Out of display range:



Remote Control Problems

? If the remote control does not work

- ▶ Check the operating angle of the remote control is within $\pm 15^\circ$ both horizontally and vertically of one of the IR receivers on the projector.
- ▶ Make sure there are not any obstructions between the remote control and the projector. Move to within 7 m ($\pm 0^\circ$) of the projector.
- ▶ Make sure the batteries are inserted correctly.
- ▶ Replace batteries if they are exhausted.

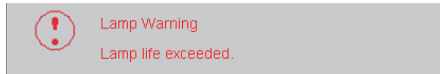

Replacing the lamp

The projector automatically detects the lamp life. When the lamp life is nearing the end of use, you will receive a warning message.



When you see this message, please contact your local reseller or service center to change the lamp as soon as possible. Make sure the projector has been cooled down for at least 30 minutes before changing the lamp.



-  Warning: If ceiling mounted, please use caution when opening the lamp access panel. It is recommended to wear safety glasses if changing the bulb when ceiling mounted. "Caution must be used to prevent any loose parts from falling out of projector."
-  Warning: Lamp compartment may be hot! Allow it to cool down before changing the lamp!
-  Warning: To reduce the risk of personal injury, do not drop the lamp module or touch the lamp bulb. The bulb may shatter and cause injury if it is dropped.



- ❖ The screws on the lamp cover and the lamp cannot be removed.
- ❖ The projector cannot be turned on if the lamp cover has not been placed back on the projector.
- ❖ Do not touch the glass area of the lamp. Hand oil can cause the lamp to shatter. Use a dry cloth to clean the lamp module if it was accidentally touched.

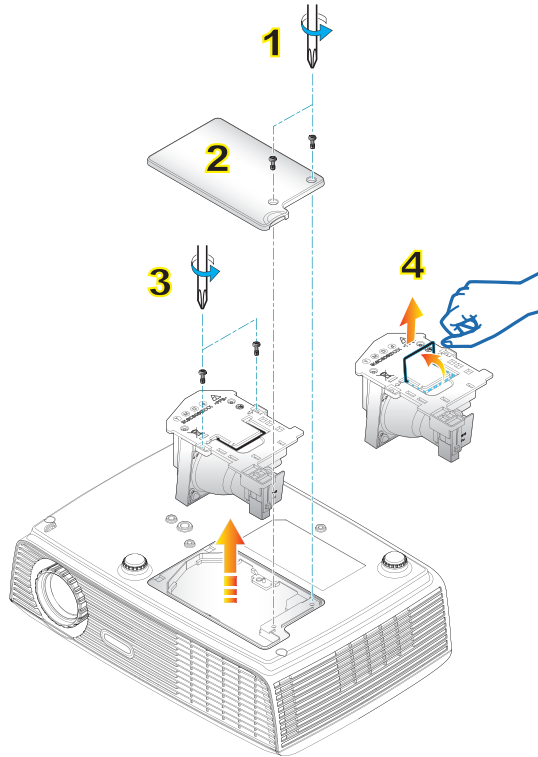

Lamp Replacement Procedure:

1. Switch off the power to the projector by pressing the “POWER” button.
 2. Allow the projector to cool down for at least 30 minutes.
 3. Disconnect the power cord.
 4. Unscrew the two screws on the cover. **1**
 5. Lift up and remove the cover. **2**
 6. Unscrew the two screws on the lamp module. **3**
 7. Lift up the lamp handle and remove the lamp module slowly and carefully. **4**
- To replace the lamp module, reverse the previous steps.
8. Turn on the projector and use “Lamp Reset” after the lamp module is replaced.
- Lamp Reset: (i) Press “MENU” → (ii) Select “OPTIONS” → (iii) Select “Lamp Settings” → (iv) Select “Lamp Reset” → (v) Select “Yes”.

Compatibility Modes

► Computer Compatibility

Mode	Resolution	V-Sync (Hz)	H-Sync (KHz)
VGA	640 × 350	70	31.50
VGA	640 × 350	85	37.90
VGA	640 × 400	85	37.90
VGA	640 × 480	60	31.50
VGA	640 × 480	72	37.90
VGA	640 × 480	75	37.50
VGA	640 × 480	85	43.30
VGA	720 × 400	70	31.50
VGA	720 × 400	85	37.90
SVGA	800 × 600	56	35.20
SVGA	800 × 600	60	37.90
SVGA	800 × 600	72	48.10
SVGA	800 × 600	75	46.90
SVGA	800 × 600	85	53.70
XGA	1024 × 768	60	48.40
XGA	1024 × 768	70	56.50
XGA	1024 × 768	75	60.00
XGA	1024 × 768	85	68.70
WXGA	1280 × 768	60	47.40
WXGA	1280 × 768	75	60.30
WXGA	1280 × 720	60	45.00
WXGA	1280 × 800	60	49.70
SXGA	1152 × 864	60	53.50
SXGA	1152 × 864	70	63.80
SXGA	1152 × 864	75	67.50
SXGA	1152 × 864	85	77.10
SXGA	1280 × 1024	60	63.98
SXGA	1280 × 1024	75	79.98
SXGA	1280 × 1024	85	91.10
SXGA	1280 × 960	60	60.00
SXGA+	1400 × 1050	60	63.98
UXGA	1600 × 1200	60	75.00



- ❖ For widescreen resolution (WXGA), the compatibility support is dependent on Notebook/PC models.

Appendices

► Computer Compatibility

Mode	Resolution	V-Sync (Hz)	H-Sync (KHz)
MAC LC 13"	640 × 480	66.66	34.98
MAC II 13"	640 × 480	66.68	35.00
MAC 16"	832 × 624	74.55	49.73
MAC 19"	1024 × 768	75	60.24
MAC	1152 × 870	75.06	68.68
MAC G4	640 × 480	60	31.35
i MAC DV	1024 × 768	75	60.00
i MAC DV	1152 × 870	75	68.49
i MAC DV	1280 × 960	75	75.00

► Video Compatibility

NTSC	M (3.58MHz), 4.43 MHz, 480i/p @60Hz
PAL	B, D, G, H, I, M, N, 576i/p @50Hz
SECAM	B, D, G, K, K1, L
SDTV/HDTV	480i/p, 576i/p, 720p@50Hz/60Hz, 1080i/p@50Hz/60Hz

RS232 Commands

RS232 Pin Assignments

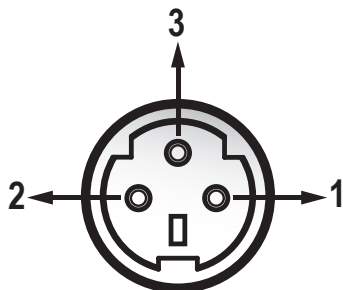

Pin no.	Name	I/O (From Projector Side)
1	TXD	OUT
2	RXD	IN
3	GND	GND

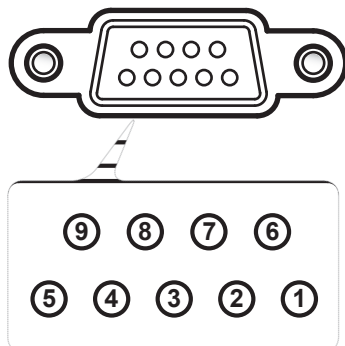

Pin no.	Spec.
1	N/A
2	RXD
3	TXD
4	N/A
5	GND
6	N/A
7	N/A
8	N/A
9	N/A

Appendices

RS232 Protocol Function List

RS232 Commands

Baud Rate : 9600

Data Bits: 8

Parity: None

Stop Bits: 1

Flow Control : None

UART16550 FIFO: Disable

Projector Return (Pass): P

Projector Return (Fail): F

XX=00-99, projector's ID,

XX=00 is for all projectors

SEND to projector

232 ASCII Code	HEX Code	Function	Description
--XX00 1	7E 30 30 30 20 31 0D	Power ON	
--XX00 0	7E 30 30 30 20 30 0D	Power OFF	(0/2 for backward compatible)
--XX00 1-nmmn	7E 30 30 30 20 31 20 a 0D	Power ON with Password	-nmmn = -0000 (a=7E 30 30 30 30) - -9999 (a=7E 39 39 39 39)
--XX01 1	7E 30 30 30 31 20 31 0D	Resync	
--XX02 1	7E 30 30 30 32 20 31 0D	AV Mute	On
--XX02 0	7E 30 30 32 20 30 0D		Off (0/2 for backward compatible)
--XX03 1	7E 30 30 30 33 20 31 0D	Mute	On
--XX03 0	7E 30 30 33 20 30 0D		Off (0/2 for backward compatible)
--XX04 1	7E 30 30 30 34 20 31 0D	Freeze	
--XX04 0	7E 30 30 34 20 30 0D	Unfreeze	(0/2 for backward compatible)
--XX05 1	7E 30 30 30 35 20 31 0D	Zoom Plus	
--XX06 1	7E 30 30 30 36 20 31 0D	Zoom Minus	
--XX07 1	7E 30 30 30 37 20 31 0D	Up (Pan under zoom)	
--XX08 1	7E 30 30 30 38 20 31 0D	Down (Pan under zoom)	
--XX09 1	7E 30 30 30 39 20 31 0D	Left (Pan under zoom)	
--XX10 1	7E 30 30 31 30 20 31 0D	Right (Pan under zoom)	
--XX12 5	7E 30 30 31 32 20 35 0D		VGA 1
--XX12 6	7E 30 31 32 20 36 0D		VGA 2
--XX12 7	7E 30 31 32 20 37 0D		VGA 1 SCART
--XX12 8	7E 30 31 32 20 38 0D		VGA 1 Component
--XX12 9	7E 30 31 32 20 39 0D		S-Video
--XX12 10	7E 30 31 32 20 31 30 0D		Video
--XX12 13	7E 30 31 32 20 31 33 0D		VGA 2 Component
--XX20 1	7E 30 32 30 20 31 0D	Display Mode	Presentation
--XX20 2	7E 30 32 30 20 32 0D		Bright
--XX20 3	7E 30 32 30 20 33 0D		Movie
--XX20 4	7E 30 32 30 20 34 0D		sRGB
--XX20 5	7E 30 32 30 20 35 0D		User1
--XX20 6	7E 30 32 30 20 36 0D		User2
--XX20 7	7E 30 32 30 20 37 0D		Blackboard
--XX20 8	7E 30 32 30 20 38 0D		Classroom
--XX21 n	7E 30 32 31 20 a 0D	Brightness	n = 0 (a=30) ~ 100 (a=31 30 30)
--XX22 n	7E 30 32 32 20 a 0D	Contrast	n = 0 (a=30) ~ 100 (a=31 30 30)
--XX23 n	7E 30 32 33 20 a 0D	Sharpness	n = 0 (a=30) ~ 21 (a=33 31)
--XX24 n	7E 30 32 34 20 a 0D	Color Settings	Red Gain n = -50 (a=2D 35 30) ~ 50 (a=35 30)
--XX25 n	7E 30 32 35 20 a 0D		Green Gain n = -50 (a=2D 35 30) ~ 50 (a=35 30)
--XX26 n	7E 30 32 36 20 a 0D		Blue Gain n = -50 (a=2D 35 30) ~ 50 (a=35 30)
--XX27 n	7E 30 32 37 20 a 0D		Red Bias n = -50 (a=2D 35 30) ~ 50 (a=35 30)
--XX28 n	7E 30 32 38 20 a 0D		Green Bias n = -50 (a=2D 35 30) ~ 50 (a=35 30)
--XX29 n	7E 30 32 39 20 a 0D		Blue Bias n = -50 (a=2D 35 30) ~ 50 (a=35 30)
--XX30 n	7E 30 33 30 20 a 0D		Cyan n = -50 (a=2D 35 30) ~ 50 (a=35 30)
--XX31 n	7E 30 33 31 20 a 0D		Yellow n = -50 (a=2D 35 30) ~ 50 (a=35 30)
--XX32 n	7E 30 33 32 20 a 0D		Magenta n = -50 (a=2D 35 30) ~ 50 (a=35 30)
--XX33 1	7E 30 33 33 20 31 0D		Reset
--XX34 n	7E 30 33 34 20 a 0D	BrilliantColor™	n = 0 (a=30) ~ 10 (a=31 30)
--XX35 1	7E 30 33 35 20 31 0D	Degamma	Film
--XX35 2	7E 30 33 35 20 32 0D		Video
--XX35 3	7E 30 33 35 20 33 0D		Graphics
--XX35 4	7E 30 33 35 20 34 0D		PC
--XX36 1	7E 30 33 36 20 31 0D	Color Temp.	Warm
--XX36 2	7E 30 33 36 20 32 0D		Medium
--XX36 3	7E 30 33 36 20 33 0D		Cold
--XX37 1	7E 30 33 37 20 31 0D	Color Space	Auto
--XX37 2	7E 30 33 37 20 32 0D		RGB
--XX37 3	7E 30 33 37 20 33 0D		YUV
--XX44 n	7E 30 34 34 20 a 0D	Tint	n = 0 (a=30) ~ 100 (a=31 30 30)
--XX45 n	7E 30 34 35 20 a 0D	Color (Saturation)	n = 0 (a=30) ~ 100 (a=31 30 30)
--XX60 1	7E 30 36 30 20 31 0D	Format	4:3
--XX60 2	7E 30 36 30 20 32 0D		16:9-I
--XX60 3	7E 30 36 30 20 33 0D		16:9-II
--XX60 6	7E 30 36 30 20 36 0D		Native
--XX60 7	7E 30 36 30 20 37 0D		Auto
--XX61 n	7E 30 36 31 20 a 0D	Overscan	n = 0 (a=30) ~ 3 (a=33)
--XX62 n	7E 30 36 32 20 a 0D	Zoom	n = -5 (a=2D 35) ~ 25 (a=32 35)
--XX63 n	7E 30 36 33 20 a 0D	H Image Shift	n = -50 (a=2D 35 30) ~ +50 (a=35 30)
--XX64 n	7E 30 36 34 20 a 0D	V Image Shift	n = -50 (a=2D 35 30) ~ +50 (a=35 30)
--XX66 n	7E 30 36 36 20 a 0D	V Keystone	n = -40 (a=2D 34 30) ~ 40 (a=34 30)
--XX70 1	7E 30 37 30 20 31 0D	Language	English
--XX70 2	7E 30 37 30 20 32 0D		German
--XX70 3	7E 30 37 30 20 33 0D		French
--XX70 4	7E 30 37 30 20 34 0D		Italian
--XX70 5	7E 30 37 30 20 35 0D		Spanish
--XX70 6	7E 30 37 30 20 36 0D		Portuguese
--XX70 7	7E 30 37 30 20 37 0D		Polish
--XX70 8	7E 30 37 30 20 38 0D		Dutch
--XX70 9	7E 30 37 30 20 39 0D		Swedish
--XX70 10	7E 30 37 30 20 31 30 0D		Norwegian/Danish
--XX70 11	7E 30 37 30 20 31 31 0D		Finnish
--XX70 12	7E 30 37 30 20 31 32 0D		Greek
--XX70 13	7E 30 37 30 20 31 33 0D		Traditional Chinese
--XX70 14	7E 30 37 30 20 31 34 0D		Simplified Chinese
--XX70 15	7E 30 37 30 20 31 35 0D		Japanese
--XX70 16	7E 30 37 30 20 31 36 0D		Korean
--XX70 17	7E 30 37 30 20 31 37 0D		Russian
--XX70 18	7E 30 37 30 20 31 38 0D		Hungarian
--XX70 19	7E 30 37 30 20 31 39 0D		Czechoslovak
--XX70 20	7E 30 37 30 20 32 30 0D		Arabic
--XX70 21	7E 30 37 30 20 32 31 0D		Thai
--XX70 22	7E 30 37 30 20 32 32 0D		Turkish
--XX71 1	7E 30 37 31 20 31 0D	Projection	Front-Desktop
--XX71 2	7E 30 37 31 20 32 0D		Rear-Desktop
--XX71 3	7E 30 37 31 20 33 0D		Front-Ceiling
--XX71 4	7E 30 37 31 20 34 0D		Rear-Ceiling



1. There is a <CR> after all ASCII commands.

2. 0D is the HEX code for <CR> in ASCII code.

Appendices

SEND to projector

232 ASCII Code	HEX Code	Function	Description
--XX72 1	7E 30 30 37 32 20 31 0D	Menu Location	Top Left
--XX72 2	7E 30 30 37 32 20 32 0D		Top Right
--XX72 3	7E 30 30 37 32 20 33 0D		Centre
--XX72 4	7E 30 30 37 32 20 34 0D		Bottom Left
--XX72 5	7E 30 30 37 32 20 35 0D		Bottom Right
--XX73 n	7E 30 30 37 33 20 a 0D	Signal	Frequency n = -5 (a=2D 35) - 5 (a=35) By signal
--XX74 n	7E 30 30 37 34 20 a 0D		Phase n = 0 (a=30) - 31 (a=33 31) By signal
--XX75 n	7E 30 30 37 35 20 a 0D		H. Position n = -5 (a=2D 35) - 5 (a=35) By timing
--XX76 n	7E 30 30 37 36 20 a 0D		V. Position n = -5 (a=2D 35) - 5 (a=35) By timing
--XX77 n	7E 30 30 37 37 20 aabbcc OD	Security	Security Timer Month/Day/Hour n = mmm/dd/hh mm = 00 (aa=30 30) - 12 (aa=31 32) dd = 00 (bb=30 30) - 30 (bb=33 30) hh = 00 (cc=30 30) - 24 (cc=32 34)
--XX78 1	7E 30 30 37 38 20 31 0D		Security Settings
--XX78 0	7E 30 30 37 38 20 32 0D		Enable
--XX79 n	7E 30 30 37 39 20 a 0D	Projector ID	Disable (0/2 for backward compatible) n = 00 (a=30 30) - 99 (a=39 39)
--XX80 1	7E 30 30 38 30 20 31 0D	Mute	On
--XX80 0	7E 30 30 38 30 20 30 0D		Off (0/2 for backward compatible)
--XX81 n	7E 30 30 38 31 20 a 0D	Volume	n = 0 (a=30) - 10 (a=31 30)
--XX82 1	7E 30 30 38 32 20 31 0D	Logo	Optoma
--XX82 3	7E 30 30 38 32 20 33 0D		Neutral
--XX100 1	7E 30 30 31 30 30 20 31 0D	Source Lock	On
--XX100 0	7E 30 30 31 30 30 20 30 0D		Off (0/2 for backward compatible)
--XX100 3	7E 30 30 31 30 30 20 33 0D	Next Source	On
--XX101 1	7E 30 30 31 30 31 20 31 0D	High Altitude	On
--XX101 0	7E 30 30 31 30 31 20 30 0D		Off (0/2 for backward compatible)
--XX102 1	7E 30 30 31 30 32 20 31 0D	Information Hide	On
--XX102 0	7E 30 30 31 30 32 20 30 0D		Off (0/2 for backward compatible)
--XX103 1	7E 30 30 31 30 33 20 31 0D	Keypad Lock	On
--XX103 0	7E 30 30 31 30 33 20 30 0D		Off (0/2 for backward compatible)
--XX104 1	7E 30 30 31 30 34 20 31 0D	Background Color	Blue
--XX104 2	7E 30 30 31 30 34 20 32 0D		Black
--XX104 3	7E 30 30 31 30 34 20 33 0D		Red
--XX104 4	7E 30 30 31 30 34 20 34 0D		Green
--XX104 5	7E 30 30 31 30 34 20 35 0D		White
--XX105 1	7E 30 30 31 30 35 20 31 0D	Advanced	Direct Power On On
--XX105 0	7E 30 30 31 30 35 20 30 0D		Off (0/2 for backward compatible)
--XX106 n	7E 30 30 31 30 36 20 a 0D		Auto Power Off (min) n = 0 (a=30) - 180 (a=31 38 30)
--XX107 n	7E 30 30 31 30 37 20 a 0D		Sleep Timer (min) n = 0 (a=30) - 999 (a=39 39 39)
--XX114 1	7E 30 30 31 31 34 20 31 0D		Eco. Standby(1W) On
--XX114 0	7E 30 30 31 31 34 20 30 0D		Off (0/2 for backward compatible)
--XX109 1	7E 30 30 31 30 39 20 31 0D	Lamp Reminder	On
--XX109 0	7E 30 30 31 30 39 20 30 0D		Off (0/2 for backward compatible)
--XX110 1	7E 30 30 31 31 30 20 31 0D	Brightness Mode	Bright
--XX110 0	7E 30 30 31 31 30 20 30 0D		STD (0/2 for backward compatible)
--XX111 1	7E 30 30 31 31 31 20 31 0D	Lamp Reset	Yes
--XX111 0	7E 30 30 31 31 31 20 30 0D		No (0/2 for backward compatible)
--XX112 1	7E 30 30 31 31 32 20 31 0D	Reset	Yes
--XX99 1	7E 30 30 39 39 20 31 0D	RS232 Alert Reset	Reset System Alert

SEND to emulate Remote

--XX140 1	7E 30 30 31 34 30 20 31 0D	Power	
--XX140 10	7E 30 30 31 34 30 20 31 30 0D	Up/Page +	
--XX140 11	7E 30 30 31 34 30 20 31 31 0D	Left/Source	
--XX140 12	7E 30 30 31 34 30 20 31 32 0D	Enter (for projector MENU)	
--XX140 13	7E 30 30 31 34 30 20 31 33 0D	Right/Re-SYNC	
--XX140 14	7E 30 30 31 34 30 20 31 34 0D	Down/Page -	
--XX140 15	7E 30 30 31 34 30 20 31 35 0D	Keystone +	
--XX140 16	7E 30 30 31 34 30 20 31 36 0D	Keystone -	
--XX140 17	7E 30 30 31 34 30 20 31 37 0D	Volume -	
--XX140 18	7E 30 30 31 34 30 20 31 38 0D	Volume +	
--XX140 19	7E 30 30 31 34 30 20 31 39 0D	Brightness (1)	
--XX140 20	7E 30 30 31 34 30 20 32 30 0D	Menu (2)	
--XX140 21	7E 30 30 31 34 30 20 32 31 0D	Zoom (3)	
--XX140 22	7E 30 30 31 34 30 20 32 32 0D	Contrast (4)	
--XX140 23	7E 30 30 31 34 30 20 32 33 0D	Freeze (5)	
--XX140 24	7E 30 30 31 34 30 20 32 34 0D	AV Mute (6)	
--XX140 25	7E 30 30 31 34 30 20 32 35 0D	S-Video (7)	
--XX140 26	7E 30 30 31 34 30 20 32 36 0D	VGA1/2 toggle (8)	
--XX140 27	7E 30 30 31 34 30 20 32 37 0D	Video (9)	

SEND from projector automatically

232 ASCII Code	HEX Code	Function	Projector Return	Description
		when Standby/Warming/Cooling/Out of Range/Lamp fail/ Fan Lock/Over Temperature/Lamp Hours Running Out	INFOn	n : 0/1/2/3/4/6/7/8 = Standby/Warming/Cooling/ Out of Range/Lamp fail/Fan Lock/Over Temperature/ Lamp Hours Running Out

READ from projector

232 ASCII Code	HEX Code	Function	Projector Return	Description
--XX121 1	7E 30 30 31 32 31 20 31 0D	Input Source Commands	OKn	n : 0/1/2/3
--XX122 1	7E 30 30 31 32 32 20 31 0D	Software Version	OKddd	ddd: FW version
--XX123 1	7E 30 30 31 32 33 20 31 0D	Display Mode	OKn	n : 0/1/2/3/4/5/6/7/8 = None/Presentation/Bright/Movie/ sRGB/User1/User2/Blackboard/Classroom
--XX124 1	7E 30 30 31 32 34 20 31 0D	Power State	OKn	n : 0/1 = Off/On
--XX125 1	7E 30 30 31 32 35 20 31 0D	Brightness	OKn	
--XX126 1	7E 30 30 31 32 36 20 31 0D	Contrast	OKn	
--XX127 1	7E 30 30 31 32 37 20 31 0D	Aspect Ratio	OKn	n : 0/1/2/3/4 = 4:3/16:9-1/16:9-l(LBX)/Native/AUTO
--XX128 1	7E 30 30 31 32 38 20 31 0D	Color Temperature	OKn	n : 0/1/2 = Warm/Medium/Cold
--XX129 1	7E 30 30 31 32 39 20 31 0D	Projection Mode	OKn	n : 0/1/2/3 = Front-Desktop/ Rear-Desktop / Front-Ceiling / Rear-Ceiling
--XX150 1	7E 30 30 31 35 30 20 31 0D	Information	OKabbbbcdddde	a : 0/1 = Off/On bbbbb: LampHour cc: source 00/01/02/03/04= None/VGA1/VGA2/ S-Video/Video ddd: FW version e : Display mode 0/1/2/3/4/5/6/7/8 None/Presentation/Bright/Movie/sRGB /User1/User2/Blackboard/Classroom
--XX151 1	7E 30 30 31 35 31 20 31 0D	Model name	OKn	n:1/2=SVGA/XGA
--XX108 1	7E 30 30 31 30 38 20 31 0D	Lamp Hours	OKbbbb	bbbb: LampHour
--XX108 2	7E 30 30 31 30 38 20 31 0D	Cumulative Lamp Hours	OKbbbbbb	bbbbbb: (5 digits) Total Lamp Hours

Ceiling Mount Installation

1. To prevent damage to your projector, please use the Optoma ceiling mount.
2. If you wish to use a third party ceiling mount kit, please ensure the screws used to attach a mount to the projector meet the following specifications:
 - ▶ Screw type: M3*3
 - ▶ Maximum screw length: 10mm
 - ▶ Minimum screw length: 7.5mm



❖ Please note that damage resulting from incorrect installation will invalidate the warranty.



⚠ Warning:

1. If you buy a ceiling mount from another company, please be sure to use the correct screw size. Screw size will vary depending on the thickness of the mounting plate.
2. Be sure to keep at least 10 cm gap between the ceiling and the bottom of the projector.
3. Avoid installing the projector near a heat source.

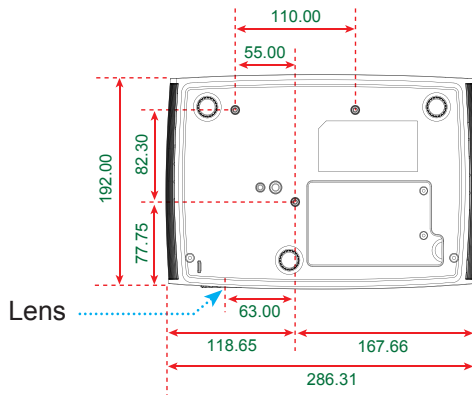
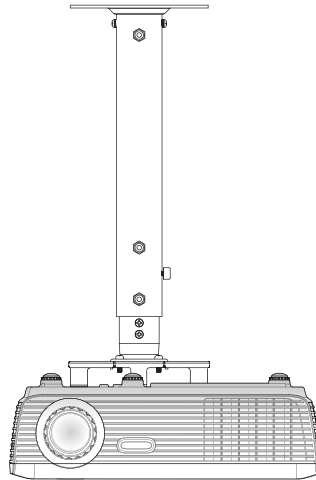

Optoma Global Offices

For service or support please contact your local office.

USA

715 Sycamore Drive
Milpitas, CA 95035, USA
www.optomausa.com

Tel : 408-383-3700
Fax: 408-383-3702
Service : services@optoma.com

Canada

5630 Kennedy Road, Mississauga,
ON, L4Z 2A9, Canada
www.optoma.ca

Tel : 905-361-2582
Fax: 905-361-2581
Service : canadacsragent@optoma.com

Europe

42 Caxton Way, The Watford Business Park
Watford, Hertfordshire,
WD18 8QZ, UK
www.optoma.eu
Service Tel : +44 (0)1923 691865

Tel : +44 (0) 1923 691 800
Fax: +44 (0) 1923 691 888
Service : service@tsc-europe.com

France

Bâtiment E
81-83 avenue Edouard Vaillant
92100 Boulogne Billancourt, France

Tel : +33 1 41 46 12 20
Fax: +33 1 41 46 94 35
Service : savoptoma@optoma.fr

Spain

C/ José Hierro,36 Of. 1C
28529 Rivas VaciaMadrid,
Spain

Tel : +34 91 499 06 06
Fax: +34 91 670 08 32

Deutschland

Wertfstrasse 25
D40549 Düsseldorf,
Germany

Tel : +49 (0) 211 506 6670
Fax: +49 (0) 211 506 66799
Service : info@optoma.de

Scandinavia

Grev Wedels Plass 2
3015 Drammen
Norway

Tel : +47 32 26 89 90
Fax: +47 32 83 78 98
Service : info@optoma.no

Latin America

715 Sycamore Drive
Milpitas, CA 95035, USA
www.optoma.com.br

Tel : 408-383-3700
Fax: 408-383-3702
www.optoma.com.mx

Korea

WOOMI TECH.CO.,LTD.

4F,Minu Bldg,33-14, Kangnam-Ku,
seoul,135-815, KOREA

Tel : +82+2+34430004

Fax: +82+2+34430005

Japan

東京都足立区綾瀬3-25-18

株式会社オーエスエム

サポートセンター:0120-46-5040

E-mail : info@osscreen.com

www.os-worldwide.com

Taiwan

5F., No. 108, Minchiuan Rd.

Shindian City,

Taipei Taiwan 231, R.O.C.

www.optoma.com.tw

Tel : +886-2-2218-2360

Fax: +886-2-2218-2313

Service : services@optoma.com.tw

asia.optoma.com

Hong Kong

Unit A, 27/F Dragon Centre,

79 Wing Hong Street,

Cheung Sha Wan,

Kowloon, Hong Kong

Tel : +852-2396-8968

Fax: +852-2370-1222

www.optoma.com.hk

China

5F, No. 1205, Kaixuan Rd.,

Changning District

Shanghai, 200052, China

Tel : +86-21-62947376

Fax: +86-21-62947375

www.optoma.com.cn

Regulation & Safety notices

This appendix lists the general notices of your projector.

FCC notice

This device has been tested and found to comply with the limits for a Class B digital device pursuant to Part 15 of the FCC rules. These limits are designed to provide reasonable protection against harmful interference in a residential installation. This device generates, uses and can radiate radio frequency energy and, if not installed and used in accordance with the instructions, may cause harmful interference to radio communications.

However, there is no guarantee that interference will not occur in a particular installation. If this device does cause harmful interference to radio or television reception, which can be determined by turning the device off and on, the user is encouraged to try to correct the interference by one or more of the following measures:

- Reorient or relocate the receiving antenna.
- Increase the separation between the device and receiver.
- Connect the device into an outlet on a circuit different from that to which the receiver is connected.
- Consult the dealer or an experienced radio/television technician for help.

Notice: Shielded cables

All connections to other computing devices must be made using shielded cables to maintain compliance with FCC regulations.

Caution

Changes or modifications not expressly approved by the manufacturer could void the user's authority, which is granted by the Federal Communications Commission, to operate this projector.

Operation conditions

This device complies with Part 15 of the FCC Rules. Operation is subject to the following two conditions:

1. This device may not cause harmful interference and
2. This device must accept any interference received, including interference that may cause undesired operation.

Notice: Canadian users

This Class B digital apparatus complies with Canadian ICES-003.

Remarque à l'intention des utilisateurs canadiens

Cet appareil numérique de la classe B est conforme à la norme NMB-003 du Canada.

Declaration of Conformity for EU countries

- EMC Directive 2004/108/EC (including amendments)
- Low Voltage Directive 2006/95/EC
- R & TTE Directive 1999/5/EC (if product has RF function)

Disposal instructions



Do not throw this electronic device into the trash when discarding. To minimize pollution and ensure utmost protection of the global environment, please recycle it.