

EPSON
EXCEED YOUR VISION

User's Guide

Multimedia Projector

EB-Z8050W

EB-Z8000WU



ProSelecta

View :: Compare :: Select - www.ProSelecta.com





Notations Used in This Guide

- **Safety indications**

The documentation and the projector use graphical symbols to show how to use the projector safely. Please understand and respect these caution symbols in order to avoid injury to persons or property.

 Warning	This symbol indicates information that, if ignored, could possibly result in personal injury or even death due to incorrect handling.
 Caution	This symbol indicates information that, if ignored, could possibly result in personal injury or physical damage due to incorrect handling.

- **General information indications**

Attention	Indicates procedures which may result in damage or injury if sufficient care is not taken.
	Indicates additional information and points which may be useful to know regarding a topic.
	Indicates a page where detailed information regarding a topic can be found.
	Indicates that an explanation of the underlined word or words in front of this symbol appears in the glossary of terms. See the "Glossary" section of the "Appendix".  p.125
<div style="border: 1px solid black; padding: 2px; display: inline-block;">Procedure</div>	Indicates operating methods and the order of operations. The procedure indicated should be carried out in the order of the numbered steps.
[(Name)]	Indicates the name of the buttons on the Remote Control or the Control panel. Example: [ESC] button
"(Menu Name)" Brightness (Boldface)	Indicates the configuration menu items. Example: Select "Brightness" from the Image menu. Image menu - Brightness



Notations Used in This Guide..... 2

Introduction

Projector Features..... 7

- Ease of use when installed on a ceiling mount. 7
- Reliability you can depend on. 8
- Large Projection Area and Precise Colors. 8
- Enhanced security functions. 8
- Easy to handle. 8
- Using the projector over a network (EB-Z8050W only). 8

Part Names and Functions..... 10

- Front/Top. 10
- Interface. 11
- Rear. 12
- Remote Control. 13

Useful Functions

Correcting Distortion in the Projected Image..... 17

- Correcting Distortion with Quick Corner. 18

Changing the Projected Image..... 21

- Automatically Detect Input Signal and Change the Projected Image (Source Search)
..... 21
- Switch to the target image by Remote Control. 22

Functions for Enhancing Projection..... 23

- Selecting the Projection Quality (Selecting Color Mode). 23
- Setting the Auto Iris. 24
- Hiding the Image Temporarily (Shutter). 24
- Freezing the Image (Freeze). 24
- Changing the Aspect Ratio. 25
 - Changing methods. 25
 - Changing the Aspect for video equipment images. 25

- Changing the Aspect for computer images. 27
- Pointer Function (Pointer). 30
- Enlarging Part of the Image (E-Zoom). 31

Limitation of the Number of the Target Projectors when Using Multiple Projectors..... 32

- Setting the Projector ID. 33
- Checking the Projector ID. 33
- Setting the Remote Control ID. 34

Correcting Color for Multiple Projectors (Multi-Screen Color Adjustment)..... 35

- Summary of Correction Procedure. 35
- Correction Method. 35

Security Functions..... 37

- Managing Users (Password Protect). 37
 - Type of Password Protect. 37
 - Setting Password Protect. 37
 - Entering the Password. 38
- Restricting Button Operation. 39
 - Setting Control Panel Lock. 39
 - Lens Operation Lock. 40
- Anti-Theft Lock. 41
 - Installing the wire lock. 41

Configuration Menu

Using the Configuration Menu..... 43

List of Functions..... 44

- Image Menu. 44
- Signal Menu. 46
- Settings Menu. 48
- Extended Menu. 49
- Network Menu (EB-Z8000WU only). 51
- Network Menu (EB-Z8050W only). 54
 - Notes on operating the network menu. 55

- Soft keyboard operations. 55
- Basic Menu. 56
- Wireless LAN Menu (only when the optional wireless LAN unit is installed). 57
- Security menu (Only available when the optional wireless LAN unit is installed)
. 59
- Wired LAN Menu. 63
- Mail Menu. 64
- Others Menu. 65
- Reset Menu. 66
- Info Menu (Display Only). 67
- Reset Menu. 68

Troubleshooting

- Using the Help. 70**
- Problem Solving. 71**
 - Reading the Indicators. 71
 - ⏻ Indicator is lit or flashing red. 72
 - ☀️ 📶 📷 Indicator is flashing or lit. 73
 - When the Indicators Provide No Help. 75
 - Problems relating to images. 76
 - Problems when projection starts. 80
 - Other problems. 81

Appendix

- Installation Methods. 84**
- Cleaning. 85**
 - Cleaning the Projector's Surface. 85
 - Cleaning the Lens. 85
 - Cleaning the Air filter. 85
- Replacing Consumables. 88**
 - Replacing the Remote Control Batteries. 88

- Replacing the Lamp. 89
 - Lamp replacement period. 89
 - How to replace the lamp. 89
 - Resetting the Lamp Hours. 91
- Replacing the Air Filter. 92
 - Air filter replacement period. 92
 - How to replace the air filter. 92

Optional Accessories and Consumables. 94

- Optional accessories. 94
- Consumables. 95

Notes on Transportation. 96

- Moving Nearby. 96
- When Transporting. 96
 - Preparing packaging. 96
 - Notes when packing and transporting. 96

Saving a User's Logo. 97

Making a WPS (Wi-Fi Protected Setup) Connection with a Wireless LAN Access Point (EB-Z8050W only). 99

- Connection Setup Method. 99
 - Making a Connection Using the Push Button Method. 99
 - Making a connection using the PIN Code Method. 101

Screen Size and Projection Distance. 103

- Projection Distance of EB-Z8000WU. 103
- Projection Distance of EB-Z8050W. 104

Connecting a LAN Cable. 105

Connecting to an external monitor. 106

Removing and Attaching the Projector Lens Unit. 107

- Removing. 107
- Attaching. 108

- Reading Problem Mail Notification Function. 110**
- ESC/VP21 Commands. 111**
 - Command List. 111
 - Cable Layouts. 111
 - Serial Connection. 111
 - Communications protocol. 112
- About PJLink. 113**
- Supported Monitor Displays. 114**
 - Supported Monitor Displays for EB-Z8000WU. 114
 - Computer signals (analog RGB). 114
 - Component Video. 115
 - Composite Video/S-Video. 115
 - Input signal from the HDMI/DVI-D input port. 116
 - Supported Monitor Displays for EB-Z8050W. 117
 - Computer signals (analog RGB). 117
 - Component Video. 118
 - Composite Video/S-Video. 118
 - Input signal from the HDMI/DVI-D input port. 119
- Specifications. 120**
 - Projector General Specifications. 120
 - Connectors. 121
 - Operating Conditions for the Software. 122
- Appearance. 124**
- Glossary. 125**
- General Notes. 127**
 - Wireless Telegraphy Act Regulations. 127
 - General Notice. 127
- Index. 128**



Introduction

This chapter explains the projector's features and the part names.

Ease of use when installed on a ceiling mount

Centered lens

The lens is positioned in the center of the projector so it is well balanced and is easy to mount on a ceiling. This also makes it easy to line up the screen and the projector.

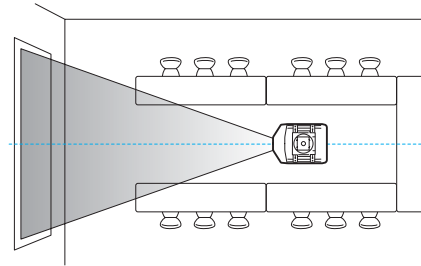

Equipped with electric lens shift, zoom and focus functions

Using the lens shift function that allows you to adjust the position of the projected image along the horizontal and vertical axis opens up a wide variety of installation locations.

The lens shift, zoom, and focus functions can be operated with a remote control so operation is easy even if the projector is mounted on the ceiling.

Six optional lenses are provided

You can select the best lens according to the projection distance and purpose. All the optional lenses are bayonet-type which allows you to simply and easily replace and install the optional lenses.

 [p.94](#), [p.107](#)

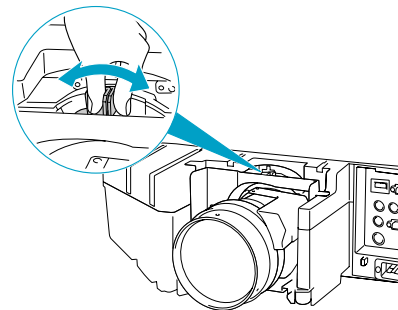

Horizontal and vertical installation possible

The projector can be pointed either up or down to project images on the ceiling or floor. This makes it an effective communication tool that lets you express your ideas with great impact.  [p.84](#)

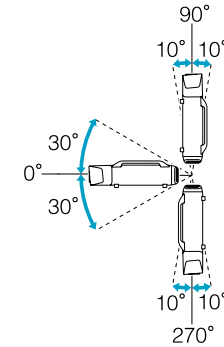

A design that harmonizes with the surrounding environment, and makes the installation easy

The projector's sophisticated design has a cable cover in which cables are hidden for a clean exterior appearance.

The bar type handles are designed to make moving and installing the projector easy so it can be handled safely. The ceiling mount is attached to these handles to mount the projector on the ceiling. The projector does not need to be turned upside down so installation is easy. The initial settings can be easily set as you look at the screen because the control panel is arranged on the back of the projector.

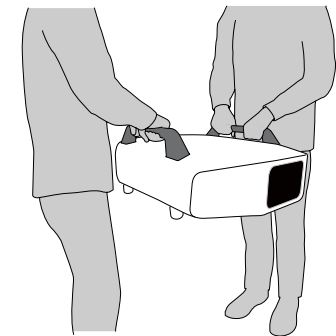

Easy maintenance

You can replace the lamp by opening a cover and pulling it straight out of the back of the projector without using a screwdriver.

There is only one air filter so cleaning and replacement are easy. The lamp and air filter can be safely replaced even when mounted on the ceiling because their covers do not fall off even if you release them.

Reliability you can depend on

The projector is equipped with two lamps. Even if one of the lamps breaks, you can continue projecting with the other lamp and avoid disrupting important presentations.

Large Projection Area and Precise Colors

Equipped with a high-resolution WUXGA panel (EB-Z8000WU only)

You can project a dramatic amount of information on the screen. Viewers can see the information at a glance without having to scroll or switch screens.

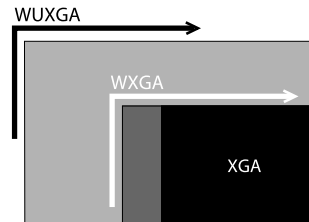

Epson Cinema Filter supports the color gamut for digital cinema.

Select Theatre or sRGB in Color Mode to use Epson Cinema Filter for 100% reproduction of the color gamut used for digital cinema. As a result, this reproduces colors that are full and deep.

Precise color adjustments

As well as Color Mode, you can also adjust the image's absolute color temperature and the strength of each RGB color. Also, because you can adjust the hue, saturation, and brightness of each RGB/CMY, the image can be projected with depth and a color matching in superior detail.

Enhanced security functions

Password Protect to restrict and manage users

By setting a Password you can restrict who can use the projector.  [p.37](#)

Control Panel Lock restricts button operation on the Control panel.

You can use this to prevent people from changing projector settings without permission at events, in schools, and so on.  [p.39](#)

Equipped with various anti-theft devices

The projector is equipped with the following types of anti-theft security devices.

 [p.41](#)

- Security slot
- Security cable installation point

Easy to handle

Direct power On/Off

In places where power is managed centrally, such as in a conference room, the projector can be set to power on and off automatically when the power source to which the projector is connected is switched on or off.

No cool down delay

After turning the projector's power off, you can disconnect the projector's power cable without having to wait for the projector to cool down.

Using the projector over a network (EB-Z8050W only)

You can make effective use of your network by using the supplied "EPSON Projector Software for Meeting & Monitoring" to perform

efficient and varied presentations and meetings.  [Projector Operation Guide](#)

Connect to the projector from computers via a network

You can use your existing network to share the projector from multiple computers. Documents can be projected from each computer without having to change any cables during meetings or presentations. Also, you don't have to worry about the distance between the computer and the projector.



Connecting wirelessly to a computer





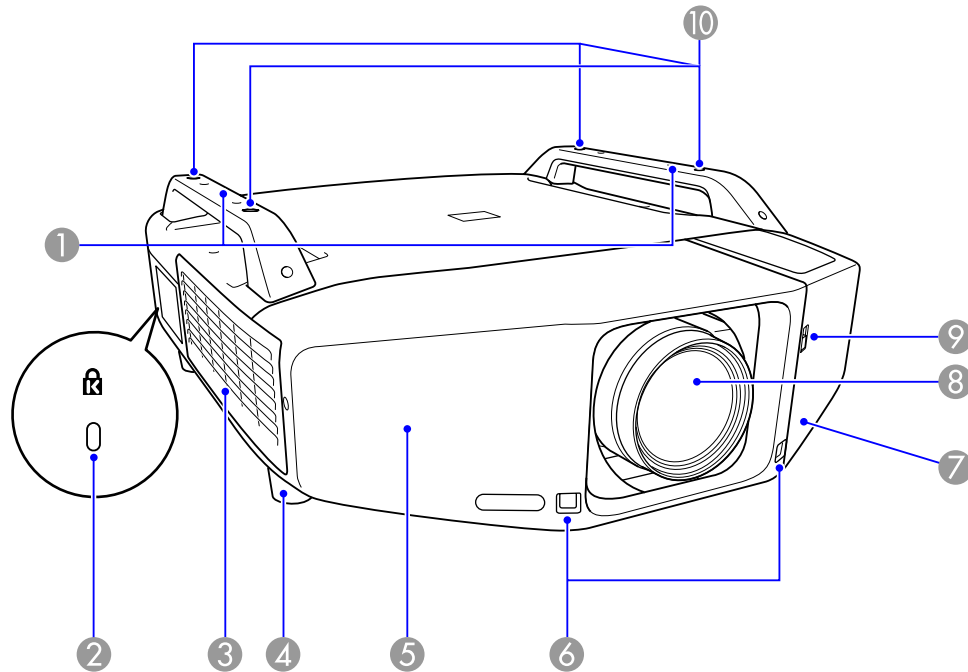



When you install the optional wireless LAN unit in the projector, you can connect wirelessly to a computer.

Front/Top

The illustration shows the projector with a standard zoom lens installed.



Name	Function
1 Handle	Use these handles when carrying the projector. Also, you can pass an anti-theft wire lock through the handles to secure the projector.  p.41
<div style="border: 1px solid black; padding: 5px; background-color: #e0f2f1;">  Caution Do not carry the projector by one person. Two people are needed to unpack or carry the projector. </div>	

Name	Function
2 Security slot()	The Security slot is compatible with the Microsaver Security System manufactured by Kensington.  p.41
3 Air intake vent (Air filter)	Takes in air to cool the projector internally. If dust collects here it can cause the internal temperature to rise, and this can lead to problems with operation and shorten the optical engine's service life. Be sure to clean the Air filter regularly.  p.85, p.92
4 Front adjustable foot	When set up on a desk, turn to extend and retract to adjust the horizontal tilt. The front adjustable feet can be removed when the projector is installed on a ceiling.  Quick Start Guide
5 Front cover	Remove this cover to remove or install the lens unit when replacing the lens.  p.107 This cover must be installed when using the projector.
6 Remote Receiver	Receives signals from the remote control.  Quick Start Guide
7 Interface cover	Remove this cover to connect cables to the ports inside when connecting the projector to video equipment.  Quick Start Guide , p.11
8 Projection lens	Images are projected through here.
9 Interface cover open/close switch	Opens and closes the interface cover.  Quick Start Guide
10 Ceiling mount fixing points (Four points)	Attach the optional Ceiling mount here when suspending the projector from a ceiling.  p.84, p.94

Interface

The following ports can be accessed by removing the interface cover. For information on how to remove the interface cover and connect video equipment, see *Quick Start Guide*.

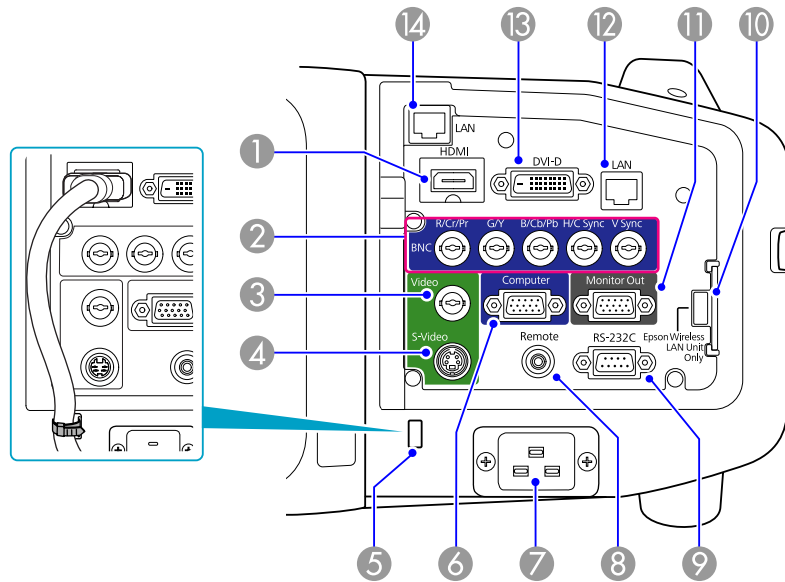







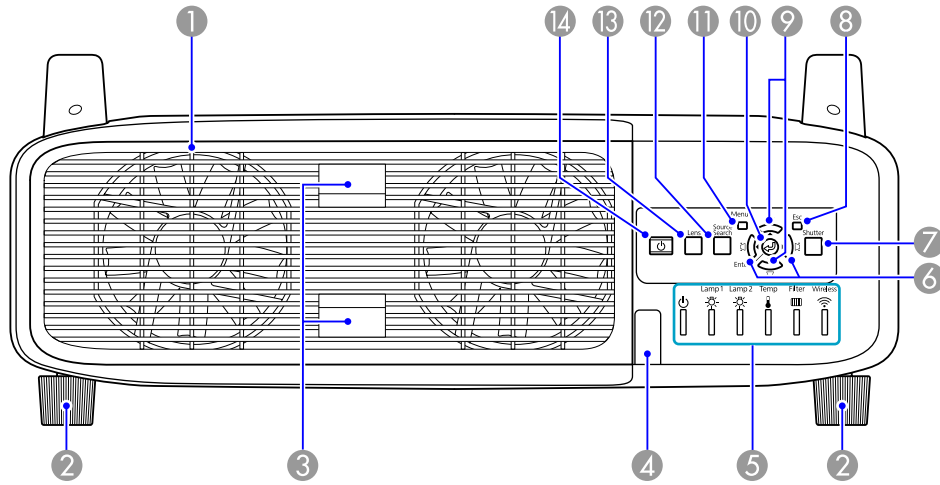





Name	Function
1 HDMI input port	Inputs video signals from HDMI compatible video equipment and computers. This projector is compatible with HDCP signals. See <i>Quick Start Guide</i> .
2 BNC input port	For analog RGB signals from a computer and component video signals from other video sources. See <i>Quick Start Guide</i> .
3 Video input port	For composite video signals from video sources. See <i>Quick Start Guide</i> .
4 S-Video input port	For S-video signals from video sources. See <i>Quick Start Guide</i> .

Name	Function
5 Cable holder	Connection may become defective when a thick heavy HDMI cable is connected to the HDMI input port. Run a commercially available cable tie through this holder to prevent the cable from disconnecting.
6 Computer input port	For analog RGB signals from a computer and component video signals from other video sources. See <i>Quick Start Guide</i> .
7 Power inlet	Connects to the power cable. See <i>Quick Start Guide</i> .
8 Remote port	Connects the optional remote control cable set and inputs signals from the remote control. When the remote control cable is plugged into this port, the remote receiver on the projector is disabled.
9 RS-232C port	When controlling the projector from a computer, connect it to the computer with an RS-232C cable. This port is for control use and should not normally be used. See p.111 .
10 Wireless LAN Unit port (EB-Z8050W only)	Connects to the optional wireless LAN unit.
11 Monitor Out port	Outputs to an external monitor the analog signal from the computer connected to the Computer input port or the BNC input port. This is not available for component video signals or other signals being input to any port other than the Computer input port or the BNC input port. See p.106 .
12 LAN port (EB-Z8000WU only)	Connects to a LAN cable and then to a network. See p.105 .
13 DVI-D input port	Inputs digital RGB signals from a computer connected to the DVI-D output port. This projector is compatible with HDCP signals. See <i>Quick Start Guide</i> .
14 LAN Port (EB-Z8050W only)	Connects to a LAN cable and then to a network. See p.105 .

Rear



Name	Function
1 Air exhaust vent (Lamp cover)	Exhaust vent for air used to cool the projector internally. Also, open this cover to replace the projector's lamps. <div style="border: 1px solid black; padding: 5px; margin-top: 10px;">  Caution Do not place objects that may become warped or otherwise affected by heat near the Air exhaust vent and do not put your face or hands near the vent while projection is in progress. </div>
2 Rear foot	When set up on a desk, turn to extend and retract to adjust the horizontal tilt. The rear adjustable feet can be removed when the projector is installed on a ceiling.  Quick Start Guide
3 Lamp cover open tab	Use these tabs to open the lamp cover.  p.89
4 Remote Receiver	Receives signals from the remote control.  Quick Start Guide

Name	Function
5 Status indicators	The color of the indicators and whether they are flashing or lit indicate the status of the projector. The left illustration indicates EB-Z8050W. EB-Z8000WU has no Wireless indicator.  p.71
6 [Left Arrow]/[Right Arrow] button	Corrects horizontal Keystone distortion. If pressed while the configuration menu or a Help screen is displayed, these buttons only have the [Left Arrow] and [Right Arrow] functions which select menu items and setting values.  Quick Start Guide , p.43
7 [Shutter] button	Press this button to open or close the electric shutter. You can close the electric shutter to completely block a projection.  Quick Start Guide , p.24
8 [Esc] button	Stops the current function. If pressed when the configuration menu is displayed, it moves to the previous menu level.  p.43
9 [Up Arrow]/[Down Arrow] button	Corrects vertical Keystone distortion. If pressed while the configuration menu or a Help screen is displayed, these buttons only have the [Up Arrow] and [Down Arrow] functions which select menu items and setting values.  Quick Start Guide , p.43
10 [Enter] button	If pressed during projection of computer analog RGB signals, it automatically adjusts the Tracking, Sync., and Position to project the optimum image. When the configuration menu or a Help screen is displayed, it accepts and enters the current selection and moves to the next level.  p.43
11 [Menu] button	Displays and closes the configuration menu.  p.43
12 [Source Search] button	Changes to the next input source that is connected to the projector and is sending an image.  p.21
13 [Lens] button	Press this button to cycle through the focus, zoom, and lens shift settings to adjust the lens.  Quick Start Guide



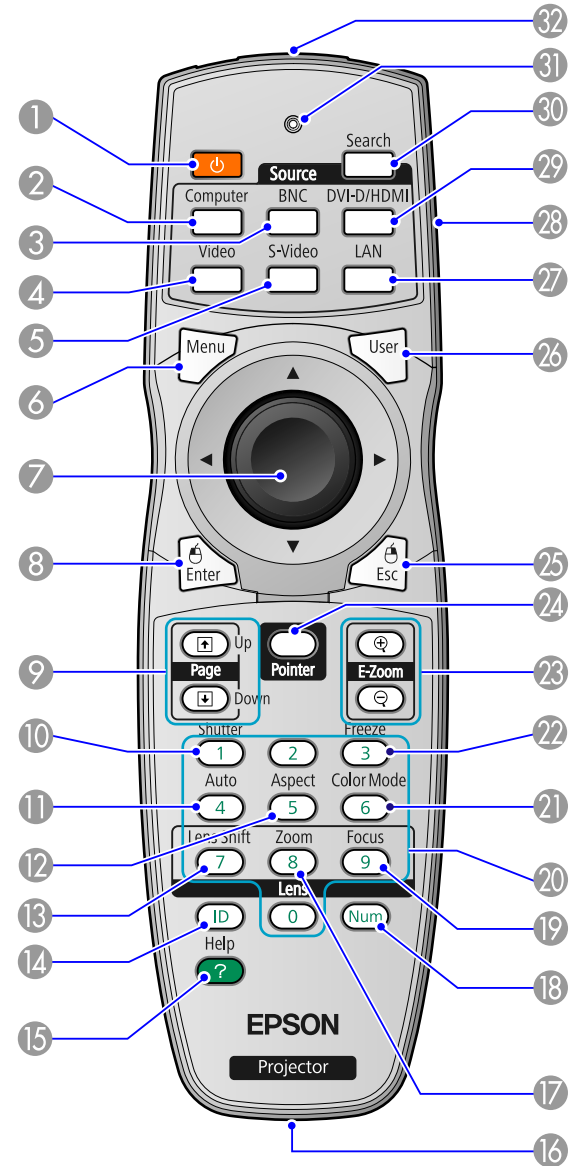

Name	Function
14 [Power] button	Turns the projector power On or Off.  <i>Quick Start Guide</i>

Remote Control



	Name	Function
①	[] button	Turns the projector power On or Off. <i>Quick Start Guide</i>
②	[Computer] button	Changes to images from the Computer input port. p.22
③	[BNC] button	Changes to images from the BNC input port. p.22
④	[Video] button	Changes to images from the Video input port. p.22
⑤	[S-Video] button	Changes to images from the S-Video input port. p.22
⑥	[Menu] button	Displays and closes the configuration menu. p.43
⑦	[] button	When the configuration menu or Help screen is displayed, it selects menu items and setting values. p.43, p.70 When using the optional wireless mouse receiver, tilting this button moves the pointer in the direction (eight possible directions) tilted.
⑧	[Enter] button	When the configuration menu or a Help screen is displayed, it accepts and enters the current selection and moves to the next level. p.43, p.70 Acts as a mouse's left button when using the optional wireless mouse receiver.
⑨	[Page] buttons [][]	When using the optional wireless mouse receiver, you can change the PowerPoint file page during projection by pressing the page up/page down buttons.
⑩	[Shutter] button	Each time you press this button, the electric shutter closes or opens. You can close the electric shutter to completely block a projection. <i>Quick Start Guide</i> , p.24
⑪	[Auto] button	If pressed during projection of computer analog RGB signals, it automatically adjusts the Tracking, Sync., and Position to project the optimum image.
⑫	[Aspect] button	The <u>Aspect Ratio</u> changes each time the button is pressed. p.25

	Name	Function
⑬	[Lens Shift] button	Press to adjust the lens shift. <i>Quick Start Guide</i>
⑭	[ID] button	Press to set the remote control ID. p.34
⑮	[Help] button	Displays and closes the Help screen which shows you how to deal with problems if they occur. p.70
⑯	Remote port	Connects the optional remote control cable set and outputs signals from the remote control. When the remote control cable is plugged into this remote port, the remote receiver is disabled.
⑰	[Zoom] button	Press to adjust the zoom. <i>Quick Start Guide</i>
⑱	[Num] button	Use this button to enter passwords, IP Address from the Network, and so on. p.37
⑲	[Focus] button	Press to adjust the focus. <i>Quick Start Guide</i>
⑳	Numeric buttons	Use this button to enter passwords, remote control IP settings, IP Address from the Network, and so on. p.34, p.37
㉑	[Color Mode] button	Each time the button is pressed, the Color Mode changes. p.23
㉒	[Freeze] button	Images are paused or unpaused. p.24
㉓	[E-Zoom] buttons [][]	The [] button enlarges the image without changing the projection size. The [] button reduces the parts of images that have been enlarged using the [] button. p.31
㉔	[Pointer] button	Press to activate the on screen pointer. p.30
㉕	[ESC] button	Stops the current function. If pressed when the configuration menu is displayed, it moves to the previous menu level. p.43, p.70 Acts as a mouse's right button when using the optional wireless mouse receiver.

	Name	Function
26	[User] button	Press to assign a frequently used item from the six available configuration menu items. By pressing the button the assigned menu item selection/adjustment screen is displayed, allowing you to make one-touch settings/adjustments.  p.48 Test Pattern is assigned as the default setting.
27	[LAN] button	Changes to images of EasyMP Network Projection. (EB-Z8050W only)  p.22 This button does not function when using EB-Z8000WU.
28	ID switch	Use this switch to enable (On)/disable (Off) ID settings for the remote control.  p.32
29	[DVI-D/HDMI] button	Each time the button is pressed, the image displayed changes between the DVI-D and HDMI input ports.  p.22
30	[Search] button	Changes to the next input source that is connected to the projector and is sending an image.  p.21
31	Indicators	A light is emitted when outputting remote control signals.
32	Remote control light-emitting area	Outputs remote control signals.



Useful Functions

This chapter explains useful tips for giving presentations, and the Security functions.

There are two methods of correcting distortion in projected images as below.

- Quick Corner

This allows you to manually correct each of the four corners of the projected image separately.  [p.18](#)

We recommend using Quick Corner to accurately adjust keystone distortion.

- H/V-Keystone

This allows you to manually correct distortion in the horizontal and vertical directions independently. You can perform easy H/V-Keystone corrections by using the [∇/\blacktriangle] [$\nabla/\blacktriangledown$] [$\blacktriangleleft/\blacktriangleright$] and [$\blacktriangleright/\blacktriangleright$] buttons on the projector's control panel.  *Quick Start Guide*



Shift the lens to the position shown below when performing horizontal and vertical keystone. When the lens shift is not positioned as below, the distortion is not corrected accurately.

- The horizontal lens shift is set to the center.
- The vertical lens shift is set to the top or bottom.

The correction may not be properly performed according to the zoom adjustment value. And, the projected screen size may become smaller after performing the correction. Be careful about the projection distance when installing the projector.

Quick Corner and horizontal and vertical keystone cannot be performed at the same time. When the **Keystone** correction method is selected from the configuration menu, the correction method you choose is assigned to the [∇/\blacktriangle], [$\nabla/\blacktriangledown$], [$\blacktriangleleft/\blacktriangleright$], and [$\blacktriangleright/\blacktriangleright$] buttons on the control panel. The default setting for **Keystone** is set to **H/V-Keystone**, so when [∇/\blacktriangle], [$\nabla/\blacktriangledown$], [$\blacktriangleleft/\blacktriangleright$], and [$\blacktriangleright/\blacktriangleright$] buttons are pressed, H/V-Keystone correction is carried out.

Because Quick Corner and H/V-Keystone correction can be carried out while projecting a test pattern, you do not need to make preparations by connecting a computer or other equipment.

Correcting Distortion with Quick Corner

Procedure

- 1 Press the [Menu] button, and then from the configuration menu select Settings - Keystone. **"Using the Configuration Menu"**

Using the Remote Control

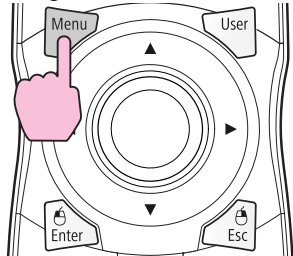

Using the Control panel

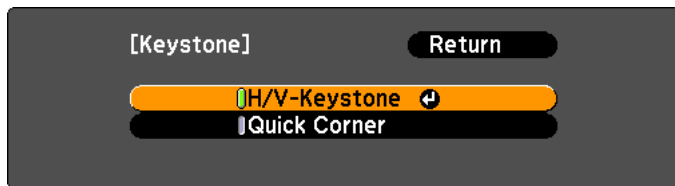
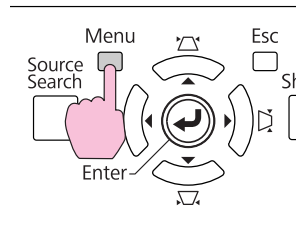

[Esc] :Return [◀/▶] :Select [Enter] :Enter [Menu] :Exit

- 2 Select "Quick Corner", and then press the [Enter] button.

Press the [Enter] button again to display the selection screen from which you can select one of the four corners.

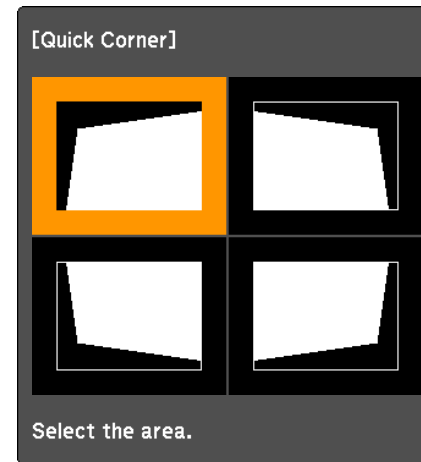

[◀/▶] :Select
[Enter] :Enter
[Esc] :Return (press for 2 seconds to reset/switch)

- 3 Use the [⊙] button on the remote control or the [▲/▼], [◀/▶], and [↶/↷] buttons on the control panel to select the corner you want to adjust, and then press the [Enter] button.

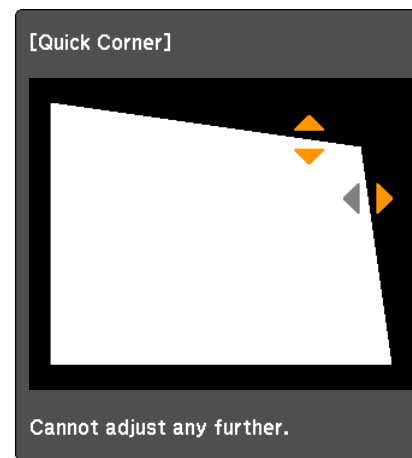
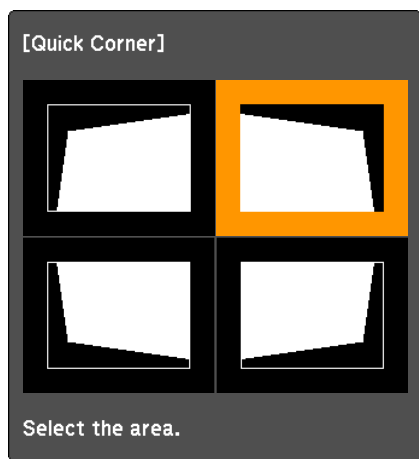

- 4 To adjust the shape, use the [⊙] button on the remote control or the [↖/▲], [↘/▼], [↙/◀], and [↗/▶] buttons on the control panel.

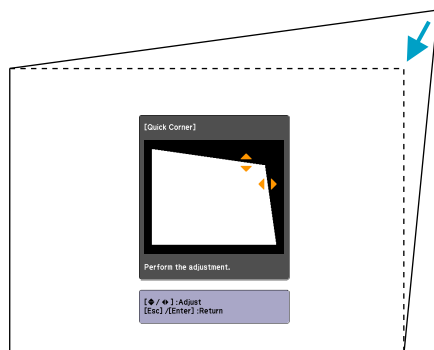

If the triangle in the direction you are adjusting the shape turns gray, as shown in the screenshot below, you cannot adjust the shape any further in that direction.

- 5 Repeat procedures 3 and 4 as needed to adjust any remaining corners.

- 6 When you are done, press the [Esc] button to exit the correction menu.

Because the correction method was changed to **Quick Corner** from **Keystone** in the configuration menu, when [↖/▲], [↘/▼], [↙/◀], and [↗/▶] buttons are pressed later, the screen for selecting the corner in procedure 2 is displayed. Change **Keystone** from the configuration menu to **H/V-Keystone** if you want to correct H/V-Keystone when pressing the [↖/▲], [↘/▼], [↙/◀], and [↗/▶] buttons on the control panel.



If the [Esc] button is held down for about two seconds while correcting with Quick Corner, the following screen is displayed.

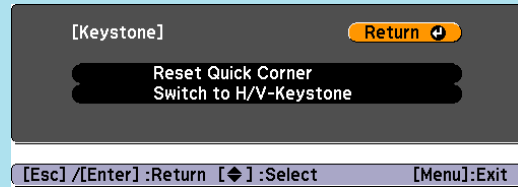

Reset Quick Corner: Resets the result of Quick Corner corrections.

Switch to H/V-Keystone: Switches the correction method to **H/V-Keystone**.  [p.48](#)

You can change the projected image in the following two ways.

- Changing by Source Search
The projector automatically detects signals being input from connected equipment, and the image being input from the equipment is projected.
- Changing directly to the target image
You can use the remote control buttons to change to the target input port.

- ⑥ HDMI
- ⑦ LAN (EB-Z8050W only): The images projected using EasyMP Network Projection from a computer connected to the projector via a network.

Skipped when no image signal is being input.

Procedure

When your video equipment is connected, start playback before beginning this operation.

Using the Remote Control

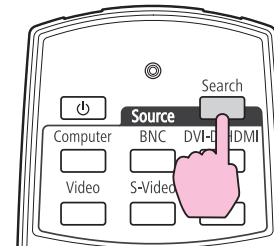

Using the Control panel

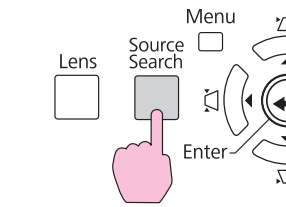

When two or more pieces of equipment are connected, press the [Source Search] button until the target image is projected.

Automatically Detect Input Signal and Change the Projected Image (Source Search)

You can project the target image quickly as input ports with no image signal being input are ignored when you change by pressing the [Source Search] button on the Remote Control or the Control panel.

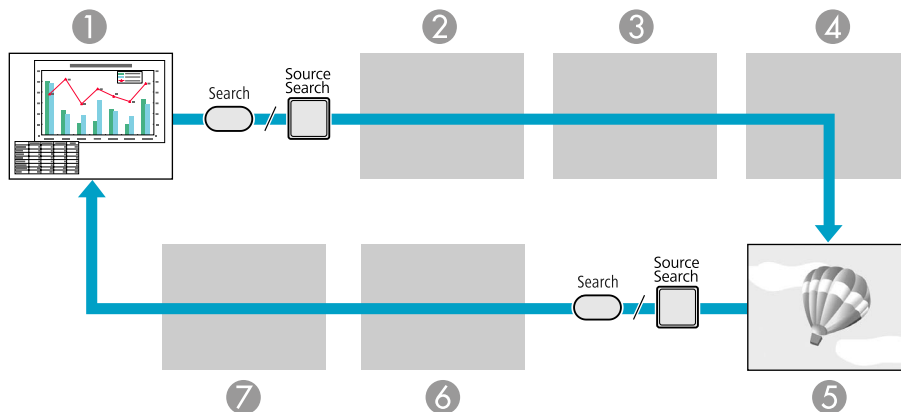

- ① Computer
- ② BNC
- ③ DVI-D
- ④ S-Video
- ⑤ Video



The following screen showing the status of image signals is displayed when only the image that the projector is currently displaying is available, or when no image signal can be found. You can select the input port where the equipment you want to use is connected. If no operation is performed after about 10 seconds, the screen closes.

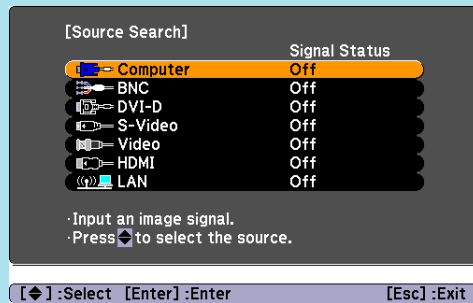

LAN is displayed on the screen only when using EB-Z8050W.

Switch to the target image by Remote Control

You can change directly to the target image by pressing the following buttons on the Remote Control.

Remote Control

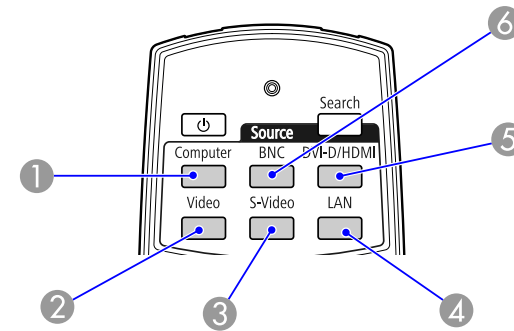

- ① Changes to images from the Computer input port.
- ② Changes to images from the Video input port.
- ③ Changes to images from the S-Video input port.
- ④ Changes to images of EasyMP Network Projection. (EB-Z8050W only)
This button does not function when using EB-Z8000WU.
- ⑤ Each time the button is pressed, the image displayed changes between the DVI-D and HDMI input ports.
- ⑥ Changes to images from the BNC input port.

Selecting the Projection Quality (Selecting Color Mode)

You can easily obtain the optimum image quality simply by selecting the setting that best corresponds to your surroundings when projecting. The brightness of the image varies depending on the mode selected.

Mode	Application
Dynamic	Ideal for use in a bright room. This is the brightest mode.
Presentation	Ideal for making presentations using color materials in a bright room.
Theatre*	Ideal for watching films in a dark room. Gives images a natural tone almost like an original source.
Photo	(When computer images (analog RGB/digital RGB) are input) Ideal for projecting still pictures, such as photos, in a bright room. The images are vivid and brought into contrast.
Sports	(When Component Video, S-Video, or composite video images are input) Ideal for watching TV programmes in a bright room. The images are vivid and brought to life.
sRGB*	Ideal for images that conform to the sRGB color standard.
Customized	Select Customized to adjust R,G,B,C,M,Y from Color Adjustment in the configuration menu.

* The Epson Cinema Filter deploys automatically when Theatre or sRGB is selected.

Procedure

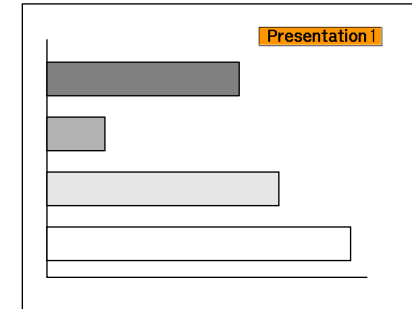
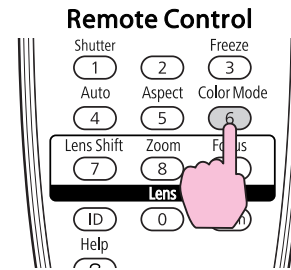

The Color Mode name is displayed on the screen by pressing the button. If you press the button while the Color Mode name is displayed on the screen, it changes to the next Color Mode.



The color mode can also be set using **Color Mode** in the **Image** menu from the configuration menu. [p.44](#)

Setting the Auto Iris

By automatically setting the luminance according to the brightness of the displayed image, it lets you enjoy deep and rich images.

Procedure

- 1 Press the [Menu] button, and select Image - Auto Iris from the configuration menu. 🖱️ "Using the Configuration Menu"

Using the Remote Control

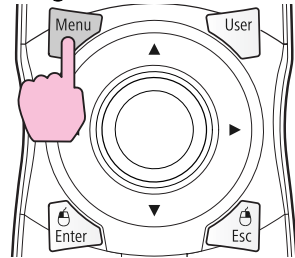

Using the Control panel

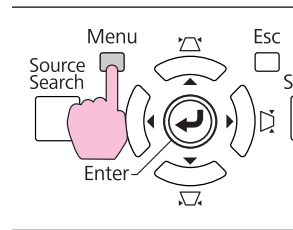

- 2 **Select On.**
The setting is stored for each Color Mode.
- 3 Press the [Menu] button to close the configuration menu.



- Auto Iris can be set only when the Color Mode is Dynamic, Theatre, or Customized.
- When Multi-screen is set to On, Auto Iris does not work.

Hiding the Image Temporarily (Shutter)

You can use this when you want to focus the audience's attention on what you are saying, or if you do not want to show details such as when you are changing between files during presentations from a computer.



Procedure

Using the Remote Control

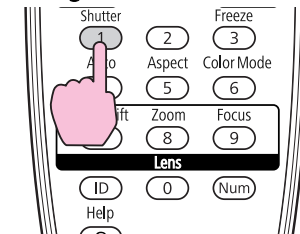

Using the Control panel

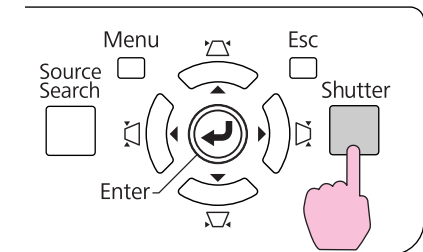

Each time you press the buttons, the electric shutter closes or opens.



- When the shutter is closed and no operations are performed for about 120 minutes, the projector enters Sleep Mode and turns off automatically. If you do not want Sleep Mode to activate, change the **Shutter Timer** setting to Off from Operation in the **Extended** menu. 🖱️ p.49
- If you press [⏻] button while the shutter is closed, the shutter automatically opens and a message requesting confirmation to turn off the power is displayed on the screen.

Freezing the Image (Freeze)

When the moving image on the screen is frozen, the image continues to project, so you can project a moving image one frame at a time like

a still photo. Also, you can perform operations such as changing between files during presentations from a computer without projecting any images if the freeze function is activated beforehand.

Procedure

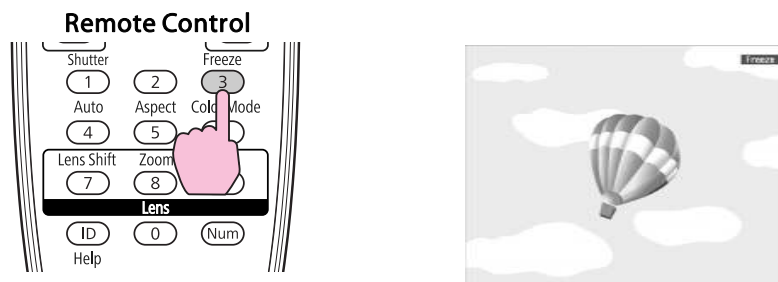

Each time you press the button, Freeze turns on or off.



- The image source continues to play back the moving images even while Freeze is on, and so it is not possible to resume projection from the point where it was paused.
- If the [Freeze] button is pressed while the configuration menu or a Help screen is displayed, the menu or Help screen being displayed is cleared.
- Freeze still works while E-Zoom is being used.

Changing the Aspect Ratio

Change the Aspect Ratio when video equipment is connected so that images that have been recorded in digital video or onto DVDs can be viewed in 16:9 wide-screen format. Change the Aspect Ratio when projecting computer images at full size. The changing methods and the types of Aspect ratio are as follows.

Changing methods

Procedure

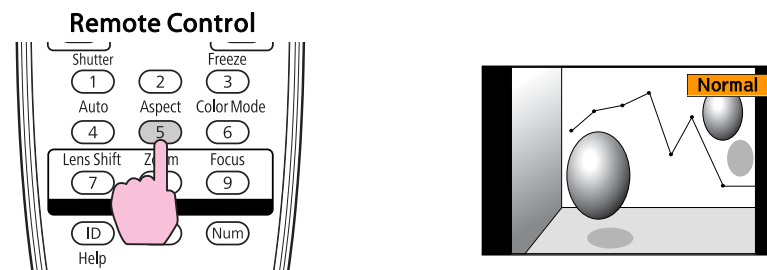

The Aspect name is displayed on the screen by pressing the button.

If you press the button while the Aspect name is displayed on the screen, it changes to the next Aspect Mode.



The aspect mode can also be set using **Aspect** in the **Signal** menu from the configuration menu. [p.46](#)

Changing the Aspect for video equipment images

Each time the button is pressed, the aspect changes in the order Normal, 16:9, Full, Zoom, and Native.

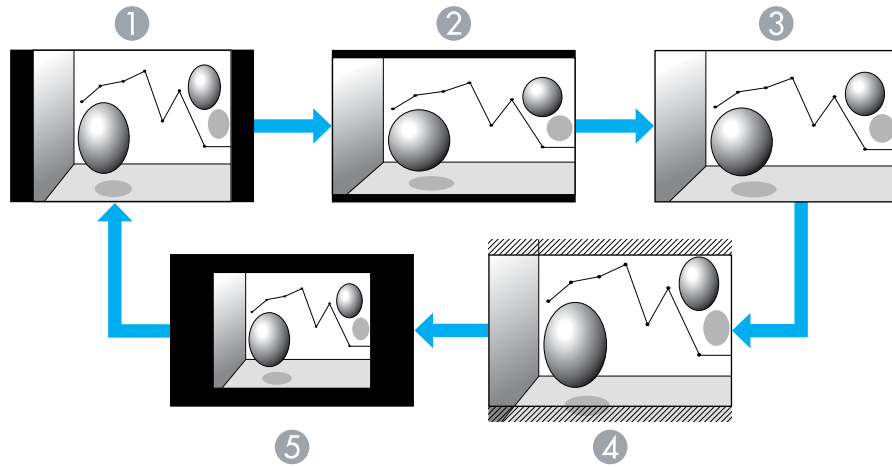

- ① Normal
- ② 16:9
- ③ Full
- ④ Zoom
- ⑤ Native

Changing the Aspect for computer images

You can change the aspect of projected images input from the Computer, BNC, DVI-D, or HDMI input port as follows. The original aspect ratio is 16:10 because of the wide panel mounted on the projector. When projecting onto 16:9 screens, set the Aspect to 16:9.

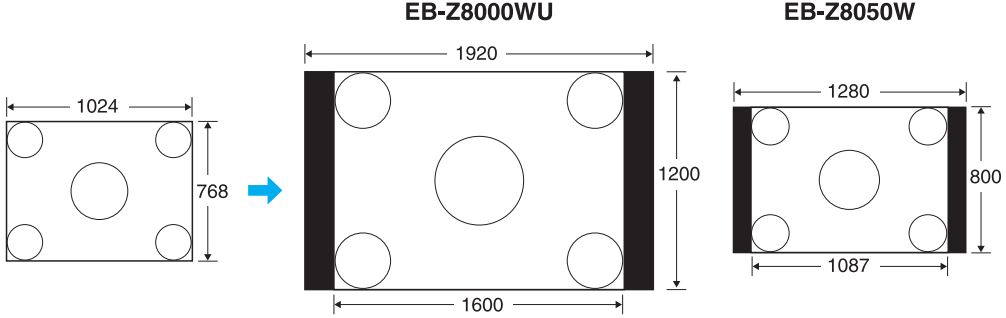
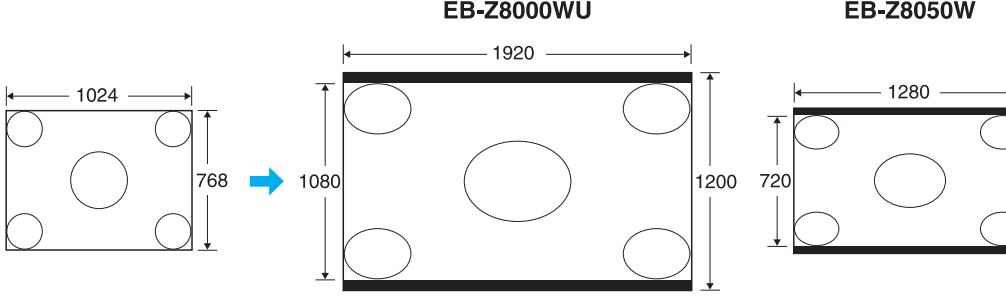
Set Values	Operation	Projection example
Normal (When the input source is a Computer, DVI-D, or BNC)	Projects to the full projection size retaining the Aspect of the input image.	When a 1024x768 signal is input 
Auto (Only available when the input source is HDMI)	Projects in an appropriate aspect based on information from the signal being input.	
16:9	Projects to the full projection size at an Aspect of 16:9.	When a 1024x768 signal is input 

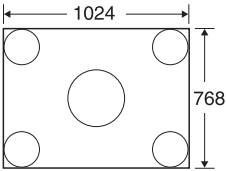
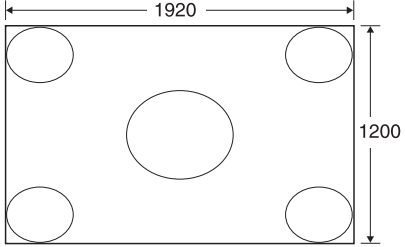
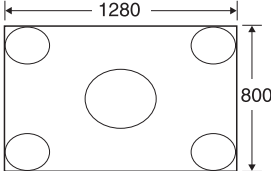
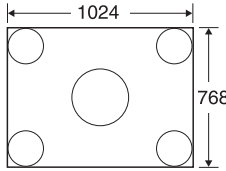
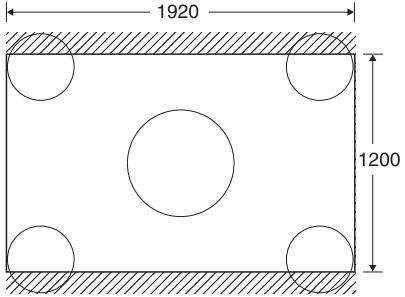
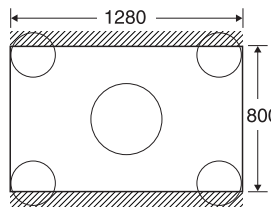
Set Values	Operation	Projection example
Full	Project at full size.	<p>When a 1024x768 signal is input</p> <div style="display: flex; justify-content: space-around; align-items: center;"> <div style="text-align: center;">  <p>1024 768</p> </div> <div style="font-size: 2em; color: blue;">→</div> <div style="display: flex; justify-content: space-around;"> <div style="text-align: center;"> <p>EB-Z8000WU</p>  <p>1920 1200</p> </div> <div style="text-align: center;"> <p>EB-Z8050W</p>  <p>1280 800</p> </div> </div> </div>
Zoom	Projects the input image enlarged to the full lateral direction size as the aspect ratio remains. Parts that extend beyond the projection size are not projected.	<p>When a 1024x768 signal is input</p> <div style="display: flex; justify-content: space-around; align-items: center;"> <div style="text-align: center;">  <p>1024 768</p> </div> <div style="font-size: 2em; color: blue;">→</div> <div style="display: flex; justify-content: space-around;"> <div style="text-align: center;"> <p>EB-Z8000WU</p>  <p>1920 1200</p> </div> <div style="text-align: center;"> <p>EB-Z8050W</p>  <p>1280 800</p> </div> </div> </div>

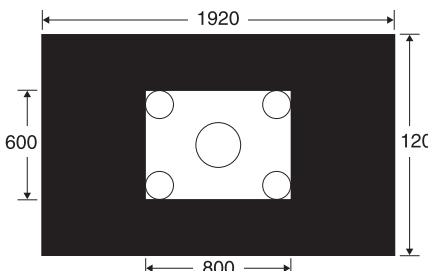
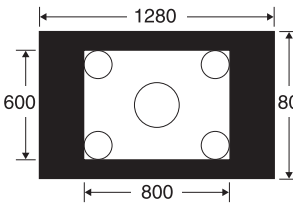
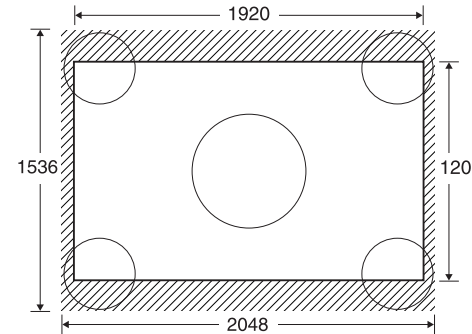
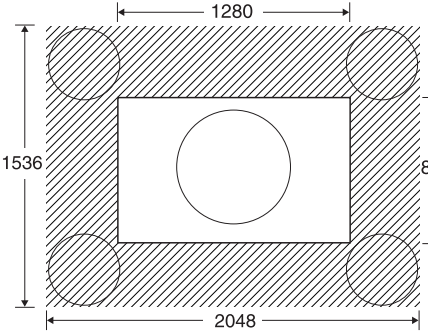
Set Values	Operation	Projection example	
<p>Native</p>	<p>Projects at the resolution of the input image size to the center of the screen. This is ideal for projecting clear images. If the image resolution exceeds the panel resolution of your projector, the edges of the image are not projected.</p>	<p>When an 800x600 signal is input</p> <p>EB-Z8000WU</p>  <p>EB-Z8050W</p> 	<p>When a 2048x1536 signal is input</p> <p>EB-Z8000WU</p>  <p>EB-Z8050W</p> 



If parts of the image are missing or it cannot project everything, set **Wide** or **Normal** in **Resolution** from the configuration menu depending on the size of the computer panel.  [p.46](#)

Pointer Function (Pointer)

This allows you to move a Pointer icon on the projected image, and helps you draw attention to the area you are talking about.

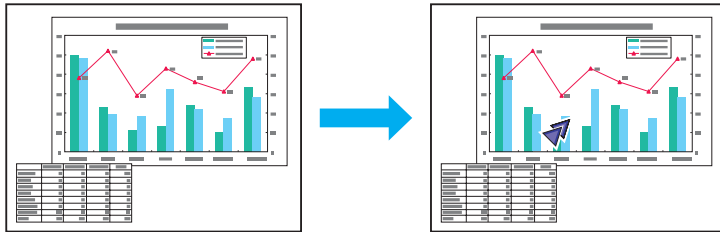

Procedure

- 1 Display the Pointer.

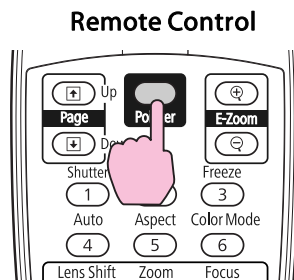

Each time you press the button, the pointer appears or disappears.

- 2 Move the Pointer icon (↗).

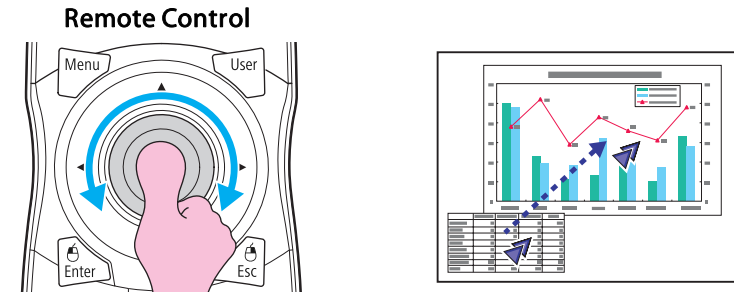

You can choose from three different kinds of Pointer icon (↗, ✖, or ↘) in **Settings - Pointer Shape** from the configuration menu.

👉 p.48

Enlarging Part of the Image (E-Zoom)

This is useful when you want to expand images to see them in greater detail, such as graphs and tables.

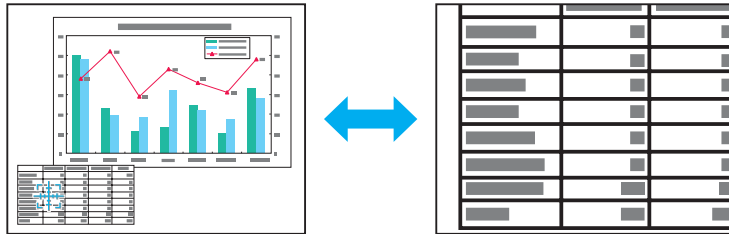

Procedure

1 Start E-Zoom.

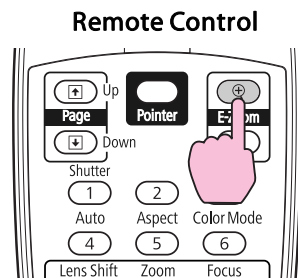

2 Move the  to the area of the image that you want to enlarge.

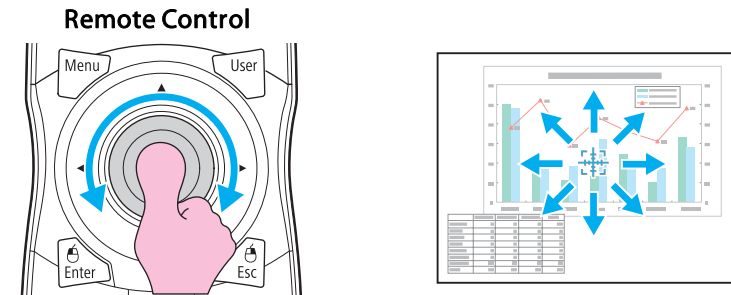

3 Enlarge.

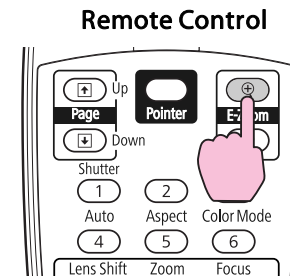

Each time the button is pressed, the area is expanded. You can expand quickly by holding the button down.

You can reduce the enlarged image by pressing the  button. Press the [ESC] button to cancel.









- The enlargement ratio appears on the screen. The selected area can be enlarged to between 1 to 4 times in 25 incremental steps.
- Tilt the  button to scroll through the enlarged image.
- If E-Zoom is selected, Progressive and Noise Reduction are cancelled.
- E-Zoom is canceled when performing some functions such as Keystone or Auto Setup.



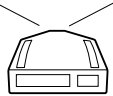

When an ID is set for the projector and the remote control, you can use the remote control to operate only the projector with a matching ID. This is very useful when managing multiple projectors.

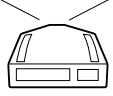
You can set an ID for the projector within a range of "1" to "9". The default value is Off.

You can set an ID for the remote control within a range of "0" to "9". The default value is "0". When the ID switch on the side of the remote control is set to Off, you can operate all projectors by the remote control regardless of the ID setting for the projector or the remote control.

The following table shows the possible combinations of projector ID and remote control ID.

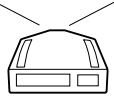
Operation	Combinations		Descriptions
Possible		Projector ID: 1	When the control switch is set to On, and Projector ID matches the remote control ID, you can operate the projector with the remote control.
		ID switch: On Remote control ID: 1	
Possible		Projector ID: 1	When the ID switch on the side of the remote control is set to Off, you can operate the projector with the remote control regardless of the projector's ID setting.
		ID switch: Off Remote control ID: 3	
Possible		Projector ID: Off	When the Projector ID is Off, you can operate with the remote control regardless of the remote control ID setting.
		ID switch: On Remote control ID: 1	

Operation	Combinations		Descriptions
Possible		Projector ID: 1	When the remote control ID is "0", you can operate with the remote control regardless of the Projector ID setting.
		ID switch: On Remote control ID: 0	
Not possible		Projector ID: 1	When the remote control switch is On, and Projector ID and remote control ID do not match, you cannot operate with the remote control.
		ID switch: On Remote control ID: 3	

When **Remote Control Type** is set to **Simple** from **Operation** in the configuration menu, you cannot set the remote control ID.

Setting the Projector ID

Procedure

- 1 During projection, press the [Menu] button and select Extended - "Projector ID" from the configuration menu.
 ☛ "Using the Configuration Menu"

Using the Remote Control

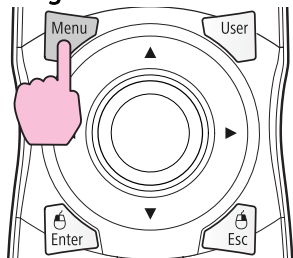

Using the Control panel

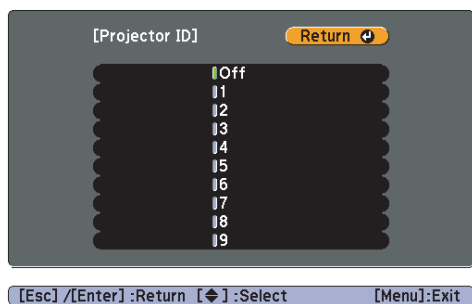
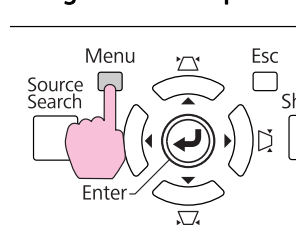

- 2 Choose the ID you want to set and press the [Enter] button.
- 3 Press the [Menu] button to close the configuration menu.

Checking the Projector ID

Use the following procedure to check the projector ID.

Procedure

- 1 Set the remote control ID switch to On.

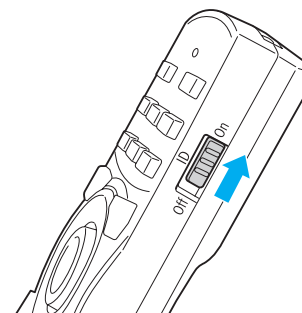

- 2 During projection, while holding the [ID] button, press the [Help] button.

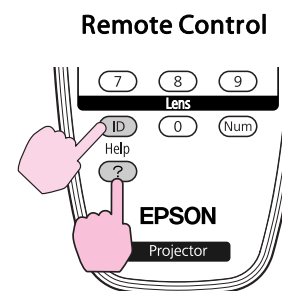

When you press the buttons, the current Projector ID is displayed on the projection screen. It disappears in about three seconds.

Setting the Remote Control ID

Procedure

- 1 Set the remote control ID switch to On.

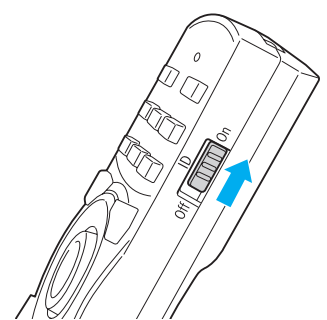

- 2 While holding the [ID] button, press a number button to select a number to match the ID of the projector you want to operate.

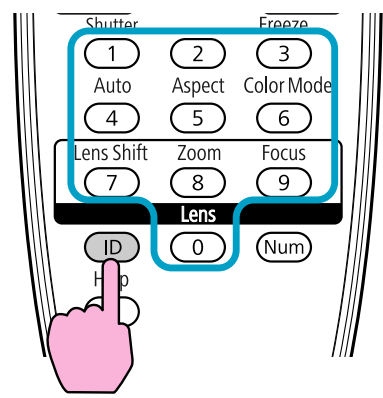

 The remote control ID setting is saved in the remote control. Even if the remote control batteries are removed to replace them and so on, the stored ID setting is retained. However, if the batteries are left out for a long time, it is reset to the default value (ID0).

Once this setting has been made, the projector that can be operated by the remote control is limited.



When multiple projectors are lined up and projecting images, you can manually correct the brightness and color tone of each projector's image so that the colors projected from each projector match closely.

Use the multi-screen color adjustment function when the Color Mode of each projector is set to the same item.

In some cases the brightness and color tone may not match completely even after correction.

Auto Iris does not work while this function is activated. Even if **Auto Iris** is set to **On**, and **Multi-screen** is set to **On**, Auto Iris does not work.

Summary of Correction Procedure

When multiple projectors are set up and you need to make corrections, use the following procedure to correct one projector at a time.

1. Set the projector ID and the remote control ID.
To limit operation to one target projector, set a Projector ID for the target projector, and set the same ID for the remote control. [p.32](#)
2. Correct the color difference.
You can carry out color correction when projecting from multiple projectors. You can adjust from black to white in five stages called levels 1 to 5, and in each of these 5 levels you can adjust the following two points.
 - Correcting brightness
You can correct the image brightness to make them all equal.
 - Correcting color
You can adjust the image color to make them match more closely by using Color Correct. (G/R) and Color Correct. (B/Y).

Correction Method

After setting up the projectors, correct the brightness and tone for each projector to reduce the differences.



Procedure

- 1 **Press the [Menu] button and select Extended - "Multi-screen" from the configuration menu.** **"Using the Configuration Menu"**
- 2 **Set "Multi-screen" to "On".**
- 3 **Select Lv. to be corrected in Adjustment Level.**
 - Each time a level is selected, the pattern of the level selected is displayed.
 - You can start correcting from any level, usually you can make it darker or lighter by correcting 1 to 5 or 5 to 1.
- 4 **Correct the brightness with Brightness Correct.**
 - When you select Lv. 5, all the images are adjusted to the darkest image from multiple projectors.
 - When you select Lv. 1, all the images are adjusted to the brightest image from multiple projectors.
 - When you select Lv. 2 to 4, all the images are adjusted to the mid-range brightness image from multiple projectors.
 - Because each time the [Enter] button is pressed the image displayed changes between the pattern display and the actual image, you can check the correction results and make corrections in the actual image.
- 5 **Correcting Color Correct. (G/R) and Color Correct. (B/Y).**
Because each time the [Enter] button is pressed the image displayed changes between the pattern display and the actual

image, you can check the correction results and make corrections in the actual image.

- 6** Repeat procedures 3 to 5 until corrections are finished.
- 7** When all corrections are finished, press the [Menu] button to close the configuration menu.

The projector has the following enhanced security functions.

- **Password Protect**
You can limit who can use the projector.
- **Control Panel Lock/Lens Operation Lock**
You can prevent people changing the settings on the projector without permission.  [p.39](#)
- **Anti-Theft Lock**
The projector is equipped with various types of anti-theft security devices.  [p.41](#)

2. User's Logo Protect

Even if someone tries to change the User's Logo set by the owner of the projector, it cannot be changed. When User's **User's Logo Protect** is set to **On**, the following setting changes for the User's Logo are prohibited.

- Capturing a User's Logo
- Settings for Display Background, and Startup Screen from Display in the configuration menu

3. Network Protect

When **Network Protect** is set to **On** setting changes for **Network** Menu in the configuration menu are prohibited.

Managing Users (Password Protect)

When Password Protect is activated, people who do not know the Password cannot use the projector to project images even if the projector power is on. Furthermore, the user's logo that is displayed when you turn on the projector cannot be changed. This acts as an anti-theft device as the projector cannot be used even if it is stolen. At the time of purchase, Password Protect is not activated.

Type of Password Protect

The following three kinds of Password Protect settings can be made according to how the projector is being used.

1. Power On Protect

When **Power On Protect** is **On**, you need to enter a preset Password after the projector is plugged in and turned on (this also applies to Direct Power On). If the correct Password is not entered, projection does not start.

Setting Password Protect

Use the following procedure to set Password Protect.

Procedure



During projection, hold down the [Freeze] button for about five seconds.

The Password Protect setting menu is displayed.

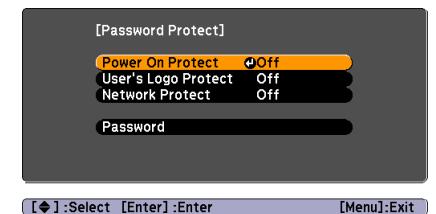
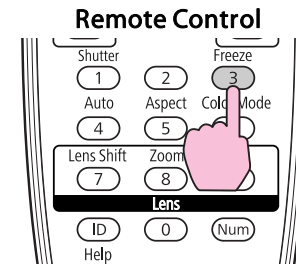



- If Password Protect is already activated, you must enter the Password.
If the Password is entered correctly, the Password Protect setting menu is displayed. ➡ "Entering the Password"
- When the Password is set, stick the Password protect sticker in a visible position on the projector as a further theft deterrent.

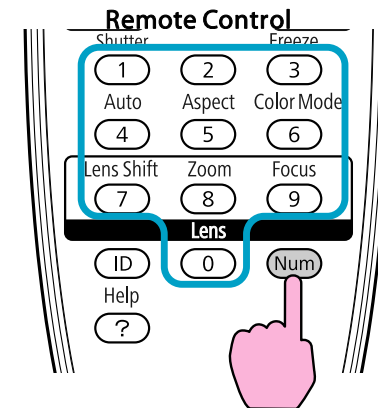

2 Turn on Power On Protect.

- (1) Select **Power On Protect**, and then press the [Enter] button.
- (2) Select **On**, and then press the [Enter] button.
- (3) Press the [ESC] button.

3 Turn on User's Logo Protect.

- (1) Select **User's Logo Protect**, and then press the [Enter] button.
- (2) Select **On**, and then press the [Enter] button.
- (3) Press the [ESC] button.

4 Turn on Network Protect.

- (1) Select **Network Protect**, and then press the [Enter] button.
- (2) Select **On**, and then press the [Enter] button.
- (3) Press the [ESC] button.

5 Set the Password.

- (1) Select **Password**, and then press the [Enter] button.
- (2) The message "Change the password?" is displayed, select **Yes** and then press the [Enter] button. The default setting for the Password is "0000". Change this to your own desired Password. If you select **No**, the screen shown in step 1 is displayed again.
- (3) While holding down the [Num] button, enter a four digit number using the numeric buttons. The number entered is displayed as "* * * *". When you enter the fourth digit, the confirmation screen is displayed.

- (4) Re-enter the Password.
The message "Password accepted." is displayed.
If you enter the Password incorrectly, a message is displayed prompting you to re-enter the password.

Entering the Password

When the Password entry screen is displayed, enter the Password using the numeric buttons on the Remote Control.

Procedure

While holding down the [Num] button, enter the Password by pressing the numeric buttons.

When you enter the correct Password, projection begins.

Attention

- If an incorrect Password is entered three times in succession, the message **"The projector's operation will be locked."** is displayed for about five minutes, and then the projector switches to standby mode. If this happens, disconnect the power plug from the electrical outlet and then reinsert it and turn the projector's power back on. The projector displays the Password entry screen again so that you can enter the correct Password.
- If you have forgotten the password, make a note of the "Request Code: xxxxx" number that appears on the screen and contact the nearest address provided in the Support and Service Guide. [Epson Projector Contact List](#)
- If you continue to repeat the above operation and input the wrong Password thirty times in succession, the following message is displayed and the projector does not accept any more Password entries. **"The projector's operation will be locked."** Contact Epson as described in your documentation. [Epson Projector Contact List](#)

Restricting Button Operation

The following two kinds of operation restriction functions are available with the projector.

- **Control Panel Lock**
This is useful at events or shows when you want to deactivate all buttons during projection or at schools when you want to limit button operation.
- **Lens Operation Lock**
This function deactivates all buttons on the remote control related to the lens operation to prevent improper lens adjustment after it is properly adjusted.

Setting Control Panel Lock

Perform one of the following to lock the operation buttons on the Control panel. Even if the control panel is locked, you can still use the remote control as usual.

- **Full Lock**
All of the buttons on the Control panel are locked. You cannot perform any operations from the Control panel, including turning the power on or off.
- **Partial Lock**
All of the buttons on the Control panel, except for the [⏻] button, are locked.

Procedure

1

During projection, press the [Menu] button and select **Settings - Control Panel Lock** from the configuration menu.
 "Using the Configuration Menu"

Using the Remote Control

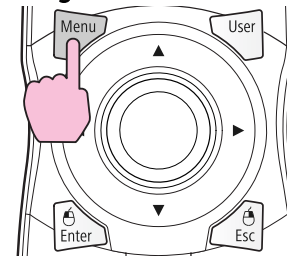

Using the Control panel

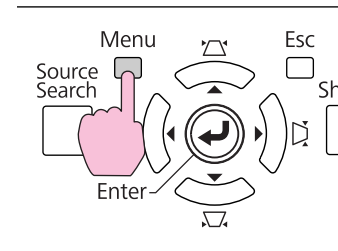

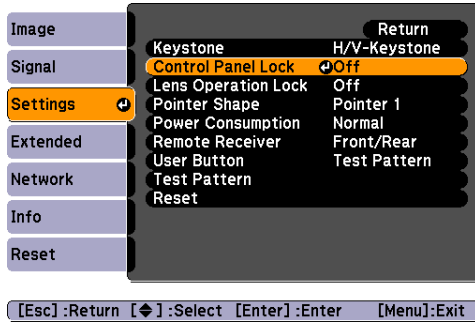

2 Select either Full Lock or Partial Lock according to your purpose.

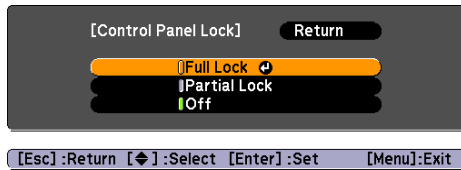

3 Select Yes when the confirmation message is displayed.

The Control panel buttons are locked according to the setting you chose.



You can release the Control panel lock by one of the following two methods.

- From the Remote Control, select **Off** in **Settings - Control Panel Lock** from the configuration menu.
- Press and hold down the [Enter] button on the Control panel for about seven seconds, a message is displayed and the lock is released.

Lens Operation Lock

This function locks the following buttons on the remote control related to the lens operation.

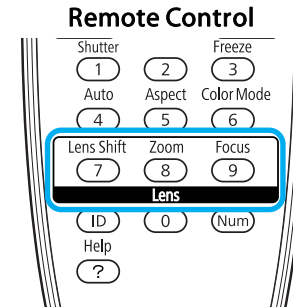

Procedure

1 Press the [Menu] button, and select Settings - "Lens Operation Lock" from the configuration menu. **"Using the Configuration Menu"**

Using the Remote Control

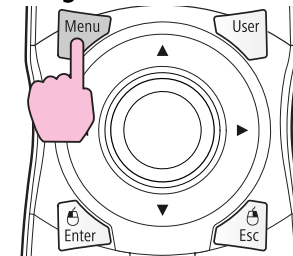

Using the Control panel

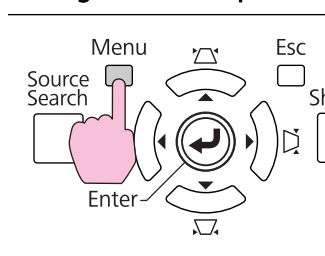

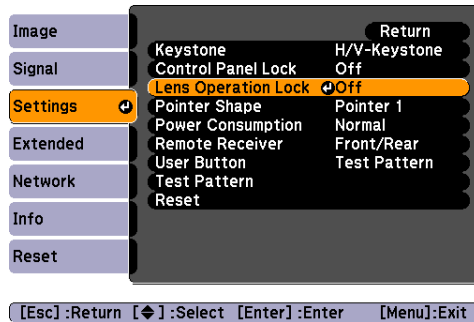

2

Select "On".

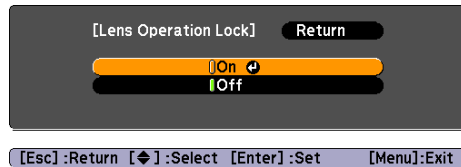

The buttons related to the lens operation are locked according to the setting you chose.

Anti-Theft Lock

As the projector is often setup on ceiling mounts and left in rooms unattended, the projector includes the following security devices to prevent someone from taking the projector.

- Security slot
The Security slot is compatible with the Microsaver Security System manufactured by Kensington. You can find details about the Microsaver Security System on the Kensington homepage <http://www.kensington.com/>.
- Handle
A commercially available theft-prevention wire lock can be passed through the handle to secure the projector to a desk or pillar.

Installing the wire lock

Pass an anti-theft wire lock through the handle.

See the documentation supplied with the wire lock for locking instructions.

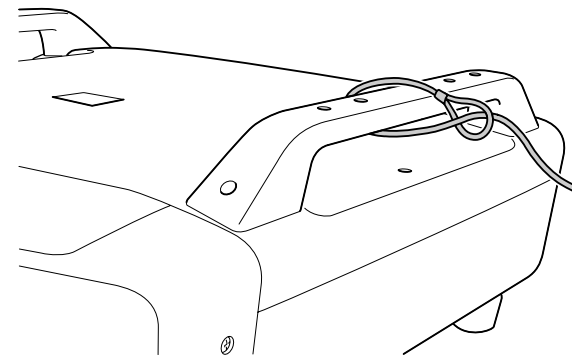



Configuration Menu

This chapter explains how to use the configuration menu and its functions.

1

Selecting from the top menu

2

Selecting from the sub menu

3

Changing the selected item

4

Exit

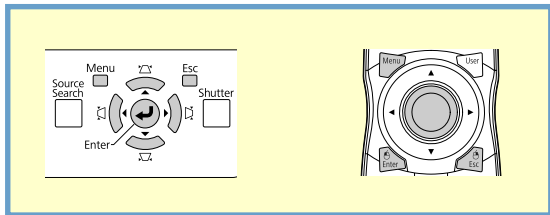
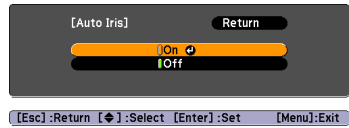
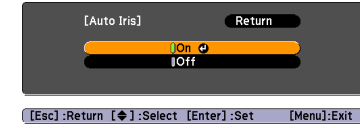
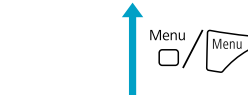
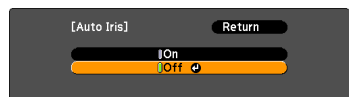
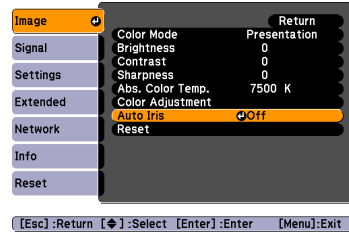
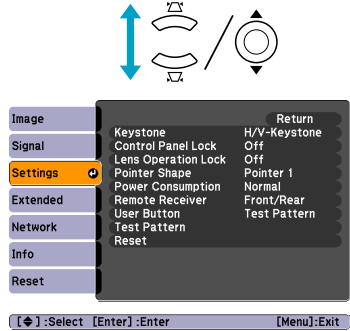
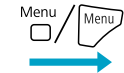
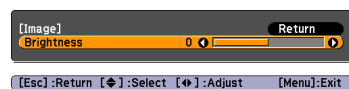
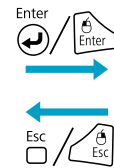
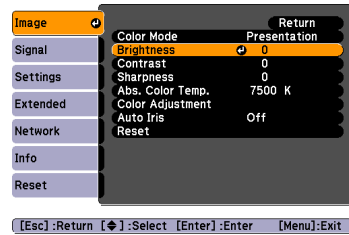
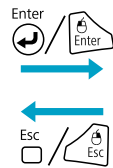
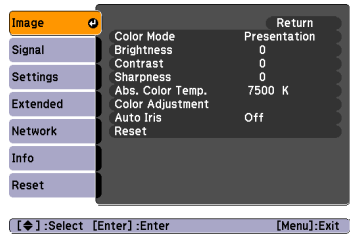
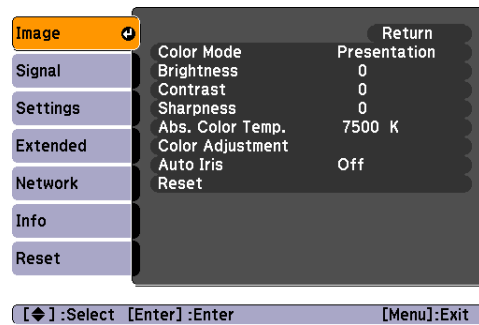

Image Menu

Items that can be set vary depending on the image signal currently being projected as shown in the following screen shots. Setting details are saved for each image signal.



Analog RGB/Digital RGB

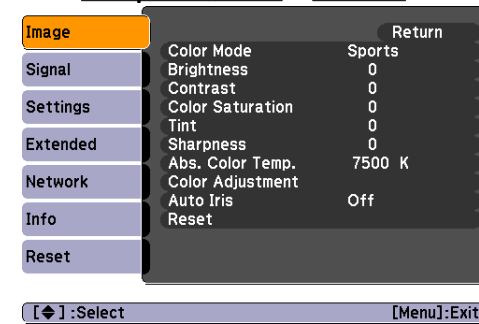

Analog/Digital Component Video / Composite video / S-Video









Sub Menu	Function
Color Mode	You can select the quality of the image to suit your surroundings.  p.23
Brightness	You can adjust the image Brightness.
Contrast	You can adjust the difference between light and shade in the images.
Color Saturation	You can adjust the Color Saturation for the images.
Tint	(Setting is only possible when NTSC signals are being input if you use composite video/S-Video.) You can adjust the image Tint.
Sharpness	You can adjust the image sharpness.
Abs. Color Temp.	(This item cannot be selected if sRGB is selected as the Color Mode setting from the Image menu.) You can adjust the overall tint of the image. You can adjust tints in 10 stages from 5000 K to 10000 K. When a high value is selected the image becomes tinged with blue, when a low value is selected the image becomes tinged with red.

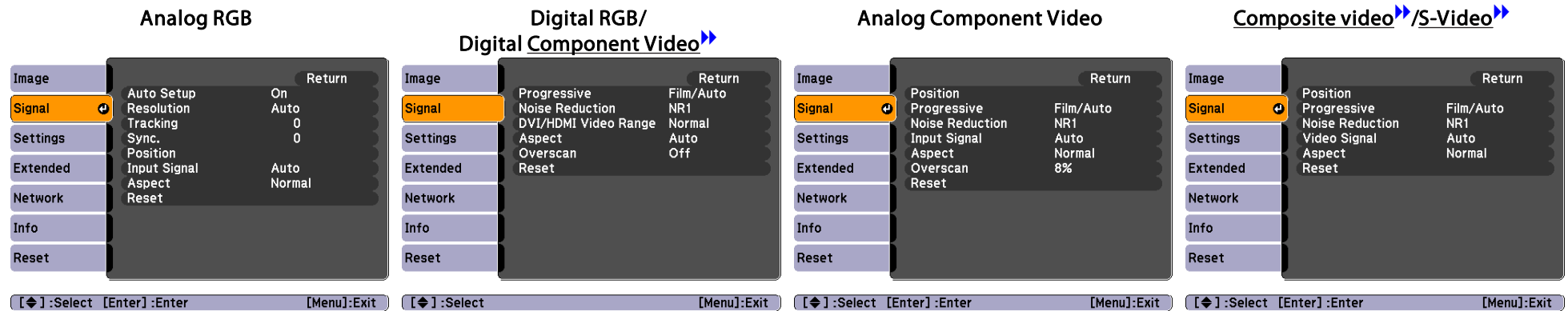

Sub Menu	Function
Color Adjustment	<p>(This item cannot be selected if sRGB is selected as the Color Mode setting from the Image menu.) You can make adjustments by choosing one of the following. Red, Green, Blue: You can adjust the saturation of each color individually. (This item cannot be displayed if Customized is selected as the Color Mode setting from the Image Menu.) R, G, B, C, M, Y: You can adjust the hue, saturation, and brightness of each color R (red), G (green), B (blue), C (cyan), M (magenta), Y (yellow) individually. (This item is displayed only when Customized is selected as the Color Mode setting from the Image Menu.)</p>
Auto Iris	<p>(This setting is only possible when the Color Mode setting in the Image Menu is set to Dynamic, Theatre, or Customized, and Multi-screen is set to Off.) Set whether or not (On/Off) to adjust to the optimum light status for images being projected.  p.24 The setting is stored for each Color Mode.</p>
Reset	<p>You can reset all adjustment values for the Image menu functions to their default settings. To return all menu items to their default settings, see  p.68</p>

Signal Menu

Items that can be set vary depending on the image signal currently being projected as shown in the following screen shots. Setting details are saved for each image signal.





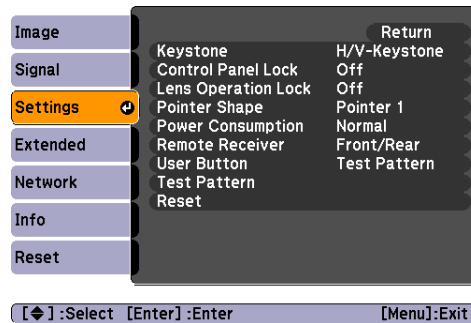

Sub Menu	Function
Auto Setup	You can select whether or not (On/Off) Auto Setup automatically adjusts the image to the optimum state when the Input Signal changes.  p.78 Auto Setup is not available when Resolution is set to Customized 1 or Customized 2 .
Resolution	Auto: The resolution of the input signal is automatically identified. Wide, Normal: If the images cannot be projected correctly when Auto is set, set this menu. Set to Wide depending on the connected computer for wide screens, or set to Normal for 4:3 or 5:4 screens. Manual: You can specify the resolution. This is ideal when connected computer is fixed.
Tracking 	You can adjust computer images when vertical stripes appear in the images.  p.78
Sync 	You can adjust computer images when flickering, fuzziness, or interference appear in the images.  p.78
Position	You can adjust the display Position up, down, left, and right when a part of the image is missing so that the whole image is projected.
Progressive	(Component Video can only be adjusted when 480i/576i/1080i signals are being input. This cannot be set when a digital RGB signal is input.) Off: IP conversion is carried out for each field in the screen. This is ideal for viewing images with a large amount of movement. Video: This is ideal for viewing general video images. Film/Auto: By automatically converting movie films, CG, animated images, and so on recorded in 24/30 frames to the optimum progressive signal via 2-3 pull-down, it is possible to recreate the natural feel of the original image.

Sub Menu	Function
Noise Reduction	(This cannot be set when a digital RGB signal is input) Smooths out rough images. There are two modes. Select your favorite setting. It is recommended that this is set to Off when viewing image sources in which noise is very low, such as for DVDs.
DVI/HDMI Video Range	(This cannot be set when a digital RGB signal is input) When the projector's DVI-D input port or HDMI input port is connected to a DVD player, the projector's video range is set according to the DVD player's video range setting.
Input Signal	You can select an input signal from Computer input port or BNC input port. If Auto is set, the input signal is identified automatically according to the connected equipment. If colors do not appear correctly when this is set to Auto , select the appropriate signal according to the connected equipment.
Video Signal	You can select input signal from Video input port. If set to Auto , video signals are recognized automatically. If interference appears in the image or a problem occurs such as no image is being projected when set to Auto , select the appropriate signal according to the connected equipment.
Aspect	You can set the <u>Aspect Ratio</u>  for projected images.  p.25
Overscan	(This cannot be set when a digital RGB signal is input) You can change the Output Scaling (the range of projected image). The range of trimming screen can be set to Off, 4%, or 8%. You can select Auto only when the input source is HDMI. When Auto is selected, the range is automatically switched to Off or 8% according to the input signal. However, the automatic setting is only effective when the video equipment is connected via the projector's HDMI port.
Reset	You can reset all adjustment values on the Signal menu to their default settings, except for Input Signal. To return all menu items to their default settings, see  p.68

Settings Menu







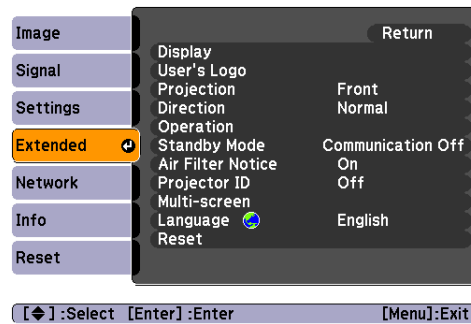

Sub Menu	Function
Keystone	<p>You can correct keystone distortion.</p> <p>H/V-Keystone: Corrects horizontal and vertical keystone distortion. Select one of V-Keystone or H-Keystone.</p> <p>Use the [↖/↗], [↘/↙], [↖/↙], and [↗/↘] buttons on the control panel to perform similar corrections to V-Keystone and H-Keystone.</p> <p>Quick Corner: Selects and corrects the four corners of the projected image. 🖱️ p.18</p>
Control Panel Lock	You can use this to restrict operation of the projector's Control panel. 🖱️ p.39
Lens Operation Lock	You can use this to restrict the lens operation of the remote control. 🖱️ p.40
Pointer Shape	<p>You can select the shape of the pointer. 🖱️ p.30</p> <p>Pointer 1:  Pointer 2:  Pointer 3: </p>
Power Consumption	<p>You can set the lamp brightness to Normal or ECO.</p> <p>Select ECO if the images being projected are too bright such as when projecting images in a dark room or onto a small screen. When ECO is selected, the amount of electricity consumed and the lamp's operating life are changed as follows, and the fan rotation noise during projection is reduced. Electrical consumption: about 16% decrease, lamp life: about 1.4 times longer</p>
Remote Receiver	<p>You can limit the reception of the operation signal from the Remote Control.</p> <p>When you want to prohibit operation by Remote Control, or if the Remote Receiver has a fluorescent light too close to it, you can make settings to deactivate the remote receiver you do not want to use or that is experiencing interference.</p>
User Button	<p>You can select the item assigned from the configuration menu with the Remote Control's [User] button. By pressing the [User] button the assigned menu item selection/adjustment screen is displayed, allowing you to make one-touch settings/adjustments. You can assign one of the following six items to the [User] button.</p> <p>Power Consumption, Info, Progressive, Test Pattern, Multi-screen, and Resolution</p>

Sub Menu	Function
Test Pattern	When the projector is setup, a Test Pattern is displayed so that you can adjust the projection without connecting other equipment. While the Test Pattern is displayed, zoom, focus adjustments, and Keystone correction can be performed. To cancel the Test Pattern, press the [ESC] button on the Remote Control or the Control panel.
Reset	You can reset all adjustment values on the Settings menu to their default settings, except for User Button. To return all menu items to their default settings, see  p.68

Extended Menu



Sub Menu	Function
Display	You can make settings related to the projector's display. Messages: The following messages are not displayed on the screen when this item is set to Off . Overheating and other warnings, messages such as when there is no video input, and when Freeze is On or when changing Source, Color Mode or Aspect. Display Background^{*1}: You can set the screen status for when no image signal is available to Black , Blue , or Logo . Startup Screen^{*1}: You can set whether or not (On/Off) the Startup Screen (the registered User's Logo displays when starting the projector) is displayed. Menu Size (EB-Z8000WU only): You can select Normal or Larger for the display size of the configuration menu, Help, and other messages.
User's Logo^{*1}	You can change the User's Logo that is displayed as a background during Display Background or Startup Screen.  p.97
Projection	You can set from the following according to the way the projector is set up.  p.84 Front, Front/Ceiling, Rear, Rear/Ceiling

Sub Menu	Function
Direction	You can set from the following according to the way the projector is set up.  p.84 Normal, Pointing Up, Pointing Down
Operation	<p>Direct Power On: You can set whether or not (On/Off) to enable Direct Power On. Be careful when this item is set to On because this unit turns on at the time of power recovery with this unit plugged-in to an outlet.</p> <p>Sleep Mode: When set to On, this automatically stops projection when no image signal is being input and no operations are carried out.</p> <p>Sleep Mode Timer: When Sleep Mode is set to On, you can set the time before the projector automatically turns off within a range of 1 to 30 minutes.</p> <p>Shutter Timer: When set to On, this turns off the power automatically 120 minutes after the electric shutter is closed. Shutter Timer is set to On at the time of purchase. (When Shutter Timer and Sleep Mode are set to On at the same time, Sleep Mode has priority.)</p> <p>High Altitude Mode: Set to On when using the projector above an altitude of 1500 m.</p> <p>BNC Sync Termination: Set the termination for the signal from the BNC input port. This should usually be set to Off. Set to On when analog (75Ω) termination such as for switchers is necessary.</p> <p>Remote Control Type: You can select Normal or Simple depending on the type of remote control. Set this item to Normal to use the remote control provided with the projector. When Simple is selected, you can use the remote control provided with other Epson projectors to operate this projector (except for EB-G5350/G5200W/G5100). This is useful if you want to use a remote control that you are already familiar with to operate the projector. However, you cannot use the remote control provided with the projector if this is set to Simple. Make sure you want to change this setting to Simple because, if the projector is mounted on the ceiling or somewhere hard to reach, changing it back may be difficult.</p>
Standby Mode	You can use the functions that monitor and control the status of the projector over the network even when the projector is in standby mode if this is set to Communication On . You can use SNMP  to monitor and control the status of the projector over the network, or by using the EasyMP Monitor software supplied with this product.
Air Filter Notice	You can set whether or not (On/Off) to enable Air Filter Notice. When this is set to On and a clog in the air filter is detected, the message is displayed on the screen.
Projector ID	Set the ID within a range of 1 to 9. Off indicates that no ID is set.  p.33
Multi-screen	When this is set to On, you can adjust the hue and brightness of images projected from a row of the several projectors.  p.35 Adjustment Level: You can adjust from black to white in five stages called Level 1 to 5, and in each of these 5 levels you can adjust Brightness Correct. and Color Correct. Brightness Correct.: Corrects the difference in the brightness of each projector. Color Correct. (G/R) / Color Correct. (B/Y): You can correct the difference in the color of each projector. When Multi-screen is set to On , Auto Iris does not work.

Sub Menu	Function
Language	You can set the Language for message displays.
Reset	You can reset Display* ¹ , Operation* ² , and Air Filter Notice from the Extended menu to their default settings. To return all menu items to their default settings, see  p.68



*1 When **User's Logo Protect** is set to **On** in **Password Protect**, settings relating to User's Logo cannot be changed. You can make changes after setting **User's Logo Protect** to **Off**.  [p.37](#)

*2 Except for High Altitude Mode and Remote Control Type.

Network Menu (EB-Z8000WU only)

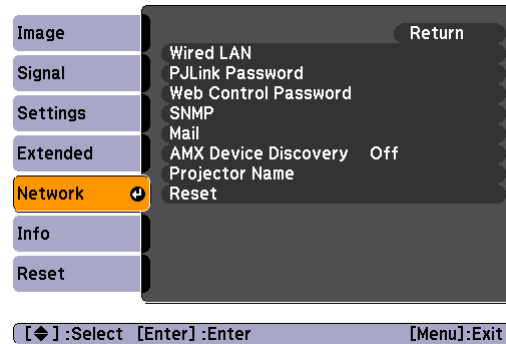
When **Network Protect** is set to **On** in **Password Protect**, a message is displayed and the settings cannot be changed. You can make changes after setting **Network Protect** to **Off**.  [p.37](#)



Sub Menu	Function
Wired LAN	<p>You can make network settings.</p> <p>DHCP: You can set whether or not (On/Off) to use DHCP. If this is set to On you cannot set any more addresses.</p> <p>IP Address: You can input the IP address assigned to the projector.* You can enter a number from 0 to 255 in each field of the address. However, the following IP Addresses cannot be used. 0.0.0.0, 0.x.x.x, 127.x.x.x, 224.0.0.0 to 255.255.255.255 (where x is a number from 0 to 255)</p> <p>Subnet Mask: You can input the subnet mask for the projector.* You can enter a number from 0 to 255 in each field of the address. However, the following Subnet Masks cannot be used. 0.0.0.0, 255.255.255.255</p> <p>Gateway Address: You can input the IP address for the gateway for the projector.* You can enter a number from 0 to 255 in each field of the address. However, the following Gateway Addresses cannot be used. 0.0.0.0, 127.x.x.x, 224.0.0.0 to 255.255.255.255 (where x is a number from 0 to 255)</p> <p>MAC Address: You can display the MAC address for the projector.</p>
PJLink Password	<p>Set a Password to use when you access the projector using compatible PJLink software.*  p.113</p> <p>You can enter up to 32 single-byte alphanumeric characters.</p>
Web Control Password	<p>Set a password to use when making settings and controlling the projector using Web Control.* You can enter up to 8 single-byte alphanumeric characters.</p> <p>Web control is a computer function that allows you to set up and control the projector by using a web browser on the computer running EasyMP Monitor.  EasyMP Monitor Operation Guide</p>
SNMP	<p>You can make SNMP  settings.</p> <p>Trap IP Address 1/Trap IP Address 2: You can register up to two addresses as the SNMP trap notification destination.* To use SNMP to monitor the projector, you need to install the SNMP manager program on your computer. SNMP should be managed by a network expert.</p>

Sub Menu	Function
Mail	<p>When this is set, you receive an e-mail notification if a problem or warning occurs in the projector. For information on the contents of the sent email, see "Reading Problem Mail Notification Function" p.110</p> <p>Mail Notification: You can set whether or not (On/Off) to be notified by e-mail. If this is set to Off you cannot set any more addresses.</p> <p>SMTP Server: You can input the IP address for the SMTP server for the projector.*</p> <p>You can enter a number from 0 to 255 in each field of the address. However, the following IP Addresses cannot be used. 127.x.x.x, 224.0.0.0 to 255.255.255.255 (where x is a number from 0 to 255)</p> <p>Port Number: You can display the SMTP server's port number.</p> <p>The default value is 25. When editing settings from Web Control, you can change Port Number by entering a valid number from 1 to 65535.</p> <p>Address 1 Setting/Address 2 Setting/Address 3 Setting: You can enter the e-mail address* and the contents of the message to receive notification when a problem or warning occurs. You can register up to three destinations. You can enter up to 64 single-byte alphanumeric characters for the e-mail addresses.</p>
AMX Device Discovery	<p>When the projector is connected to a network, set this to On to allow the projector to be detected by <u>AMX Device Discovery</u>. Set this to Off if the projector is not connected to an environment controlled with a controller from AMX or AMX Device Discovery.</p>
Projector Name	<p>Displays the projector name used to identify the projector when connected to a network.</p>
Reset	<p>You can reset all adjustment values for the Network menu to their default settings.</p> <p>To return all menu items to their default settings, see p.68</p>

* When inputting numbers and passwords, the following software keyboards are displayed. Tilt the [◊] button on the remote control to move the cursor to the target key, and then press the [Enter] button. Enter figures by holding down the [Num] button on the Remote Control, and pressing the numeric buttons. After inputting, press [Finish] on the keyboard to confirm your input. Press [Cancel] on the keyboard to cancel your input.

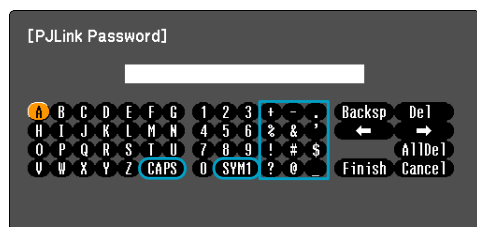

[Esc]:Return [◄►]:Select [Enter]:Set [Menu]:Exit

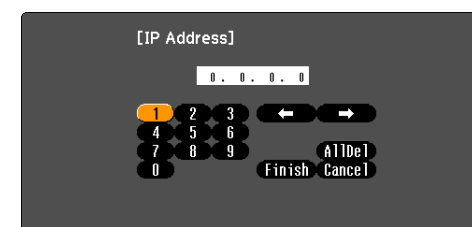

[Esc]:Return [◄►]:Select [Enter]:Set [Menu]:Exit

Each time the [CAPS] key is selected, it sets and changes between upper case and lower case letters. Each time the [SYM1/2] key is selected, it sets and changes the symbol keys for the section enclosed by the frame.

Network Menu (EB-Z8050W only)

When **Network Protect** is set to **On** in **Password Protect**, a message is displayed and the settings cannot be changed. You can make changes after setting **Network Protect** to **Off**.  [p.37](#)

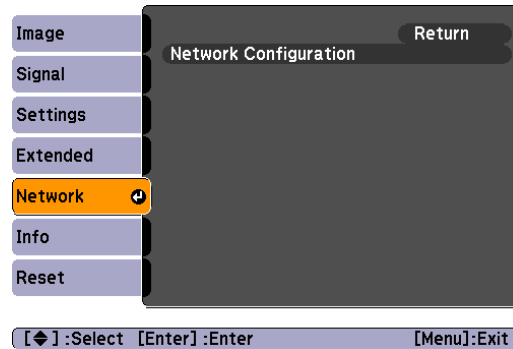

Sub Menu	Function
Network Configuration	The following menus are available for setting network items. Basic, Wireless LAN, Security, Wired LAN, Mail, Others, Reset and Setup complete.



By using the Web browser of a computer connected to the projector on a network, you can set the projector's functions and control the projector. This function is called "Web control". You can easily enter text using a keyboard to make settings for Web control such as security settings.  [Projector Operation Guide "Changing Settings Using a Web Browser \(Web Control\)"](#)

Notes on operating the network menu

Selecting from the top menu and sub menus, and changing of selected items are the same as operations in the configuration menu.

When done, make sure you go to the **Setup complete**, and select one of **Yes**, **No**, or **Cancel**. When you select **Yes** or **No**, you return to the configuration menu.

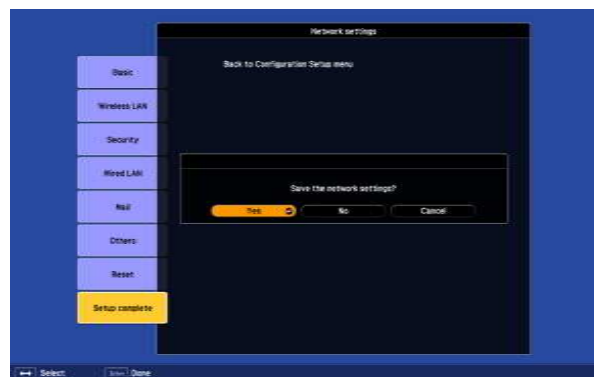

- Yes:** Saves the settings and exits the **Network** menu.
No: Exits to the **Network** menu without saving the settings.
Cancel: Continues displaying the **Network** menu.

Soft keyboard operations

The **Network** menu contains items that require input of alphanumeric during setup. In this case, the following software keyboard is displayed. Use the [◂] button on the remote control or [↖/▲], [↘/▼], [↙/◀], and [↗/▶] on the projector to move the cursor to the desired key, and then press the [Enter] button to enter the alphanumeric. Enter figures by holding down the [Num] button on the remote control, and pressing the numeric buttons. After inputting, press [Finish] on the keyboard to confirm your input. Press [Cancel] on the keyboard to cancel your input.

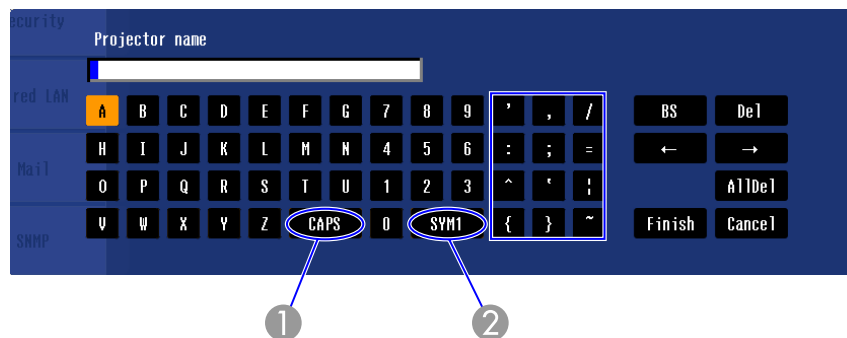



- ① Each time this key is selected, it sets and changes between upper case and lower case letters.
- ② Each time this key is selected, it sets and changes the symbol keys for the section enclosed by the frame.

Basic Menu



Sub Menu	Function
Projector Name	Displays the projector name used to identify the projector when connected to a network. When editing, you can enter up to 16 single-byte alphanumeric characters.
PJLink Password	Set a password to use when you access the projector using compatible PJLink software.  p.113 You can enter up to 32 single-byte alphanumeric characters.

Sub Menu	Function
Web Control Password	Set a password to use when making settings and controlling the projector using Web Control. You can enter up to 8 single-byte alphanumeric characters. Web control is a computer function that allows you to set up and control the projector by using the Web browser on a computer connected on a network.  Projector Operation Guide "Changing Settings Using a Web Browser (Web Control)"
Projector keyword	When set to On , you have to enter the keyword when you try to connect the projector to a computer on a network. As a result, you can prevent presentations from being interrupted by unscheduled connections from the computer. Normally this should be set to On .  Projector Operation Guide "Connecting to a Projector on a Network and Projecting"

Wireless LAN Menu (only when the optional wireless LAN unit is installed)



Sub Menu	Function
Wireless LAN Power	Set to Off to deactivate the wireless LAN unit connected to the projector. When set to Off , the wireless LAN unit is treated as if it were not connected.
Connection mode	When the projector is connected to a computer with EasyMP Network Projection, set so that it is in a permanently connected mode.
Wi-Fi Protected Setup	When using a WPS (Wi-Fi Protected Setup) compatible access point via a wireless LAN, you can easily connect the projector to the access point and make security settings.  p.99
Antenna level	Displays the wireless LAN wave strength.
Wireless LAN system	Sets the wireless LAN system.
SSID	Enter an SSID. When an SSID is provided for the wireless LAN system in which the projector participates, enter the SSID. You can enter up to 32 single-byte alphanumeric characters.

Sub Menu	Function
DHCP	You can set whether or not (On/Off) to use DHCP . If this is set to On you cannot set any more addresses.
IP Address	You can input the IP address assigned to the projector. You can input a number from 0 to 255 in each field of the address. However, the following IP addresses cannot be used. 0.0.0.0, 127.x.x.x, 224.0.0.0 to 255.255.255.255 (where x is a number from 0 to 255)
Subnet Mask	You can input the Subnet Mask for the projector. You can input a number from 0 to 255 in each field of the address. However, the following subnet masks cannot be used. 0.0.0.0, 255.255.255.255
Gateway Address	You can input the IP address for the gateway for the projector. You can input a number from 0 to 255 in each field of the address. However, the following Gateway addresses cannot be used. 0.0.0.0, 127.x.x.x, 224.0.0.0 to 255.255.255.255 (where x is a number from 0 to 255)
MAC Address	Displays the MAC address.
SSID Display	To prevent the SSID from being displayed on the LAN Standby screen, set this to Off .
IP Address Display	To prevent the IP address from being displayed on the LAN Standby screen, set this to Off .

Security menu (Only available when the optional wireless LAN unit is installed)

When the optional wireless LAN unit is installed and being used in Manual Mode, it is strongly recommended that you set security.

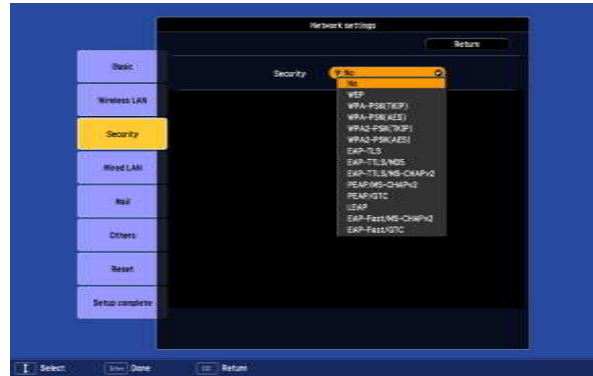

Sub Menu	Function
Security	<p>Select one of the following security methods.</p> <p>When setting up security, follow the instructions from the administrator of the network system you are about to access.</p> <p>WEP: Data is encrypted with a code key (WEP key)</p> <p>This mechanism prevents communication unless the encrypted keys for the access point and the projector match.</p> <p>WPA/WPA2: This is an encryption standard that improves security which is a weak point of WEP. Although there are multiple kinds of WPA encryption methods, this projector uses "TKIP" and "AES".</p> <p>WPA also includes user authentication functions. WPA authentication provides two methods: using an authentication server, or authenticating between a computer and an access point without a server. This projector supports the latter method, without a server.</p> <p>EAP: EAP is a protocol used for communication between clients and authentication servers. These are multiple protocols, such as EAP-TLS which uses electronic certification for user authentication, LEAP which uses user name and password, and EAP-TTLS.</p>

Type of security

System	Authentication
EAP-TLS	Digital certificate, CA certificate
EAP-TTLS/MD5	User name, Password
EAP-TTLS/MS-CHAPv2	User name, Password
PEAP/MS-CHAPv2	User name, Password

System	Authentication
PEAP/EAP-GTC	User name, Password
LEAP	User name, Password
EAP-Fast/MS-CHAPv2	User name, Password
EAP-Fast/GTC	User name, Password



- If using EAP, you need to make settings at the projector that match the authentication server settings. Check with your network administrator for details on RADIUS settings.
- Open “Network Menu” – “Certificate” in “Web Control” to register a digital certificate and a CA certificate to the projector. Only one set of a digital certificate and a CA certificate can be registered to the projector. These certificates are used with EAP-TLS.

When WEP is selected

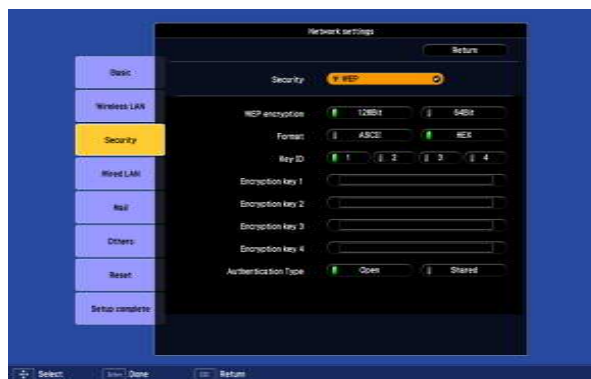

The following items can be set.

Sub Menu	Function
WEP encryption	<p>You can set the encryption for WEP encoding.</p> <p>128 Bit: Uses 128 (104) bit encoding</p> <p>64 Bit: Uses 64 (40) bit encoding</p>

Sub Menu	Function
Format	You can set the input method for the WEP encrypted key. ASCII: Input text. The method of inputting the encrypted WEP with text differs depending on the access point. Check with the network administrator for the network in which the projector participates, and then set to "ASCII". HEX: Input in hexadecimal.
Key ID	Selects the WEP encryption ID key.
Encryption key 1/ Encryption key 2/ Encryption key 3/ Encryption key 4	You can enter the key used for WEP encryption. Enter the key in single-byte characters following instructions from the network administrator for the network in which the projector participates. The type of character and the number that can be entered differ according to the WEP encryption and Format settings. If the number of characters you enter is shorter than the required character length, no character is encrypted. If the number of characters you enter is longer than the required character length, characters that exceed the permitted number are not encrypted. 128 Bit - ASCII: Single-byte alphanumerics, 13 characters. 64 Bit - ASCII: Single-byte alphanumerics, 5 characters. 128 Bit - HEX: 0 to 9 and A to F, 26 characters 64 Bit - HEX: 0 to 9 and A to F, 10 characters
Authentication Type	You can set Authentication Type for WEP encoding. Open: Method to connect access point with no authentication. Shared: Authentication Type using WEP key.

When WPA-PSK (TKIP) or WPA2-PSK (AES) are selected

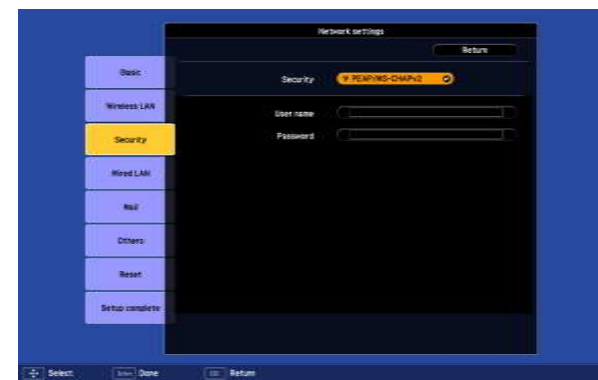
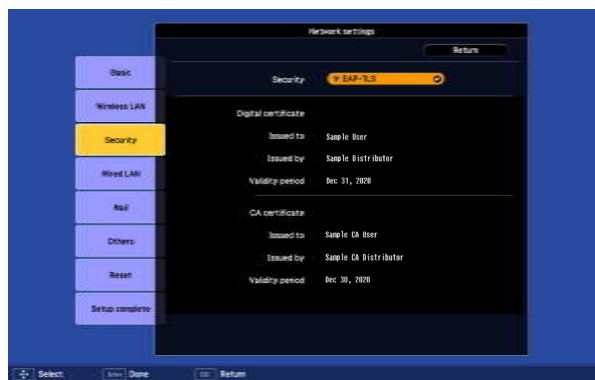
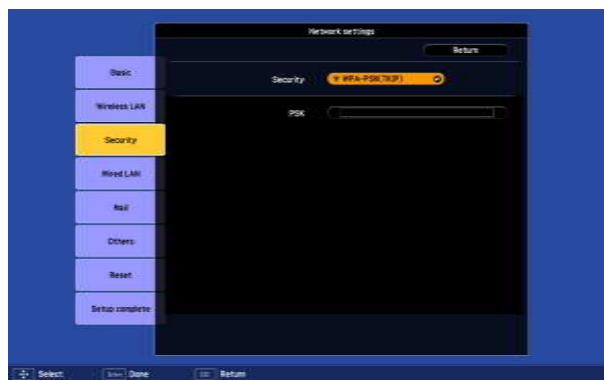

The following items can be set.

Sub Menu	Function
PSK (Encryption key)	You can enter a Pre-Shared Key (encrypted key) in single-byte alphanumeric characters. Enter at least 8 and up to 63 characters. When the Pre-Shared Key is entered and the [Enter] button is pressed, the value is set and displayed as an asterisk (*). You cannot enter more than 32 characters on the configuration menu. When setting from Web Control, you can enter more than 32 characters.  Projector Operation Guide "Changing Settings Using a Web Browser (Web Control)"



When EAP-TLS is selected

The following items can be set.

Sub Menu	Function
Issued to/Issued by/Validity period	Information in the certificate is displayed. You cannot enter.

When EAP-TTLS/MD5, EAP-TTLS/MS-CHAPv2, PEAP/MS-CHAPv2, PEAP/GTC, LEAP, EAP-Fast/MS-CHAPv2 or EAP-FAST/GTC are selected

The following items can be set.

Sub Menu	Function
User name	You can enter a user name to be used for authentication in single-byte alphanumeric characters (no spaces). You can enter up to 64 characters. You cannot enter more than 32 characters on the configuration menu. When setting from Web Control, you can enter more than 32 characters.  Projector Operation Guide "Changing Settings Using a Web Browser (Web Control)"
Password	You can enter an authentication password in single-byte alphanumeric characters. You can enter up to 64 characters. When the password is entered and the [Enter] button is pressed, the value is set and displayed as an asterisk (*). You cannot enter more than 32 characters on the configuration menu. When setting from Web Control, you can enter more than 32 characters.  Projector Operation Guide "Changing Settings Using a Web Browser (Web Control)"

Wired LAN Menu



Sub Menu	Function
DHCP	You can set whether or not (On/Off) to use DHCP . If this is set to On you cannot set any more addresses.
IP Address	You can input the IP address assigned to the projector. You can input a number from 0 to 255 in each field of the address. However, the following IP addresses cannot be used. 0.0.0.0, 127.x.x.x, 224.0.0.0 to 255.255.255.255 (where x is a number from 0 to 255)
Subnet Mask	You can input the Subnet Mask for the projector. You can input a number from 0 to 255 in each field of the address. However, the following subnet masks cannot be used. 0.0.0.0, 255.255.255.255
Gateway Address	You can input the IP address for the gateway for the projector. You can input a number from 0 to 255 in each field of the address. However, the following Gateway addresses cannot be used. 0.0.0.0, 127.x.x.x, 224.0.0.0 to 255.255.255.255 (where x is a number from 0 to 255)
MAC Address	Displays the MAC address.
IP Address Display	To prevent the IP address from being displayed on the LAN Standby screen, set this to Off .

Mail Menu

When this is set, you receive an e-mail notification if a problem or warning occurs in the projector. For information on the contents of the sent e-mail,  [p.110](#)



Sub Menu	Function
Mail Notification	You can set whether or not (On/Off) to be notified by e-mail.
SMTP Server	You can input the <u>IP address</u>  for the SMTP server for the projector. You can input a number from 0 to 255 in each field of the address. However, the following IP addresses cannot be used. 127.x.x.x, 224.0.0.0 to 255.255.255.255 (where x is a number from 0 to 255)
Port Number	You can input the port number for the SMTP server. The default value is 25. You can input numbers between 1 to 65535.
Email Address 1/Email Address 2/Email Address 3	You can input the e-mail address of the destination to send the notification e-mail to. You can register up to three destinations. You can enter up to 64 single-byte alphanumeric characters for the e-mail addresses. You cannot enter more than 32 characters on the configuration menu. When setting from Web Control, you can enter more than 32 characters.
Setting a Notification Event	You can select the problems or warnings to be notified about by e-mail. When the selected problem or warning occurs in the projector, an e-mail is sent to the specified Email Address notifying that a problem or warning has occurred. You can select multiple items from the displayed items.

Others Menu



Sub Menu	Function
Trap IP Address 1/Trap IP Address 2	<p>You can register up to two for the SNMP trap notification destination.</p> <p>You can input a number from 0 to 255 in each field of the address.</p> <p>However, the following IP addresses cannot be used.</p> <p>127.x.x.x, 224.0.0.0 to 255.255.255.255 (where x is a number from 0 to 255)</p> <p>To use SNMP to monitor the projector, you need to install the SNMP manager program on your computer. SNMP should be managed by a network administrator.</p>
Priority gateway	<p>For the priority gateway, select either Wireless LAN or Wired LAN.</p>
AMX Device Discovery	<p>When the projector is connected to a network, set this to On to allow the projector to be detected by AMX Device Discovery. Set this to Off if you are not connected to an environment controlled with a controller from AMX or AMX Device Discovery.</p>

Reset Menu

Resets all of the network settings.

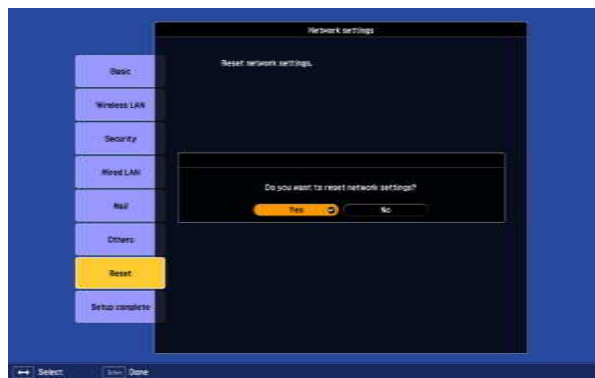

Sub Menu	Function
Reset network settings.	To reset all of the network settings, select Yes . After you reset all the settings, the Basic menu appears.

Info Menu (Display Only)



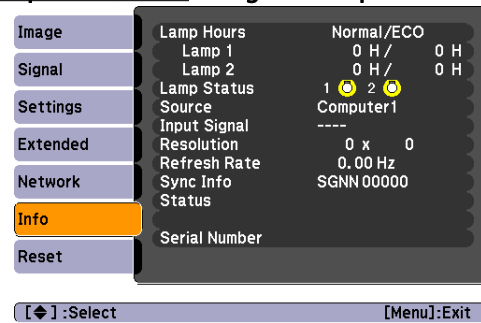

Lets you check the status of the image signals being projected and the status of the projector. Items that can be displayed vary depending on the image signal being projected as shown in the following screen shots.

Analog RGB/Digital RGB/ Component Video/S-Video/Digital Component Video

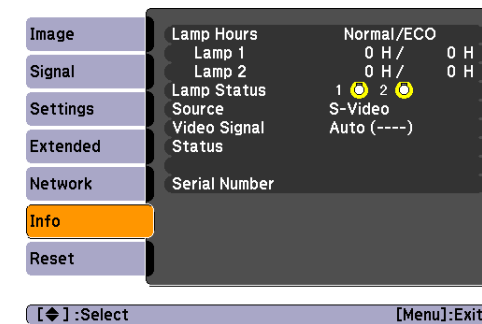

Composite video/S-Video



Sub Menu	Function
Lamp Hours	You can display the cumulative lamp operating time*. When it reaches the lamp warning time, the characters are displayed in yellow.
Lamp Status	The following icons show the status of the lamps.  : Lighted  : Disable When  is displayed, the lamp is not operating normally. See "Reading the Indicators".  p.71
Source	You can display the Source name for the connected equipment currently being projected.
Input Signal	You can display the content of Input Signal set in the Signal menu according to the Source.
Resolution	You can display the Resolution.
Video Signal	You can display the content of Video Signal set in the Signal menu.
Refresh Rate	You can display the Refresh Rate .
Sync Info	You can display the image signal Info. This information may be needed if service is required.
Status	This is Info about errors that have occurred on the projector. This information may be needed if service is required.

Sub Menu	Function
Serial Number	Displays the projector's serial number.

* The cumulative use time is displayed as "0H" for the first 10 hours. 10 hours and above is displayed as "10H", "11H", and so on.

Reset Menu

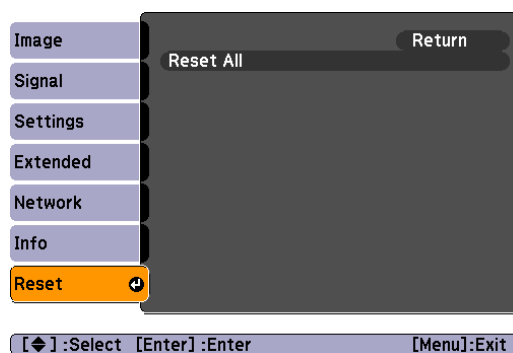

Sub Menu	Function
Reset All	You can reset all items in the configuration menu to their default settings. The following items are not reset to their defaults: Input Signal, User's Logo, Multi-screen, all items for Network menus, Lamp Hours, and Language.



Troubleshooting

This chapter explains how to identify problems and what to do if a problem is found.

If a problem occurs with the projector, the Help screen is displayed to assist you by pressing the [Help] button. You can solve problems by answering the questions.

Procedure

1 Press the [Help] button.

The Help screen is displayed.

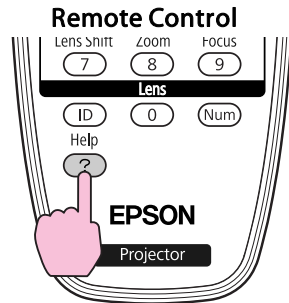

2 Select a menu item.

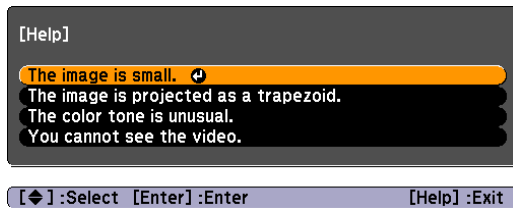

Remote Control

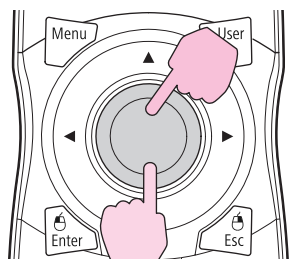

3 Confirm the selection.

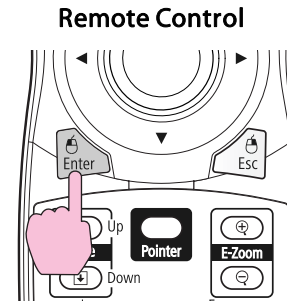

Questions and solutions are displayed as shown on the screen below. Press the [Help] button to exit Help.

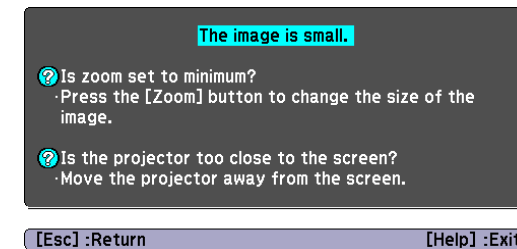

If the Help screen does not provide a solution to the problem, refer to "Problem Solving" p.71.

If you are having a problem with the projector, first check the projector's indicators and refer to "Reading the Indicators" below.



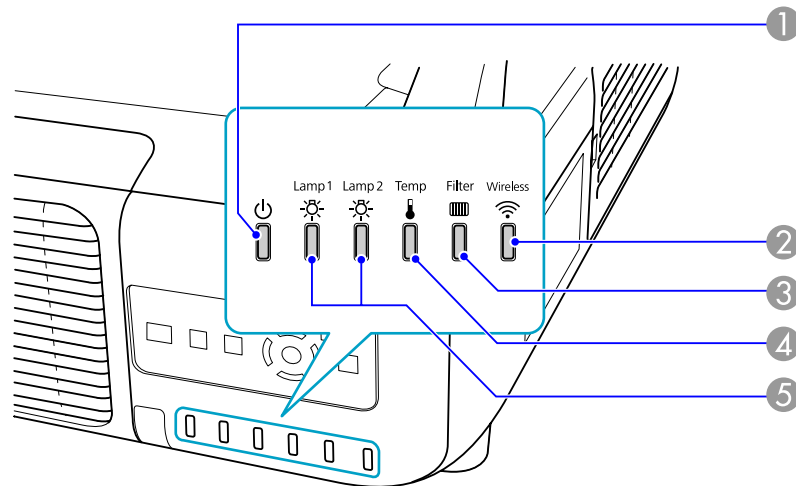

If the indicators do not show clearly what the problem might be, refer to "When the Indicators Provide No Help". [p.75](#)

Reading the Indicators

These indicators indicate the operating status of the projector.



① Indicates the operating status.

-  Standby condition
When the [⏻] button is pressed in this condition, projection starts.
-  Preparing network monitoring (maximum approx. 20 minutes) or cool down in progress
Buttons are disabled while the indicator is flashing.
-  Warming up
Warm-up time is about 30 seconds. After warm-up is complete, the indicator stops flashing.
[⏻] button does not function during warm-up.
-  Projecting

② Indicates the operating status of wireless LAN when the optional wireless LAN unit is connected. (EB-Z8050W only)

③ Indicates the air filter status.

















































④ Indicates the internal temperature status.



























5 Indicates the projection lamp status.

Refer to the following table to see what the indicators mean and how to remedy problems that they indicate. If all indicators are off, check that the power cable is connected correctly and that the power is being supplied normally. Sometimes, when the power cable is unplugged, the  indicator remains lit for a short period, but this is not a fault.

Indicator is lit or flashing red



































 : Lit  : Flashing:  : Off

Status	Cause	Remedy or Status
         	Internal Error	Stop using the projector, disconnect the power cable from the electrical outlet, and contact your local dealer or the nearest address provided in the Support and Service Guide.  Epson Projector Contact List
         	Fan Error Sensor Error Cool System Error	Stop using the projector, disconnect the power cable from the electrical outlet, and contact your local dealer or the nearest address provided in the Support and Service Guide.  Epson Projector Contact List
         	High Temp Error (overheating)	<p>The lamp turns off automatically and projection stops. Wait for about five minutes. After about five minutes the projector switches to standby mode, so check the following two points.</p> <ul style="list-style-type: none"> • Check that the air filter and air exhaust vent are clear, and that the projector is not positioned against a wall. • If the air filter is clogged, clean or replace it.  p.85, p.92 <p>If the error continues after checking the points above, stop using the projector, disconnect the power cable from the electrical outlet, and contact your local dealer or the nearest address provided in the Support and Service Guide.  Epson Projector Contact List</p> <p>When using at an altitude of 1500 m or more, set High Altitude Mode to On.  p.49</p> <p>Set Direction to Pointing Down or Pointing Up when the projector is installed to project downward or upward.  p.49</p>
         	Lamp Error Lamp Failure	<p>Check the following two points.</p> <ul style="list-style-type: none"> • Take out the both lamps and check if they are cracked.  p.89 • Clean the air filter.  p.85 <p>If it is not cracked: Re-fit the lamp and turn on the power.</p> <p>If the error continues: Replace the lamp with a new lamp and turn on the power.</p> <p>If the error continues: Stop using the projector, disconnect the power cable from the electrical outlet, and contact your local dealer or the nearest address provided in the Support and Service Guide.  Epson Projector Contact List</p>

Status	Cause	Remedy or Status
		<p>If it is cracked: Replace it with a new lamp, or contact your local dealer for further advice. If replacing the lamp yourself, be careful to avoid pieces of broken glass (you cannot continue projecting until the lamp is replaced).  Epson Projector Contact List</p> <p>When using at an altitude of 1500 m or more, set High Altitude Mode to On.  p.49</p> <p>Set Direction to Pointing Down or Pointing Up when the projector is installed to project downward or upward.  p.49</p>
          	Filter Airflow Error	<p>Check the following two points.</p> <ul style="list-style-type: none"> • Check that the air filter and air exhaust vent are clear, and that the projector is not positioned against a wall. • If the air filter is clogged, clean or replace it.  p.85, p.92 <p>If the error continues after checking the points above, stop using the projector, disconnect the power cable from the electrical outlet, and contact your local dealer or the nearest address provided in the Support and Service Guide.  Epson Projector Contact List</p>
         	Auto Iris Error Cinema filter error Shutter Error Power Err. (Ballast)	<p>Stop using the projector, disconnect the power cable from the electrical outlet, and contact your local dealer or the nearest address provided in the Support and Service Guide.  Epson Projector Contact List</p>

Indicator is flashing or lit

 : Lit
  : Flashing
  : Off
  : Varies according to the projector status

Status	Cause	Remedy or Status
         	High Temp Warning	<p>(This is not an abnormality. However, if the temperature rises too high again, projection stops automatically.)</p> <ul style="list-style-type: none"> • Check that the air filter and air exhaust vent are clear, and that the projector is not positioned against a wall. • If the air filter is clogged, clean or replace it.  p.85, p.92
         	Replace Lamp	<p>The lamp indicated by flashing indicator, lamp 1 or 2, is due for replacement. Replace it with a new lamp.  p.89</p> <p>If you continue to use the lamp after the replacement period has passed, the possibility that the lamp may explode increases. Replace it with a new lamp as soon as possible.</p> <p>We recommend replacing both lamps together to maintain consistent hue and brightness of projected images.</p>
         	Lamp Warning Supply System Warning (Ballast)	<p>Check the following two points.</p> <ul style="list-style-type: none"> • Remove the lamp indicated by the flashing indicator, lamp 1 or 2, and check if it is cracked.  p.89 • Clean the air filter.  p.85

Status	Cause	Remedy or Status
		<p>If it is not cracked: Re-fit the lamp and turn on the power.</p> <p>If the error continues: Replace the lamp with a new lamp and turn on the power.</p> <p>If the error continues: Stop using the projector, disconnect the power cable from the electrical outlet, and contact your local dealer or the nearest address provided in the Support and Service Guide. Epson Projector Contact List</p> <p>If it is cracked: Replace it with a new lamp, or contact your local dealer for further advice. (Only one lamp is working. Replace the burned-out lamp as soon as possible.) Epson Projector Contact List</p> <p>If replacing the lamp yourself, be careful to avoid pieces of broken glass.</p> <p>When using at an altitude of 1500 m or more, set High Altitude Mode to On. p.49</p> <p>Set Direction to Pointing Down or Pointing Up when the projector is installed to project downward or upward. p.49</p>
 	No Air Filter Air Flow Sensor Err.	<p>Check that the air filter is securely installed. p.92</p> <p>The projector automatically turns off about one minute after it detects that there is no air filter.</p> <p>If the error continues even though an air filter is installed, the air filter sensor may be defective. Stop using the projector, disconnect the power cable from the electrical outlet, and contact your local dealer or the nearest address provided in the Support and Service Guide. Epson Projector Contact List</p>
 	Low Air Flow	<p>(This is not an abnormality. However, projection stops automatically if the airflow falls any further.)</p> <p>The message "The air filter is clogged. Clean or replace the air filter." is displayed. Check the following two points.</p> <ul style="list-style-type: none"> • Check that the air filter and air exhaust vent are clear, and that the projector is not positioned against a wall. • If the air filter is clogged, clean or replace it. p.85, p.92 <p>If the Low Air Flow continues to be low after cleaning the air filter, replace the air filter with a new one. p.92</p> <p>If the error continues after checking the points above, stop using the projector, disconnect the power cable from the electrical outlet, and contact your local dealer or the nearest address provided in the Support and Service Guide. Epson Projector Contact List</p>
 	Air Filter Notice	<p>"Time to clean the air filter. Clean or replace the air filter." is displayed. Clean the air filter. p.85</p> <p>If the air filter is stained yellow with tobacco smoke and cannot be cleaned, replace it with a new one.</p> <p>The indicators or messages regarding "Air Filter Notice" are displayed only when Air Filter Notice is set to On, on the configuration menu's Extended menu. p.49</p>



- If the projector is not operating properly, even though the indicators are all showing normal, refer to "When the Indicators Provide No Help". [p.75](#)
- If the error is not indicated in this table, Stop using the projector, disconnect the power cable from the electrical outlet, and contact your local dealer or the nearest address provided in the Support and Service Guide. [Epson Projector Contact List](#)

When the Indicators Provide No Help

If any of the following problems occur and the indicators do not offer a solution, refer to the pages given for each problem.

Problems relating to images

- "No images appear" 🖱️ p.76
Projection does not start, the projection area is completely black, the projection area is completely blue, and so on.
- "Moving images are not displayed" 🖱️ p.76
Moving images being projected from a computer appear black and nothing is projected.
- "Projection stops automatically" 🖱️ p.76
- "The message "Not supported" is displayed." 🖱️ p.77
- ""No Signal" is displayed." 🖱️ p.77
- "Images are fuzzy or out of focus" 🖱️ p.77
- "Interference or distortion appear in images" 🖱️ p.78
Problems such as interference, distortion, or black & white checked patterns appear.
- "The image is truncated (large) or small, or the aspect is not suitable" 🖱️ p.78
Only part of the image is displayed, or the height and width ratios of the image are not correct, and so on.
- "Image colors are not right" 🖱️ p.79
The whole image appears purplish or greenish, images are black & white, colors appear dull, and so on...(Computer monitors and LCD screens have different color reproduction performance, so that the colors projected by the projector and the colors appearing on the monitor may not necessarily match, but this is not a sign of a problem.)
- "Images appear dark" 🖱️ p.79

Problems when projection starts

- "No power supplied" 🖱️ p.80

Other problems

- "The Remote Control does not work" 🖱️ p.81
- "Nothing appears on the external monitor" 🖱️ p.81
- "I want to change the language for messages and menus" 🖱️ p.81
- "Mail is not received even if a problem occurs in the projector" 🖱️ p.82

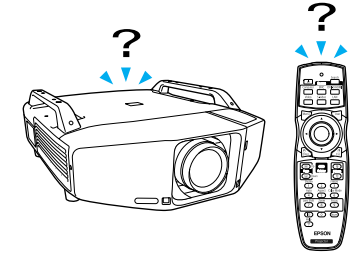

Problems relating to images

No images appear

Check	Remedy
Did you press the [⏻] button?	Press the [⏻] button to turn the power on.
Are the indicators switched off?	The power cable is not connected correctly or power is not being supplied normally. Connect the projector's power cable correctly. 🖱 Quick Start Guide Check that your electrical outlet or power source is functioning correctly.
Is Shutter active?	Press the [Shutter] button on the Remote Control to cancel Shutter. 🖱 p.24
Are the configuration menu settings correct?	Reset All of the settings. 🖱 Reset Menu - Reset All p.68
Is the projected image completely black? Only when projecting computer images	Some input images, such as screen savers, may be completely black.
Is the image signal format setting correct? Only when projecting images from a video source	Change the setting according to the signal for the connected equipment. 🖱 Signal Menu - Video Signal p.46

Moving images are not displayed

Check	Remedy
Is the computer's image signal being output to the LCD and the monitor? Only when projecting images from a laptop computer or a computer with a built-in LCD screen	Change the image signal to external output only. 🖱 Check your computer's documentation.

Projection stops automatically

Check	Remedy
Is Sleep Mode set to On ?	Press the [⏻] button to turn the power on. If you do not want to use Sleep Mode, change the setting to Off . 🖱 Extended Menu - Operation - Sleep Mode p.49
Is the air filter installed?	Check that the air filter is securely installed. 🖱 p.92 The projector automatically turns off about one minute after it detects that there is no air filter.

The message "Not supported" is displayed.

Check	Remedy
Is the image signal format setting correct? Only when projecting images from a video source	Change the setting according to the signal for the connected equipment. 🖱️ Signal Menu - Video Signal p.46
Do the image signal Resolution and the Refresh Rate correspond to the mode? Only when projecting computer images	Refer to the computer's documentation for how to change the image signal Resolution and the Refresh Rate output from the computer. 🖱️ "Supported Monitor Displays" p.114

"No Signal" is displayed.

Check	Remedy
Are the cables connected correctly?	Check that all the cables required for projection are securely connected. 🖱️ Quick Start Guide
Is the correct input port selected?	Change the image by pressing the [Source Search] button on the Remote Control or the Control panel. 🖱️ p.21
Is the power for the computer or video source turned on?	Turn the power on for the equipment.
Are the image signals being output to the projector? Only when projecting images from a laptop computer or a computer with a built-in LCD screen	If the image signals are only being output to the computer's LCD monitor or to the accessory monitor, you need to change the output to an external destination as well as the computer's own monitor. For some computer models, when the image signals are output externally, they no longer appear on the LCD monitor or accessory monitor. 🖱️ Computer's documentation, under a title such as "External output" or "Connecting an external monitor". If the connection is made while the power of the projector or computer is already turned on, the function [Fn] key that changes the computer's image signal to external output may not work. Turn the power for the computer and the projector off and then back on again.

Images are fuzzy or out of focus

Check	Remedy
Is the focus adjusted correctly?	Press the [Focus] button on the remote control to adjust the focus. 🖱️ Quick Start Guide
Is the projector at the correct distance?	Is it projecting outside of the recommended projection distance range? Setup within the recommended range. 🖱️ p.103
Is the Keystone adjustment value too large?	Lower the projection angle to reduce the amount of keystone correction. 🖱️ Quick Start Guide

Check	Remedy
Has condensation formed on the lens?	If the projector is suddenly taken from a cold environment to a warm environment, or if sudden ambient temperature changes occur, condensation may form on the surface of the lens, and this may cause the images to appear fuzzy. Set the projector up in the room about one hour before it is used. If condensation forms on the lens, turn the projector off and wait for the condensation to disappear.

Interference or distortion appear in images

Check	Remedy
Is the image signal format setting correct? Only when projecting images from a video source	Change the setting according to the signal for the connected equipment. 🖱️ Signal Menu - Video Signal p.46
Are the cables connected correctly?	Check that all the cables required for projection are securely connected. 🖱️ Quick Start Guide
Is an extension cable being used?	If an extension cable is used, electrical interference may affect the signals. Use the cables supplied with the projector to check if the cables you are using may be causing the problem.
Is the correct resolution selected? Only when projecting computer images	Set the computer so that the signals being output are compatible with the projector. 🖱️ "Supported Monitor Displays" p.114 🖱️ Computer documentation
Are the "Sync.▶▶" and "Tracking▶▶" settings adjusted correctly? Only when projecting computer images	Press the [Auto] button on the Remote Control or the [Enter] button on the Control panel to perform automatic adjustment. If the images are not adjusted correctly after using automatic adjustment, you can make the adjustments using Sync. and Tracking from the configuration menu. 🖱️ Signal Menu - Tracking, Sync. p.46

The image is truncated (large) or small, or the aspect is not suitable

Check	Remedy
Is the aspect adjusted correctly?	Press the [Aspect] button on the Remote Control to select an aspect suitable for the input source. 🖱️ p.25
Is a wide panel computer image being projected? Only when projecting computer images	Change the setting according to the signal for the connected equipment. 🖱️ Signal Menu - Resolution p.46
Is the image still being enlarged by E-Zoom?	Press the [ESC] button on the Remote Control to cancel E-Zoom. 🖱️ p.31
Is Position adjusted correctly?	Press the [Auto] button on the Remote Control or the [Enter] button on the Control panel to perform automatic adjustment when the computer image is projected. If the images are not adjusted correctly after using automatic adjustment, you can make the adjustments using Position from the configuration menu. Apart from computer image signals, you can adjust other signals while projecting by adjusting Position from the configuration menu. 🖱️ Signal Menu - Position p.46

















Check	Remedy
Is the computer set for dual display? Only when projecting computer images	If dual display is activated in the "Display Properties" of the computer's Control panel, only about half of the image on the computer screen is projected. To display the entire image on the computer screen, turn off the dual display setting.  Computer video driver documentation
Is the correct resolution selected? Only when projecting computer images	Set the computer so that the signals being output are compatible with the projector.  "Supported Monitor Displays" p.114  Computer documentation

Image colors are not right

Check	Remedy
Do the input signal settings match the signals from the connected device?	Change the following settings according to the signal for the connected equipment. When image is from a device connected to the Computer or BNC input port  Signal menu - Input Signal p.46 When image is from a device connected to the Video or S-Video input port  Signal menu - Video Signal p.46
Is the image Brightness set correctly?	Adjust the Brightness setting from the configuration menu.  Image Menu - Brightness p.44
Are the cables connected correctly?	Check that all the cables required for projection are securely connected.  <i>Quick Start Guide</i>
Is Contrast  adjusted correctly?	Adjust the Contrast setting from the configuration menu.  Image Menu - Contrast p.44
Is the Color Adjustment correctly?	Adjust the Color Adjustment setting from the configuration menu.  Image Menu - Color Adjustment p.44
Are the Color Saturation and Tint adjusted correctly? Only when projecting images from a video source	Adjust the Color Saturation and Tint settings from the configuration menu.  Image Menu - Color Saturation, Tint p.44

Images appear dark

Check	Remedy
Is the image Brightness set correctly?	Adjust the Brightness and Power Consumption settings from the configuration menu.  Image Menu - Brightness p.44  Settings Menu - Power Consumption p.48
Is Contrast  adjusted correctly?	Adjust the Contrast setting from the configuration menu.  Image Menu - Contrast p.44
Is the lamp due for replacement?	When the lamp is nearly ready for replacement, the images become darker and the color quality becomes poorer. When this happens, replace the lamp with a new lamp.  p.89







Problems when projection starts

No power supplied

Check	Remedy
Did you press the [⏻] button?	Press the [⏻] button to turn the power on.
Are the indicators switched off?	The power cable is not connected correctly or power is not being supplied normally. Disconnect and then reconnect the power cable. 🖱 Quick Start Guide Check that your electrical outlet or power source is functioning correctly.
Do the indicators turn on and off when the power cable is touched?	There is probably a poor contact in the power cable, or the power cable may be defective. Reinsert the power cable. If this does not solve the problem, stop using the projector, disconnect the power cable from the electrical outlet, and contact your local dealer or the nearest address provided in the Support and Service Guide. 🖱 Epson Projector Contact List
Is the Control Panel Lock set to Full Lock ?	Press the [⏻] button on the Remote Control. If you do not want to use Control Panel Lock, change the setting to Off . 🖱 Settings Menu - Control Panel Lock p.39
Is the correct setting for the remote receiver selected?	Check the Remote Receiver from the configuration menu. 🖱 Settings Menu - Remote Receiver p.48
Was the power cable plugged back in or was the breaker turned on immediately after Direct Power Off?	When the operation to the left is performed when Direct Power On is set to On , the power may not turn back on. Press the [⏻] button to turn the power back on.
Is the ID switch on the side of the remote control set to On?	When the switch is set to On, you can use the remote control to operate only a projector with a matching ID. Set ID switch to Off. 🖱 p.32
Are the lamp cover and lamp installed correctly?	If the lamp or lamp cover is installed incorrectly, the projector cannot be turned on. Check how it is installed. 🖱 p.89

Other problems

The Remote Control does not work

Check	Remedy
Is the remote control light-emitting area pointing towards the remote receiver on the projector when it is operated?	Point the remote control towards the Remote Receiver. Operating range  Quick Start Guide
Is the remote control too far from the projector?	The operating range for the remote control is about 15 m.  Quick Start Guide
Is direct sunlight or strong light from fluorescent lamps shining onto the Remote Receiver?	Set the projector up in a location where strong light does not shine onto the remote receiver. Or set the remote receiver to Off from Remote Receiver in the configuration menu.  Settings Menu - Remote Receiver p.48
Is the correct setting for the remote receiver selected?	Check the Remote Receiver from the configuration menu.  Settings Menu - Remote Receiver p.48
Are the batteries dead or have the batteries been inserted correctly?	Make sure the batteries are inserted correctly or replace the batteries with new ones if necessary.  p.88
Are the remote control ID and the projector ID matched?	Make sure the ID for the projector you want to operate and the ID for the remote control match. To operate all projectors by remote control regardless of the ID setting, set the ID switch on the side of the remote control to Off.  p.32
Does Remote Control Type match the remote control that you are using?	Check the Remote Control Type on the configuration menu.  Extended Menu - Operation - Remote Control Type p.49
Is the optional remote control cable connected to the remote control or to the projector's remote port?	When the remote control cable is connected, the remote control light-emitting area or the projector's remote receiver are disabled. When not using the remote control cable set, disconnect it from the remote control and the remote port.



Nothing appears on the external monitor

Check	Remedy
Are images input from a port other than the Computer or BNC input port?	The only images that can be displayed on an external monitor are computer images from the Computer or BNC input ports.  p.106

I want to change the language for messages and menus

Check	Remedy
Change the Language setting.	Adjust the Language setting from the configuration menu.  Extended Menu - Language p.49

Mail is not received even if a problem occurs in the projector

Check	Remedy
Is Standby Mode set to Communication On ?	To use the Mail Notification function when the projector is in standby, set Communication On in Standby Mode from the configuration menu.  Extended Menu - Standby Mode p.49
Did a fatal abnormality occur and the projector come to a sudden stop?	When the projector comes to a sudden stop, e-mail cannot be sent. If the abnormal state continues, contact your local dealer or the nearest address provided in the Support and Service Guide.  Epson Projector Contact List
Is power being supplied to the projector?	Check that your electrical outlet or power source is functioning correctly.
Is Mail function set correctly in the configuration menu?	Mail notification of problems is sent according to the Mail settings in the configuration menu. Check if it is set correctly.  Reset Menu - Mail p.51



Appendix

This chapter provides information on maintenance procedures to ensure the best level of performance from the projector for a long time to come.

The projector can be mounted on a ceiling or placed on a desk as shown below. Also, this projector can project images to various places because it can project images vertically or horizontally at each 90° angle.

Warning

- A special method is required when installing the projector to project images downward (ceiling mount) or upward. If installation work is not carried out correctly, the projector could fall down. This may result in injury or accidents.

Contact your dealer or the nearest address provided in the Support and Service Guide if you want to use this installation method.  [Epson Projector Contact List](#)

- If you use adhesives on the Ceiling mount fixing points to prevent the screws from loosening, or if you use things such as lubricants or oils on the projector, the projector case may crack causing it to fall from its ceiling mount. This could cause serious injury to anyone under the ceiling mount and could damage the projector.

When installing or adjusting the Ceiling mount, do not use adhesives to prevent the screws from loosening and do not use oils or lubricants and so on.

- When mounting the projector on the ceiling, be sure to arrange measures to prevent it from falling such as passing a wire through the handles.

Attention

- Do not install the projector at any angles other than those shown in the following illustrations.
- Do not use the projector upside down.
- Set the Direction properly in the configuration menu according to the angle of installation.  [p.49](#)
- Using the projector at an improper angle or if the configuration menu settings are wrong causes malfunctions and shortens the operating life of optical parts.

- Suspend the projector from the ceiling and project images from in front of a screen.

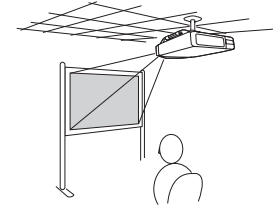

- Suspend the projector from the ceiling and project images from behind a translucent screen.

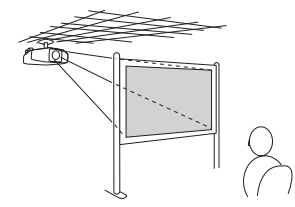

- Project images from in front of a screen.

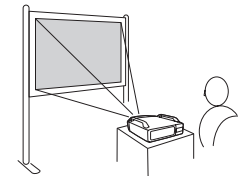

- Project images from behind a translucent screen.

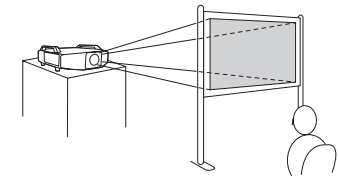

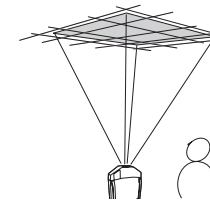

- Project images directly up

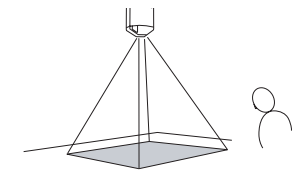

- Project images directly down



- An optional Ceiling mount is required when suspending the projector from a ceiling.  [p.94](#)
- The Projection can be changed from the configuration menu.  [p.49](#)

You should clean the projector if it becomes dirty or if the quality of projected images starts to deteriorate.

Warning

Do not use sprays containing a flammable gas to remove dirt or dust which is adhering to parts such as the lens or filter of the projector. This could be a cause of the fire for the high temperature of lamps inside the unit.

Cleaning the Projector's Surface

Clean the projector's surface by wiping it gently with a soft cloth.

If the projector is particularly dirty, moisten the cloth with water containing a small amount of neutral detergent, and then firmly wring the cloth dry before using it to wipe the projector's surface.

Attention

Do not use volatile substances such as wax, alcohol, or thinner to clean the projector's surface. The quality of the case may change or become discolored.

Cleaning the Lens

Use a commercially available cloth for cleaning glasses to gently wipe the lens.

Attention

Do not rub the lens with harsh materials or subject the lens to shocks, as it can easily become damaged.

Cleaning the Air filter

Clean the air filter and the air intake vent when the following message is displayed or the Filter indicator is flashing green.

"Time to clean the air filter."

"Clean or replace the air filter."

Attention

- If dust collects on the air filter it can cause the internal temperature of the projector to rise, and this can lead to problems with operation and shorten the optical engine's service life. Clean the air filter immediately when the message is displayed.
- If the air filter is stained yellow with tobacco smoke, it cannot be cleaned. In this case, replace it with a new air filter.  p.92
- Do not rinse the air filter in water. Do not use detergents or solvents.
- When using a brush for cleaning, use one with long soft bristles, and brush it lightly. If it is brushed too strongly, dust will be ground into the air filter and cannot be removed.

Procedure

1

After you turn off the projector's power and the confirmation buzzer beeps twice, disconnect the power cable.

2

Remove the air filter cover.

Grip the air filter cover tab between your fingers, and pull up and remove the cover while pressing the tab.

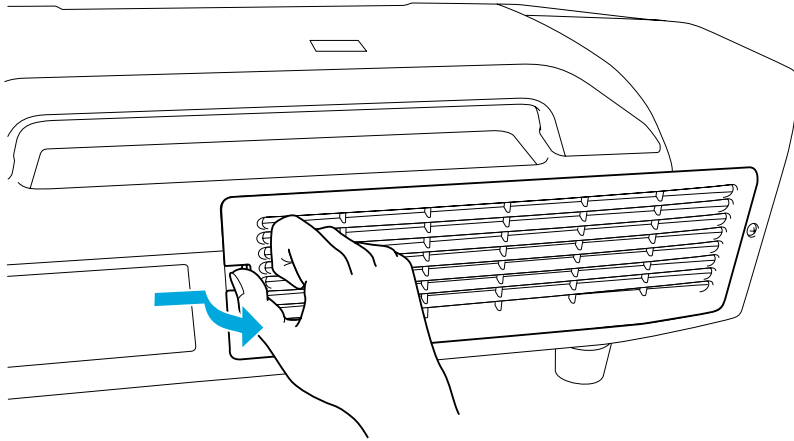

3 Remove the air filter.

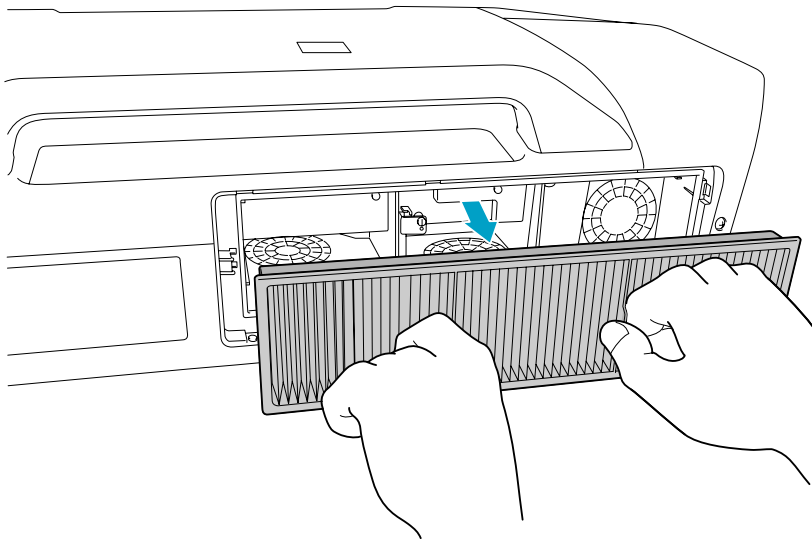

4 With the front (the side with tabs) of the air filter facing down, tap the air filter four or five times to shake off the dust.

Turn it over and tap the other side in the same way.

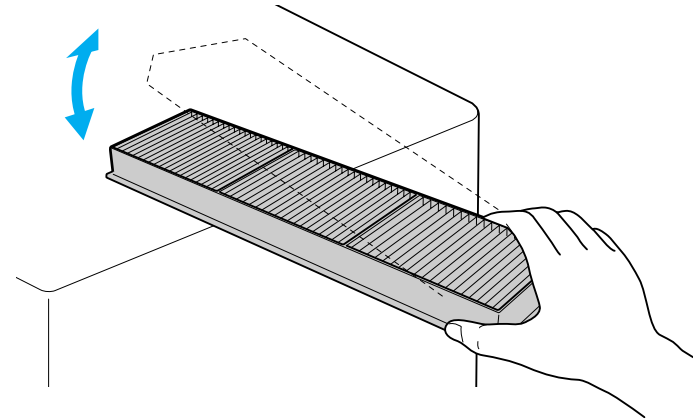

Attention

If the air filter is hit too hard, it may become unusable due to deformities and cracks.

5 Remove any dust remaining on the air filter by using a vacuum cleaner from the front side.

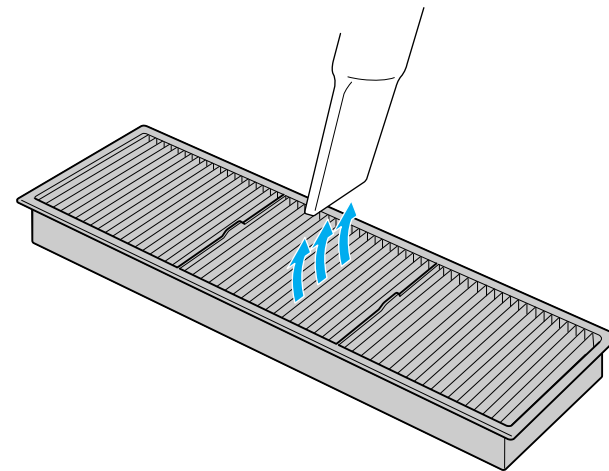

6 Replace the air filter.

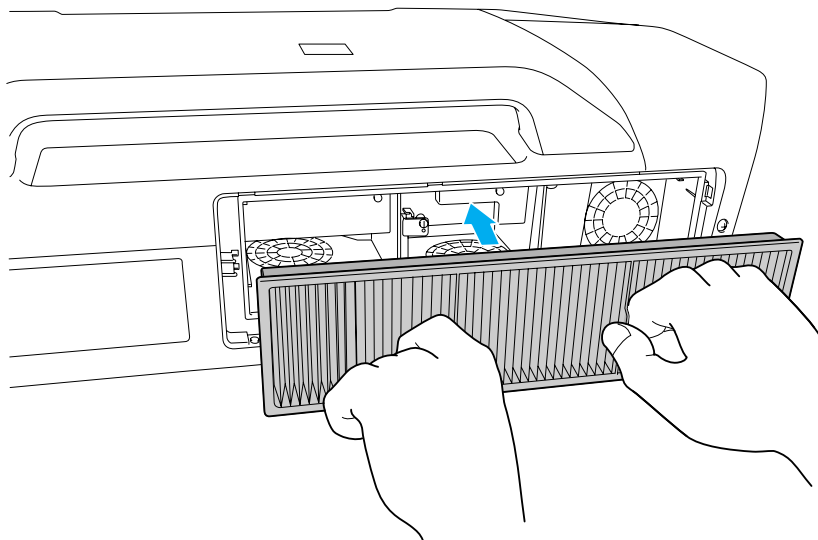

7

Replace the air filter cover.

Press the cover until it clicks into place.

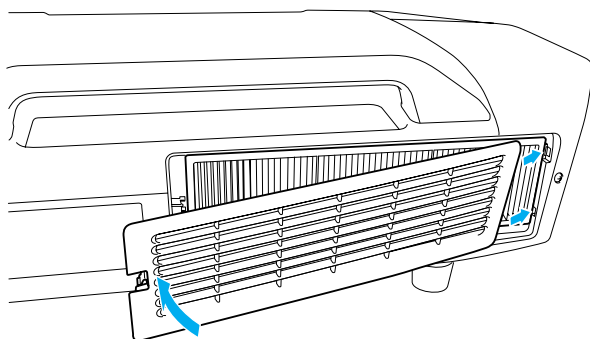

If a message is frequently displayed, even after cleaning, it is time to replace the air filter. Replace it with a new air filter.  [p.92](#)

This section explains how to replace the Remote Control batteries, the lamp, and the air filter.

Replacing the Remote Control Batteries

If delays in the responsiveness of the Remote Control occur or if it does not operate after it has been used for some time, it probably means that the batteries are becoming flat. When this happens, replace them with new batteries. Have two AA size alkaline batteries ready. You cannot use other batteries except for the AA size alkaline.

Attention

Make sure you read the Safety Instructions before handling the batteries. 
[Safety Instructions](#)

Procedure

1 Remove the battery cover.

While pushing the battery compartment cover catch, lift the cover up.

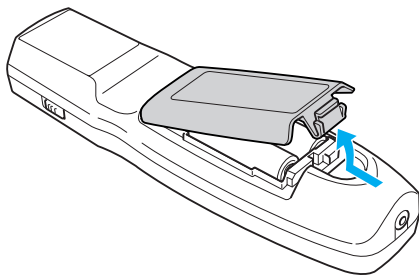

2 Replace the old batteries with new batteries.

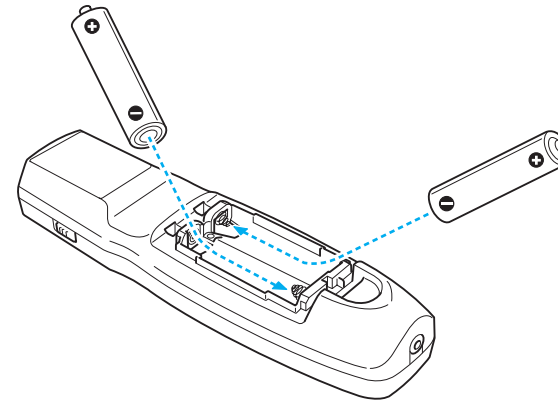

Caution

Check the positions of the (+) and (-) marks inside the battery holder to ensure the batteries are inserted the correct way.

3 Replace the battery cover.

Press the battery compartment cover until it clicks into place.

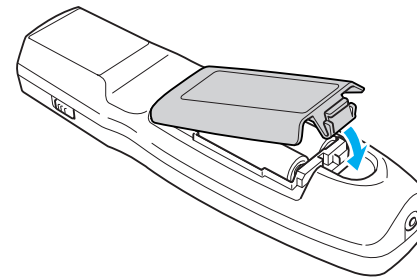

Replacing the Lamp

Lamp replacement period

It is time to replace the lamp when:

- The message "Replace the lamp." is displayed at the lower left of the projection screen when you start projecting.

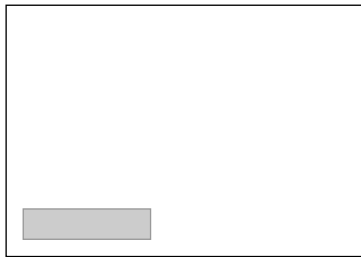

- The lamp indicator flashes orange.
Replace the lamp indicated by the flashing indicator, either lamp 1 or 2.

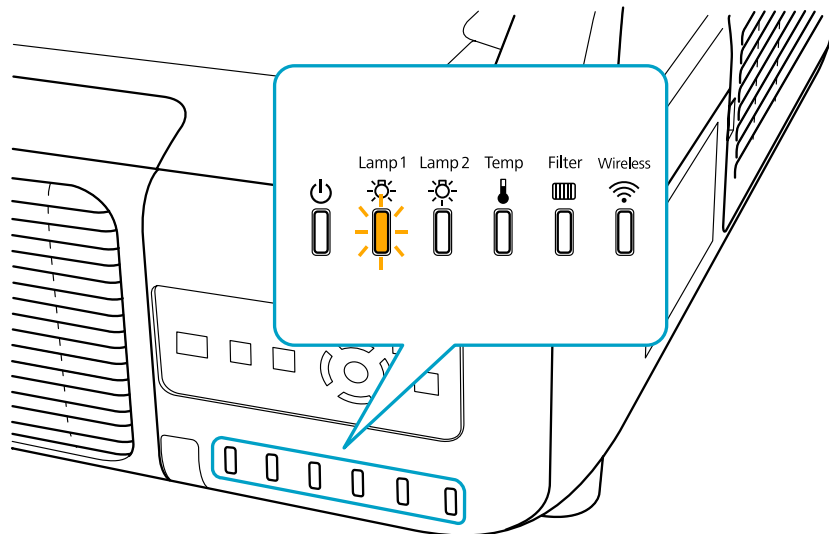

- The projected image gets darker or starts to deteriorate.

Attention

- The lamp replacement message is set to appear after the following time periods in order to maintain the initial brightness and quality of the projected images. [p.48](#)
When using **Power Consumption** continually at Normal: About 2400 hours
When using **Power Consumption** continually at ECO: About 3400 hours
- Do not turn the projector on immediately after turning it off. Turning the projector on and off frequently may shorten the life of the lamps.
- If you continue to use the lamp after the replacement period has passed, the possibility that the lamp may explode increases. When the lamp replacement message appears, replace the lamp with a new one as soon as possible, even if it is still working.
- Depending on the characteristics of the lamp and the way it has been used, the lamp may become darker or stop working before the lamp warning message appears. You should always have two spare lamp units ready in case they are needed.

How to replace the lamp

The lamp can be replaced even when the projector is suspended from a ceiling.

Warning

- When replacing the lamps because they have stopped illuminating, there is a possibility that the lamp may be broken. If replacing the lamp of a projector which has been installed on the ceiling, you should always assume that the lamp is broken, and you should stand to the side of the lamp cover, not underneath it. Remove the lamp cover gently.
- Never disassemble or remodel the lamp. If a remodeled or reassembled lamp is installed into the projector and used, it could cause a fire, electric shock, or an accident.

Caution

Wait until the lamps have cooled down sufficiently before removing the lamp cover. If the lamp is still hot, burns or other injuries may result. It takes about one hour after the power has been turned off for the lamp to be cool enough.

Attention

- Never use the projector unless there are two lamps installed.
- We recommend replacing both lamps together to maintain consistent hue and brightness of projected images.

Procedure

1 After you turn off the projector's power and the confirmation buzzer beeps twice, disconnect the power cable.

2 Wait until the lamps have cooled down sufficiently before removing the lamp cover on the back of the projector.

Pinch the tabs on the front of the lamp cover together to release the lock. When the lock releases, pull the cover straight out.

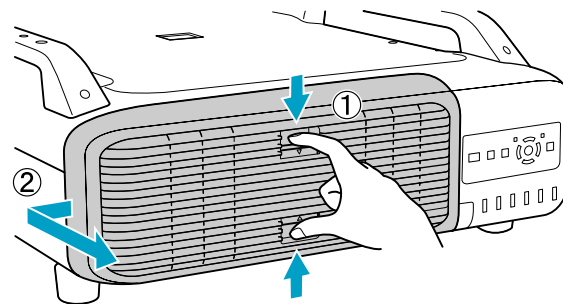

3 Pull up the lock lever for the lamp you want to replace and pull the lamp straight out.

If the lamp is cracked, replace it with a new lamp, or contact your local dealer for further advice. [Epson Projector Contact List](#)

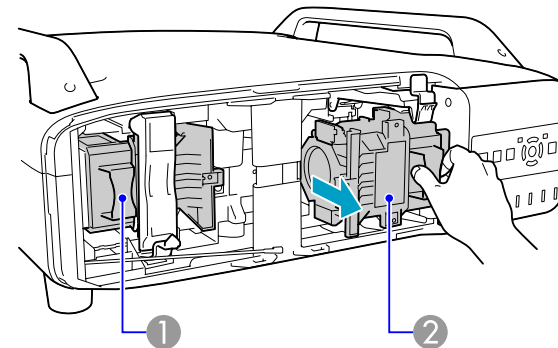
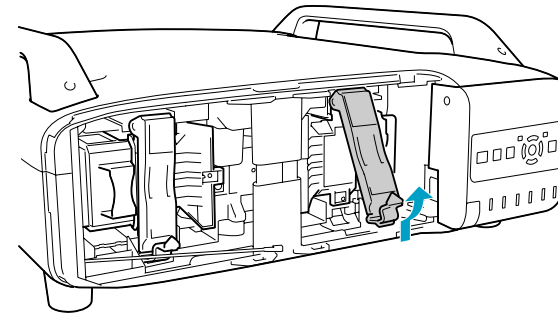

- ① Lamp 1
- ② Lamp 2

4 Install the new lamp.

Insert the new lamp along the guide rail in the correct direction so that it fits in place, push firmly until it is fully inserted, and pull down the lock lever until it clicks into place.

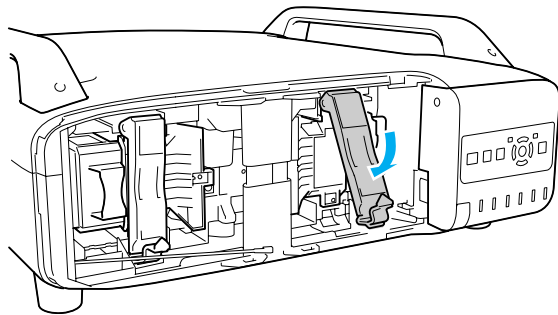
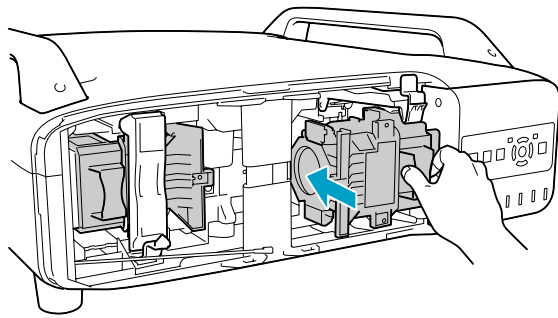

5

Replace the lamp cover.

Press the cover against the unit and slide it to the right until it clicks.

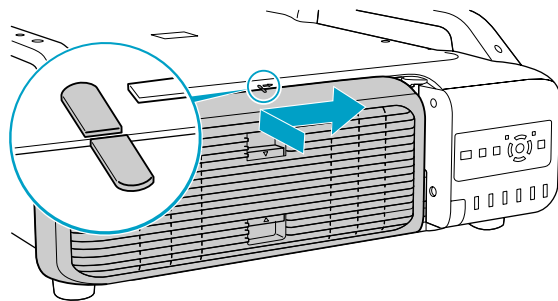

Attention

- Make sure you install the lamp securely. If the lamp cover is removed, the lamp turns off automatically as a safety precaution. If the lamp or the lamp cover is not installed correctly, the lamp does not turn on.
- This product includes a lamp component that contains mercury (Hg). Please consult your local regulations regarding disposal or recycling. Do not dispose of it with normal waste.

Resetting the Lamp Hours

The projector records how long the lamps are turned on and a message and indicator notify you when it is time to replace the lamp. After replacing the lamps and turning on the power, the following message is displayed on the screen and you can reset the lamp-hour counter.

Select **Yes**, and then press the [Enter] button.

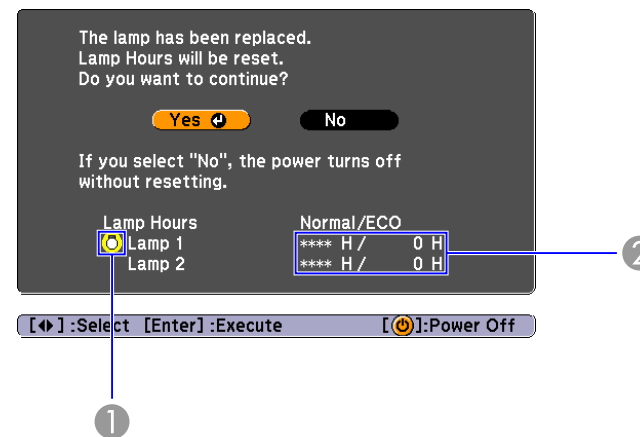

- 1 Displays the replacement for the lamp 1.
- 2 Displays the cumulative lamp operating time. If you select **Yes** and reset the Lamp Hours, the count for lamp 1 is set to 0H.

Replacing the Air Filter

Air filter replacement period

It is time to replace the air filter when:

- The air filter has turned brown.
- The message is displayed even though the air filter has been cleaned.

How to replace the air filter

The air filter can be replaced even when the projector is suspended from a ceiling.

Procedure

- 1** After you turn off the projector's power and the confirmation buzzer beeps twice, disconnect the power cable.
- 2** Remove the air filter cover.
Grip the air filter cover tab between your fingers, and pull up and remove the cover while pressing the tab.

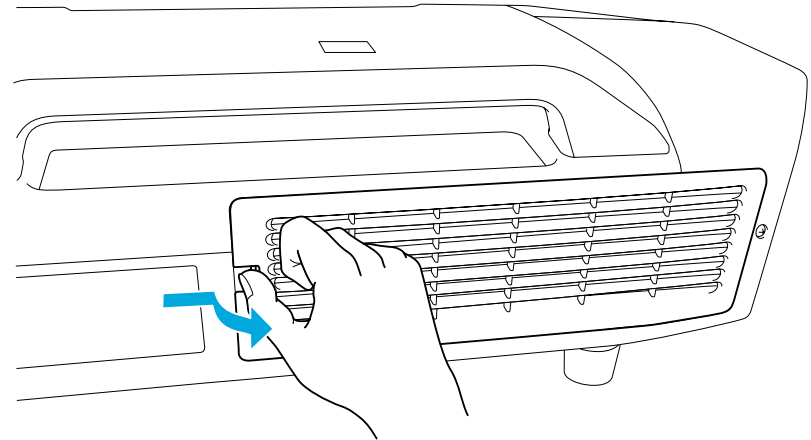

- 3** Remove the air filter.

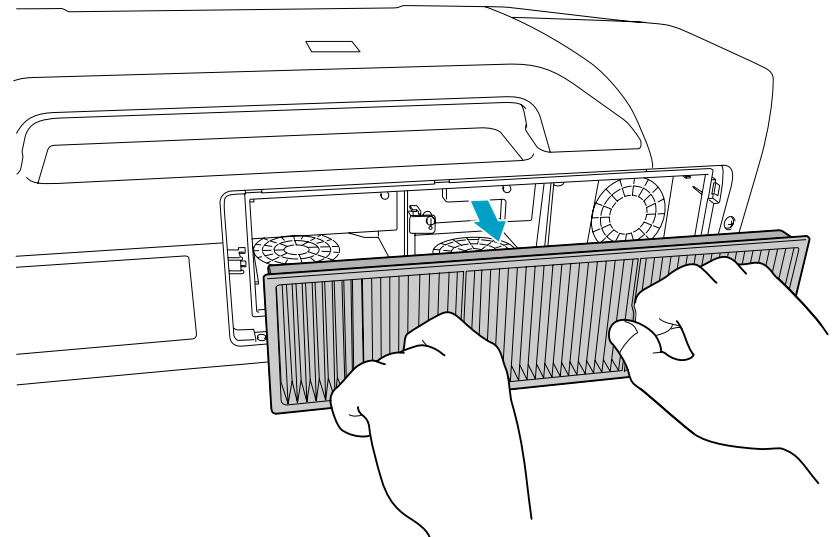

- 4** Install the new air filter.

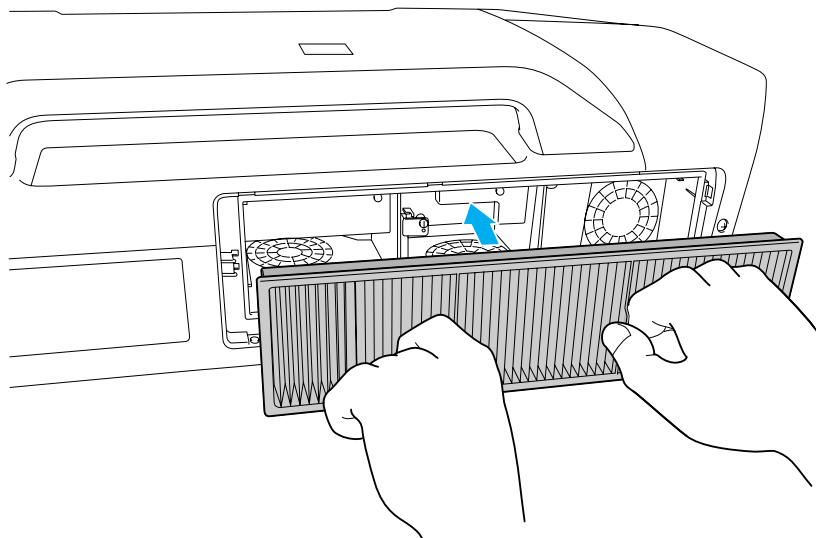

5 Replace the air filter cover.

Press until it clicks into place.

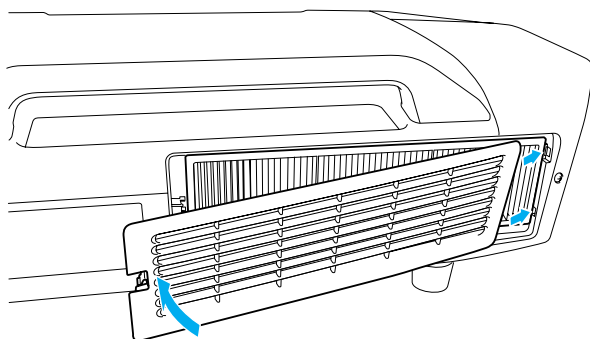

Dispose of used air filters properly in accordance with your local regulations.

Material of the frame part: Polypropylene

Material of the filter part: Polypropylene

The following optional accessories and consumables are available. Please purchase these products as and when needed. The following list of optional accessories and consumables is current as of: 2009.07. Details of accessories are subject to change without notice and availability may vary depending on the country of purchase.

Optional accessories

Computer cable ELPKC02

(1.8 m - for mini D-Sub15-pin/mini D-Sub 15pin)

This is the same as the computer cable supplied with the projector.

Computer cable ELPKC09

(3 m - for mini D-Sub15-pin/mini D-Sub 15pin)

Computer cable ELPKC10

(20 m - for mini D-Sub15-pin/mini D-Sub 15pin)

Use one of these longer cables if the computer cable supplied with the projector is too short.

Component video cable ELPKC19

(3 m - for mini D-Sub 15-pin/RCA male×3)

Use to connect a [Component Video](#) source.

Remote control cable set ELPKC28

(10m 2 piece set)

Use this to guarantee operation from the remote control from a distance.

Wireless mouse receiver ELPST16

Use this to operate a computer's mouse pointer using the projector's remote control, or to operate page Up/Down while projecting a PowerPoint file.

Wireless LAN unit ELPAP03 (for EB-Z8050W)

Use this to project images from a computer via a wireless LAN.

Long focus zoom lens ELPLL07

(Projection distance ratio: a. Approx. 5.76 to 8.09 b. Approx. 5.83 to 8.18)

Medium focus zoom lens ELPLM07

(Projection distance ratio: a. Approx. 3.85 to 5.88 b. Approx. 3.92 to 5.97)

Medium focus zoom lens ELPLM06

(Projection distance ratio: a. Approx. 2.64 to 4.03 b. Approx. 2.68 to 4.10)

Standard focus zoom lens ELPLS04

(Projection distance ratio: a. Approx. 1.71 to 2.78 b. Approx. 1.74 to 2.82)

Short focus wide lens ELPLW04

(Projection distance ratio: a. Approx. 1.29 to 1.77 b. Approx. 1.31 to 1.80)

Wide lens for rear projection ELPLR04

(Projection distance ratio: a. Approx. 0.76 b. Approx. 0.77)

a: EB-Z8050W b: EB-Z8000WU

Projection distance ratio = projection distance/projection screen width

The values are installation standards. They are subject to change depending on projection conditions.

Low ceiling mount* ELPMB25

High ceiling mount* ELPMB26

Use when installing the projector on a ceiling.

* A special method of installation is required to suspend the projector from a ceiling. Contact your dealer or the nearest address provided in the Support and Service Guide if you want to use this installation method.

 [Epson Projector Contact List](#)



Consumables

Replacement lamp unit (two-pack) ELPLP52

Replacement lamp unit (one-pack) ELPLP51

Use as a replacement for used lamps.

Air filter ELPAF23

Use as a replacement for used air filters.

There are many glass parts and precision components inside the projector. To prevent damage due to impacts when transporting, handle the projector as follows.

Moving Nearby

Checking the following points, and then carry carefully by the handles.

- Turn off the power to the projector and disconnect all cables.
- Attach the lens cover to the lens.
- Store the foot.



Caution

*Do not carry the projector by one person.
Two people are needed to unpack or carry the projector.*

When Transporting

Preparing packaging

After checking the points in "Moving Nearby", prepare the following and then pack up the projector.

- Remove the lens unit if an option lens, other than the standard zoom lens, is installed. Attach the standard zoom lens if the projector has a built-in lens. If the projector does not have a lens, attach the cover that was on the lens mount when you purchased the projector.
- The vertical and horizontal lens shifts are positioned in the center.
- Fit the protective lens pad that was used at the time of purchase.

Notes when packing and transporting

Enclose the projector securely in buffer material to protect it from shock, and place it into a strong cardboard container. Be sure to notify the carrier company that the contents are fragile.

You can save the image that is currently being projected as a User's Logo.



When a User's Logo is saved, the previous User's Logo is erased.

Procedure

- 1 Project the image you want to use as the User's Logo, and then press the [Menu] button.

Using the Remote Control

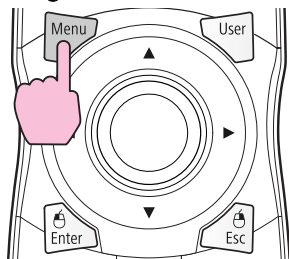

Using the Control panel

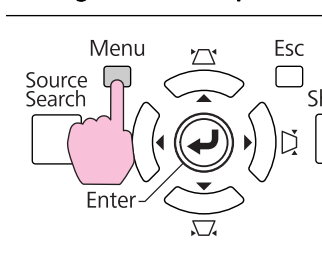

- 2 Select Extended - "User's Logo" from the configuration menu. ➡ ["Using the Configuration Menu"](#)

Check the buttons you can use and the operations they perform in the guide under the menu.

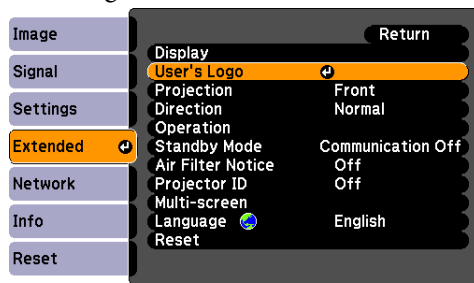

[Esc]:Return [◀]:Select [Enter]:Enter [Menu]:Exit



- If **User's Logo Protect** from **Password Protect** is set to **On**, a message is displayed and the user's logo cannot be changed. You can make changes after setting **User's Logo Protect** to **Off**. ➡ [p.37](#)
- If **User's Logo** is selected when Keystone, E-Zoom, Aspect, or Progressive are being performed, the function currently being performed is cancelled.

- 3 When "Choose this image as the User's Logo?" is displayed, select "Yes".



When you press the [Enter] button on the Remote Control or the Control panel, the screen size may change according to the signal as it changes to the resolution of the image signal.

- 4** Move the box to select the part of the image to use as the User's Logo.

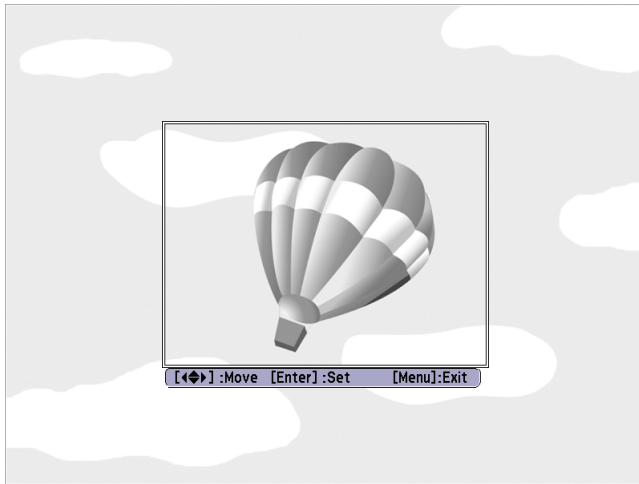

Using the Remote Control

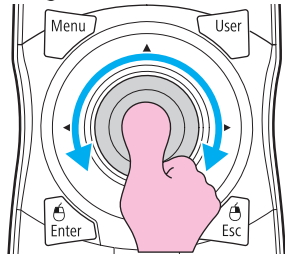

Using the Control panel

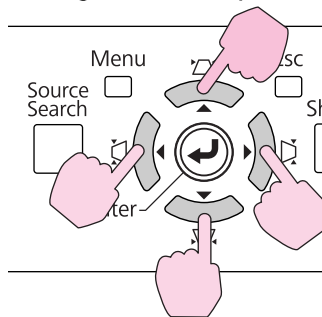

You can save at up to 400 × 300 dots in size.

- 5** When "Select this image?" is displayed, select "Yes".

- 6** Select the zoom factor from the zoom setting screen.

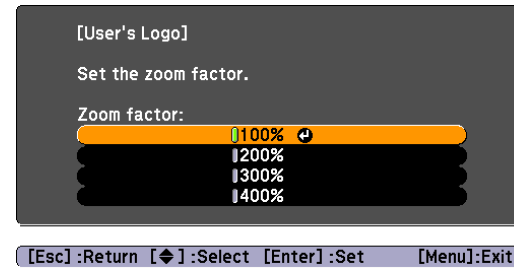

400% is displayed only when using EB-Z8000WU.

- 7** When the message "Save this image as the User's Logo?" is displayed, select "Yes".

The image is saved. After the image has been saved, the message "Completed." is displayed.



- Once a User's Logo has been saved, the logo cannot be returned to the factory default.
- Saving the user's logo may take approximately 15 seconds. Do not use the projector or any connected equipment while it is saving, otherwise malfunctions may occur.

There are two methods for setting WPS.

- Push Button Method
SSID and security are set automatically when the [Enter] button is pressed on the projector's control panel and the dedicated button on the access point equipment. This method is recommended when the projector and access point are close together.
- PIN Code Method
SSID and security are set automatically by inputting an 8-digit code that was assigned to the projector from the computer to the access point in advance. Make connection settings between the computer and the access point in advance. For details on how to make this connection, refer to the manual provided with the access point. This method is recommended when the projector is mounted on the ceiling.

Connection Setup Method

Procedure

- 1 During projection, press the [Menu] button and select Network - "Network Configuration" from the configuration menu.

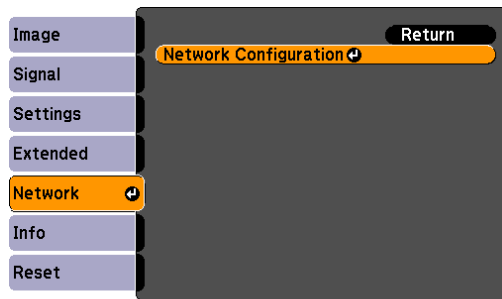

[Esc]:Return [↓]:Select [Enter]:Enter [Menu]:Exit

The Network Configuration screen is displayed.

- 2 From "Wireless LAN" select "To Setup Wizard".



The following screen is displayed.

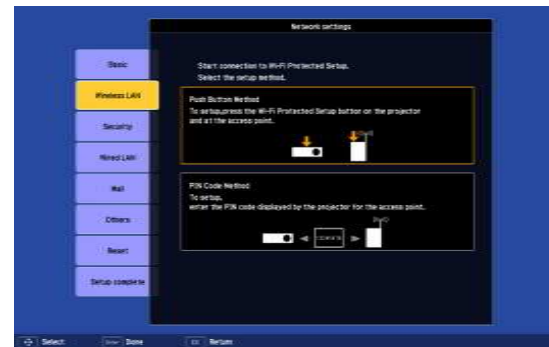

When connecting using the Push Button Method, follow the steps given below.

Go to "Making a connection using the PIN Code Method" when connecting using the "PIN Code Method".  p.101

Making a Connection Using the Push Button Method

Procedure

- 1 Select "Push Button Method".

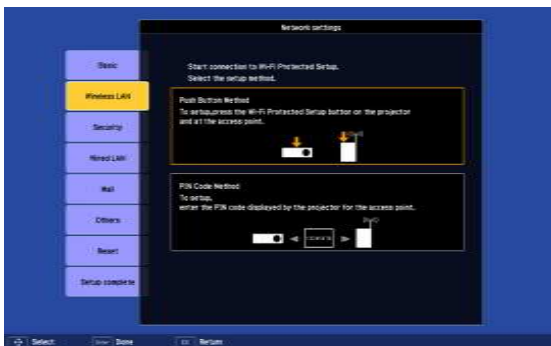

The Push Button Method screen is displayed.

- 2 Press the [Enter] button on the projector's control panel when prompted by the screen.

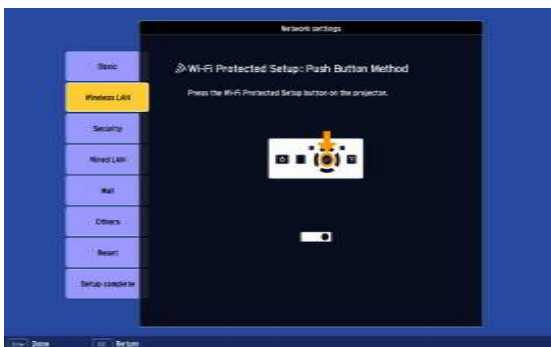

Then, the Push Button Method screen is displayed.

- 3 Press the button on the access point when prompted by the screen.

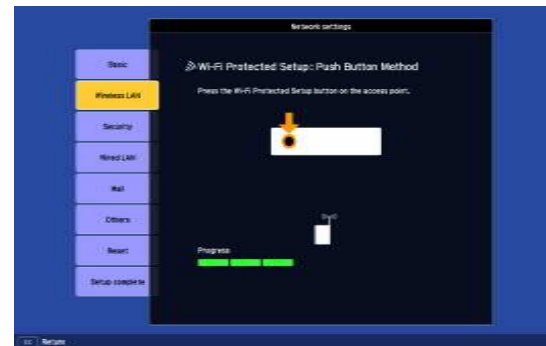

This completes the setup.

- 4 Press the [Enter] button or the [Esc] button.

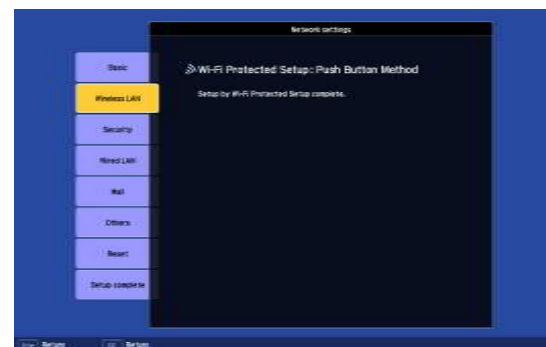

It returns to the Wireless LAN menu screen.

- 5 Select "Yes" from "Setup complete".



This completes the setup of the connection between the projector and the access point. Press the [Menu] button to close the configuration menu.

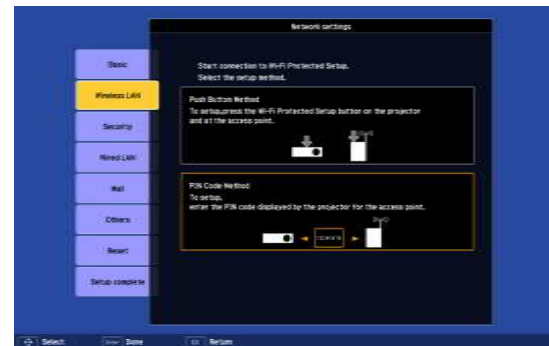

The PIN Code Method screen is displayed.

2

Enter the PIN code displayed on the "PIN Code Method" screen from the computer to the access point, and then select "Start Setup".

Making a connection using the PIN Code Method



Before you can make a connection using the "PIN Code Method", a connection must have already been setup between the computer and the access point.

Procedure

1

Select "PIN Code Method".



The progress is displayed.

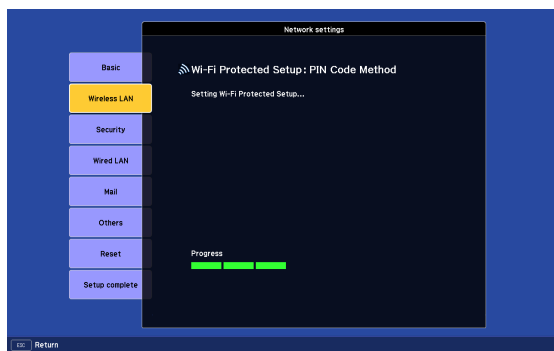

3 The message "Setup by Wi-Fi Protected Setup complete." is displayed. Press the [Enter] button or the [Esc] button.

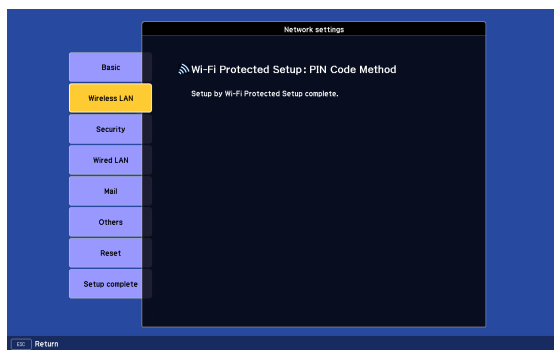

It returns to the **Wireless LAN** menu screen.

4 Select "Yes" from "Setup complete".

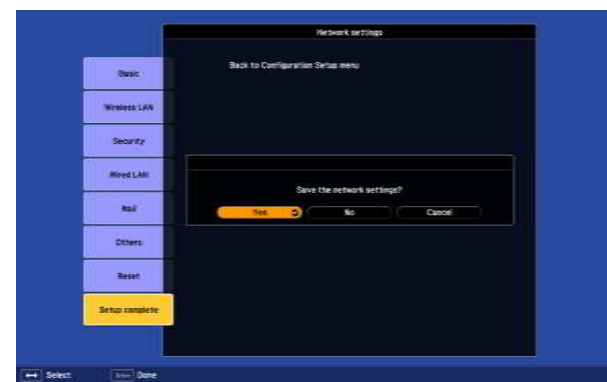

This completes the setup of the connection between the projector and the access point. Press the [Menu] button to close the configuration menu.

The following table shows the projection distance when a standard zoom lens is attached. When an optional lens is attached, check the projection distances in the User's Guide supplied with optional lenses. To find the appropriate screen size, see the following table to set up the projector. Values are just reference.

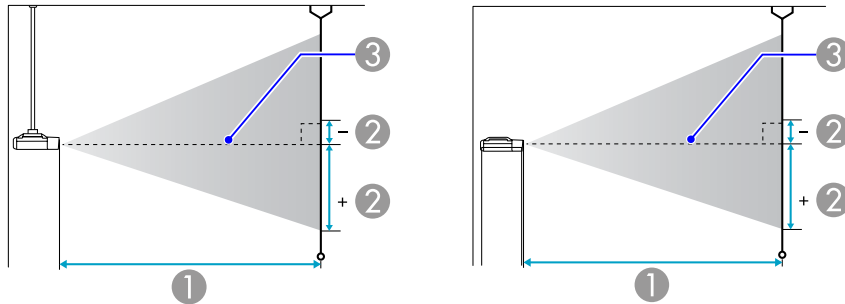

- ① Projection distance
- ② is the distance from the center of the lens to the base of the screen. This changes depending on the setting for vertical lens shift.
- ③ Center of lens

Projection Distance of EB-Z8000WU

Units: cm

4:3 Screen Size		①	②
		Minimum (Wide) to Maximum (Tele)	Vertical lens shift Top to Bottom
60"	120x90	251 - 410	-19 - 111
80"	160x120	338 - 549	-26 - 148
100"	200x150	424 - 688	-32 - 185
120"	240x180	510 - 828	-39 - 221
150"	300x230	640 - 1036	-48 - 277
200"	410x300	856 - 1384	-64 - 369

4:3 Screen Size		①	②
		Minimum (Wide) to Maximum (Tele)	Vertical lens shift Top to Bottom
300"	610x460	1288 - 2081	-97 - 554
440"	890x670	1898 - 3062	-142 - 814

Units: cm

16:9 Screen Size		①	②
		Minimum (Wide) to Maximum (Tele)	Vertical lens shift Top to Bottom
60"	130x75	227 - 371	-22 - 96
80"	180x100	306 - 498	-29 - 129
100"	220x120	384 - 624	-36 - 161
120"	270x150	463 - 751	-43 - 193
150"	330x190	580 - 940	-54 - 241
200"	440x250	777 - 1256	-72 - 321
300"	660x370	1169 - 1888	-108 - 482
485"	1070x600	1899 - 3064	-176 - 781

Units: cm

16:10 Screen Size		①	②
		Minimum (Wide) to Maximum (Tele)	Vertical lens shift Top to Bottom
60"	130x81	221 - 361	-17 - 98
80"	180x110	297 - 484	-23 - 130
100"	220x130	374 - 607	-28 - 163
120"	270x169	450 - 730	-34 - 196
150"	330x206	564 - 915	-43 - 245

16:10 Screen Size		①	②
		Minimum (Wide) to Maximum (Tele)	Vertical lens shift Top to Bottom
200"	440x275	755 - 1222	-57 - 326
300"	550x344	1137 - 1837	-85 - 489
500"	1100x688	1900 - 3067	-142 - 815

16:9 Screen Size		①	②
		Minimum (Wide) to Maximum (Tele)	Vertical lens shift Top to Bottom
80"	180x100	301 - 490	-28 - 127
100"	220x120	378 - 614	-35 - 159
120"	270x150	455 - 739	-42 - 191
150"	330x190	571 - 925	-52 - 239
200"	440x250	764 - 1236	-69 - 318
300"	660x370	1150 - 1859	-104 - 477
485"	1070x600	1869 - 3016	-168 - 773

Projection Distance of EB-Z8050W

Units: cm

4:3 Screen Size		①	②
		Minimum (Wide) to Maximum (Tele)	Vertical lens shift Top to Bottom
60"	120x90	247 - 403	-18 - 110
80"	160x120	332 - 540	-24 - 146
100"	200x150	417 - 677	-30 - 183
120"	240x180	502 - 814	-37 - 219
150"	300x230	630 - 1020	-46 - 274
200"	410x300	843 - 1363	-61 - 366
300"	610x460	1268 - 2048	-91 - 549
440"	890x670	1868 - 3014	-134 - 807

Units: cm

16:9 Screen Size		①	②
		Minimum (Wide) to Maximum (Tele)	Vertical lens shift Top to Bottom
60"	130x75	224 - 365	-21 - 95

Units: cm

16:10 Screen Size		①	②
		Minimum (Wide) to Maximum (Tele)	Vertical lens shift Top to Bottom
60"	130x81	217 - 355	-16 - 97
80"	180x110	292 - 476	-22 - 129
100"	220x130	368 - 597	-27 - 162
120"	270x169	443 - 719	-32 - 194
150"	330x206	555 - 900	-40 - 242
200"	440x275	743 - 1203	-54 - 323
300"	550x344	1119 - 1808	-81 - 485
500"	1100x688	1870 - 3019	-135 - 808

Connect with a commercially available 100BASE-TX or 10BASE-T LAN cable. The interface may differ from the following illustration depending on the model of your projector. (The following illustration indicates EB-Z8000WU)

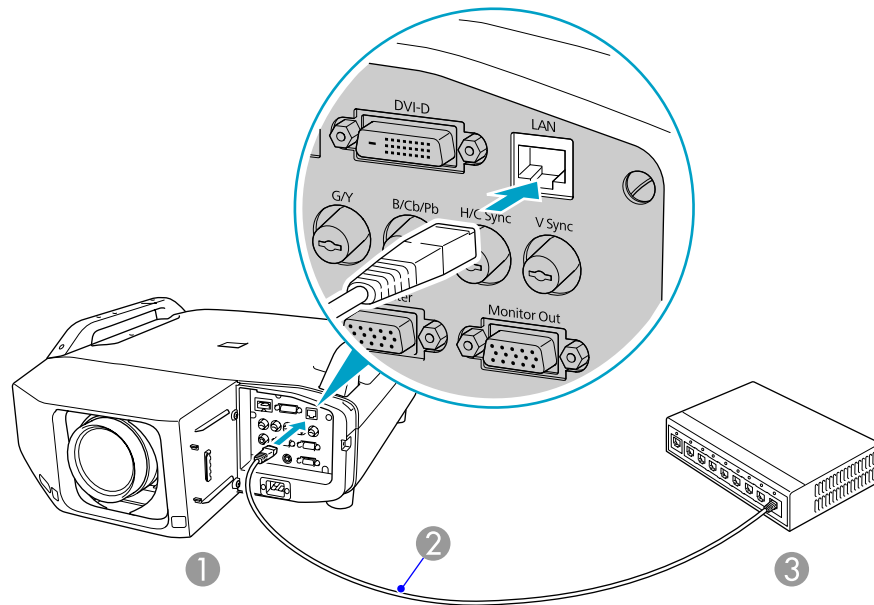

- ① To LAN port
- ② LAN cable (commercially available)
- ③ To LAN port

Attention

To prevent malfunctions, use a category 5 shielded LAN cable.

Analog RGB images input from Computer Input Port or BNC Input Port can be displayed on an external monitor and the screen at the same time. This means that you can check projected images on an external monitor when giving presentations even if you cannot see the screen. Connect using the cable supplied with the external monitor.

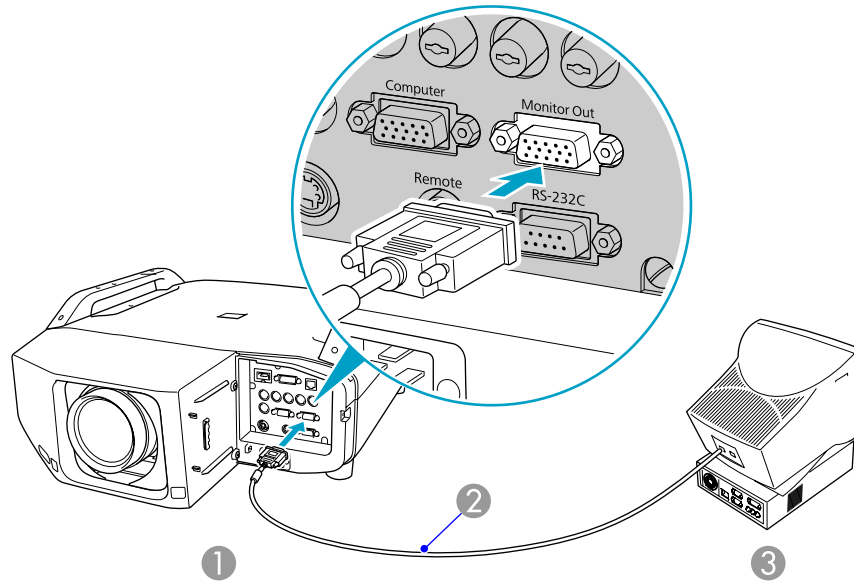

- ① To Monitor Out port
- ② Cable supplied with monitor
- ③ To Monitor port



- Component video signals and computer or video equipment connected to the input ports other than Computer input port and BNC input port cannot be output to an external monitor.
- Setting gauges such as Keystone, the configuration menu, or Help screens are not output to the external monitor.

Prepare #2 plus-driver in advance.

Removing

Attention

- Only remove the lens unit when necessary. If dust or dirt enter the projector, projection quality deteriorates and it could cause a malfunction.
- Try not to touch the lens section with your hand or fingers. If fingerprints or oils are left on the surface of the lens, projection quality deteriorates.
- If the lens shift has been done, set the lens shift to the center before replacing the lens unit.

Procedure

- ① Remove the interface cover.

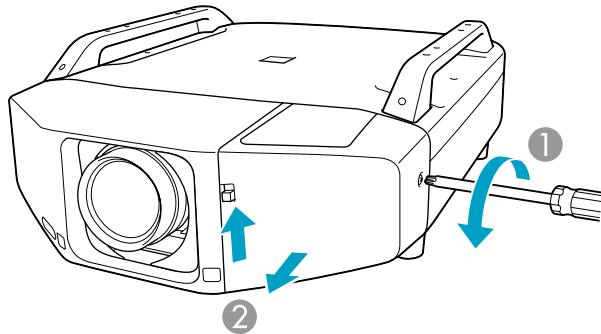

- ① Loosen the fixing screw.
- ② While pulling up the interface cover open switch, pull the interface cover straight out.

- ② Remove the front cover.

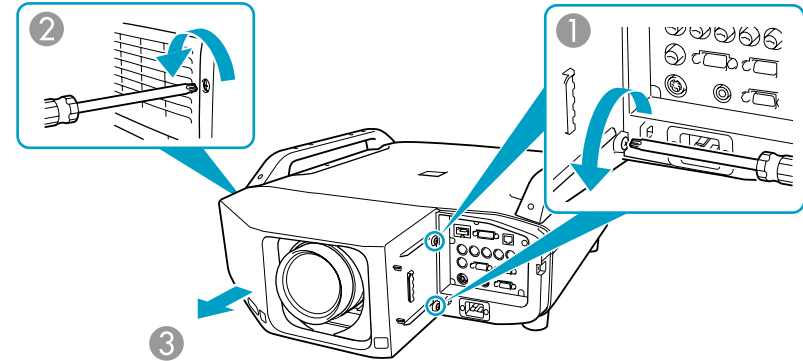

- ① Loosen the two fixing screws.
- ② Loosen the fixing screw.
- ③ Pull the cover straight out.

- ③ Pinch the lock lever of the lens unit and turn it counterclockwise.

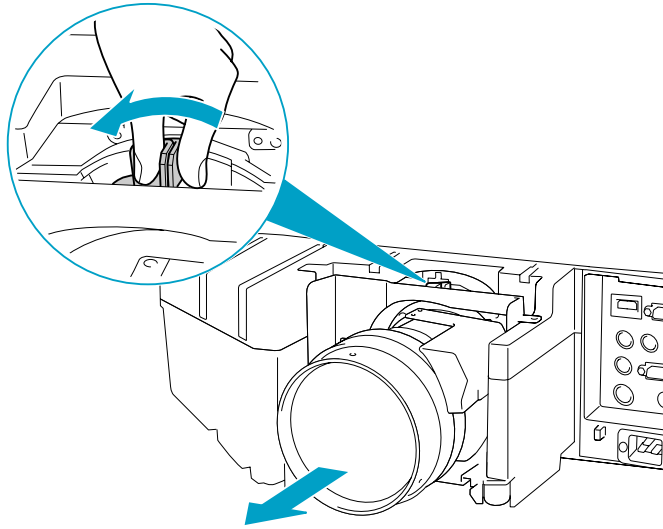

- 4** Pull the lens unit straight out as it is released.

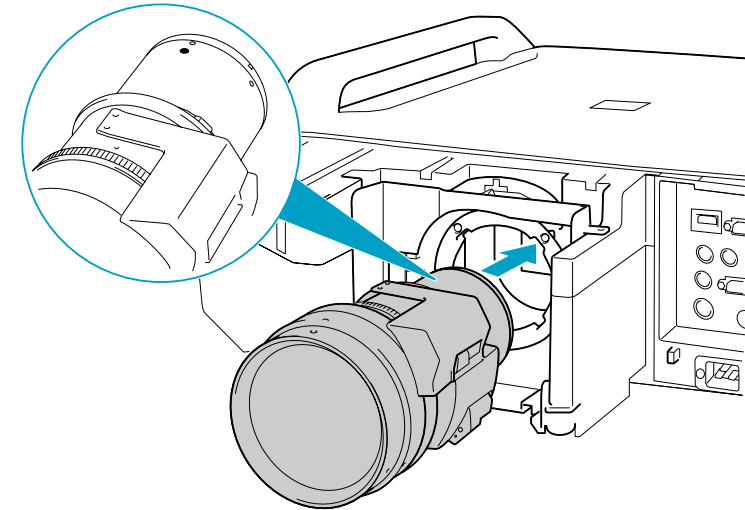

- 2** While holding the lens unit firmly, turn the lock lever clockwise until it is locked. Check that the lens cannot be detached.

Attaching

Attention

Do not attach the lens unit when the projector's lens insertion section is facing up. Dust or dirt could enter the projector.

Procedure

- 1** Insert the lens unit straight into the lens insertion section with the white circle on the lens on top.

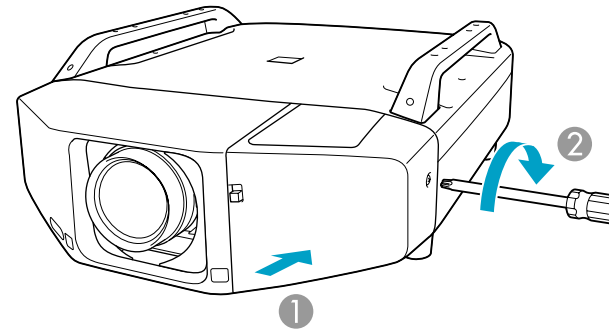
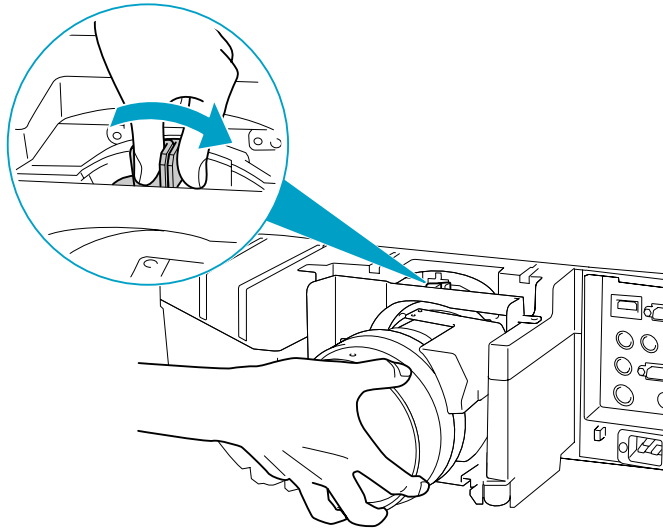

- 1 Install the cover along the guide.
- 2 Tighten the fixing screws.

3 Replace the front cover.

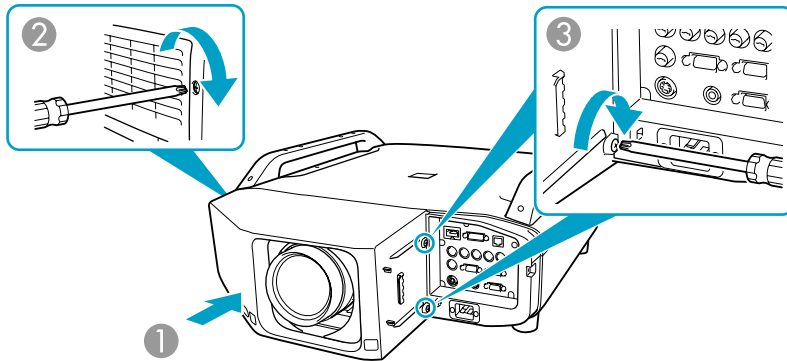

- 1 Install the cover along the guide.
- 2 Tighten the fixing screw.
- 3 Tighten the two fixing screws.

4 Replace the interface cover.

Attention

- Install the front cover to use the projector.
- Store the projector with the lens unit installed.
If the projector is stored without the lens unit, dust and dirt may get inside the projector and cause malfunctions or lower the quality of projection.

When the **Mail Notification** function is set to **On** and a problem/warning occurs in the projector, the following e-mail is sent.

Subject: EPSON Projector

Line 1: The name of the projector where the problem has occurred

Line 2: The IP address set for the projector where the problem has occurred.

Line 3 and on: Details of the problem

The details of the problem are listed line by line. The following table shows the details that are given in the message for each item. To deal with problems/warnings, see "Reading the Indicators"  p.71

Message	Cause
Auto Iris Error	Auto Iris Error
Cinema filter error	Cinema filter error
Cinema Filter Warning	Cinema Filter Warn. The projector can still be used but the cinema filter does not work.
Clean Air Filter	Air Filter Notice
Fan related error	Fan Error
High-speed cooling in progress	High Temp Warning
Internal error	Internal Error
Internal temperature error	High Temp Error (Overheating)
Lamp out	Lamp Error (both lamps 1/2)
Lamp replacement notification (1) Lamp replacement notification (2)	Replace Lamp (1) Indicates lamp 1, and (2) indicates lamp 2. The informed lamp is due for replacement.
Lamp timer failure	Lamp Failure (both lamp 1/2)
Lamp Warning (1) Lamp Warning (2)	Lamp Warning (1) indicates lamp 1, and (2) indicates lamp 2. The informed lamp is out.

Message	Cause
Low Air Flow	Low Air Flow
Low Air Flow Error	Filter Airflow Error
No Air Filter	No Air Filter/Air Flow Sensor Err.
No-signal	No Signal No Signal is input to the projector. Check the connection status or check that the power for the signal source is turned on.
Peltier Device error	Cooling system error (Peltier element)
Power Err. (Ballast)	Power Err. (Ballast)
Power Warning. (Ballast) (1) Power Warning. (Ballast) (2)	Supply System Warning (Ballast) (1) indicates the lamp 1, and (2) indicates the lamp 2. The informed lamp is out.
Pump Error	Cooling system error (pump)
Sensor error	Sensor Error
Shutter Error	Shutter Error
Shutter Warning	Shutter Warning Though this unit still can be used, the electric shutter does not work.

A (+) or (-) appears at the start of the message.

(+): A projector problem has occurred

(-): A projector problem has been dealt with

Command List

When the power ON command is transmitted to the projector, the power turns on and it enters warm-up mode. When the projector's power has turned on, a colon ":" (3Ah) is returned.

When a command is input, the projector executes the command and returns a ":", and then accepts the next command.

If the command being processed terminates abnormally, an error message is output and a ":" is returned.

Item		Command	
Power ON/OFF	On	PWR ON	
	Off	PWR OFF	
Signal selection	Computer	Auto	SOURCE 1F
		RGB	SOURCE 11
		Component	SOURCE 14
	BNC	Auto	SOURCE BF
		RGB	SOURCE B1
		Component	SOURCE B4
	HDMI	SOURCE A0	
	DVI-D	SOURCE 30	
	Video	SOURCE 45	
S-Video	SOURCE 42		
Shutter On/Off	On	MUTE ON	
	Off	MUTE OFF	

Add a Carriage Return (CR) code (0Dh) to the end of each command and transmit.

Cable Layouts

Serial Connection

- Connector shape: D-Sub 9-pin (male)
- Projector input port name: RS-232C

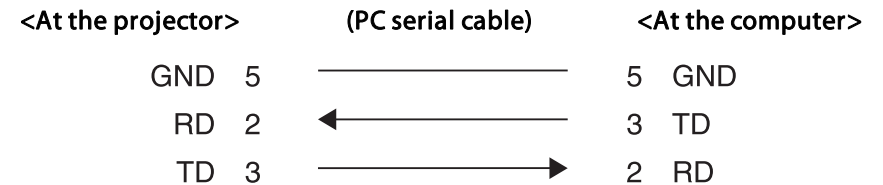
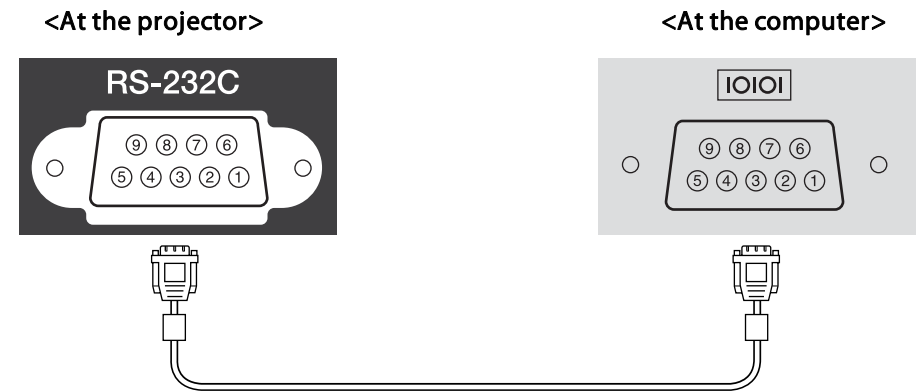

Signal Name	Function
GND	Signal wire ground
TD	Transmit data
RD	Receive data



Communications protocol

- Default baud rate setting: 9600 bps
- Data length: 8 bit
- Parity: None
- Stop-bit: 1 bit
- Flow control: None

PJLink Class1 was established by the JBMIA (Japan Business Machine and Information System Industries Association) as a standard protocol for controlling network-compatible projector's as part of their efforts to standardize projector control protocols.

The projector complies with the PJLink Class1 standard established by the JBMIA.

It complies with all commands except for the following commands defined by PJLink Class1, and agreement was confirmed by the PJLink standard adaptability verification.

URL: <http://pjlink.jbmia.or.jp/english/>

- **Non-compatible commands**

Function	PJLink Command
Image muting set	AVMT 11

- Input names defined by **PJLink and corresponding projector sources**

Source	PJLink Command
Computer	INPT 11
BNC	INPT 13
Video	INPT 23
S-Video	INPT 22
DVI-D	INPT 31
HDMI	INPT 32

- Manufacturer name displayed for "Manufacture name information query"
EPSON
- Model name displayed for "Product name information query"
EB-Z8050W/PowerLite Pro Z8050W
EB-Z8000WU/PowerLite Pro Z8000WU

Supported Monitor Displays for EB-Z8000WU

Computer signals (analog RGB)

Units: dots

Signal	Refresh Rate (Hz)	Resolution	Aspect Mode				
			Normal	16:9	Full	Zoom	Native
VGA	60/72/75/85/iMac* ¹	640x480	1600x1200	1920x1080	1920x1200	1920x1200	640x480
SVGA	56/60/72/75/85/iMac* ¹	800x600	1600x1200	1920x1080	1920x1200	1920x1200	800x600
XGA	60/70/75/85/iMac* ¹	1024x768	1600x1200	1920x1080	1920x1200	1920x1200	1024x768
WXGA	60/75/85	1280x768	1920x1152	1920x1080	1920x1200	1920x1152	1280x768
	60	1360x768	1920x1084	1920x1080	1920x1200	1920x1084	1360x768
	60/75/85	1280x800	1920x1200	1920x1080	1920x1200	1920x1200	1280x800
WXGA+	60/75/85	1440x900	1920x1200	1920x1080	1920x1200	1920x1200	1440x900
WSXGA+	60	1680x1050	1920x1200	1920x1080	1920x1200	1920x1200	1680x1050
SXGA	70/75/85	1152x864	1600x1200	1920x1080	1920x1200	1920x1200	1152x864
	60/75/85	1280x1024	1500x1200	1920x1080	1920x1200	1920x1200	1280x1024
	60/75/85	1280x960	1600x1200	1920x1080	1920x1200	1920x1200	1280x960
SXGA+	60* ² /75/85	1400x1050	1600x1200	1920x1080	1920x1200	1920x1200	1400x1050
UXGA	60	1600x1200	1600x1200	Non-compatible	1920x1200	1920x1200	1600x1200
WUXGA* ³	60	1920x1200	1920x1200	1920x1080	1920x1200	1920x1200	1920x1200
MAC13"	67	640x480	1600x1200	1920x1080	1920x1200	1920x1200	640x480
MAC16"	75	832x624	1600x1200	1920x1080	1920x1200	1920x1200	832x624
MAC19"	75	1024x768	1600x1200	1920x1080	1920x1200	1920x1200	1024x768
	60	1024x768	1600x1200	1920x1080	1920x1200	1920x1200	1024x768

Signal	Refresh Rate (Hz)	Resolution	Aspect Mode				
			Normal	16:9	Full	Zoom	Native
MAC21"	75	1152x870	1588x1200	1920x1080	1920x1200	1920x1200	1152x870

*1 Connection is disabled if the equipment does not have a VGA output port.

*2 Only compatible when Normal is selected as the Resolution from the configuration menu.

*3 Only compatible when VESA CVT-RB(Reduced Blanking) signal is input.

Even when signals other than those mentioned above are input, it is likely that the image can be projected. However, not all functions may be supported.

Component Video

Units: dots

Signal	Refresh Rate (Hz)	Resolution	Aspect Mode				
			Normal	16:9	Full	Zoom	Native
SDTV(480i)	60	720x480	1600x1200	1920x1080	1920x1200	1920x1200	640x480
SDTV(576i)	50	720x576	1600x1200	1920x1080	1920x1200	1920x1200	768x576
SDTV(480p)	60	720x480	1600x1200	1920x1080	1920x1200	1920x1200	640x480
SDTV(576p)	50	720x576	1600x1200	1920x1080	1920x1200	1920x1200	768x576
HDTV(720p)	50/60	1280x720	1920x1080	1920x1080	1920x1200	1920x1080	1280x720
HDTV(1080i)	50/60	1920x1080	1920x1080	1920x1080	1920x1200	1920x1080	1920x1080
HDTV(1080p)	50/60	1920x1080	1920x1080	1920x1080	1920x1200	1920x1080	1920x1080

Composite Video/S-Video

Units: dots

Signal	Refresh Rate (Hz)	Resolution	Aspect Mode				
			Normal	16:9	Full	Zoom	Native
TV(NTSC)	60	720x480	1600x1200	1920x1080	1920x1200	1920x1200	640x480
TV(PAL,SECAM)	50	720x576	1600x1200	1920x1080	1920x1200	1920x1200	768x576

Input signal from the HDMI/DVI-D input port

Units: dots

Signal	Refresh Rate (Hz)	Resolution	Aspect Mode			
			16:9	Full	Zoom	Native
VGA	60	640x480	1920x1080	1920x1200	1920x1200	640x480
SVGA	60	800x600	1920x1080	1920x1200	1920x1200	800x600
XGA	60	1024x768	1920x1080	1920x1200	1920x1200	1024x768
WXGA	60	1280x800	1920x1080	1920x1200	1920x1200	1280x800
SXGA	60	1280x960	1920x1080	1920x1200	1920x1200	1280x960
	60	1280x1024	1920x1080	1920x1200	1920x1200	1280x1024
SXGA+	60	1400x1050	1920x1080	1920x1200	1920x1200	1400x1050
UXGA	60	1600x1200	Non-compatible	1920x1200	1920x1200	1600x1200
WUXGA*	60	1920x1200	1920x1080	1920x1200	1920x1200	1920x1200
SDTV(480i)	60	720x480	1920x1080	1920x1200	1920x1200	640x480
SDTV(480p)	60	720x480	1920x1080	1920x1200	1920x1200	640x480
SDTV(576i)	50	720x576	1920x1080	1920x1200	1920x1200	768x576
SDTV(576p)	50	720x576	1920x1080	1920x1200	1920x1200	768x576
HDTV(720p)	50/60	1280x720	1920x1080	1920x1200	1920x1080	1280x720
HDTV(1080i)	50/60	1920x1080	1920x1080	1920x1200	1920x1080	1920x1080
HDTV(1080p)	24/30/50/60	1920x1080	1920x1080	1920x1200	1920x1080	1920x1080

* Only compatible when VESA CVT-RB(Reduced Blanking) signal is input.

Supported Monitor Displays for EB-Z8050W

Computer signals (analog RGB)

Units: dots

Signal	Refresh Rate (Hz)	Resolution	Aspect Mode				
			Normal	16:9	Full	Zoom	Native
VGAEGA	70	640x350	1280x700	1280x720	1280x800	1280x700	640x350
VGA	60/72/75/85/iMac ^{*1}	640x480	1066x800	1280x720	1280x800	1280x800	640x480
SVGA	56/60/72/75/85/iMac ^{*1}	800x600	1066x800	1280x720	1280x800	1280x800	800x600
XGA	60/70/75/85/iMac ^{*1}	1024x768	1066x800	1280x720	1280x800	1280x800	1024x768
WXGA	60/75/85	1280x768	1280x768	1280x720	1280x800	1280x768	1280x768
	60	1360x768	1280x722	1280x720	1280x800	1280x722	1280x800
	60/75/85	1280x800	1280x800	1280x720	1280x800	1280x800	1280x800
WXGA+	60/75/85	1440x900	1280x800	1280x720	1280x800	1280x800	1280x800
WSXGA+	60	1680x1050	1280x800	1280x720	1280x800	1280x800	1280x800
SXGA	70/75/85	1152x864	1066x800	1280x720	1280x800	1280x800	1280x800
	60/75/85	1280x1024	1000x800	1280x720	1280x800	1280x800	1280x800
	60/75/85	1280x960	1066x800	1280x720	1280x800	1280x800	1280x800
SXGA+	60 ^{*2} /75/85	1400x1050	1066x800	1280x720	1280x800	1280x800	1280x800
UXGA	60	1600x1200	1066x800	1280x720	1280x800	1280x800	1280x800
WUXGA ^{*3}	60	1920x1200	1280x800	1280x720	1280x800	1280x800	1280x800
MAC13"	67	640x480	1066x800	1280x720	1280x800	1280x800	640x480
MAC16"	75	832x624	1066x800	1280x720	1280x800	1280x800	832x624
MAC19"	75	1024x768	1066x800	1280x720	1280x800	1280x800	1024x768
	60	1024x768	1066x800	1280x720	1280x800	1280x800	1024x768

Signal	Refresh Rate (Hz)	Resolution	Aspect Mode				
			Normal	16:9	Full	Zoom	Native
MAC21"	75	1152x870	1059x800	1280x720	1280x800	1280x800	1152x800

*1 Connection is disabled if the equipment does not have a VGA output port.

*2 Only compatible when Normal is selected as the Resolution from the configuration menu.

*3 Only compatible when VESA CVT-RB(Reduced Blanking) signal is input.

Even when signals other than those mentioned above are input, it is likely that the image can be projected. However, not all functions may be supported.

Component Video

Units: dots

Signal	Refresh Rate (Hz)	Resolution	Aspect Mode				
			Normal	16:9	Full	Zoom	Native
SDTV(480i)	60	720x480	1066x800	1280x720	1280x800	1280x800	640x480
SDTV(576i)	50	720x576	1066x800	1280x720	1280x800	1280x800	768x576
SDTV(480p)	60	720x480	1066x800	1280x720	1280x800	1280x800	640x480
SDTV(576p)	50	720x576	1066x800	1280x720	1280x800	1280x800	768x576
HDTV(720p)	50/60	1280x720	1280x720	1280x720	1280x800	1280x720	1280x720
HDTV(1080i)	50/60	1920x1080	1280x720	1280x720	1280x800	1280x720	1280x800
HDTV(1080p)	50/60	1920x1080	1280x720	1280x720	1280x800	1280x720	1280x800

Composite Video/S-Video

Units: dots

Signal	Refresh Rate (Hz)	Resolution	Aspect Mode				
			Normal	16:9	Full	Zoom	Native
TV(NTSC)	60	720x480	1066x800	1280x720	1280x800	1280x800	640x480
TV(PAL,SECAM)	50	720x576	1066x800	1280x720	1280x800	1280x800	768x576

Input signal from the HDMI/DVI-D input port

Units: dots

Signal	Refresh Rate (Hz)	Resolution	Aspect Mode			
			16:9	Full	Zoom	Native
VGA	60	640x480	1280x720	1280x800	1280x800	640x480
SVGA	60	800x600	1280x720	1280x800	1280x800	800x600
XGA	60	1024x768	1280x720	1280x800	1280x800	1024x768
WXGA	60	1280x800	1280x720	1280x800	1280x800	1280x800
SXGA	60	1280x960	1280x720	1280x800	1280x800	1280x800
	60	1280x1024	1280x720	1280x800	1280x800	1280x800
SXGA+	60	1400x1050	1280x720	1280x800	1280x800	1280x800
UXGA	60	1600x1200	1280x720	1280x800	1280x800	1280x800
WUXGA*	60	1920x1200	1280x720	1280x800	1280x800	1280x800
SDTV(480i)	60	720x480	1280x720	1280x800	1280x800	640x480
SDTV(480p)	60	720x480	1280x720	1280x800	1280x800	640x480
SDTV(576i)	50	720x576	1280x720	1280x800	1280x800	768x576
SDTV(576p)	50	720x576	1280x720	1280x800	1280x800	768x576
HDTV(720p)	50/60	1280x720	1280x720	1280x800	1280x720	1280x720
HDTV(1080i)	50/60	1920x1080	1280x720	1280x800	1280x720	1280x800
HDTV(1080p)	24/30/50/60	1920x1080	1280x720	1280x800	1280x720	1280x800

* Only compatible when VESA CVT-RB(Reduced Blanking) signal is input.

Projector General Specifications

Product name		EB-Z8050W	EB-Z8000WU
Dimensions		534 (W) × 167 (H) × 734 (D) mm (not including raised section)	
Panel size		0.95" Wide	0.94" Wide
Display method		Polysilicon TFT active matrix	
Resolution		1,024,000 pixels WXGA (1280 (W) × 800 (H) dots) × 3	2,304,000 pixels WUXGA (1920 (W) × 1200 (H) dots) × 3
Focus adjustment		Automatic	
Zoom adjustment*1		Automatic (1-1.6)	
Lens shift*1		Automatic (Vertical direction: Maximum approx. 70%, Horizontal direction: Maximum approx. 20%)	
Lamp		UHE lamp, 330 W Two-lamps Model No.: ELPLP52 (Two)/ELPLP51 (One)	
Power supply		100-240V AC ±10%, 50/60Hz 10.7 to 4.5A	
Power consumption	100 to 120 V area	Operating: 938W Standby power consumption (Communication On): 10.2W Standby power consumption (Communication Off): 0.3W	Operating: 942W Standby power consumption (Communication On): 11.2W Standby power consumption (Communication Off): 0.3W
	200 to 240 V area	Operating: 872W Standby power consumption (Communication On): 12.0W Standby power consumption (Communication Off): 0.5W	Operating: 877W Standby power consumption (Communication On): 13.1W Standby power consumption (Communication Off): 0.5W
Operating altitude		Altitude 0 to 3048 m	
Operating temperature		0 to 45°C*2 (No condensation)	
Storage temperature		-10 to +60°C (No condensation)	
Mass		Approx. 22 kg	

*1 The specifications are when a standard lens is attached. When an optional lens is attached, check the User's Guide supplied with the optional lenses.

*2 The operating temperature is 0 to +40°C when "Power Consumption" is set to "Normal" at an altitude of 1500 to 3048m.

Connectors

Computer Input Port	1	Mini D-Sub15-pin (female) blue
BNC Input Port	1	5BNC (female)
HDMI Input Port*	1	HDMI HDCP compatible, CEC signal incompatible
DVI-D Input Port*	1	DVI-D 24pin Single Link HDCP compatible
Video input port	1	1BNC (female)
S-Video input port	1	Mini DIN 4-pin
Monitor Out port	1	Mini D-Sub15-pin (female) black
LAN Port	1	RJ-45
Wireless LAN Port	1	USB connector (Type A) only for the wireless LAN unit
RS-232C Port	1	Mini D-Sub 9-pin (male)
Remote port	1	Stereo mini jack

* The projector can be connected to and project images from HDMI and DVI-D compatible equipment. However, images input from some equipment may not be projected.

This product is also designed for IT power distribution system with phase-to-phase voltage 230V.



Pixelworks DNX™ ICs are used in this projector.

Angle of tilt

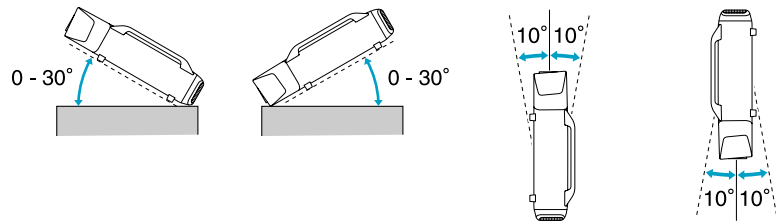

Using the projector at angles not shown in the illustrations above may damage it or cause an accident.

Operating Conditions for the Software

The software supplied with the projector runs on computers that meet the following requirements.

	EasyMP Network Projection	EasyMP Monitor
OS	Windows 2000 SP4/XP/XP SP1/XP SP2/XP SP3/Vista/Vista SP1 Mac OS X 10.3 or later Recommended: Mac OS X 10.5.1 or later, 10.4.11/10.3.9	Windows 98 Second Edition SP1/Windows Me/Windows NT4.0 SP6/Windows 2000 Professional SP4/ Windows XP Home Edition SP2 or later/Windows XP Professional SP2 or later/Windows Vista (All editions except for Starter)/Windows Vista SP1 (All editions except for Starter)
CPU	Mobile Pentium III 1.2GHz or more Power PC G3 900MHz or more Recommended: Pentium M1.6GHz or more CoreDuo 1.5GHz or more	Pentium MMX 166MHz or more Recommended: Pentium II 233MHz or more
Amount of Memory	256MB or more Recommended: 512MB or more	64MB or more
Hard Disk Free space	20MB or more	50MB or more
Display	Resolution greater than XGA (1024x768) Display color of approx. 32000 colors more than 16 bit colors	Resolution greater than SVGA (800x600) Display color in 32 bit full-color or greater Display Color

Internet Explorer Ver.5 or later must be installed.

Administrator rights are required to use EasyMP Monitor when using the following operation systems.

Windows 2000/Windows NT4.0/Windows XP/Windows Vista

DECLARATION of CONFORMITY

According to 47CFR, Part 2 and 15
Class B Personal Computers and Peripherals; and/or
CPU Boards and Power Supplies used with Class B
Personal Computers

We: Epson America, Inc.
Located at: 3840 Kilroy Airport Way
MS: 3-13
Long Beach, CA 90806
Tel: 562-290-5254

Declare under sole responsibility that the product identified herein, complies with 47CFR Part 2 and 15 of the FCC rules as a Class B digital device. Each product marketed, is identical to the representative unit tested and found to be compliant with the standards. Records maintained continue to reflect the equipment being produced can be expected to be within the variation accepted, due to quantity production and testing on a statistical basis as required by 47CFR 2.909. Operation is subject to the following two conditions : (1) this device may not cause harmful interference, and (2) this device must accept any interference received, including interference that may cause undesired operation.

Trade Name: EPSON
Type of Product: LCD Projector
Model: H265C/H266C

**FCC Compliance Statement
For United States Users**

This equipment has been tested and found to comply with the limits for a Class B digital device, pursuant to Part 15 of the FCC Rules. These limits are designed to provide reasonable protection against harmful interference in a residential installation. This equipment generates, uses, and can radiate radio frequency energy and, if not installed and used in accordance with the instructions, may cause harmful interference to radio communications. However, there is no guarantee that interference will not occur in a particular installation. If this equipment does cause harmful interference to radio or television reception, which can be determined by turning the equipment off and on, the user is encouraged to try to correct the interference by one or more of the following measures.

- Reorient or relocate the receiving antenna.
- Increase the separation between the equipment and receiver.
- Connect the equipment into an outlet on a circuit different from that to which the receiver is connected.
- Consult the dealer or an experienced radio/TV technician for help.

WARNING

The connection of a non-shielded equipment interface cable to this equipment will invalidate the FCC Certification or Declaration of this device and may cause interference levels which exceed the limits established by the FCC for this equipment. It is the responsibility of the user to obtain and use a shielded equipment interface cable with this device. If this equipment has more than one interface connector, do not leave cables connected to unused interfaces. Changes or modifications not expressly approved by the manufacturer could void the user's authority to operate the equipment.

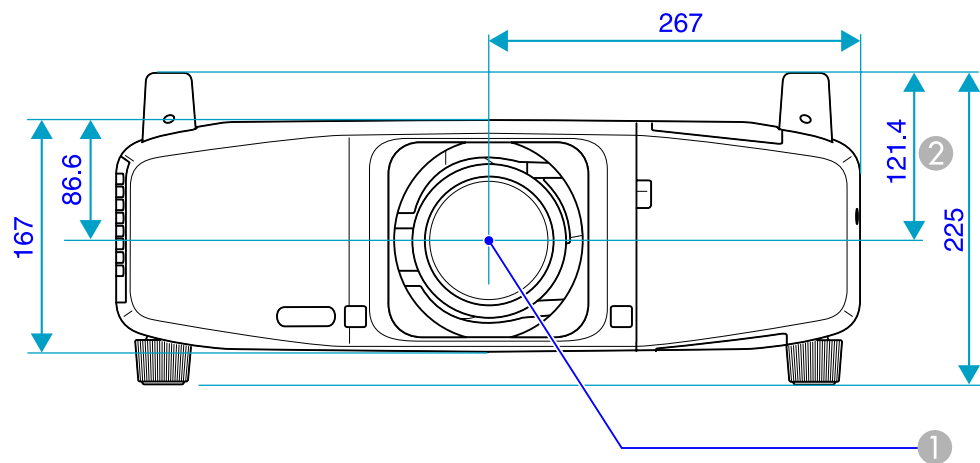

- ① Center of lens
- ② Distance from center of lens to suspension bracket fixing point

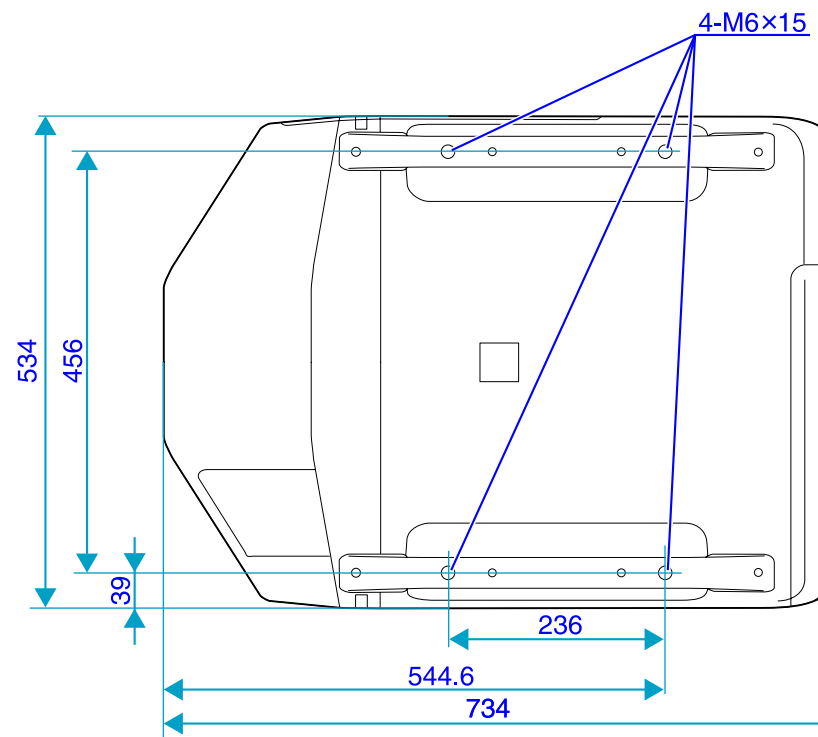

Units: mm