

# EB-L210SF/EB-L210SW User's Guide



---

# Contents

<b>EB-L210SF/EB-L210SW User's Guide .....</b>	<b>11</b>
<b>Introduction to Your Projector .....</b>	<b>12</b>
Projector Features.....	12
Product Box Contents.....	13
Additional Components .....	14
Optional Equipment and Replacement Parts.....	15
Warranty and Registration Information (U.S. and Canada) .....	16
Warranty and Registration Information (Latin America).....	16
Notations Used in the Documentation .....	17
Where to Go for Additional Information .....	17
Additional Projector Software and Manuals.....	17
Projector Part Locations .....	19
Projector Parts - Front/Top .....	20
Projector Parts - Rear .....	21
Projector Parts - Base.....	22
Projector Parts - Control Panel .....	23
Projector Parts - Remote Control.....	24
<b>Setting Up the Projector .....</b>	<b>26</b>
Projector Placement.....	26
Projector Setup and Installation Options .....	26
Projection Distance.....	28
Projector Connections .....	29
Connecting to Computer Sources.....	29
Connecting to a Computer for HDMI Video and Audio.....	29
Connecting to a Computer for VGA Video and Audio.....	30
Connecting to a Computer for USB Video and Audio.....	32
Connecting to Video Sources .....	33
Connecting to an HDMI Video Source .....	33
Connecting to a Composite Video Source .....	34
Connecting External Output Devices.....	35

Connecting to an External Computer Monitor .....	35
Connecting to External Speakers.....	36
Connecting a Microphone .....	37
Connecting to External USB Devices .....	38
USB Device Projection.....	38
Connecting a USB Device or Camera to the Projector.....	39
Selecting the Connected USB Source .....	39
Disconnecting a USB Device or Camera From the Projector.....	39
Connecting to a Document Camera .....	40
Installing Batteries in the Remote Control .....	40
<b>Using the Projector on a Network .....</b>	<b>42</b>
Wired Network Projection.....	42
Connecting to a Wired Network.....	42
Selecting Wired Network Settings .....	43
Wireless Network Projection .....	46
Connecting Directly to a Smartphone or Tablet.....	47
Using Quick Wireless Connection (Windows).....	51
Selecting Wireless Network Settings Manually.....	53
Wireless LAN Menu Settings .....	57
Selecting Wireless Network Settings in Windows.....	60
Selecting Wireless Network Settings on Mac .....	60
Setting Up Wireless Network Security .....	60
Installing the Wireless LAN Module .....	62
Wireless Network Projection from a Mobile Device or Windows Computer (Screen Mirroring).....	63
Screen Mirroring Restrictions .....	64
Selecting Screen Mirroring Settings .....	64
Connecting for Screen Mirroring with a Windows 8.x/Windows 10/Windows 11 Computer.....	67
Connecting for Screen Mirroring with Miracast.....	68
Setting Up Projector Network E-Mail Alerts.....	68
Network Projector E-mail Alert Messages .....	70
Setting Up Monitoring Using SNMP .....	71
Controlling a Networked Projector Using a Web Browser .....	71
Using Crestron Connected.....	75

Setting Up Crestron Connected.....	76
Controlling a Networked Projector Using Crestron Connected.....	77
Registering a Digital Certificate on the Projector.....	78
Importing a Web Server Certificate Using the Projector Menus.....	79
Registering Digital Certificates from a Web Browser.....	79
Digital Certificate Types.....	81
Art-Net Channel Definitions.....	82
<b>Using Basic Projector Features.....</b>	<b>87</b>
Turning On the Projector.....	87
Using the Home Screen.....	89
Turning Off the Projector.....	91
Selecting the Language for the Projector Menus.....	93
Setting the Date and Time.....	93
Adjusting the Image Height.....	95
Image Shape.....	96
Correcting Image Shape with the Horizontal Keystone Slider.....	96
Correcting Image Shape with the Keystone Buttons.....	97
Correcting Image Shape with Quick Corner.....	99
Correcting Image Shape with Arc Correction.....	102
Correcting Image Shape with Point Correction.....	104
Resizing the Image with the Wide and Tele Buttons.....	105
Setting the Screen Type.....	106
Adjusting the Image Position Using Screen Position.....	107
Displaying a Test Pattern.....	108
Focusing the Image Using the Focus Ring.....	109
Remote Control Operation.....	110
Selecting an Image Source.....	111
Projection Modes.....	113
Changing the Projection Mode Using the Remote Control.....	114
Changing the Projection Mode Using the Menus.....	114
Image Aspect Ratio.....	115
Changing the Image Aspect Ratio.....	115
Available Image Aspect Ratios.....	116

Color Mode.....	117
Changing the Color Mode.....	117
Available Color Modes.....	118
Adjusting the Hue, Saturation, and Brightness.....	119
Adjusting Gamma.....	120
Adjusting the Image Resolution.....	123
Adjusting the Projector's Brightness Level.....	125
Turning On Dynamic Contrast.....	127
Controlling the Volume with the Volume Buttons.....	128
Selecting a Quick Startup Setting.....	129
Projecting a PC Free Presentation.....	130
PC Free Precautions.....	131
Supported PC Free File Types.....	131
Starting a PC Free Slideshow.....	133
Starting a PC Free Movie Presentation.....	135
PC Free Display Options.....	137
Projecting in Content Playback Mode.....	138
Switching to Content Playback Mode.....	138
Projecting a Playlist in Content Playback Mode.....	140
Creating a Playlist Using Epson Web Control.....	141
Adding Effects to the Projected Image.....	143
Using Spotlight Mode.....	144
<b>Adjusting Projector Features.....</b>	<b>147</b>
Shutting Off the Picture and Sound Temporarily.....	147
Stopping Video Action Temporarily.....	148
Zooming Into and Out of Images.....	148
Using Multiple Projectors.....	149
Projector Identification System for Multiple Projector Control.....	150
Setting the Projector ID.....	150
Setting the Remote Control ID.....	151
Adjusting Color Uniformity.....	152
Blending the Image Edges.....	156
Matching the Image Colors.....	158

Adjusting the Black Level.....	160
Adjusting RGBCMY .....	164
Scaling an Image.....	166
Projecting Multiple Images Simultaneously.....	168
Input Sources for Split Screen Projection .....	171
Split Screen Projection Restrictions.....	171
Projector Security Features.....	172
Password Security Types .....	172
Setting a Password .....	172
Selecting Password Security Types.....	174
Entering a Password to Use the Projector.....	175
Saving a User's Logo Image to Display.....	176
Locking the Projector's Buttons .....	178
Unlocking the Projector's Buttons .....	179
Installing a Security Cable .....	179
Creating a User Pattern to Display .....	180
Copying Menu Settings Between Projectors .....	181
Saving Settings to a USB Flash Drive.....	182
Transferring Settings from a USB Flash Drive .....	183
Saving Settings to a Computer .....	184
Transferring Settings from a Computer .....	185
Scheduling Projector Events .....	187
Saving a Scheduled Event.....	187
Viewing Scheduled Events .....	190
Editing a Scheduled Event.....	191
<b>Adjusting the Menu Settings .....</b>	<b>193</b>
Using the Projector's Menus.....	193
Image Quality Settings - Image Menu .....	195
Input Signal Settings - Signal I/O Menu.....	200
Installation Settings - Installation Menu .....	204
Display Settings - Display Menu.....	207
Feature Settings - Operation Menu .....	210
Administration Settings - Management Menu.....	215

Event ID Code List.....	220
Network Settings - Network Menu .....	223
Multiple Projector Operation Settings - Multi-Projection Menu .....	226
Setup Settings - ECO Menu .....	229
Initial Settings and Reset Options - Initial/All Settings Menu .....	232
<b>Maintaining and Transporting the Projector .....</b>	<b>234</b>
Projector Maintenance .....	234
Cleaning the Lens.....	234
Cleaning the Projector Case.....	235
Air Filter and Vent Maintenance .....	235
Cleaning the Air Filter and Vents .....	236
Replacing the Air Filter .....	237
Replacing the Remote Control Batteries .....	238
Updating the Firmware .....	240
Transporting the Projector.....	240
<b>Solving Problems .....</b>	<b>242</b>
Projection Problem Tips .....	242
Projector Light Status .....	242
Using the Projector Menu Displays .....	245
Solving Image or Sound Problems .....	245
Solutions When No Image Appears.....	246
Solutions When Image is Incorrect Using the USB Display Function .....	247
Solutions When "No Signal" Message Appears.....	248
Displaying From a PC Laptop .....	248
Displaying From a Mac Laptop .....	249
Solutions When "Not Supported" Message Appears .....	249
Solutions When Only a Partial Image Appears .....	249
Solutions When the Image is Not Rectangular .....	250
Solutions When the Image Contains Noise or Static .....	250
Solutions When the Image is Fuzzy or Blurry .....	251
Solutions When the Image Brightness or Colors are Incorrect .....	252
Solutions When an Afterimage Remains On the Projected Image.....	252
Solutions to Sound Problems .....	252



Solutions to Microphone Problems .....	253
Solutions to PC Free Problems .....	253
Solutions to Problems Using Content Playback.....	254
Solving Projector or Remote Control Operation Problems .....	254
Solutions to Projector Power or Shut-Off Problems .....	254
Solutions to Remote Control Problems.....	255
Solutions to Password Problems .....	256
Solutions When a Battery Message Appears .....	256
Solving Network Problems .....	256
Solutions When Wireless Authentication Fails .....	257
Solutions When You Cannot Access the Projector Through the Web .....	257
Solutions When Network Alert E-Mails are Not Received.....	258
Solutions When the Image Contains Static During Network Projection .....	258
Solutions When You Cannot Connect Using Screen Mirroring.....	258
Solutions When the Image or Sound Contains Static When Using Screen Mirroring.....	259
Solutions to HDMI Link Problems.....	259
Where to Get Help (U.S. and Canada) .....	260
Where to Get Help (Latin America).....	261
<b>Technical Specifications .....</b>	<b>263</b>
General Projector Specifications .....	263
Projector Light Source Specifications.....	265
Remote Control Specifications .....	266
Projector Dimension Specifications .....	266
Projector Electrical Specifications .....	266
Projector Environmental Specifications.....	267
Projector Safety and Approvals Specifications (U.S. and Canada) .....	267
Projector Safety and Approvals Specifications (Latin America).....	268
<b>Supported Video Display Formats .....</b>	<b>270</b>
<b>USB Display System Requirements.....</b>	<b>273</b>
<b>Notices .....</b>	<b>274</b>
Recycling (U.S. and Canada).....	274
Important Safety Information .....	274

Laser Safety Information .....	274
Important Safety Instructions.....	275
Restriction of Use .....	279
List of Safety Symbols (corresponding to IEC60950-1 A2).....	279
FCC Compliance Statement.....	284
Binding Arbitration and Class Waiver .....	285
Trademarks .....	288
Copyright Notice.....	289
A Note Concerning Responsible Use of Copyrighted Materials.....	289
Copyright Attribution .....	289

---

## EB-L210SF/EB-L210SW User's Guide

Welcome to the EB-L210SF/EB-L210SW *User's Guide*. For a printable PDF copy of this guide, [click here](#).

**Note:** Availability of products in this guide varies by country.

---

# Introduction to Your Projector

Refer to these sections to learn more about your projector and this manual.

[Projector Features](#)

[Notations Used in the Documentation](#)

[Where to Go for Additional Information](#)

[Additional Projector Software and Manuals](#)

[Projector Part Locations](#)

## Projector Features

The EB-L210SF/EB-L210SW projectors include these special features:

### **Bright, high-resolution projection system**

- Up to 4000 lumens of color brightness (color light output) and white brightness (white light output)

**Note:** Color brightness (color light output) and white brightness (white light output) will vary depending on usage conditions. Color light output measured in accordance with IDMS 15.4; white light output measured in accordance with ISO 21118.

- EB-L210SF: Native resolution of 1920 × 1080 pixels (1080p)
- EB-L210SW: Native resolution of 1280 × 800 pixels (WXGA)

### **Flexible connectivity**

- Two HDMI ports for computer or video device connection
- Plug-and-play USB projection and audio for instant setup
- Wired and wireless network support for projection
- Screen mirroring to connect your mobile device wirelessly using Miracast technology
- 5V 2.0A USB-A port for powering connected streaming devices
- Projector monitoring and control via remote network computer
- PC Free photo slide shows via connected USB memory devices or Epson document camera
- Use Epson iProjection (Windows/Mac) to simultaneously project up to four images from network computers or mobile devices using the Epson iProjection app

- Projection from an iOS device, Android device, or Chromebook with the free Epson iProjection app; visit [epson.com/iprojection](http://epson.com/iprojection) (U.S.), [epson.ca/iprojection](http://epson.ca/iprojection) (Canada), or [latin.epson.com/iprojection](http://latin.epson.com/iprojection) (Latin America) for more information

### **Innovative display and operation features**

- Long-life laser light source
- Support for side-by-side projector mounting
- High digital zoom ratio for larger images in shorter projection distances
- 2,500,000:1 contrast ratio and Dynamic Contrast control for sharp, detailed images
- Built-in closed captioning decoder (availability varies by country)
- Powerful 16 W speaker system with audio out port for connecting external speakers
- Epson's Direct Power On and Auto Power On features for quick and easy setup
- Epson Content Management software for signage includes preset overlay filters, customizable options, playlist and scheduling functions with supplemental web app control
- Support for Crestron Connected network monitoring systems
- Network message broadcast system to project timely messages to all networked projectors

[Product Box Contents](#)

[Additional Components](#)

[Optional Equipment and Replacement Parts](#)

[Warranty and Registration Information \(U.S. and Canada\)](#)

[Warranty and Registration Information \(Latin America\)](#)

**Parent topic:** [Introduction to Your Projector](#)

## **Product Box Contents**

Save all the packaging in case you need to ship the projector. Always use the original packaging (or equivalent) when shipping.

Make sure your projector box included all of these parts:

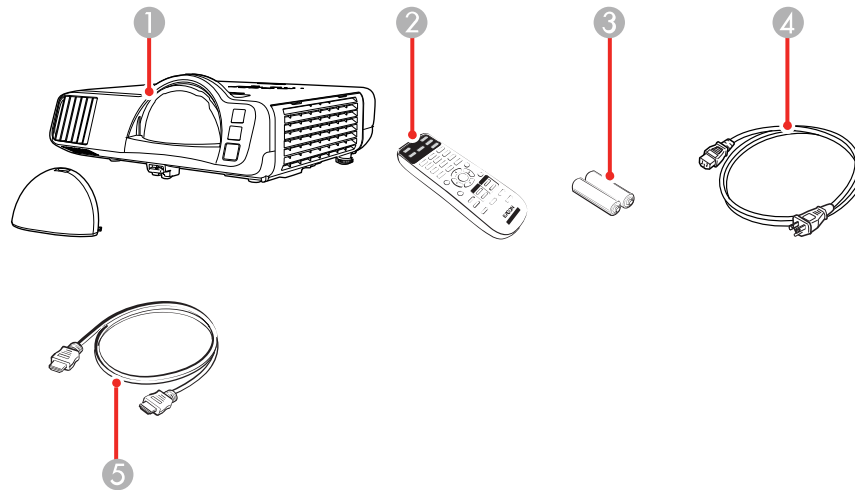

- 1 Projector
- 2 Remote control
- 3 Remote control batteries (2 AA manganese)
- 4 Power cord
- 5 HDMI cable

Parent topic: [Projector Features](#)

## Additional Components

Depending on how you plan to use the projector, you may need to obtain additional components.

**Note:** To connect a Mac that does not include a compatible video output port, you need to obtain an adapter that allows you to connect to an input port on the projector. Contact Apple for compatible adapter options. To connect a smartphone or tablet, you may need to obtain an adapter that allows you to connect to the projector. This allows you to mirror your smartphone or tablet screens, watch movies, and more. Contact your device manufacturer for compatible adapter options.

Unless listed as available from Epson in this table, see your local computer or electronics dealer for purchase information.

Signal or connection type	Additional component necessary
Composite video	RCA-style video or A/V cable
Audio from certain ports	Commercially available audio cable compatible with your device
VGA	Connect a computer through its VGA port to the projector's VGA video port
USB	Compatible USB cable

Parent topic: [Projector Features](#)

## Optional Equipment and Replacement Parts

**U.S. and Canada:** You can purchase screens, other optional accessories, and replacement parts from an Epson authorized reseller. To find the nearest reseller, call 800-GO-EPSON (800-463-7766) in the U.S. or 800-807-7766 in Canada. Or you can purchase online at [epsonstore.com](http://epsonstore.com) (U.S. sales) or [epsonstore.ca](http://epsonstore.ca) (Canadian sales).

**Latin America:** You can purchase optional accessories and replacement parts from an Epson authorized reseller. To find the nearest reseller, go to [latin.epson.com](http://latin.epson.com). Or you can click the "Where to Get Help" link below to contact your nearest sales office.

**Note:** Availability of accessories varies by country.

Epson offers the following optional accessories and replacement parts for your projector:

**U.S. and Canada:**

Option or part	Part number
Replacement air filter (ELPAF60)	V13H134A60
Short throw wall mount (ELPMB64)	V12HA39010
Soft carrying case (ELPKS71)	V12H001K71
Wireless LAN module (ELPAP11)	V12H005A02
Epson DC-07 document camera (ELPDC07)	V12H759020
Epson DC-13 document camera (ELPDC13)	V12H757020

Option or part	Part number
Epson DC-21 document camera (ELPDC21)	V12H758020
Active speakers (ELPSP02)	V12H467020
PowerLite Pilot 3 control system (ELPCB03)	V12H927020
Ceiling mount (ELPMB60W)	V12H963210
ES3000 ultra portable projector screen (ELPSC26H)	V12H002S3Y
Duet ultra portable projector screen	ELPSC80

In addition to the accessories listed above, extended service plans are available.

**Latin America:**

Option or part	Part number
Replacement air filter (ELPAF60)	V13H134A60
Short throw wall mount (ELPMB64)	V12HA39010
Wireless LAN module (ELPAP11)	V12H005A02

**Parent topic:** [Projector Features](#)

### Warranty and Registration Information (U.S. and Canada)

Your projector comes with a basic warranty that lets you project with confidence. For details, see the warranty that came with your projector.

Register your product online at this site: [epson.com/webreg](http://epson.com/webreg)

Registering also lets you receive special updates on new accessories, products, and services.

**Parent topic:** [Projector Features](#)

### Warranty and Registration Information (Latin America)

Your projector comes with a basic warranty that lets you project with confidence. For details, see the warranty that came with your projector.

Register your product online at [latin.epson.com/support](http://latin.epson.com/support), search for your product, and select **Register**.

Registering also lets you receive special updates on new accessories, products, and services.

**Parent topic:** [Projector Features](#)



## Notations Used in the Documentation

Follow the guidelines in these notations as you read your documentation:

- **Warnings** must be followed carefully to avoid bodily injury.
- **Cautions** must be observed to avoid damage to your equipment.
- **Notes** contain important information about your projector.
- **Tips** contain additional projection information.

**Parent topic:** [Introduction to Your Projector](#)

## Where to Go for Additional Information

Need quick help on using your projector? Here's where to look for help:

- [epson.com/support](http://epson.com/support) (U.S.), [epson.ca/support](http://epson.ca/support) (Canada), or [latin.epson.com/support](http://latin.epson.com/support) (Caribbean)

View FAQs (frequently asked questions) and e-mail your questions to Epson technical support 24 hours a day.

- If you still need help after checking this manual and any other sources listed here, you can use the Epson PrivateLine Support service to get help fast (U.S. and Canada only). For details, see "Where to Get Help."

**Parent topic:** [Introduction to Your Projector](#)

## Additional Projector Software and Manuals

After connecting and setting up the projector, install the projector software as necessary. You may need to install it from a software CD, if included, or download the software and manuals as necessary.

You can install the projector software programs listed here and view their manuals for instructions on using them.

**Note:** If you still need help after checking this manual and the sources listed here, you can use the Epson PrivateLine Support service to get help fast (U.S. and Canada only). For details, see "Where to Get Help."

<b>Projector software</b>	<b>Manual</b>	<b>Description</b>
Epson Projector Management (Windows only)	<i>Epson Projector Management Operation Guide</i>	Lets you update firmware and monitor and control your projector through the network.  You can download the latest software and documentation from the Epson web site. Go to <a href="http://epson.com/support">epson.com/support</a> (U.S.), <a href="http://epson.ca/support">epson.ca/support</a> (Canada), or <a href="http://latin.epson.com/support">latin.epson.com/support</a> (Caribbean) and select your projector.
Epson iProjection (Windows/Mac)	<i>Epson iProjection Operation Guide (Windows/Mac)</i>	Lets you project the computer screens of users over a network.  You can download the latest software and documentation from the Epson web site. Go to <a href="http://epson.com/support">epson.com/support</a> (U.S.), <a href="http://epson.ca/support">epson.ca/support</a> (Canada), or <a href="http://latin.epson.com/support">latin.epson.com/support</a> (Caribbean) and select your projector.
Epson iProjection app	Instructions are included with the app (instructions included with the app available only in English)	Lets you project from an iOS device, Android device, or Chromebook if your projector is connected to a network that includes a wireless access point.  Visit <a href="http://epson.com/support">epson.com/support</a> (U.S.), <a href="http://epson.ca/support">epson.ca/support</a> (Canada), or <a href="http://latin.epson.com/support">latin.epson.com/support</a> (Caribbean) for more information. (Software available only in English.)
—	<i>Open Source Software License</i>	You can download this document from the Epson web site. Go to <a href="http://epson.com/support">epson.com/support</a> (U.S.), <a href="http://epson.ca/support">epson.ca/support</a> (Canada), or <a href="http://latin.epson.com/support">latin.epson.com/support</a> (Caribbean) and select your projector. (Document available only in English.)

Projector software	Manual	Description
Epson Projector Content Manager	<i>Epson Projector Content Manager Operation Guide</i>	Lets you add images and movies to playlists, and save them on a USB device; insert the USB device into the projector to project your playlist content without using a cable connection.  You can download the latest software and documentation from the Epson web site. Go to <a href="http://epson.com/support">epson.com/support</a> (U.S.), <a href="http://epson.ca/support">epson.ca/support</a> (Canada), or <a href="http://latin.epson.com/support">latin.epson.com/support</a> (Caribbean) and select your projector.
Epson Creative Projection (iOS only)	Instructions are included with the app (instructions included with the app available only in English)	Lets you create custom content using built-in templates and stamps, and wirelessly transfer it to the projector if it is connected to a network that includes a wireless access point.  You can download the latest software and documentation from the Apple App Store.

**Note:** Epson iProjection is not recommended for use with streaming video.

**Parent topic:** [Introduction to Your Projector](#)

## Projector Part Locations

Check the projector part illustrations to learn about the parts on your projector.

[Projector Parts - Front/Top](#)

[Projector Parts - Rear](#)

[Projector Parts - Base](#)

[Projector Parts - Control Panel](#)

[Projector Parts - Remote Control](#)

**Parent topic:** [Introduction to Your Projector](#)

## Projector Parts - Front/Top

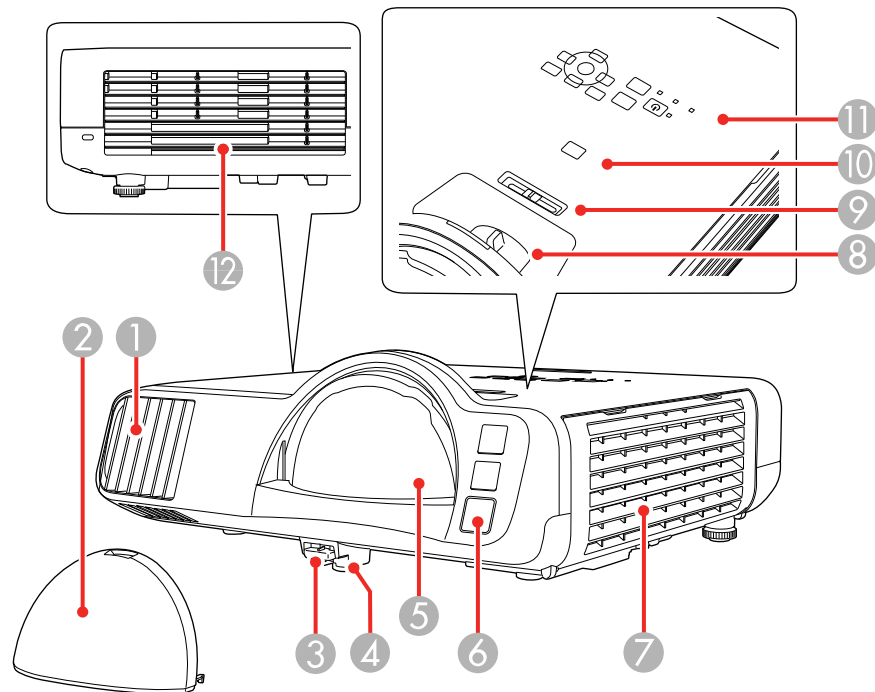

- 1 Air intake vent
- 2 Lens cover
- 3 Foot release lever
- 4 Front adjustable foot
- 5 Lens
- 6 Remote control receiver
- 7 Air filter/intake vent
- 8 Focus ring

- 9 Horizontal keystone slider
- 10 **A/V Mute** button
- 11 Control panel
- 12 Air exhaust vent

Parent topic: [Projector Part Locations](#)

## Projector Parts - Rear

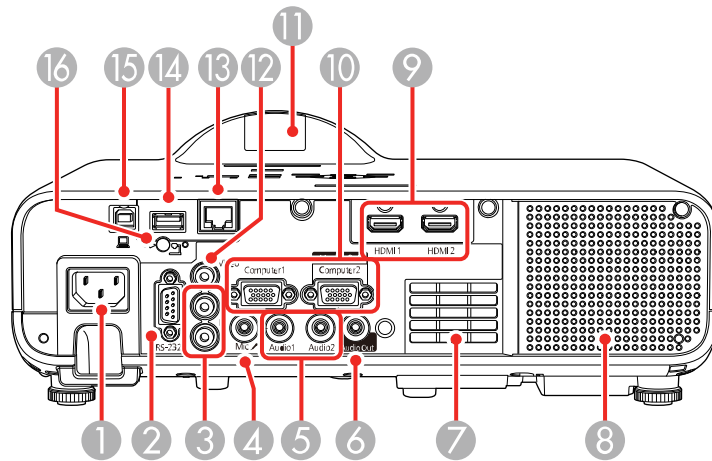

- 1 AC input
- 2 **RS-232C** port
- 3 **L** and **R** audio ports
- 4 **Mic** port
- 5 **Audio1** and **Audio2** ports
- 6 **Audio Out** port
- 7 Air intake vent
- 8 Speaker
- 9 **HDMI1** and **HDMI2** ports

- 10 **Computer1** and **Monitor Out/Computer2** ports
- 11 Remote receiver
- 12 **Video** port
- 13 **LAN** (network) port
- 14 **USB-A** port
- 15 **USB-B** port
- 16 Wireless LAN module cover screw

Parent topic: [Projector Part Locations](#)

## Projector Parts - Base

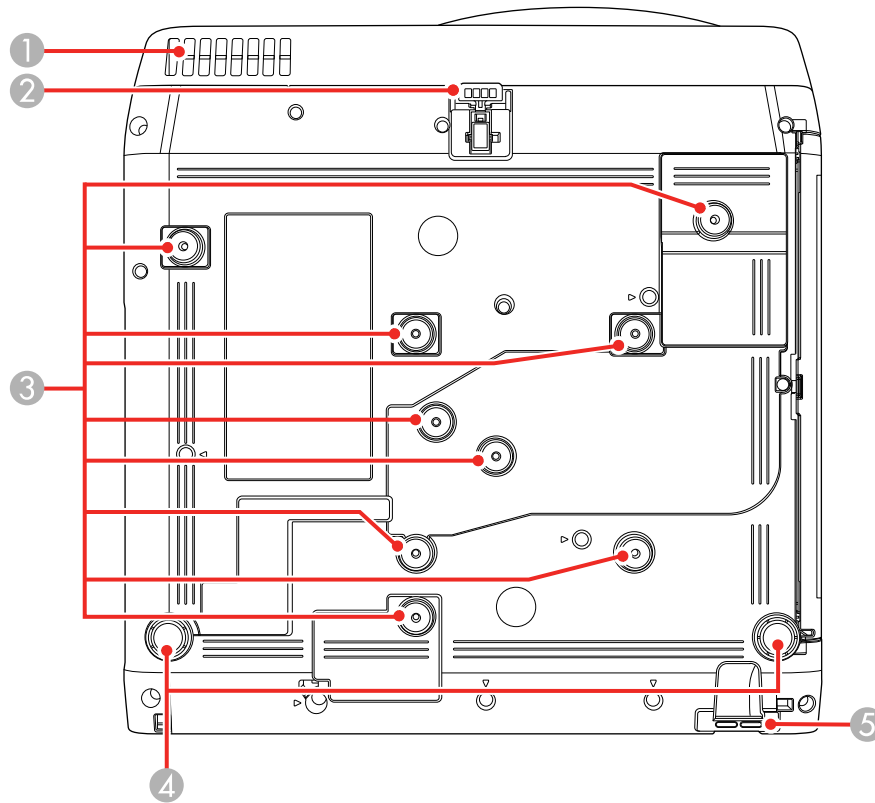

- 1 Air intake vent
- 2 Front adjustable foot
- 3 Ceiling/wall mount holes (9)
- 4 Rear feet
- 5 Security cable attachment point

**Note:** Use M4×9mm screws for mounting the projector.

**Parent topic:** [Projector Part Locations](#)

## Projector Parts - Control Panel

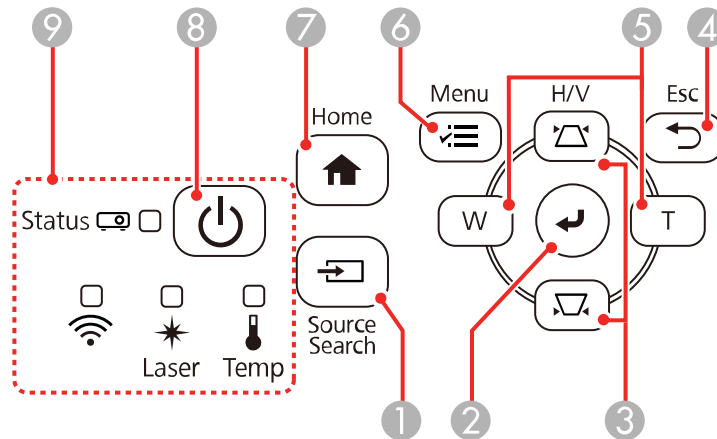

- 1 **Source Search** button (searches for connected video sources)
- 2 **Enter** button (selects options and automatically adjusts position, tracking, and sync settings when projecting analog RGB signals from the Computer ports)
- 3 **Vertical keystone adjustment** buttons (displays the adjustment screen and adjusts screen shape) and arrow buttons
- 4 **Esc** button (cancels/exits functions)
- 5 **W/T** (Wide/Tele) buttons (adjust projected image size) and arrow buttons

- 6 **Menu** button (accesses projector menu system)
- 7 **Home** button (displays Home screen)
- 8 Power button
- 9 Status lights

Parent topic: [Projector Part Locations](#)

## Projector Parts - Remote Control

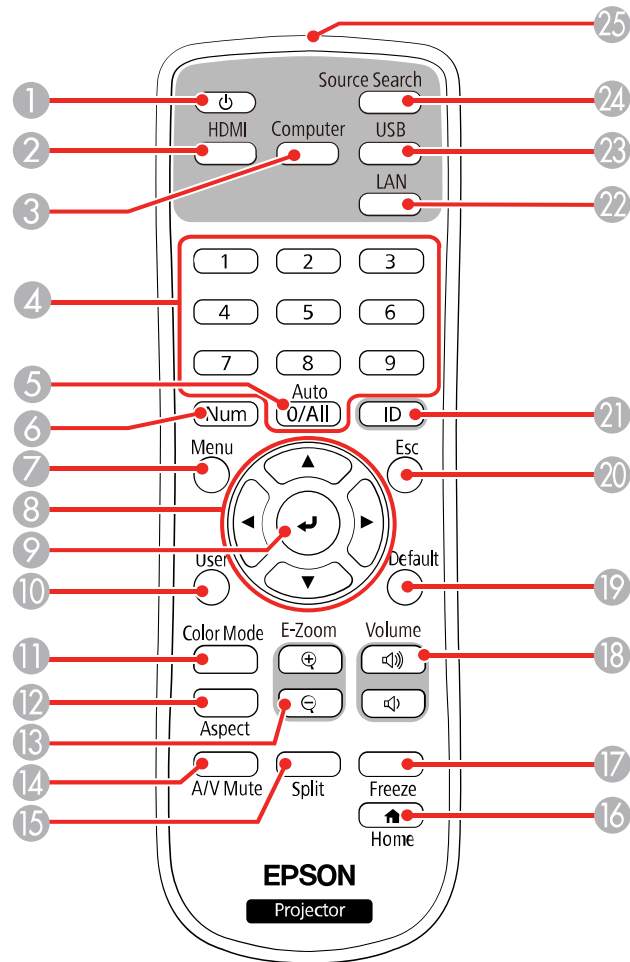



- 1 Power button
- 2 **HDMI** button (cycles through connected HDMI and video sources)
- 3 **Computer** button
- 4 Numeric buttons
- 5 **Auto** button (automatically adjusts position, tracking, and sync settings when projecting analog RGB signals from the Computer ports)
- 6 **Num** button (when held down, switches numeric buttons to number function)
- 7 **Menu** button (accesses projector menu system)
- 8 Arrow buttons (move through on-screen options)
- 9 ↵ Enter button (selects options)
- 10 **User** button (customizable for different functions)
- 11 **Color Mode** button (selects display modes)
- 12 **Aspect** button (selects the image aspect ratio)
- 13 **E-Zoom +/-** buttons (zoom into and out of the image)
- 14 **A/V Mute** button (turns off picture and sound)
- 15 **Split** button (splits the screen between up to four image sources)
- 16 🏠 **Home** button (accesses projector Home screen)
- 17 **Freeze** button (stops video action)
- 18 **Volume** up/down buttons (adjust speaker volume)
- 19 **Default** button (returns the current setting to its default)
- 20 **Esc** button (cancels/exits functions)
- 21 **ID** button (selects a projector to use with the remote control)
- 22 **LAN** button (connects to a network source)
- 23 **USB** button (cycles between USB Display and USB-A port)
- 24 **Source Search** button (searches for connected video sources)
- 25 Remote control emitter

Parent topic: [Projector Part Locations](#)

---

# Setting Up the Projector

Follow the instructions in these sections to set up your projector for use.

[Projector Placement](#)

[Projector Connections](#)

[Installing Batteries in the Remote Control](#)

## Projector Placement

You can place the projector on almost any flat surface to project an image.

You can also install the projector in a ceiling or wall mount if you want to use it in a fixed location.

There is no vertical or horizontal limit to how the projector can be installed.

Keep these considerations in mind as you select a projector location:

- Place the projector on a sturdy, level surface or install it using a compatible mount.
- Leave plenty of space around and under the projector for ventilation, and do not place it on top of or next to anything that could block the vents.
- If you are using the projector at altitudes above 4921 feet (1500 m), set the **High Altitude Mode** setting to **On** in the projector's Installation menu to ensure the projector's internal temperature is regulated properly.
- Position the projector within reach of a grounded electrical outlet or extension cord.
- If installing on a wall, the wall mount (V12HA39010) is required. Follow the instructions in the online *Installation Guide* to install the projector.
- Place the projector so it squarely faces the screen, not at an angle. If you cannot install the projector squarely facing the screen, correct any resulting image distortion using the projector controls.

[Projector Setup and Installation Options](#)

[Projection Distance](#)

Parent topic: [Setting Up the Projector](#)

## Projector Setup and Installation Options

You can set up or install your projector in the following ways:

Front

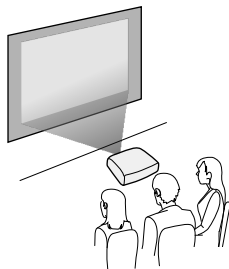

Rear

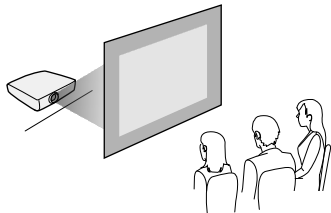

Front ceiling

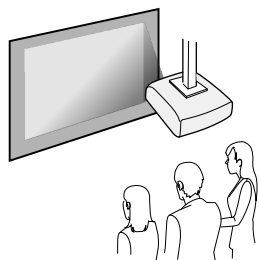

## Rear ceiling

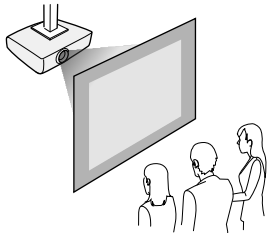

You can mount the projector to the ceiling at any horizontal or vertical angle.

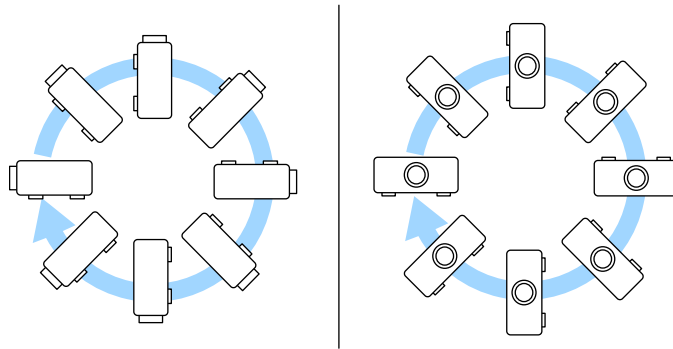

**Note:** When you install the projector in a fixed location, turn on the **Fixed Installation** setting in the projector's Installation menu.

If you project from the ceiling or from the rear, select the correct **Projection** setting.

**Parent topic:** [Projector Placement](#)

## Projection Distance

The distance at which you place the projector from the screen determines the approximate size of the image. The image size increases the farther the projector is from the screen, but can vary depending on the zoom factor, aspect ratio, and other settings.

Refer to the tables in the online *Installation Guide* to determine approximately how far to place the projector from the screen based on the size of the projected image. (Conversion figures may have been

rounded up or down.) You can also use the Projection Distance Calculator [here](#) (U.S.), [here](#) (Canada), or [here](#) (Caribbean).

**Parent topic:** [Projector Placement](#)

## Projector Connections

See these sections to connect the projector to a variety of projection sources.

**Caution:** If you will use the projector at altitudes above 4921 feet (1500 m), turn on **High Altitude Mode** to ensure the projector's internal temperature is regulated properly.

**Caution:** Check the shape and orientation of the connectors on any cable you plan to connect. Do not force a connector into a port if it does not fit. The device or your projector could be damaged or could malfunction.

[Connecting to Computer Sources](#)

[Connecting to Video Sources](#)

[Connecting External Output Devices](#)

[Connecting to External USB Devices](#)

[Connecting to a Document Camera](#)

**Parent topic:** [Setting Up the Projector](#)

## Connecting to Computer Sources

Follow the instructions in these sections to connect a computer to the projector.

[Connecting to a Computer for HDMI Video and Audio](#)

[Connecting to a Computer for VGA Video and Audio](#)

[Connecting to a Computer for USB Video and Audio](#)

**Parent topic:** [Projector Connections](#)

### Connecting to a Computer for HDMI Video and Audio

If your computer has an HDMI port, you can connect it to the projector using an HDMI cable.

**Note:** To connect a Mac that includes only a Mini DisplayPort, Thunderbolt port, USB-C port, or Mini-DVI port for video output, you need to obtain an adapter that allows you to connect to the projector's **HDMI** port. Contact Apple for compatible adapter options. Older Mac computers (2009 and earlier) may not support audio through the **HDMI** port.

1. Connect the HDMI cable to your computer's HDMI output port.
2. Connect the other end to one of the projector's HDMI ports.

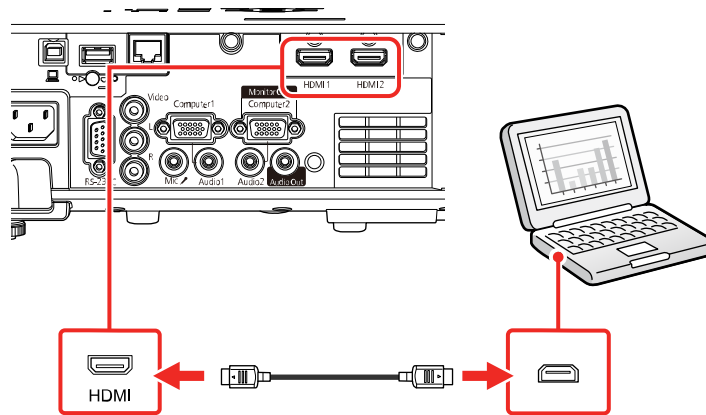

**Note:** The projector converts the digital audio signal sent from your computer into a mono analog signal for the internal speaker or a stereo analog signal if you are connecting to external speakers. (Make sure the HDMI audio playback device on your computer's audio settings is set to **EPSON PJ**.)

**Note:** If you have problems hearing audio through the HDMI connection, you can use one of the projector's audio ports instead to play sound. Connect one end of an optional 3.5 mm stereo mini-jack audio cable to one of the projector's audio ports and the other end to your computer's audio out port. Then select the audio port you connected to as the **HDMI1 Audio Output** or **HDMI2 Audio Output** setting in the Signal I/O menu.

**Parent topic:** [Connecting to Computer Sources](#)

### Connecting to a Computer for VGA Video and Audio

You can connect the projector to your computer using a VGA computer cable.

**Note:** To connect a Mac that includes only a Mini DisplayPort, Thunderbolt port, USB-C port, or Mini-DVI port for video output, you need to obtain an adapter that allows you to connect to the projector's VGA video port. Contact Apple for compatible adapter options.

**Note:** To project an image source connected to the **Computer2/Monitor Out** port, set **Monitor Out Port** to **Computer2** in the projector's Signal I/O menu. You can also set the port to input audio when

projecting the computer source as the **Audio Output** setting in the projector's Signal I/O menu. Make sure the audio cable is labeled "No resistance."

1. If necessary, disconnect your computer's monitor cable.
2. Connect the VGA computer cable to your computer's monitor port.
3. Connect the other end to a **Computer** port on the projector.

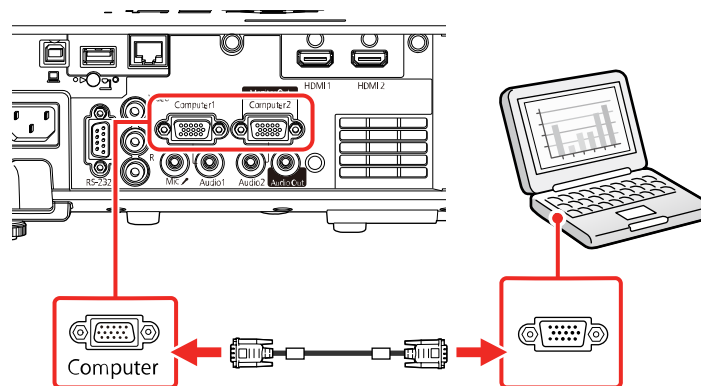

4. Tighten the screws on the VGA connector.
5. Connect an audio cable to your laptop's headphone or audio out jack, or your desktop's speaker or audio out port.
6. Connect the other end to the **Audio** port that corresponds to the **Computer** port you are using.

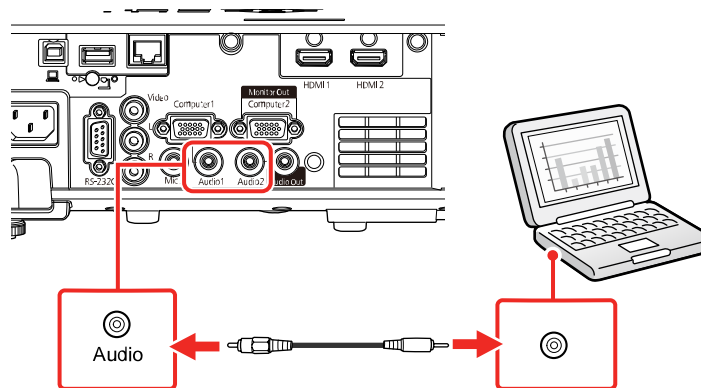

Parent topic: [Connecting to Computer Sources](#)

### Connecting to a Computer for USB Video and Audio

If your computer meets the system requirements, you can send video and audio output to the projector through the computer's USB port (preferably USB 2.0). Connect the projector to your computer using a USB cable.

**Note:** An HDMI connection is recommended for projecting content requiring high bandwidth.

**Note:** Connecting through a USB hub may not work properly. Connect the USB cable directly to the projector.

1. Turn on the projector, if necessary.
2. Turn on your computer.
3. Connect the cable to your projector's **USB-B** port.

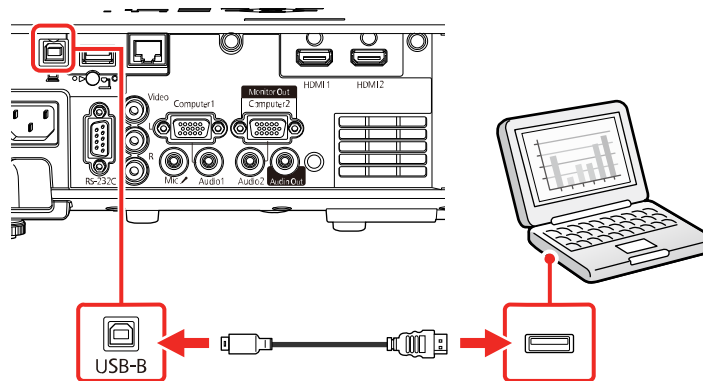

4. Connect the other end to any available USB port on your computer.
5. Do one of the following:
  - **Windows 11/Windows 10/Windows 8.x:** Click **EPSON\_PJ\_UD** when it appears on the desktop, then select **Run EMP\_UDSE.EXE** in the dialog box that appears to install the Epson USB Display software.
  - **Windows 7/Windows Vista:** Select **Run EMP\_UDSE.EXE** in the dialog box that appears to install the Epson USB Display software.



- **Mac:** The USB Display setup folder appears on your screen. Select **USB Display Installer** and follow the on-screen instructions to install the Epson USB Display software.

Follow any on-screen instructions. You need to install this software only the first time you connect the projector to the computer.

The projector displays the image from your computer's desktop and outputs sound, if your presentation contains audio.

**Parent topic:** [Connecting to Computer Sources](#)

## Connecting to Video Sources

Follow the instructions in these sections to connect video devices to the projector.

[Connecting to an HDMI Video Source](#)

[Connecting to a Composite Video Source](#)

**Parent topic:** [Projector Connections](#)

### Connecting to an HDMI Video Source

If your video source has an HDMI port, you can connect it to the projector using an HDMI cable. The HDMI connection provides the best image quality.

**Caution:** Do not turn on the video source before connecting it to the projector. Doing so could damage the projector.

1. Connect the HDMI cable to your video source's HDMI output port.
2. Connect the other end to one of the projector's **HDMI** ports.

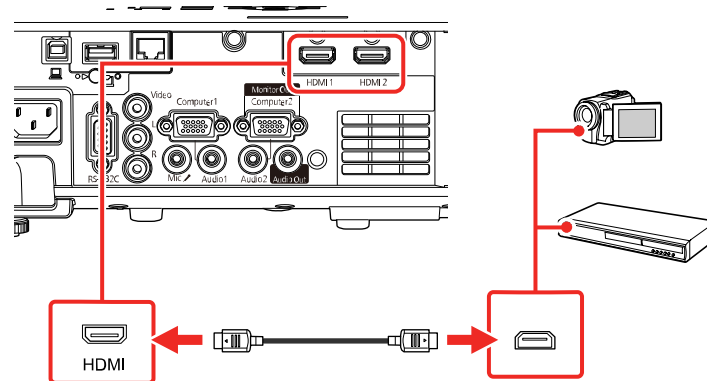

**Note:** The projector converts the digital audio signal sent from your video source into a mono analog signal for the internal speaker or a stereo analog signal if you are connecting to external speakers.

**Note:** If you have problems hearing audio through the HDMI connection, you can use one of the projector's audio ports instead to play sound. Connect one end of an optional 3.5 mm stereo mini-jack audio cable to one of the projector's audio ports and the other end to your video source's audio out port. Then select the audio port you connected to as the **HDMI1 Audio Output** or **HDMI2 Audio Output** setting in the Signal I/O menu.

**Parent topic:** [Connecting to Video Sources](#)

### Connecting to a Composite Video Source

If your video source has a composite video port, you can connect it to the projector using an optional RCA-style video or A/V cable.

You can play sound through the projector's speaker system by connecting a commercially available RCA audio cable. Make sure the audio cable is labeled "No Resistance."

1. Connect the cable with the yellow connector to your video source's yellow video output port.
2. Connect the other end to the projector's **Video** port.

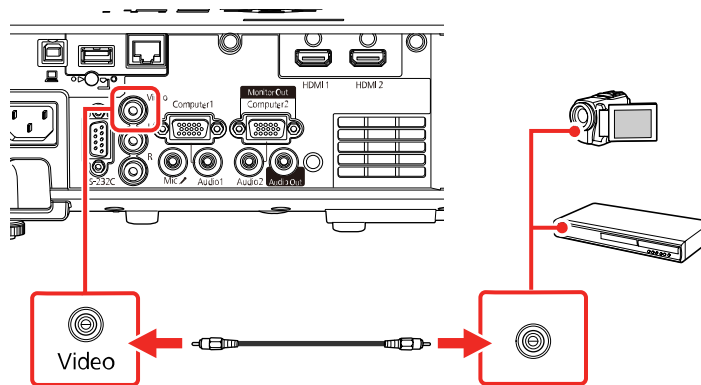

3. Connect the audio cable to your video source's audio out ports.

4. Connect the other end to the projector's **L** and **R** audio ports.

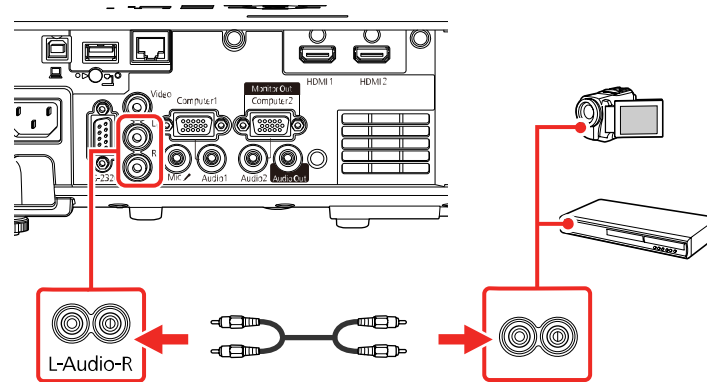

Parent topic: [Connecting to Video Sources](#)

## Connecting External Output Devices

See these sections to connect the projector to external output devices.

[Connecting to an External Computer Monitor](#)

[Connecting to External Speakers](#)

[Connecting a Microphone](#)

Parent topic: [Projector Connections](#)

### Connecting to an External Computer Monitor

If you connected a computer to the projector's **Computer1** port, you can also connect an external monitor to the projector. This lets you see your presentation on the external monitor even when the projected image is not visible.

To output images to an external VGA monitor, set the **Monitor Out Port** setting to **Monitor Out** in the projector's Signal I/O menu.

If you want to output images to an external monitor when the projector is turned off, you need to select **Always On** as the **A/V Output** setting in the projector's Signal I/O menu.

**Note:** Monitors that use a refresh rate less than 60 Hz may not be able to display images correctly.

1. Make sure your computer is connected to the projector's **Computer1** port.

2. Connect the external monitor's cable to your projector's **Monitor Out/Computer 2** port.

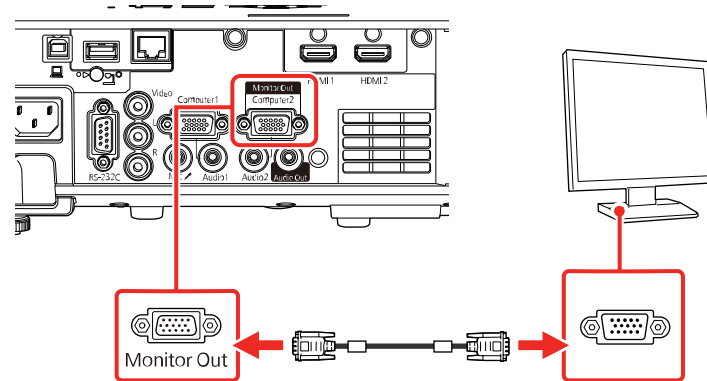

**Parent topic:** [Connecting External Output Devices](#)

### Connecting to External Speakers

You can connect the projector to external self-powered speakers and control the volume using the projector's remote control.

You can also connect the projector to an amplifier with speakers.

Set the **Audio Out Device** setting to **AV System** in the projector's Signal I/O > **HDMI Link** menu. When an audio/video system is not connected to the projector, audio is output from the external speakers even if **Audio Out Device** is set to **AV System**.

If you want to output audio from the external speakers when the projector is turned off, you need to select **Always On** as the **A/V Output** setting in the projector's Signal I/O menu.

**Note:** The projector's built-in speaker system is disabled when you connect external speakers.

1. Make sure your computer or video source is connected to the projector with both audio and video cables as necessary.
2. Locate the appropriate cable to connect your external speakers, such as a stereo mini-jack-to-pin-jack cable, or another type of cable or adapter.
3. Connect one end of the cable to your external speakers as necessary.

4. Connect the stereo mini-jack end of the cable to your projector's **Audio Out** port.

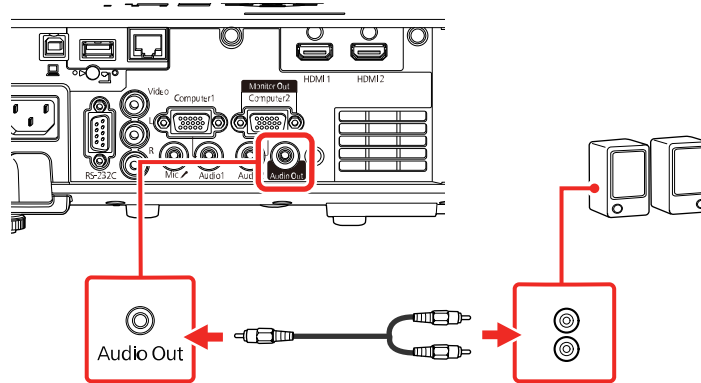

Parent topic: [Connecting External Output Devices](#)

### Connecting a Microphone

You can connect a microphone to the projector's **Mic** port to provide audio support during presentations.

**Note:** The projector does not support plug-in-power microphones. If you want to output audio from the microphone when the projector is off, select **Always On** as the **A/V Output** setting in the Signal I/O menu.

1. Connect the microphone cable to the projector's **Mic** port.

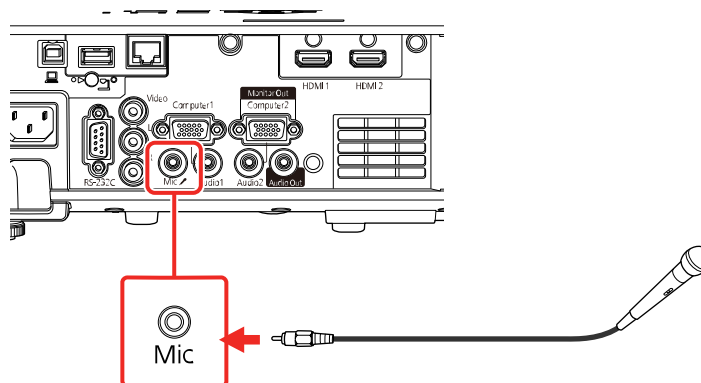

2. Turn on the microphone, if necessary.
3. If you hear a crackling noise or the volume is too high or low, adjust the **Mic Input Level** setting in the Signal I/O menu.

**Parent topic:** [Connecting External Output Devices](#)

## Connecting to External USB Devices

Follow the instructions in these sections to connect external USB devices to the projector.

[USB Device Projection](#)

[Connecting a USB Device or Camera to the Projector](#)

[Selecting the Connected USB Source](#)

[Disconnecting a USB Device or Camera From the Projector](#)

**Parent topic:** [Projector Connections](#)

### USB Device Projection

You can project images and other content without using a computer or video device by connecting any of these devices to your projector:

- USB flash drive
- Digital camera or smartphone
- USB hard drive

**Note:** Digital cameras or smartphones must be USB-mounted devices, not TWAIN-compliant devices, and must be USB Mass Storage Class-compliant.

**Note:** USB hard drives must meet these requirements:

- USB Mass Storage Class-compliant (not all USB Mass Storage Class devices are supported)
- Formatted in FAT16 or FAT32
- Self-powered by their own AC power supplies (bus-powered hard drives are not recommended)
- Does not have multiple partitions

You can project slide shows from image files on a connected USB device.

You can also project playlists that contain images and movies saved on a USB device when in Content Playback mode.

**Parent topic:** [Connecting to External USB Devices](#)

## Connecting a USB Device or Camera to the Projector

You can connect your USB device or camera to the projector's **USB-A** port and use it to project images and other content.

1. If your USB device came with a power adapter, plug the device into an electrical outlet.
2. Connect the USB cable (or USB flash drive) to the projector's **USB-A** port.

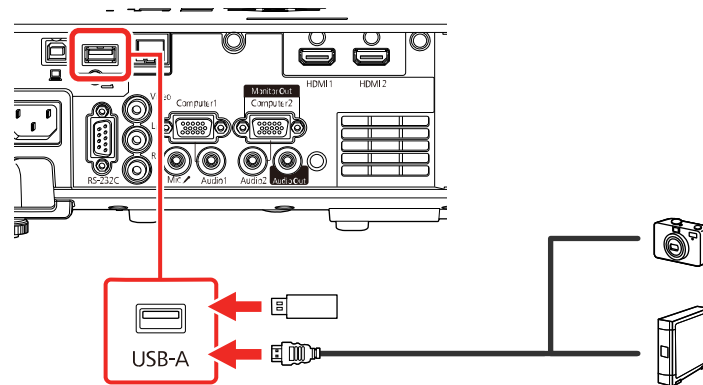

**Note:** Use the USB cable supplied with or specified for use with your device. Do not connect a USB hub or a USB cable longer than 10 feet (3 m), or the device may not operate correctly.

3. Connect the other end of the cable (if applicable) to your device.

**Parent topic:** [Connecting to External USB Devices](#)

## Selecting the Connected USB Source

You can switch the projector's display to the source you connected to the **USB-A** port.

1. Make sure the connected USB source is turned on, if necessary.
2. Press the **USB** or **Source Search** button on the remote control.

**Parent topic:** [Connecting to External USB Devices](#)

## Disconnecting a USB Device or Camera From the Projector

When you finish presenting with a connected USB device or camera, you must prepare to disconnect the device from the projector.

1. If the device has a power button, turn off and unplug the device.

2. Disconnect the USB device or camera from the projector.

**Parent topic:** [Connecting to External USB Devices](#)

## Connecting to a Document Camera

You can connect a document camera to your projector to project images from the camera.

**Note:** The connection method varies depending on your document camera model. For additional features supported by software, connect your document camera to your computer using the camera's USB port instead of connecting the camera to the projector. See the document camera manual for details.

**Parent topic:** [Projector Connections](#)

## Installing Batteries in the Remote Control

The remote control uses the two AA batteries that came with the projector. Replace the batteries as soon as they run out.

**Caution:** Use only the type of batteries specified in this manual. Do not install batteries of different types, or mix new and old batteries.

1. Remove the battery cover.

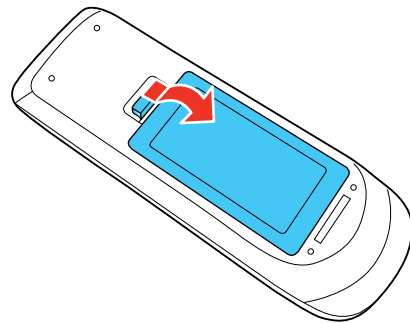



2. Insert the batteries with the + and – ends facing as shown.

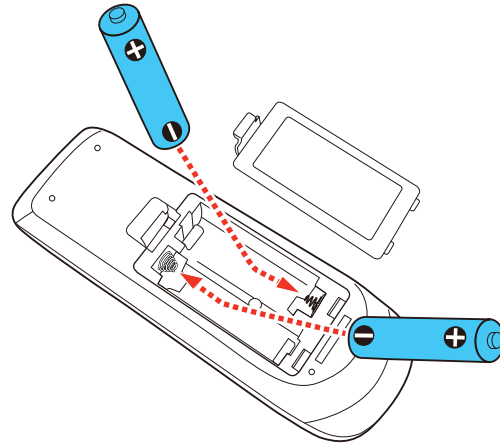

3. Replace the battery cover and press it down until it clicks into place.

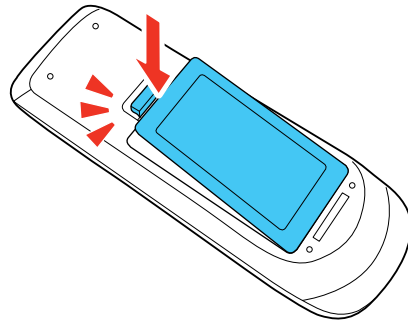

**Warning:** Dispose of used batteries according to local regulations. Do not expose batteries to heat or flame. Keep batteries out of the reach of children; they are choking hazards and are very dangerous if swallowed.

**Parent topic:** [Setting Up the Projector](#)

---

# Using the Projector on a Network

Follow the instructions in these sections to set up your projector for use on a network.

[Wired Network Projection](#)

[Wireless Network Projection](#)

[Wireless Network Projection from a Mobile Device or Windows Computer \(Screen Mirroring\)](#)

[Setting Up Projector Network E-Mail Alerts](#)

[Setting Up Monitoring Using SNMP](#)

[Controlling a Networked Projector Using a Web Browser](#)

[Using Crestron Connected](#)

[Registering a Digital Certificate on the Projector](#)

[Art-Net Channel Definitions](#)

## Wired Network Projection

You can project through a wired network. To do this, you connect the projector to your network with an Ethernet cable, and then set up your projector and computer for network projection.

After connecting and setting up the projector, install the projector software. You may need to install it from a software CD, if included, or download the software and manuals as necessary.

**Note:** If your projector is connected via a LAN (Ethernet) cable to a network that includes a wireless access point, you can connect to the projector wirelessly through the access point using the Epson network software.

[Connecting to a Wired Network](#)

[Selecting Wired Network Settings](#)

**Parent topic:** [Using the Projector on a Network](#)

## Connecting to a Wired Network

To connect the projector to a wired local area network (LAN), use a 100Base-TX or 10Base-T network cable. To ensure proper data transmission, use a Category 5 shielded cable or higher.

1. Connect one end of the network cable to your network hub, switch, or router.

2. Connect the other end of the cable to the projector's **LAN** port.

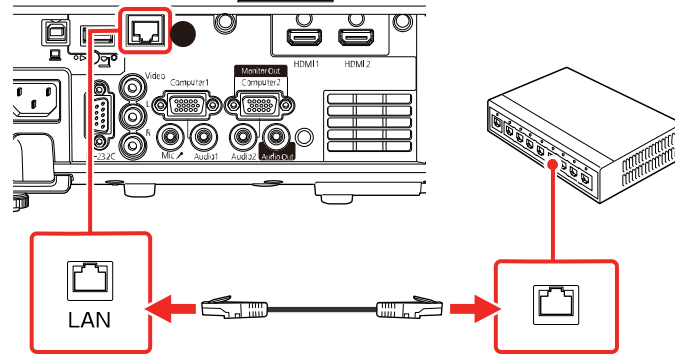

Parent topic: [Wired Network Projection](#)

## Selecting Wired Network Settings

Before you can project from computers on your network, you must select the network settings for the projector using its menu system.

**Note:** Make sure you already connected the projector to your wired network using the **LAN** port.

1. Turn on the projector.
2. Press the **Menu** button.

3. Select the **Network** menu and press **↵ Enter**.

Frequently Used Items	Network
Image	Wireless LAN Info.
Signal I/O	Wired LAN Info.
Installation	Art-Net Channel Information
Display	Network Settings
Operation	Transmitter Settings
Management	Reset Network Settings
<b>Network</b>	Multi-Projection
Multi-Projection	Projector ID                      Off
ECO	Tiling
Initial/All Settings	Geometry Correction              Point Correction
	Edge Blending
	Scale
	Color Uniformity
	Light Source Mode                  Normal
	Color Matching
	RGBCMY
	Reset Multi-Projection Settings

4. Select **Network Settings** and press **↵ Enter**.
5. Select **Projector Name** and enter a name up to 16 alphanumeric characters long to identify the projector on a network.
6. Set the **Priority Control Interface** setting to **Wired LAN**.
7. Select the **Wired LAN** menu and press **↵ Enter**.

[ Wired LAN ]	Return
<b>IP Settings</b>	
DNS Server 1	0.0.0.0
DNS Server 2	0.0.0.0
IPv6	Off <span style="float: right;">▼</span>
IP Address Display	On

8. Select **IP Settings** and press **↵ Enter**.
9. Select your IP settings as necessary:
  - If your network assigns addresses automatically, turn on the **DHCP** setting.
  - If you must set addresses manually, turn off **DHCP** and enter the projector's **IP Address**, **Subnet Mask**, and **Gateway Address** as needed.

**Note:** To highlight the numbers you want from the displayed keyboard, press the arrow buttons on the remote control. To select a highlighted number, press **↵ Enter**. Alternatively, press and hold the **Num** button on the remote control while entering the desired numbers.

10. To prevent display of the IP address on the standby screen, turn off **IP Address Display** in the Wired LAN menu.
11. Select **Return** and press **↵ Enter** to return to the Network Settings menu.
12. Select **Network Projection** and press **↵ Enter**.

You see a screen like this:

[ Network Projection ]		Return
Projector Keyword	Off	
Epson iProjection	On	^
SSID Display	On	
Display LAN Info.	Text & QR Code	
Moderator Password		
Keyword Interrupt Display	Off	
Screen Mirroring	On	^
Interrupt Connection	On	
Adjust Image Quality	1 (Fine)	
Screen Mirroring Info.	On	
Message Broadcasting	Off	
Screen Sharing	On	

13. Set the **Projector Keyword** setting to **On** if you want to prevent access to the projector by anyone not in the room with it.

**Note:** When this setting is enabled, you must enter a displayed, randomized keyword from a computer using Epson iProjection to access the projector and share the current screen.

14. Set the **Epson iProjection** setting to **On**.

15. Select the following options as necessary:

- **SSID Display** lets you display the SSID on the network information screen and home screen.
- **Display LAN Info** lets you select how the projector displays network information. You can select an option to display a QR code that lets you quickly connect your iOS or Android devices using the Epson iProjection app.
- **Moderator Password** lets you enter a password up to 4 numbers long for accessing the projector as a moderator with the Epson iProjection (Windows/Mac) software or the Epson iProjection app. (No default password.)
- **Keyword Interrupt Display** lets you select whether to display a projector keyword on the projected image when accessing the projector using Epson iProjection.

**Note:** Use the displayed keyboard to enter the password and keyword. Press the arrow buttons on the remote control to highlight characters and press **↵ Enter** to select them.

16. When you finish selecting settings, select **Return** and press **↵ Enter** to return the **Network Settings** menu.
17. Select **Set**, and follow the on-screen instructions to save your settings and exit the menus.
18. Press the **LAN** button on the remote control and confirm that the correct IP address is displayed on the network information screen.

**Parent topic:** [Wired Network Projection](#)

## Wireless Network Projection

You can project over a wireless network. To do this, you must set up your projector and computer for wireless projection.

There are two ways to connect to your projector wirelessly:

- Creating a Quick Wireless Connection USB Key (Windows only) using the Epson iProjection software
- Configuring the connection manually using the projector's Network menus

After connecting and setting up the projector, install the projector software as necessary. You may need to install it from a software CD, if included, or download the software and manuals as necessary.

**Note:** If your projector is connected via a LAN cable to a network that includes a wireless access point, you can connect to the projector wirelessly through the access point using the Epson network software.

[Connecting Directly to a Smartphone or Tablet](#)

[Using Quick Wireless Connection \(Windows\)](#)

[Selecting Wireless Network Settings Manually](#)

[Selecting Wireless Network Settings in Windows](#)

[Selecting Wireless Network Settings on Mac](#)

[Setting Up Wireless Network Security](#)

[Installing the Wireless LAN Module](#)

**Parent topic:** [Using the Projector on a Network](#)

## Connecting Directly to a Smartphone or Tablet

You can display a QR code on the screen and use it to connect a single smartphone or tablet to your projector with the Epson iProjection app.

1. Download the latest version of the Epson iProjection app from the App Store or Google Play and install it on your smartphone or tablet.
2. Press the **Menu** button on the projector or the remote control.

3. Select the **Management** menu and press **↵ Enter**.

Frequently Used Items	Management	
Image	User Button	Light Source Mode
Signal I/O	User's Logo	
Installation	User Pattern	
Display	Control Panel Lock	Off
Operation	Color Uniformity	
Management	Refresh Mode	
Network	Light Source Calibration	
Multi-Projection	Date & Time	
ECO	Schedule Settings	
Initial/All Settings	Wireless LAN Power	
	Wireless LAN Diagnosis	1
	Log Save Destination	USB and Internal Memory
	Batch Setup Range	
	Language 	English
	Information	
	Display Logs	
	Reset Management Settings	
	Network	

4. Select **On** as the **Wireless LAN Power** setting.



5. Select the **Network** menu and press **↵ Enter**.

Frequently Used Items	Network
Image	Wireless LAN Info.
Signal I/O	Wired LAN Info.
Installation	Art-Net Channel Information
Display	Network Settings
Operation	Transmitter Settings
Management	Reset Network Settings
Network	Multi-Projection
Multi-Projection	Projector ID                      Off
ECO	Tiling
Initial/All Settings	Geometry Correction              Point Correction
	Edge Blending
	Scale
	Color Uniformity
	Light Source Mode                  Normal
	Color Matching
	RGBCMY
	Reset Multi-Projection Settings

6. Select **Network Settings** and press **↵ Enter**.
7. Set the **Priority Control Interface** setting to **Wireless LAN**.

8. Make sure **Simple AP** is set to **On**.
9. Select **Network Projection** and press **↵ Enter**.

[ Network Projection ]		Return
Projector Keyword	Off	
Epson iProjection	On	^
SSID Display	On	
Display LAN Info.	Text & QR Code	
Moderator Password		
Keyword Interrupt Display	Off	
Screen Mirroring	On	^
Interrupt Connection	On	
Adjust Image Quality	1 (Fine)	
Screen Mirroring Info.	On	
Message Broadcasting	Off	
Screen Sharing	On	

10. Turn on the **Projector Keyword** setting if you want to prevent access to the projector by anyone not in the room with it.

**Note:** The projector displays a random keyword that you must enter from a computer using the Epson iProjection (Windows/Mac) software to access the projector.

11. Select **On** as the **Epson iProjection** setting.
12. Select the following settings as necessary:
  - **SSID Display** selects whether to display the SSID on the network standby screen and Home screen.
  - **Display LAN Info** lets you select how the projector displays network information. You can select an option to display a QR code that lets you quickly connect your iOS or Android devices using the Epson iProjection app.

- **Moderator Password** lets you enter a password up to 4 numbers long for accessing the projector as a moderator with the Epson iProjection (Windows/Mac) software or the Epson iProjection app. (No default password.)
  - **Keyword Interrupt Display** lets you select whether to display a projector keyword on the projected image when accessing the projector using Epson iProjection.
13. When you finish selecting settings, select **Return** and press **↩ Enter** to return to the **Network Settings** menu.
  14. Select **Set**, and follow the on-screen instructions to save your settings and exit the menus.
  15. Press the **LAN** button on the remote control.  
Your projector displays a QR code on the projection surface. You can press **↩ Enter** to hide and show the QR code on the screen. If you do not see the QR code, set the **Display LAN Info** setting to **Text & QR Code** in the Network menu.
  16. Open the Epson iProjection app on your smartphone or tablet.
  17. Use the QR code reader feature to read the QR code and connect your device to the projector.

**Note:** The projector and the smartphone must be on the same wireless network in order to establish a connection.

Your smartphone or tablet is now connected to your projector. Visit for information on controlling your projector with the Epson iProjection app.

**Parent topic:** [Wireless Network Projection](#)

## Using Quick Wireless Connection (Windows)

You can create a Quick Wireless Connection USB Key to quickly connect the projector to a Windows computer wirelessly. Then you can project your presentation and remove the key when you are done.

1. Create a Quick Wireless Connection USB Key with a USB flash drive and the Epson iProjection (Windows) software.

**Note:** A USB flash drive is not included with your projector.

**Note:** See the online *Epson iProjection Operation Guide* for instructions.

2. Make sure the wireless LAN module is installed in your projector.
3. Turn on the projector.

4. Press the **LAN** button on the remote control.  
The LAN standby screen is displayed.
5. Verify the SSID and IP address.
6. Insert the USB key into the projector's **USB-A** port.

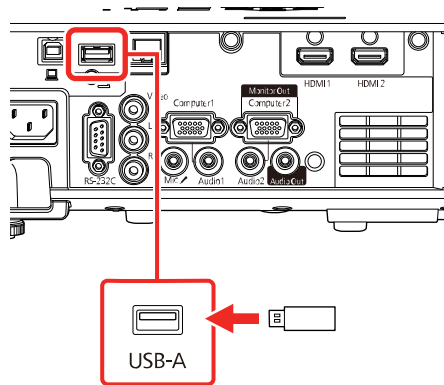

You see a projected message that the network information update is complete.

7. Remove the USB key.
8. Insert the USB key into a USB port on your computer.
9. Follow the on-screen instructions to install the Epson iProjection software.

**Note:** If you see a Windows Firewall message, click **Yes** to disable the firewall. You need administrator authority to install the software. If it is not installed automatically, double-click **MPPLaunch.exe** in the USB key.

After a few minutes, your computer image is displayed by the projector. If it does not appear, press the **LAN** or **Source Search** button on your remote control or restart your computer.

10. Run your presentation as necessary.
11. When you finish projecting wirelessly, select the **Safely Remove Hardware** option in the Windows taskbar, then remove the USB key from your computer.

**Note:** You can share the USB key with other computers without disconnecting your computer. You may need to restart your computer to reactivate your wireless LAN connection.

Parent topic: [Wireless Network Projection](#)

## Selecting Wireless Network Settings Manually

Before you can project from your wireless network, you must select the network settings for the projector using its menu system.

1. Turn on the projector.
2. Press the **Menu** button.
3. Select the **Management** menu and press **↵ Enter**.

Frequently Used Items	Management
Image	User Button Light Source Mode
Signal I/O	User's Logo
Installation	User Pattern
Display	Control Panel Lock Off
Operation	Color Uniformity
Management	Refresh Mode
Network	Light Source Calibration
Multi-Projection	Date & Time
ECO	Schedule Settings
Initial/All Settings	Wireless LAN Power
	Wireless LAN Diagnosis 1
	Log Save Destination USB and Internal Memory
	Batch Setup Range
	Language 🌐 English
	Information
	Display Logs
	Reset Management Settings
	Network

4. Select **On** as the **Wireless LAN Power** setting.

5. Select the **Network** menu and press **↵ Enter**.

Frequently Used Items	Network
Image	Wireless LAN Info.
Signal I/O	Wired LAN Info.
Installation	Art-Net Channel Information
Display	Network Settings
Operation	Transmitter Settings
Management	Reset Network Settings
Network	Multi-Projection
Multi-Projection	Projector ID Off
ECO	Tiling
Initial/All Settings	Geometry Correction Point Correction
	Edge Blending
	Scale
	Color Uniformity
	Light Source Mode Normal
	Color Matching
	RGBCMY
	Reset Multi-Projection Settings

6. Select **Network Settings** and press **↵ Enter**.
7. Select **Projector Name** and enter a name up to 16 alphanumeric characters long to identify the projector on the network.
8. Set the **Priority Control Interface** setting to **Wireless LAN**.
9. Select the connection method:
  - To connect directly to a wireless device (Simple AP mode), set the **Simple AP** setting to **On** and go to step 17.
  - To connect to a device via a wireless network router (infrastructure mode), set the **Simple AP** setting to **Off** and go to the next step.
  - If you installed the optional wireless LAN module and want to use both connection methods, set the **Simple AP** setting to **On** and go to the next step.

10. Select the **Wireless LAN** menu and press **↵ Enter**.

[ Wireless LAN ]	Return	
Search Access Point		
SSID		
Security	Open	
IP Settings		
DNS Server 1	0.0.0.0	
DNS Server 2	0.0.0.0	
IPv6	Off	▼
IP Address Display	On	

11. Select **Search Access Point** and press **↵ Enter**.

The projector searches for wireless networks.

12. Select the network you want to connect to and enter the password, if necessary.

**Note:** If you need to assign the SSID manually, select **SSID** to enter the SSID. The SSID and password are case-sensitive. Make sure you enter them in the correct case.

13. Select **IP Settings** and press **↵ Enter**.

14. Select your IP settings as necessary:

- If your network assigns addresses automatically, turn on the **DHCP** setting.
- If you must set addresses manually, turn off **DHCP** and enter the projector's **IP Address**, **Subnet Mask**, and **Gateway Address** as needed.

**Note:** Do not use these addresses: 0.0.0.0, 127.x.x.x, 192.0.2.x or 224.0.0.0 through 255.255.255.255 (where x is a number from 0 to 255) for **IP Address**, 255.255.255.255 or 0.0.0.0 through 254.255.255.255 for **Subnet Mask**, and 0.0.0.0, 127.x.x.x or 224.0.0.0 through 255.255.255.255 for **Gateway Address**. For DNS Server addresses, do not use the following IP

addresses: 127.x.x.x (where x is a number from 0 to 255). When these settings are not set, DNS server information is acquired using DHCP.

**Note:** To highlight the numbers you want from the displayed keyboard, press the arrow buttons on the remote control. To select a highlighted number, press **↵ Enter**.

15. To prevent display of the IP address on the network information screen, turn off **IP Address Display**.
16. Select **Return** and press **↵ Enter** to return to the Network Settings menu.
17. Select the **Network Projection** menu and press **↵ Enter**.

[ Network Projection ]		Return
Projector Keyword	Off	
Epson iProjection	On	^
SSID Display	On	
Display LAN Info.	Text & QR Code	
Moderator Password		
Keyword Interrupt Display	Off	
Screen Mirroring	On	^
Interrupt Connection	On	
Adjust Image Quality	1 (Fine)	
Screen Mirroring Info.	On	
Message Broadcasting	Off	
Screen Sharing	On	

18. Turn on the **Projector Keyword** setting if you want to prevent access to the projector by anyone not in the room with it.

**Note:** The projector displays a random keyword that you must enter from a computer using the Epson iProjection (Windows/Mac) software to access the projector.

19. Set the **Epson iProjection** setting to **On**.



20. Select the following options as necessary:

- **SSID Display** lets you select whether to display the projector's SSID on the standby screen and Home screen.
- **Display LAN Info** lets you select how the projector displays network information. You can select an option to display a QR code that lets you quickly connect your iOS or Android devices with the Epson iProjection app.
- **Moderator Password** lets you enter a password up to 4 numbers long for accessing the projector as a moderator with the Epson iProjection (Windows/Mac) software or the Epson iProjection app.
- **Keyword Interrupt Display** lets you select whether to display a projector keyword on the projected image when accessing the projector using Epson iProjection.

**Note:** Use the displayed keyboard to enter the password and keyword. Press the arrow buttons on the remote control to highlight characters and press **↵ Enter** to select them.

21. When you finish selecting settings, select **Return** to return to the **Network Settings** menu.

22. Select **Set** and follow the on-screen instructions to save your settings and exit the menus.

After you complete the wireless settings for your projector, you need to select the wireless network on your computer, or iOS or Android device.

**Note:** You can press the **LAN** button on the remote control to check your network security settings after completing the wireless settings.

[Wireless LAN Menu Settings](#)

Parent topic: [Wireless Network Projection](#)

### Wireless LAN Menu Settings

Setting	Options	Description
<b>Search Access Point</b>	—	Search for available wireless network access points in <b>Advanced</b> connection mode
<b>SSID</b>	Up 32 alphanumeric characters	Manually set the SSID (network name) of the wireless LAN system the projector is connecting to

Setting	Options	Description
<b>Security</b>	<b>WPA2/WPA3-PSK</b> <b>WPA2/WPA3-EAP</b> <b>WPA3-PSK</b> <b>WPA3-EAP</b> <b>Open</b>	Selects the type of security used on the wireless network  <b>WPA2/WPA3-PSK:</b> uses WPA2/WPA3 personal mode; encryption is dependent on the access point settings; <b>Passphrase</b> must be the same as the access point  <b>WPA2/WPA3-EAP:</b> uses WPA2/WPA3 enterprise mode; encryption is dependent on the access point settings  <b>WPA3-PSK:</b> uses WPA3 security with AES for encryption. Use the <b>Passphrase</b> value to establish a connection from a computer  <b>WPA3-EAP:</b> uses WPA3 enterprise mode; encryption is dependent on the access point settings
<b>Passphrase</b>	Various passphrases from 8 to 63 characters	Selects the pre-shared key used on the network; passphrases are case-sensitive. If the network settings are reset after the passphrase has been changed more than once, the first passphrase is restored. This setting is only displayed when <b>Security</b> is set to <b>WPA3-PSK</b> or <b>WPA2/WPA3-PSK</b> .

Setting	Options	Description
<b>EAP Type</b>	<b>User name</b> <b>Password</b> <b>Client Certificate</b> <b>Verify Server Certificate</b> <b>CA certificate</b> <b>RADIUS Server Name</b>	Sets the EAP settings for WPA3-EAP and WPA2/WPA3-EAP security
<b>IP Settings</b>	<b>DHCP (On or Off)</b> <b>IP Address</b> <b>Subnet Mask</b> <b>Gateway Address</b>	Selects DHCP if your network assigns IP addresses automatically, or turns off DHCP so you can enter the network's IP address, subnet mask, and gateway address as needed
<b>DNS Server 1/ DNS Server 2</b>	Various IP addresses	Sets the IP address for the DNS server using 0 to 255 for each address field. The DNS server resolves the host name
<b>IPv6</b>	<b>On</b> <b>Off</b>	<p>Enables IPv6 to allow monitoring and control of the projector over a network using Epson Web Control and PLink. When enabled, the following settings are available:</p> <p><b>Auto Configuration:</b> selects whether to automatically assign addresses according to the Router Advertisement</p> <p><b>Use Temporary Address:</b> enables use of a temporary IPv6 address</p>
<b>IP Address Display</b>	<b>On</b> <b>Off</b>	Selects whether to display the IP address on the network standby screen and Home screen

Parent topic: [Selecting Wireless Network Settings Manually](#)

## Selecting Wireless Network Settings in Windows

Before connecting to the projector, select the correct wireless network on your computer.

1. To access your wireless utility software, access the Desktop and double-click the network icon on the Windows taskbar.
2. Do one of the following:
  - If your projector is set up on an existing network, select the network name (SSID).
  - If your projector is configured for a direct wireless connection (Simple AP mode), select the projector's SSID.
3. Click **Connect**.

**Parent topic:** [Wireless Network Projection](#)

## Selecting Wireless Network Settings on Mac

Before connecting to the projector, select the correct wireless network on your Mac.

1. Click the AirPort or Wi-Fi icon on the menu bar at the top of the screen.
2. Make sure AirPort or Wi-Fi is turned on, then do one of the following:
  - If your projector is set up on an existing network, select the network name (SSID).
  - If your projector is configured for a direct wireless connection (Simple AP mode), select the projector's SSID.

**Parent topic:** [Wireless Network Projection](#)

## Setting Up Wireless Network Security

You can set up security for your projector to use on a wireless network. Set up one of the following security options to match the settings used on your network:

- WPA2-PSK (Simple AP mode only)
- WPA3-PSK
- WPA2/WPA3-PSK
- WPA3-EAP
- WPA2/WPA3-EAP

**Note:** To set up WPA3-EAP or WPA2/WPA3-EAP security, register your digital certificate file and place it on a USB storage device for connection to your projector.

1. Press the **Menu** button.
2. Select the **Network** menu and press **↵ Enter**.



3. Select **Network Settings** and press **↵ Enter**.
4. Do one of the following:
  - To connect directly to a wireless device (Simple AP mode), select **Passphrase**, press **↵ Enter**, and enter a passphrase from 8 to 63 characters long. When you are done, return to the **Network Settings** screen, select **Set**, and follow the on-screen instructions to save your settings and exit the menus. Skip the rest of these steps.
  - To connect to a device via a wireless network router (infrastructure mode), select the **Wireless LAN** menu and press **↵ Enter**. Continue with the next step.
5. Select the **Security** setting and press **↵ Enter**.
6. Select the security settings for your network.
7. Do one of the following according to the security you selected:
  - **WPA3-PSK** or **WPA2/WPA3-PSK**: Select **Passphrase**, press **↵ Enter**, and enter a passphrase from 8 to 63 characters long. Then continue with step 9.

- **WPA3-EAP** or **WPA2/WPA3-EAP**: Select **EAP Type** and press **↵ Enter**.
8. Select the protocol for authentication as the **EAP Type** setting.
  9. When you are finished, select **Return** and press **↵ Enter** to return to the **Network Settings** menu.
  10. Select **Set**, and follow the on-screen instructions to save your settings and exit the menus.

Parent topic: [Wireless Network Projection](#)

## Installing the Wireless LAN Module

Your projector has a built-in wireless LAN module. If you install an optional Epson 802.11b/g/n wireless LAN module, you can use both network connection methods at the same time. When you install the wireless LAN module, set the **Simple AP** setting to **On**. Do not install any other type of wireless module.

**Caution:** Never remove the module while its indicator light is blue or flashing, or while you are projecting wirelessly. You may damage the module or lose data.

**Note:** The wireless LAN module is not included with your projector.

1. Remove the wireless LAN module cover screw.

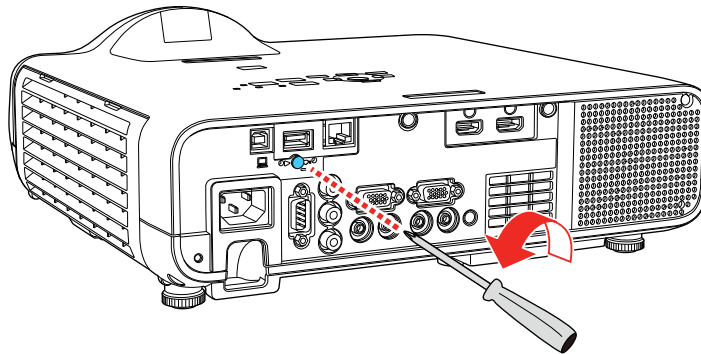

2. Insert the wireless LAN module into a **USB-A** port.

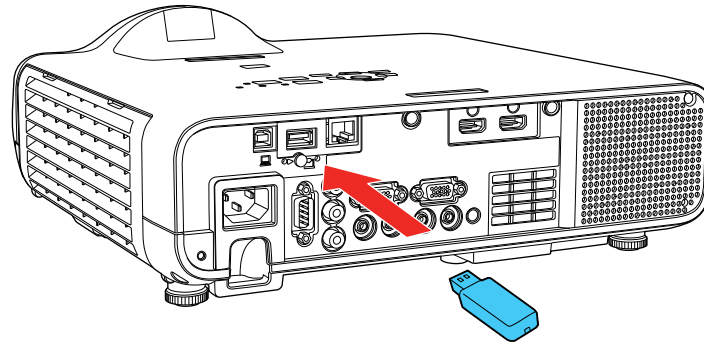

3. Attach the wireless LAN module cover and secure it using the screw you removed.

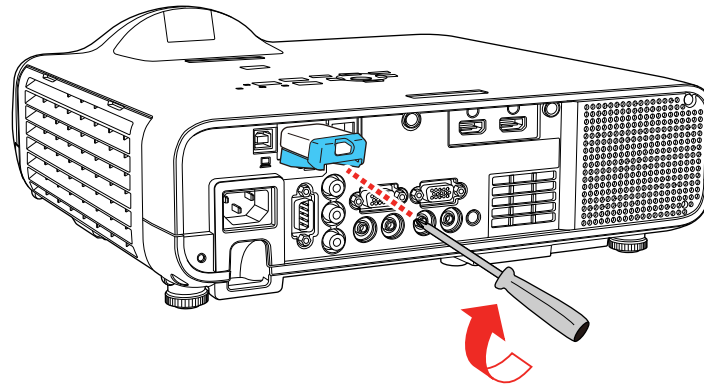

The light on the wireless LAN module turns on when the module is installed and operating. The light flashes when the module is communicating over the network.

Parent topic: [Wireless Network Projection](#)

## Wireless Network Projection from a Mobile Device or Windows Computer (Screen Mirroring)

You can send images to your projector from mobile devices such as laptops, smartphones, and tablets using Miracast technology or from a Windows computer. If your device supports Miracast, you do not

need to install any additional software. When using a Windows computer, make sure the necessary adapter for the Miracast connection is available.

The projector detects the input sources as Screen Mirroring1 and Screen Mirroring2. Set **Interrupt Connection** to **Off**.

[Screen Mirroring Restrictions](#)

[Selecting Screen Mirroring Settings](#)

[Connecting for Screen Mirroring with a Windows 8.x/Windows 10/Windows 11 Computer](#)

[Connecting for Screen Mirroring with Miracast](#)

**Parent topic:** [Using the Projector on a Network](#)

## Screen Mirroring Restrictions

Note the following when using Screen Mirroring features:

- You cannot project an interlaced image.
- You cannot play audio with more than 3 channels.
- You may not be able to project images depending on the resolution and frame rate.
- You cannot project 3D video.
- You cannot use extended Miracast features on Windows 8.1.
- You may not be able to view contents with copyright protection using a Miracast connection.
- Do not change the projector's Screen Mirroring settings during Screen Mirroring projection. Doing so may cause the projector to disconnect and delay reconnection.
- Do not turn off the electrical supply to the projector during Screen Mirroring projection.

**Parent topic:** [Wireless Network Projection from a Mobile Device or Windows Computer \(Screen Mirroring\)](#)

## Selecting Screen Mirroring Settings

You can select Screen Mirroring settings for your projector and then project images from your mobile device.

1. Press the **Menu** button.



2. Select the **Management** menu and press **↵ Enter**.

Frequently Used Items	Management	
Image	User Button	Light Source Mode
Signal I/O	User's Logo	
Installation	User Pattern	
Display	Control Panel Lock	Off
Operation	Color Uniformity	
Management	Refresh Mode	
Network	Light Source Calibration	
Multi-Projection	Date & Time	
ECO	Schedule Settings	
Initial/All Settings	Wireless LAN Power	
	Wireless LAN Diagnosis	1
	Log Save Destination	USB and Internal Memory
	Batch Setup Range	
	Language 	English
	Information	
	Display Logs	
	Reset Management Settings	
	Network	

3. Set the **Wireless LAN Power** setting to **On**.

4. Select the **Network** menu and press **↵ Enter**.

Frequently Used Items	Network
Image	Wireless LAN Info.
Signal I/O	Wired LAN Info.
Installation	Art-Net Channel Information
Display	Network Settings
Operation	Transmitter Settings
Management	Reset Network Settings
<b>Network</b>	Multi-Projection
Multi-Projection	Projector ID Off
ECO	Tiling
Initial/All Settings	Geometry Correction Point Correction
	Edge Blending
	Scale
	Color Uniformity
	Light Source Mode Normal
	Color Matching
	RGBCMY
	Reset Multi-Projection Settings

5. Select **Network Settings** and press **↵ Enter**.
6. Select **Priority Control Interface** and press **↵ Enter**.
7. Choose one of the following options:
  - If you are casting images over a wired LAN, select **Wired LAN**.
  - If you are casting images wirelessly directly or via a wireless network router, select **Wireless LAN**.
8. Set the **Simple AP** setting to **On**.
9. Select **Network Projection** and press **↵ Enter**.
10. Set the **Screen Mirroring** setting to **On**.
11. Select these settings as necessary:
  - **Interrupt Connection** lets you switch the screen to another device while projecting using Screen Mirroring. If you want to connect two Screen Mirroring sources at once, select **Off**.
  - **Adjust Image Quality** lets you adjust the screen mirroring speed and quality. Select a small number to improve the quality or a large number to increase the speed.

- **Screen Mirroring Info** displays connection information when projecting from a Screen Mirroring source.
12. When you finish selecting settings, select **Return** and press **↩ Enter** to return to the **Network Settings** screen.
  13. Select **Set**, and follow the on-screen instructions to save your settings and exit the menus.
- Parent topic:** [Wireless Network Projection from a Mobile Device or Windows Computer \(Screen Mirroring\)](#)

## Connecting for Screen Mirroring with a Windows 8.x/Windows 10/Windows 11 Computer

You can set up your computer to wirelessly project images and play sound using Screen Mirroring.

**Note:** If you are using Windows 10, you can cast images over a local area network or from your device to the projector directly. When you cast images over a local area network, the connection is more stable and secure. Connect the projector to the network with an Ethernet cable or install the optional wireless LAN module and set the wireless LAN settings to connect to a wireless network.

1. Select the Screen Mirroring settings on your projector as necessary.
2. Press the **LAN** button on the remote control to switch to the Screen Mirroring source.  
You see the Screen Mirroring standby screen.
3. Do one of the following:
  - **Windows 11:** Open **Settings** and select **System > Display > Multiple displays > Connect**
  - **Windows 10:** Hold down the Windows key and press **K** at the same time.
  - **Windows 8.x:** Select **Devices > Project > Add a wireless display**.
4. Select your projector from the list.

**Note:** You can check the **Projector Name** in the projector's Network menu (**Menu > Network > Network Settings > Projector Name**) to identify your projector in the list.

5. If you see the PIN entry screen on your computer, enter the PIN code displayed on the Screen Mirroring standby screen or at the bottom right of the projected image.  
The projector displays the image from your computer or mobile device.

**Note:** It may take some time to establish the connection. Do not disconnect the projector's power cord while it is connecting to your device. This may cause your device to freeze or malfunction.

**Parent topic:** [Wireless Network Projection from a Mobile Device or Windows Computer \(Screen Mirroring\)](#)

## Connecting for Screen Mirroring with Miracast

If your mobile device supports Miracast, you can connect it to the projector wirelessly and project images and sound.

1. Select the Screen Mirroring settings on your projector as necessary.
2. Press the **LAN** button on the remote control to switch to the Screen Mirroring source.  
You see the Screen Mirroring standby screen.
3. On your mobile device, use the Miracast function to search for the projector.

**Note:** See your mobile device's documentation for information on accessing the Miracast function.

You see a list of available devices.

4. Select your projector from the list.
5. If you see the PIN entry screen on your mobile device, enter the PIN code displayed on the Screen Mirroring standby screen or at the upper left of the projected image.

The projector displays the image from your mobile device.

**Caution:** It may take some time to establish the connection. Do not disconnect the projector's power cord while it is connecting to your device. Doing so may cause your device to freeze or malfunction.

**Note:** Depending on the mobile device, you may need to delete a device when connecting. Follow the on-screen instructions on your device.

**Parent topic:** [Wireless Network Projection from a Mobile Device or Windows Computer \(Screen Mirroring\)](#)

## Setting Up Projector Network E-Mail Alerts

You can set up the projector to send you an e-mail alert over the network if there is a problem with the projector.

**Note:** If the **Standby Mode** setting is set to **Communication On** in the **Operation** menu, you can receive e-mail alerts even if the projector is in standby mode (the power is off). The **Standby Mode** setting is displayed only if the **A/V Output** setting in the Signal I/O menu is set to **While Projecting**.

1. Press the **Menu** button.
2. Select the **Network** menu and press **↵ Enter**.



3. Select **Network Settings** and press **↵ Enter**.
4. Select the **Mail Notification** menu and press **↵ Enter**.

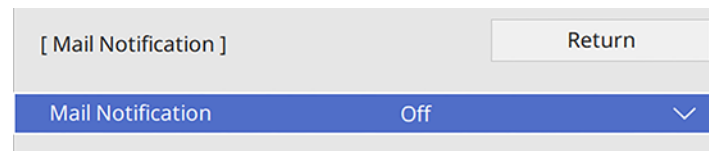

5. Turn on **Mail Notification**.

6. Enter the IP address for the **SMTP Server** setting.  
  
**Note:** Do not use 127.x.x.x (where x is a number from 0 to 255).
7. Select a type of **Authentication** for the SMTP server.
8. Select a number for the SMTP server **Port Number** setting, from 0 to 65535 (default is 25).
9. Enter a **User Name** for the SMTP server.
10. Enter a **Password** for the SMTP server authentication.
11. Enter the sender's email address as the **From** setting.
12. Choose an **Address** field, enter the e-mail address, and select the alerts you want to receive there. Repeat for up to three addresses. Your e-mail address can be up to 64 alphanumeric characters long.
13. If you are using the PJLink protocol for projector control, turn on the **PJLink** setting in the Projector Control menu and enter the IP address where you want to receive PJLink notifications as the **Notified IP Address** setting.
14. When you finish selecting settings, select **Return** and press **↵ Enter** to return to the **Network Settings** menu.
15. Select **Set**, and follow the on-screen instructions to save your settings and exit the menus.

**Note:** If a critical problem causes a projector to shut down, you may not receive an e-mail alert.

[Network Projector E-mail Alert Messages](#)

**Parent topic:** [Using the Projector on a Network](#)

## Network Projector E-mail Alert Messages

When a problem occurs with a networked projector, and you selected to receive e-mail alerts, you receive an e-mail containing the following information:

- The email address entered as the **From** setting
- **Epson Projector** on the subject line
- The name of the projector experiencing a problem
- The IP address of the affected projector
- Detailed information about the problem

**Note:** If a critical problem causes a projector to shut down, you may not receive an e-mail alert.

**Parent topic:** [Setting Up Projector Network E-Mail Alerts](#)

## Setting Up Monitoring Using SNMP

Network administrators can install SNMP (Simple Network Management Protocol) software on network computers so they can monitor projectors. If your network uses this software, you can set up the projector for SNMP monitoring.

1. Press the **Menu** button.
2. Select **Network > Network Settings > Projector Control > SNMP > On**.
3. If no SNMP **Community Name** has been set, a screen appears prompting you to set one.  
Enter the SNMP **Community Name** (up to 32 alphanumeric characters).
4. Enter up to two IP addresses to receive SNMP notifications as the **Trap IP Address 1** and **Trap IP Address 2** settings, using 0 to 255 for each address field.

**Note:** To enter the IP address using the numeric keys on the remote control, press and hold the **Num** button. Do not use these addresses: 224.0.0.0 through 255.255.255.255. This projector supports SNMP agent version 1 (SNMPv1).

5. When you finish selecting settings, select **Return** and press **↩ Enter** to return to the **Network Settings** menu.
6. Select **Set**, and follow the on-screen instructions to save your settings and exit the menus.

**Parent topic:** [Using the Projector on a Network](#)

## Controlling a Networked Projector Using a Web Browser

Once you have connected your projector to your network, you can select projector settings and control projection using a compatible web browser. This lets you access the projector remotely.

**Note:** The web setup and control features support Microsoft Edge, Google Chrome, and Safari on networks that do not use a proxy server for connection. You cannot select all of the projector menu settings or control all projector functions using a web browser.

**Note:** If you set **Standby Mode** to **Communication On** in the Operation menu, you can use a web browser to select settings and control projection even if the projector is in standby mode (the power is

off). The **Standby Mode** setting is displayed only if the **A/V Output** setting in the Signal I/O menu is set to **While Projecting**.

1. Make sure the projector is turned on.
2. Start your web browser on a computer or device connected to the network.
3. Type the projector's IP address into the browser's address box and press the computer's **Enter** key (if you are entering an IPv6 address, wrap the address with [ and ]).

**Note:** You can find the projector's IP address in the projector's Network menu or on the LAN input screen.

**Note:** If you attempt to connect to the Web Control screen via a proxy server, the screen will not be displayed. Make a direct connection to the Web Control screen.

**Caution:** Do not remove the USB flash drive from the projector or disconnect the projector's power cord when the **Playlists** or **USB Memory Device** screens are displayed in Content Playback mode. Data saved on the flash drive may be damaged.

You see a Web Control screen like this.



In normal mode:

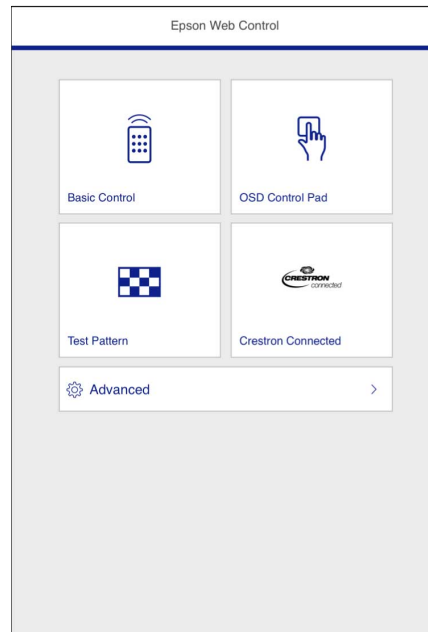

In Content Playback mode:

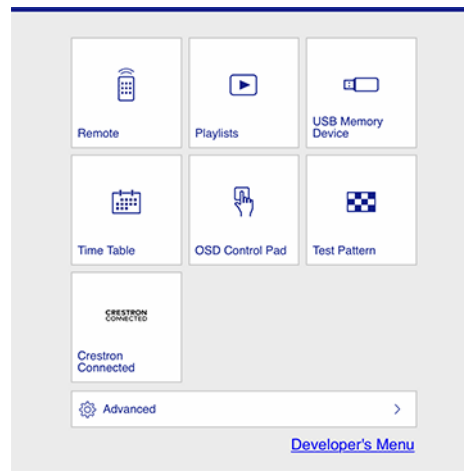

**Note:** To disable this mode, set **Content Playback** to **Off** in the Operation menu.

4. To control projection remotely, select the **Basic Control** option from the Web Control screen.

**Note:** If you see a log in window, enter your user name and password. (The default user name is **EPSONREMOTE**. There is no default password.

You see a screen like this:

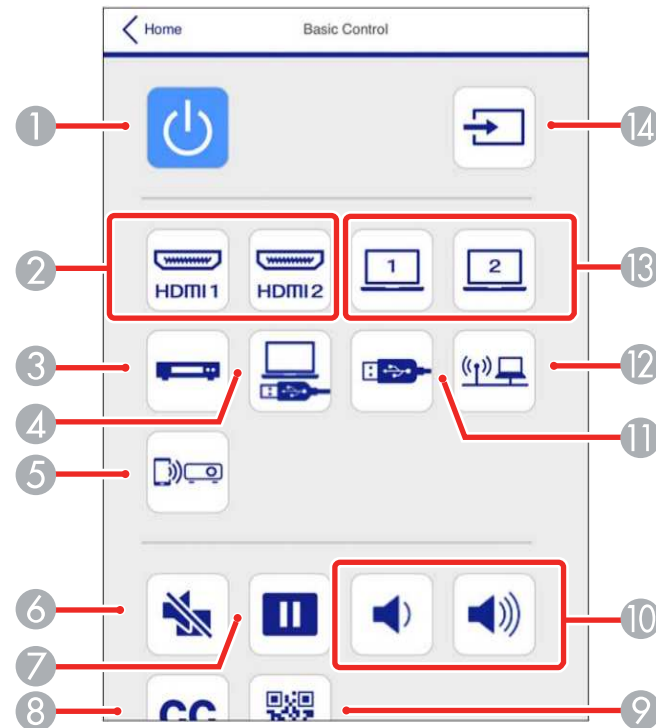

- 1 Power button control
- 2 Selects an **HDMI** port source
- 3 Selects the **Video** port source
- 4 Selects the USB Display source

- 5 Selects the Screen Mirroring source
  - 6 **A/V Mute** button control
  - 7 **Freeze** button control
  - 8 Closed captioning control (not available in all countries)
  - 9 Displays a QR code for connecting with iOS or Android devices using the Epson iProjection app
  - 10 **Volume** button controls
  - 11 Selects the USB device source
  - 12 Selects the network source
  - 13 Selects a **Computer** port source
  - 14 Searches for connected sources
5. Select the icon corresponding to the projector function you want to control.
  6. To select projector menu settings, select **Advanced** on the Web Control screen.

**Note:** If you see a log in window, enter your user name and password. (The default user name is **EPSONWEB**. There is no default password.

7. Select the name of the menu and follow the on-screen instructions.

**Parent topic:** [Using the Projector on a Network](#)

## Using Crestron Connected

If you are using the Crestron Connected network monitoring and control system, you can set up your projector for use on the system. Crestron Connected lets you control and monitor your projector using a web browser.

**Note:** You cannot use the Message Broadcasting feature in the Epson Projector Management software when you use Crestron Connected.

For additional information on Crestron Connected, contact Crestron.

[Setting Up Crestron Connected](#)

[Controlling a Networked Projector Using Crestron Connected](#)

Parent topic: [Using the Projector on a Network](#)

## Setting Up Crestron Connected

To set up your projector for monitoring and control using a Crestron Connected system, make sure your computer and projector are connected to the network.

**Note:** If you are connecting wirelessly, connect to devices over a wireless network access point.

1. Press the **Menu** button.
2. Select the **Network** menu and press **↵ Enter**.

Frequently Used Items	Network
Image	Wireless LAN Info.
Signal I/O	Wired LAN Info.
Installation	Art-Net Channel Information
Display	Network Settings
Operation	Transmitter Settings
Management	Reset Network Settings
Network	Multi-Projection
Multi-Projection	Projector ID Off
ECO	Tiling
Initial/All Settings	Geometry Correction Point Correction
	Edge Blending
	Scale
	Color Uniformity
	Light Source Mode Normal
	Color Matching
	RGBCMY
	Reset Multi-Projection Settings

3. Select **Network Settings** and press **↵ Enter**.

4. Select the **Projector Control** menu and press **↵ Enter**.

[ Projector Control ]		Return
PJLink	Off	▼
SNMP	Off	▼
AMX Device Discovery	Off	
Crestron Connected	Off	
Control4 SDDP	Off	
Art-Net	On	
Secure HTTP	On	▲
Web Server Certificate		

5. Set the **Crestron Connected** setting to **On** to allow the projector to be detected.

**Note:** Enabling Crestron Connected disables the Message Broadcasting feature in the Epson Projector Management software. To enable the Crestron XiO Cloud service, set **Crestron XiO Cloud** to **On**.

6. When you are finished selecting settings, select **Return** and press **↵ Enter** to return to the **Network Settings** menu.
7. Select **Set**, and follow the on-screen instructions to save your settings and exit the menus.
8. Turn off the projector, then turn it on again to enable the setting.
9. Start your Web browser on a computer or device connected to the network.
10. Go to the **Epson Web Control** screen by entering the projector's IP address into the browser's address box.
11. Select the **Crestron Connected** settings. See the Crestron Web site for details.

**Parent topic:** [Using Crestron Connected](#)

## Controlling a Networked Projector Using Crestron Connected

Once you have set up your projector to use Crestron Connected, you can control and monitor projection using a compatible web browser.

1. Start your web browser on a computer connected to the network.
2. Type the projector's IP address into the browser's address box and press the computer's **Enter** key.  
You see the Epson Web Control screen:

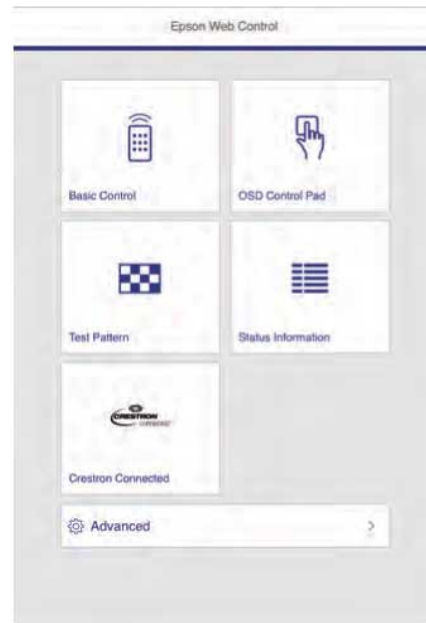

**Note:** You may need to log in to access some of the options on the Web Control screen. If you see a log in window, enter your user name and password.

3. Select **Crestron Connected**.

**Parent topic:** [Using Crestron Connected](#)

## Registering a Digital Certificate on the Projector

Follow the instructions here if you need to install a digital certificate on the projector to provide security for your presentation files.

**Note:** You can register a digital certificate using a web browser or through the projector's Network menu. However, be sure to register just once, or the certificate may not install correctly.

[Importing a Web Server Certificate Using the Projector Menus](#)

[Registering Digital Certificates from a Web Browser](#)

[Digital Certificate Types](#)

**Parent topic:** [Using the Projector on a Network](#)

## Importing a Web Server Certificate Using the Projector Menus

You can create your web server certificate and import it using the projector menus and a USB flash drive.

**Note:** You can also register digital certificates from your web browser. Make sure to only register once, or the certificate may not install correctly.

1. Make sure your digital certificate file is compatible with projector registration and saved in the root directory of the USB flash drive.
2. Press the **Menu** button on the projector or remote control.
3. Select **Network > Network Settings > Projector Control > Secure HTTP > On**.
4. Select the **Web Server Certificate** setting and press **↵ Enter**.
5. Select **Save** and press **↵ Enter**.
6. Follow the on-screen instructions to connect a USB flash drive to the **USB-A** port on the projector.
7. Press **↵ Enter** to display the certificate list.
8. Select the certificate you want to import from the displayed list.  
A message is displayed prompting you to enter the password for the certificate.
9. Enter the password and press **↵ Enter**.

The certificate is imported and a completion message appears.

**Parent topic:** [Registering a Digital Certificate on the Projector](#)

## Registering Digital Certificates from a Web Browser

You can register the digital certificates on the projector for wireless LAN authentication.

**Note:** You can also register the digital certificates in the projector's Network menu. However, be sure to register just once or the certificate may not install correctly.

1. Make sure your digital certificate file is compatible with projector registration.

2. Make sure the projector is turned on.
3. Start your web browser on a computer or mobile device connected to the network.
4. Type the projector's IP address into the browser's address box and press the computer's **Enter** key. You see the Web Control screen and a prompt to enter a user ID and password.
5. Select **Advanced** and enter the following information in uppercase or lowercase letters, exactly as shown:
  - For the user ID, enter **EPSONWEB**. (You cannot change the user ID.)
  - For the password, enter the default password **admin**. (You can change the Web Control password using the projector's Network Settings menu.)
6. Under **Network**, select **Certificate**.

**Note:** You may need to select the ☰ menu icon to find **Network**, depending on your device.

You see a screen like this:

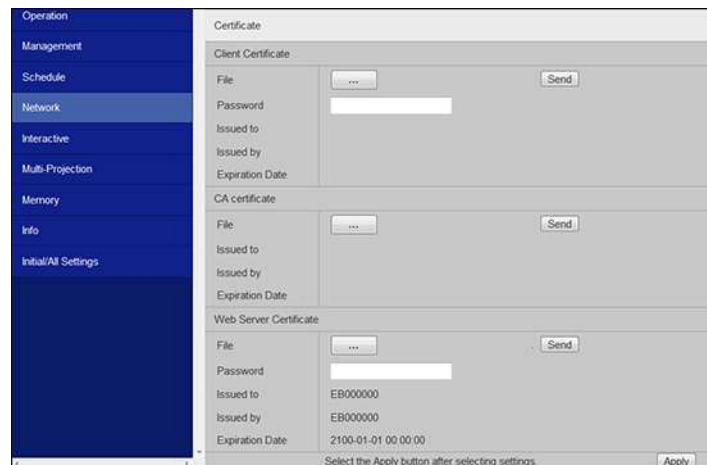

The screenshot shows the 'Certificate' configuration page in the Epson Web Control interface. On the left is a dark blue navigation menu with the following items: Operation, Management, Schedule, Network (highlighted), Interactive, Multi-Projection, Memory, Info, and Initial/All Settings. The main content area is titled 'Certificate' and contains three sections: 'Client Certificate', 'CA certificate', and 'Web Server Certificate'. Each section has a 'File' field with a file selection button and a 'Send' button. The 'Web Server Certificate' section also includes a 'Password' field, and 'Issued to' and 'Issued by' fields both containing 'EB000000', and an 'Expiration Date' field containing '2100-01-01 00:00:00'. At the bottom of the page, there is a note: 'Select the Apply button after selecting settings.' and an 'Apply' button.

7. Click the **Choose File** button, select the certificate file, and click **Open**.

**Note:** The button name may vary depending on the browser you are using.

8. Enter a password in the **Password** box and click **Send**.



9. When you finish registering the certificate, click **Apply** to finalize your changes and complete the registration.

**Parent topic:** [Registering a Digital Certificate on the Projector](#)

## Digital Certificate Types

You can register these types of digital certificates.

### Client Certificate (PEAP-TLS/EAP-TLS)

Specification	Description
Format	PKCS#12
Extension	PFX, P12
Encryption	RSA
Hashes	MD5/SHA-1/SHA-256/SHA-384/SHA-512
Key length	512/1024/2048/4096 bit
Password	Up to 64 alphanumeric characters; required

### CA Certificate (PEAP/PEAP-TLS/EAP-TLS/EAP-FAST)

Specification	Description
Format	X509v3
Extension	DER/CER/PEM
Encryption	RSA
Hashes	MD5/SHA-1/SHA-256/SHA-384/SHA-512
Key length	512/1024/2048/4096 bit
Encoding	BASE64/Binary

### Web Server Certificate (Secure HTTP)

Specification	Description
Format	PKCS#12
Extension	PFX, P12

Specification	Description
Encryption	RSA
Hashes	MD5/SHA-1/SHA-256/SHA-384/SHA-512
Key length	512/1024/2048/4096 bit
Common name	Network host name
Organization	Optional
Password	Up to 64 alphanumeric characters; required

Parent topic: [Registering a Digital Certificate on the Projector](#)

## Art-Net Channel Definitions

Art-Net is an Ethernet communication protocol based on the TCP/IP protocol. You can control the projector by using a DMX controller or an application system.

The following table lists the channel definitions used to control the projector in Art-Net.

Channel/Function	Operation	Parameters	Description
1 Adjusting light (dimming)	0% to 100%	0 to 255 (default is 0)	Adjusts the image brightness
2 Shutter control	Shutter open Non-operational Shutter closed	0 to 63 (default is 128) 64 to 191 192 to 255	Enables/disables A/V Mute
3 Switch source	Non-operational HDMI LAN SD Player Spotlight Non-operational	0 to 7 (default is 0) 8 to 15 16 to 23 24 to 31 32 to 39 40 to 255	Switches to the specified source

<b>Channel/Function</b>	<b>Operation</b>	<b>Parameters</b>	<b>Description</b>
7 Zoom	(+) lens adjustment (large) (+) lens adjustment (medium) (+) lens adjustment (small) Non-operational (-) lens adjustment (small) (-) lens adjustment (medium) (-) lens adjustment (large)	0 to 31 (default is 128) 32 to 63 64 to 95 96 to 159 160 to 191 192 to 223 224 to 255	Zooms using the specified amount of movement
8 Electronic focus	(+) lens adjustment (large) (+) lens adjustment (medium) (+) lens adjustment (small) Non-operational (-) lens adjustment (small) (-) lens adjustment (medium) (-) lens adjustment (large)	0 to 31 (default is 128) 32 to 63 64 to 95 96 to 159 160 to 191 192 to 223 224 to 255	Performs electronic focus using the specified amount of movement

<b>Channel/Function</b>	<b>Operation</b>	<b>Parameters</b>	<b>Description</b>
10 Content playback	Non-operational	0 to 3 (default is 0)	Plays the specified playlist
	Playlist 1	4 to 7	
	Playlist 2	8 to 11	
	Playlist 3	12 to 15	
	Playlist 4	16 to 19	
	Playlist 5	20 to 23	
	Playlist 6	24 to 27	
	Playlist 7	28 to 31	
	Playlist 8	32 to 35	
	Playlist 9	36 to 39	
	Playlist 10	40 to 43	
	Playlist 11	44 to 47	
	Playlist 12	48 to 51	
	Playlist 13	52 to 55	
	Playlist 14	56 to 59	
	Playlist 15	60 to 63	

Channel/Function	Operation	Parameters	Description
10 Content playback	Playlist 16	64 to 67	
	Playlist 17	68 to 71	
	Playlist 18	72 to 75	
	Playlist 19	76 to 79	
	Playlist 20	80 to 83	
	Playlist 21	84 to 87	
	Playlist 22	88 to 91	
	Playlist 23	92 to 95	
	Playlist 24	96 to 99	
	Playlist 25	100 to 103	
	Playlist 26	104 to 107	
	Playlist 27	108 to 111	
	Playlist 28	112 to 115	
	Playlist 29	116 to 119	
	Playlist 30	120 to 123	
	Playlist 31	124 to 127	
	Playlist 32	128 to 131	
	Playlist 33	132 to 135	
	Playlist 34	136 to 139	
	Playlist 35	140 to 143	
Playlist 36	144 to 147		
Playlist 37	148 to 151		
Playlist 38	152 to 155		
Playlist 39	156 to 159		
Playlist 40	160 to 163		

Channel/Function	Operation	Parameters	Description
10 Content playback	Playlist 41	164 to 167	
	Playlist 42	168 to 171	
	Playlist 43	172 to 175	
	Playlist 44	176 to 179	
	Playlist 45	180 to 183	
	Playlist 46	184 to 187	
	Playlist 47	188 to 191	
	Playlist 48	192 to 195	
	Playlist 49	196 to 199	
	Playlist 50	200 to 203	
	Non-operational	204 to 255	
11 Power control	Power off	0 to 63 (default is 128)	Turns the projector power on or off
	Non-operational	64 to 191	
	Power on	192 to 255	
13 Lock	Cannot control	0 to 127 (default is 0)	Enables/disables Art-Net operations
	Can control	128 to 255	

**Note:** If you are controlling the projector using Art-Net and operating it from the remote control, settings made by the DMX controller or application software may differ from the projector's actual status. If you want to apply all the channel controls to the projector, set Channel 13 to **Cannot control**, then set it back to **Can control**.

**Parent topic:** [Using the Projector on a Network](#)

---

# Using Basic Projector Features

Follow the instructions in these sections to use your projector's basic features.

[Turning On the Projector](#)

[Turning Off the Projector](#)

[Selecting the Language for the Projector Menus](#)

[Setting the Date and Time](#)

[Adjusting the Image Height](#)

[Image Shape](#)

[Resizing the Image with the Wide and Tele Buttons](#)

[Setting the Screen Type](#)

[Adjusting the Image Position Using Screen Position](#)

[Displaying a Test Pattern](#)

[Focusing the Image Using the Focus Ring](#)

[Remote Control Operation](#)

[Selecting an Image Source](#)

[Projection Modes](#)

[Image Aspect Ratio](#)

[Color Mode](#)

[Adjusting the Hue, Saturation, and Brightness](#)

[Adjusting Gamma](#)

[Adjusting the Image Resolution](#)

[Adjusting the Projector's Brightness Level](#)

[Turning On Dynamic Contrast](#)

[Controlling the Volume with the Volume Buttons](#)

[Selecting a Quick Startup Setting](#)

[Projecting a PC Free Presentation](#)

[Projecting in Content Playback Mode](#)

## Turning On the Projector

Turn on the computer or video equipment you want to use before you turn on the projector so it can display the image source.

**Note:** When first powering on the projector, the initial setup wizard is displayed. Use the arrow and **Enter** buttons on the control panel or remote control to follow the on-screen instructions.

1. Remove the projector's lens cover.
2. Connect the power cord to the projector's power inlet.

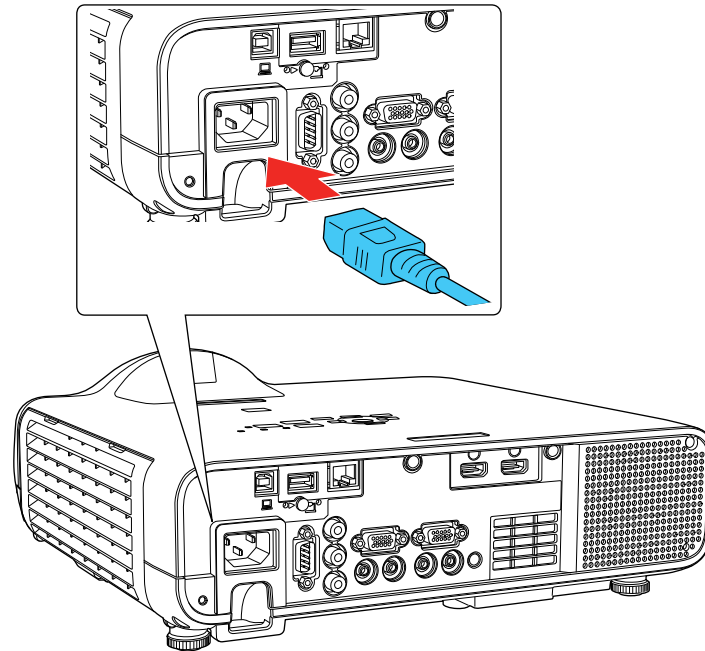

3. Plug the power cord into an electrical outlet.

The projector's power light turns blue. This indicates that the projector is receiving power.

**Note:** With **Direct Power On** turned on, the projector turns on as soon as you plug it in. If you enable the **Auto Power On** setting in the projector's Operation menu, the projector turns on when it detects a signal or cable connection from the selected port.

4. Press the power button on the projector or remote control to turn on the projector.

The projector beeps and the Status light flashes blue as the projector warms up. After about 30 seconds, the Status light stops flashing and turns blue.



**Note:** When **Quick Startup** is enabled in the projector's Operation menu, the projector becomes ready for use in several seconds the next time you press the power button.

**Warning:** Never look into the projector lens when the laser is on. This can damage your eyes and is especially dangerous for children and pets. If you are using the remote control to turn the projector on, make sure no one is looking into the lens or in front of the projector before turning it on.

**Caution:** Make sure no objects are blocking the light from the projector lens. Objects blocking the lens for an extended time can melt and light that is reflected back into the lens can cause the projector to malfunction.

If you do not see a projected image right away, try the following:

- Make sure the lens cover is off.
- Turn on the connected computer or video device.
- Insert a DVD or other video media and press the play button, if necessary.
- Press the **Source Search** button on the projector or remote control to detect the video source.

**Note:** If the **Auto Source Search** setting in the Operation menu is enabled, the projector automatically detects the input signal when you turn it on.

- Change the screen output from the computer when using a laptop.
- Press the button for the video source on the remote control.
- If the Home screen is displayed, select the source you want to project.

[Using the Home Screen](#)

**Parent topic:** [Using Basic Projector Features](#)

## Using the Home Screen

You can select input sources and other frequently used options from the Home screen.

1. To display the Home screen, do one of the following:
  - Press the **Home** button on the control panel or remote control.
  - Turn on the projector with the **Home Screen Auto Disp** setting enabled.
  - Turn on the projector when no signal is received from the selected input source.

2. Press the arrow buttons on the remote control or control panel to navigate the screen, and press **Enter** to select an option.

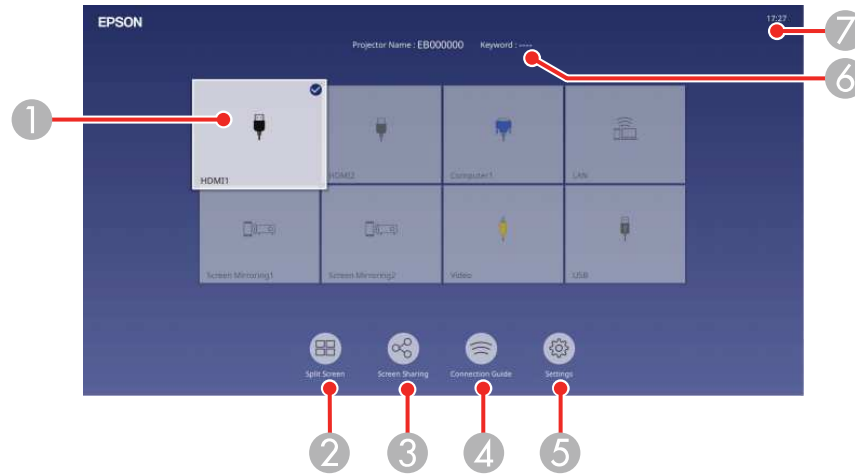

- 1 Selects the source you want to project  
A checkmark appears in the upper right corner of the current input source. For most sources, a preview of the input image appears as a thumbnail.
- 2 Projects images from two or four input sources simultaneously in a grid format
- 3 Sends images to or views images from other projectors connected to the same network
- 4 Displays the Connection Guide  
You can view steps for different wireless connection methods depending on the devices you are using, such as smartphones or computers.

- 5 Lets you select the following common projector settings (these settings may vary depending on other selected settings):
  - **Color Mode**
  - **Brightness Level**
  - **Volume**
  - **E-Zoom**
  - **Geometry Correction (H/V-Keystone and Quick Corner are available)**
  - **Aspect**
- 6 Displays the projector name and the projector keyword
- 7 Displays the current time

**Note:** The Home screen closes after 10 minutes of inactivity.

**Parent topic:** [Turning On the Projector](#)

## Turning Off the Projector

Before turning off the projector, shut down any computer connected to it so you can see the computer display during shutdown.

**Note:** Turn off this product when not in use to prolong the life of the projector. Laser life will vary depending upon mode selected, environmental conditions, and usage. Brightness decreases over time.

**Note:** Since the projector supports the direct shutdown feature, it can be turned off directly using the breaker.

1. Press the power button on the projector or the remote control.

The projector displays a shutdown confirmation screen.

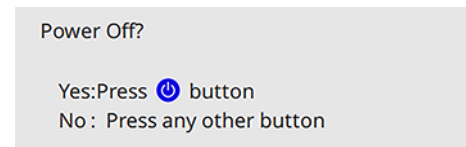

2. Press the power button again. (To leave it on, press any other button.)

The projector beeps twice, the laser turns off, and the Status light turns off.

**Note:** With Epson's Instant Off technology, there is no cool-down period so you can pack up the projector for transport right away (if necessary).

**Note:** If the **Light Source Calibration** setting is set to **Run Periodically** in the projector's Management menu, light source calibration starts automatically if you turn off the projector and the following conditions are present (EB-L210SF):

- 100 hours have passed since the last light source calibration.
- You have used the projector continuously for at least 20 minutes.

3. To transport or store the projector, make sure the power light is blue (not flashing) and the light is off, then unplug the power cord.

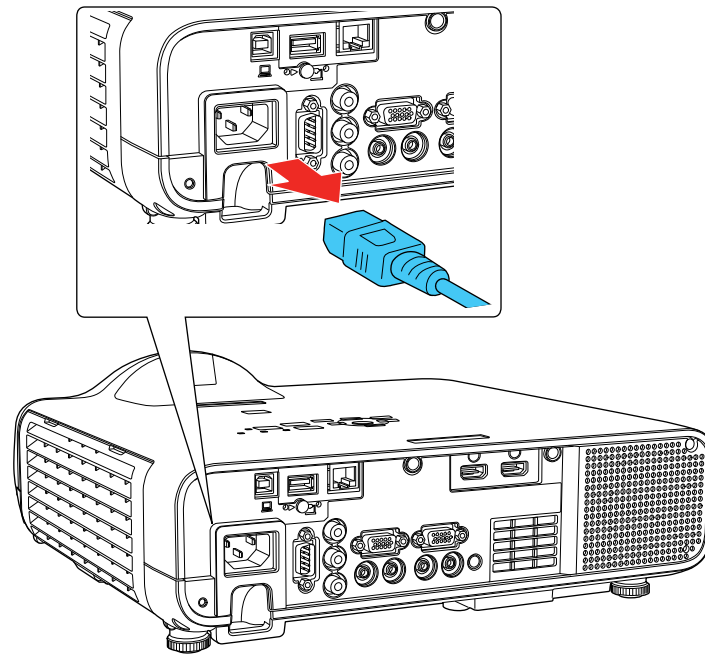

**Caution:**

Parent topic: [Using Basic Projector Features](#)

## Selecting the Language for the Projector Menus

If you want to view the projector's menus and messages in another language, you can change the Language setting.

1. Turn on the projector.
2. Press the **Menu** button.
3. Select the **Management** menu and press **↵ Enter**.



Frequently Used Items	Management
Image	User Button Light Source Mode
Signal I/O	User's Logo
Installation	User Pattern
Display	Control Panel Lock Off
Operation	Color Uniformity
Management	Refresh Mode
Network	Light Source Calibration
Multi-Projection	Date & Time
ECO	Schedule Settings
Initial/All Settings	Wireless LAN Power
	Wireless LAN Diagnosis 1
	Log Save Destination USB and Internal Memory
	Batch Setup Range
	Language  English
	Information
	Display Logs
	Reset Management Settings
	Network

4. Select the **Language** setting and press **↵ Enter**.
5. Select the language you want to use and press **↵ Enter**.
6. Press **Menu** or **Esc** to exit the menus.

Parent topic: [Using Basic Projector Features](#)

## Setting the Date and Time

You can set the date and time for the projector.

1. Press the **Menu** button.
2. Select the **Management** menu and press **↵ Enter**.
3. Select the **Date & Time** setting and press **↵ Enter**.

You see a screen like this:

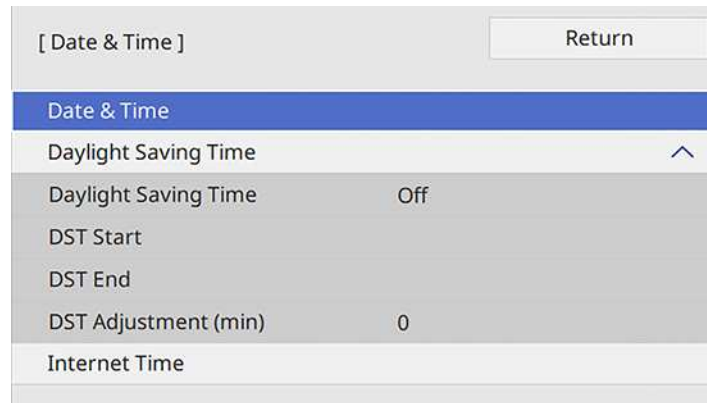

4. Select the **Date & Time** setting and press **↵ Enter**.
5. Select **Date**, press **↵ Enter**, and use the displayed keyboard to enter today's date.
6. Select **Time**, press **↵ Enter**, and use the displayed keyboard to enter the current time.
7. Adjust the **Time Difference (UTC)** settings to set the time difference from the Coordinated Universal Time.

**Note:** If you use this setting, enter Coordinated Universal Time as the **Time** setting instead of your local time.

8. When you are finished, select **Set** and press **↵ Enter**.
9. To activate daylight saving time, select the **Daylight Saving Time** setting and set it to **On**. Then select settings.
10. When you are finished, select **Set** and press **↵ Enter**.
11. To update the time automatically through an internet time server, select the **Internet Time** setting and set it to **On**.
12. Select **Internet Time** and press **↵ Enter**.

13. Enter the IP address for the Internet time server you want to use and select **OK**.
14. Select **Set** and press **↵ Enter**.
15. Press **Menu** or **Esc** to exit the menus.

**Parent topic:** [Using Basic Projector Features](#)

## Adjusting the Image Height

If you are projecting from a table or other flat surface, and the image is too high or low, you can adjust the image height using the projector's adjustable feet.

**Note:** The more you tilt the projector, the harder it will be to focus the projected image. Place the projector so that you only need to tilt it at small angles.

1. Turn on the projector and display an image.
2. To adjust the front foot, pull up on the foot release lever and lift the front of the projector.

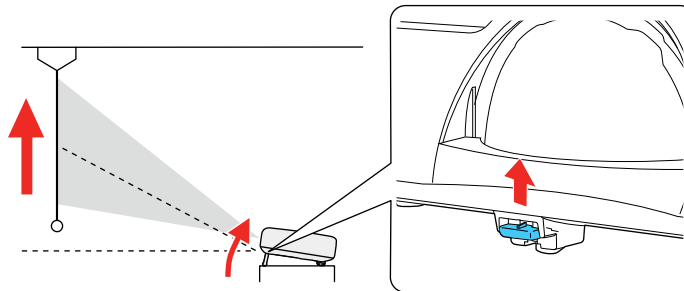

The foot extends from the projector.

3. Release the lever to lock the foot.

4. If the image is tilted, rotate the rear feet to adjust their height.

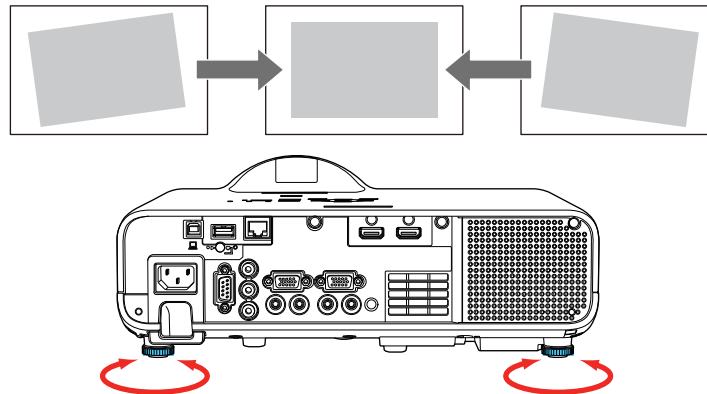

If the projected image is unevenly rectangular, you need to adjust the image shape.

**Parent topic:** [Using Basic Projector Features](#)

## Image Shape

You can project an evenly rectangular image by placing the projector directly in front of the center of the screen and keeping it level. If you place the projector at an angle to the screen, or tilted up or down, or off to the side, you may need to correct the image shape for the best display quality. After correction, your image is slightly smaller.

[Correcting Image Shape with the Horizontal Keystone Slider](#)

[Correcting Image Shape with the Keystone Buttons](#)

[Correcting Image Shape with Quick Corner](#)

[Correcting Image Shape with Arc Correction](#)

[Correcting Image Shape with Point Correction](#)

**Parent topic:** [Using Basic Projector Features](#)

## Correcting Image Shape with the Horizontal Keystone Slider

You can use the projector's horizontal keystone slider to correct the shape of an image that is unevenly rectangular horizontally, such as when the projector is placed to the side of the projection area.

You can make effective corrections when the projection angle is about 15° right or left.



**Note:** To provide the best possible image quality, adjust the projector's position to correct the image shape. If this isn't possible, use the horizontal keystone slider on the projector to correct the image shape.

1. Turn on the projector and display an image.
2. Adjust the slider until the image is evenly rectangular.

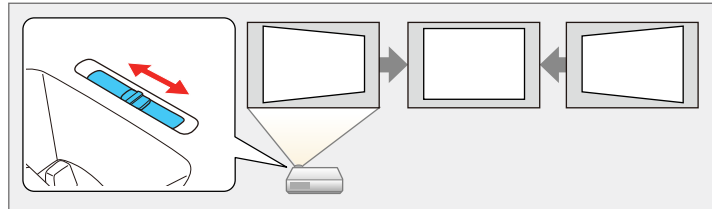

After correction, your image is slightly smaller.

**Parent topic:** [Image Shape](#)

## Correcting Image Shape with the Keystone Buttons

You can use the projector's keystone correction buttons to correct the shape of an image that is unevenly rectangular on the sides.

**Note:** You can use the keystone buttons to correct the image up to 30° left, right, up, or down.

**Note:** You cannot combine keystone correction with other correction methods at the same time.

**Note:** To provide the best possible image quality, adjust the projector's position to correct the image shape. If this isn't possible, use the keystone correction buttons on the projector to correct the image shape.

**Note:** If you change the **Screen Type** or **Screen Position** settings, your image adjustments are reset.

1. Turn on the projector and display an image.
2. Press one of these keystone buttons on the control panel to display the Keystone adjustment screen.

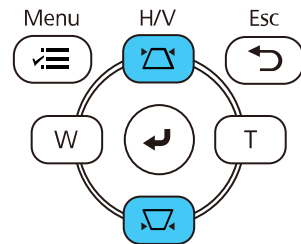

3. Press a keystone button on the projector's control panel to adjust the image shape.

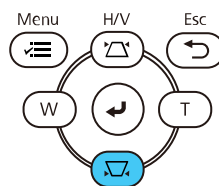
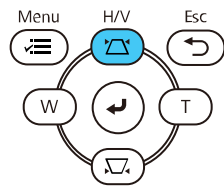
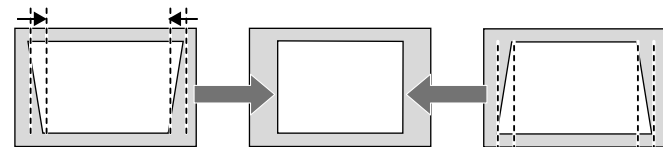
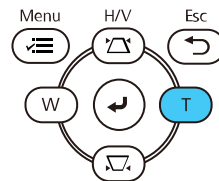
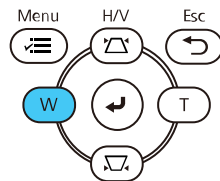
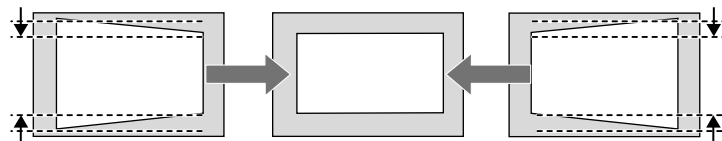

**Note:** The horizontal keystone adjustment buttons are labeled **W** and **T**.

After correction, your image is slightly smaller.

**Note:** If the projector is installed out of reach, you can also correct the image shape with the remote control using the **H/V-Keystone** settings in the projector menus.

Parent topic: [Image Shape](#)

## Correcting Image Shape with Quick Corner

You can use the projector's Quick Corner setting to correct the shape and size of an image that is unevenly rectangular on all sides.

**Note:** To provide the best possible image quality, adjust the projector's position to correct the image shape. If this isn't possible, use the Quick Corner setting to correct the image shape.

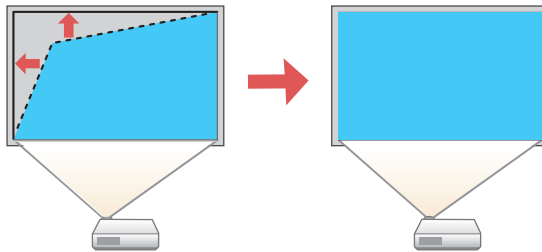

**Note:** If you change the **Screen Type** or **Screen Position** settings, your image adjustments are reset.

1. Turn on the projector and display an image.
2. Press the **Menu** button.

3. Select the **Installation** menu and press **↵ Enter**.

Frequently Used Items	Installation
Image	Fixed Installation Off
Signal I/O	Test Pattern
Installation	Projection Front/Ceiling
Display	Geometry Correction Point Correction
Operation	Digital Zoom
Management	Remote Receiver Off
Network	Screen Type 16:9
Multi-Projection	High Altitude Mode Off
ECO	Reset Installation Settings
Initial/All Settings	Display
	Pattern Display
	Pattern Type
	No-signal Screen Blue
	Startup Screen On
	Home Screen Auto Disp. On
	Messages On
	Menu Rotation Off

4. Select the **Geometry Correction** setting and press **↵ Enter**.
5. Select the **Quick Corner** setting and press **↵ Enter**.

You see the Quick Corner adjustment screen:

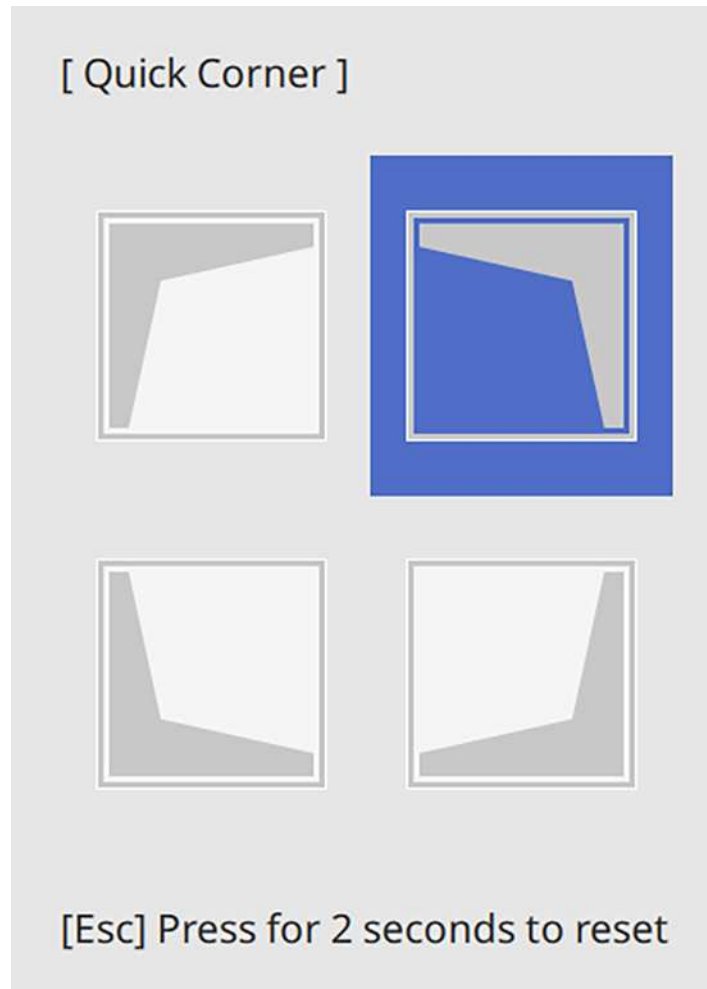

6. Use the arrow buttons on the projector or remote control to select the corner of the image you want to adjust. Then press **↵ Enter**.

**Note:** To reset your adjustments, press and hold the **Esc** button for at least 2 seconds to display a reset screen. Then select **Yes**.

- Press the arrow buttons to adjust the image shape as necessary. Press **↵ Enter** to return to the area selection screen.

**Note:** You can also use the numeric buttons on the remote control to adjust the image shape. If one of the directional arrows on the screen turns gray, you cannot adjust the shape any further in that direction.

- When you are finished, press **Esc**.

Parent topic: [Image Shape](#)

## Correcting Image Shape with Arc Correction

You can use the projector's Arc Correction setting to adjust the curve or arc of the sides of your image.

**Note:** If you change the **Screen Type** or **Screen Position** settings, your image adjustments are reset.

- Turn on the projector and display an image.
- Press the **Menu** button.
- Select the **Installation** menu and press **↵ Enter**.

Frequently Used Items	Installation	
Image	Fixed Installation	Off
Signal I/O	Test Pattern	
Installation	Projection	Front/Ceiling
Display	Geometry Correction	Point Correction
Operation	Digital Zoom	
Management	Remote Receiver	Off
Network	Screen Type	16:9 <span>∨</span>
Multi-Projection	High Altitude Mode	Off
ECO	Reset Installation Settings	
Initial/All Settings	Display	
	Pattern Display	
	Pattern Type	
	No-signal Screen	Blue
	Startup Screen	On
	Home Screen Auto Disp.	On
	Messages	On
	Menu Rotation	Off

4. Select the **Geometry Correction** setting and press **↵ Enter**.
5. Select the **Arc Correction** setting and press **↵ Enter**. Then select the **Arc Correction** setting and press **↵ Enter** again.

You see the Arc Correction adjustment screen:

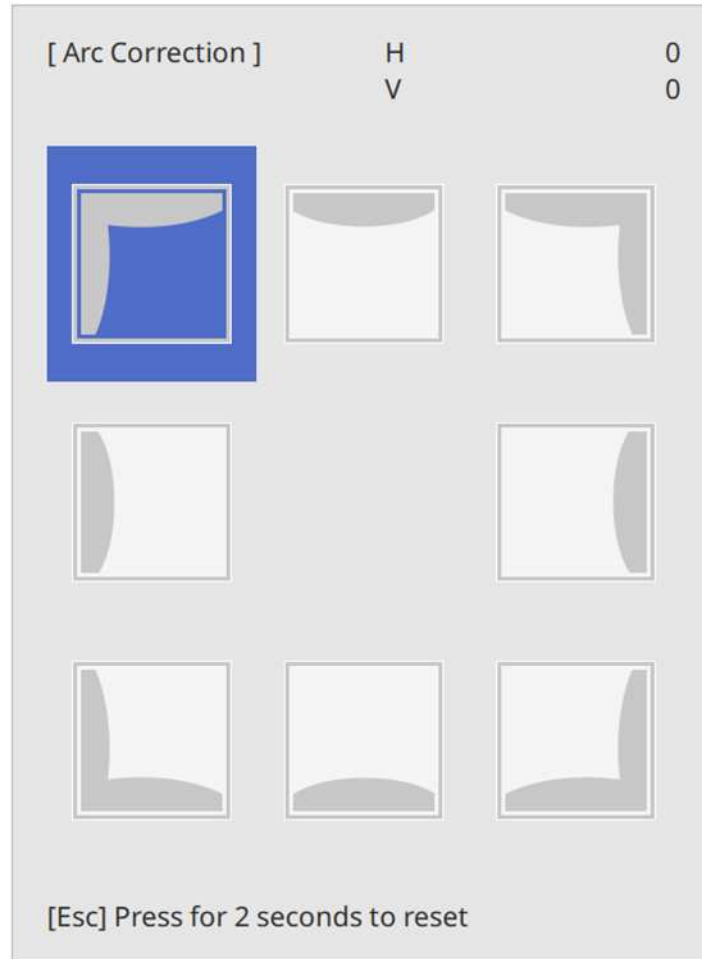

**Note:** To reset your adjustments, press the **Esc** button for at least 2 seconds to display a reset screen, and select **Yes**.

6. Use the arrow buttons on the projector or the remote control to select the corner or side of the image you want to adjust. Then press **↵ Enter**.
7. Press the arrow buttons to adjust the image shape as necessary.
8. When you are finished, press **Esc**.

**Parent topic:** [Image Shape](#)

## Correcting Image Shape with Point Correction

You can use the projector's Point Correction feature to fine-tune the image shape using points on a grid. This is useful for adjusting overlapping areas in multiple projected images that do not line up correctly.

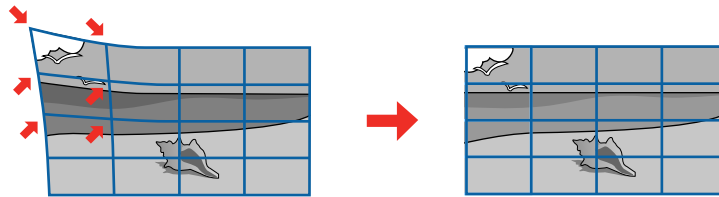

**Note:** If you change the **Screen Type** or **Screen Position** settings, your image adjustments are reset.

1. Turn on the projector and display an image.
2. Press the **Menu** button.
3. Select **Installation > Geometry Correction > Point Correction**.

**Note:** If you see a confirmation message, select **Yes** and press **↵ Enter**.

4. Select the **Point Correction** setting again and press **↵ Enter**.

**Note:** For fine tuning, select **Quick Corner** to roughly correct the shape and size of an image and then select **Point Correction** to adjust them more precisely.

5. Select the number of grid lines to display and press **↵ Enter**.  
You see a grid on the projected image.

**Note:** If you need to change the color of the grid lines, press **Esc** and then select a different **Pattern Color** setting in the Point Correction menu.



6. Press the arrow buttons on the projector or remote control to move to the point on the grid that you want to adjust. Then press **↵ Enter**.

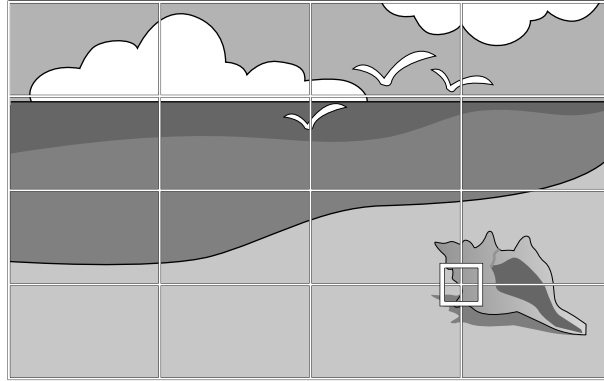

7. Press the arrow buttons as necessary to correct the image shape.

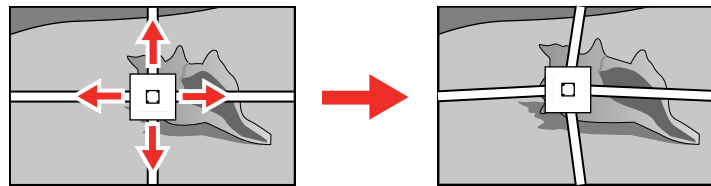

8. Press **Esc** to return to the previous screen and select another point to correct, if necessary.
9. When you are finished, press the **Menu** button.

**Note:** If necessary, you can fine-tune your image adjustments using the **Quick Corner** setting.

**Note:** To reset your adjustments, select **Reset** on the Point Correction screen.

Parent topic: [Image Shape](#)

## Resizing the Image with the Wide and Tele Buttons

You can resize the image using the Wide and Tele buttons. Wait at least 30 minutes after you start projecting to adjust the image size.

1. Turn on the projector and display an image.
2. To enlarge the image size, press the **W** (Wide) button on the projector's control panel.
3. To reduce the image size, press the **T** (Tele) button.

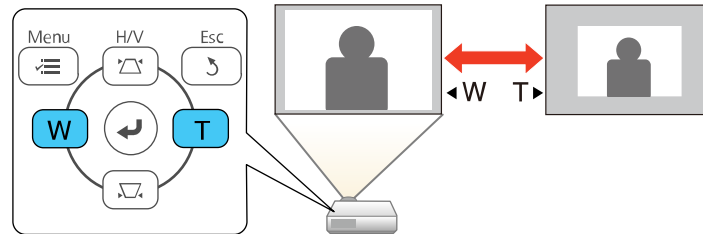

**Note:** If the projector is installed out of reach, you can also adjust the image size with the remote control using the **Digital Zoom** setting in the projector menus.

Parent topic: [Using Basic Projector Features](#)

## Setting the Screen Type

You can use the Screen Type setting to match the aspect ratio of the displayed image to the screen you are using.

**Note:** This setting is unavailable when using the **USB** or **LAN** input source.

**Note:** If you change the **Screen Type** setting, the **EDID** settings are automatically adjusted. You cannot change the **Screen Type** setting when the **Content Playback** setting is enabled.

**Note:** Certain screen type settings are only available on select projector models.

1. Turn on the projector and display an image.
2. Press the **Menu** button.
3. Select the **Installation** menu and press **↵ Enter**.
4. Select the **Screen Type** setting and press **Enter**.  
You see a screen like this:
5. Select your screen's aspect ratio and press **↵ Enter**.

6. Press the **Menu** button to exit.
7. Turn off the projector, then turn it on again to enable the setting.
8. Adjust the aspect ratio for the projected image, if necessary.

**Parent topic:** [Using Basic Projector Features](#)

## Adjusting the Image Position Using Screen Position

You can adjust the image position if there are margins between the edge of the image and the projected screen frame.

**Note:** This feature is not available if you set the **Screen Type** setting to the same aspect ratio as the projector's native resolution.

1. Turn on the projector and display an image.
2. Press the **Menu** button on the control panel or remote control.
3. Select the **Installation** menu and press **↵ Enter**.

Frequently Used Items	Installation
Image	Fixed Installation Off
Signal I/O	Test Pattern
Installation	Projection Front/Ceiling
Display	Geometry Correction Point Correction
Operation	Digital Zoom
Management	Remote Receiver Off
Network	Screen Type 16:9
Multi-Projection	High Altitude Mode Off
ECO	Reset Installation Settings
Initial/All Settings	Display
	Pattern Display
	Pattern Type
	No-signal Screen Blue
	Startup Screen On
	Home Screen Auto Disp. On
	Messages On
	Menu Rotation Off

4. Select **Screen Position** and press **↵ Enter**.

5. Use the arrow buttons on the remote control or projector to adjust the position of the image.

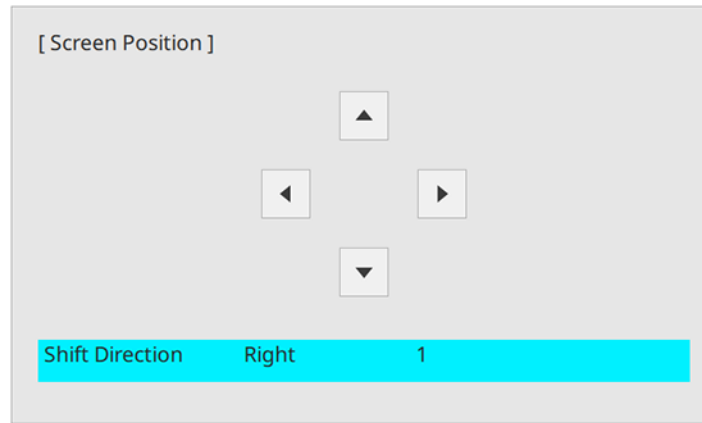

6. When you are finished, press the **Menu** button.

**Parent topic:** [Using Basic Projector Features](#)

## Displaying a Test Pattern

You can display a test pattern to adjust the projected image without connecting a computer or video device.

**Note:** The test pattern's shape is determined by the Screen Type setting. Be sure to set the correct screen type before adjusting with the test pattern.

**Note:** Some menu options may be unavailable when displaying a test pattern and you may need to project from a connected device to change these settings.

1. Turn on the projector.
2. Press the **Menu** button on the remote control.

3. Select the **Installation** menu and press **↵ Enter**.



The screenshot shows a projector settings menu. On the left is a dark blue sidebar with menu categories: Frequently Used Items, Image, Signal I/O, Installation (highlighted), Display, Operation, Management, Network, Multi-Projection, ECO, and Initial/All Settings. The main area shows the 'Installation' menu with the following items:

Item	Value
Fixed Installation	Off
Test Pattern	
Projection	Front/Ceiling
Geometry Correction	Point Correction
Digital Zoom	
Remote Receiver	Off
Screen Type	16:9
High Altitude Mode	Off
Reset Installation Settings	

Below the Installation menu, the 'Initial/All Settings' section is visible, including: Display, Pattern Display, Pattern Type, No-signal Screen (Blue), Startup Screen (On), Home Screen Auto Disp. (On), Messages (On), and Menu Rotation (Off).

4. Select the **Test Pattern** setting and press **Enter**.
5. Select the pattern you want to display and press **Enter**.  
A test pattern is displayed.
6. Adjust the image as necessary.

**Note:** Some settings may not be available while displaying a test pattern. To adjust these settings or to fine-tune the image, project an image from a connected device.

7. Press **Esc** to clear the test pattern.

**Parent topic:** [Using Basic Projector Features](#)

## Focusing the Image Using the Focus Ring

You can correct the focus using the focus ring.

1. Turn on the projector and display an image.

2. To sharpen the image focus, rotate the projector's focus ring.

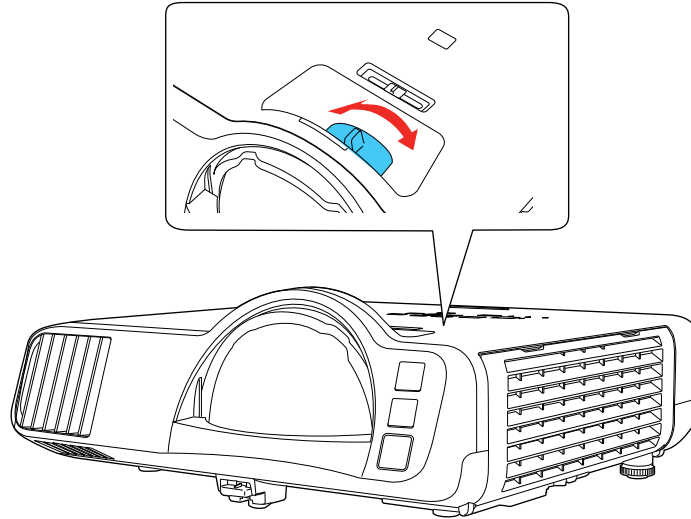

Parent topic: [Using Basic Projector Features](#)

## Remote Control Operation

The remote control lets you control the projector from almost anywhere in the room, up to 19.7 feet (6 m) away. You can point it at the screen or board, or the front or back of the projector.

Make sure that you aim the remote control at the projector's receivers within the angles listed here.

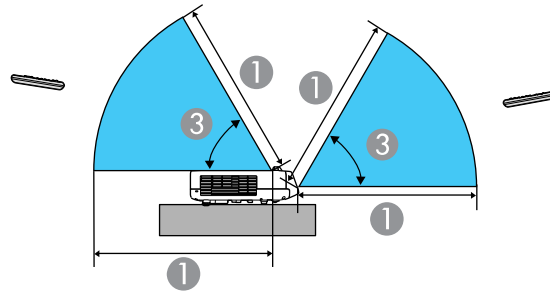
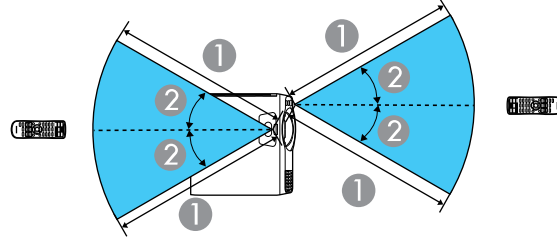

- 1 19.7 feet (6 m)
- 2 30°
- 3 60°

**Note:** Avoid using the remote control in conditions with bright fluorescent lights or in direct sunlight, or the projector may not respond to commands. If you will not use the remote control for a long time, remove the batteries.

Parent topic: [Using Basic Projector Features](#)

## Selecting an Image Source

If you connected multiple image sources to the projector, such as a computer and DVD player, you may want to switch from one image source to the other.

**Note:** If you turned on the **Auto Source Search** setting in the Operation menu, the projector automatically switches to another detected image source if the signal to the current image source is lost.

1. Make sure the connected image source you want to use is turned on.
2. For video image sources, insert a DVD or other video media and press its play button, if necessary.
3. Do one of the following:
  - Press the **Source Search** button on the projector or remote control until you see the image from the source you want.

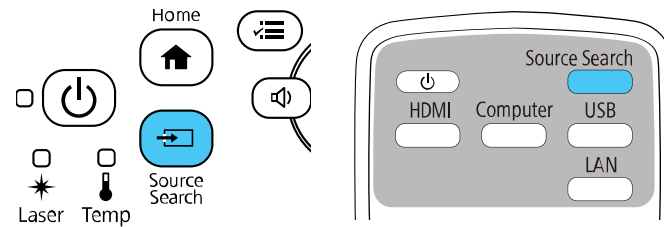

- Press the button for the source you want on the remote control. If there is more than one port for that source, press the button again to cycle through the sources.

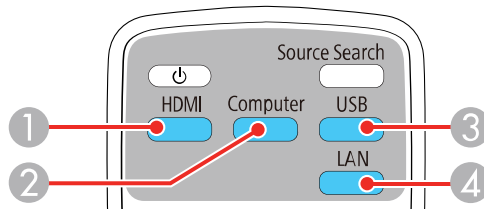

- 1 HDMI and Video sources
- 2 VGA port sources
- 3 USB port sources (computer display or external devices)
- 4 Network and Screen Mirroring sources



- Press the **Home** button on the remote control or projector and select your image source.



**Note:** Your Home screen may look different from the illustration shown here. A checkmark appears on the image from the current input source. You can see thumbnail previews of most input sources (except the USB input source when in Content Playback mode).

**Note:** If there are more than nine available input sources, your desired source may appear on the next page. Select the right arrow to move to the next page.

The displayed order of the input sources changes. Detected input sources appear in the upper left position. You can set the order of the input sources using the **Sort Source Thumbnails** setting in the projector's Display menu.

**Parent topic:** [Using Basic Projector Features](#)

## Projection Modes

Depending on how you positioned the projector, you may need to change the projection mode so your images project correctly.

- **Front** (default setting) lets you project from a table in front of the screen.
- **Front/Ceiling** flips the image over top-to-bottom to project upside-down from a ceiling or wall mount.
- **Rear** flips the image horizontally to project from behind a translucent screen.
- **Rear/Ceiling** flips the image over top-to-bottom and horizontally to project from the ceiling and behind a translucent screen.

**Note:** You can change the projection mode using the remote control or by changing the **Projection** setting in the Installation menu.

[Changing the Projection Mode Using the Remote Control](#)

[Changing the Projection Mode Using the Menu](#)

**Parent topic:** [Using Basic Projector Features](#)

## Changing the Projection Mode Using the Remote Control

You can change the projection mode to flip the image over top-to-bottom.

1. Turn on the projector and display an image.
2. Hold down the **A/V Mute** button on the remote control for 5 to 10 seconds.

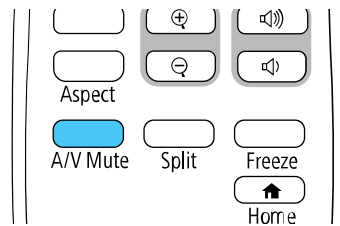

The image disappears briefly and reappears flipped top-to-bottom.

3. To change projection back to the original mode, hold down the **A/V Mute** button for 5 to 10 seconds again.

**Parent topic:** [Projection Modes](#)

## Changing the Projection Mode Using the Menu

You can change the projection mode to flip the image over top-to-bottom and/or left-to-right using the projector menus.

1. Turn on the projector and display an image.
2. Press the **Menu** button.

3. Select the **Installation** menu and press **↵ Enter**.

Frequently Used Items	Installation
Image	Fixed Installation Off
Signal I/O	Test Pattern
<b>Installation</b>	Projection Front/Ceiling
Display	Geometry Correction Point Correction
Operation	Digital Zoom
Management	Remote Receiver Off
Network	Screen Type 16:9
Multi-Projection	High Altitude Mode Off
ECO	Reset Installation Settings
Initial/All Settings	Display
	Pattern Display
	Pattern Type
	No-signal Screen Blue
	Startup Screen On
	Home Screen Auto Disp. On
	Messages On
	Menu Rotation Off

4. Select the **Projection** setting and press **↵ Enter**.
5. Select a projection mode and press **↵ Enter**.
6. Press **Menu** or **Esc** to exit the menus.

Parent topic: [Projection Modes](#)

## Image Aspect Ratio

If you always want to use a particular aspect ratio for a certain video input source, you can select it using the projector's menus.

[Changing the Image Aspect Ratio](#)

[Available Image Aspect Ratios](#)

Parent topic: [Using Basic Projector Features](#)

## Changing the Image Aspect Ratio

You can change the aspect ratio of the displayed image to resize it.

**Note:** Set the **Screen Type** setting in the projector's Installation menu before changing the aspect ratio.

**Note:** This setting is available only when the **Scale** setting is turned off or the **Scale Mode** setting is set to **Full Display** (EB-L210SF).

1. Turn on the projector and switch to the image source you want to use.
2. Press the **Aspect** button on the remote control.

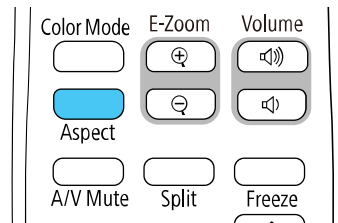

The shape and size of the displayed image changes, and the name of the aspect ratio appears briefly on the screen.

3. To cycle through the available aspect ratios for your input signal, press the **Aspect** button repeatedly.

**Note:** To remove black bars when projecting from a computer, set the **Resolution** setting to **Wide** or **Normal** in the Image menu, depending on your computer's resolution.

**Parent topic:** [Image Aspect Ratio](#)

## Available Image Aspect Ratios

You can select the following image aspect ratios, depending on the selected **Screen Type** setting and input signal from your image source.

**Note:** Black bands and cropped images may project in certain aspect ratios, depending on the aspect ratio and resolution of your input signal.

Aspect ratio setting	Description
Auto	Automatically sets the aspect ratio according to the input signal and the <b>Resolution</b> setting.

Aspect ratio setting	Description
<b>Full</b>	Displays images using the full width of the projection area, but does not maintain the aspect ratio.
<b>H-Zoom / V-Zoom</b> (EB-L210SF)	Displays images using the full width (H-Zoom) or height (V-Zoom) of the projection area and maintains the aspect ratio of the image.
<b>Zoom</b> (EB-L210SW)	Displays images using the full width of the projection area and maintains the aspect ratio of the image.
<b>Native</b>	Displays images as is (aspect ratio and resolution are maintained).

Parent topic: [Image Aspect Ratio](#)

## Color Mode

The projector offers different Color Modes to provide optimum brightness, contrast, and color for a variety of viewing environments and image types. You can select a mode designed to match your image and environment, or experiment with the available modes.

If you always want to use a particular color mode for a certain video input source, you can select it using the projector menus.

[Changing the Color Mode](#)

[Available Color Modes](#)

Parent topic: [Using Basic Projector Features](#)

## Changing the Color Mode

You can change the projector's Color Mode using the remote control to optimize the image for your viewing environment.

1. Turn on the projector and switch to the image source you want to use.
2. If you are projecting from a DVD player or other video source, insert a disc or other video media and press the play button, if necessary.

3. Press the **Color Mode** button on the remote control to change the Color Mode.

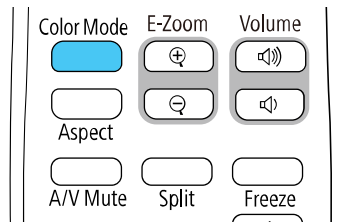

The image appearance changes and the name of the Color Mode appears briefly on the screen.

4. To cycle through all the available Color Modes for your input signal, press the **Color Mode** button repeatedly.

Parent topic: [Color Mode](#)

## Available Color Modes

You can set the projector to use these Color Modes, depending on the input source you are using:

Color Mode	Description
<b>Presentation</b>	Best for color presentations in a bright room
<b>Dynamic</b>	Best for video games in a bright room
<b>Cinema</b>	Best for movies projected in a dark room with natural tone images
<b>sRGB</b>	Best for standard sRGB computer displays
<b>DICOM SIM</b> (EB-L210SF)	Best for projecting X-rays and other medical images (shows clear shadows)
<b>Multi-Projection</b> (EB-L210SF)	Best for projecting from multiple projectors (reduces the color tone difference between images)

**Note:** The **DICOM SIM** color mode is for reference purposes only and should not be used to make medical diagnoses.

Parent topic: [Color Mode](#)

## Adjusting the Hue, Saturation, and Brightness

You can adjust the hue, saturation, and brightness settings for individual image colors.

1. Turn on the projector and switch to the image source you want to use.
2. Press the **Menu** button.
3. Select the **Image** menu and press **↵ Enter**.

Frequently Used Items	Image	
Image	Color Mode	Dynamic
Signal I/O	Brightness	50
Installation	Contrast	50
Display	Color Saturation	50
Operation	Tint	50
Management	Sharpness	5
Network	White Balance	
Multi-Projection	Dynamic Contrast	Off
ECO	Image Enhancement	
Initial/All Settings	Scene Adaptive Gamma	0
	Gamma	0
	RGBCMY	
	Reset to Defaults	
	Source	HDMI1
	Aspect	Auto
	Reset to Defaults	
	Scale	
	Reset Image Settings	

4. Select **RGBCMY** and press **↵ Enter**.

5. Select the color to adjust and press **↵ Enter**.



6. Do the following as necessary for each setting:
- To adjust the overall hue of the color (bluish, greenish, reddish), adjust the **Hue** setting.
  - To adjust the overall vividness of the color, adjust the **Saturation** setting.
  - To adjust the overall brightness of the color, adjust the **Brightness** setting.

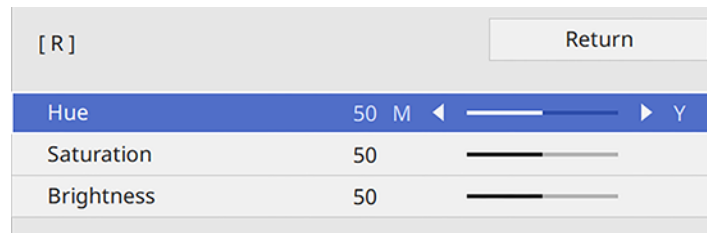

7. Press **Menu** or **Esc** to exit the menus.

**Parent topic:** [Using Basic Projector Features](#)

## Adjusting Gamma

You can adjust the gamma to improve differences in halftone brightness that vary depending on the connected device.



**Note:** Project a still image to adjust the gamma; you cannot adjust it properly when projecting a movie or other moving video. Medical images may not reproduce correctly depending on your operating environment and screen.

**Note:** To optimize the color tone according to the scene, and to obtain a more vivid image, correct the image by adjusting the **Scene Adaptive Gamma** setting.

1. Turn on the projector and switch to the image source you want to use.
2. Press the **Menu** button.
3. Select the **Image** menu and press **↵ Enter**.

Frequently Used Items	Image	
Image	Color Mode	Dynamic
Signal I/O	Brightness	50
Installation	Contrast	50
Display	Color Saturation	50
Operation	Tint	50
Management	Sharpness	5
Network	White Balance	
Multi-Projection	Dynamic Contrast	Off
ECO	Image Enhancement	
Initial/All Settings	Scene Adaptive Gamma	0
	Gamma	0
	RGBCMY	
	Reset to Defaults	
	Source	HDMI1
	Aspect	Auto
	Reset to Defaults	
	Scale	
	Reset Image Settings	

4. Select the **Gamma** setting and press **↵ Enter**.
5. Select and adjust the correction value.

You see a screen like this:

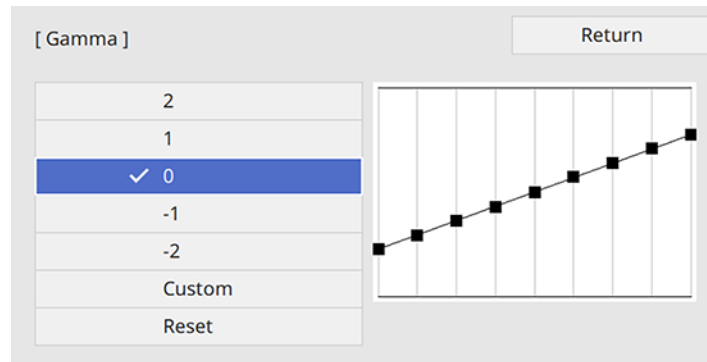

When you select a smaller value, you can reduce the overall brightness of the image to make the image sharper. When you select a larger value, the dark areas of images become brighter, but the color saturation for lighter areas may become weaker.

**Note:** If you set the **Color Mode** setting to **DICOM SIM** in the projector's **Image** menu, select the adjustment value according to the projection size (EB-L210SF). If the projection size is 80 inches (203 cm) or less, select a small value. If the projection size is 80 inches or more, select a large value.

6. If you want to make finer adjustments, select **Custom** and press **↵ Enter**.
7. Press the left or right arrow button to select the tone you want to change, then press the up or down arrow button to adjust the tone and press **↵ Enter**.

You see a screen like this:

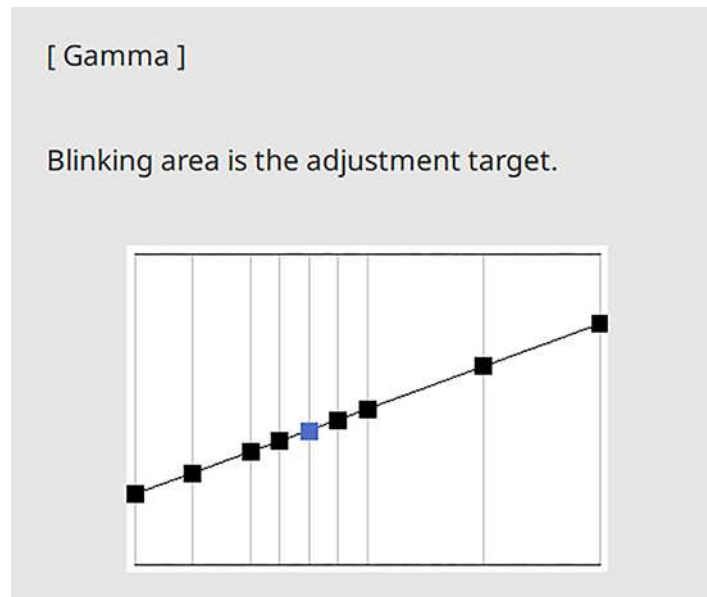

8. Press **Menu** or **Esc** to exit the menus.

Parent topic: [Using Basic Projector Features](#)

## Adjusting the Image Resolution

You can adjust the image resolution to project a clear image with an emphatic texture and material feel.

1. Turn on the projector and switch to the image source you want to use.
2. Press the **Menu** button.

3. Select the **Image** menu and press **↵ Enter**.

Frequently Used Items	Image	
Image	Color Mode	Dynamic
Signal I/O	Brightness	50
Installation	Contrast	50
Display	Color Saturation	50
Operation	Tint	50
Management	Sharpness	5
Network	White Balance	
Multi-Projection	Dynamic Contrast	Off
ECO	Image Enhancement	
Initial/All Settings	Scene Adaptive Gamma	0
	Gamma	0
	RGBCMY	
	Reset to Defaults	
	Source	HDMI1
	Aspect	Auto
	Reset to Defaults	
	Scale	
	Reset Image Settings	

4. Select **Image Enhancement** and press **↵ Enter**.
5. Select **Image Preset Mode** and press **↵ Enter**.
6. Select the preset option and press **↵ Enter**.

**Note:** The following settings saved in the preset option are applied to the image:

- **Noise Reduction**
  - **MPEG Noise Reduction**
  - **Deinterlacing**
  - **Super-resolution**
  - **Detail Enhancement**
7. Adjust each setting in the projector's Image menu individually as necessary.
    - Adjust the **Noise Reduction** setting to reduce flickering in images.

- Adjust the **MPEG Noise Reduction** setting to reduce the noise or artifacts seen in MPEG video.
- Adjust the **Deinterlacing** setting to convert interlaced-to-progressive signals for certain video image types (only displayed when the current signal is interlaced [480i/576i/1080i]).
- Adjust the **Super-resolution** setting to reduce blurring when projecting low-resolution images.
- Adjust the **Detail Enhancement** setting to create a more emphatic texture and material feel of the image.

The setting values in the preset option are overwritten as you make changes.

8. Press **Menu** or **Esc** to exit the menus.

**Parent topic:** [Using Basic Projector Features](#)

## Adjusting the Projector's Brightness Level

You can adjust the brightness of your projector's light source.

**Note:** The **Maintain Brightness** and **Maintain Brightness Level** settings are only available for EB-L210SF.

1. Turn on the projector and switch to the image source you want to use.
2. Press the **Menu** button.

3. Select the **Operation** menu and press **↵ Enter**.

Frequently Used Items	Operation
Image	Auto Source Search On
Signal I/O	Light Source Brightness Cont...
Installation	Direct Power On Off
Display	Auto Power On Off
Operation	Sleep Mode On ^
Management	Sleep Mode Timer 10 min.
Network	A/V Mute Timer On
Multi-Projection	Standby Mode Communication On ^
ECO	Port Wired LAN
Initial/All Settings	Quick Startup Off
	Indicators On
	Content Playback Off v
	Reset Operation Settings
	Management
	User Button Light Source Mode
	User's Logo
	User Pattern

4. Select **Light Source Brightness Control** and press **↵ Enter**.

[ Light Source Brightness Control ]	Return
Maintain Brightness	On
Maintain Brightness Level	100 %
Light Source Mode	Normal
Brightness Level	100 %

5. If you want to maintain the brightness at a specific level, select the **Maintain Brightness** setting and select **On**.
6. If you turn on **Maintain Brightness**, select the **Maintain Brightness Level** setting.

7. If you turn off **Maintain Brightness**, select the **Light Source Mode** setting:
  - **Normal**: Sets brightness to the maximum level (ideal for conference rooms, auditoriums, and lecture halls)
  - **Quiet**: Sets brightness to 70% and reduces fan noise (ideal for libraries, theaters, museums, and art galleries)
  - **Extended**: Sets brightness to 70% and extends the life expectancy of the light source (ideal for darker environments with ambient light, such as museums and art galleries, where a reduced maintenance cycle is desired)
  - **Custom**: Allows you to select a custom brightness level between 70 to 100%
8. If you set the **Light Source Mode** setting to **Custom**, select **Brightness Level** and use the left and right arrow buttons to select the brightness.
9. Press **Menu** or **Esc** to exit the menus.

**Note:** For the best results in maintaining the brightness level, set the **Light Source Calibration** setting to **Run Periodically** in the projector's Management menu (EB-L210SF).

Parent topic: [Using Basic Projector Features](#)

## Turning On Dynamic Contrast

You can turn on the **Dynamic Contrast** setting to automatically optimize the image luminance. This improves the image contrast based on the brightness of the content you project.

**Note:** The **Dynamic Contrast** setting does not appear if the **Closed Caption** setting is enabled in the Operation menu.

1. Turn on the projector and switch to the image source you want to use.
2. Press the **Menu** button.

3. Select the **Image** menu and press **↵ Enter**.

Frequently Used Items	Image	
Image	Color Mode	Dynamic
Signal I/O	Brightness	50
Installation	Contrast	50
Display	Color Saturation	50
Operation	Tint	50
Management	Sharpness	5
Network	White Balance	
Multi-Projection	Dynamic Contrast	Off
ECO	Image Enhancement	
Initial/All Settings	Scene Adaptive Gamma	0
	Gamma	0
	RGBCMY	
	Reset to Defaults	
	Source	HDMI1
	Aspect	Auto
	Reset to Defaults	
	Scale	
	Reset Image Settings	

4. Select the **Dynamic Contrast** setting and press **Enter**.
5. Choose one of the following options and press **Enter**:
  - **Normal** to adjust brightness at the standard speed.
  - **High Speed** to adjust brightness as soon as the scene changes.
6. Press **Menu** or **Esc** to exit the menus.

**Parent topic:** [Using Basic Projector Features](#)

## Controlling the Volume with the Volume Buttons

You can use the **Volume** buttons on the remote control to adjust the volume of your projected content. The volume buttons control the projector's internal speaker system or any external speakers you connected to the projector.

You must adjust the volume separately for each connected input source.



**Warning:** Do not start playback at a high volume. Sudden loud noises may cause hearing loss. Always lower the volume before turning off the projector. Gradually increase the volume after turning the projector on.

1. Turn on the projector and start a presentation that includes audio.
2. To lower or raise the volume, press the **Volume** buttons on the remote control.  
A volume gauge appears on the screen.
3. To set the volume to a specific level for an input source, use the projector menus.

**Parent topic:** [Using Basic Projector Features](#)

## Selecting a Quick Startup Setting

If you want to quickly restart the projector within five seconds after turning it off, you can change the **Quick Startup** setting. You can select 20, 60, or 90 minutes of Quick Startup time.

**Note:** The projector may take longer than five seconds to start up in the following conditions:

- When projecting with Screen Mirroring

**Note:** The Quick Startup setting is displayed only if the A/V Output setting in the Signal I/O menu is set to **While Projecting**, the Auto Power On setting in the Network menu is set to **Off**, or the Auto Power On setting is set to **HDMI1** and Power On Trigger setting in the Operation menu is set to **Plug-in Detection**.

1. Turn on the projector.
2. Press the **Menu** button.

3. Select the **Operation** menu and press **↵ Enter**.

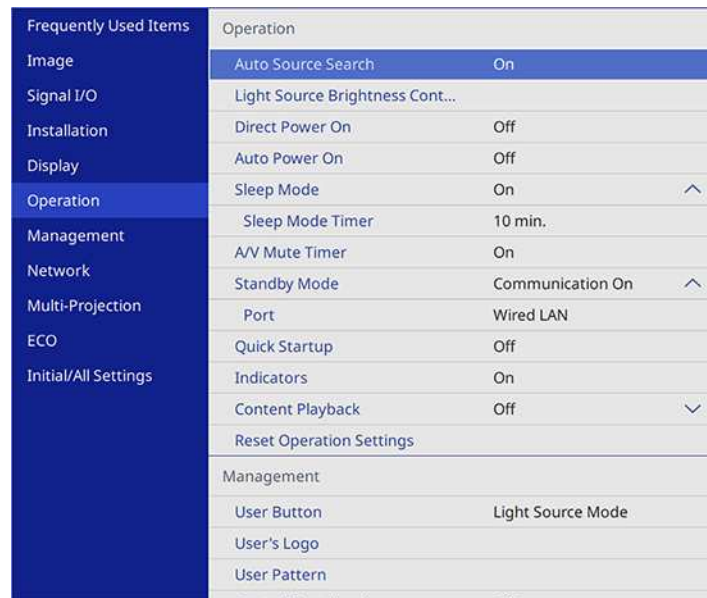

4. Select the **Quick Startup** setting and press **↵ Enter**.
5. Select how long you want to enable Quick Startup mode for and press **↵ Enter**.
6. Press **Menu** or **Esc** to exit the menus.

Press the power button to quickly restart the projector in this mode.

**Parent topic:** [Using Basic Projector Features](#)

## Projecting a PC Free Presentation

You can use your projector's PC Free feature whenever you connect a USB device that contains compatible files. This lets you quickly and easily display the contents of the files and control their display using the projector's remote control.

[PC Free Precautions](#)

[Supported PC Free File Types](#)

[Starting a PC Free Slideshow](#)

[Starting a PC Free Movie Presentation](#)

## [PC Free Display Options](#)

**Parent topic:** [Using Basic Projector Features](#)

### **PC Free Precautions**

Note the following precautions when using PC Free features:

- You cannot use a USB key for quick wireless connection for PC Free features.
- Do not disconnect the USB device while it is being accessed; otherwise, PC Free may not operate correctly.
- You may not be able to use the security features on certain USB devices with PC Free features.
- When connecting a USB device that includes an AC adapter, connect the AC adapter to an electrical outlet when you use the USB device with your projector.
- Some commercially available USB card readers may not be compatible with your projector.
- The projector can recognize up to five cards at a time from a connected card reader.
- You can use the following features while :
  - Freeze
  - A/V Mute
  - E-Zoom

**Parent topic:** [Projecting a PC Free Presentation](#)

### **Supported PC Free File Types**

You can project these types of files using the projector's PC Free feature.

**Note:** For best results, place your files on media that is formatted in FAT16/32. If you have trouble projecting from media formatted for non-Windows file systems, try formatting the media for Windows instead. You may not be able to use the security features on certain USB storage devices with PC Free features. When connecting a USB-compatible hard drive, connect the AC adapter supplied with the drive. PC Free may not work with USB device security features. If you are using a connected card reader, the projector can recognize up to five cards.

File type and extension	Details
Image (.jpg)	Make sure the file is not: <ul style="list-style-type: none"> <li>• CMYK format</li> <li>• Progressive format</li> <li>• Highly compressed</li> <li>• Above 8192 × 8192 resolution</li> </ul>
Image (.bmp)	Make sure the file resolution is not above 1280 × 800
Image (.gif )	Make sure the file is not: <ul style="list-style-type: none"> <li>• Above 1280 × 800 resolution</li> <li>• Animated</li> <li>• Interlaced</li> </ul>
Image (.png)	Make sure the file resolution is not: <ul style="list-style-type: none"> <li>• Above 1920 × 1200 resolution</li> <li>• Interlaced</li> </ul>
Motion JPEG movie (.avi)	Supports only AVI 1.0 Make sure the file is not: <ul style="list-style-type: none"> <li>• Saved with a video codec other than Motion JPEG</li> <li>• Saved with an audio codec other than LPCM or IMA ADPCM</li> <li>• Above 1280 × 720 resolution</li> <li>• Larger than 2GB</li> <li>• Saved with a frame rate higher than 30 fps</li> <li>• Saved with an audio sampling rate other than 11.025 kHz, 16 kHz, 22.05 kHz, 24 kHz, 32 kHz, 44.1, or 48 kHz</li> </ul>

File type and extension	Details
H.264, H.265 (.mp4/.mov)	<p>Make sure the file is not:</p> <ul style="list-style-type: none"> <li>• Larger than 2GB</li> <li>• Above 1920 × 1200 resolution</li> <li>• A color format other than YUV420</li> <li>• Saved with a movie codec other than H.264/MPEG-4 AVC (Baseline Profile, Main Profile, High Profile) or H.265/MPEG-H HEVC (Main Profile)</li> <li>• Saved with a frame rate higher than 30 fps</li> <li>• Saved with an audio codec other than MPEG-2 AAC-LC, MPEG-4 AAC-LC, or LPCM</li> <li>• Saved with an audio sampling rate other than 11.025 kHz, 16 kHz, 22.05 kHz, 24 kHz, 32 kHz, 44.1 kHz, or 48 kHz for LPCM, or 44.1 kHz or 48 kHz for MPEG-2 AAC-LC and MPEG-4 AAC-LC</li> <li>• Saved with audio other than 8-bit or 16-bit and up to 2 channels</li> <li>• A format other than single slice structure</li> </ul>

Parent topic: [Projecting a PC Free Presentation](#)

## Starting a PC Free Slideshow

After connecting a USB device or digital camera to the projector, you can switch to the USB input source and start your slideshow.

**Note:** You can change the slideshow operation options or add special effects by highlighting **Option** at the bottom of the screen and pressing **↵ Enter**.

**Note:** Make sure **Content Playback** is disabled in the projector's menu.

1. Press the **USB** button on the projector remote control until the PC Free file list appears.

The PC Free screen appears.



**Note:** If the Select Drive screen appears, press the arrow buttons to select the drive and press **↵ Enter**.

2. Do the following as necessary to locate your files:
  - If you need to display files inside a subfolder on your device, press the arrow buttons to highlight the folder and press **↵ Enter**.
  - To move back up a folder level on your device, highlight **Back to Top** and press **↵ Enter**.
  - To view additional files in a folder, highlight **Next Page** or **Previous Page** and press **↵ Enter**.
  - To display images from a different USB drive, select **Select Drive** at the top of the PC Free screen and press **↵ Enter**.
3. Do one of the following:
  - To display an individual image, press the arrow buttons to highlight the image and press **↵ Enter**. (Press the **Esc** button to return to the file list screen.)

- To display a slide show of all the images in a folder, press the arrow buttons to highlight the **Slideshow** option at the bottom of the screen and press **↵ Enter**.

**Note:** If any file names are longer than the display area or include unsupported symbols, the file names may be shortened or changed only in the screen display.

4. While projecting, use the following commands to control the display as necessary:
  - To rotate a displayed image, press the up or down arrow button.
  - To move to the next or previous image, press the left or right arrow button.
5. To stop the display, follow the on-screen instructions or press the **Esc** button.
6. Turn off the USB device, if necessary, and then disconnect the device from the projector.

**Parent topic:** [Projecting a PC Free Presentation](#)

## Starting a PC Free Movie Presentation

After connecting a USB device or digital camera to the projector, you can switch to the USB input source and start your movie.

**Note:** You can change the operation options by highlighting **Option** at the bottom of the screen and pressing **↵ Enter**.

1. Press the **USB** button on the projector remote control until the PC Free screen appears.

The PC Free screen appears.



**Note:** If the Select Drive screen appears, press the arrow buttons to select the drive and press **↵ Enter**.

2. Do the following as necessary to locate your files:
  - If you need to display files inside a subfolder on your device, press the arrow buttons to highlight the folder and press **↵ Enter**.
  - To move back up a folder level on your device, highlight **Back to Top** and press **↵ Enter**.
  - To view additional files in a folder, highlight **Next Page** or **Previous Page** and press **↵ Enter**.
  - To display movie files from a different USB drive, select **Select Drive** at the top of the PC Free screen and press **↵ Enter**.
3. To play back a movie, press the arrow buttons to highlight the file and press **↵ Enter**.

**Note:** If any file names are longer than the display area or include unsupported symbols, the file names may be shortened or changed only in the screen display. If you want to play back all the movies in a folder in sequence, select the **Slideshow** option at the bottom of the screen.



4. To stop movie playback, press the **Esc** button, highlight **Exit**, and press **↵ Enter**.
5. Turn off the USB device, if necessary, and then disconnect the device from the projector.

**Parent topic:** [Projecting a PC Free Presentation](#)

## PC Free Display Options

You can select these display options when using the projector's PC Free feature.

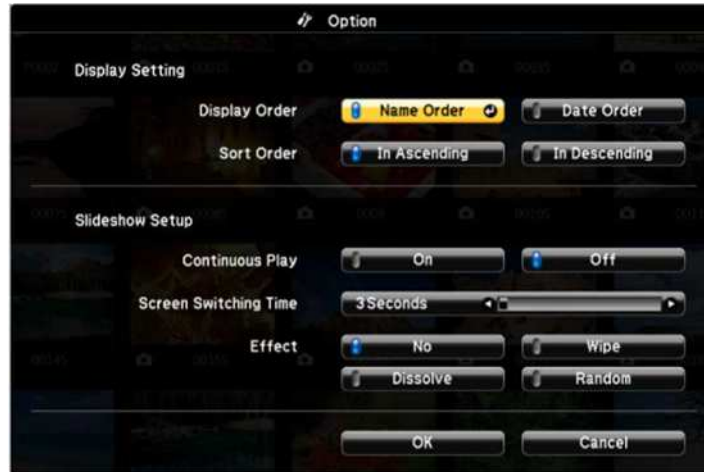

Setting	Options	Description
Display Order	Name Order	Displays files in name order
	Date Order	Displays files in date order
Sort Order	In Ascending	Sorts files in first-to-last order
	In Descending	Sorts files in last-to-first order
Continuous Play	On	Displays a slideshow continuously
	Off	Displays a slideshow one time through

Setting	Options	Description
<b>Screen Switching Time</b>	<b>No</b>	Does not display the next file automatically
	1 Second to 60 Seconds	Displays files for the selected time and switches to the next file automatically; high resolution images may switch at a slightly slower rate
<b>Effect</b>	<b>No</b>	No effect
	<b>Wipe</b>	Transitions between images with a wipe effect
	<b>Dissolve</b>	Transitions between images with a dissolve effect
	<b>Random</b>	Transitions between images using a random variety of effects

Parent topic: [Projecting a PC Free Presentation](#)

## Projecting in Content Playback Mode

You can project images or other content from an external storage device using Content Playback mode. You can also add color or effects to the projected image.

[Switching to Content Playback Mode](#)

[Projecting a Playlist in Content Playback Mode](#)

[Creating a Playlist Using Epson Web Control](#)

[Adding Effects to the Projected Image](#)

[Using Spotlight Mode](#)

Parent topic: [Using Basic Projector Features](#)

## Switching to Content Playback Mode

You need to switch to Content Playback mode to use its features.

**Note:** The **Screen Type** setting returns to its default setting when you switch to Content Playback mode.

1. Turn on the projector.
2. Press the **Menu** button.

3. Select the **Operation** menu and press **↵ Enter**.

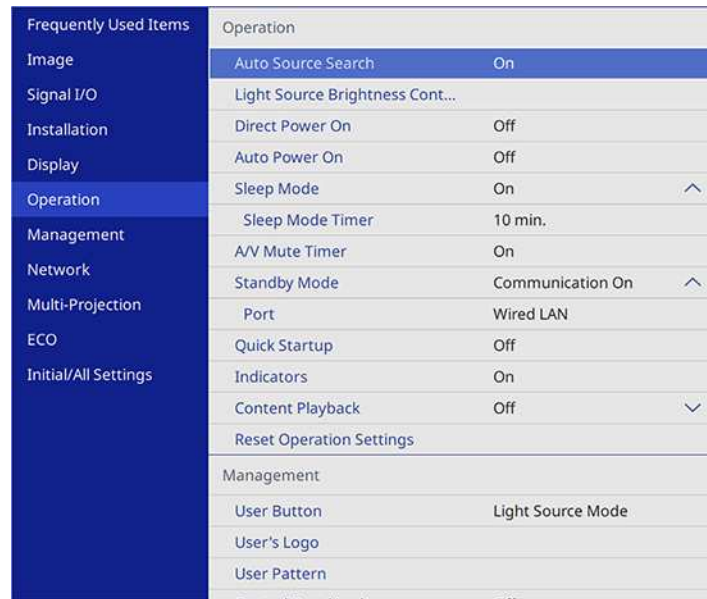

4. Select the **Content Playback** setting and press **↵ Enter**.
5. Select the **On** setting and press **↵ Enter**.  
You see a confirmation prompt.
6. Turn off the projector.
7. Turn on the projector again to enable Content Playback mode.
8. Press the **Home** button to make sure Content Playback mode is enabled.

**Note:** You cannot perform the following operations in Content Playback mode:

- Color Temp. (when **Warm White** or **Cool White** is selected as **Color Filter**)
- Split Screen
- Screen Type
- Detecting the input signal automatically
- No-signal Screen setting

- Log Save Destination
- Edge blending
- Remote Password
- PC Free
- Document camera
- Screen delivery function using the Epson iProjection software

Parent topic: [Projecting in Content Playback Mode](#)

## Projecting a Playlist in Content Playback Mode

You can project playlists that contain images and movies in Content Playback mode.

1. Create a playlist and export it to a USB device using the Epson Projector Content Manager software, Epson Web Control, or the Epson Creative Projection App.

**Note:** See the *Epson Projector Content Manager Operation Guide* for more information.

2. Turn on the projector.
3. Make sure the projector is in Content Playback mode.
4. Insert the USB device containing the playlist into the projector's **USB-A** port.

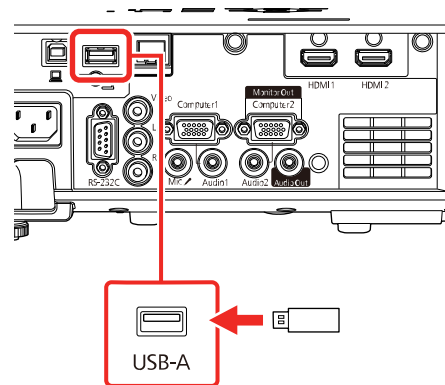

5. Press the **USB** button on the remote control to project the playlist.

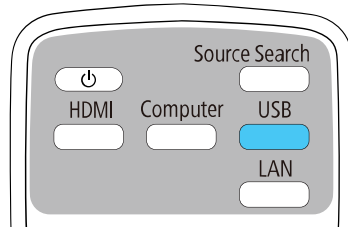

The playlist that was played last is projected. If a timetable is assigned, the playlist will play back according to the schedule in the timetable.

**Note:** You can also hold down the **Num** and numeric buttons to project your playlist. You can set a remote control shortcut key using the software you used to create the playlists.

**Note:** To select a specific playlist, select the **USB Viewer** setting in the Operation menu and use the arrow buttons to select your playlist.

**Parent topic:** [Projecting in Content Playback Mode](#)

## Creating a Playlist Using Epson Web Control

You can create playlists using a web browser and save them to a USB flash drive connected to a projector on a network when the projector is in Content Playback mode.

**Caution:** Do not remove the USB flash drive from the projector or disconnect the projector's power cord while creating playlists. Data saved on the USB flash drive may be damaged.

1. Make sure the projector is in Content Playback mode.
2. Make sure your computer or device is connected to the same network as the projector.

3. Connect a USB device to the projector's **USB-A** port.

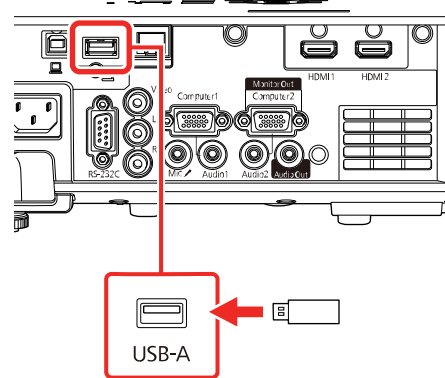

4. Start your web browser on your computer or device.
5. Enter the projector's IP address into the browser's address box and press the computer's **Enter** key.

**Note:** When entering an IPv6 address, wrap the address with [ and ].

**Note:** If you see a log in window, enter your user name and password. (The default user name is **EPSONWEB** and the default password is **admin**.)

You see the Epson Web Control screen.

6. Select **USB Memory Device**.
7. Select **Upload New Data**.
8. Select the images or movies you want to add to the playlist.

**Note:** You cannot upload .mp4 or .mov files. If you want to add .mp4 or .mov files to the playlist, use Epson Projector Content Manager software or the Epson Creative Projection app.

The selected files are copied to the USB device that is connected to the projector.

9. Do one of the following:
  - Select **Create New Playlist** to create a new playlist and add the files to it.
  - Select **Add to Playlist** and select the existing playlist you want to add the files to.

10. Edit the playlist.
11. Select **Finish** when you are done editing the playlist.

You can play the playlist from the Remote or Playlist screen. If you want to specify when the playlist starts and finishes, schedule the playlist using the Epson Projector Content Manager software. See the *Epson Projector Content Manager Operation Guide* for details.

**Parent topic:** [Projecting in Content Playback Mode](#)

## Adding Effects to the Projected Image

You can add color and effects to the projected image in Content Playback mode.

**Note:** When you use the effects feature, select **Refresh Mode > Start** on the **Management** menu periodically. You can't add effects when using **Edge Blending**.

1. In Content Playback mode, press the **Menu** button on the remote control and select the **Operation** menu.
2. Select **Overlay Effect** and press **Enter**.
3. Select the **Overlay Effect** setting and select **On**.

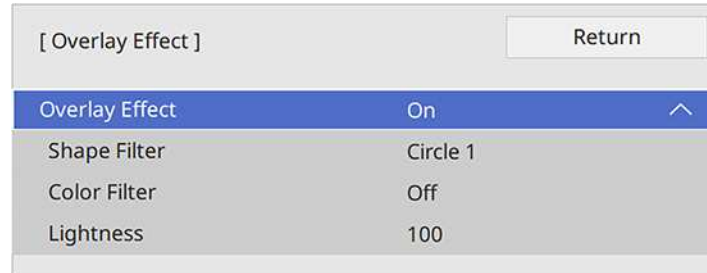

4. Select the **Shape Filter** setting and adjust the options as necessary.
  - **Shape:** Select a circle, rectangle, or other shape effect

**Note:** You can add your images as customized shapes using the Epson Projector Content Manager software. See the *Epson Projector Content Manager Operation Guide* for details.

- **Filter Effect:** Select an option to mask the inside or outside of the shape

- **Size:** Set the shape size
- **Position:** Set the shape position

**Note:** When you use a customized shape, you cannot change the **Size** and **Position** settings.

5. Select the **Color Filter** setting and adjust the options as necessary.
  - **Color Filter:** Select the color
  - **Custom:** Adjust red, green, or blue individually
6. Select the **Lightness** setting and adjust the brightness level.
7. Press the **Menu** button to exit.

**Parent topic:** [Projecting in Content Playback Mode](#)

## Using Spotlight Mode

You can use spotlight mode to project a virtual spotlight and customize the position, size, shape and width of the light.

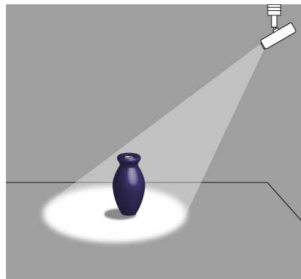

1. Press the **Menu** button on the projector or remote control.

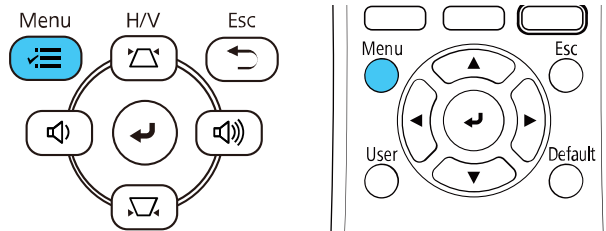



2. Select the **Management** menu and press **↵ Enter**.



3. Select the **User Button** setting and press **↵ Enter**.
4. Select the **Spotlight** setting and press **↵ Enter**.  
The Spotlight function is assigned to the **User** button on the remote control.
5. Press the **User** button on the remote control.

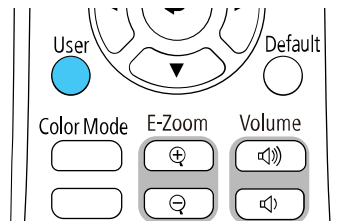

The projected image becomes a spotlight.

6. To change the overlay effect and shape filter for the spotlight, select the **Overlay Effect** setting in the projector's **Operation** menu.

**Parent topic:** [Projecting in Content Playback Mode](#)

---

# Adjusting Projector Features

Follow the instructions in these sections to use your projector's feature adjustments.

[Shutting Off the Picture and Sound Temporarily](#)

[Stopping Video Action Temporarily](#)

[Zooming Into and Out of Images](#)

[Using Multiple Projectors](#)

[Projecting Multiple Images Simultaneously](#)

[Projector Security Features](#)

[Creating a User Pattern to Display](#)

[Copying Menu Settings Between Projectors](#)

[Scheduling Projector Events](#)

## Shutting Off the Picture and Sound Temporarily

You can temporarily turn off the projected picture and sound if you want to redirect your audience's attention during a presentation. Any sound or video action continues to run, however, so you cannot resume projection at the point that you stopped it.

If you want to display an image such as a company logo or picture when the presentation is stopped, you can set up this feature using the projector's menus.

**Note:** If the picture and sound are off for more than 30 minutes, the power automatically turns off. You can turn the **A/V Mute Timer** setting on and off in the projector's Operation menu.

1. Press the **A/V Mute** button on the remote control to temporarily stop projection and mute any sound.

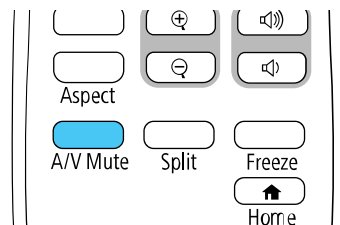

2. To turn the picture and sound back on, press the **A/V Mute** button again.

Parent topic: [Adjusting Projector Features](#)

## Stopping Video Action Temporarily

You can temporarily stop the action in a video or computer presentation and keep the current image on the screen. Any sound or video action continues to run, however, so you cannot resume projection at the point that you stopped it.

1. Press the **Freeze** button on the remote control to stop the video action.

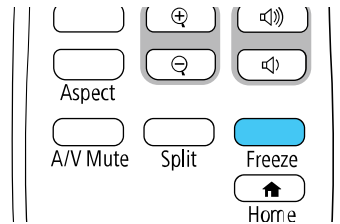

2. To restart the video action in progress, press **Freeze** again.

Parent topic: [Adjusting Projector Features](#)

## Zooming Into and Out of Images

You can draw attention to parts of a presentation by zooming into a portion of the image and enlarging it on the screen.

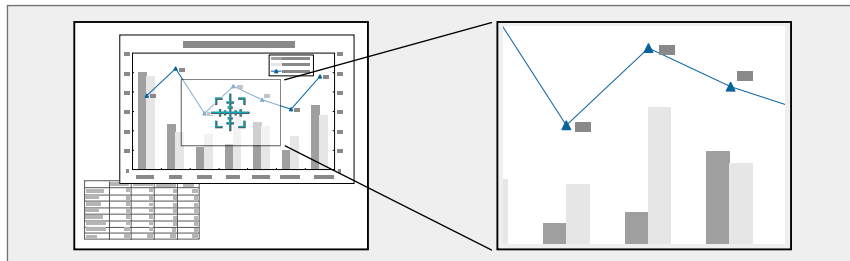

**Note:** This feature is unavailable if the **Scale** setting in the Image menu is enabled (EB-L210SF).

1. Press the **E-Zoom +** button on the remote control.

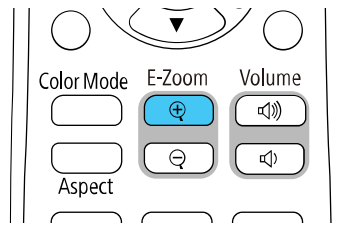

You see a crosshair on the screen indicating the center of the zoom area.

2. Use the following buttons on the remote control to adjust the zoomed image:
  - Use the arrow buttons to position the crosshair in the image area you want to zoom into. To move the crosshair diagonally, press any adjacent arrow buttons at the same time.
  - Press the **E-Zoom +** button repeatedly to zoom into the image area, enlarging it as necessary. Press and hold the **E-Zoom +** button to zoom in more quickly.
  - To pan around the zoomed image area, use the arrow buttons.
  - To zoom out of the image, press the **E-Zoom –** button as necessary.
  - To return to the original image size, press the **Esc** button.

Parent topic: [Adjusting Projector Features](#)

## Using Multiple Projectors

You can combine the projected images from two or more projectors to create one large image. Follow the instructions in these sections to set up and project from multiple projectors.

**Note:** Before projecting, make sure you set **Color Mode** to **Multi-Projection** in each projector's Image menu .

For best results, wait at least 30 minutes after you start projecting, then select settings and make adjustments in this order:

- Set the projector ID
- Adjust **Color Uniformity**
- Set **Light Source Mode** to **Custom** and adjust the **Brightness Level** in the projector's Operation menu (EB-L210SW)

- Blend the image edges (EB-L210SW)
- Match the image colors (EB-L210SW)
- Adjust the **Black Level** (EB-L210SW)
- Adjust the **RGBCMY**
- Scale the image (EB-L210SW)

**Note:** In some cases, the brightness and color tones may not completely match, even after correction. If brightness and color tone differences become more noticeable over time, repeat the adjustments.

[Projector Identification System for Multiple Projector Control](#)

[Adjusting Color Uniformity](#)

[Blending the Image Edges](#)

[Matching the Image Colors](#)

[Adjusting the Black Level](#)

[Adjusting RGBCMY](#)

[Scaling an Image](#)

**Parent topic:** [Adjusting Projector Features](#)

## Projector Identification System for Multiple Projector Control

You can operate multiple projectors using one remote control for more elaborate presentations. To do this, you assign an identification number to each projector and to the remote control. Then you can operate all the projectors at once or individually.

[Setting the Projector ID](#)

[Setting the Remote Control ID](#)

**Parent topic:** [Using Multiple Projectors](#)

### Setting the Projector ID

If you want to control multiple projectors from a remote control, give each projector a unique ID.

1. Press the **Menu** button.
2. Select the **Multi-Projection** (EB-L210SF) or **Installation** (EB-L210SW) menu and press **↵ Enter**.

3. Select **Projector ID** and press **↵ Enter**.

[ Projector ID ]	Return
✓ Off	
1	
2	
3	
4	
5	
6	
7	
8	
9	

4. Press the arrow buttons on the remote control to select the identification number you want to use for the projector. Then press **↵ Enter**.

Repeat these steps for all the other projectors you want to operate from one remote control.

**Note:** If you don't know the projector's ID, aim the remote control at the projector and press the **ID** button to temporarily display the projector's ID on the screen.

**Parent topic:** [Projector Identification System for Multiple Projector Control](#)

### Setting the Remote Control ID

The remote control's ID is set to zero by default so it can operate any compatible projector. If you want to set the remote control to operate only a particular projector, you need to set the remote control's ID to match the projector's ID.

1. Turn on the projector you want the remote control to operate with exclusively.

2. Make sure you know the projector's ID number as set in the Multi-Projection or Installation menu's **Projector ID** setting.

**Note:** If you have forgotten the projector's ID, aim the remote control at the projector and press the **ID** button to temporarily display the projector's ID on the screen. If you turn off the **Projector ID** setting, the remote control will operate the projector regardless of the ID selected on the remote.

3. Aim the remote control at that projector and press the **ID** button on the remote control.  
The current projector ID is displayed on the screen for about 3 seconds.
4. Hold down the **ID** button on the remote control while you press the numeric button that matches the projector's ID. Then release the buttons.

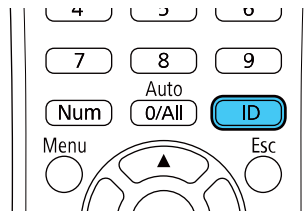

**Note:** If you select **0/All** on the remote control, you can operate all projectors regardless of the **Projector ID** setting.

The remote control's ID is set.

**Note:** If the batteries are left out of the remote control for an extended period, the remote control ID returns to its default setting. If you use multiple remote controls at the same time, you may not be able to operate the projectors as intended due to infrared interference.

**Parent topic:** [Projector Identification System for Multiple Projector Control](#)

## Adjusting Color Uniformity

If the color tone is uneven on each screen, adjust the color tone balance in the Management menu of each projector. (The color tone may not be uniform even after performing color uniformity.)

**Note:** Set the **Color Mode** setting in each projector's Image menu to **Multi-Projection** before you start projecting.



1. Press the **Menu** button on the remote or control panel, select the **Management** menu, and press **Enter**.

Frequently Used Items	Management
Image	User Button Light Source Mode
Signal I/O	User's Logo
Installation	User Pattern
Display	Control Panel Lock Off
Operation	Color Uniformity
Management	Refresh Mode
Network	Light Source Calibration
ECO	Date & Time
Initial/All Settings	Schedule Settings
	Wireless LAN Power
	Wireless LAN Diagnosis 1
	Log Save Destination USB and Internal Memory
	Batch Setup Range
	Language  English
	Information
	Display Logs
	Reset Management Settings
	Network

2. Select the **Color Uniformity** setting and press **↵ Enter**.

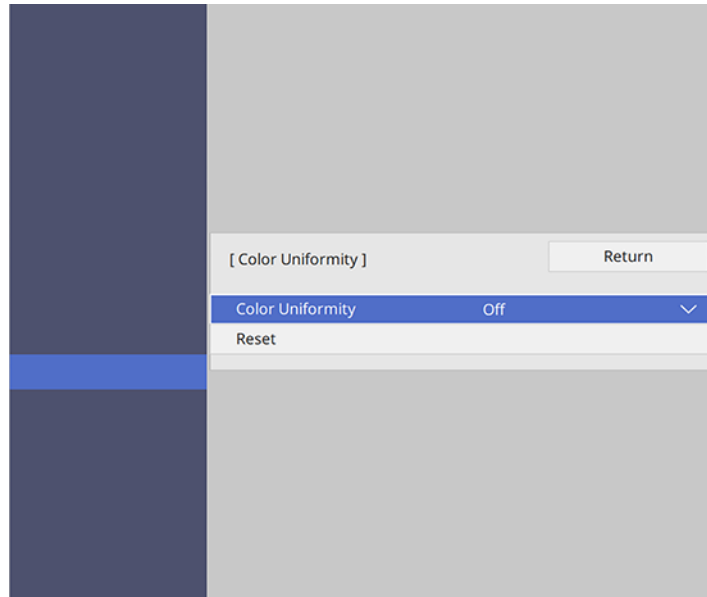

3. Select **On** as the **Color Uniformity** setting and press **↵ Enter**, then press **Esc**.
4. Select **Adjustment Level** and press **↵ Enter**.
5. Select an adjustment level and press **Esc**.
6. Select **Start Adjustments** and press **↵ Enter**.

7. Select the area you want to adjust and press **↵ Enter**.



8. Select **Red**, **Green**, or **Blue** and press the left arrow button to weaken the color tone or the right arrow button to strengthen the color tone.

**Note:** The adjustment screen changes each time you press **↵ Enter**.

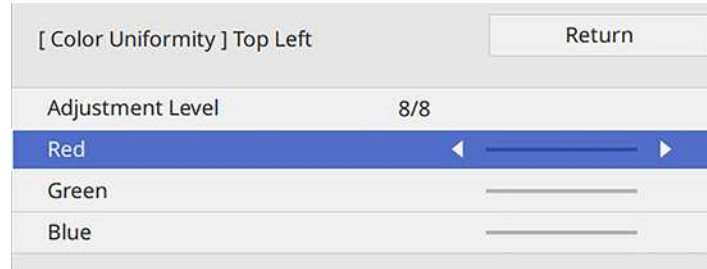

9. Press **Esc** to return to the area selection screen.
10. Repeat steps 7 through 9 for each area, then select **All** to adjust the entire screen.
11. Press **Esc** to return to the Color Uniformity screen.
12. Repeat steps 4 through 10 for each Adjustment Level.
13. Press **Esc** to exit the menus.

**Parent topic:** [Using Multiple Projectors](#)

## Blending the Image Edges

You can use the projector's Edge Blending feature to create a seamless image from multiple projectors (EB-L210SF).

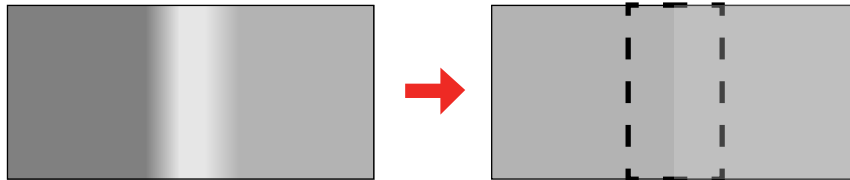

1. Press the **Menu** button.
2. Select the **Multi-Projection** menu and press **Enter**.

Frequently Used Items	Multi-Projection
Image	Projector ID Off
Signal I/O	Tiling
Installation	Geometry Correction Point Correction
Display	Edge Blending
Operation	Scale
Management	Color Uniformity
Network	Light Source Mode Normal
Multi-Projection	Color Matching
ECO	RGBCMY
Initial/All Settings	Reset Multi-Projection Settings
	ECO
	Light Source Mode Normal
	Sleep Mode On ^
	Sleep Mode Timer 10 min.
	A/V Mute Timer On
	Standby Mode Communication On
	Initial/All Settings

3. Select the **Edge Blending** setting and press **↵ Enter**.

4. Turn on the **Edge Blending**, **Line Guide**, and **Pattern Guide** settings.

**Note:** Select a different **Guide Color** setting for each projector so that you can see the blended area clearly.

5. Select the edge you want to blend on each projector and press **↵ Enter**. For the projector on the left, select the **Right Edge** and for the projector on the right, select **Left Edge**.

You see a screen like this:

[ Top Edge ]		Return
Blending	Off	
Blend Start Position	0	—————
Blend Range	0	—————
Blend Curve	0	

6. Select the **Blending** setting and select **On**.
7. Press **Esc** to return to the previous screen.
8. Select the **Blend Start Position** setting and adjust the point where edge blending begins.

**Note:** If you created a unified image area using the Edge Blending feature, set the **Blend Start Position** setting to **0**.

9. Select the **Blend Range** setting and use the arrow buttons to select the width of the blended area so that the displayed guides are at the edges of the overlapping area between the two images.

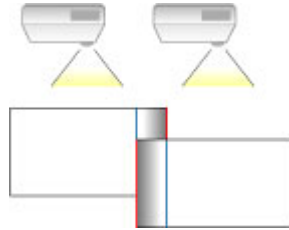

**Note:** If you created a unified image area using the Edge Blending feature, set the **Blend Range** setting to **300**.

10. Press **Esc** to go back to the previous screen.
11. Select the **Blend Curve** setting and select a gradient for the shaded area on the projectors.
12. When the edges are blended, turn off the **Line Guide** and **Pattern Guide** settings on each projector to check the final settings.
13. When you are finished, press the **Menu** button.

If the blended area does not overlap exactly, correct the shape of the blended area using **Point Correction**.

**Parent topic:** [Using Multiple Projectors](#)

## Matching the Image Colors

You can match the display color of multiple projectors that will project next to one another (EB-L210SF). Turn on all the projectors so you can properly adjust the color of the combined screen.

1. Press the **Menu** button.

2. Select the **Multi-Projection** menu and press **↵ Enter**.

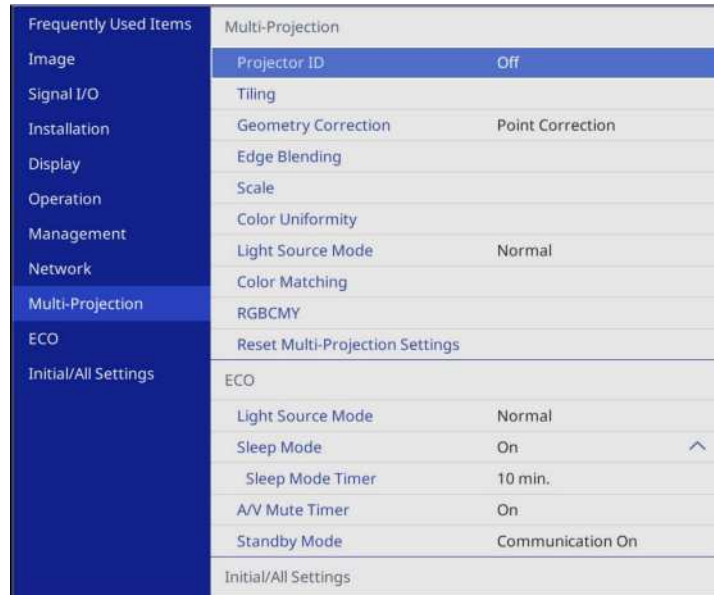

3. Select the **Color Matching** setting and press **↵ Enter**.  
You see this screen:

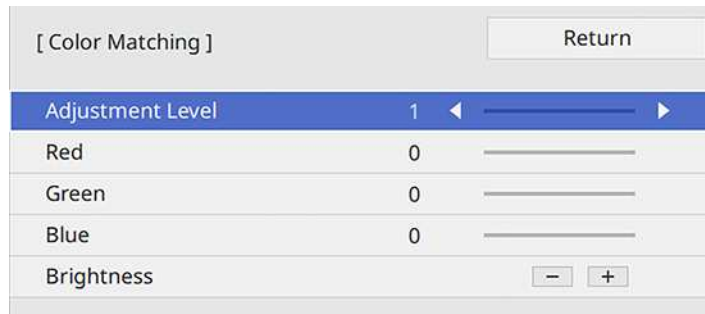

4. Press the left or right arrow button to select **Adjustment Level 8**.

**Note:** There are several adjustment levels and you can adjust each level individually.

5. Press the left or right arrow buttons to adjust the **Brightness** setting.
6. Press the left or right arrow buttons to adjust the color tone for the **Red**, **Green**, and **Blue** settings if necessary.
7. Press **Esc** to return to the Multi-Projection menu.
8. Select the **Operation** menu and press **↵ Enter**.
9. Select **Light Source Brightness Control** and press **↵ Enter**.
10. Set the **Light Source Mode** setting to **Custom** and adjust the **Brightness Level** setting as necessary.
11. Press **Esc** and repeat steps 2 through 6 for **Adjustment Level 7** through **2**.
12. When you are finished, press the **Menu** button.

**Parent topic:** [Using Multiple Projectors](#)

## Adjusting the Black Level

When two images overlap, the overlapping area can appear differently from the areas that do not overlap. You can use the projector's Black Level setting to make the difference less noticeable (EB-L210SF).

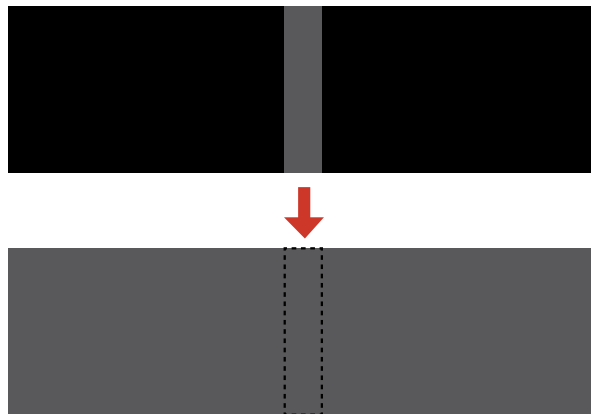



**Note:** You cannot adjust the black levels while projecting a test pattern, and you may not be able to adjust the black levels correctly if the **Geometry Correction** settings are set too high. The brightness and tone of the overlapping areas may differ from the rest of the image even after adjusting the black level.

1. Press the **Menu** button.
2. Select the **Multi-Projection** menu and press **↵ Enter**.



3. Select the **Black Level** setting and press **↵ Enter**.

**Note:** The **Black Level** setting is displayed only if **Edge Blending** is enabled and at least one (top, bottom, left, right) edge is set to **On**.

4. Select the **Color Adjustment** setting and press **↵ Enter**.

You see a screen based on the **Top Edge**, **Bottom Edge**, **Right Edge**, and **Left Edge** settings you selected for the **Edge Blending** setting.

5. Select the area you want to adjust and press **↵ Enter**.

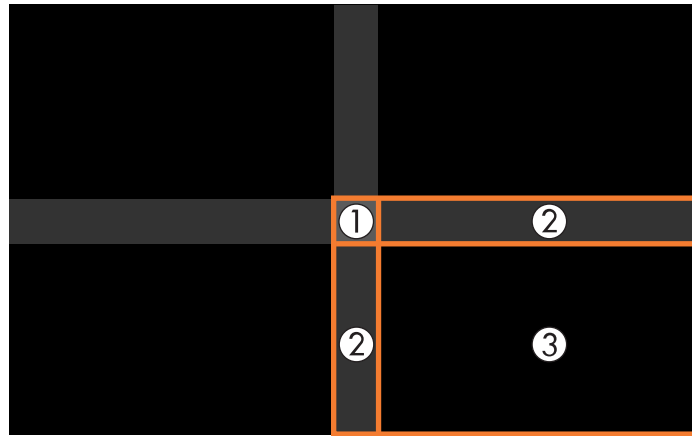

**Note:** The area you selected is displayed in orange. Adjust overlapping areas starting with the brightest areas first. For example, adjust area 2 to match area 1, then adjust area 3 to match area 2.

6. Adjust the brightness and tone of the areas that do not overlap to match the areas that overlap using the displayed adjustment sliders. Then press the **Esc** button.

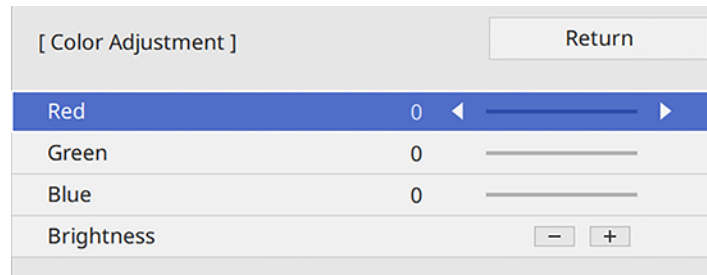

7. Repeat the previous two steps as needed until all areas match.
8. If the tone of some areas do not match, you can adjust them using the **Area Correction** setting. Continue with the next step. Otherwise, press the **Menu** button to exit.
9. Press the **Esc** button to return to the Black Level screen.
10. Select the **Area Correction** setting and press **↵ Enter**.

11. Select the **Start Adjustments** setting and press **↵ Enter**.

You see a screen with boundary lines indicating areas that are overlapping. The boundary lines are based on the **Top Edge**, **Bottom Edge**, **Right Edge**, and **Left Edge** settings you selected for the **Edge Blending** setting.

12. Use the arrow buttons to select a boundary line of the area you want to adjust and press **↵ Enter**.  
The selected line is displayed in orange.



13. Use the arrow buttons to adjust the boundary line position and press **↵ Enter**.
14. Use the arrow buttons to select an adjustment point and press **↵ Enter**.

**Note:** You can change the number of adjustment points displayed by changing the **Points** setting in the Area Correction menu.

The selected point turns orange.

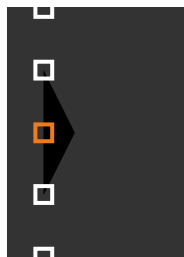

15. Use the arrow buttons to move the point.
16. To move another point, press the **Esc** button and repeat the previous two steps.

17. To move another boundary line, press the **Esc** button repeatedly until you can select a boundary line.
18. When you are finished, press the **Esc** button until you see a confirmation message. Select **Yes** and press **↵ Enter**.
19. When you are finished, press the **Menu** button.

**Note:** Changing the **Top Edge**, **Bottom Edge**, **Right Edge**, or **Left Edge** settings resets the **Black Level** setting to its default value.

**Parent topic:** [Using Multiple Projectors](#)

## Adjusting RGBCMY

You can adjust the **Hue**, **Saturation**, and **Brightness** settings for R (red), G (green), B (blue), C (cyan), M (magenta), and Y (yellow) color components .

Turn on all the projectors and select the **RGBCMY** setting in each projector's Image menu so that the color tone on the combined screen becomes entirely even.

1. Press the **Menu** button.

2. Select the **Image** menu and press **↵ Enter**.

Frequently Used Items	Image	
Image	Color Mode	Dynamic
Signal I/O	Brightness	50
Installation	Contrast	50
Display	Color Saturation	50
Operation	Tint	50
Management	Sharpness	5
Network	White Balance	
Multi-Projection	Dynamic Contrast	Off
ECO	Image Enhancement	
Initial/All Settings	Scene Adaptive Gamma	0
	Gamma	0
	RGBCMY	
	Reset to Defaults	
	Source	HDMI1
	Aspect	Auto
	Reset to Defaults	
	Scale	
	Reset Image Settings	

3. Select the **RGBCMY** setting and press **↵ Enter**.

[ RGBCMY ]				Return
	Hue	Saturation	Brightness	
R	50	50	50	
G	50	50	50	
B	50	50	50	
C	50	50	50	
M	50	50	50	
Y	50	50	50	

4. Select the color you want to adjust and press **↵ Enter**.

You see this screen:

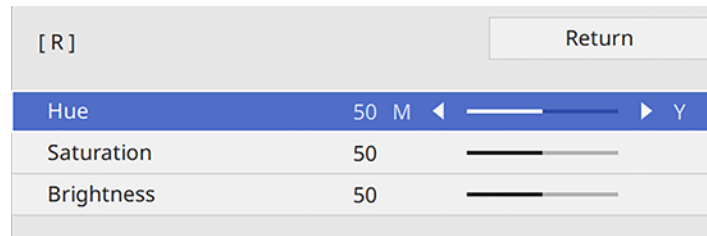

- To adjust the overall hue of the color, adjust the **Hue** setting.
  - To adjust the overall vividness of the color, adjust the **Saturation** setting.
  - To adjust the overall brightness of the color, adjust the **Brightness** setting.
5. Press the left or right arrow buttons to adjust the **Hue**, **Saturation**, and **Brightness** settings.
  6. Repeat the previous two steps as necessary to adjust each color.
  7. Press **Menu** or **Esc** to exit the menus.

Parent topic: [Using Multiple Projectors](#)

## Scaling an Image

You can project the same image from multiple projectors and use the Scale feature to crop and combine them into one large image (EB-L210SF).

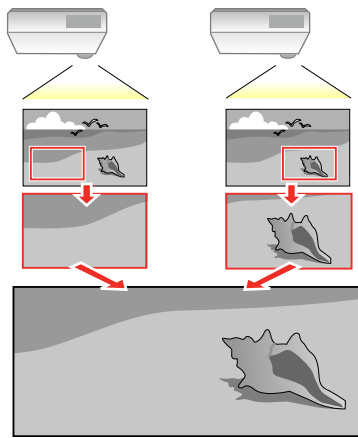

1. Press the **Menu** button.
2. Select the **Multi-Projection** menu and press **↵ Enter**.
3. Select the **Scale** setting and press **↵ Enter**.

You see this screen:

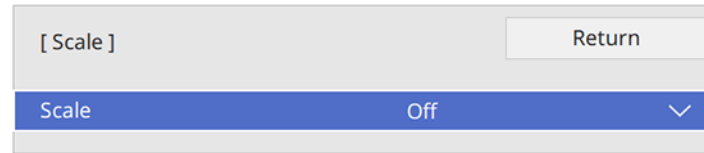

4. Turn on the **Scale** setting.
5. Select the **Scale Mode** setting and select one of these options:
  - **Zoom Display** to maintain the image aspect ratio as you scale the image

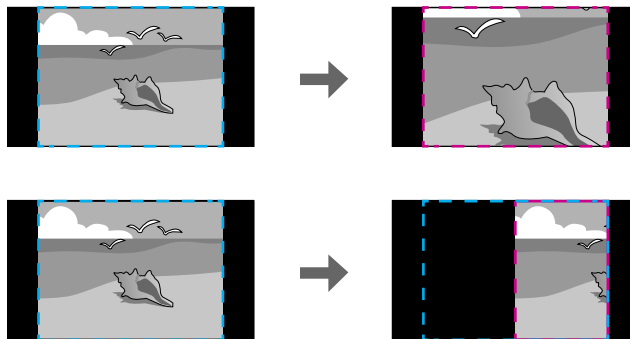

- **Full Display** to adjust the image to the projector's screen size as you scale the image

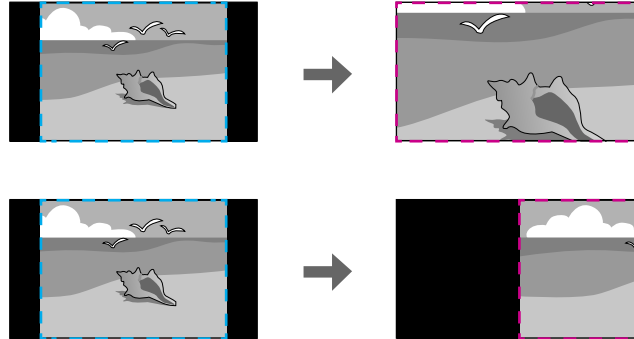

6. If you selected **Auto** as the Scale setting, you can skip the remaining steps. If you selected **Manual**, adjust each of the following options as necessary:
  - Select **-** or **+** to scale the image horizontally and vertically at the same time
  - Select **Scale Vertically** to scale the image vertically only
  - Select **Scale Horizontally** to scale the image horizontally only
7. Select the **Clip Adjustment** setting and use the arrow buttons to adjust the coordinates and size of each image as you view the screen.
8. Select the **Clip Range** setting to preview the area you just selected.
9. Press the **Menu** button to exit.

Parent topic: [Using Multiple Projectors](#)

## Projecting Multiple Images Simultaneously

You can use the split screen feature to simultaneously project from two or four images from different image sources next to each other. You can control the split screen feature using the remote control or the projector menus.



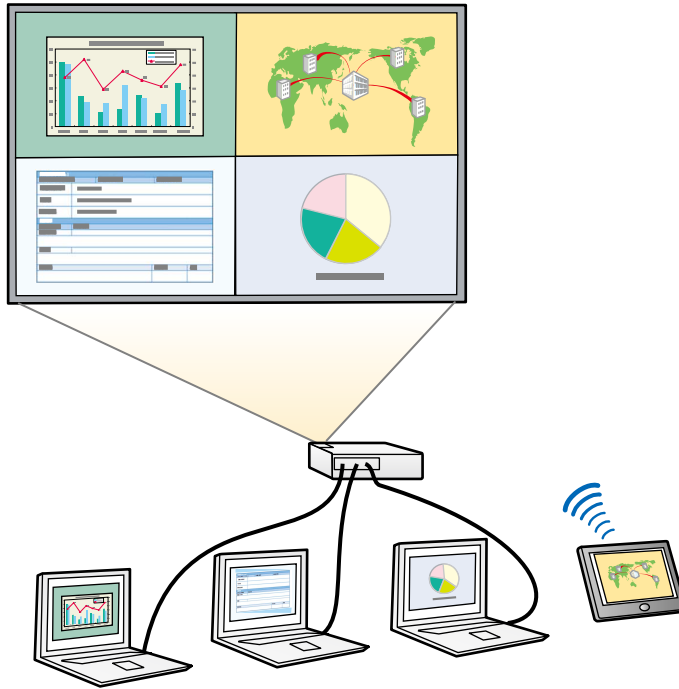

**Note:** While you use the split screen feature, other projector features may not be available and some settings may be automatically applied to all images.

**Note:** You cannot perform split screen projection if **Content Playback** is enabled.

1. Press the **Split** button on the remote control.

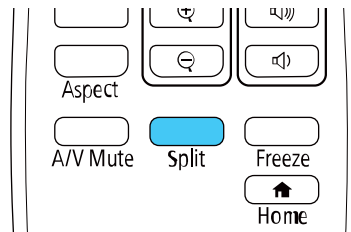

**Note:** You can also select **Split Screen** from the Home screen.

You are prompted for the number of screens.

2. Select **2 Screens** or **4 Screens**, depending on the number of input sources you want to project.

If you selected **2 Screens**, the currently selected input source moves to the left side of the screen. If you selected **4 Screens** and used the split screen feature to project four images before, the projected images are arranged in the same order as they were previously.

3. Press the **Menu** button.

You see a screen like this:

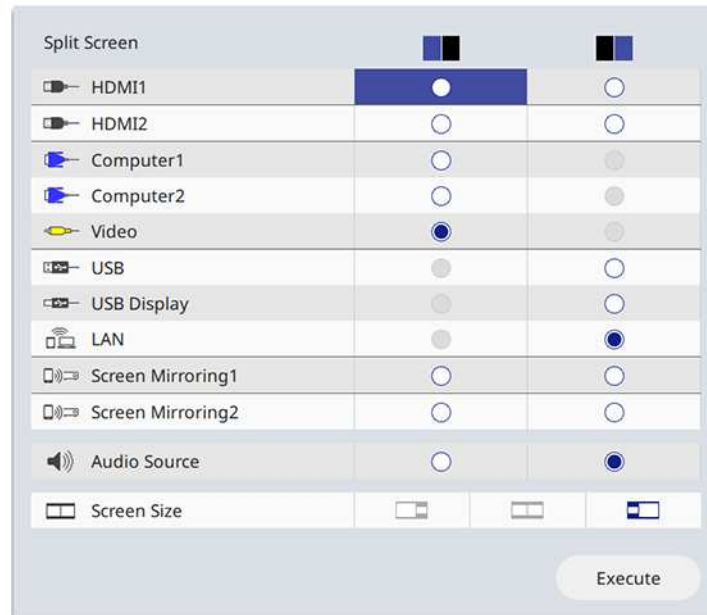

4. Press the arrow and **↵ Enter** buttons to select an image source for each section of the screen.
5. To choose the audio you want to hear, select an input source as the **Audio Source** setting.
6. If you selected **2 Screens** and want to change the size of the images, select a sizing option as the **Screen Size** setting.
7. Select **Execute** and press **↵ Enter**.
8. To exit the split screen feature, press the **Split** or **Esc** button.

[Input Sources for Split Screen Projection](#)

## [Split Screen Projection Restrictions](#)

**Parent topic:** [Adjusting Projector Features](#)

### **Input Sources for Split Screen Projection**

You can choose most input source combinations for split screen projection, but the following combinations are not supported:

- **Computer1, Computer2, Video**
- **USB, USB Display, LAN**

**Note:** When you split the screen into four screens and select the USB and the Screen Mirroring input source at the same time, you can only select one Screen Mirroring source.

**Parent topic:** [Projecting Multiple Images Simultaneously](#)

### **Split Screen Projection Restrictions**

You cannot perform the following operations during split screen projection:

- Change settings in the projector's menu
- E-Zoom
- Switching the aspect mode (the aspect mode is set to **Auto**)
- Operations using the **User** button on the remote control, other than displaying the network information on the projected surface
- Applying the **Dynamic Contrast** setting
- Applying the **Image Shift** setting
- Displaying the network information on the projected surface by a method other than pressing the **User** button
- Displaying the Screen Mirroring information bar

#### **Image restrictions**

- Even if you set **No-signal screen** to **Logo** in the Display menu, the blue screen appears when no image signal is being input.

**Parent topic:** [Projecting Multiple Images Simultaneously](#)

## Projector Security Features

You can secure your projector to deter theft or prevent unintended use by setting up the following security features:

- Password security to prevent the projector from being turned on, and prevent changes to the startup screen and other settings.
- Button lock security to block operation of the projector using the buttons on the control panel.
- Security cabling to physically cable the projector in place.

[Password Security Types](#)

[Locking the Projector's Buttons](#)

[Installing a Security Cable](#)

**Parent topic:** [Adjusting Projector Features](#)

## Password Security Types

You can set up these types of password security using one shared password:

- **Power On Protection** password prevents anyone from using the projector without first entering a password.
- **User's Logo** password prevents anyone from changing the custom screen the projector can display when it turns on. The presence of the custom screen discourages theft by identifying the projector's owner.
- **Network** password prevents anyone from changing the network settings in the projector menus.

[Setting a Password](#)

[Selecting Password Security Types](#)

[Entering a Password to Use the Projector](#)

[Saving a User's Logo Image to Display](#)

**Parent topic:** [Projector Security Features](#)

## Setting a Password

To use password security, you must set a password.

1. Hold down the **Freeze** button on the remote control for about 5 seconds or until you see this menu.

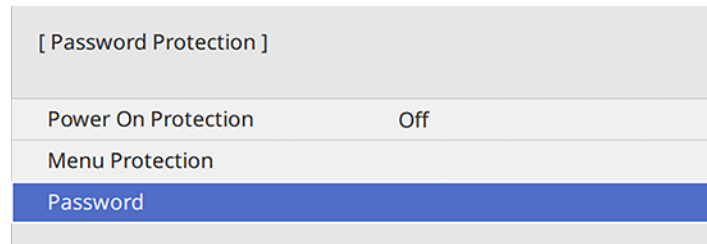

2. Press the down arrow to select **Password** and press **↵ Enter**.  
You see the prompt "Change the password?".
3. Select **Yes** and press **↵ Enter**.
4. Press and hold down the **Num** button on the remote control and use the numeric buttons to set a four-digit password.

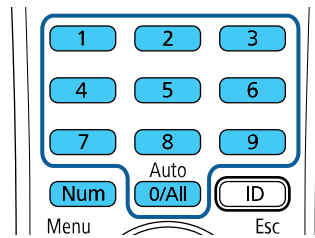

The password displays as \*\*\*\* as you enter it. Then you see the confirmation prompt.

5. Enter the password again.  
You see the message "Password accepted."
6. Press **Esc** to return to the menu.
7. Make a note of the password and keep it in a safe place in case you forget it.

**Parent topic:** [Password Security Types](#)

## Selecting Password Security Types

After setting a password, you see this menu, allowing you to select the password security types you want to use.

[ Password Protection ]	
Power On Protection	Off
Menu Protection	
Password	

If you do not see this menu, hold down the **Freeze** button on the remote control for about five seconds or until the menu appears.

- To prevent unauthorized use of the projector, select **Power On Protection**, press **↵ Enter**, select **On**, press **↵ Enter** again, and press **Esc**.
- To prevent changes to certain projector settings, select **Menu Protection**, press **↵ Enter**, and do the following as necessary:
  - To prevent changes to the User's Logo screen or related display settings, select **User's Logo**, press **↵ Enter**, select **On**, press **↵ Enter** again, and press **Esc**.
  - To prevent changes to the projector's time or schedule settings, select **Schedule**, press **↵ Enter**, select **On**, press **↵ Enter** again, and press **Esc**.
  - To prevent changes to network settings, select **Network**, press **↵ Enter**, select **On**, press **↵ Enter** again, and press **Esc**.

You can attach the Password Protect sticker to the projector as an additional theft deterrent.

**Note:** Be sure to keep the remote control in a safe place; if you lose it, you will not be able to enter the password required to use the projector.

**Parent topic:** [Password Security Types](#)

## Entering a Password to Use the Projector

If a password is set up and a password is enabled, you see a prompt to enter a password whenever you turn on the projector.

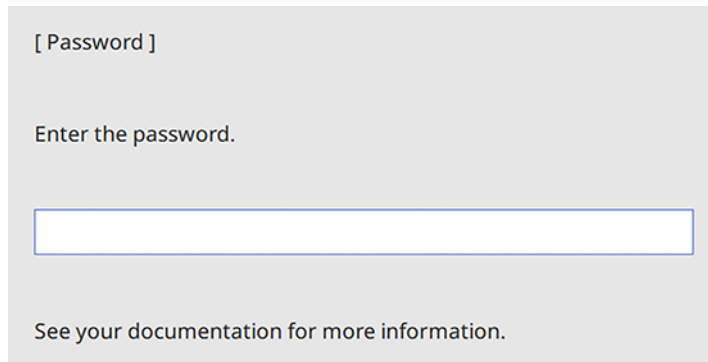

You must enter the correct password to use the projector.

1. Press and hold down the **Num** button on the remote control while you enter the password using the numeric buttons.

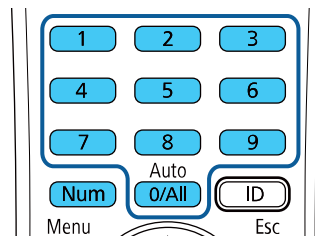

The password screen closes.

2. If the password is incorrect, the following may happen:
  - You see a "wrong password" message and a prompt to try again. Enter the correct password to proceed.
  - If you have forgotten the password, make note of the **Request Code: xxxxx** number that appears on the screen and contact Epson Support.

- If you enter an incorrect password three times in succession, you see a message telling you that the projector is locked. After the message is displayed for 5 minutes, the projector enters standby mode. Unplug the projector, plug in the power cord, and turn on the projector. You see a prompt to enter the password.
- If you continue to enter an incorrect password many times in succession, the projector displays a request code and a message to contact Epson Support. Do not attempt to enter the password again. When you contact Epson Support, provide the displayed request code and proof of ownership for assistance in unlocking the projector.

**Parent topic:** [Password Security Types](#)

### **Saving a User's Logo Image to Display**

You can transfer an image to the projector and then display it whenever the projector turns on. You can also display the image when the projector is not receiving an input signal or when you temporarily stop projection. This transferred image is called the User's Logo screen.

The image you select as the User's Logo can be a photo, graphic, or company logo, which is useful in identifying the projector's owner to help deter theft. You can prevent changes to the User's Logo by setting up password protection for it.

**Note:** You cannot save an image that is protected by HDCP as a User's Logo. You cannot display a user's logo when **Content Playback** is set to **On**. If you turned on password protection for the User's Logo, turn it off before performing these steps.

**Note:** When you copy the menu settings from one projector to another using the batch setup feature, the user logo is also copied. Do not include any information in the user logo that you do not want to share between multiple projectors.

1. Display the image you want to project as the User's Logo.



2. Press the **Menu** button, select the **Management** menu, and press **↵ Enter**.



3. Select the **User's Logo** setting and press **↵ Enter**.
4. Select **Start Setting** and press **↵ Enter**.

You see a prompt asking if you want to use the displayed image as a user's logo.

**Note:** When you select **User's Logo**, adjustments such as **Geometry Correction**, **E-Zoom**, **Aspect**, and **Screen Type** are temporarily canceled.

5. Select **Yes** and press **↵ Enter**.

**Note:** Depending on the image signal, the screen size may change to match the resolution of the image signal.

6. Make sure the image appears as you want it, then select **Yes** again and press **↵ Enter**.  
You see a completion message.
7. Press **Esc** to exit the message screen.

8. Select the **Display** menu and press **↵ Enter**.
9. Select when you want to display the User's Logo screen:
  - To display it whenever there is no input signal, select **No-Signal Screen** and set it to **Logo**.
  - To display it whenever you turn the projector on, select **Startup Screen** and set it to **On**.

To prevent anyone from changing the User's Logo settings without first entering a password, set a password and enable User's Logo security.

Parent topic: [Password Security Types](#)

## Locking the Projector's Buttons

You can lock the buttons on the projector's control panel to prevent anyone from using the projector. You can lock all the buttons or all the buttons except the power button.

**Note:** The projector can still be operated using the remote control.

1. Press the **Menu** button.
2. Select the **Management** menu and press **↵ Enter**.

Frequently Used Items	Management	
Image	User Button	Light Source Mode
Signal I/O	User's Logo	
Installation	User Pattern	
Display	Control Panel Lock	Off
Operation	Color Uniformity	
Management	Refresh Mode	
Network	Light Source Calibration	
Multi-Projection	Date & Time	
ECO	Schedule Settings	
Initial/All Settings	Wireless LAN Power	
	Wireless LAN Diagnosis	1
	Log Save Destination	USB and Internal Memory
	Batch Setup Range	
	Language 	English
	Information	
	Display Logs	
	Reset Management Settings	
	Network	

3. Select the **Control Panel Lock** setting and press **↵ Enter**.
4. Select one of these lock types and press **↵ Enter**:
  - To lock all of the projector's buttons, select **Full Lock**.
  - To lock all buttons except the power button, select **Except for Power**.You see a confirmation prompt.
5. Select **Yes** and press **↵ Enter**.

#### [Unlocking the Projector's Buttons](#)

**Parent topic:** [Projector Security Features](#)

### Unlocking the Projector's Buttons

If the projector's buttons have been locked, hold the **↵ Enter** button on the projector's control panel for 7 seconds to unlock them. You can also set the **Control Panel Lock** setting to **Off** in the Management menu.

**Parent topic:** [Locking the Projector's Buttons](#)

### Installing a Security Cable

You can install two types of security cables on the projector to deter theft.

- Use the security slot on the projector to attach a Kensington lock. See your local computer or electronics dealer for purchase information.
- Use the security cable attachment point on the projector to attach a wire cable and secure it to a room fixture or heavy furniture.

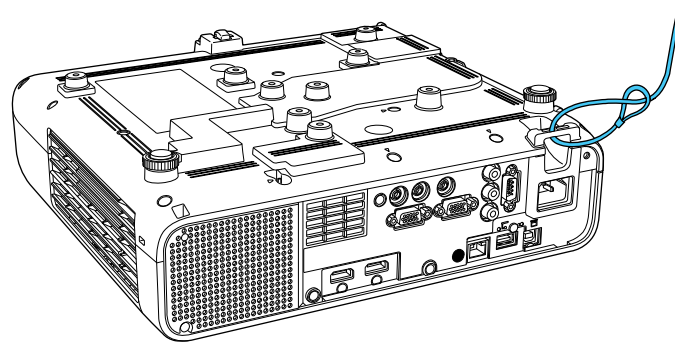

**Parent topic:** [Projector Security Features](#)

## Creating a User Pattern to Display

You can transfer an image to the projector and then display it as a pattern to aid in presentations when you use the Pattern Display feature. This transferred image is called the User Pattern.

**Note:** Once you save a user pattern, you cannot restore the default pattern. You cannot save an image that is protected by HDCP.

1. Display the image you want to project as the User Pattern from a connected computer or video source.
2. Press the **Menu** button, select the **Management** menu, and press **↵ Enter**.



The screenshot shows a two-column menu interface. The left column lists various menu categories, and the right column lists specific settings. The 'Management' category is highlighted in blue, and the 'User Pattern' option is selected within that category.

Frequently Used Items	Management
Image	User Button Light Source Mode
Signal I/O	User's Logo
Installation	User Pattern
Display	Control Panel Lock Off
Operation	Color Uniformity
Management	Refresh Mode
Network	Light Source Calibration
Multi-Projection	Date & Time
ECO	Schedule Settings
Initial/All Settings	Wireless LAN Power
	Wireless LAN Diagnosis 1
	Log Save Destination USB and Internal Memory
	Batch Setup Range
	Language 🌐 English
	Information
	Display Logs
	Reset Management Settings

3. Select the **User Pattern** setting and press **↵ Enter**.

You see a prompt asking if you want to use the displayed image as a User Pattern.

**Note:** When you select **User Pattern**, adjustments such as **Keystone**, **E-Zoom**, and **Aspect** are temporarily canceled.

4. Select **Yes** and press **↵ Enter**.

**Note:** It takes a few moments for the projector to save the image; do not use the projector, its remote control, or any connected equipment until it is finished.

You see a completion message.

5. Press **Esc** to exit the message screen.

To view your user pattern, press the **Menu** button, select the **Display** menu, and press **↵ Enter**. Set the **Pattern Type** setting to **User Pattern**, then return to the Display menu and select **Pattern Display**.

**Parent topic:** [Adjusting Projector Features](#)

## Copying Menu Settings Between Projectors

After you select menu settings for your projector, you can transfer them to another projector of the same model.

**Note:** Copy the projector's settings before you adjust the projected image using the projector's image adjustment settings. Any saved User's Logo setting on the projector will transfer to the other projector.

**Caution:** If the copy process fails due to a power failure, communication error, or for any other reason, Epson will not be responsible for any repair costs incurred.

The following settings will not transfer between projectors:

- Light Source Hours
- Status

The following settings will not transfer between projectors if you set the **Batch Setup Range** setting to **Limited**:

- Password Protection settings
- **EDID** in the Signal I/O menu
- Network menu settings

**Note:** In addition to the methods covered in this section, you can also copy and transfer settings to multiple projectors over a network using the Epson Projector Management software. See the online *Epson Projector Management Operation Guide* for instructions. You can download the latest software and documentation from the Epson website.

- [Saving Settings to a USB Flash Drive](#)
- [Transferring Settings from a USB Flash Drive](#)
- [Saving Settings to a Computer](#)
- [Transferring Settings from a Computer](#)
- Parent topic:** [Adjusting Projector Features](#)

## Saving Settings to a USB Flash Drive

You can save the projector settings you want to transfer to a USB flash drive.

**Note:** Use an empty flash drive. If the drive contains other files, the transfer may not complete correctly. The flash drive must use the FAT format and cannot have any security features.

1. Turn off the projector and unplug the power cord from the projector's power inlet.
2. Insert the flash drive into the **USB-A** port.

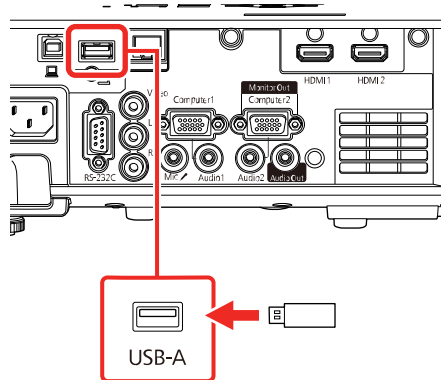

**Note:** Connect the flash drive directly to the projector. Do not use a hub or your settings may not be saved correctly.

3. Press and hold the **Esc** button on the control panel or remote control as you connect the power cord to the projector's power inlet. Press and hold the **Esc** button on the control panel or remote control as you turn on the power switch.
4. When all of the projector lights turn on, release the **Esc** button.

The lights flash to indicate that settings are transferring to the flash drive. When the lights stop flashing, the projector turns off.

**Caution:** Do not unplug the power cord or remove the flash drive while the lights are flashing. This could damage the projector.

5. Remove the flash drive.

**Note:** The file name for the batch setup file is PJCONFDATA.bin. If you need to change the file name, add text after PJCONFDATA using only alphanumeric characters. If you change the PJCONFDATA section of the file name, the projector may not be able to recognize the file correctly.

**Parent topic:** [Copying Menu Settings Between Projectors](#)

## Transferring Settings from a USB Flash Drive

After saving projector settings to a USB flash drive, you can transfer them to another projector of the same model.

**Note:** Make sure the USB flash drive contains only a single settings transfer from another projector of the same model. The settings are contained in a file called **pjconfdata.bin**. If the drive contains other files, the transfer may not complete correctly.

Do not adjust image settings on a projector until after you transfer settings to it. Otherwise, you may have to repeat your adjustments.

1. Turn off the projector and unplug the power cord from the projector's power inlet.

2. Insert the flash drive into the **USB-A** port.

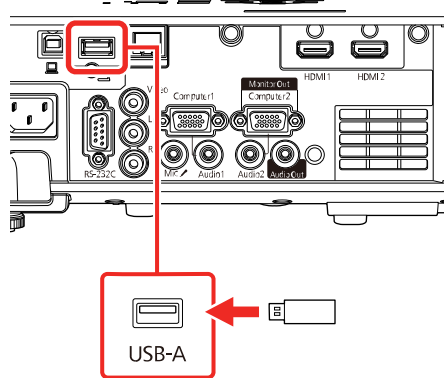

**Note:** Connect the flash drive directly to the projector. Do not use a hub or your settings may not be saved correctly.

3. Press and hold the **Menu** button on the control panel or remote control as you connect the power cord to the projector's power inlet.
4. When all of the projector lights turn on, release the **Menu** button.  
The lights flash to indicate that settings are transferring to the projector. When the lights stop flashing, the projector turns off.

**Caution:** Do not unplug the power cord or remove the flash drive while the lights are flashing. This could damage the projector.

5. Remove the flash drive.

**Parent topic:** [Copying Menu Settings Between Projectors](#)

## Saving Settings to a Computer

You can save the projector settings you want to transfer to a computer.

Your computer must be running one of the following operating systems:

- Windows 8.1 or later.
- macOS 10.13.x or later



1. Turn off the projector and unplug the power cord from the projector's power inlet.
2. Connect a USB cable to your projector's **USB-B** port.

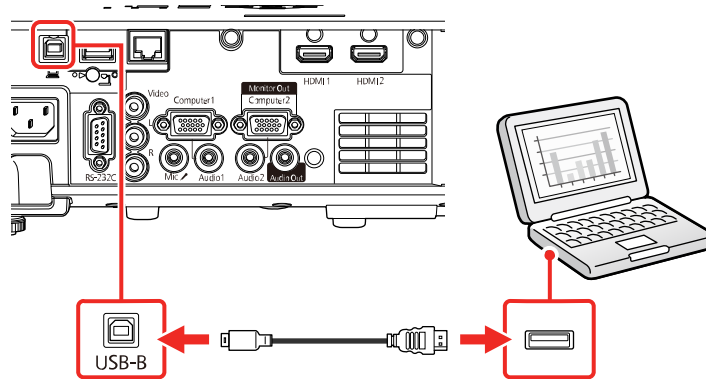

3. Connect the other end to any available USB port on your computer.
  4. Press and hold the **Esc** button on the control panel or remote control as you connect the power cord to the projector's power inlet.
  5. When all of the projector lights turn on, release the **Esc** button.  
The projector shows up as a removable disk on your computer.
  6. Open the removable disk and copy the **pjconfdata.bin** file to your computer.
  7. Once the file has copied, do one of the following:
    - **Windows:** Open the **My Computer**, **Computer**, **Windows Explorer**, or **File Explorer** utility. Right-click the name of your projector (listed as a removable disk) and select **Eject**.
    - **Mac:** Drag the removable disk icon for your projector from the desktop into the trash.
- The projector turns off when you disconnect the USB cable.

Parent topic: [Copying Menu Settings Between Projectors](#)

## Transferring Settings from a Computer

After saving projector settings to a computer, you can transfer them to another projector of the same model.

Your computer must be running one of the following operating systems:

- Windows 8.1 or later.
- macOS 10.13.x or later

Do not adjust image settings on a projector until after you transfer settings to it. Otherwise, you may have to repeat your adjustments.

1. Turn off the projector and unplug the power cord from the projector's power inlet.
2. Connect a USB cable to your projector's **USB-B** port.

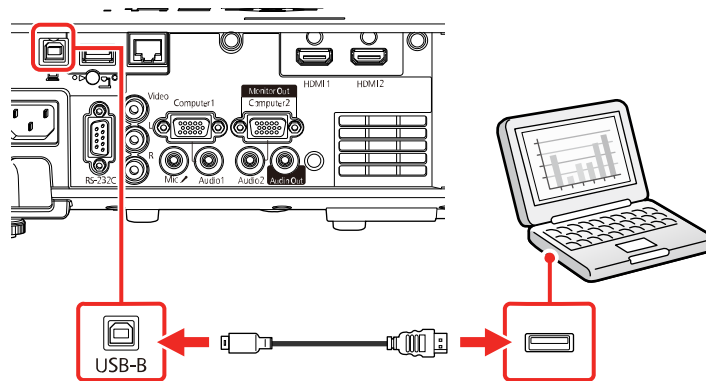

3. Connect the other end to any available USB port on your computer.
4. Press and hold the **Menu** button on the control panel or remote control as you connect the power cord to the projector's power inlet.
5. When all of the projector lights turn on, release the **Menu** button.  
The projector shows up as a removable disk on your computer.
6. Copy the **pjconfdata.bin** file from your computer to the removable disk.

**Note:** Do not copy any other files to the removable disk.

7. Once the file has copied, do one of the following:
  - **Windows:** Open the **My Computer**, **Computer**, **Windows Explorer**, or **File Explorer** utility. Right-click the name of your projector (listed as a removable disk) and select **Eject**.
  - **Mac:** Drag the removable disk icon for your projector from the desktop into the trash.

All the lights start flashing to indicate that the projector's settings are being updated. Disconnect the USB cable. When all of the indicators stop flashing, the projector turns off.

**Caution:** Do not unplug the power cord while the lights are flashing. This could damage the projector.

**Parent topic:** [Copying Menu Settings Between Projectors](#)

## Scheduling Projector Events

You can save a projector command, such as turning the projector on or off or switching input sources, as an "event." You can schedule when you want the projector to automatically execute the command.

**Warning:** Do not place flammable objects in front of the lens. If you schedule the projector to turn on automatically, flammable objects in front of the lens could catch on fire.

**Note:** The **Schedule** setting in the Menu Protection menu must be turned off to schedule an event.

[Saving a Scheduled Event](#)

[Viewing Scheduled Events](#)

[Editing a Scheduled Event](#)

**Parent topic:** [Adjusting Projector Features](#)

## Saving a Scheduled Event

You can select projector commands you want to perform and schedule them as an event.

**Warning:** Do not place flammable objects in front of the lens. If you schedule a projector to turn on automatically, flammable objects in front of the lens could catch on fire.

**Note:** The **Schedule** setting in the Menu Protection menu must be turned off to schedule an event.

1. Press the **Menu** button.
2. Select the **Management** menu and press **↵ Enter**.
3. Select the **Schedule Settings** setting and press **↵ Enter**.
4. Select the **Schedule** menu and press **↵ Enter**.
5. Select **Add New** and press **↵ Enter**.

You see a screen like this:

The screenshot displays a web interface for 'Schedule Settings'. On the left is a dark blue sidebar with the following menu items: 'Schedule' (highlighted), 'Schedule Reset', and 'Setup complete'. The main content area has a light gray background. At the top right of this area is a 'Return' button. Below the header is a blue bar with a '+ Add New' button. The central part of the interface is a calendar grid. The columns are labeled with dates: 7-1, 7-2, 7-3, 7-4, 7-5, 7-6, and 7-7. The rows are labeled with times: 04:00, 08:00, 12:00, 16:00, and 20:00. The '7-1' column is highlighted in blue. Navigation arrows are visible on the left and right sides of the date header.

6. In the Event Settings section, select the events you want to have occur. (Select **No Change** for events that you do not want to occur.)

Schedule

Schedule Reset

Setup complete

Event Settings

Power No Change

Source No Change

Light Source Mode No Change

A/V Mute No Change

Volume No Change

Light Source Calibration No Change

Refresh Mode No Change

Date / Time Settings

Type  Date  Day of the Week

Date 2019-07-01

Day of the Week

Time 00:00

Save Cancel

7. In the Date/Time Settings section, set the date and time for the scheduled events to occur.

Schedule

Reset

Complete

Event Settings

Power No Change

Source No Change

Light Source Mode No Change

A/V Mute No Change

Volume No Change

Light Source Calibration No Change

Refresh Mode No Change

Date / Time Settings

Type  Date  Day of the Week

Date 2019-07-01

Day of the Week

Time 00:00

Save Cancel

- When you are finished, select **Save** and press **↵ Enter**.
- To schedule more events, repeat the previous steps as necessary. You can schedule up to 30 events.

**Parent topic:** [Scheduling Projector Events](#)

## Viewing Scheduled Events

You can view your scheduled events on the calendar displayed on the Schedule Settings screen.

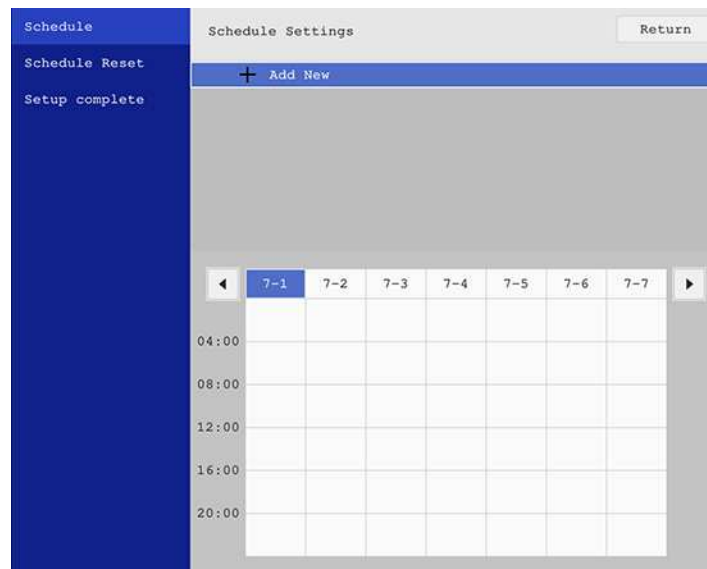

- Press the **Menu** button.
- Select the **Management** menu and press **↵ Enter**.
- Select **Schedule Settings** and press **↵ Enter**.
- Select **Schedule** and press **↵ Enter**.

You see a screen like this:



Colored boxes on the calendar indicate the following:

One-time event

-  Repeating event
-  Communication is on or off
-  Event is invalid

5. To view an event, press the left and right arrow buttons on the remote to select a day. The screen displays the details of the events scheduled for that day. A blue icon indicates an enabled event, a gray icon indicates a disabled event, and the  icon indicates a repeating event.

Parent topic: [Scheduling Projector Events](#)

## Editing a Scheduled Event

You can edit any currently scheduled event.

1. Press the **Menu** button.
2. Select the **Management** menu and press **↵ Enter**.
3. Select the **Schedule Settings** setting and press **↵ Enter**.

You see a screen like this:

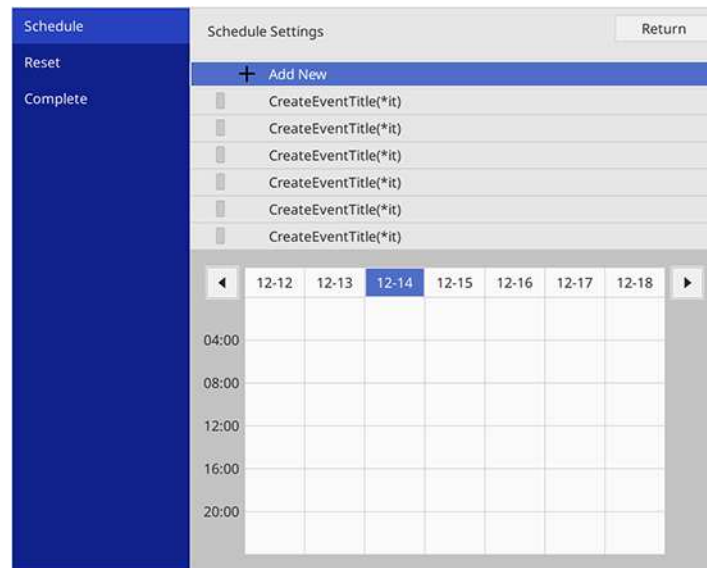

4. Press the left or right arrow buttons to highlight the date on the calendar containing the scheduled event you want to edit.
5. Press the up or down arrow buttons to highlight the event you want to edit, and press **↵ Enter**.
6. Select one of the following:
  - **On/Off** to enable or disable the selected event.
  - **Edit** to edit the settings for the selected event.
  - **Clear** to delete the selected event.
  - **Add New** to add a new scheduled event.
7. When you are finished, select **Return** and press **↵ Enter**.
8. Select **Complete** and press **↵ Enter** to save your changes.

**Note:** To delete all scheduled events, select **Schedule Reset** and select **Yes**.

**Parent topic:** [Scheduling Projector Events](#)



---

# Adjusting the Menu Settings

Follow the instructions in these sections to access the projector menu system and change projector settings.

**Note:** Not all settings are available, depending on your projector model.

[Using the Projector's Menus](#)

[Image Quality Settings - Image Menu](#)

[Input Signal Settings - Signal I/O Menu](#)

[Installation Settings - Installation Menu](#)

[Display Settings - Display Menu](#)

[Feature Settings - Operation Menu](#)

[Administration Settings - Management Menu](#)

[Network Settings - Network Menu](#)

[Multiple Projector Operation Settings - Multi-Projection Menu](#)

[Setup Settings - ECO Menu](#)

[Initial Settings and Reset Options - Initial/All Settings Menu](#)

## Using the Projector's Menus

You can use the projector's menus to adjust the settings that control how your projector works. The projector displays the menus on the screen.

1. Press the **Menu** button on the control panel or remote control.

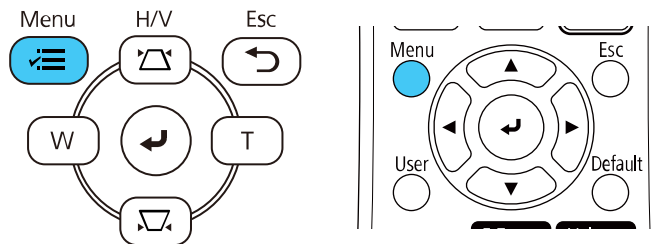

You see the menu screen.

Frequently Used Items	Image	
Image	Color Mode	Dynamic
Signal I/O	Brightness	50
Installation	Contrast	50
Display	Color Saturation	50
Operation	Tint	50
Management	Sharpness	5
Network	White Balance	
Multi-Projection	Dynamic Contrast	Off
ECO	Image Enhancement	
Initial/All Settings	Scene Adaptive Gamma	0
	Gamma	0
	RGBCMY	
	Reset to Defaults	
	Source	HDMI1
	Aspect	Auto
	Reset to Defaults	
	Scale	
	Reset Image Settings	

2. Press the up or down arrow button to move through the menus listed on the left. The settings for each menu are displayed on the right.

**Note:** The available settings depend on the current input source, resolution, or other menu settings.

3. To change settings in the displayed menu, press **↵ Enter**.
4. Press the up or down arrow button to move through the settings.
5. To return all the menu settings to their default values, select the **Initial/All Settings** menu.
6. When you finish changing settings on a menu, press **Esc**.
7. Press **Menu** or **Esc** to exit the menus.

**Note:** The  icon indicates that a setting contains sub-settings.

**Parent topic:** [Adjusting the Menu Settings](#)

## Image Quality Settings - Image Menu

Settings on the Image menu let you adjust the quality of your image for the input source you are currently using. The available settings depend on the currently selected color mode and input source.

Frequently Used Items	Image	
Image	Color Mode	Dynamic
Signal I/O	Brightness	50
Installation	Contrast	50
Display	Color Saturation	50
Operation	Tint	50
Management	Sharpness	5
Network	White Balance	
Multi-Projection	Dynamic Contrast	Off
ECO	Image Enhancement	
Initial/All Settings	Scene Adaptive Gamma	0
	Gamma	0
	RGBCMY	
	Reset to Defaults	
	Source	HDMI1
	Aspect	Auto
	Reset to Defaults	
	Scale	
	Reset Image Settings	

### Color Mode Settings

Setting	Options	Description
<b>Color Mode</b>	See the list of available Color Modes	Adjusts the vividness of image colors for various image types and environments
<b>Brightness</b>	Varying levels available	Lightens or darkens the overall image
<b>Contrast</b>	Varying levels available	Adjusts the difference between light and dark areas of the image
<b>Color Saturation</b>	Varying levels available	Adjusts the intensity of the image colors

Setting	Options	Description
<b>Tint</b>	Varying levels available	Adjusts the balance of green to magenta tones in the image
<b>Sharpness</b>	Varying levels available	Adjusts the sharpness or softness of image details
<b>White Balance</b>	<b>Color Temp.</b> <b>G-M Correction</b> <b>Custom</b>	Sets the overall color tone of the image  <b>Color Temp.:</b> sets the color temperature according to the selected color mode; lower values tint the image red, and higher values tint the image blue  <b>G-M Correction:</b> makes fine adjustments to the color tone; higher values tint the image green and lower values tint the image red  <b>Custom:</b> adjusts the individual RGB components of the offset and gain
<b>Dynamic Contrast</b>	<b>Off</b> <b>Normal</b> <b>High Speed</b>	Adjusts the projected luminance based on the image brightness

Setting	Options	Description
<b>Image Enhancement</b>	<b>Image Preset Mode</b>	Selects preset Image Enhancement settings
	<b>Noise Reduction</b>	Reduces flickering in analog images
	<b>MPEG Noise Reduction</b>	Reduces the noise or static in MPEG video
	<b>Deinterlacing</b>	Sets whether to convert interlaced-to-progressive signals for interlaced video signals (480i/576i/1080i) <b>Off:</b> for fast-moving video images <b>Video:</b> for most video images <b>Film/Auto:</b> for movies, computer graphics, and animation
	<b>Super-resolution</b>	Sharpens blurred images when projecting low-resolution images <b>Fine Line Adjust:</b> enhances the contrast and outlines of complicated images <b>Soft Focus Detail:</b> enhances the contrast and outlines of smooth backgrounds
	<b>Detail Enhancement</b>	Enhances details to create clear outlines <b>Strength:</b> higher settings create a stronger effect <b>Range:</b> higher settings increase the affected area around the outline
	<b>Reset</b>	Resets all settings in the Image Enhancement menu
<b>Scene Adaptive Gamma</b>	Varying levels available	Adjusts the coloring according to the scene to obtain a more vivid image; larger numbers enhance the contrast

Setting	Options	Description
<b>Gamma</b>	<b>-2 to 2</b> <b>Custom</b>	Adjusts the colors by selecting one of the gamma correction values or referring to a gamma graph
<b>RGBCMY</b>	Varying levels available	Adjusts the hue, saturation, and brightness for each color
<b>Reset to Defaults</b>	—	Resets all settings for the Color Mode currently selected

**Note:** The **Brightness** setting does not affect laser brightness. To change the laser brightness mode, use the **Light Source Brightness Control** setting in the Operation menu.

### Input Source Settings

To change settings for an input source, make sure the source is connected and select that source.

**Note:** You can restore the default settings of the **Tracking**, **Sync**, and **Position** settings by pressing the **Auto** button on the remote control.

Setting	Options	Description
<b>Source</b>	—	Displays the current input source selected
<b>Resolution</b>	<b>Auto</b> <b>Normal</b> <b>Wide</b>	Sets the VGA input signal resolution if not detected automatically using the <b>Auto</b> option (only for computer inputs)
<b>Aspect</b>	See the list of available aspect ratios	Sets the aspect ratio (width-to-height ratio)  Turn off the <b>Scale</b> setting or set the <b>Scale Mode</b> setting to <b>Full Display</b> before selecting this setting. (EB-L210SF)

Setting	Options	Description
<b>Analog Signal Adjustment</b>	<b>Auto Setup</b> <b>Tracking</b> <b>Sync.</b> <b>Position</b>	Adjusts the signal when <b>Computer</b> is the currently selected input source  <b>Auto Setup:</b> set to <b>On</b> to automatically optimize the image quality  <b>Tracking:</b> adjusts the signal to eliminate vertical stripes in images  <b>Sync:</b> adjusts signal to eliminate fuzziness or flickering in images  <b>Position:</b> adjusts the image location on the screen
<b>Reset to Defaults</b>	—	Resets all settings for the currently selected input source
<b>Scale (EB-L210SF)</b>	Varying levels available	When using multiple projectors, adjusts the scale of the image displayed by each projector

**Note:** Select **Reset Image Settings** to reset all settings on the Image menu to their default values.

**Parent topic:** [Adjusting the Menu Settings](#)

## Input Signal Settings - Signal I/O Menu

Normally the projector detects and optimizes the input signal settings automatically. If you need to customize the settings, you can use the Signal I/O menu. The available settings depend on the currently selected input source.

Frequently Used Items	Signal I/O	
Image	Volume	
Signal I/O	Source	HDMI1
Installation	Signal Format	
Display	Mic Input Level	50
Operation	Overscan	Off
Management	Reset to Defaults	
Network	EDID	
Multi-Projection	HDMI IN EQ Level	
ECO	A/V Output	While Projecting
Initial/All Settings	Audio Output	Auto
	HDMI Audio Output	
	Monitor Out Port	Monitor Out
	HDMI Link	
	Reset Signal I/O Settings	
	Installation	
	Fixed Installation	Off
	Test Pattern	

To change settings for an input source, make sure the source is connected and select that source.

Setting	Options	Description
<b>Volume</b>	Varying levels available	Adjusts the volume of the projector's speaker system or external speakers



Setting	Options	Description
<b>Source</b>	<b>Signal Format</b> <b>Mic Input Level</b> <b>Overscan</b> <b>Reset to Defaults</b>	<p>Displays settings selected for the current input source</p> <p><b>Signal Format:</b> sets the signal type and video range for certain input sources</p> <ul style="list-style-type: none"> <li>• <b>Video Signal:</b> specifies the signal type from input sources connected to video ports; if interference appears or no image appears when set to <b>Auto</b>, select the appropriate signal type</li> <li>• <b>Video Range:</b> sets the video range to match the setting of an input source connected to the HDMI ports</li> </ul> <p><b>Mic Input Level:</b> adjusts the volume from a microphone when audio is not output to an audio/visual system; when the <b>Mic Input Level</b> setting is turned up, the volume of the other connected device is turned down, and when the <b>Mic Input Level</b> is turned down, the volume of the other connected device is turned up</p> <p><b>Overscan:</b> changes the projected image ratio to make the edges visible by a selectable percentage or automatically when projecting a component signal</p> <p><b>Reset to Defaults:</b> resets all settings for the current input source</p>
<b>EDID</b>	<b>HDMI1</b> <b>HDMI2</b>	<p>Describes the display capabilities of your projector when the selected input source is <b>HDMI</b>; change this setting as necessary according to the resolution of the current input source</p>

Setting	Options	Description
HDMI IN EQ Level	HDMI1 HDMI2	Adjusts the HDMI input signal level depending on the devices connected to the HDMI port. Change the setting if there is a lot of interference in the image or if no image is projected.
A/V Output	While Projecting Always On	Determines when the projector outputs audio and images to external devices; set to <b>Always On</b> to output audio and images when the projector is in standby mode.  This setting is only displayed when <b>Quick Startup</b> is set to <b>Off</b> in the projector's Operation menu, <b>Auto Power On</b> is set to <b>Off</b> in the projector's Network menu, or <b>Auto Power On</b> is set to <b>HDMI1</b> and <b>Power On Trigger</b> is set to <b>Plug-in Detection</b> in the projector's Operation menu.
Audio Output	Auto Audio1 Audio2 Audio L/R	Sets the audio input port when projecting from input sources other than HDMI, LAN, and Screen Mirroring
HDMI Audio Output	HDMI1 Audio Output HDMI2 Audio Output	Sets the audio input port when projecting from one of the HDMI ports
Monitor Out Port	Monitor Out Computer2	Selects the function of the <b>Computer2/Monitor Out</b> port  <b>Monitor Out:</b> select this option when outputting an image signal to an external monitor  <b>Computer2:</b> select this option when inputting an image signal from a computer

Setting	Options	Description
HDMI Link	<b>Device Connections</b> <b>HDMI Link</b> <b>Audio Out Device</b> <b>Power On Link</b> <b>Power Off Link</b>	<p>Adjusts the HDMI Link options that allow the projector or remote to control HDMI-connected devices that support the CEC standard</p> <p><b>Device Connections:</b> lists the devices connected to the <b>HDMI1</b> and <b>HDMI2</b> ports when <b>HDMI Link</b> is enabled</p> <p><b>HDMI Link:</b> enables or disables the HDMI Link feature</p> <p><b>Audio Out Device:</b> selects whether to output audio from the internal speakers or a connected audio/visual system</p> <p><b>Power On Link:</b> controls what happens when you turn on the projector or a linked device</p> <ul style="list-style-type: none"> <li>• <b>Bidirectional:</b> automatically turns on the connected device when you turn on the projector, and vice versa</li> <li>• <b>Device -&gt; PJ:</b> automatically turns on the projector when you turn on the connected device</li> <li>• <b>PJ -&gt; Device:</b> automatically turns on the connected device when you turn on the projector</li> </ul> <p><b>Power Off Link:</b> controls whether linked devices are turned off when the projector is turned off</p>
Reset Signal I/O Settings		Resets all settings on the Signal I/O menu to their default values

Parent topic: [Adjusting the Menu Settings](#)

## Installation Settings - Installation Menu

Settings on the Installation menu let you set up your projector for your installation environment. The available settings depend on the currently selected input source and other settings.

Frequently Used Items	Installation	
Image	Fixed Installation	Off
Signal I/O	Test Pattern	
Installation	Projection	Front/Ceiling
Display	Geometry Correction	Point Correction
Operation	Digital Zoom	
Management	Remote Receiver	Off
Network	Screen Type	16:9
Multi-Projection	High Altitude Mode	Off
ECO	Reset Installation Settings	
Initial/All Settings	Display	
	Pattern Display	
	Pattern Type	
	No-signal Screen	Blue
	Startup Screen	On
	Home Screen Auto Disp.	On
	Messages	On
	Menu Rotation	Off

Setting	Options	Description
<b>Fixed Installation</b>	<b>On</b> <b>Off</b>	Set to <b>On</b> if you installed the projector in a fixed location
<b>Test Pattern</b>	—	Displays a test pattern to assist in focusing and zooming the image and correcting image shape
<b>Projection</b>	<b>Front</b> <b>Front/Ceiling</b> <b>Rear</b> <b>Rear/Ceiling</b>	Selects the way the projector faces the screen so the image is oriented correctly

Setting	Options	Description
<b>Geometry Correction</b>	<b>H/V-Keystone</b> <b>Quick Corner</b> <b>Arc Correction</b> <b>Point Correction</b>	Adjusts image shape to rectangular (horizontally and vertically) <b>H/V Keystone:</b> lets you manually correct horizontal and vertical sides <b>Quick Corner:</b> select to correct image shape and alignment using an on-screen display <b>Arc Correction:</b> select to adjust the curve or arc of the horizontal and vertical sides <b>Point Correction:</b> select to divide the projected image into a grid and correct distortion by moving a selected point
<b>Digital Zoom</b>	Varying levels available	Adjusts the size of the projected image
<b>Image Shift</b>	Varying positions available	Adjusts the position of the projected image
<b>Remote Receiver</b>	<b>Front/Rear</b> <b>Front</b> <b>Rear</b> <b>Off</b>	Limits reception of remote control signals by the selected receiver; <b>Off</b> turns off all receivers
<b>Projector ID (EB-L210SW)</b>	<b>Off</b> 1 through 9	Assigns an ID for the projector when you use multiple projectors
<b>Screen Type</b>	<b>4:3</b> <b>16:9</b> <b>16:10</b> <b>21:9 (EB-L210SF)</b>	Sets the aspect ratio to fit the image on the projection surface; not available in Content Playback mode

Setting	Options	Description
<b>Screen Position</b>	Varying positions available	Shifts the image position on the screen (only available if the <b>Screen Type</b> setting is not set to the same aspect ratio as the projector's native resolution)
<b>High Altitude Mode</b>	<b>On</b> <b>Off</b>	Regulates the projector's operating temperature at altitudes above 4921 feet (1500 m)
<b>Reset Installation Settings</b>	—	Resets all settings on the Installation menu to their default values except for the following: <ul style="list-style-type: none"> <li>• <b>Digital Zoom</b></li> <li>• <b>Image Shift</b></li> </ul>

Parent topic: [Adjusting the Menu Settings](#)

## Display Settings - Display Menu

Settings on the Display menu let you customize various projector display features. The available settings depend on the currently selected input source and other settings.



Setting	Options	Description
<b>Pattern Display</b>	—	Displays the selected pattern type to assist in adjusting the image  <b>Note:</b> If a pattern is displayed for a long time, a residual image may be visible in projected images.

<b>Setting</b>	<b>Options</b>	<b>Description</b>
<b>Pattern Type</b>	<b>Pattern 1</b> <b>Pattern 2</b> <b>Pattern 3</b> <b>Pattern 4</b> <b>User Pattern</b>	Selects the type of grid pattern, line pattern, or custom pattern to display
<b>No-signal Screen</b>	<b>Black</b> <b>Blue</b> <b>Logo</b> <b>Gradation</b>	Select the screen color or logo to display when no input signal is detected; not available in Content Playback mode
<b>Startup Screen</b>	<b>On</b> <b>Off</b>	Controls whether a logo is displayed when the projector starts up
<b>Home Screen Auto Disp.</b>	<b>On</b> <b>Off</b>	Controls whether the Home screen is displayed automatically when no input signal is detected when the projector turns on
<b>Sort Source Thumbnails</b>	<b>On</b> <b>Off</b>	Displays the detected input source in the upper left position of the Home screen. The display order of the input sources changes when the projector detects an input signal.
<b>Messages</b>	<b>On</b> <b>Off</b>	Controls whether projector status and error messages are displayed on the projected image
<b>Menu Rotation</b>	<b>Right 90 Degree</b> <b>Left 90 Degree</b> <b>Off</b>	Rotates the menu display 90°
<b>Menu Color</b>	<b>White</b> <b>Black</b>	Sets the color theme of the Home screen and projector menu system



Setting	Options	Description
<b>Panel Alignment</b> (EB-L210SF)	<b>On</b> <b>Off</b>	Set to <b>On</b> to correct color misalignment in the projected image <b>Select Color:</b> select the color to correct <b>Pattern Color:</b> select the pattern used for correction <b>Start Adjustments:</b> start panel alignment <b>Reset:</b> resets all panel alignment settings to their defaults
<b>Split Screen Setting</b>	<b>Display Audio Output Source</b> <b>Align</b>	Adjusts the Split Screen feature; not available in Content Playback mode <b>Display Audio Output Source:</b> controls whether an icon is displayed with the source providing audio output during Split Screen projection <b>Align:</b> if splitting the screen between two images, determines whether the images are aligned at the top or in the middle of the screen
<b>Reset Display Settings</b>	—	Resets all settings on the Display menu to their default values

**Note:** You must disable User's Logo password protection to adjust the **No-signal Screen** and **Startup Screen** settings.

**Parent topic:** [Adjusting the Menu Settings](#)

## Feature Settings - Operation Menu

Settings on the Operation menu let you customize various projector features that control its operation. The available settings depend on the currently selected input source and other settings.

Frequently Used Items	Operation	
Image	Auto Source Search	On
Signal I/O	Light Source Brightness Cont...	
Installation	Direct Power On	Off
Display	Auto Power On	Off
Operation	Sleep Mode	Off
Management	A/V Mute Timer	On
Network	Standby Mode	Communication Off
Multi-Projection	Quick Startup	Off
ECO	USB Power	On While Projecting
Initial/All Settings	Closed Caption	off
	Indicators	On
	Content Playback	off
	Reset Operation Settings	
	Management	
	User Button	Light Source Mode
	User's Logo	
	User Pattern	

Setting	Options	Description
<b>Auto Source Search</b>	<b>On</b> <b>Off</b>	Enables the projector to automatically select an input source; not available in Content Playback mode or when the projector is turned on in Quick Startup mode

Setting	Options	Description
<b>Light Source Brightness Control</b>	<b>Maintain Brightness</b> (EB-L210SF) <b>Maintain Brightness Level</b> (EB-L210SF) <b>Light Source Mode</b> <b>Brightness Level</b>	<p>Controls the constant brightness of the projector's light source</p> <p><b>Maintain Brightness:</b> maintains a constant brightness</p> <p><b>Maintain Brightness Level:</b> selects the brightness level to maintain when the <b>Maintain Brightness</b> setting is enabled</p> <p><b>Light Source Mode:</b> selects the brightness mode of the projector when the <b>Maintain Brightness</b> setting is disabled</p> <ul style="list-style-type: none"> <li>• <b>Normal:</b> maximum brightness</li> <li>• <b>Quiet:</b> 70% brightness with reduced fan noise</li> <li>• <b>Extended:</b> 70% brightness and extends the life expectancy of the light source</li> <li>• <b>Custom:</b> select a custom brightness level and enable use of the next setting</li> </ul> <p><b>Brightness Level:</b> select the <b>Custom</b> brightness level you want</p>
<b>Direct Power On</b>	<b>On</b> <b>Off</b>	Controls whether the projector automatically turns on when you plug it in
<b>Auto Power On</b>	<b>HDMI1</b> <b>Computer1</b> <b>USB Display</b> <b>Off</b>	Selects whether to automatically turn on the projector when you connect an input signal to a specific input source

Setting	Options	Description
<b>Power On Trigger</b>	<b>Plug-in Detection</b> <b>Signal Detection</b>	<p>Selects the power on condition when <b>Auto Power On</b> is set to <b>HDMI1</b>:</p> <ul style="list-style-type: none"> <li>• <b>Plug-in Detection:</b> automatically turns on the projector when the device connected to the <b>HDMI1</b> port is turned on</li> <li>• <b>Signal Detection:</b> automatically turns on the projector when it detects an HDMI video signal on the <b>HDMI1</b> port; selecting this option increases standby power consumption</li> </ul>
<b>Sleep Mode</b>	<b>On</b> <b>Off</b>	Automatically turns off the projector after an interval of inactivity
<b>Sleep Mode Timer</b>	1 to 30 minutes	Sets the time before the projector automatically turns off ( <b>Sleep Mode</b> must be turned on)
<b>A/V Mute Timer</b>	<b>On</b> <b>Off</b>	Automatically turns off the projector after 30 minutes of inactivity

Setting	Options	Description
<b>Standby Mode</b>	<b>Communication On</b> <b>Communication Off</b>	<p>Enable this setting to allow monitoring and control of the projector over a network when the projector is in standby mode.</p> <p>This setting is only displayed in the following cases:</p> <ul style="list-style-type: none"> <li>• <b>A/V Output</b> is set to <b>While Projecting</b> in the Signal I/O menu</li> <li>• <b>Auto Power On</b> is not set to <b>HDMI1</b> and <b>Power On Trigger</b> is set to <b>Plug-in Detection</b></li> <li>• <b>Auto Power On</b> is set to <b>Off</b> in the projector's Network menu, or</li> <li>• <b>USB Power</b> is set to <b>On While Projecting</b>.</li> </ul>
<b>Port</b>	<b>Wired LAN</b> <b>Wireless LAN</b>	Selects the port to use while the <b>Standby Mode</b> setting is set to <b>Communication On</b>
<b>Startup Source</b>	Various input sources available	Selects the source displayed on startup in Content Playback mode

Setting	Options	Description
<b>Quick Startup</b>	<b>Off</b> <b>20min.</b> <b>60min.</b> <b>90min.</b>	<p>Sets the time period for which you want to be able to restart the projector within five seconds of turning it off (Quick Start mode).</p> <p>It may take longer than five seconds when projecting from the projector's USB port or when using the Screen Mirroring features.</p> <p>This setting is only displayed when:</p> <ul style="list-style-type: none"> <li>• <b>A/V Output</b> is set to <b>While Projecting</b> in the projector's Signal I/O menu</li> <li>• <b>Auto Power On</b> is set to <b>HDMI1</b> and <b>Power On Trigger</b> is set to <b>Plug-in Detection</b> in the projector's Operation menu, or</li> <li>• <b>Auto Power On</b> is set to <b>Off</b> in the projector's Network menu</li> </ul>
<b>Closed Caption</b>	<b>CC1</b> <b>CC2</b> <b>Off</b>	<p>Selects the type of closed captioning to display (availability varies by country)</p>
<b>Indicators</b>	<b>On</b> <b>Off</b>	<p>Enables or disables the status indicator lights on the projector</p>
<b>Content Playback</b>	<b>On</b> <b>Off</b>	<p>Enable to play back a playlist created in the Epson Projector Content Manager software</p>

Setting	Options	Description
<b>Overlay Effect</b>	<b>Overlay Effect</b> <b>Shape Filter</b> <b>Color Filter</b> <b>Lightness</b>	Adds color and shape effects to the projected image; not available when <b>Edge Blending</b> is enabled
<b>USB Viewer</b>	—	Select a playlist from the USB device
<b>Reset Operation Settings</b>	—	Reset all settings on the Operation menu to their default values

Parent topic: [Adjusting the Menu Settings](#)

## Administration Settings - Management Menu

Settings on the Management menu let you customize various projector administrative features.

Frequently Used Items	Management	
Image	User Button	Light Source Mode
Signal I/O	User's Logo	
Installation	User Pattern	
Display	Control Panel Lock	Off
Operation	Color Uniformity	
<b>Management</b>	Refresh Mode	
Network	Light Source Calibration	
Multi-Projection	Date & Time	
ECO	Schedule Settings	
Initial/All Settings	Wireless LAN Power	
	Wireless LAN Diagnosis	1
	Log Save Destination	USB and Internal Memory
	Batch Setup Range	
	Language 	English
	Information	
	Display Logs	
	Reset Management Settings	
	Network	

**Note:** You must disable Schedule password protection to adjust the **Schedule Settings** settings.

Setting	Options	Description
<b>User Button</b>	<b>Light Source Mode</b> <b>Information</b> <b>Deinterlacing</b> <b>Closed Caption</b> <b>Resolution</b> <b>Mic Input Level</b> <b>Pattern Display</b> <b>Display LAN Info.</b> <b>Content Playback</b> <b>Spotlight</b>	Assigns a menu option to the <b>User</b> button on the remote control for one-touch access
<b>User's Logo</b>	<b>Start Setting</b> <b>Reset</b>	Creates the screen that the projector displays to identify itself and enhance security
<b>User Pattern</b>	—	Captures a projected screen and saves it as a pattern for display; select <b>Pattern Display</b> in the Display menu to display the saved pattern
<b>Control Panel Lock</b>	<b>Full Lock</b> <b>Except for Power</b> <b>Off</b>	Controls projector button locking to secure the projector <b>Full Lock:</b> locks all buttons <b>Except for Power:</b> locks all buttons except the power button <b>Off:</b> no buttons locked



Setting	Options	Description
<b>Color Uniformity</b>	<b>Color Uniformity</b> <b>Adjustment Level</b> <b>Start Adjustments</b> <b>Reset</b>	Adjusts the color tone balance <b>Color Uniformity:</b> set to <b>On</b> to adjust the color tone balance for the whole screen <b>Adjustment Level:</b> sets the adjustment level <b>Start Adjustments:</b> adjusts the red, green, and blue color tones individually for the selected area <b>Reset:</b> resets all Color Uniformity adjustment values to their defaults
<b>Refresh Mode</b>	<b>Timer</b> <b>Messages</b> <b>Start</b>	Select <b>Start</b> to clear an afterimage that remains in the projected image and turn off the projector after the time specified in the <b>Timer</b> screen. Press any button to cancel Refresh Mode. Enable the <b>Messages</b> setting if you want to display a message when Refresh Mode is in progress.

Setting	Options	Description
<b>Light Source Calibration</b> (EB-L210SF)	<b>Run Now</b> <b>Run Periodically</b> <b>Last Run</b>	Selects options to perform light source calibration to maintain the color balance of the projected image  <b>Run Now:</b> Select <b>On</b> to start light source calibration now. Make sure the projector has been turned on for at least 30 minutes for maximum accuracy. You may not be able to start calibration if the projector's environmental temperature is out of range.  <b>Run Periodically:</b> Select <b>On</b> to perform calibration every 100 hours of usage  <b>Last Run:</b> Displays the date and time light source calibration was last performed
<b>Date &amp; Time</b>	<b>Date &amp; Time</b> <b>Daylight Saving Time</b> <b>Internet Time</b>	Adjusts the projector's date and time settings  <ul style="list-style-type: none"> <li>• <b>Date &amp; Time:</b> sets the date and time on the projector</li> <li>• <b>Daylight Saving Time:</b> enables daylight saving time</li> <li>• <b>Internet Time:</b> updates the time automatically via an online time server</li> </ul>
<b>Schedule Settings</b>	—	Schedules projector events to occur automatically at selected dates and times
<b>Wireless LAN Power</b>	<b>On</b> <b>Off</b>	Enables or disables wireless communication

Setting	Options	Description
<b>Wireless LAN Diagnosis</b>	<b>Ping</b> <b>IP Address</b> <b>Ping until stopped</b> <b>Start</b>	Displays the status of the wireless LAN communication
<b>Log Save Destination</b>	<b>Internal Memory</b> <b>USB and Internal Memory</b>	Selects where you want to save projector error and operation log files; not available in Content Playback mode
<b>Batch Setup Range</b>	<b>All</b> <b>Limited</b>	Selects which projector menu settings to copy using the batch setup feature; select <b>All</b> to copy all the settings, or select <b>Limited</b> to copy all settings except for the following: <ul style="list-style-type: none"> <li>• <b>Password Protection</b> settings</li> <li>• <b>EDID</b> setting in the Signal I/O menu</li> <li>• <b>Network</b> menu settings</li> </ul>
<b>Language</b>	Various languages available	Selects the language for projector menu and message displays

Setting	Options	Description
Information	<b>Operation Hours</b> <b>Light Source Hours</b> <b>Source</b> <b>Input Signal</b> <b>Resolution</b> <b>Refresh Rate</b> <b>Sync Info</b> <b>Video Signal</b> <b>Status</b> <b>Serial Number</b> <b>Event ID</b> <b>Version</b>	<p>Displays information about the projector and current input signal; the displayed items vary depending on the current input source</p> <p>The <b>Version</b> option displays version numbers for the projector and other components</p>
Display Logs	<b>Temp Warning Info</b> <b>Power On/Off History</b>	Displays log data saved to the location specified in the <b>Log Save Destination</b> setting
Reset Management Settings	—	<p>Resets all settings on the Management menu to their default values except for the following:</p> <ul style="list-style-type: none"> <li>• <b>User Pattern</b></li> <li>• <b>Language</b></li> </ul>

[Event ID Code List](#)

Parent topic: [Adjusting the Menu Settings](#)

## Event ID Code List

If the **Event ID** option on the Information screen in the Management menu displays a code number, check this list of Event ID codes for the solution to the projector problem associated with the code.

Event ID code	Cause and solution
0026	A screen mirroring communication error has occurred. Turn the projector off and on again, or restart the network software.
0032	
0036	
0037	
0027	Unstable screen mirroring communication. Check the network communication status, wait a few moments, and try connecting to the network again.
0028	
0029	
0030	
0031	
0035	
0023	Connection failed. If you see the PIN entry screen on your computer, enter the PIN code displayed on the network information screen or at the bottom right of the projected image. If this does not solve the problem, restart the projector and the connected devices, and then check the connection settings.
0024	
0025	
0043	The video format is not supported. Change the resolution of the mobile device and reconnect. Alternatively, change the <b>Adjust Image Quality</b> setting for the projector and reconnect.
0432	The network software did not start. Turn the projector off and then on again.
0435	
0433	Cannot display the transferred images. Restart the network software.
0434	Unstable network communication. Check the network communication status, wait a few moments, and try connecting to the network again.
0481	
0482	
0485	
0483	The network software quit unexpectedly. Check the network communication status, then turn the projector off and then on again.
04FE	
0484	Communication with computer was disconnected. Restart the network software.

Event ID code	Cause and solution
0479	A projector system error has occurred. Turn the projector off and then on again.
04FF	
0891	Cannot find the SSID (network name). Make sure your computer and projector are connected to your access point's current SSID.
0892	The WPA/WPA2/WPA3 authentication type does not match. Make sure the wireless network security settings are correct.
0893	The TKIP/AES encryption type does not match. Make sure the wireless network security settings are correct.
0894	Communication with unauthorized access point was disconnected. Contact your network administrator.
0895	Communication with a connected device was disconnected. Check your device's connection status.
0898	Failed to acquire DHCP address. Make sure the DHCP server is operating correctly. If you are not using DHCP, turn off the <b>DHCP</b> setting in the Network menus.
0899	A communication error has occurred. Try restarting the network software and restarting your projector. If that does not solve the problem, contact Epson for help.
089A	The EAP authentication type does not match the network. Check the wireless LAN security settings and make sure that the security certificate is installed correctly.
089B	EAP server authentication failed. Check the wireless LAN security settings and make sure that the security certificate is installed correctly.
089C	EAP client authentication failed. Check the wireless LAN security settings and make sure that the security certificate is installed correctly.
089D	Key exchange failed. Check the wireless LAN security settings and make sure that the security certificate is installed correctly.
0920	The internal battery that saves the projector's date and time settings is running low. Contact Epson for help.

Parent topic: [Administration Settings - Management Menu](#)

## Network Settings - Network Menu

Settings on the Network menu let you view network information and set up the projector for control over a network.

Frequently Used Items	Network	
Image	Wireless LAN Info.	
Signal I/O	Wired LAN Info.	
Installation	Art-Net Channel Information	
Display	Network Settings	
Operation	Transmitter Settings	
Management	Reset Network Settings	
Network	Multi-Projection	
Multi-Projection	Projector ID	Off
ECO	Tiling	
Initial/All Settings	Geometry Correction	Point Correction
	Edge Blending	
	Scale	
	Color Uniformity	
	Light Source Mode	Normal
	Color Matching	
	RGBCMY	
	Reset Multi-Projection Settings	

**Note:** You must disable Network password protection to adjust the network settings.

Setting	Options	Description
<b>Wireless LAN Info.</b>	—	<p>Displays wireless network status and details</p> <p>The <b>Wireless LAN</b> option displays the following:</p> <ul style="list-style-type: none"> <li>• <b>Projector Name</b></li> <li>• <b>Antenna level</b></li> <li>• <b>SSID</b></li> <li>• <b>Channel</b></li> <li>• <b>DHCP</b></li> <li>• <b>IP Address</b></li> <li>• <b>Subnet Mask</b></li> <li>• <b>Gateway Address</b></li> <li>• <b>DNS Server 1</b></li> <li>• <b>DNS Server 2</b></li> <li>• <b>MAC Address</b></li> <li>• <b>Region Code</b></li> <li>• <b>IPv6 Address</b></li> </ul>
<b>Wired LAN Info.</b>	—	<p>Displays wired network status and details</p> <p>The <b>Wired LAN</b> option displays the following:</p> <ul style="list-style-type: none"> <li>• <b>Projector Name</b></li> <li>• <b>DHCP</b></li> <li>• <b>IP Address</b></li> <li>• <b>Subnet Mask</b></li> <li>• <b>Gateway Address</b></li> <li>• <b>MAC Address</b></li> <li>• <b>IPv6 Address</b></li> </ul>



Setting	Options	Description
<b>Art-Net Channel Information</b>	—	Displays features and settings assigned to the Art-Net channels
<b>Network Settings</b>	—	Configures your network settings
<b>Transmitter Settings</b>	<b>Start Pairing</b> <b>Auto Power On</b> <b>Connection Guide Display</b>	<p><b>Start Pairing:</b> Updates the network information of the wireless transmitter from your computer using the Epson Wireless Transmitter Settings software when the wireless LAN module is installed and <b>Simple AP</b> is set to <b>On</b></p> <p><b>Auto Power On:</b> Set to <b>On</b> to turn on the projector automatically. This setting is only displayed when <b>A/V Output</b> is set to <b>While Projecting</b> in the projector's Signal I/O menu, <b>Power On Trigger</b> is set to <b>Plug-in Detection</b> in the projector's Operation menu, and <b>Auto Power On</b> is set to <b>Off</b> in the projector's Network menu.</p> <p><b>Connection Guide Display:</b> Set to <b>On</b> to automatically display the connection guide for the wireless transmitter (Epson Wireless Presentation) instead of the Home screen when there is no input signal when you turn on the projector ; not available in Content Playback mode</p>
<b>Reset Network Settings</b>	—	Resets all settings on the Network menu to their default values

Parent topic: [Adjusting the Menu Settings](#)

## Multiple Projector Operation Settings - Multi-Projection Menu

Settings on the Multi-Projection menu let you set up multiple projectors to project a single unified image (EB-L210SF).

Frequently Used Items	Multi-Projection
Image	Projector ID Off
Signal I/O	Tiling
Installation	Geometry Correction Point Correction
Display	Edge Blending
Operation	Scale
Management	Color Uniformity
Network	Light Source Mode Normal
Multi-Projection	Color Matching
ECO	RGBCMY
Initial/All Settings	Reset Multi-Projection Settings
	ECO
	Light Source Mode Normal
	Sleep Mode On ^
	Sleep Mode Timer 10 min.
	A/V Mute Timer On
	Standby Mode Communication On
	Initial/All Settings

Setting	Options	Description
<b>Projector ID</b>	<b>Off</b> 1 through 9	Assigns an ID for the projector when you use multiple projectors
<b>Tiling</b>	<b>Layout</b> <b>Location Setup</b>	Sets the number of split screens and the position of each image

Setting	Options	Description
<b>Geometry Correction</b>	<b>H/V-Keystone</b> <b>Quick Corner</b> <b>Arc Correction</b> <b>Point Correction</b>	Adjusts image shape to rectangular (horizontally and vertically) <b>H/V Keystone:</b> lets you manually correct horizontal and vertical sides <b>Quick Corner:</b> select to correct image shape and alignment using an on-screen display <b>Arc Correction:</b> select to adjust the curve or arc of the horizontal and vertical sides <b>Point Correction:</b> select to divide the projected image into a grid and correct distortion by moving a selected point
<b>Edge Blending</b>	<b>Edge Blending</b> <b>Top Edge</b> <b>Bottom Edge</b> <b>Left Edge</b> <b>Right Edge</b> <b>Line Guide</b> <b>Pattern Guide</b> <b>Guide Color</b>	Blends the border between multiple images to create a seamless screen
<b>Black Level</b>	<b>Color Adjustment</b> <b>Area Correction</b> <b>Reset</b>	Adjusts the brightness and tone differences in overlapping images
<b>Scale</b>	Varying levels available	When using multiple projectors, adjusts the scale of the image displayed by each projector

Setting	Options	Description
<b>Color Uniformity</b>	<b>Color Uniformity</b> <b>Adjustment Level</b> <b>Start Adjustments</b> <b>Reset</b>	Adjusts the color tone balance <b>Color Uniformity:</b> set to <b>On</b> to adjust the color tone balance for the whole screen <b>Adjustment Level:</b> sets the adjustment level <b>Start Adjustments:</b> adjusts the red, green, and blue color tones individually for the selected area <b>Reset:</b> resets all Color Uniformity adjustment values to their defaults
<b>Light Source Mode</b>	<b>Normal</b> <b>Quiet</b> <b>Extended</b> <b>Custom</b>	Selects the brightness mode of the projector when the <b>Maintain Brightness</b> setting (EB-L210SF) is disabled <b>Normal:</b> maximum brightness <b>Quiet:</b> 70% brightness with reduced fan noise <b>Extended:</b> 70% brightness and extends the life expectancy of the light source <b>Custom:</b> select a custom brightness level and enable use of the next setting
<b>Color Matching</b>	<b>Adjustment Level</b> <b>Red</b> <b>Green</b> <b>Blue</b> <b>Brightness</b>	Corrects the tint and brightness differences between images
<b>RGBCMY</b>	Varying levels available	Adjusts the hue, saturation, and brightness for each color

Setting	Options	Description
<b>Reset Multi-Projection Settings</b>	—	Resets all settings on the Multi-Projection menu to their default values

Parent topic: [Adjusting the Menu Settings](#)

## Setup Settings - ECO Menu

Settings on the ECO menu let you customize projector functions to save power.

Frequently Used Items	Projector ID	Off
Image	Geometry Correction	Point Correction
Signal I/O	Edge Blending	
Installation	Scale	
Display	Color Uniformity	
Operation	Light Source Mode	Normal
Management	Color Matching	
Network	RGBCMY	
Multi-Projection	Reset Multi-Projection Settings	
ECO	ECO	
Initial/All Settings	Light Source Mode	Normal
	Sleep Mode	On
	Sleep Mode Timer	10 min.
	AV Mute Timer	On
	Standby Mode	Communication On
Initial/All Settings	Reset All	
	Firmware Update	

Setting	Options	Description
<b>Light Source Mode</b>	<b>Normal</b> <b>Quiet</b> <b>Extended</b> <b>Custom</b>	Selects the brightness mode of the projector; only displayed when the <b>Maintain Brightness</b> setting is disabled (EB-L210SF) <b>Normal:</b> maximum brightness <b>Quiet:</b> 70% brightness with reduced fan noise <b>Extended:</b> 70% brightness and extends the life expectancy of the light source <b>Custom:</b> select a custom brightness level and enable use of the next setting
<b>Sleep Mode</b>	<b>On</b> <b>Off</b>	Automatically turns off the projector after an interval of inactivity
<b>Sleep Mode Timer</b>	1 to 30 minutes	Sets the interval for Sleep Mode
<b>A/V Mute Timer</b>	<b>On</b> <b>Off</b>	Automatically turns off the projector after 30 minutes if <b>A/V Mute</b> is enabled

Setting	Options	Description
<b>Standby Mode</b>	<b>Communication On</b> <b>Communication Off</b>	<p>Enable this setting to allow monitoring and control of the projector over a network when the projector is in standby mode; this setting is only displayed in the following cases:</p> <ul style="list-style-type: none"> <li>• <b>Auto Power On</b> is disabled in the projector's Network menu</li> <li>• <b>Auto Power On</b> is not set to <b>HDMI1</b> and <b>Power On Trigger</b> is set to <b>Plug-in Detection</b></li> <li>• <b>A/V Output</b> is set to <b>While Projecting</b> in the Signal I/O menu</li> <li>• <b>USB Power</b> is set to <b>On While Projecting</b></li> </ul>

Parent topic: [Adjusting the Menu Settings](#)

## Initial Settings and Reset Options - Initial/All Settings Menu

You can reset most of the projector settings to their default values using the **Reset All** option on the Initial/All Settings menu.



When you select the **Reset All** option, you see a screen like this:

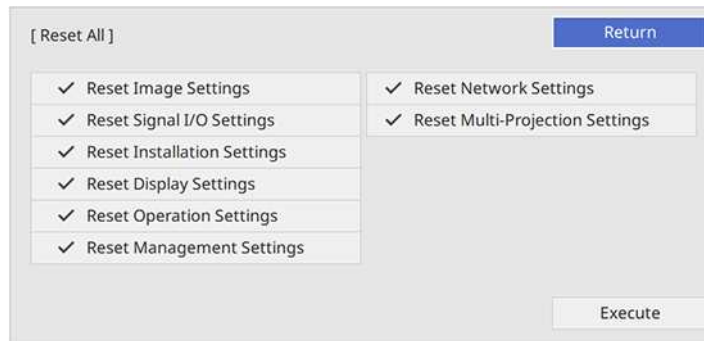



Checkmarks appear next to the menu settings that are selected to be reset. If you do not want to reset settings in some menus, deselect them. When you are ready, select **Execute** and press **↵ Enter**.

**Note:** All of the passwords for settings in the Network menu will be reset. To prevent unauthorized users from resetting these passwords, enable **Menu Protection** for the Network menu.

You cannot reset the following settings using the **Reset All** option:

- Digital Zoom
- Image Shift
- User Pattern
- Language

**Note:** See the link below for details on updating the projector's firmware.

**Parent topic:** [Adjusting the Menu Settings](#)

---

# Maintaining and Transporting the Projector

Follow the instructions in these sections to maintain your projector and transport it from place to place.

[Projector Maintenance](#)

[Air Filter and Vent Maintenance](#)

[Replacing the Remote Control Batteries](#)

[Updating the Firmware](#)

[Transporting the Projector](#)

## Projector Maintenance

Your projector needs little maintenance to keep working at its best.

You may need to clean the lens periodically, and clean the air filter and air vents to prevent the projector from overheating due to blocked ventilation.

The only parts you should replace are the air filter and remote control batteries. If any other part needs replacing, contact Epson or an authorized Epson servicer.

This projector uses a sealed laser light source which does not need servicing and cannot be replaced.

**Warning:** Before cleaning any part of the projector, turn it off, unplug the power cord, and let it cool down. Never open any cover on the projector, except as specifically explained in this manual. Dangerous electrical voltages in the projector can injure you severely.

**Warning:** Do not try to service this product yourself, except as specifically explained in this manual. Refer all other servicing to Epson qualified servicers.

[Cleaning the Lens](#)

[Cleaning the Projector Case](#)

**Parent topic:** [Maintaining and Transporting the Projector](#)

## Cleaning the Lens

Clean the projector's lens periodically, or whenever you notice dust or smudges on the surface. Make sure you turn off the projector and unplug the power cord before cleaning the lens.

**Note:** If the lens is dusty, first blow off the dust and then wipe the lens.

- To remove dust or smudges, gently wipe the lens with clean and dry lens-cleaning paper.
- To remove stubborn smudges, moisten a soft, lint-free cloth with lens cleaner and gently wipe the lens. Do not spray any liquid directly on the lens.

**Warning:** Do not use a lens cleaner that contains flammable gas. The high heat generated by the projector may cause a fire.

**Caution:** Do not wipe the lens immediately after turning off the projector; otherwise, the lens could be damaged. Do not use glass cleaner or any harsh materials to clean the lens and do not subject the lens to any impacts; you may damage it. Do not use canned air, or the gases may leave a residue. Avoid touching the lens with your bare hands to prevent fingerprints on or damage to the lens surface.

**Parent topic:** [Projector Maintenance](#)

## Cleaning the Projector Case

Before cleaning the projector case, turn off the projector and unplug the power cord.

- To remove dust or dirt, use a soft, dry, lint-free cloth.
- To remove stubborn dirt, use a soft cloth moistened with water and mild soap. Do not spray liquid directly on the projector.

**Caution:** Do not use wax, alcohol, benzine, paint thinner, or other chemicals to clean the projector case. These can damage the case. Do not use canned air, or the gases may leave a flammable residue.

**Parent topic:** [Projector Maintenance](#)

## Air Filter and Vent Maintenance

Regular filter maintenance is important to maintaining your projector. Your Epson projector is designed with an easily accessible, user-replaceable filter to protect your projector and make regular maintenance simple. Filter maintenance intervals will depend on the environment.

If regular maintenance is not performed, your Epson projector will notify you when the temperature inside the projector has reached a high level. Do not wait until this warning appears to maintain your projector filter as prolonged exposure to high temperatures may reduce the life of your projector or laser.

Damage due to the failure to properly maintain the projector or its filter may not be covered by the projector's Limited Warranty.

[Cleaning the Air Filter and Vents](#)

## Replacing the Air Filter

**Parent topic:** [Maintaining and Transporting the Projector](#)

### Cleaning the Air Filter and Vents

Clean the projector's air filter or vents if they get dusty, or if you see a message telling you to clean them.

**Note:** It is recommended that you clean these parts over a 20000-hour period. Clean them more often than this if you use the projector in a environment that is dustier than expected.

**Caution:** If you do not perform regular maintenance, the projector will display a high temperature warning. Do not wait until this message appears to clean your air filter and vents, as prolonged exposure to high temperatures can reduce the life of your projector.

1. Turn off the projector and unplug the power cord.
2. Gently remove the dust using a small vacuum designed for computers or a very soft brush (such as a paintbrush).

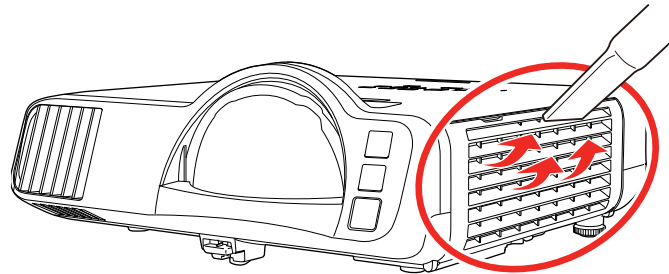

**Note:** You can remove the air filter so you can clean both sides of it. Do not rinse the air filter in water or use any detergent or solvent to clean it.

**Caution:** Do not use canned air. The gases may leave a flammable residue or push dust and debris into the projector's optics or other sensitive areas.

3. If dust is difficult to remove or the air filter is damaged, replace the air filter.

**Parent topic:** [Air Filter and Vent Maintenance](#)

## Replacing the Air Filter

You need to replace the air filter in the following situations:

- After cleaning the air filter, you see a message telling you to clean or replace it
- The air filter is torn or damaged

You can replace the air filter while the projector is mounted to the ceiling or placed on a table.

1. Turn off the projector and unplug the power cord.
2. Open the air filter cover.

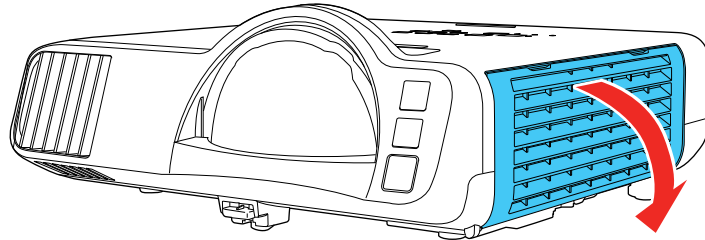

3. Pull the air filter out of the projector.

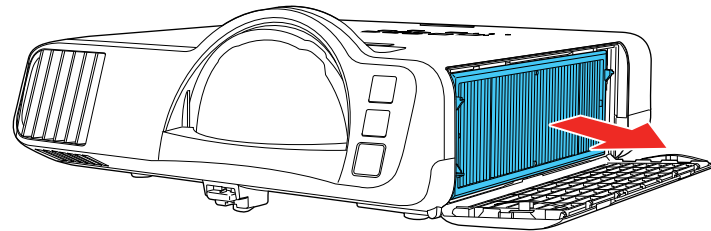

**Note:** Air filters contain polypropylene. Dispose of used air filters according to local regulations.

4. Place the new air filter in the projector as shown.

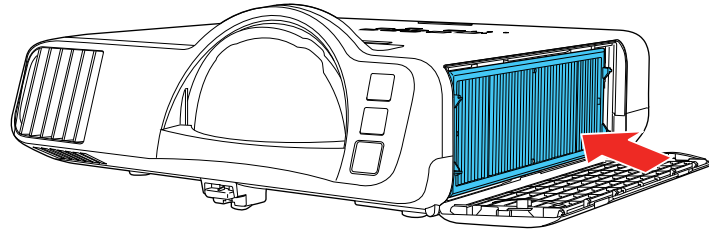

5. Close the air filter cover.

Parent topic: [Air Filter and Vent Maintenance](#)

## Replacing the Remote Control Batteries

The remote control uses two AA manganese or alkaline batteries. Replace the batteries as soon as they run out.

**Caution:** Use only the type of batteries specified in this manual. Do not install batteries of different types, or mix new and old batteries.

1. Remove the battery cover as shown.

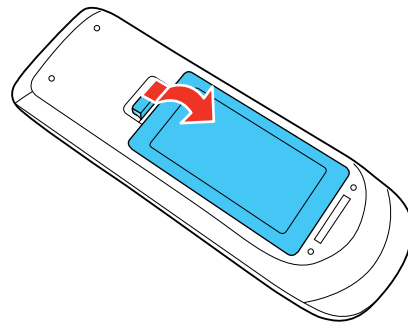

2. Remove the old batteries.

**Warning:** If the battery fluid has leaked, wipe it away with a soft cloth and avoid getting the fluid on your hands. If it gets on your hands, wash them immediately to avoid injury.

3. Insert the batteries with the + and – ends facing as shown.

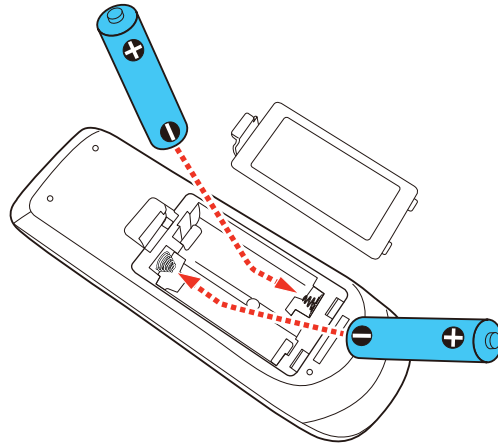

**Warning:** Make sure the batteries are inserted in the correct positions. If the batteries are not inserted correctly, they could explode or leak, causing a fire, injury, or damage to the product.

4. Replace the battery cover and press it down until it clicks into place.

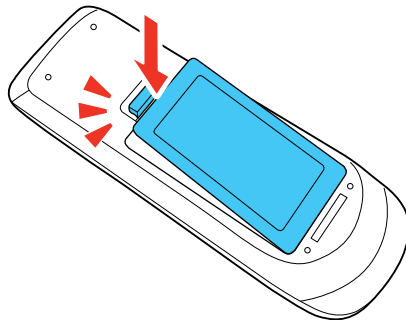

**Warning:** Dispose of used batteries according to local regulations. Do not expose batteries to heat or flame. Keep batteries out of the reach of children; they are choking hazards and are very dangerous if swallowed.

**Parent topic:** [Maintaining and Transporting the Projector](#)

## Updating the Firmware

You can update the projector's firmware using a USB storage device or a computer and a USB cable.

**Note:** Your computer must be running one of the following operating systems to update the firmware:

- Windows 8.x or later
- macOS 10.13.x or later

If a firmware update is available for your product, you can select the **Firmware Update** option in the projector's Initial/All Settings menu. The projector enters firmware update mode and is ready to perform a firmware update. If a firmware update file is not found, the projector enters standby mode.

If your projector is on a network, you can use the Epson Projector Management software to check for and update your product's firmware.

You can also contact Epson Support to check for firmware updates for your product. For more information, contact Epson Support.

**Parent topic:** [Maintaining and Transporting the Projector](#)

## Transporting the Projector

The projector contains precision parts, some of which are glass. Follow these guidelines to transport, ship, or store the projector safely:

- Make sure the projector is turned off, the power indicator is blue (but not flashing), and the status indicator is off, then unplug the power cord.
- Close the lens cover to protect the lens.
- Remove any equipment connected to the projector.
- Use a carrying case to hand-carry the projector.
- When transporting the projector a long distance or as checked luggage, place it in a carrying case. Then pack the case in a firm box with cushioning around it and mark the box "Fragile."
- When shipping the projector for repairs, place it in its original packing materials, if possible, or use equivalent materials with cushioning around the projector. Mark the box "Fragile."



**Note:** Epson shall not be liable for any damages incurred during transportation.

**Parent topic:** [Maintaining and Transporting the Projector](#)

---

# Solving Problems

Check the solutions in these sections if you have any problems using the projector.

[Projection Problem Tips](#)

[Projector Light Status](#)

[Using the Projector Menu Displays](#)

[Solving Image or Sound Problems](#)

[Solving Projector or Remote Control Operation Problems](#)

[Solving Network Problems](#)

[Solutions to HDMI Link Problems](#)

[Where to Get Help \(U.S. and Canada\)](#)

[Where to Get Help \(Latin America\)](#)

## Projection Problem Tips

If the projector is not working properly, try turning it off and unplugging it. Then plug it back in and turn it on.

If this does not solve the problem, check the following:

- The lights on the projector may indicate what the problem is.
- The solutions in this manual can help you solve many problems.

If none of these solutions help, you can contact Epson for technical support.

**Parent topic:** [Solving Problems](#)

## Projector Light Status

The lights on the projector indicate the projector status and let you know when a problem occurs. Check the status and color of the lights and look for a solution in the table here.

**Note:** If the **Indicators** setting in the Operation menu is **Off**, all lights are off under normal projection conditions.

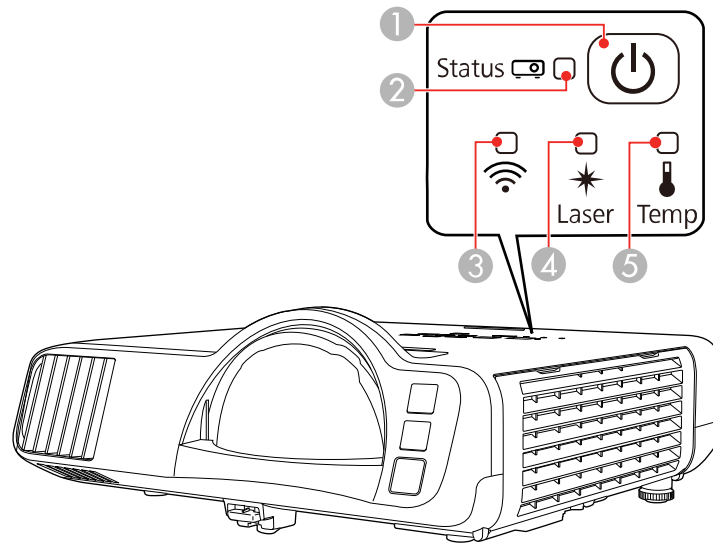

- 1 Power light
- 2 Status light
- 3 Wireless LAN light
- 4 Laser light
- 5 Temp (temperature) light

Power light	Status light	Laser light	Temp light	Status and solution
Blue	Blue	Off	Off	Normal operation.
Blue	Flashing blue	Off	Off	Warming up. Wait for an image to appear.
				Shutting down. (When the Status light stops flashing, you can unplug the projector.)

Power light	Status light	Laser light	Temp light	Status and solution
Blue	Off	Off	Off	In standby, sleep mode, or monitoring.
Flashing blue	Off	Off	Off	Preparing for monitoring or quick startup mode; all features are disabled.
Flashing blue	Varies	Varies	Flashing orange	Projector is too hot. <ul style="list-style-type: none"> <li>• Make sure that the vents and air filter are not clogged with dust or obstructed by nearby objects.</li> <li>• Clean or replace the air filter.</li> <li>• Make sure the environmental temperature is not too hot.</li> </ul>
Off	Flashing blue	Off	Orange	Projector has overheated and turned off. Leave it turned off to cool down. After about five minutes, do the following: <ul style="list-style-type: none"> <li>• Make sure that the vents and air filter are not clogged with dust or obstructed by nearby objects.</li> <li>• Make sure the environmental temperature is not too hot.</li> <li>• Clean or replace the air filter.</li> <li>• If operating the projector at high altitude, turn on <b>High Altitude Mode</b>.</li> <li>• If the problem persists, unplug the projector and contact Epson for help.</li> </ul>
Flashing blue	Varies	Flashing orange	Varies	Laser warning. Turn the projector off, unplug it, and contact Epson for help.
Off	Flashing blue	Orange	Off	Laser has a problem. Turn the projector off, unplug it, and contact Epson for help.

Power light	Status light	Laser light	Temp light	Status and solution
Off	Flashing blue	Off	Flashing orange	A fan or sensor has a problem. Turn the projector off, unplug it, and contact Epson for help.
Off	Flashing blue	Flashing orange	Off	Internal projector error. Turn the projector off, unplug it, and contact Epson for help.
Varies	Flashing blue	Flashing orange	Varies	Refresh Mode is in progress.

### Wireless LAN Light Status

The Wireless LAN light indicates the following:

- **Blue:** Wireless LAN connection is available and operating normally.
- **Flashing blue (quickly):** Connecting to a device.
- **Flashing blue (slowly):** An error has occurred. Turn off the projector and restart it.
- **Off:** Wireless LAN connection is not available. Make sure the **Wireless LAN Power** setting is set to **On** in the projector's Management menu.

**Note:** If the lights display a pattern not listed in the tables above, turn the projector off, unplug it, and contact Epson for help.

Parent topic: [Solving Problems](#)

## Using the Projector Menu Displays

The projector displays descriptions in the menu system to help you navigate the projector's settings. The descriptions appear on the right side of the screen as you scroll the menu settings.

Parent topic: [Solving Problems](#)

## Solving Image or Sound Problems

Check the solutions in these sections if you have any problems with projected images or sound.

[Solutions When No Image Appears](#)

[Solutions When Image is Incorrect Using the USB Display Function](#)

[Solutions When "No Signal" Message Appears](#)

[Solutions When "Not Supported" Message Appears](#)  
[Solutions When Only a Partial Image Appears](#)  
[Solutions When the Image is Not Rectangular](#)  
[Solutions When the Image Contains Noise or Static](#)  
[Solutions When the Image is Fuzzy or Blurry](#)  
[Solutions When the Image Brightness or Colors are Incorrect](#)  
[Solutions When an Afterimage Remains On the Projected Image](#)  
[Solutions to Sound Problems](#)  
[Solutions to Microphone Problems](#)  
[Solutions to PC Free Problems](#)  
[Solutions to Problems Using Content Playback](#)  
**Parent topic:** [Solving Problems](#)

## Solutions When No Image Appears

If no image appears, try the following solutions:

- Press the **A/V Mute** button on the remote control or projector to see if the image was temporarily turned off.
- Make sure all necessary cables are securely connected and the power is on for the projector and connected video sources.
- If you connected your video source to the **Computer2/Monitor Out** port, make sure you set the **Monitor Out Port** setting to **Computer2**.
- Make sure the image being projected is not completely black (only when projecting computer images).
- Press the projector's power button to wake it from standby or sleep mode. Also see if your connected computer is in sleep mode or displaying a blank screen saver.
- Press the **Menu** button. If the projector menu displays, there may be a problem with the connected video source, cable connection, or port.
- Adjust the **Brightness** setting on the Image menu.
- Adjust the brightness of your projector's light source.
- Check the Display menu to make sure the **Messages** setting is set to **On**.
- If the projector does not respond when you press the control panel buttons, the buttons may be locked. Unlock the buttons. Press and hold the **Enter** button on the control panel for 7 seconds.

- If the projector does not respond when you press buttons on the remote control, make sure the remote receivers are turned on.
- For images projected with Windows Media Center, reduce the screen size from full screen mode.
- For images projected from applications using Windows DirectX, turn off DirectX functions.
- The projector may not be able to project copyrighted videos that you play back on a computer. For details, see the manual supplied with your computer.
- If the other solutions do not solve the problem, reset all of the projector settings using the options on the **Initial/All Settings** menu.

**Parent topic:** [Solving Image or Sound Problems](#)

## Solutions When Image is Incorrect Using the USB Display Function

If no image appears or if the image appears incorrectly using the USB Display function, try the following solutions:

- Press the **USB** button on the remote control.
- Disconnect and reconnect the USB cable.
- Make sure the USB Display software has installed correctly. Install it manually if necessary.
- Make sure your computer is connected to the **USB-B** port on the projector.
- On a Mac, select the **USB Display** icon in the Dock or from the **Applications** folder. If you select Exit from the USB Display icon menu in the Dock, USB Display does not start automatically when you connect the USB cable.
- If the mouse cursor flickers, select **Make the movement of the mouse pointer smooth** in the Epson USB Display Settings program on your computer.
- Turn off the **Transfer layered window** setting in the Epson USB Display Settings program on your computer.
- If you change the computer resolution during projection, the video quality and performance may decline.
- For images projected with Windows Media Center, reduce the screen size from full screen mode.
- For images projected from applications using Windows DirectX, turn off DirectX functions.
- Make sure you are using the most recent version of the USB Display software. You can download the latest version from the Epson web site. Go to [epson.com/support](http://epson.com/support) (U.S.), [epson.ca/support](http://epson.ca/support) (Canada), or [latin.epson.com/support](http://latin.epson.com/support) (Caribbean) and select your projector.

**Parent topic:** [Solving Image or Sound Problems](#)

## Solutions When "No Signal" Message Appears

If the "No Signal" message appears, try the following solutions:

- Press the **Source Search** button and wait a few seconds for an image to appear.
- Turn on the connected computer or video source, and press its play button to begin your presentation, if necessary.
- Check the connection from the projector to your video sources.
- If you are projecting from a laptop computer, make sure it is set up to display on an external monitor.
- If necessary, turn the projector and the connected computer or video source off and then on again.
- If you are projecting from an HDMI source, replace the HDMI cable with a shorter one.
- Connect the video source directly to the projector.
- Try a different video cable.
- If the other solutions do not solve the problem, reset all of the projector settings using the options on the **Initial/All Settings** menu.

[Displaying From a PC Laptop](#)

[Displaying From a Mac Laptop](#)

**Parent topic:** [Solving Image or Sound Problems](#)

### Displaying From a PC Laptop

If you see the "No Signal" message when you display from a PC laptop, you need to set up the laptop to display on an external monitor.

1. Hold down the laptop's **Fn** key and press the key labeled with a monitor icon or **CRT/LCD**. (See your laptop manual for details.) Wait a few seconds for an image to appear. To display on both the laptop's monitor and the projector, try pressing the same keys again.

**Note:** On Windows 7 or later, hold down the Windows key and press **P** at the same time, then click **Duplicate**.

2. If the same image is not displayed by the laptop and projector, check the Windows **Display** utility to make sure the external monitor port is enabled and extended desktop mode is disabled. (See your computer or Windows manual for instructions.)
3. If necessary, check your video card settings and set the multiple display option to **Clone**, **Mirror**, or **Duplicate**.

**Parent topic:** [Solutions When "No Signal" Message Appears](#)



## Displaying From a Mac Laptop

If you see the "No Signal" message when you display from a Mac laptop, you need to set up the laptop for mirrored display. (See your laptop manual for details.)

1. Open the **System Preferences** utility and select **Displays**, **Display**, or **Color LCD**.
2. Click the **Arrange** or **Arrangement** tab.
3. Select the **Mirror Displays** checkbox.

**Parent topic:** [Solutions When "No Signal" Message Appears](#)

## Solutions When "Not Supported" Message Appears

If the "Not Supported" message appears, try the following solutions:

- Make sure the correct input signal is selected on the Signal I/O menu.
- Make sure the computer's display resolution does not exceed the projector's resolution and frequency limit. If necessary, select a different display resolution for your computer. (See your computer manual for details.)
- If you are projecting from an HDMI source, change the **HDMI IN EQ Level** setting in the projector's Signal I/O menu. Follow the on-screen instructions. You may need to restart the projector.
- If you are projecting using a thumb-sized media streaming device, set the **HDMI EQ Setting** to **1** in the projector's Signal I/O menu.

**Parent topic:** [Solving Image or Sound Problems](#)

## Solutions When Only a Partial Image Appears

If only a partial computer image appears, try the following solutions:

- For VGA connections, press the **Auto** button on the remote control to optimize the image signal.
- Make sure you selected the correct **Screen Type** setting in the projector's Installation menu for the screen you are using. If there are margins between the edge of the image and the projected screen frame, use the **Screen Position** setting to adjust the position of the image.
- Make sure the **Scale** setting in the Image menu is turned off (EB-L210SF).
- Make sure the **Resolution** setting in the Image menu is set correctly for the input signal.
- Try adjusting the image position using the **Position** setting in the Image menu.
- Press the **Aspect** button on the remote control to select a different image aspect ratio.
- If you zoomed into or out of the image using the **E-Zoom** buttons, press the **Esc** button until the projector returns to a full display.

- Check your computer display settings to disable dual display and set the resolution within the projector's limits. (See your computer manual for details.)
- Check the resolution assigned to your presentation files to see if they are created for a different resolution than you are projecting in. (See your software help for details.)
- Make sure you selected the correct **Projection** setting in the Installation menu.
- If you are projecting in **Content Playback** mode, make sure you are using the correct **Overlay Effect** setting in the Operation > Content Playback menu.

**Parent topic:** [Solving Image or Sound Problems](#)

## Solutions When the Image is Not Rectangular

If the projected image is not evenly rectangular, try the following solutions:

- Place the projector directly in front of the center of the screen, facing it squarely, if possible.
- Turn on automatic keystone adjustments using the projector's menus.
- If you adjusted the projector height using the projector feet, press the keystone buttons on the projector to adjust the image shape.
- Adjust the position of the projector's horizontal keystone slider.
- Adjust the **Quick Corner** setting to correct the image shape.
- Adjust the **Arc Correction** setting to correct the image shape when projecting onto a curved surface.
- Adjust the **Point Correction** setting to correct any slight distortion.

**Parent topic:** [Solving Image or Sound Problems](#)

## Solutions When the Image Contains Noise or Static

If the projected image seems to contain electronic interference (noise) or static, try the following solutions:

- Check the cables connecting your computer or video source to the projector. They should be:
  - Separated from the power cord to prevent interference
  - Securely connected at both ends
  - Not connected to an extension cable
- Make sure you selected the correct **Signal Format** or **EDID** settings in the projector's Signal I/O menu, if available for your image source.

- Adjust the **Noise Reduction**, **MPEG Noise Reduction**, and **Deinterlacing** settings in the projector's Image menu.
- If available for your video source, select **Auto** as the **Resolution** setting in the Image menu.
- Select a computer video resolution and refresh rate that are compatible with the projector.
- If you are projecting from a computer using a VGA cable, press the **Auto** button on the remote control to automatically adjust the tracking and sync. If the problem remains, display a uniformly patterned image on the screen and manually adjust the **Tracking** and **Sync** settings.
- If you adjusted the image shape using the projector controls, try decreasing the **Sharpness** setting to improve image quality.
- If you connected an extension power cable, try projecting without it to see if it caused interference in the signal.
- If you are using the USB Display function, turn off the **Transfer layered window** setting in the Epson USB Display Settings program on your computer.

Parent topic: [Solving Image or Sound Problems](#)

## Solutions When the Image is Fuzzy or Blurry

If the projected image is fuzzy or blurry, try the following solutions:

- Adjust the image focus.
- Clean the projector lens.

**Note:** To avoid condensation on the lens after bringing the projector in from a cold environment, let the projector warm up to room temperature before using it.

- Position the projector close enough to the screen.
- Position the projector so the keystone adjustment angle is not so wide that it distorts the image.
- Adjust the **Sharpness** setting to improve image quality.
- If you are projecting from a computer, press the **Auto** button on the remote control to automatically adjust the tracking and sync. If any bands or overall blurriness remain, display a uniformly patterned image on the screen and manually adjust the **Tracking** and **Sync** settings.
- If you are projecting from a computer, try using a lower resolution or try to match the projector's native resolution.

Parent topic: [Solving Image or Sound Problems](#)

## Solutions When the Image Brightness or Colors are Incorrect

If the projected image is too dark or light, or the colors are incorrect, try the following solutions:

- Press the **Color Mode** button on the remote control to try different color modes for the image and environment.
- Check your video source settings.
- Adjust the available settings on the Image menu for the current input source, such as **Brightness**, **Contrast**, **Tint**, **Color Saturation**, and **RGBCMY**. RGBCMY should be set by a professional color calibrator using specialized color calibration tools in a controlled lighting environment.
- Make sure you selected the correct **Signal Format** or **EDID** setting in the Signal I/O menu, if available for your video source.
- Make sure all the cables are securely connected to the projector and your video device. If you connected long cables, try connecting shorter cables.
- Position the projector close enough to the screen.
- Make sure you have run the **Light Source Calibration** in the Management menu recently. If using multiple projectors, perform the calibration on all projectors to ensure a consistent image quality (EB-L210SF).

**Parent topic:** [Solving Image or Sound Problems](#)

## Solutions When an Afterimage Remains On the Projected Image

If you see an afterimage in the projected image, select **Refresh Mode > Start** in the Management menu.

**Parent topic:** [Solving Image or Sound Problems](#)

## Solutions to Sound Problems

If there is no sound when you expect it or the volume is too low or high, try the following solutions:

- Adjust the projector's volume settings.
- Check your computer or video source to make sure the volume is turned up and the audio output is set for the correct source.
- Try disconnecting and reconnecting the audio cable.
- Check the audio cable connections between the projector and your video source.
- If you do not hear sound from an HDMI source, set the connected device to PCM output.
- Make sure any connected audio cables are labeled "No Resistance."

- If you are using the USB Display function, turn on the **Output audio from the projector** setting in the Epson USB Display Settings program on your computer.
- If you are using a Mac and you do not hear sound from an HDMI source, make sure your Mac supports audio through the HDMI port. If not, you need to connect an audio cable.
- If you want to use a connected audio source when the projector isn't projecting any images, set the **Quick Startup** option in the Operation menu to **Off** and make sure the **A/V Output** setting in the Signal I/O menu is set to **Always On**.
- Make sure the **Audio Out Device** option is set to the correct audio port for your video device.
- If you turn the projector on immediately after turning it off, the cooling fans may run at high speed momentarily and cause an unexpected noise. This is normal.

**Parent topic:** [Solving Image or Sound Problems](#)

## Solutions to Microphone Problems

If there is no sound when you use a microphone connected to the projector, try the following solutions:

- Make sure the microphone is securely connected to the projector.
- Adjust the **Mic Input Level** setting in the Signal I/O menu. If the setting is too high, the sound of the other connected devices will be too low.

**Parent topic:** [Solving Image or Sound Problems](#)

## Solutions to PC Free Problems

If you are having problems with the PC Free feature on your projector, try the following solutions:

- If any file names are longer than the display area or include unsupported symbols, the displayed file names are shortened or changed in PC Free. To avoid this, shorten or change the file name on the USB drive.
- If you are using a USB device with a slow transfer speed, you may not be able to project movies correctly.
- You cannot play movies saved with a movie codec other than H.264 and H.265. (H.265 only supports Main Profile.)
- You cannot play audio saved with an audio codec other than LPCM and AAC-LC.

**Parent topic:** [Solving Image or Sound Problems](#)

## Solutions to Problems Using Content Playback

If you cannot play back a playlist correctly, try the following solutions:

- Check the following on all projectors:
  - All projectors are the same model. If any of the projectors are a different model or have a different resolution, synchronized playback may not be performed properly.
  - Make sure the name, date, and time settings are correct.
  - Make sure all projectors are connected to the same network.
  - Make sure the **Content Playback** setting is turned on in the Operation menu.
- Make sure your USB device contains a playlist.
- Make sure your USB device is connected directly to the projector and not through a USB hub or card reader.
- If the USB device is partitioned, you may not be able to play back playlists. Delete all of the partitions before saving the playlists on your USB device.
- Do not share a playlist between projectors that are different in resolution. Color and shape effects added by using the **Overlay Effect** setting may not be reproduced correctly.

**Parent topic:** [Solving Image or Sound Problems](#)

## Solving Projector or Remote Control Operation Problems

Check the solutions in these sections if you have problems operating the projector or remote control.

[Solutions to Projector Power or Shut-Off Problems](#)

[Solutions to Remote Control Problems](#)

[Solutions to Password Problems](#)

[Solutions When a Battery Message Appears](#)

**Parent topic:** [Solving Problems](#)

## Solutions to Projector Power or Shut-Off Problems

If the projector does not come on when you press the power button or it shuts off unexpectedly, try the following solutions:

- Make sure the power cord is securely connected to the projector and to a working electrical outlet.
- The projector's buttons may be locked for security. Unlock the buttons or use the remote control to turn on the projector.

- If the projector's laser shuts off unexpectedly, it may have entered standby mode after a period of inactivity. Press the power button to wake the projector and adjust the **Sleep Mode** setting to change the sleep interval.
- If the projector's light source turns off unexpectedly, the A/V mute timer may be enabled. Select **Off** as the **A/V Mute Timer** setting.
- If the power button on the remote control does not turn on the projector, check its batteries and make sure the **Remote Receiver** setting is turned on in the projector's menu, if available.
- The power cord may be defective. Try another power cord. If that doesn't work, disconnect the cord and contact Epson.
- The cooling fans may run in standby status depending on the projector settings. Also, when the projector wakes from standby status, the fans may cause an unexpected noise. This is not a malfunction.

**Parent topic:** [Solving Projector or Remote Control Operation Problems](#)

## Solutions to Remote Control Problems

If the projector does not respond to remote control commands, try the following solutions:

- Check that the remote control batteries are installed correctly and have power. If necessary, replace the batteries.
- Make sure you are operating the remote control within the reception angle and range of the projector.
- Make sure the projector is not warming up or shutting down.
- Check to see if a button on the remote control is stuck down, causing it to enter sleep mode. Release the button to wake the remote control up.
- Strong fluorescent lighting, direct sunlight, or infrared device signals may be interfering with the projector's remote receivers. Dim the lights or move the projector away from the sun or interfering equipment.
- If available, turn on one of the remote receivers in the projector's menu system, or check if all the remote receivers were turned off.
- If the remote receiver setting is off, press and hold the **Menu** button on the remote for at least 15 seconds to restore the default setting.
- If you assigned an ID number to the remote control to operate multiple projectors, you may need to check or change the ID setting.
- To set the remote control so it will operate any projector, hold down the **ID** button and press the **0/All** button.

- If you lose the remote control, you can purchase another from an Epson parts distributor.

**Parent topic:** [Solving Projector or Remote Control Operation Problems](#)

## Solutions to Password Problems

If you cannot enter or remember a password, try the following solutions:

- You may have turned on password protection without first setting a password. Try entering **0000** using the remote control. If you lose the remote control, you cannot enter a password. Order a new one from Epson.
- If you have entered an incorrect password too many times and see a message displaying a request code, write down the code and contact Epson. Do not attempt to enter the password again. Provide the request code and proof of ownership for assistance in unlocking the projector.
- If you set a Epson Web Control password and forgot the user ID or password, try entering the following:
  - User ID: **EPSONWEB**
  - Default password: **admin**
- If you set a Remote password (in Epson Web Control) and forgot the user ID or password, try entering the following:
  - User ID: **EPSONREMOTE**
  - Default password: **admin**

**Parent topic:** [Solving Projector or Remote Control Operation Problems](#)

## Solutions When a Battery Message Appears

If you see a message telling you that the battery that saves your clock settings is running low, contact Epson for help.

**Parent topic:** [Solving Projector or Remote Control Operation Problems](#)

## Solving Network Problems

Check the solutions in these sections if you have problems using the projector on a network.

[Solutions When Wireless Authentication Fails](#)

[Solutions When You Cannot Access the Projector Through the Web](#)

[Solutions When Network Alert E-Mails are Not Received](#)

[Solutions When the Image Contains Static During Network Projection](#)



[Solutions When You Cannot Connect Using Screen Mirroring](#)  
[Solutions When the Image or Sound Contains Static When Using Screen Mirroring](#)

**Parent topic:** [Solving Problems](#)

## Solutions When Wireless Authentication Fails

If you cannot authenticate a wireless connection, try the following solutions:

- If the wireless settings are correct, but authentication fails, you may need to update the **Date & Time** settings in the Management menu, if available.
- Check the **Security** settings and passphrase in the Network menu.
- Make sure the connected device is on and operating properly.
- If the access point security is WPA3-EAP, change the access point setting to **WPA2/WPA3-EAP**.

**Parent topic:** [Solving Network Problems](#)

## Solutions When You Cannot Access the Projector Through the Web

If you are unable to access the projector through a web browser, make sure you are using the correct ID and password, which are case sensitive.

**Note:** You cannot change the user ID.

- You may need to log in to access some options on the Web Control screen. If you see a log in window, enter **EPSONWEB** as the user ID and enter the password set in the projector's Network menu as the password. The default password is **admin**.
- Avoid connecting via a proxy server.
- Make sure you have access to the network the projector is on.
- Check the IP address on the projector, then reenter the IP address in the browser search bar.
- If you set the **Standby Mode** setting to **Communication On** in the projector's Operation menu, make sure the network device is turned on. After turning on the network device, turn on the projector.

**Note:** The user ID and password are case sensitive.

**Parent topic:** [Solving Network Problems](#)

## Solutions When Network Alert E-Mails are Not Received

If you do not receive an e-mail alerting you to problems with a projector over the network, try the following solutions:

- Make sure the projector is turned on and connected to the network correctly. (If an error shut down the projector, it cannot send an e-mail.)
- Make sure you set up the projector e-mail alert settings correctly on the projector's Network menu or in the network software.
- Set the **Standby Mode** setting to **Communication On** so the network software can monitor the projector in standby mode. Change the **Port** setting according to your network environment.

**Parent topic:** [Solving Network Problems](#)

## Solutions When the Image Contains Static During Network Projection

If the projected image contains static during network projection, try the following solutions:

- Check for any obstacles between the access point, the computer, the mobile device, and the projector. If necessary, change their positions to improve communication. Also make sure that they are not too far apart; move them closer together and try to connect again.
- If the wireless connection is slow or your projected image contains noise, check for interference from other equipment, such as a Bluetooth device or microwave. Move the interfering device farther away or expand your wireless bandwidth.
- If the connection speed declines, reduce the number of connected devices.

**Parent topic:** [Solving Network Problems](#)

## Solutions When You Cannot Connect Using Screen Mirroring

If you are unable to connect to the projector using Screen Mirroring, try the following solutions:

- Select **On** as the **Screen Mirroring** setting in the projector's Network menu.
- Select **On** as the **Simple AP** setting in the projector's Network menu.
- Select **Off** as the **Screen Mirroring** setting, then select **On** again.
- Make sure the mobile device settings are correct and restart the device.
- You may not be able to connect immediately after disconnecting from the projector. Wait a while and try connecting again.

- If you have previously connected to the projector using Screen Mirroring, the device may have saved the previous connection information. Delete the saved information and connect to the projector from the list of available devices.
- If you are unable to use two Screen Mirroring sources at the same time, set the **Interrupt Connection** setting to **Off**.

**Parent topic:** [Solving Network Problems](#)

## Solutions When the Image or Sound Contains Static When Using Screen Mirroring

If the projected image or sound contains static when connecting using Screen Mirroring, try the following solutions:

- Avoid covering the Wi-Fi antenna of the mobile device.
- If you use a Screen Mirroring connection and an internet connection at the same time, the image may freeze or contain noise. Disconnect from the internet to improve the connection speed of the mobile device.
- Make sure the projection contents meet the Screen Mirroring requirements.
- Depending on the settings of the mobile device, the connection may be lost when the device enters power saving mode. Check the power saving settings on the mobile device.
- Make sure your mobile device has the latest version of its wireless driver and firmware installed.

**Parent topic:** [Solving Network Problems](#)

## Solutions to HDMI Link Problems

If you cannot control an HDMI device using the HDMI Link feature, try the following solutions:

- Make sure all necessary cables are securely connected and the power is on for the projector and connected video sources.
- Make sure the cables meet the HDMI CEC standard.
- Make sure the connected device meets the HDMI CEC standard. See the documentation supplied with the device for more information.
- Check if the device is available in the **Device Connections** list in the Signal I/O menu. If the device does not appear, it does not meet the HDMI CEC standards. Connect a different device.
- Make sure the connected devices are turned on and in standby status. See the documentation supplied with the device for more information.
- If you connected a new device or changed any connections, make sure the CEC function is set for the connected device. You may need to restart the device.

- Connect no more than four devices that support HDMI Link or 3 devices that support HDMI CEC at the same time.
- If you have connected a speaker or receiver, set the output to PCM.

**Parent topic:** [Solving Problems](#)

## Where to Get Help (U.S. and Canada)

If you need to contact Epson for technical support services, use the following support options.

### Internet Support

Visit Epson's support website at [epson.com/support](http://epson.com/support) (U.S.) or [epson.ca/support](http://epson.ca/support) (Canada) and select your product for solutions to common problems with your projector. You can download utilities and documentation, get FAQs and troubleshooting advice, or e-mail Epson with your questions.

### Speak to a Support Representative

To use the Epson PrivateLine Support service, call (800) 637-7661. This service is available for the duration of your warranty period. You may also speak with a projector support specialist by dialing (562) 276-4394 (U.S.) or (905) 709-3839 (Canada).

Support hours are Monday through Friday, 7 a.m. to 4 p.m., Pacific Time.

Days and hours of support are subject to change without notice. Toll or long distance charges may apply.

Before you call, have the following information ready:

- Product name
- Product serial number (located on the bottom or rear of the projector, or in the menu system)
- Proof of purchase (such as a store receipt) and date of purchase
- Computer or video configuration
- Description of the problem

### Purchase Supplies and Accessories

You can purchase screens, other optional accessories, and replacement parts from an Epson authorized reseller. To find the nearest reseller, call 800-GO-EPSON (800-463-7766) in the U.S. or 800-807-7766 in Canada. Or you can purchase online at [epsonstore.com](http://epsonstore.com) (U.S. sales) or [epsonstore.ca](http://epsonstore.ca) (Canadian sales).

You can purchase a replacement remote control from an Epson parts distributor [here](#) (U.S. sales) or [here](#) (Canadian sales).

Parent topic: [Solving Problems](#)

## Where to Get Help (Latin America)

If you need to contact Epson for technical support services, use the following support options.

### Internet Support

Visit Epson's support website at [latin.epson.com/support](http://latin.epson.com/support) and select your product for solutions to common problems with your projector. You can download utilities and documentation, get FAQs and troubleshooting advice, or e-mail Epson with your questions.

### Speak to a Support Representative

Before you call for support, please have the following information ready:

- Product name
- Product serial number (located on the bottom or rear of the projector, or in menu system)
- Proof of purchase (such as a store receipt) and date of purchase
- Computer or video configuration
- Description of the problem

Then call:

Country	Telephone
Argentina	(54 11) 5167-0300 0800-288-37766
Bolivia*	800-100-116
Brazil	
Chile	(56 2) 2484-3400
Colombia	Bogota: (57 1) 602-4751 Other cities: 01-8000-915235
Costa Rica	800-377-6627
Dominican Republic*	1-888-760-0068
Ecuador*	1-800-000-044
El Salvador*	800-6570

Country	Telephone
Guatemala*	1-800-835-0358
Mexico	Mexico City: (52 55) 1323-2052 Other cities: 01-800-087-1080
Nicaragua*	00-1-800-226-0368
Panama*	00-800-052-1376
Paraguay	009-800-521-0019
Peru	Lima: (51 1) 418-0210 Other cities: 0800-10126
Uruguay	00040-5210067
Venezuela	(58 212) 240-1111

\*Contact your local phone company to call this toll-free number from a mobile phone.

**Note:** Toll or long distance charges may apply. If your country does not appear on the list, contact the sales office in the nearest country.

### **Purchase Supplies and Accessories**

You can purchase optional accessories and replacement parts from an Epson authorized reseller. To find the nearest reseller, go to [latin.epson.com](http://latin.epson.com). Or you can contact your nearest sales office as described in "Where to Get Help."

**Parent topic:** [Solving Problems](#)

---

# Technical Specifications

These sections list the technical specifications of your projector.

[General Projector Specifications](#)

[Projector Light Source Specifications](#)

[Remote Control Specifications](#)

[Projector Dimension Specifications](#)

[Projector Electrical Specifications](#)

[Projector Environmental Specifications](#)

[Projector Safety and Approvals Specifications \(U.S. and Canada\)](#)

[Projector Safety and Approvals Specifications \(Latin America\)](#)

## General Projector Specifications

<b>Type of display</b>	Poly-silicon TFT active matrix
<b>Resolution</b>	<b>EB-L210SF:</b> 1920 × 1080 pixels (Full HD) <b>EB-L200SW:</b> 1280 × 800 pixels (WXGA)
<b>Lens</b>	F=1.6 Focal length: 6.4 mm
<b>Color reproduction</b>	Full color, up to 1.07 billion colors

**Brightness**

Normal Light Source Mode:

White and Color light output 4000 lumens (ISO 21118 standard)

Quiet Light Source Mode:

White and Color light output 2800 lumens (ISO 21118 standard)

Extended Light Source Mode:

White and Color light output 2800 lumens (ISO 21118 standard)

Custom Light Source Mode:

White and Color light output 2800 to 4000 lumens (ISO 21118 standard)

**Note:** Color brightness (color light output) and white brightness (white light output) will vary depending on usage conditions. Color light output measured in accordance with IDMS 15.4; white light output measured in accordance with ISO 21118.

**Contrast ratio**

Over 2,500,000:1 with Dynamic Color Mode, Normal Light Source Mode, and Wide Zoom on

**Image size****EB-L210SF:**

55 inches (1.4 m) to 125 inches (3.18 m)

**EB-L210SW:**

53 inches (1.34 m) to 120 inches (3.05 m)

**Projection distance****EB-L210SF:**

55 inches (1.4 m) to 125 inches (3.18 m)

**EB-L210SW:**

53 inches (1.35 m) to 120 inches (3.05 m)

**Projection methods**

Front, rear, wall-mounted, table-mounted, ceiling-mounted

**Optical aspect ratio****EB-L210SF:**

(width-to-height)

16:9

**EB-L210SW:**

16:10



<b>Focus adjustment</b>	Manual
<b>Zoom adjustment</b>	Digital
<b>Zoom ratio</b> (Tele-to-Wide)	1.0 to 1.35
<b>Internal sound system</b>	16 W monaural
<b>Noise level</b>	37 dB (Normal Light Source Mode) 27 dB (ECO Light Source Mode)
<b>Keystone correction angle</b>	± 15°
<b>USB Type B port compatibility</b>	One USB 2.0 compliant port for USB Display, firmware update, or copying menu settings
<b>USB Type A port compatibility</b>	One USB 2.0 compliant port for USB memory device, use of a compatible Epson document camera, use of wireless LAN module, firmware update, or copying menu settings

Parent topic: [Technical Specifications](#)

## Projector Light Source Specifications

<b>Type</b>	Laser Diode
<b>Power consumption</b>	Normal Light Source Mode: 272 W Quiet Light Source Mode: 208 W
<b>Light source output power</b>	Up to 88 W
<b>Wavelength</b>	449 to 461 nm
<b>Light source life</b>	Normal or Quiet Light Source Mode: Up to about 20,000 hours Extended Light Source Mode: Up to about 30,000 hours

**Note:** Turn off this product when not in use to prolong the life of the projector. Laser life will vary depending upon mode selected, environmental conditions, and usage. Brightness decreases over time.

Parent topic: [Technical Specifications](#)

## Remote Control Specifications

<b>Reception range</b>	19.7 feet (6 m)
<b>Batteries</b>	Two alkaline or manganese AA

Parent topic: [Technical Specifications](#)

## Projector Dimension Specifications

<b>Height</b> (excluding feet)	3.5 inches (90 mm)
<b>Width</b>	12.8 inches (325 mm)
<b>Depth</b>	13.3 inches (337 mm)
<b>Weight</b>	10.4 lb (4.6 kg)

Parent topic: [Technical Specifications](#)

## Projector Electrical Specifications

<b>Rated frequency</b>	50/60 Hz
<b>Power supply</b>	100 to 240 VAC $\pm$ 10% 1.3 to 2.8 A
<b>Power consumption</b> (100 to 120 V)	Operating: Normal Light Source Mode: 272 W Quiet Light Source Mode: 208 W Standby: 0.5 W (Communication Off), 2.0 W (Communication On)

**Power consumption**

(220 to 240 V)

**Operating:**

Normal Light Source Mode: 260 W

Quiet Light Source Mode: 199 W

**Standby:**

0.5 W (Communication Off), 2.0 W (Communication On)

Parent topic: [Technical Specifications](#)

## Projector Environmental Specifications

**Temperature**

Operating - Single projector:

32 to 104 °F (0 to 40 °C)

Operating - Multiple projectors:

32 to 95 °F (0 to 35 °C)

Storage:

14 to 140 °F (-10 to 60 °C)

**Humidity** (relative, non-condensing)

Operating: 20 to 80%

Storage: 10 to 90%

**Operating altitude**

Up to 7500 feet (2286 m)

Up to 10000 feet (3048 m) with High Altitude Mode enabled

Parent topic: [Technical Specifications](#)

## Projector Safety and Approvals Specifications (U.S. and Canada)

**United States**

FCC Part 15B Class B

UL62368-1 3rd edition (cTUVus Mark)

**Canada**

ICES-003 Class B

CSA C22.2 No. 62368-1-19 (cTUVus Mark)

Parent topic: [Technical Specifications](#)

## Projector Safety and Approvals Specifications (Latin America)

### Notice for Argentina

Product Model: EB-L210SF/EB-L210SW

WLAN/Bluetooth Module Model: WLU5630B-D101(RoHS)

Brand: EPSON

CONTIENE  RAMATEL ID:C-23113

### Notice for Mexico



Operation is subject to the following two conditions: (1) this device may not cause harmful interference, and (2) this device must accept any interference received, including interference that may cause undesired operation of the device.

Product Model: EB-L210SF/EB-L210SW (HA75A/HA76A)

WLAN/Bluetooth Module Model: WLU5630B-D101(RoHS)

Brand: EPSON

IFT Certification Number: RCPEPWL19-0590

### Notice for Paraguay

Imported by:

Fastrax, S.A., Av. Perú esq. Río de Janeiro, Barrios Las Mercedes, Asunción, Paraguay

Sol Control S.R.L., Av. Gral. Bernardino Caballero 810 esq. Celsa Speratti, Asunción, Paraguay

### Notice for Peru

Product Model: EB-L210SF/EB-L210SW (HA75A/HA76A)

Brand: EPSON

This product uses the following WLAN module:

WLAN/Bluetooth Module Model: WLU5630B-D101(RoHS)

FCC ID: BKMAE-WLU5630

Product Manufacturer: Seiko Epson Corporation

Address: 3-3-5 Owa Suwa-shi, Nagano-Ken 392-8502, Japan

**Parent topic:** [Technical Specifications](#)

## Supported Video Display Formats

For best results, your computer's monitor port or video card resolution should be set to display in the projector's native resolution. However, your projector includes Epson's SizeWise chip that supports other computer display resolutions, so your image will be resized to fit automatically.

Your computer's monitor port or video card refresh rate (vertical frequency) must be compatible with the projector. (See your computer or video card manual for details.)

The table here lists the compatible refresh rate and resolution for each compatible video display format.

Display format	Refresh rate (in Hz)	Resolution (in pixels)
<b>Computer signals (analog RGB)</b>		
VGA	59.94/72/75/85	640 × 480
SVGA	60.32/72/75/85	800 × 600
XGA	60/70/75/85	1024 × 768
WXGA	60	1280 × 768
	59.79	1366 × 768
	59.81/75/85	1280 × 800
WXGA+	59.89/75/85	1440 × 900
WXGA++	60	1600 × 900
SXGA	70/75/85	1152 × 864
	60/75/85	1280 × 960
	60.02/75/85	1280 × 1024
SXGA+	59.98/75	1400 × 1050
WSXGA+	59.95	1680 × 1050
UXGA	60	1600 × 1200
WUXGA (Reduced Blanking)	59.95	1920 × 1080
<b>Composite video</b>		
TV (480i)	60	720 × 480
TV (576i)	50/60	720 × 576

Display format	Refresh rate (in Hz)	Resolution (in pixels)
<b>Component video</b>		
SDTV (480p)	59.94	720 × 480
SDTV (576p)	50	720 × 576
HDTV (720p)	50/59.94/60	1280 × 720
HDTV (1080p)	50/59.94/60	1920 × 1080
<b>HDMI input signals</b>		
VGA	59.94	640 × 480
SVGA	60.32	800 × 600
XGA	60	1024 × 768
WXGA	59.81	1280 × 800
	59.79	1366 × 768
WXGA+	59.89	1440 × 900
WXGA++	60	1600 × 900
WSXGA+	59.95	1680 × 1050
SXGA	60	1280 × 960
	60.02	1280 × 1024
SXGA+	59.98	1400 × 1050
UXGA	60	1600 × 1200
WSXGA+	59.95	1680 × 1050
1920 × 810*	60	1920 × 810
WUXGA (Reduced Blanking)	59.95	1920 × 1200
QXGA	59.95	2048 × 1536
WQHD	59.95	2560 × 1440
WXQGA (Reduced Blanking)	59.97	2560 × 1600
SDTV (480i/480p)	59.94	720 × 480
SDTV (576i/576p)	50	720 × 576

<b>Display format</b>	<b>Refresh rate (in Hz)</b>	<b>Resolution (in pixels)</b>
HDTV (720p)	50/59.94/60	1280 × 720
HDTV (1080i)	50/59.94/60	1920 × 1080
HDTV (1080p )	23.98/24/29.97/30/50/59.94/60	1920 × 1080
4K	23.98/24/25/29.97/30/50/59.94/60	3840 x 2160
4K (SMPTE)	23.98/24/50/59.94/60	4096 x 2160

\* EB-L210SF only



---

# USB Display System Requirements

Your computer system must meet the system requirements here to use the projector's USB Display software.

Requirement	Windows	Mac
Operating system	Windows 8.1 <ul style="list-style-type: none"><li>• Windows 8.1 (32- and 64-bit)</li><li>• Windows 8.1 Pro (32- and 64-bit)</li><li>• Windows 8.1 Enterprise (32- and 64-bit)</li></ul>	macOS <ul style="list-style-type: none"><li>• macOS 10.13.x (64-bit)</li><li>• macOS 10.14.x (64-bit)</li><li>• macOS 10.15.x (64-bit)</li><li>• macOS 11.0.x (64-bit)</li><li>• macOS 12.0.x (64-bit)</li></ul>
	Windows 10 <ul style="list-style-type: none"><li>• Windows 10 Home (32- and 64-bit)</li><li>• Windows 10 Pro (32- and 64-bit)</li><li>• Windows 10 Enterprise (32- and 64-bit)</li></ul>	
CPU	Intel Core2 Duo or faster (Intel Core i3 or faster recommended)	Intel Core2 Duo or faster (Intel Core i5 or faster recommended)
Memory	2GB or more (4GB or more recommended)	
Hard disk space	20MB or more	
Display	Resolution between 640 × 480 and 1920 × 1200, 16-bit color or greater	

---

## Notices

Check these sections for important notices about your projector.

[Recycling \(U.S. and Canada\)](#)

[Important Safety Information](#)

[Laser Safety Information](#)

[Important Safety Instructions](#)

[List of Safety Symbols \(corresponding to IEC60950-1 A2\)](#)

[FCC Compliance Statement](#)

[Binding Arbitration and Class Waiver](#)

[Trademarks](#)

[Copyright Notice](#)

### Recycling (U.S. and Canada)

Epson offers a recycling program for end of life products. Please go to [this site](#) for information on how to return your products for proper disposal.

**Parent topic:** [Notices](#)

### Important Safety Information

**Caution:** Never look into the projector lens when the laser is turned on; the bright light can damage your eyes. Never let children look into the lens when it is on. Never open any cover on the projector, except the filter covers. Dangerous electrical voltages inside the projector can severely injure you. Except as specifically explained in this *User's Guide*, do not attempt to service this product yourself. Refer all servicing to qualified service personnel.

**Warning:** The projector and its accessories come packaged in plastic bags. Keep plastic bags away from small children to avoid any risk of suffocation.

**Parent topic:** [Notices](#)

### Laser Safety Information

This projector is a Class 1 laser product that complies with the IEC/EN60825-1:2014 international standard for lasers. Follow these safety instructions when using the projector.

**Warning:** Possibly hazardous optical radiation emitted from this product. Do not look at operating light source. Eye injury may result.

- If an error occurs in the projector, turn off the power and unplug the projector immediately. Continuing to use the projector could result in an electric shock, fire, or visual impairment. Contact Epson support.
- Do not attempt to disassemble or modify the projector. The projector contains a high-power laser component. Serious injury could result.
- Do not look into the lens during projection. Also, do not look into the lens using optical devices, such as a magnifying glass or telescope. This could cause visual impairment.
- Do not place flammable objects in front of the lens. Objects could catch fire.
- When turning on the projector at a distance using the remote control, make sure no one is looking into the lens.
- Do not allow small children to operate the projector. Children must be accompanied by an adult.
- Do not apply optical devices, such as a magnifying glass or reflector, to the projected image. Using the projector may result in physical harm, fire, or an accident.
- Do not block the light from the lens during projection. The high temperature in this area could cause burns, fire, or other damage. The lens may overheat due to the reflected light and could cause the projector to malfunction.
- Before using the projector, make sure there is nothing in the area that could reflect the projected image.
- When disposing of the projector, do not disassemble it. Dispose of the projector in accordance with your local or national laws and regulations.

Labels are attached to the projector to indicate it is a Class 1 laser product and complies with FDA performance standards for laser products except for conformance as a Risk Group 2 LIP as defined in IEC 62471-5: Ed. 1.0 (for more information see Laser Notice No. 57, dated May 8, 2019):

**Parent topic:** [Notices](#)

## Important Safety Instructions

Follow these safety instructions when setting up and using the projector:

- Do not look into the lens when the projector is on. The bright light can damage your eyes. Avoid standing in front of the projector so the bright light does not shine into your eyes. Be especially careful if children are around. Do not look into the lens using a magnifying glass or telescope.
- When turning on the projector at a distance using the remote control, make sure there is no one looking into the lens.

- Do not place any flammable objects in front of the projector lens, otherwise, a fire may occur.
- Do not touch the lens with bare hands.
- Do not place the projector on an unstable cart, stand, or table.
- If the projector is mounted on a ceiling or wall, it should be installed by qualified technicians using mounting hardware designed for use with this projector. When installing the projector in a high position, take measures to prevent it from falling by using wires to ensure safety in an emergency, such as an earthquake, and to prevent accidents. If the projector is not installed correctly, the projector could fall. This may result in injury or accidents. Contact your dealer to carry out the installation work.
- When installing or adjusting a ceiling or wall mount, do not use adhesives to prevent the screws from loosening and do not use oils or lubricants. This may cause the projector case to crack and the projector to fall from its ceiling mount. This could cause serious injury to anyone under the mount and could damage the projector.
- Do not install the projector in locations exposed to high humidity and dust, such as on a kitchen counter, in the kitchen, or near a humidifier, or in locations exposed to oil smoke or steam. Doing so could cause fire or electric shock. In addition, the oil content could cause the projector's outer case to deteriorate and could cause the projector to fall off from the ceiling where it is suspended.

**Examples of environments that could cause the projector to fall due to case deterioration:**

- Locations subject to excessive smoke or airborne oil particles, such as factories or kitchens
- Locations containing volatile solvents or chemicals, such as factories or laboratories
- Locations where the projector could be subjected to detergents or chemicals, such as factories or kitchens
- Locations in which aroma oils are often used, such as relaxation rooms
- Near devices that produce excessive smoke, airborne oil particles, or foam at events
- Locations where the projector could be subjected to ultraviolet rays, such as a sunny room
- Locations near humidifiers
- Do not use the projector near water, sources of heat, high-voltage electrical wires, or sources of magnetic fields.
- Do not use the device near any medical equipment or equipment that is automatically controlled, such as automatic doors or fire alarms. Electromagnetic interference from the device may cause such equipment to malfunction and cause an accident.
- Use the type of power source indicated on the projector. Use of a different power source may result in fire or electric shock. If you are not sure of the power available, consult your dealer or power company.
- Place the projector near a wall outlet where the plug can be easily unplugged.

- Take the following precautions when handling the plug: Do not hold the plug with wet hands. Do not insert the plug into a dusty outlet. Insert the plug firmly into the outlet. Do not pull the power cord when disconnecting the plug; always be sure to hold the plug when disconnecting it. Do not overload wall outlets, extension cords, or power strips. Failure to comply with these precautions could result in fire or electric shock.
- Do not place the projector where the cord can be walked on. This may result in fraying or damage to the plug.
- Unplug the projector from the wall outlet and allow to cool before cleaning. Use a dry cloth (or, for stubborn dirt or stains, a moist cloth that has been wrung dry) for cleaning. Do not use liquid or aerosol cleaners, any sprays containing flammable gas, or solvents such as alcohol, paint thinner, or benzene.
- Do not block the slots and openings in the projector case. They provide ventilation and prevent the projector from overheating. If the vents are covered, the internal temperature could rise and cause a fire. Do not place the projector in locations subject to high temperatures, such as near heating equipment. Do not operate the projector on a sofa, rug, or other soft surface, or set it on top of loose papers. Do not cover the projector with a blanket, curtain, or tablecloth. If you are setting up the projector near a wall, leave at least 7.9 inches (20 cm) of space between the wall and the projector.
- Do not operate the projector in a closed-in cabinet unless proper ventilation is provided.
- Never allow objects of any kind to enter any openings in the projector. Do not leave objects, especially flammable objects, near the projector. Never spill liquid of any kind into the projector.
- If you are using two or more projectors side-by-side, leave enough space between the projectors to allow for proper ventilation.
- You may need to clean the air filter and vent. A clogged air filter or vent can block ventilation needed to cool the projector. Do not use canned air, or the gases may leave a residue.
- Do not use or store the projector in locations where it will be subject to dust or dirt. Otherwise, the quality of the projected image may decline, or the air filter may become clogged, resulting in a malfunction or fire.
- Do not store the projector outdoors for an extended length of time.
- Except as specifically explained in this manual, do not attempt to service this product yourself. Refer all servicing to qualified personnel. Opening or removing covers may expose you to dangerous voltages and other hazards.
- Never open any covers on the projector except as specifically explained in this manual. Never attempt to disassemble or modify the projector. Refer all repairs to qualified service personnel. Electrical voltages inside the projector can cause serious injury.
- Unplug the projector from the wall outlet and refer servicing to qualified service personnel under the following conditions: if it does not operate normally when you follow the operating instructions, or

exhibits a distinct change in performance; if smoke, strange odors, or strange noises come from the projector; if the power cord or plug is damaged or frayed; if liquid or foreign objects get inside the projector, or if it has been exposed to rain or water; if it has been dropped or the housing has been damaged. Continuing to use the projector under these conditions may result in fire or electric shock.

- Do not touch the plug during an electrical storm. Otherwise, you may receive an electric shock.
- Unplug the projector when it will not be used for extended periods.
- Do not use the projector where it may be exposed to rain, water, or excessive humidity.
- Do not use or store the projector where it may be exposed to smoke, steam, corrosive gases, excessive dust, vibration, or shock.
- Do not use the projector where flammable or explosive gases may be present.
- Do not use or store the projector or remote control in a hot location, such as near a heater, in direct sunlight, or in a closed vehicle.
- Check the specifications for the power cable. Using an inappropriate power cable could result in fire or electric shock. The power cable supplied with the projector is intended to comply with power supply requirements for the country of purchase. If you use the projector in the country where it was purchased, only use the power cable that came with the projector.
- If you use the projector in a country other than where you purchased it, use the correct power cord for that country.
- Do not stand on the projector or place heavy objects on it.
- Do not use the projector outside of the required temperature range below:  
32 to 104 °F (0 to 40 °C) at an altitude of 7500 feet (2286 m) or less, or 32 to 95 °F (0 to 35 °C) at an altitude of 7500 to 10000 feet (2286 to 3048 m)  
When using multiple projectors at the same time:  
32 to 95 °F (0 to 35 °C) at an altitude of 7500 feet (2286 m) or less, or 32 to 86 °F (0 to 30 °C) at an altitude of 7500 to 10000 feet (2286 m to 3048 m)  
Doing so may cause an unstable display and could lead to projector damage. Do not use or store the projector where it may be exposed to sudden changes in temperature.
- Do not store the projector outside of the required temperature range of 14 to 140 °F (–10 to 60 °C) or in direct sunlight for long periods of time. Doing so may cause damage to the case.
- Do not place anything that can become warped or damaged by heat near the exhaust vents. Do not bring your hands or face close to the vents while projection is in progress. Do not bring your face close to the projector while it is in use.

- Before you move the projector, make sure its power is turned off, the plug is disconnected from the outlet, and all cables are disconnected.
- Do not place the source of an open flame, such as a lit candle, on or near the projector.
- During projection, do not block the light from the projector with a book or other objects. If the light from the projector is blocked, the area on which the light shines becomes hot which could cause it to melt, burn, or start a fire. Also, the lens may get hot due to the reflected light which could cause the projector to malfunction. To stop projection, use the A/V Mute function, or turn off the projector.
- Do not modify the power cord. Do not place heavy objects on top of the power cord or bend, twist, or pull it excessively. Keep the power cord away from hot electrical appliances. Do not tie the power cord to other cables.
- Always lower the volume before turning off the projector. Turning on the projector with the volume too high can damage your ears.
- When a still image is displayed for a long time, image retention may occur on the screen. Do not display images in the exact same position for long periods.

#### [Restriction of Use](#)

**Parent topic:** [Notices](#)

## **Restriction of Use**







When this product is used for applications requiring high reliability/safety such as transportation devices related to aviation, rail, marine, automotive; disaster prevention devices; various safety devices; or functional/precision devices, you should use this product only after giving consideration to including fail-safes and redundancies into your design to maintain safety and total system reliability.

Because this product was not intended for use in applications requiring extremely high reliability/safety such as aerospace equipment, main communication equipment, nuclear power control equipment, or medical equipment related to direct medical care, please make your own judgment on this product's suitability after a full evaluation.







**Parent topic:** [Important Safety Instructions](#)







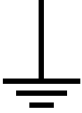

## **List of Safety Symbols (corresponding to IEC60950-1 A2)**









The following table lists the meaning of the safety symbols labeled on the equipment.

No.	Symbol	Approved Standards	Description
1		IEC60417 No.5007	"ON" (power) To indicate connection to the mains.
2		IEC60417 No.5008	"OFF" (power) To indicate disconnection from the mains.
3		IEC60417 No.5009	Stand-by To identify the switch or switch position by means of which part of the equipment is switched on in order to bring it into the stand-by condition.
4		ISO7000 No.0434B, IEC3864-B3.1	Caution To identify general caution when using the product.
5		IEC60417 No.5041	Caution, hot surface To indicate that the marked item can be hot and should not be touched without taking care.
6		IEC60417 No.6042 ISO3864-B3.6	Caution, risk of electric shock To identify equipment that has risk of electric shock.
7		IEC60417 No.5957	For indoor use only To identify electrical equipment designed primarily for indoor use.



No.	Symbol	Approved Standards	Description
8		IEC60417 No.5926	Polarity of DC power connector To identify the positive and negative connections (the polarity) on a piece of equipment to which a DC power supply may be connected.
9		—	Polarity of DC power connector To identify the positive and negative connections (the polarity) on a piece of equipment to which a DC. power supply may be connected.
10		IEC60417 No.5001B	Battery, general On battery powered equipment. To identify a device for instance a cover for the battery compartment, or the connector terminals.
11		IEC60417 No.5002	Positioning of cell To identify the battery holder itself and to identify the positioning of the cell(s) inside the battery holder.
12		—	Positioning of cell To identify the battery holder itself and to identify the positioning of the cell(s) inside the battery holder.
13		IEC60417 No.5019	Protective earth To identify any terminal which is intended for connection to an external conductor for protection against electric shock in case of a fault, or the terminal of a protective earth electrode.
14		IEC60417 No.5017	Earth To identify an earth (ground) terminal in cases where neither the symbol No.13 is explicitly required.

No.	Symbol	Approved Standards	Description
15		IEC60417 No.5032	Alternating current To indicate on the rating plate that the equipment is suitable for alternating current only; to identify relevant terminals.
16		IEC60417 No.5031	Direct current To indicate on the rating plate that the equipment is suitable for direct current only; to identify relevant terminals.
17		IEC60417 No.5172	Class II equipment To identify equipment meeting the safety requirements specified for Class II equipment according to IEC 61140.
18		ISO 3864	General prohibition To identify actions or operations that are prohibited.
19		ISO 3864	Contact prohibition To indicate injury that could occur due to touching a specific part of the equipment.
20		—	Never look into the optical lens while the projector is on.
21		—	To indicate that the marked item don't place anything on projector.
22		ISO3864 IEC60825-1	Caution, laser radiation To indicate the equipment has a laser radiation part.

No.	Symbol	Approved Standards	Description
23		ISO 3864	Disassembly prohibition To indicate a risk of injury, such as electric shock, if the equipment is disassembled.
24		IEC60417 No. 5266	Standby, partial standby To indicate that part of the equipment is in the ready status.
25		ISO3864 IEC60417 No. 5057	Caution, movable parts To indicate that you must keep away from movable parts according to protection standards.
26		IEC 60417-6056	Caution (movable fan blades) To indicate that you must keep away from the blades of the movable fan according to protection standards.
27		IEC 60417-6043	Caution (sharp corners) To indicate that you must not touch the sharp corners of the product according to protection standards.
28		—	Never look into the projection lens while the projector is on.
29		ISO7010 No. W027 ISO3864	Warning, light emission (UV, visible light, IR and so on) To indicate that you must be careful not to injure your eyes or skin when near light emitting sections.
30		IEC60417 No. 5109	Not to be used in residential areas To indicate that the electrical equipment/device is not suitable for use in residential area.

Parent topic: [Notices](#)

## FCC Compliance Statement

### For United States Users

This device complies with part 15 of the FCC Rules. Operation is subject to the following two conditions: (1) This device may not cause harmful interference, and (2) this device must accept any interference received, including interference that may cause undesired operation.

This equipment has been tested and found to comply with the limits for a Class B digital device, pursuant to Part 15 of the FCC Rules. These limits are designed to provide reasonable protection against harmful interference in a residential installation. This equipment generates, uses, and can radiate radio frequency energy and, if not installed and used in accordance with the instructions, may cause harmful interference to radio communications. However, there is no guarantee that interference will not occur in a particular installation. If this equipment does cause interference to radio and television reception, which can be determined by turning the equipment off and on, the user is encouraged to try to correct the interference by one or more of the following measures:

- Reorient or relocate the receiving antenna.
- Increase the separation between the equipment and receiver.
- Connect the equipment into an outlet on a circuit different from that to which the receiver is connected.
- Consult the dealer or an experienced radio/TV technician for help.

### WARNING

The connection of a non-shielded equipment interface cable to this equipment will invalidate the FCC Certification or Declaration of this device and may cause interference levels which exceed the limits established by the FCC for this equipment. It is the responsibility of the user to obtain and use a shielded equipment interface cable with this device. If this equipment has more than one interface connector, do not leave cables connected to unused interfaces. Changes or modifications not expressly approved by the manufacturer could void the user's authority to operate the equipment.

### For Canadian Users

CAN ICES-003(B)/NMB-003(B)

Parent topic: [Notices](#)

## Binding Arbitration and Class Waiver

### 1. DISPUTES, BINDING INDIVIDUAL ARBITRATION, AND WAIVER OF CLASS ACTIONS AND CLASS ARBITRATIONS

1.1 **Disputes.** The terms of this Section 1 shall apply to all Disputes between you and Epson. The term "Dispute" is meant to have the broadest meaning permissible under law and includes any dispute, claim, controversy or action between you and Epson arising out of or relating to this Agreement, Epson branded products (hardware and including any related software), or other transaction involving you and Epson, whether in contract, warranty, misrepresentation, fraud, tort, intentional tort, statute, regulation, ordinance, or any other legal or equitable basis. "DISPUTE" DOES NOT INCLUDE IP CLAIMS, or more specifically, a claim or cause of action for (a) trademark infringement or dilution, (b) patent infringement, (c) copyright infringement or misuse, or (d) trade secret misappropriation (an "IP Claim"). You and Epson also agree, notwithstanding Section 1.6, that a court, not an arbitrator, may decide if a claim or cause of action is for an IP Claim.

1.2 **Binding Arbitration.** You and Epson agree that all Disputes shall be resolved by binding arbitration according to this Agreement. **ARBITRATION MEANS THAT YOU WAIVE YOUR RIGHT TO A JUDGE OR JURY IN A COURT PROCEEDING AND YOUR GROUNDS FOR APPEAL ARE LIMITED.** Pursuant to this Agreement, binding arbitration shall be administered by JAMS, a nationally recognized arbitration authority, pursuant to its code of procedures then in effect for consumer related disputes, but excluding any rules that permit joinder or class actions in arbitration (for more detail on procedure, see Section 1.6 below). You and Epson understand and agree that (a) the Federal Arbitration Act (9 U.S.C. §1, et seq.) governs the interpretation and enforcement of this Section 1, (b) this Agreement memorializes a transaction in interstate commerce, and (c) this Section 1 shall survive termination of this Agreement.

1.3 **Pre-Arbitration Steps and Notice.** Before submitting a claim for arbitration, you and Epson agree to try, for sixty (60) days, to resolve any Dispute informally. If Epson and you do not reach an agreement to resolve the Dispute within the sixty (60) days, you or Epson may commence an arbitration. Notice to Epson must be addressed to: Epson America, Inc., ATTN: Legal Department, 3131 Katella Ave., Los Alamitos, CA 90720 (the "Epson Address"). The Dispute Notice to you will be sent to the most recent address Epson has in its records for you. For this reason, it is important to notify us if your address changes by emailing us at [EAILEgal@ea.epson.com](mailto:EAILEgal@ea.epson.com) or writing us at the Epson Address above. Notice of the Dispute shall include the sender's name, address and contact information, the facts giving rise to the Dispute, and the relief requested (the "Dispute Notice"). Following receipt of the Dispute Notice, Epson and you agree to act in good faith to resolve the Dispute before commencing arbitration.

1.4 **Small Claims Court.** Notwithstanding the foregoing, you may bring an individual action in the small claims court of your state or municipality if the action is within that court's jurisdiction and is pending only in that court.

**1.5 WAIVER OF CLASS ACTIONS AND CLASS ARBITRATIONS. YOU AND EPSON AGREE THAT EACH PARTY MAY BRING DISPUTES AGAINST THE OTHER PARTY ONLY IN AN INDIVIDUAL CAPACITY, AND NOT AS A PLAINTIFF OR CLASS MEMBER IN ANY CLASS OR REPRESENTATIVE PROCEEDING, INCLUDING WITHOUT LIMITATION FEDERAL OR STATE CLASS ACTIONS, OR CLASS ARBITRATIONS. CLASS ACTION LAWSUITS, CLASS-WIDE ARBITRATIONS, PRIVATE ATTORNEY-GENERAL ACTIONS, AND ANY OTHER PROCEEDING WHERE SOMEONE ACTS IN A REPRESENTATIVE CAPACITY ARE NOT ALLOWED. ACCORDINGLY, UNDER THE ARBITRATION PROCEDURES OUTLINED IN THIS SECTION, AN ARBITRATOR SHALL NOT COMBINE OR CONSOLIDATE MORE THAN ONE PARTY'S CLAIMS WITHOUT THE WRITTEN CONSENT OF ALL AFFECTED PARTIES TO AN ARBITRATION PROCEEDING.**

**1.6 Arbitration Procedure.** If you or Epson commences arbitration, the arbitration shall be governed by the rules of JAMS that are in effect when the arbitration is filed, excluding any rules that permit arbitration on a class or representative basis (the "JAMS Rules"), available at <http://www.jamsadr.com> or by calling 1-800-352-5267 (U.S. or Canada), or <https://www.jamsadr.com/about/> or by calling +1-949-224-1810 (Latin America), and under the rules set forth in this Agreement. All Disputes shall be resolved by a single neutral arbitrator, and both parties shall have a reasonable opportunity to participate in the selection of the arbitrator. The arbitrator is bound by the terms of this Agreement. The arbitrator, and not any federal, state or local court or agency, shall have exclusive authority to resolve all disputes arising out of or relating to the interpretation, applicability, enforceability or formation of this Agreement, including any claim that all or any part of this Agreement is void or voidable. Notwithstanding this broad delegation of authority to the arbitrator, a court may determine the limited question of whether a claim or cause of action is for an IP Claim, which is excluded from the definition of "Disputes" in Section 1.1 above. The arbitrator shall be empowered to grant whatever relief would be available in a court under law or in equity. The arbitrator may award you the same damages as a court could, and may award declaratory or injunctive relief only in favor of the individual party seeking relief and only to the extent necessary to provide relief warranted by that party's individual claim. In some instances, the costs of arbitration can exceed the costs of litigation and the right to discovery may be more limited in arbitration than in court. The arbitrator's award is binding and may be entered as a judgment in any court of competent jurisdiction.

You may choose to engage in arbitration hearings by telephone. Arbitration hearings not conducted by telephone shall take place in a location reasonably accessible from your primary residence, or in Orange County, California, at your option.

a) Initiation of Arbitration Proceeding. If either you or Epson decides to arbitrate a Dispute, both parties agree to the following procedure:

(i) Write a Demand for Arbitration. The demand must include a description of the Dispute and the amount of damages sought to be recovered. You can find a copy of a Demand for Arbitration at <http://www.jamsadr.com> ("Demand for Arbitration").

(ii) Send three copies of the Demand for Arbitration, plus the appropriate filing fee, to: JAMS, 500 North State College Blvd., Suite 600 Orange, CA 92868, U.S.A.

(iii) Send one copy of the Demand for Arbitration to the other party (same address as the Dispute Notice), or as otherwise agreed by the parties.

b) Hearing Format. During the arbitration, the amount of any settlement offer made shall not be disclosed to the arbitrator until after the arbitrator determines the amount, if any, to which you or Epson is entitled. The discovery or exchange of non-privileged information relevant to the Dispute may be allowed during the arbitration.

c) Arbitration Fees. Epson shall pay, or (if applicable) reimburse you for, all JAMS filings and arbitrator fees for any arbitration commenced (by you or Epson) pursuant to provisions of this Agreement.

d) Award in Your Favor. For Disputes in which you or Epson seeks \$75,000 or less in damages exclusive of attorney's fees and costs, if the arbitrator's decision results in an award to you in an amount greater than Epson's last written offer, if any, to settle the Dispute, Epson will: (i) pay you \$1,000 or the amount of the award, whichever is greater; (ii) pay you twice the amount of your reasonable attorney's fees, if any; and (iii) reimburse you for any expenses (including expert witness fees and costs) that your attorney reasonably accrues for investigating, preparing, and pursuing the Dispute in arbitration. Except as agreed upon by you and Epson in writing, the arbitrator shall determine the amount of fees, costs, and expenses to be paid by Epson pursuant to this Section 1.6d).

e) Attorney's Fees. Epson will not seek its attorney's fees and expenses for any arbitration commenced involving a Dispute under this Agreement. Your right to attorney's fees and expenses under Section 1.6d) above does not limit your rights to attorney's fees and expenses under applicable law; notwithstanding the foregoing, the arbitrator may not award duplicative awards of attorney's fees and expenses.

**1.7 Opt-out. You may elect to opt-out (exclude yourself) from the final, binding, individual arbitration procedure and waiver of class and representative proceedings specified in this Agreement by sending a written letter to the Epson Address within thirty (30) days of your assent to this Agreement (including without limitation the purchase, download, installation of the Software or other applicable use of Epson Hardware, products and services) that specifies (i) your name, (ii) your mailing address, and (iii) your request to be excluded from the final, binding individual arbitration procedure and waiver of class and representative proceedings specified in this Section 1. In the event that you opt-out consistent with the procedure set forth above, all other terms shall continue to apply, including the requirement to provide notice prior to litigation.**

**1.8 Amendments to Section 1.** Notwithstanding any provision in this Agreement to the contrary, you and Epson agree that if Epson makes any future amendments to the dispute resolution procedure and class action waiver provisions (other than a change to Epson's address) in this Agreement, Epson will obtain your affirmative assent to the applicable amendment. If you do not affirmatively assent to the applicable amendment, you are agreeing that you will arbitrate any Dispute between the parties in

accordance with the language of this Section 1 (or resolve disputes as provided for in Section 1.7, if you timely elected to opt-out when you first assented to this Agreement).

**1.9 Severability.** If any provision in this Section 1 is found to be unenforceable, that provision shall be severed with the remainder of this Agreement remaining in full force and effect. **The foregoing shall not apply to the prohibition against class or representative actions as provided in Section 1.5. This means that if Section 1.5 is found to be unenforceable, the entire Section 1 (but only Section 1) shall be null and void.**

Parent topic: [Notices](#)

## Trademarks

EPSON®, Instant Off® and Quick Corner® are registered trademarks, Epson iProjection is a trademark, and EPSON Exceed Your Vision is a registered logomark of Seiko Epson Corporation.

PrivateLine® is a registered trademark and SizeWise™ is a trademark of Epson America, Inc.

Microsoft and Windows are either registered trademarks or trademarks of Microsoft Corporation in the United States and other countries.

Mac, macOS, OS X, and App Store are trademarks of Apple Inc., registered in the U.S. and other countries.

Google® is a registered trademark and Android™, Chromebook™, Google Chrome™, and Google Play™ are trademarks of Google LLC.

Miracast® is a registered trademark of Wi-Fi Alliance®.

HDMI and High-Definition Multimedia Interface are the trademarks or registered trademarks of HDMI Licensing LLC.  HIGH DEFINITION MULTIMEDIA INTERFACE

General Notice: Other product names used herein are for identification purposes only and may be trademarks of their respective owners. Epson disclaims any and all rights in those marks.

**EPSON®**  
EXCEED YOUR VISION

Parent topic: [Notices](#)



## Copyright Notice

All rights reserved. No part of this publication may be reproduced, stored in a retrieval system, or transmitted in any form or by any means, electronic, mechanical, photocopying, recording, or otherwise, without the prior written permission of Seiko Epson Corporation. The information contained herein is designed only for use with this Epson product. Epson is not responsible for any use of this information as applied to other products.

Neither Seiko Epson Corporation nor its affiliates shall be liable to the purchaser of this product or third parties for damages, losses, costs, or expenses incurred by purchaser or third parties as a result of: accident, misuse, or abuse of this product or unauthorized modifications, repairs, or alterations to this product, or (excluding the U.S.) failure to strictly comply with Seiko Epson Corporation's operating and maintenance instructions.

Seiko Epson Corporation shall not be liable for any damages or problems arising from the use of any options or any consumable products other than those designated as Original Epson Products or Epson Approved Products by Seiko Epson Corporation.

This information is subject to change without notice.

[A Note Concerning Responsible Use of Copyrighted Materials](#)

[Copyright Attribution](#)

**Parent topic:** [Notices](#)

## A Note Concerning Responsible Use of Copyrighted Materials

Epson encourages each user to be responsible and respectful of the copyright laws when using any Epson product. While some countries' laws permit limited copying or reuse of copyrighted material in certain circumstances, those circumstances may not be as broad as some people assume. Contact your legal advisor for any questions regarding copyright law.

**Parent topic:** [Copyright Notice](#)

## Copyright Attribution

© 2023 Epson America, Inc.

3/23

CPD-63089

**Parent topic:** [Copyright Notice](#)