



Digital Projector

# User Manual

LX890UST / LW890UST / LH890UST

V1.01



# Table of contents

## Important safety

**instructions ..... 3**

**Introduction..... 5**

Projector features..... 5

Shipping contents ..... 6

Projector exterior view..... 8

Controls and functions ..... 9

**Positioning your projector ..... 14**

Choosing a location..... 14

Obtaining a preferred projected image size..... 15

Mounting the projector ..... 18

**Connection ..... 20**

Connecting Video source devices.....21

Connecting smart device.....22

**Operation ..... 23**

Starting up the projector .....23

Adjusting the projected image .....24

Using the menus.....27

Securing the projector.....28

Switching input signal .....30

Magnifying and searching for details ...31

Selecting the aspect ratio .....31

Optimizing the image .....33

Setting the presentation timer .....37

Hiding the image.....38

Freezing the image.....38

Operating in a high altitude environment..... 38

Adjusting the sound.....39

Setting **Auto Power Off**.....39

Personalizing the projector menu display..... 40

Select the Light Mode..... 40

Use Teaching Template..... 41

Controlling the projector through a LAN environment..... 42

Upgrading firmware via LAN ..... 46

Installing PointWrite Module on Projector to use interaction function 47

Shutting down the projector ..... 48

Menu operation ..... 49

**Maintenance ..... 64**

Care of the projector ..... 64

**Troubleshooting..... 66**

**Specifications..... 67**

Dimensions ..... 68

Timing chart..... 69

**Warranty and Copyright information..... 73**

# Important safety instructions

Your projector is designed and tested to meet the latest standards for safety of information technology equipment. However, to ensure safe use of this product, it is important that you follow the instructions mentioned in the user manual / installation guide and marked on the product.

1. **Please read the user manual / installation guide before you operate your projector.** Save it for future reference.
2. **Do not look straight at the projector lens during operation.** The intense light beam may damage your eyes.
3. **Refer servicing to qualified service personnel.**
4. **Always open the lens shutter (if any) or remove the lens cap (if any) when the projector light source is on.**
5. The light source becomes extremely hot during operation.
6. In some countries, the line voltage is NOT stable. This projector is designed to operate safely within a mains voltage between 100 to 240 volts AC, but could fail if power cuts or surges of  $\pm 10$  volts occur. **In areas where the mains voltage may fluctuate or cut out, it is recommended that you connect your projector through a power stabilizer, surge protector or uninterruptible power supply (UPS).**
7. Do not block the projection lens with any objects when the projector is under operation as this could cause the objects to become heated and deformed or even cause a fire. To temporarily turn off the light source, use the blank function.
8. Do not operate light sources beyond the rated light source life.
9. Do not place this product on an unstable cart, stand, or table. The product may fall sustaining serious damage.
10. Do not attempt to disassemble this projector. There are dangerous high voltages inside which may cause death if you should come into contact with live parts.  
Under no circumstances should you ever undo or remove any other covers.  
Refer servicing only to suitably qualified professional service personnel.
11. Do not block the ventilation holes.
  - Do not place this projector on a blanket, bedding or any other soft surface.
  - Do not cover this projector with a cloth or any other item.
  - Do not place inflammables near the projector.If the ventilation holes are seriously obstructed, overheating inside the projector may result in a fire.
12. Do not stand the projector on end vertically. Doing so may cause the projector to fall over, causing injury or resulting in damage to the projector.
13. Do not step on the projector or place any objects upon it. Besides probable physical damage to the projector, doing so may result in accidents and possible injury.
14. When the projector is under operation, you may sense some heated air and odor from its ventilation grill. It is a normal phenomenon and not a product defect.
15. Do not place liquids near or on the projector. Liquids spilled into the projector may cause it to fail. If the projector does become wet, disconnect it from the power supply's power outlet and call BenQ to have the projector serviced.

16. This apparatus must be earthed.
17. Do not place this projector in any of the following environments.
  - Space that is poorly ventilated or confined. Allow at least 50 cm clearance from walls and free flow of air around the projector.
  - Locations where temperatures may become excessively high, such as the inside of a car with all windows rolled up.
  - Locations where excessive humidity, dust, or cigarette smoke may contaminate optical components, shorten the projector's life span and darken the image.
  - Locations near fire alarms
  - Locations with an ambient temperature above 40°C / 104°F
  - Locations where the altitudes are higher than 3000 m (10000 feet).

### Risk Group 2

1. According to the classification of photobiological safety of light sources and light source systems, this product is Risk Group 2, IEC 62471-5:2015.
2. Possibly hazardous optical radiation emitted from this product.
3. Do not stare at operating light source. May be harmful to the eyes.
4. As with any bright source, do not stare into the direct beam.



The projector's light source unit uses a laser.

### Laser Caution

(For China and other regions) This product belongs to CLASS 1 laser product and complies with IEC 60825-1:2014.

(For north America) This product belongs to CLASS 2 laser product and complies with IEC 60825-1:2007.

**LASER RAOIATION, DO NOT STARE INTO BEAM, CLASS 2 LASER PROOUCT.**

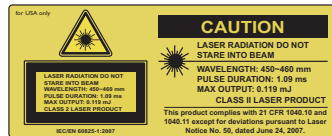

(For north America)



(For other regions)

# Introduction

## Projector features

This model is one of the best projectors available in the world. You can enjoy the best video quality across various devices such as PC, laptop, DVD and VCR even document camera to bring all possibility to life.

The projector offers the following features.

- **2D keystone for easy horizontal and vertical keystone correction allows you to project a rectangular image from any angle**
  - **Corner Fit allows you to adjust four corners of the projected image**
  - **Equipped with HDMI & MHL connection supporting HDCP**
  - **Dimming Mode starts your dynamic power saving**
  - **Wall color correction allowing projection on surfaces of several predefined colors**
  - **Quick auto search speeding up the signal detecting process**
  - **3D color management allowing color adjustments to your liking**
  - **Presentation timer for better control of time during presentations**
  - **One-key auto-adjustment to display the best picture quality**
  - **Component HDTV compatibility (YPbPr)**
-  • **The apparent brightness of the projected image will vary depending on the ambient lighting conditions, selected input signal contrast/brightness settings, and is proportional to projection distance.**

# Shipping contents

Carefully unpack and verify that you have all of the items shown below. If any of these items are missing, please contact your place of purchase.

## Standard accessories

 The supplied accessories will be suitable for your region, and may differ from those illustrated.

**\*The warranty card is only supplied in some specific regions. Please consult your dealer for detailed information.**

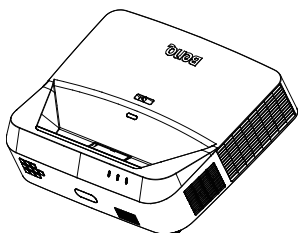

---

Projector with the  
projector mounting plate

---

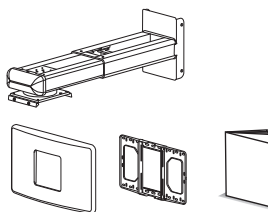

---

Wall mount kit & user manual

---



---

Remote control or remote control without  
laser (depending on region) & batteries

---

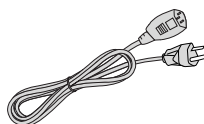

---

Power cord

---

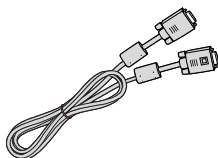

---

VGA cable

---

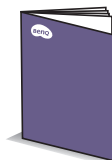

---

Quick start guide

---



---

User manual CD

---



---

Warranty card\*

---

## Optional accessories

1. Wireless dongle: QCast (QP01), QCastMirror(QP20), InstaShow™ (WDC10)
2. Dust Filter: FTFS02 (3mm)
3. 3D glasses
4. PointWrite kit (PW40U)

# Projector exterior view

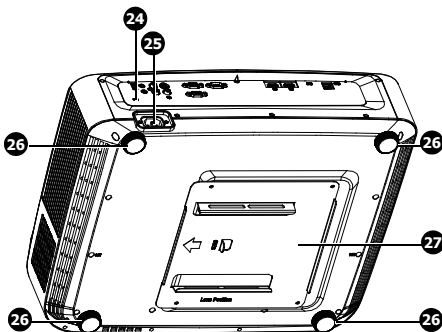
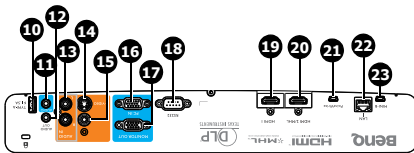
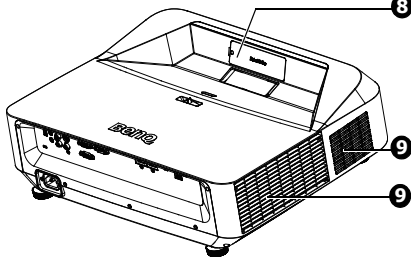
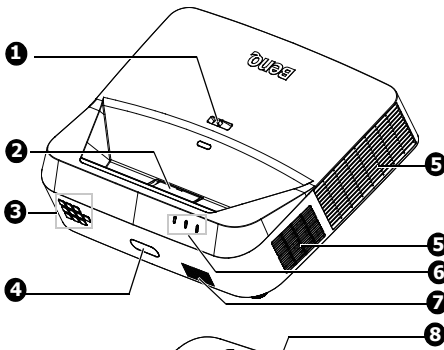









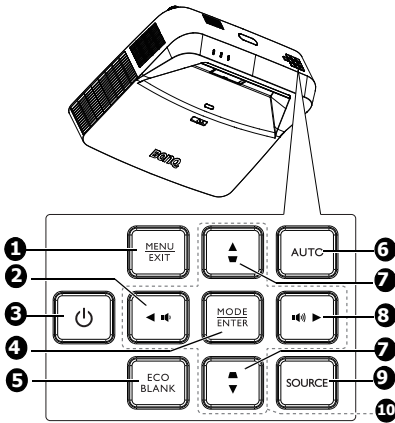

1. Focus ring
2. Projection lens and Mirror
3. External control panel  
(See "Projector" on page 9 for details.)
4. Front IR remote sensor
5. Ventilation holes (exhaust)
6. POWER indicator light/  
TEMPERature warning light/  
LIGHT indicator light
7. Speaker grille
8. PointWrite dummy cover  
(Optional PointWrite kit)
9. Ventilation holes (intake)
10. USB type A/1.5A jack
11. Audio input jack
12. Audio output jack
13. Audio (L/R) input jack
14. S-Video input jack
15. Video input jack
16. RGB (PC)/Component video  
(YPbPr/ YCbCr) signal input jack
17. RGB signal output jack
18. RS232 control port
19. HDMI I input jack
20. HDMI 2/MHL input jack
21. PointWrite port (PointWrite kit  
is required)
22. RJ-45 LAN input jack
23. USB Mini-B jack
24. Kensington anti-theft lock slot
25. AC power cord inlet
26. Adjuster feet
27. Projector mounting plate



# Controls and functions

## Projector



1. **MENU**  
Turns on the On-Screen Display (OSD) menu.  
**EXIT**  
Goes back to previous OSD menu, exits and saves menu settings.
2.   
Decreases the projector volume.
3.  **Power**  
Toggles the projector between standby mode and on.
4. **MODE**  
Selects an available picture setup mode.  
**ENTER**  
Activates the selected On-Screen Display (OSD) menu item.
5. **Eco Blank**  
Used to hide the screen picture.
6. **Auto**  
Automatically determines the best picture timings for the displayed image.
7. Keystone keys (, )  
Displays 2D Keystone page.
8.   
Increases the projector volume.
9. **SOURCE**  
Displays the source selection bar.
10. Arrow keys (, , , )  
When the On-Screen Display (OSD) menu is activated, these keys are used as directional arrows to select the desired menu items and to make adjustments.

# Remote control

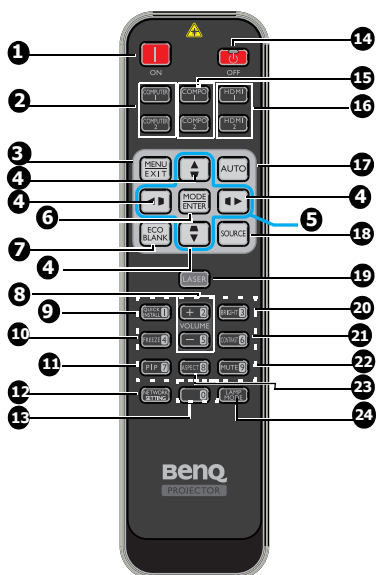

1. **ON**  
Turns on the projector.
2. **COMPUTER 1/COMPUTER 2**  
Displays RGB (PC)/Component video (YPbPr/ YCbCr) signal.  
**COMPUTER 2:** Not operational on this projector.
3. **MENU**  
Turns on the On-Screen Display (OSD) menu.  
**EXIT**  
Goes back to previous OSD menu, exits and saves menu settings.
4. Keystone keys (▼, ▲, ►, ◄)  
Displays 2D Keystone page and adjusts the vertical and horizontal keystone values.

5. Arrow keys (▲, ▼, ◀, ▶)  
When the On-Screen Display (OSD) menu is activated, these keys are used as directional arrows to select the desired menu items and to make adjustments.
6. **MODE**  
Selects an available picture setup mode.  
**ENTER**  
Activates the selected On-Screen Display (OSD) menu item.
7. **Eco Blank**  
Used to hide the screen picture.
8. **VOLUME + / -**  
Adjusts the projector volume.
9. **QUICK INSTALL**  
A menu shortcut that includes Test Pattern, Projector Installation, 2D Keystone and Corner Fit.
10. **Freeze**  
Freezes the projected image.
11. **PIP**  
Not operational on this projector.
12. **NETWORK SETTING**  
Displays Network Settings menu.
13. Number keys
14. **OFF**  
Turns off the projector.
15. **COMPO 1/COMPO 2**  
Not operational on this projector.



16. **HDMI 1/HDMI 2**  
Displays HDMI signal.
17. **Auto**  
Automatically determines the best picture timings for the displayed image.
18. **SOURCE**  
Displays the source selection bar.
19. **LASER**  
Emits visible laser pointer light for presentation purposes.
20. **BRIGHT**  
Adjusts the brightness of the image.
21. **CONTRAST**  
Adjusts the degree of difference between dark and light in the image.
22. **Mute**  
Toggles projector audio between on and off.
23. **Aspect**  
Selects the display aspect ratio.
24. **LAMP MODE**  
Displays the light mode selection bar (Normal/Economic/Dimming).

## Operating the laser pointer

The Laser Pointer is a presentation aid for professionals. It emits red colored light when you press it and the indicator lights up red.

The laser beam is visible. It is necessary to press and hold **LASER** for continuous output.



**Do not look into the laser light window or shine the laser light beam on yourself or others. See the warning messages on the back of the remote control prior to using it.**

The laser pointer is not a toy. Parents should be mindful of the dangers of laser energy and keep this remote control out of the reach of children.

\*Remote control for Japan region



Test key acts as Quick Install key.



Infra-Red (IR) remote control sensor is located on the front of the projector. The remote control must be held at an angle within 30 degrees perpendicular to the projector's IR remote control sensor to function correctly. The distance between the remote control and the sensor should not exceed 8 meters (~ 26 feet).

Make sure that there are no obstacles between the remote control and the IR sensor on the projector that might obstruct the infra-red beam.

- **Operating the projector from the front**

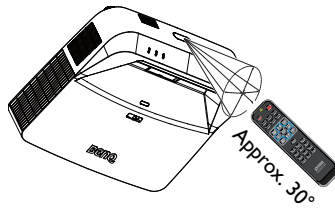

## Replacing the remote control battery

1. To open the battery cover, turn the remote control over to view its back, push on the finger grip on the cover and slide it up in the direction of the arrow as illustrated. The cover will slide off.
2. Remove any existing batteries (if necessary) and install two AAA batteries observing the battery polarities as indicated in the base of the battery compartment. Positive (+) goes to positive and negative (-) goes to negative.
3. Refit the cover by aligning it with the base and sliding it back down into position. Stop when it clicks into place.

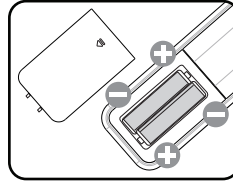
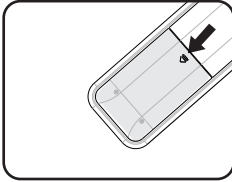

- **Avoid excessive heat and humidity.**
- **There may be battery damage if the battery is incorrectly replaced.**
- **Replace only with the same or equivalent type recommended by the battery manufacturer.**
- **Dispose of the used battery according to the battery manufacturer's instructions.**
- **Never throw a battery into a fire. There may be danger of an explosion.**
- **If the battery is dead or if you will not be using the remote control for a long time, remove the battery to prevent damage to the remote control from possible battery leakage.**

# Positioning your projector

## Choosing a location

Your room layout or personal preference will dictate which installation location you select. Take into consideration the size and position of your screen, the location of a suitable power outlet, as well as the location and distance between the projector and the rest of your equipment.

Your projector is designed to be installed in one of two possible installation locations:

### 1. Front Ceiling

Select this location with the projector suspended upside-down from the ceiling in front of the screen.

Use BenQ Projector Wall Mounting Kit come with the box to mount on the wall.

Set **Front Ceiling** in the **SYSTEM SETUP: Basic > Projector Installation** menu after you turn the projector on.

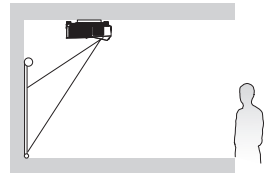

### 2. Rear Ceiling

Select this location with the projector suspended upside-down from the ceiling behind the screen.

Note that a special rear projection screen and the BenQ Projector Wall Mounting Kit are required for this installation location.

Set **Rear Ceiling** in the **SYSTEM SETUP: Basic > Projector Installation** menu after you turn the projector on.

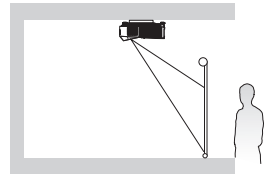

You can also use **QUICK INSTALL** key on the remote control to select projector's location.

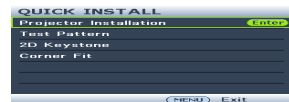

# Obtaining a preferred projected image size

## Projection dimensions

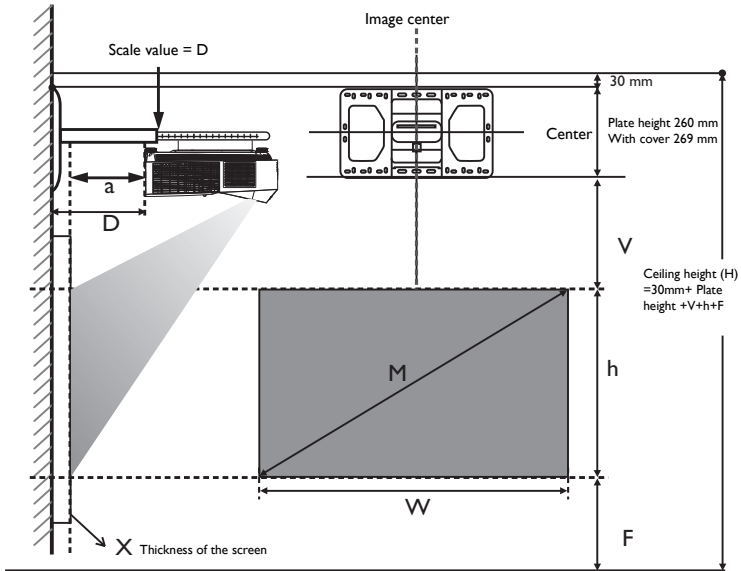

- ☞ • **Installation distance D** is measured from the projector rear side to the wall surface, which is also indicated on the scale of the wall mount.
- **Projection distance a** is measured from the projector rear side to the projection surface.
- **Vertical offset V** is measured from the bottom edge of the wall plate to the top edge of screen.

# Image adjustment area

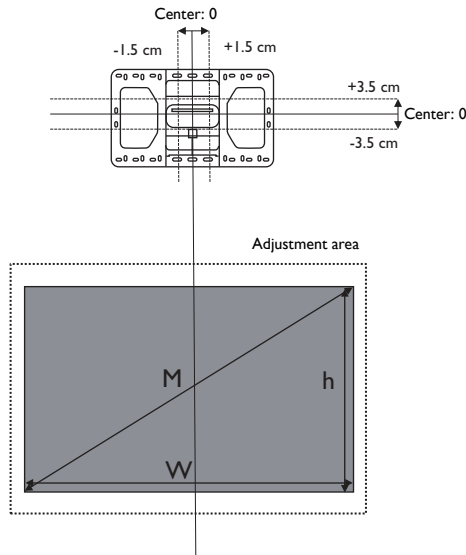

## LX890UST

The screen aspect ratio is 4:3 and the projected picture is in a 4:3 aspect ratio.

Screen size			Minimum Ceiling height	Vertical offset	Installation distance (D)		
Diagonal (M)	Height (h)	Width (W)	H <sup>a</sup>	V	X <sup>b</sup> =0 mm (D=a)	X <sup>c</sup> =30 mm (D=a+30 mm)	
Inch	mm	(mm)	(mm)	(mm)	(mm)	(mm)	
73	1854	1113	1483	2359	185.4	118	148
78	1981	1189	1585	2449	198.9	150	180
83	2108	1265	1687	2538	212.3	182	212
88	2235	1341	1788	2628	225.8	214	244
93	2362	1417	1890	2718	239.3	246	276
98	2489	1494	1991	2807	252.7	278	308
100	2540	1524	2032	2843	258.1	291	321
101	2565	1539	2052	2861	260.8	298	328

- base on an image 762 mm from the floor, if the image is lower, the min ceiling height is reduced by the measurement.
- Assume the thickness of projection screen(X) is 0 mm.
- Assume the thickness of projection screen(X) is 30 mm.



## LW890UST

The screen aspect ratio is 16:10 and the projected picture is in a 16:10 aspect ratio.

Screen size			Minimum Ceiling height	Vertical offset	Installation distance (D)		
Diagonal (M)		Height (h)	Width (W)	H <sup>a</sup>	V	X <sup>b</sup> =0 mm (D=a)	X <sup>c</sup> =30 mm (D=a+30 mm)
Inch	mm	(mm)	(mm)	(mm)	(mm)	(mm)	(mm)
80	2032	1077	1723	2288	150	85	115
85	2159	1144	1831	2365	160	112	142
90	2286	1212	1939	2443	170	139	169
95	2413	1279	2046	2520	180	166	196
100	2540	1346	2154	2598	190	194	224
105	2667	1414	2262	2675	200	221	251
110	2794	1481	2369	2752	211	248	278
115	2921	1548	2477	2830	221	275	305
119	3023	1602	2563	2892	229	297	327

- base on an image 762 mm from the floor, if the image is lower, the min ceiling height is reduced by the measurement.
- Assume the thickness of projection screen(X) is 0 mm.
- Assume the thickness of projection screen(X) is 30 mm.

## LH890UST

The screen aspect ratio is 16:9 and the projected picture is in a 16:9 aspect ratio.

Screen size			Minimum Ceiling height	Vertical offset	Installation distance (D)		
Diagonal (M)		Height (h)	Width (W)	H <sup>a</sup>	V	X <sup>b</sup> =0 mm (D=a)	X <sup>c</sup> =30 mm (D=a+30 mm)
Inch	mm	(mm)	(mm)	(mm)	(mm)	(mm)	(mm)
81	2057	1009	1793	2247	178	81	111
86	2184	1071	1904	2321	189	107	137
91	2311	1133	2015	2395	201	134	164
96	2438	1195	2125	2469	213	160	190
101	2565	1258	2236	2543	224	187	217
106	2692	1320	2347	2617	236	214	244
111	2819	1382	2457	2691	248	240	270
116	2946	1445	2568	2765	259	267	297
121	3073	1507	2679	2839	271	293	323

- base on an image 762 mm from the floor, if the image is lower, the min ceiling height is reduced by the measurement.
- Assume the thickness of projection screen(X) is 0 mm.
- Assume the thickness of projection screen(X) is 30 mm.



**All measurements are approximate and may vary from the actual sizes. BenQ recommends that if you intend to permanently install the projector, you should physically test the projection size and distance using the actual projector in situ before you permanently install it, so as to make allowance for this projector's optical characteristics. This will help you determine the exact mounting position so that it best suits your installation location.**

# Mounting the projector

If you intend to mount your projector, we strongly recommend that you use a proper fitting BenQ projector mounting kit and that you ensure it is securely and safely installed.

If you use a non-BenQ brand projector mounting kit, there is a safety risk that the projector may fall down due to an improper attachment through the use of the wrong gauge or length screws.

## Before mounting the projector

- Use BenQ Projector Wall Mounting Kit come with the package. Please refer to the User manual in the box of wall mount kit for installation details.
- BenQ recommends that you also purchase a separate Kensington lock compatible security cable and attach it securely to both the Kensington lock slot on the projector and the base of the mounting bracket. This will perform the secondary role of restraining the projector should its attachment to the mounting bracket become loose.
- Ask your dealer to install the projector for you. Installing the projector on your own may cause it to fall and result in injury.
- Take necessary procedures to prevent the projector from falling off such as during an earthquake.
- The warranty doesn't cover any product damage caused by mounting the projector with a non-BenQ brand projector mounting kit.
- Consider the surrounding temperature where the projector is ceiling/wall mounted. If a heater is used, the temperature around the ceiling may be higher than expected.
- Read the user manual for the mounting kit about the range of torque. Tightening with torque exceeding the recommended range may cause damage to the projector and subsequently falling off.
- Make sure the power outlet is at an accessible height so that you can easily shut down the projector.

## Install the projector on the projector wall mount

1. Slide the projector into the wall mount.

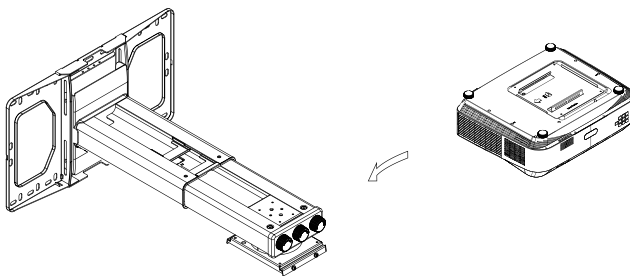

2. Adjust the Vertical Tilt/Horizontal Roll/Horizontal Rotation to adjust screen alignment and image position.

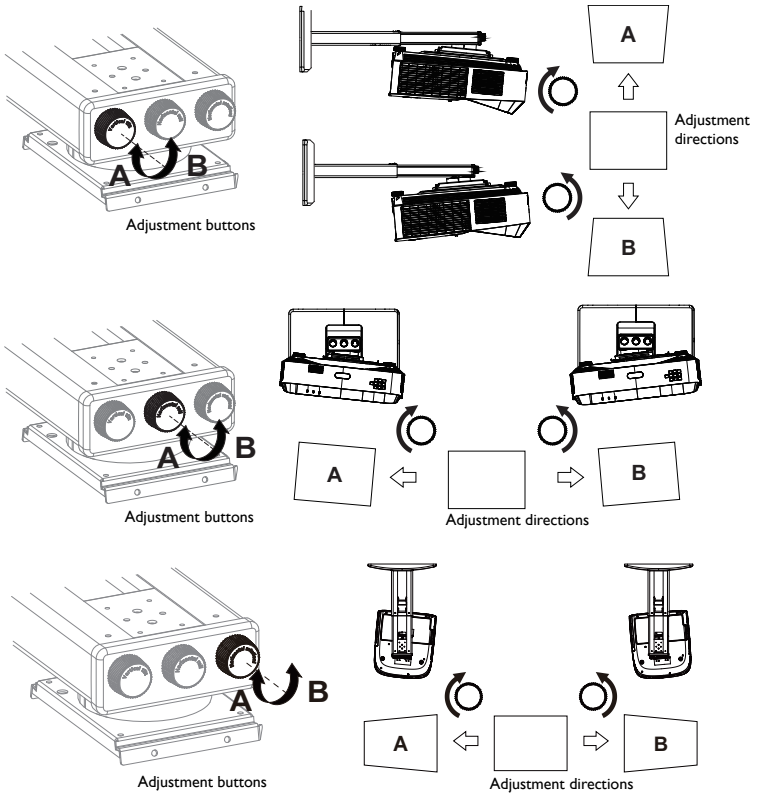

3. Adjust The Forward/Backward Slide to reduce/enlarge the image.

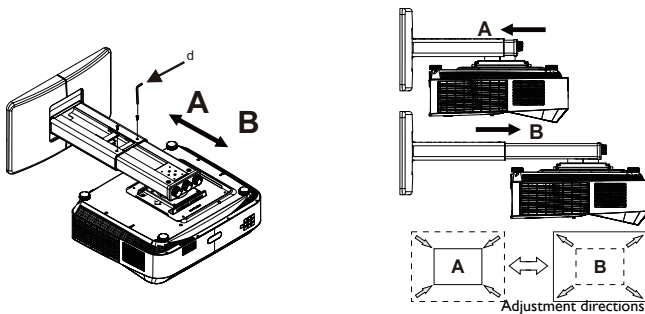

# Connection

When connecting a signal source to the projector, be sure to:

1. Turn all equipment off before making any connections.
2. Use the correct signal cables for each source.
3. Ensure the cables are firmly inserted.

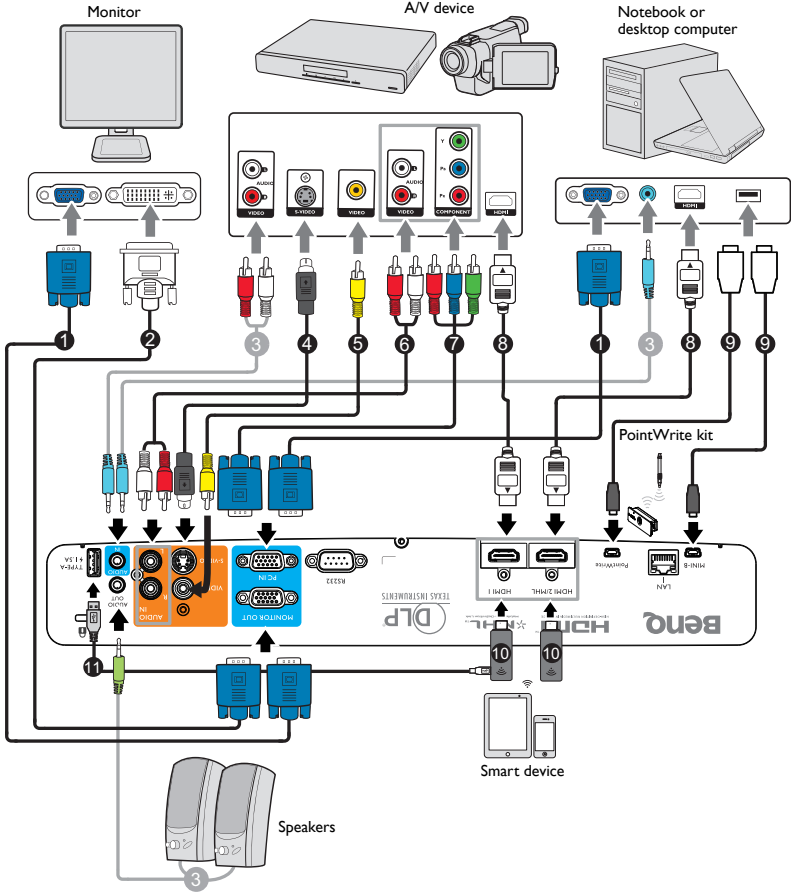





- |  |   |
|--|---|
| <ol style="list-style-type: none"> <li>1. VGA cable</li> <li>2. VGA to DVI-A cable</li> <li>3. Audio cable</li> <li>4. S-Video cable</li> <li>5. Video cable</li> <li>6. Audio L/R cable</li> <li>7. Component Video to VGA (D-Sub) adapter cable</li> </ol> | <ol style="list-style-type: none"> <li>8. HDMI cable</li> <li>9. USB cable</li> <li>10. HDMI dongle (QCast, QCast Mirror, etc.)</li> <li>11. USB cable (A to micro B type) connect to HDMI dongle for power supply</li> </ol> |
|--|---|

- In the connections shown above, some cables may not be included with the projector (see **"Shipping contents" on page 6**). They are commercially available from electronics stores.
- The connection illustrations are for reference only. The rear connecting jacks available on the projector vary with each projector model.
- Many notebooks do not turn on their external video ports when connected to a projector. Usually a key combo like **FN + F3** or **CRT/LCD** key turns the external display on/off. Locate a function key labeled **CRT/LCD** or a function key with a monitor symbol on the notebook. Press **FN** and the labeled function key simultaneously. Refer to your notebook's documentation to find your notebook's key combination.
- The output signal for **MONITOR OUT** jack only works when the input signal comes from **PC IN** jack.
- If you wish to use this connection method when the projector is in standby mode, make sure the **MONITOR OUT** function is turned on in the **SYSTEM SETUP: Advanced > Standby Settings** menu. See **"Standby Settings" on page 61** for details.

## Connecting Video source devices

You need only connect the projector to a Video source device using just one of the above connecting methods, however each provides a different level of video quality. The method you choose will most likely depend upon the availability of matching terminals on both the projector and the Video source device as described below:

	Terminal	Picture quality
HDMI 1/HDMI 2/MHL	HDMI 1/HDMI 2/MHL 	Best
Component Video	PC IN 	Better
S-Video	S-VIDEO 	Good
Video	VIDEO 	Normal

## Connecting audio

The projector has built-in mono speaker(s) which are designed to provide basic audio functionality accompanying data presentations for business purposes only. They are not designed for, nor intended for stereo audio reproduction use as might be expected in home theater or home cinema applications. Any stereo audio input (if

provided), is mixed into a common mono audio output through the projector speaker(s).

The built-in speaker(s) will be muted when the **AUDIO OUT** jack is connected.

☞ If the selected video image is not displayed after the projector is turned on and the correct video source has been selected, check that the Video source device is turned on and operating correctly. Also check that the signal cables have been connected correctly.

## Connecting smart device

The projector can project the content directly from a smart device by using a wireless dongle.

**HDMI wireless dongle (e.g. BenQ QCastMirror, QCast)**

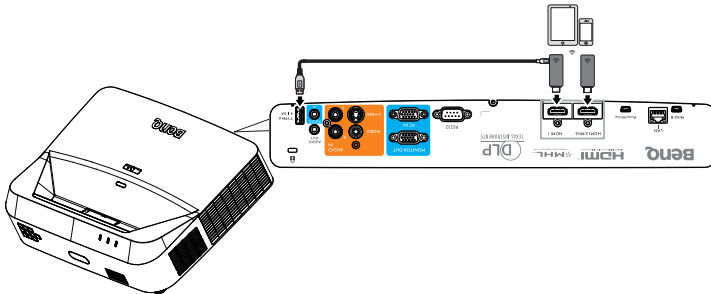

- Connect the dongle to **HDMI** and **USB TYPE-A** ports on the projector and switch the input signal to **HDMI-1**.
- Connect the dongle to **HDMI2/MHL** port on the projector and switch the input signal to **HDMI-2/MHL**.

# Operation

## Starting up the projector

1. Plug the power cord into the projector and into a power outlet. Check that the **POWER indicator light** on the projector lights orange after power has been applied.

 • **Please use the original accessories (e.g. power cable) only with the device to avoid possible dangers such as electric shock and fire.**

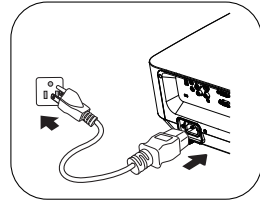



- If **Direct Power On** function is activated in the **SYSTEM SETUP: Basic > Operation Settings** menu, the projector will turn on automatically after the power cord has been connected and power has been applied. See "**Direct Power On**" on page 59 for details.
- If **Signal Power On** function is activated in the **SYSTEM SETUP: Basic > Operation Settings** menu, the projector will turn on automatically when **VGA** signal is detected. See "**Signal Power On**" on page 59 for details.

2. Press  **Power** on the projector or **ON** on the remote control to start the projector. The **POWER indicator light** flashes and stays green when the projector is on.

The start up procedure takes about 10-20 seconds. In the later stage of start up, a startup logo is projected.

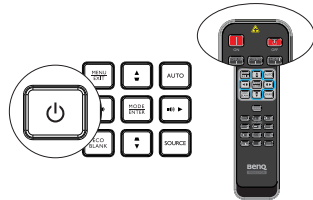
(If necessary) Use the focus ring to adjust the image clearness.



 If the projector is still hot from previous activity, it will run the cooling fan for approximately 90 seconds before energizing the light.

3. If the projector is activated for the first time, select your OSD language following the on-screen instructions.
4. If you are prompted for a password, press the arrow keys to enter a six digit password. See "**Utilizing the password function**" on page 28 for details.
5. Switch all of the connected equipment on.
6. The projector will start to search for input signals. The current input signal being scanned displays in the screen. If the projector doesn't detect a valid signal, the message '**No Signal**' will continue displaying until an input signal is found.



You can also press **SOURCE** on the projector or remote control to select your desired input signal. See ["Switching input signal" on page 30](#) for details.

- ☞ If no signal is detected for 3 minutes, the projector automatically enters **ECO BLANK** mode.

## Adjusting the projected image

### Auto-adjusting the image

In some cases, you may need to optimize the picture quality. To do this, press **AUTO** on the projector or remote control. Within 5 seconds, the built-in Intelligent Auto Adjustent function will re-adjust the values of Frequency and Clock to provide the best picture quality.

- ☞ The screen will display "Auto adjusting" while **AUTO** is functioning.
- This function is only available when **PC signal (analog RGB)** is selected.

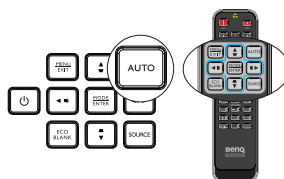

### Fine-tuning the image clarity

Sharpen the image by rotating the focus ring.

If the projector is not placed on a flat surface or the screen and the projector are not perpendicular to each other, the projected image becomes trapezoidal. To correct this situation, see ["Correcting 2D keystone" on page 24](#) for details.

- ⚠ Do not look into the lens while the light is on. The strong light from the light may cause damage to your eyes.

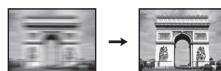

### Correcting 2D keystone

2D Keystone function enables a wider projector installation area compared to conventional projectors with limited positioning in front of the screen.

To correct this, you will need to manually correct it following one of these steps.

- Using the projector or remote control

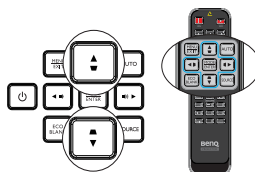



Press  $\blacktriangledown/\blacktriangle$  on the projector or  $\blacktriangledown/\blacktriangle/\blacktriangleright/\blacktriangleleft$  on the remote control to display the **2D Keystone** page. Press  $\blacktriangledown/\blacktriangle$  to adjust vertical values from -20 to 20. Press  $\blacktriangleleft/\blacktriangleright$  to adjust horizontal values from -20 to 20.

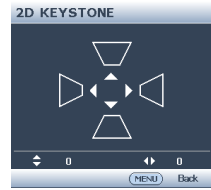

- Using the OSD menu
  1. Press **MENU/EXIT** and select the **DISPLAY** menu.
  2. Press  $\blacktriangledown$  to select **2D Keystone** and press **MODE/ENTER**.
  3. Press  $\blacktriangle/\blacktriangledown/\blacktriangleleft/\blacktriangleright$  to adjust the keystone values.

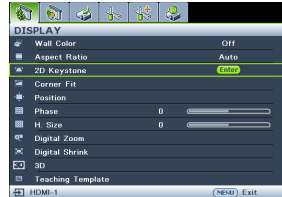

- Using the **QUICK INSTALL** key
  1. Press **QUICK INSTALL** on the remote control.
  2. Press  $\blacktriangledown$  to select **2D Keystone** and press **MODE/ENTER**.
  3. Press  $\blacktriangle/\blacktriangledown/\blacktriangleleft/\blacktriangleright$  to adjust the keystone values.

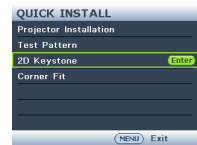

## Adjusting Corner Fit

Manually adjust four corners of the image by setting the horizontal and vertical values.

- Using the OSD menu
  1. Select **Corner Fit** in the **DISPLAY** menu and press **MODE/ENTER**.
  2. Press  $\blacktriangle/\blacktriangledown/\blacktriangleleft/\blacktriangleright$  to select one of the four corners and press **MODE/ENTER**.

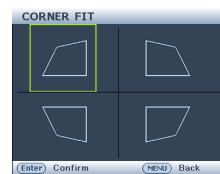

3. Press ▲/▼ to adjust vertical values from 0 to 60.
  4. Press ◀/▶ to adjust horizontal values from 0 to 60.
- Using the **QUICK INSTALL** key

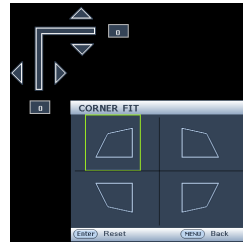

1. Press **QUICK INSTALL** on the remote control.
2. Press ▼ to select **Corner Fit** and press **MODE/ENTER**.
3. Follow the steps 2~4 in the above section.

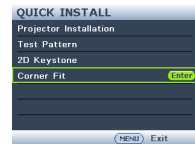

# Using the menus

The projector is equipped with On-Screen Display (OSD) menus for making various adjustments and settings.

Below is the overview of the OSD menu.

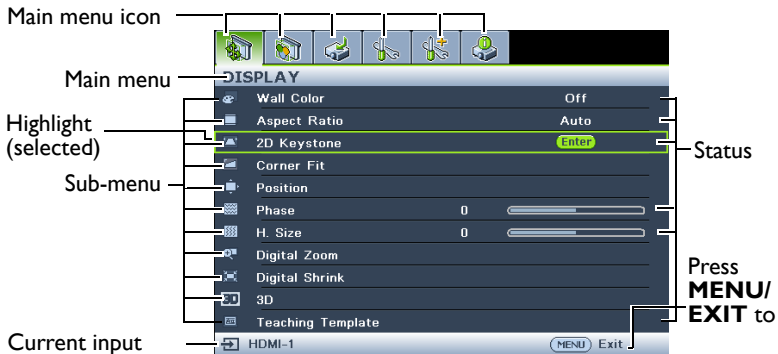

The following example describes how to set the OSD menu.

1. Press **MENU/EXIT** on the projector or remote control to turn the OSD menu on.
3. Press **▼** to select **Background Color** and press **◀/▶** to select a background color.



2. Use **◀/▶** to select the **SYSTEM SETUP: Basic** menu.
4. Press **MENU/EXIT** twice\* on the projector or remote control to leave and save the settings.  
\*The first press leads you back to the main menu and the second press closes the OSD menu.



# Securing the projector

## Using a security cable lock

The projector has to be installed in a safe place to prevent theft. Otherwise, purchase a lock, such as the Kensington lock, to secure the projector. You can locate a Kensington lock slot on the rear side of the projector. See item 24 on page 8 for details.

A Kensington security cable lock is usually a combination of key(s) and the lock. Refer to the lock's documentation for finding out how to use it.

## Utilizing the password function

For security purposes and to help prevent unauthorized use, the projector includes an option for setting up password security. The password can be set through the On-Screen Display (OSD) menu.

**WARNING:** You will be inconvenienced if you activate the power-on lock functionality and subsequently forget the password. Print out this manual (if necessary) and write the password you used in this manual, and keep the manual in a safe place for later recall.

## Setting a password

Once a password has been set, the projector cannot be used unless the correct password is entered every time the projector is started.

1. Open the OSD menu and go to the **SYSTEM SETUP: Advanced > Security Settings** menu. Press **MODE/ENTER**.

2. Press **▼** to select **Change Security Settings** and press **MODE/ENTER**.

3. Enter the new or current password. As pictured to the right, the four arrow keys (**▲**, **▶**, **▼**, **◀**) respectively represent 4 digits (1, 2, 3, 4). According to the password you desire to set, press the arrow keys to enter six digits for the password.

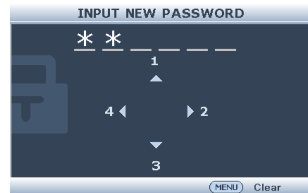

If the function is used for the first time, enter the default password (1, 1, 1, 1, 1, 1) of the projector by pressing the arrow key **▲** six times.

4. Confirm the new password by re-entering the new password. Once the password is set, the OSD menu returns to the **Security Settings** page.

**IMPORTANT:** The digits being input will display as asterisks on-screen. Write your selected password down here in this manual in advance or right after the password is entered so that it is available to you should you ever forget it.

Password: \_\_\_\_\_

Keep this manual in a safe place.

5. Press **▼** to select **Power On Lock** and select **On** by pressing **◀/▶**.

6. To leave the OSD menu, press **MENU/EXIT**.

## If you forget the password

If the password function is activated, you will be asked to enter the six-digit password every time you turn on the projector. If you enter the wrong password, the password error message as pictured to the right displays lasting for three seconds, and the message 'INPUT PASSWORD' follows. You can retry by entering another six-digit password, or if you did not record the password in this manual, and you absolutely do not remember it, you can use the password recall procedure. See "[Entering the password recall procedure](#)" on page 29 for details.

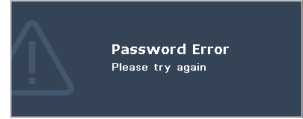

If you enter an incorrect password 5 times in succession, the projector will automatically shut down in a short time.

## Entering the password recall procedure

1. Press and hold **AUTO** on the projector or remote control for 3 seconds. The projector will display a coded number on the screen.
2. Write down the number and turn off your projector.
3. Seek help from the local BenQ service center to decode the number. You may be required to provide proof of purchase documentation to verify that you are an authorized user of the projector.

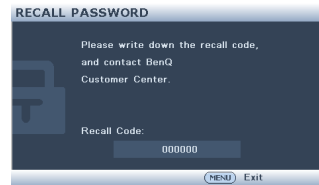

## Changing the password

1. Open the OSD menu and go to the **SYSTEM SETUP: Advanced > Security Settings**.
2. Select **Change Password** and press **MODE/ENTER**. The message '**INPUT CURRENT PASSWORD**' displays.
3. Enter the old password.
  - If the password is correct, another message '**INPUT NEW PASSWORD**' displays.
  - If the password is incorrect, the password error message displays lasting for three seconds, and the message '**INPUT CURRENT PASSWORD**' displays for your retry. You can press **MENU/EXIT** to cancel the change or try another password.
4. Enter a new password.



**IMPORTANT:** The digits being input will display as asterisks on-screen. Write your selected password down here in this manual in advance or right after the password is entered so that it is available to you should you ever forget it.

Password: \_\_\_\_\_

Keep this manual in a safe place.

5. Confirm the new password by re-entering the new password.
6. You have successfully assigned a new password to the projector. Remember to enter the new password next time the projector is started.

7. To leave the OSD menu, press **MENU/EXIT**.

## Disabling the password function

To disable password protection, go back to the **SYSTEM SETUP: Advanced > Security Settings > Change Security Settings** menu after opening the OSD menu system and press **MODE/ENTER**. The message **'INPUT PASSWORD'** displays. Enter the current password.

- If the password is correct, the OSD menu returns to the **Security Settings** page. Select **Power On Lock** and select **Off** by pressing **◀/▶**. You will not have to enter the password next time you turn on the projector.
- If the password is incorrect, the password error message displays lasting for three seconds, and the message **'INPUT PASSWORD'** displays for your retry. You can press **MENU/EXIT** to cancel the change or try another password.

 Though the password function is disabled, you need to keep the old password in hand should you ever need to re-activate the password function by entering the old password.

## Switching input signal

The projector can be connected to multiple devices at the same time. However, it can only display one full screen at a time. When starting up, the projector automatically searches for the available signals.

Be sure the **Quick Auto Search** function in the **SOURCE** menu is **On** (which is the default of this projector) if you want the projector to automatically search for the signals.

You can also manually cycle through the available input signals.

1. Press **SOURCE** on the projector or remote control. A source selection bar displays.

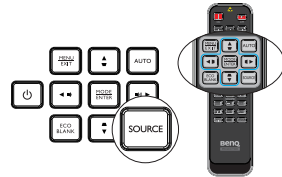

2. Press **▲/▼** until your desired signal is selected and press **MODE/ENTER**. Once detected, the selected source information will display on the screen for seconds. If there is multiple equipment connected to the projector, repeat steps 1-2 to search for another signal.



-  • **The brightness level of the projected image will change accordingly when you switch between different input signals. Data (graphic) "PC" presentations using mostly static images are generally brighter than "Video" using mostly moving images (movies).**
- **The input signal type effects the options available for the Picture Mode. See ["Selecting a picture mode" on page 33](#) for details.**

- For best display picture results, you should select and use an input signal which outputs at this resolution. Any other resolutions will be scaled by the projector depending upon the 'aspect ratio' setting, which may cause some image distortion or loss of picture clarity. See "[Selecting the aspect ratio](#)" on page 31 for details.

## Magnifying and searching for details

If you need to find the details on the projected picture, magnify the picture. Use the direction arrow keys for navigating the picture.

- Using the **Digital Zoom** function
  1. Press **MENU/EXIT** and then press ◀/▶ until the **DISPLAY** menu is selected.
  2. Press ▼ to select **Digital Zoom** and press **MODE/ENTER**. The Zoom bar displays.
  3. Press ▲ on the projector repeatedly to magnify the picture to a desired size.
  4. To navigate the picture, press **MODE/ENTER** to switch to the panning mode and press the directional arrows (▲, ▼, ◀, ▶) to navigate the picture.
  5. To reduce size of the picture, press **MODE/ENTER** to switch back to the zoom in/out functionality, and press **AUTO** to restore the picture to its original size. You can also press ▼ repeatedly until it is restored to the original size.

☞ The picture can only be navigated after the picture is magnified. You can further magnify the picture while searching for details.

## Selecting the aspect ratio

The 'aspect ratio' is the ratio of the image width to the image height.

With the advent of digital signal processing, digital display devices like this projector can dynamically stretch and scale the image output to a different aspect than that of the image input signal.

To change the projected image ratio (no matter what aspect the source is):

- Using the remote control
  1. Press **Aspect** to show the current setting.
  2. Press **Aspect** repeatedly to select an aspect ratio to suit the format of the video signal and your display requirements.



- Using the OSD menu
  1. Press **MENU/EXIT** and then press ◀/▶ until the **DISPLAY** menu is selected.
  2. Press ▼ to select **Aspect Ratio**.
  3. Press ◀/▶ to select an aspect ratio to suit the format of the video signal and your display requirements.

## About the aspect ratio

There are several options to set the image's aspect ratio depending on your input signal source.

1. **Auto:** Scales an image proportionally to fit the projector's native resolution in its horizontal or vertical width.

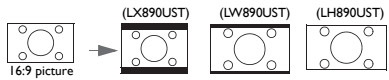

2. **Real:** Projects an image as its original resolution and resizes it to fit within the display area. For input signals with lower resolutions, the projected image will be displayed in its original size.

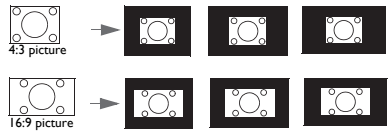

3. **4:3:** Scales an image so that it is displayed in the center of the screen with a 4:3 aspect ratio.

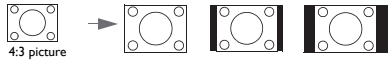

4. **16:9:** Scales an image so that it is displayed in the center of the screen with a 16:9 aspect ratio.

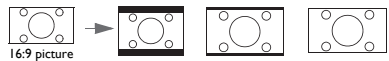

5. **16:10:** Scales an image so that it is displayed in the center of the screen with a 16:10 aspect ratio.

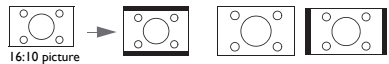

6. **16:6:** Scales an image so that it is displayed in the center of the screen with a 16:6 aspect ratio. (Only available on education 1080p model)





# Optimizing the image

## Selecting a picture mode

The projector is preset with several predefined picture modes so that you can choose one to suit your operating environment and input signal picture type.

To select an operation mode that suits your need, you can follow one of the following steps.

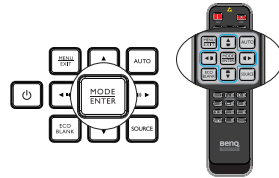

- Press **MODE/ENTER** on the remote control or projector repeatedly until your desired mode is selected.
- Go to the **PICTURE > Picture Mode** menu and press **◀/▶** to select a desired mode.

The picture modes are listed below.

1. **Bright mode:** Maximizes the brightness of the projected image. This mode is suitable for environments where extra-high brightness is required, such as using the projector in well lit rooms.
2. **Presentation mode (Default):** Is designed for presentations. The brightness is emphasized in this mode.
3. **Vivid mode:** This is suitable for displaying colorful video and pictures with well-balanced color saturation and high color brightness
4. **sRGB mode:** Maximizes the purity of RGB colors to provide true-to-life images regardless of brightness setting. It is most suitable for viewing photos taken with an sRGB compatible and properly calibrated camera, and for viewing PC graphic and drawing applications such as AutoCAD.
5. **Cinema mode:** Is appropriate for playing colorful movies, video clips from digital cameras or DVs through the PC input for best viewing in a blackened (little light) environment.
6. **User 1/User 2 mode:** Recalls the settings customized based on the current available picture modes. See "[Setting the User 1/User 2 mode](#)" on page 33 for details.

## Setting the User 1/User 2 mode

There are two user-definable modes if the current available picture modes are not suitable for your need. You can use one of the picture modes (except the User 1/User 2) as a starting point and customize the settings.

1. Press **MENU/EXIT** to open the On-Screen Display (OSD) menu.
2. Go to the **PICTURE > Picture Mode** menu.
3. Press **◀/▶** to select User 1 to User 2.
4. Press **▼** to select **Reference Mode**.

 **This function is only available when User 1 or User 2 mode is selected up in the Picture Mode sub-menu item.**

5. Press **◀/▶** to select a picture mode that is closest to your need.

- Press ▼ to select a sub-menu item to be changed and adjust the value with ◀/▶. See "Fine-tuning the image quality in user modes" below for details.
- The settings will be saved when selecting.

## Using Wall Color

In the situation where you are projecting onto a colored surface such as a painted wall which may not be white, the **Wall Color** feature can help correct the projected picture's color to prevent possible color difference between the source and projected pictures.

To use this function, go to the **DISPLAY > Wall Color** menu and press ◀/▶ to select a color which is the closest to the color of the projection surface. There are several precalibrated colors to choose from: Light Yellow, Pink, Light Green, Blue, and Blackboard.

## Fine-tuning the image quality in user modes

According to the detected signal type, there are some user-definable functions available when User 1 or User 2 mode is selected. Based on your needs, you can make adjustments to these functions by selecting them and pressing ◀/▶ on the projector or remote control.

### Adjusting Brightness

The higher the value, the brighter the image. And the lower the setting, the darker the image. Adjust this control so the black areas of the image appear just as black and that detail in the dark areas is visible.



### Adjusting Contrast

The higher the value, the greater the contrast. Use this to set the peak white level after you have previously adjusted the **Brightness** setting to suit your selected input and viewing environment.



You can also adjust **Brightness** or **Contrast** by using **BRIGHT** or **CONTRAST** key on the remote control.



### Adjusting Color

Lower setting produces less saturated colors. If the setting is too high, colors on the image will be overpowering, which makes the image unrealistic.

### Adjusting Tint

The higher the value, the more reddish the picture becomes. The lower the value, the more greenish the picture becomes.

### Adjusting Sharpness

The higher the value, the sharper the picture becomes. The lower the value, the softer the picture becomes.

### Adjusting Brilliant Color

This feature utilizes a new color-processing algorithm and system level enhancements to enable higher brightness while providing truer, more vibrant colors in picture. It enables a greater than 50% brightness increase in mid-tone images, which are

common in video and natural scenes, so the projector reproduces images in realistic and true colors. If you prefer images with that quality, select **On**. If you don't need it, select **Off**.

**On** is the default and recommended selection for this projector. When **Off** is selected, the **Color Temperature** function is not available.

### Selecting a Color Temperature

The options available for color temperature\* settings vary according to the signal type selected.

1. **Cool:** Makes images appear bluish white.
2. **Normal:** Maintains normal colorings for white.
3. **Warm:** Makes images appear reddish white.

#### \*About color temperatures:

There are many different shades that are considered to be "white" for various purposes. One of the common methods of representing white color is known as the "color temperature". A white color with a low color temperature appears to be reddish white. A white color with a high color temperature appears to have more blue in it.

### Setting a preferred color temperature

To set a preferred color temperature:

1. Select **Color Temperature** and select **Warm, Normal** or **Cool** by pressing **◀/▶** on the projector or remote control.
2. Press **▼** to select **Color Temperature Fine Tuning** and press **MODE/ENTER**. The Color Temperature Fine Tuning page displays.
3. Press **▲/▼** to select the item you want to change and adjust the values by pressing **◀/▶**.
  - **R Gain/G Gain/B Gain:** Adjusts the contrast levels of Red, Green, and Blue.
  - **R Offset/G Offset/B Offset:** Adjusts the brightness levels of Red, Green, and Blue.
4. Press **MENU/EXIT** to exit and save the settings.

### 3D Color Management

In most installation situations, color management will not be necessary, such as in classroom, meeting room, or lounge room situations where lights remain on, or where building external windows allow daylight into the room.

Only in permanent installations with controlled lighting levels such as boardrooms, lecture theaters, or home theaters, should color management be considered. Color management provides fine color control adjacent to allow for more accurate color reproduction, should you require it.

Proper color management can only be achieved under controlled and reproducible viewing conditions. You will need to use a colorimeter (color light meter), and provide a set of suitable source images to measure color reproduction. These tools are not provided with the projector, however, your projector supplier should be able to provide you with suitable guidance, or even an experienced professional installer.

The Color Management provides six sets (RGBCMY) of colors to be adjusted. When you select each color, you can independently adjust its range and saturation according to your preference.

If you have purchased a test disc which contains various color test patterns and can be used to test the color presentation on monitors, TVs, projectors, etc. You can project any image from the disc on the screen and enter the **3D Color Management** menu to make adjustments.

To adjust the settings:

1. Go to the **PICTURE** menu and select **3D Color Management**.
2. Press **MODE/ENTER** and the **3D Color Management** page displays.
3. Select **Primary Color** and press **◀/▶** to select a color from among Red, Yellow, Green, Cyan, Blue, or Magenta.
4. Press **▼** to select **Hue** and press **◀/▶** to select its range. Increase in the range will include colors consisted of more proportions of its two adjacent colors. Please refer to the illustration to the right for how the colors relate to each other. For example, if you select Red and set its range at 0, only pure red in the projected picture will be selected. Increasing its range will include red close to yellow and red close to magenta.
5. Press **▼** to select **Saturation** and adjust its values to your preference by pressing **◀/▶**. Every adjustment made will reflect to the image immediately. For example, if you select Red and set its value at 0, only the saturation of pure red will be affected.

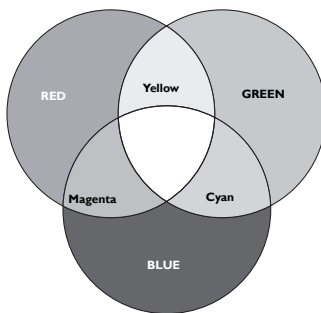

☞ • **Saturation** is the amount of that color in a video picture. Lower settings produce less saturated colors; a setting of “0” removes that color from the image entirely. If the saturation is too high, that color will be overpowering and unrealistic.

6. Press **▼** to select **Gain** and adjust its values to your preference by pressing **◀/▶**. The contrast level of the primary color you select will be affected. Every adjustment made will reflect to the image immediately.
7. Repeat steps 3 to 6 for other color adjustments.
8. Make sure you have made all of the desired adjustments.
9. Press **MENU/EXIT** to exit and save the settings.

Resetting current or all picture modes

1. Go to the **PICTURE** menu and select **Reset Picture Settings**.
2. Press **MODE/ENTER** and press **▲/▼** to select **Current** or **All**.
  - **Current**: returns current picture mode to the factory preset settings.
  - **All**: returns all settings, except **User 1/User 2** in the **PICTURE** menu to the factory preset settings.

# Setting the presentation timer

The presentation timer can indicate the presentation time on the screen to help you achieve better time management when giving presentations. Follow these steps to utilize this function:

1. Go to the **SYSTEM SETUP: Basic > Presentation Timer** menu and press **MODE/ENTER** to display the **Presentation Timer** page.
2. Select **Timer Period** and decide the timer period by pressing ◀/▶. The length of time can be set from 1 to 5 minutes in 1-minute increments and 5 to 240 minutes in 5-minute increments.
3. Press ▼ to select **Timer Display** and choose if you want the timer to show up on the screen by pressing ◀/▶.

Selection	Description
Always	Displays the timer on screen throughout the presentation time.
1 Min/2 Min/3 Min	Displays the timer on screen in the last 1/2/3 minute(s).
Never	Hides the timer throughout the presentation time.

4. Press ▼ to select **Timer Position** and set the timer position by pressing ◀/▶.  
**Top-Left → Bottom-Left → Top-Right → Bottom-Right**
5. Press ▼ to select **Timer Counting Direction** and select your desired counting direction by pressing ◀/▶.

Selection	Description
Count Up	Increases from 0 to the preset time.
Count Down	Decrease from the preset time to 0.

6. Press ▼ to select **Sound reminder** and decide if you want to activate sound reminder by pressing ◀/▶. If you select **On**, a double beep sound will be heard at the last 30 seconds of counting down/up, and a triple beep sound will be produced when the timer is up.
7. To activate the presentation timer, press ▼ and press ◀/▶ to select **On** and press **MODE/ENTER**.
8. A confirmation message displays. Select **Yes** and press **MODE/ENTER** to confirm. You will see the message "**Timer is On**" displaying on the screen. The timer starts counting at the time the timer is on.

## To cancel the timer, perform the following steps:

1. Go to the **SYSTEM SETUP: Basic > Presentation Timer** menu and press select ▼ to select **Off**. Press **MODE/ENTER**. A confirmation message displays.

2. Select **Yes** and press **MODE/ENTER** to confirm. You will see the message “**Timer is Off!**” displaying on the screen.

## Hiding the image

In order to draw the audience's full attention to the presenter, you can use **ECO BLANK** to hide the screen image and the light source power will be off. Press any key on the projector or remote control to restore the image. When this function is activated with an audio input connected, the audio can still be heard.

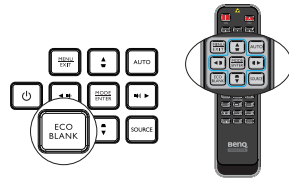

You can set the blank time in the **SYSTEM SETUP: Basic > Operation Settings > Blank**

**Timer** menu to let the projector return the image automatically after a period of time when there is no action taken on the blank screen. The length of time can be set from 5 to 30 minutes in 5-minute increments.

- ⚠ • **Do not block the projection lens from projecting as this could cause the blocking object to become heated.**
- **No matter Blank Timer is activated or not, you can press any key on the projector or remote control to restore the picture.**

## Freezing the image

Press **FREEZE** on the remote control to freeze the image. The word 'FREEZE' will display in the screen. To release the function, press any key on the projector or remote control.

Even if an image is frozen on the screen, the pictures are running on the video or other device. If the connected devices have active audio output, you will still hear the audio even though the image is frozen on screen.



## Operating in a high altitude environment

We recommend you use the **High Altitude Mode** when your environment is between 1500 m –3000 m above sea level, and ambient temperature is between 0°C–35°C.

- ⚠ **Do not use the High Altitude Mode if your altitude is between 0 m and 1500 m and ambient temperature is between 0°C and 35°C. The projector will be over cooled, if you turn the mode on under such a condition.**

To activate the **High Altitude Mode**:

1. Press **MENU/EXIT** and then press ◀/▶ until the **SYSTEM SETUP: Advanced** menu is selected.
2. Press ▼ to select **High Altitude Mode** and press ◀/▶ to select **On**. A confirmation message displays.

3. Select **Yes** and press **MODE/ENTER**.

Operation under "**High Altitude Mode**" may cause a higher decibel operating noise level because of increased fan speed necessary to improve overall system cooling and performance.

If you use this projector under other extreme conditions excluding the above, it may display auto shut-down symptoms, which is designed to protect your projector from over-heating. In cases like this, you should switch to High Altitude mode to solve these symptoms. However, this is not to state that this projector can operate under any and all harsh or extreme conditions.

## Adjusting the sound

The sound adjustments made as below will have an effect on the projector speaker(s). Be sure you have made a correct connection to the projector audio input. See "[Connection](#)" on page 20 for how the audio input is connected.

### Muting the sound

To adjust the sound level, press **MUTE** on the remote control, or:

1. Press **MENU/EXIT** and then press **◀/▶** until the **SYSTEM SETUP: Advanced** menu is selected.
2. Press **▼** to select **Audio Settings** and press **MODE/ENTER**. The Audio Settings page displays.
3. Select **Mute** and select **On**.



### Adjusting the sound level

To adjust the sound level, press **VOLUME** on the remote control or on the projector, or:

1. Repeat steps 1-2 above.
2. Select **Volume** and select a desired sound level.

### Turning off the Power on/off ring tone

To turn off the ring tone:

1. Repeat steps 1-2 in Muting the sound section.
2. Select **Power On/Off Ring Tone** and select **Off**.

 **The only way to change Power on/off ring tone is setting On or Off here. Setting the sound mute or changing the sound level will not affect the Power on/off ring tone.**

## Setting Auto Power Off

This function allows the projector to turn off automatically if no input source is detected after a set period of time to prevent unnecessary waste of light life.

To set **Auto Power Off**, go into the **SYSTEM SETUP: Basic > Operation Settings > Auto Power Off** menu and press **◀/▶**. The time period can be set from 5 to 30 minutes in 5-minute increments. If the preset time lengths are not suitable for your presentation, select **Disable**. The projector will not automatically shut down in a certain time period.

# Personalizing the projector menu display

The On-Screen Display (OSD) menus can be set according to your preferences. The following settings do not affect the projection settings, operation, or performance.

- **Language** in the **SYSTEM SETUP: Basic** menu sets your familiar language for the OSD menus. Press **MODE/ENTER** to display language page. Use **▲/▼/◀/▶** and **MODE/ENTER** to select your language.
- **Menu Display Time** in the **SYSTEM SETUP: Basic > Menu Settings** menu sets the length of time the OSD will remain active after your last key press. The time length ranges from 5 to 30 seconds in 5-second increments. Use **◀/▶** to select a suitable time frame.
- **Menu Position** in the **SYSTEM SETUP: Basic > Menu Settings** menu sets the OSD position in five locations. Use **◀/▶** to select a preferred position.
- **Reminder Message** in the **SYSTEM SETUP: Basic > Menu Settings** menu sets whether to display reminder messages on screen. Use **◀/▶** to select your desired setting.
- **Splash Screen** in the **SYSTEM SETUP: Basic** menu sets a preferred logo screen to be displayed during projector start-up. Use **◀/▶** to select a screen.

## Select the Light Mode

- Using the remote control.

Press **LAMP MODE** and the light mode selection bar appears. Use **▲/▼** to select **Normal/Economic/Dimming**.

- Using the OSD menu.

1. Press **MENU/EXIT** and then press **◀/▶** until the **SYSTEM SETUP: Advanced** menu is selected.
2. Press **▼** to select **Light Settings** and press **MODE/ENTER**. The **Light Settings** page displays.
3. Select **Light Mode** and press **◀/▶** to select Normal/Economic/Dimming. The light brightness vary from the different light mode, see the description list in table below.



Light Mode	Description
Normal	Provides full light brightness
Economic	Lowers brightness to extend the light source life and decreases the fan noise
Dimming	Lowers brightness to offer a longer light source life.

 If the **Economic mode** or **Dimming mode** is selected, the light output will be reduced and result in darker projected pictures.



# Use Teaching Template

Making writing on the board easier for teachers, you can use build-in template by OSD.



Open the OSD menu and go to the **DISPLAY > Teaching Template**. Choose **Blackboard/Whiteboard > Off/Letter Formation/Worksheet/Coordinate Chart**. The Teaching Template displays.

Teaching Template	Whiteboard	Blackboard
<b>Letter Formation</b>		
<b>Worksheet</b>		
<b>Coordinate Chart</b>		

# Controlling the projector through a LAN environment

Wired LAN allows you to manage the projector from a computer using a web browser when the computer and the projector are properly connected to the same local area network.

## Configuring the Wired LAN Settings

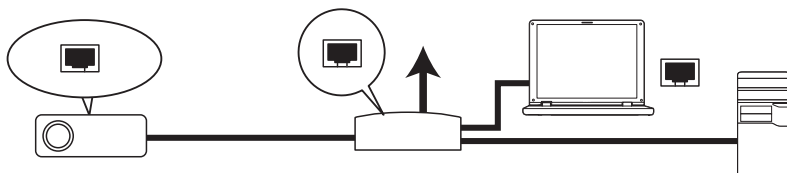

### If you are in a DHCP environment:

1. Take a RJ45 cable and connect one end to the LAN input jack of the projector and the other end to the RJ45 port.

 **When connecting the RJ45 cable, avoid coiling and intertwining the cable as it may cause signal noise or interruption.**

2. Press **MENU/EXIT** and then press **◀/▶** until the **SYSTEM SETUP: Advanced** menu is selected.
3. Press **▼** to select **Network Settings** and press **MODE/ENTER**. The **Network Settings** page displays.
4. Press **▼** to select **Wired LAN** and press **MODE/ENTER**. The **Wired LAN** page is displayed.
5. Press **▼** to select **DHCP** and press **◀/▶** to select **On**.
6. Please wait for around 15 - 20 seconds, and then re-enter the **Wired LAN** page.
7. The **IP Address**, **Subnet Mask**, **Default Gateway**, and **DNS Server** settings will be displayed. Note down the IP address displayed in the **IP Address** row.

 **If the IP Address still does not display, contact your ITS administrator.**

8. Go back to **SYSTEM SETUP: Advanced > Network Settings** page.
9. Press **▼** to highlight **AMX Device Discovery** and press **◀/▶** to select **On** or **Off**. When **AMX Device Discovery** is **On**, the projector can be detected by AMX controller.

### If you are in a non-DHCP environment:

1. Repeat steps 1-4 above.
2. Press **▼** to select **DHCP** and press **◀/▶** to select **Off**.
3. Contact your ITS administrator for information on the **IP Address**, **Subnet Mask**, **Default Gateway**, and **DNS Server** settings.
4. Press **▼** to select the item you want to modify and press **MODE/ENTER**.

5. Press ◀/▶ to move the cursor and then press ▲/▼ to enter the value.
6. To save the setting, press **MODE/ENTER**. If you do not want to save the setting, press **MENU/EXIT**.
7. Press ▼ to highlight Apply and press **MODE/ENTER**.
8. Press **MENU/EXIT** to return to **Network Settings** page, press ▼ to highlight **AMX Device Discovery** and press ◀/▶ to select **On** or **Off**.
9. Press **MENU/EXIT** to exit the menu.

## Controlling the projector remotely through a web browser

Once you have the correct IP address for the projector and the projector is on or in standby mode, you can use any computer that is on the same local area network to control the projector.

1. Enter the address of the projector in the address bar of your browser and click Go.



2. The remote network operation page opens. This page (Crestron eControl) allows you to operate the projector as if you were using the remote control or control panel on the projector.



1	<p>To switch input source, click on your desired signal.</p> <p> <b>The source list varies according to the connectors available on the projector. "Video" stands for the Video signal.</b></p>
---	--

2	Menu Auto PC Blank Input ▲ (▼) ▼ (▲) ◀ (▶) ▶ (◀)	See "Remote control" on page 10 for details.
	OK	Activates the selected On-Screen Display (OSD) menu item.

The tools page allows you to manage the projector, configure the LAN control settings and secure access of remote network operation on this projector.

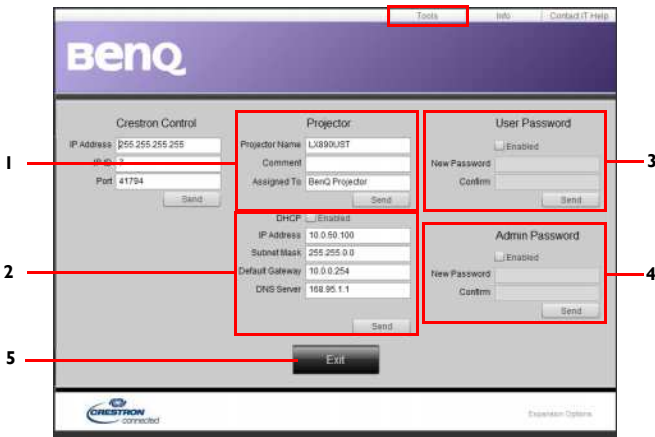

1. You can name the projector, keep track of its location and the person in charge of it.
2. You can adjust the **LAN Control Settings**.
3. Once set, access to the remote network operation on this projector has been password protected.
4. Once set, access to the tools page has been password-protected.
5. Press **Exit** to go back to the remote network operation page.

☞ **After making the adjustments, press the Send button and the data will be saved in the projector**

Please pay attention to the limitation of input length (including space and other punctuation keys) in the list blow:

Category item	Input length	Maximum number of characters
Crestron Control	IP Address	15
	IP ID	4
	Port	5
Projector	Projector Name	22
	Location	22
	Assigned To	(N/A)
Network Configuration	DHCP (Enabled)	15
	IP Address	15
	Subnet Mask	15
	Default Gateway	15
	DNS Server	(N/A)
User Password	Enabled	(N/A)
	New Password	15
	Confirm	15
Admin Password	Enabled	(N/A)
	New Password	15
	Confirm	15

The info page displays the information and status of this projector.

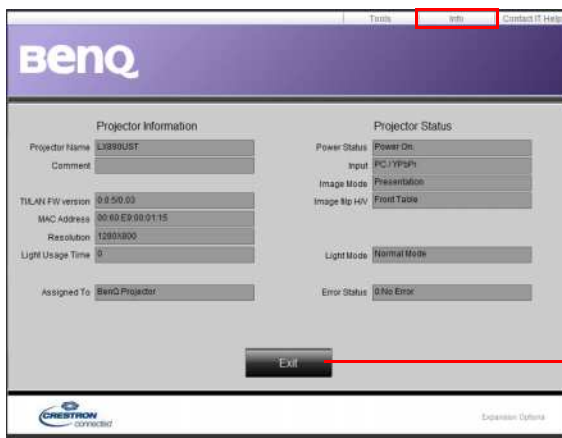

Press **Exit** to go back to the remote network operation page.

For more information, visit <http://www.crestron.com> & [www.crestron.com/getroomview](http://www.crestron.com/getroomview).

## Upgrading firmware via LAN

The BenQ Easy Firmware Updater is a software program that enables remote and centralized upgrade the BenQ network projector on a host computer.

The key features of the BenQ Easy Firmware Updater include:

- Search for projectors in the different subnet.
- Support multiple projectors firmware upgrade at the same time (up to 255).

For more information about the tool, please contact BenQ service.

# Installing PointWrite Module on Projector to use interaction function

You can install a PointWrite module (PW40U, an optional accessory sold independently) on the projector to start the interactive function.

## Camera Installation on Projector

Make sure the PointWrite camera is installed properly before you active interactive function.

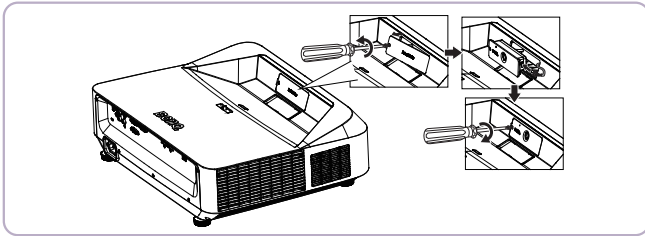

Use the USB cable to connect the projector to PC. Plug the USB mini-B end into the projector and plug the USB type-A end into PC.

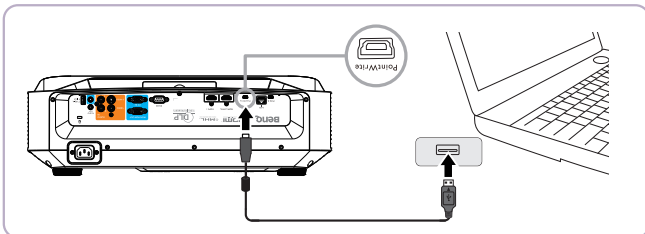

Check “Device Manager” from your computer to make sure that PointWrite device is recognized by your computer.



When finishing the PointWrite Module Installation, please refer to the PW40U User manual for further instruction.

# Shutting down the projector

1. Press **Power** on the projector. A confirmation message displays prompting you.  
If you don't respond in a few seconds, the message will disappear. If you use the remote control, press OFF to shut down the projector.

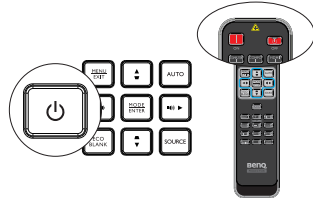

2. Press **Power** on the projector a second time. The **POWER indicator light** flashes orange, the projection light shuts down, and the fans will continue to run to cool down the projector.



- **To protect the light, the projector will not respond to any commands during the cooling process.**

3. Once the cooling process finishes, the **POWER indicator light** is a steady orange and fans stop.
4. Disconnect the power cord from the power outlet if the projector will not be used in an extended period of time.



- **If the projector is not properly shut down, to protect the light, when you attempt to re-start the projector, the fans will run for a few minutes to cool down. Press Power again to start the projector after the fans stop and the POWER indicator light turns orange.**

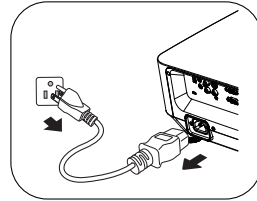

- **Actual light lives may vary due to different environmental conditions and usage.**



# Menu operation

## Menu system

Please note that the on-screen display (OSD) menus vary according to the signal type selected.

### I. DISPLAY menu

Sub-menu	Sub-menu item/Options			
<b>Wall Color</b>	<b>Off</b> /Light Yellow/Pink/Light Green/Blue/Blackboard			
<b>Aspect Ratio</b>	<b>Auto</b> /Real/4:3/16:9/16:10/16:6			
<b>2D Keystone</b>				
<b>Corner Fit</b>				
<b>Position</b>				
<b>Phase</b>				
<b>H. Size</b>				
<b>Digital Zoom</b>				
<b>Digital Shrink</b>				
<b>3D</b>	<b>3D mode</b>	<b>Auto</b>		
		Top Bottom		
		Frame Sequential		
		Frame Packing		
		Side by Side		
		Off		
	<b>3D Sync Invert</b>	<b>Disable</b> /Invert		
	<b>Save 3D Settings</b>	<b>3D Settings 1</b>	<b>Yes</b> /No	
		<b>3D Settings 2</b>	<b>Yes</b> /No	
		<b>3D Settings 3</b>	<b>Yes</b> /No	
	<b>Apply 3D Settings</b>	<b>3D Settings 1</b>	<b>Yes</b> /No	
		<b>3D Settings 2</b>	<b>Yes</b> /No	
		<b>3D Settings 3</b>	<b>Yes</b> /No	
<b>Teaching Template</b>	<b>Blackboard</b>	<b>Off</b> /Letter Formation/Worksheet/Coordinate Chart		
	<b>Whiteboard</b>	<b>Off</b> /Letter Formation/Worksheet/Coordinate Chart		

## 2. PICTURE menu

Sub-menu	Sub-menu item/Options
<b>Picture Mode</b>	Bright/ <b>Presentation</b> /Vivid/sRGB/Cinema/(3D)/User 1/User 2
<b>Reference Mode</b>	Bright/ <b>Presentation</b> /Vivid/sRGB/Cinema/(3D)
<b>Brightness</b>	
<b>Contrast</b>	
<b>Color</b>	
<b>Tint</b>	
<b>Sharpness</b>	
<b>Brilliant Color</b>	On/Off
<b>Color Temperature</b>	Cool/ <b>Normal</b> /Warm
<b>Color Temperature Fine Tuning</b>	<b>R Gain</b>
	<b>G Gain</b>
	<b>B Gain</b>
	<b>R Offset</b>
	<b>G Offset</b>
<b>3D Color Management</b>	<b>B Offset</b>
	<b>Primary Color</b> R/G/B/C/M/Y
	<b>Hue</b>
	<b>Saturation</b>
<b>Reset Picture Settings</b>	<b>Gain</b>
	Current
	All
	Cancel

## 3. SOURCE menu

Sub-menu	Sub-menu item/Options
<b>Quick Auto Search</b>	On/Off
<b>HDMI Format</b>	Auto/RGB Full/RGB Limited/YUV Full/YUV Limited
<b>HDMI Equalizer</b>	HDMI-1
	HDMI-2

#### 4. SYSTEM SETUP: Basic menu

Sub-menu	Sub-menu item/Options		
Presentation Timer	Timer Period	1~15~240 minutes	
	Timer Display	Always/3 min/2 min/1 min/Never	
	Timer Position	Top-Left/Bottom-Left/Top-Right/ Bottom-Right	
	Timer Counting Direction	Count Down/Count Up	
	Sound Reminder	On/Off	
	On	Yes/No	
	Off	Yes/No	
Language	English / Français / Deutsch Italiano / Español / Русский 繁體中文 / 简体中文 / 日本語 / 한국어 Svenska / Nederlands / Türkçe/ Čeština / Português / हिन्दी / Polski Magyar / Български / Hrvatski/ Română / Suomi / Norsk / Dansk / Indonesian / Ελληνικά / العربية / हिन्दी		
Projector Installation	Front Table/Rear Table/Rear Ceiling/ <b>Front Ceiling</b>		
Menu Settings	Menu Display Time	5 secs/10 secs/ <b>20 secs</b> /30 secs/Always	
	Menu Position	Center/Top-Left/Top-Right/Bottom- Right/Bottom-Left	
	Reminder Message	On/Off	
Operation Settings	Direct Power On	On/Off	
	Signal Power On	Computer	On/Off
		HDMI	On/Off
	Auto Power Off	Disable/3 min/10 min/15 min/ <b>20 min</b> /25 min/30 min	
	Blank Timer	Disable/5 min/10 min/15 min/20 min/25 min/30 min	
	Sleep Timer	Disable/30 min/1 hr/2 hrs/3 hrs/4 hrs/8 hrs/12 hrs	
	Reset Filter Timer	Reset/ <b>Cancel</b>	
Panel Key Lock	On/Off	Yes/No	
Background Color	BenQ/Black/Blue/Purple		
Splash Screen	BenQ/Black/Blue		
USB Power Switch	On/Off		

## 5. SYSTEM SETUP: Advanced menu

Sub-menu	Sub-menu item/Options			
<b>High Altitude Mode</b>	<b>On/Off</b>	<b>Yes/No</b>		
<b>Fan Speed Mode</b>	<b>Filter</b>	<b>On/Off</b>	<b>Yes/No</b>	
	<b>Vertical Projection</b>	<b>On/Off</b>	<b>Yes/No</b>	
	<b>Mute</b>	<b>On/Off</b>		
<b>Audio Settings</b>	<b>Volume</b>			
	<b>Power On/Off Ring Tone</b>	<b>On/Off</b>		
	<b>Light Mode</b>	Normal		
Economic				
<b>Dimming</b>				
<b>Light Settings</b>	Light Usage Time			
	<b>Light Usage Time</b>	Normal		
		Economic		
		<b>Dimming</b>		
<b>Security Settings</b>	<b>Change Password</b>			
	<b>Change Security</b>	<b>Power On Lock</b>		
<b>Baud Rate</b>	9600/14400 /19200/38400/57600/115200			
<b>Test Pattern</b>	<b>On/Off</b>			
<b>Closed Caption</b>	<b>Closed Caption Enable</b>	<b>On/Off</b>		
	<b>Caption Version</b>	<b>CC1/CC2/CC3/CC4</b>		
<b>Standby Settings</b>	<b>Network</b>	<b>Enable network standby mode</b>	<b>On/Off</b>	
		<b>Switch to normal standby mode</b>	<b>Off/20 min/1 hr/3 hr/6 hr</b>	
	<b>Monitor Out</b>	<b>On/Off</b>		
	<b>Audio Pass Through</b>	<b>Off</b>		
		Audio In		
Audio L/R				
HDMI-1				
			HDMI-2/MHL	

<b>Network Settings</b>	<b>Wired LAN</b>	<b>Status</b>	<b>Connect/Disconnect</b>
		<b>DHCP</b>	<b>On/Off</b>
		<b>IP Address</b>	
		<b>Subnet Mask</b>	
		<b>Default Gateway</b>	
		<b>DNS Server</b>	
		<b>Apply</b>	
		<b>AMX Device Discovery</b>	<b>On/Off</b>
		<b>Mac Address</b>	
		<b>Reset All Settings</b>	<b>Reset/Cancel</b>

## 6. INFORMATION menu

<b>Sub-menu</b>	<b>Sub-menu item/Options</b>
<b>Current System Status</b>	<b>Native Resolution</b>
	<b>Source</b>
	<b>Picture Mode</b>
	<b>Light Mode</b>
	<b>Resolution</b>
	<b>3D Format</b>
	<b>Color System</b>
	<b>Light Usage Time</b>
	<b>Filter Usage Time</b>
	<b>Firmware Version</b>

Note that the menu items are available when the projector detects at least one valid signal. If there is no equipment connected to the projector or no signal detected, limited menu items are accessible.

# Description of each menu



- ☞ • The default values listed in this manual, especially on pages 54-63, are for reference only. They may vary between the projectors due to the continuous improvement to the products.

## I. DISPLAY menu

FUNCTION	DESCRIPTION
Wall Color	Corrects the projected picture's color when the projection surface is not white. See "Using Wall Color" on page 34 for details.
Aspect Ratio	There are four options to set the image's aspect ratio depending on your input signal source. See "Selecting the aspect ratio" on page 31 for details.
2D Keystone	Corrects vertical and horizontal keystoneings of the image. See "Correcting 2D keystone" on page 24 for details.
Corner Fit	Manually adjust four corners of the image by setting the horizontal and vertical values. See "Adjusting Corner Fit" on page 25 for details.
Position	Displays the position adjacent page. To move the projected image, use the directional arrow keys. The values shown on the lower position of the page change with every key press you made until they reach their maximum or minimum.  ☞ This function is only available when a PC signal (analog RGB) is selected.
Phase	Adjusts the clock phase to reduce image distortion.    ☞ This function is only available when a PC signal (analog RGB) is selected.
H. Size	Adjusts the horizontal width of the image.  ☞ This function is only available when a PC signal (analog RGB) is selected.
Digital Zoom	Magnifies the projected image. See "Magnifying and searching for details" on page 31 for details.
Digital Shrink	Shrinks the image with middle point of the image fixed.  1. Press <b>MENU/EXIT</b> and then press ◀/▶ until the <b>DISPLAY</b> menu is selected. Press ▼ to select <b>Digital Shrink</b> and press <b>MODE/ENTER</b> .  2. Press ◀/▶ to reduce the image to a desired size.

FUNCTION	DESCRIPTION
<p><b>3D</b></p>	<p>This projector features a 3D function which enables you to enjoy the 3D movies, videos, and sporting events in a more realistic way by presenting the depth of the images. You need to wear a pair of 3D glasses to view the 3D images.</p> <p><b>3D mode</b> The default setting is <b>Auto</b> and the projector automatically chooses an appropriate 3D format when detecting 3D contents. If the projector cannot recognize the 3D format, press ◀/▶ to choose a 3D mode.</p> <p><b>3D Sync Invert</b> When you discover the inversion of the image depth, enable this function to correct the problem.</p> <p><b>Save 3D Settings</b> Save current 3D settings.</p> <p><b>Apply 3D Settings</b> Apply saved 3D settings.</p>
<p><b>Teaching Template</b></p>	<p>Provides some templates as teaching aids. Teachers can use them for teaching. See "<a href="#">Use Teaching Template</a>" on page 41 for details.</p>

## 2. PICTURE menu

FUNCTION	DESCRIPTION
<b>Picture Mode</b>	Pre-defined picture modes are provided so you can optimize your projector image set-up to suit your program type. See <a href="#">"Selecting a picture mode" on page 33</a> for details.
<b>Reference Mode</b>	Selects a picture mode that best suits your need for the image quality and further fine-tune the image based on the selections listed on the same page below. See <a href="#">"Setting the User 1/User 2 mode" on page 33</a> for details.
<b>Brightness</b>	Adjusts the brightness of the image. See <a href="#">"Adjusting Brightness" on page 34</a> for details.
<b>Contrast</b>	Adjusts the degree of difference between dark and light in the image. See <a href="#">"Adjusting Contrast" on page 34</a> for details.
<b>Color</b>	Adjusts the color saturation level -- the amount of each color in a video image. See <a href="#">"Adjusting Color" on page 34</a> for details.  <b>This function is only available when a Video, S-Video or YPbPr signal is selected.</b>
<b>Tint</b>	Adjusts the red and green color tones of the image. See <a href="#">"Adjusting Tint" on page 34</a> for details.  <b>This function is only available when a Video or S-Video signal is selected and the system format is NTSC, NTSC443 or SECAM.</b>
<b>Sharpness</b>	Adjusts the sharpness of the image. See <a href="#">"Adjusting Sharpness" on page 34</a> for details.  <b>This function is only available when a Video, S-Video or YPbPr signal is selected.</b>
<b>Brilliant Color</b>	Adjusts the image to make it look sharper or softer. See <a href="#">"Adjusting Brilliant Color" on page 34</a> for details.



FUNCTION	DESCRIPTION
Color Temperature	See <a href="#">"Selecting a Color Temperature" on page 35</a> for details.
Color Temperature Fine Tuning	See <a href="#">"Setting a preferred color temperature" on page 35</a> for details.
3D Color Management	See <a href="#">"3D Color Management" on page 35</a> for details.
Reset Picture Setting	See <a href="#">"Resetting current or all picture modes" on page 36</a> for details. When Picture Mode is under Dynamic, choosing "Current" will only reset the Dynamic to default value, however, choosing "All" will reset all the Picture Mode settings to default values.

### 3. SOURCE menu

FUNCTION	DESCRIPTION
Quick Auto Search	See <a href="#">"Switching input signal" on page 30</a> for details.
HDMI Format	Selects a suitable color format to optimize display quality. <b>Auto</b> Automatically selects a suitable color space and gray level for the incoming HDMI signal. <b>RGB Full</b> Utilizes the Full range RGB 0-255. <b>RGB Limited</b> Utilizes the Limited range RGB 16-235. <b>YUV Full</b> Utilizes the Full range YUV 0-255. <b>YUV Limited</b> Utilizes the Limited range YUV 16-235.
HDMI Equalizer	Adjusts the equalizer gain settings for an HDMI signal. The higher the setting, the stronger the gain value. If there are more than one HDMI port on the projector, select the HDMI port first before adjusting the value.





#### 4. SYSTEM SETUP: Basic menu

FUNCTION	DESCRIPTION
<b>Presentation Timer</b>	<p>Reminds the presenter to finish the presentation within a certain time frame. See "<a href="#">Setting the presentation timer</a>" on page 37 for details.</p> <p><b>Timer Period</b> Sets a preferred length of time for presentation.</p> <p><b>Timer Display</b> Sets whether to display the timer on screen.</p> <p><b>Timer Position</b> Sets the position where the timer displays on screen.</p> <p><b>Timer Counting Direction</b> Sets the timer counting direction.</p> <p><b>Sound Reminder</b> Sets a sound reminder if timer is up.</p> <p><b>On</b> Turns on the presentation timer.</p> <p><b>Off</b> Turns off the presentation timer.</p>
<b>Language</b>	Sets the language for the On-Screen Display (OSD) menus.
<b>Projector Installation</b>	The projector can be installed on a ceiling or behind a screen, or with one or more mirrors. See " <a href="#">Choosing a location</a> " on page 14 for details.
<b>Menu Settings</b>	<p><b>Menu Display Time</b> Sets the length of time the OSD will remain active after your last key press. The range is from 5 to 30 seconds in 5-second increments.</p> <p><b>Menu Position</b> Sets the On-Screen Display (OSD) menu position.</p> <p><b>Reminder Message</b> Sets whether to display the reminder message.</p>

FUNCTION	DESCRIPTION
<b>Operation Settings</b>	<p><b>Direct Power On</b> Selecting <b>On</b> enables the function. See <a href="#">"Starting up the projector" on page 23</a> for details.</p>
	<p><b>Signal Power On</b> Selecting <b>On</b> the projector will turn on automatically when VGA signal is detected. Selecting <b>Off</b> the projector has to be turned on manually (by keypad or remote). See <a href="#">"Starting up the projector" on page 23</a> for details.</p>
	<p><b>Auto Power Off</b> Allows the projector to turn off automatically if no input signal is detected after a set period of time. See <a href="#">"Setting Auto Power Off" on page 69</a> for details.</p>
	<p><b>Blank Timer</b> Sets the image blank time when the Blank feature is activated, once elapsed the image will return to the screen. See <a href="#">"Hiding the image" on page 38</a> for details.</p>
	<p><b>Sleep Timer</b> Sets the auto-shutdown timer. The timer can be set to a value between 30 minutes and 12 hours.</p>
	<p><b>Reset Filter Timer</b> Resets the filter timer if a new filter is replaced.</p>
<b>Panel Key Lock</b>	Disables or enables all panel key functions except Power on the projector and keys on the remote control.
<b>Background Color</b>	Allows you to select which background color will display when no signal is input into the projector. Four options are available: BenQ logo, Black, Blue, or Purple.
<b>Splash Screen</b>	Allows you to select which logo screen will display during projector start-up. Four options are available: BenQ logo, Black, or Blue.
<b>USB Power Switch</b>	Selects <b>On/Off</b> to enable or disable USB power output.

## 5. SYSTEM SETUP: Advanced menu

FUNCTION	DESCRIPTION
<b>High Altitude Mode</b>	A mode for operation in high altitude areas. See " <a href="#">Operating in a high altitude environment</a> " on page 38 for details.
<b>Fan Speed Mode</b>	<p>In <b>Fan Speed Mode</b>, fan will rotate faster to suck in more air to cool down the projector.</p> <p><b>Filter</b> Sets to <b>On</b> when the dust filter is installed.</p> <p><b>Vertical Projection</b> Sets to <b>On</b> when doing vertical projection.</p>
<b>Audio Settings</b>	<p>Allows you to enter the audio setting menu. See "<a href="#">Adjusting the sound</a>" on page 39 for details.</p> <p><b>Mute</b> Sets the mute function.</p> <p><b>Volume</b> Adjusts the audio volume level.</p> <p><b>Power On/Off Ring Tone</b> Sets the power on/off ring tone.</p>
<b>Light Settings</b>	<p><b>Light Mode</b> See "<a href="#">Select the Light Mode</a>" on page 40 for details</p> <p><b>Light Usage Time</b> Shows equivalent light hour of used time.</p>
<b>Security Settings</b>	<p><b>Change Password</b> You will be asked to enter the current password before changing to a new one.</p> <p><b>Change Security Settings</b> Input current password to activate <b>Power On Lock</b> function.</p> <p><b>Power On Lock</b> See "<a href="#">Securing the projector</a>" on page 28 for details.</p>
<b>Baud Rate</b>	Selects a baud rate that is identical with your computer's so that you can connect the projector using a suitable RS-232 cable. This function is intended for qualified service personnel.
<b>Test Pattern</b>	Selecting <b>On</b> enables the function and the projector displays the grid test pattern. It helps you adjust the image size and focus and check that the projected image is free from distortion.

FUNCTION	DESCRIPTION
<p><b>Closed Caption</b></p>	<p><b>Closed Caption Enable</b>  Activates the function by selecting <b>On</b> when the selected input signal carries closed captions.</p> <ul style="list-style-type: none"> <li>• Captions: An on-screen display of the dialogue, narration, and sound effects of TV programs and videos that are closed captioned (usually marked as "CC" in TV listings).</li> </ul> <p> <b>Set your screen aspect ratio to 4:3. This function is not available when the aspect ratio is "16:9", "16:10" or "Real".</b></p> <p><b>Caption Version</b>  Selects a preferred closed captioning mode. To view captions, select CC1, CC2, CC3, or CC4 (CC1 displays captions in the primary language in your area).</p>
<p><b>Standby Settings</b></p>	<p><b>Network</b></p> <ul style="list-style-type: none"> <li>• Enable Network Standby Mode</li> </ul> <p>Selecting <b>On</b> enables the function. The projector is able to provide the network function in standby mode. Selecting <b>Off</b> disables the function. The projector does not provide the network function in standby mode.</p> <ul style="list-style-type: none"> <li>• Switch to normal standby mode</li> </ul> <p>Allows the projector to disable the network function after a set period of time after it enters standby mode. For instance, if 20 min is selected, the projector is able to provide the network function for 20 minutes after it enters standby mode. When 20 minutes is up, the projector enters normal standby mode.</p> <p> <b>This function is only available when Enable Network Standby Mode is On.</b></p> <p><b>Monitor Out</b></p> <p>Selecting <b>On</b> enables the function. The projector can output a VGA signal when it is in standby mode and the <b>PC IN</b> and <b>MONITOR-OUT</b> jacks are correctly connected to devices. See "<a href="#">Connection</a>" on page 20 for how to make the connection.</p> <p> <b>Enabling this function slightly increases the standby power consumption.</b></p> <p> <b>The Monitor Out only works when an appropriate D-Sub input is made to the PC IN jack.</b></p> <p><b>Audio Pass Through</b></p> <p>The projector can play sound when it is in standby mode and the corresponding jacks are correctly connected to devices. Press ◀/▶ to choose the source that you wish to use. See "<a href="#">Connection</a>" on page 20 for how to make the connection.</p> <p> <b>Enabling this function slightly increases the standby power consumption.</b></p>

<p><b>Network Settings</b></p>	<p><b>Wired LAN</b> See "<a href="#">Controlling the projector through a LAN environment</a>" on page 42 for details.</p> <p><b>AMX Device Discovery</b> When <b>AMX Device Discovery</b> is <b>On</b>, the projector can be detected by AMX controller.</p> <p><b>Mac Address</b> Displays the <b>Mac Address</b> for this projector.</p>
<p><b>Reset All Settings</b></p>	<p>Returns all settings to the factory preset values.</p> <p> <b>The following settings will still remain: 2D Keystone, Corner Fit, Digital Shrink, Projector Installation, Filter Usage Time, High Altitude Mode, Fan Speed Mode, Light Usage Time, Security Settings, Baud Rate, Network Settings.</b></p>

## 6. INFORMATION menu

FUNCTION	DESCRIPTION
<b>Current System Status</b>	<p><b>Native Resolution</b> Shows the native resolution.</p> <p><b>Source</b> Shows the current signal source.</p> <p><b>Picture Mode</b> Shows the selected mode in the <b>PICTURE</b> menu.</p> <p><b>Light Mode</b> Shows the current light mode.</p> <p><b>Resolution</b> Shows the native resolution of the input signal.</p> <p><b>3D Format</b> Shows the current 3D mode.</p> <p><b>Color System</b> Shows input system format RGB or YUV.</p> <p><b>Light Usage Time</b> Displays the number of hours the light has been used.</p> <p><b>Filter Usage Time</b> Displays the number of hours the filter has been used.</p> <p><b>Firmware Version</b> Shows firmware version.</p>

# Maintenance

## Care of the projector

Your projector needs little maintenance. The only thing you need to do on a regular basis is to keep the lens and case clean.

Never remove any parts of the projector. Contact your dealer if other parts need replacing.

### Cleaning the lens

Clean the lens whenever you notice dirt or dust on the surface.

- Use a canister of compressed air to remove dust.
- If there is dirt or smears, use lens-cleaning paper or moisten a soft cloth with lens cleaner and gently wipe the lens surface.
- Never use any type of abrasive pad, alkaline/acid cleaner, scouring powder, or volatile solvent, such as alcohol, benzene, thinner or insecticide. Using such materials or maintaining prolonged contact with rubber or vinyl materials may result in damage to the projector surface and cabinet material.

 **Never rub the lens with abrasive materials.**

### Cleaning the projector case

Before you clean the case, turn the projector off using the proper shutdown procedure as described in "[Shutting down the projector](#)" on page 48 and unplug the power cord.

- To remove dirt or dust, wipe the case with a soft, lint-free cloth.
- To remove stubborn dirt or stains, moisten a soft cloth with water and a neutral pH detergent. Then wipe the case.

 **Never use wax, alcohol, benzene, thinner or other chemical detergents. These can damage the case.**

### Storing the projector

If you need to store the projector for an extended time, please follow the instructions below:

- Make sure the temperature and humidity of the storage area are within the recommended range for the projector. Please refer to "[Specifications](#)" on page 67 or consult your dealer about the range.
- Retract the adjuster feet.
- Remove the battery from the remote control.
- Pack the projector in its original packing or equivalent.

### Transporting the projector

It is recommended that you ship the projector with its original packing or equivalent.



# Indicators

Light			Status & Description
POWER	TEMP	LIGHT	
<b>System messages</b>			
Orange	Off	Off	Stand-by
Green Flashing	Off	Off	Powering up
Green	Off	Off	Normal operation
Orange Flashing	Off	Off	Normal power-down cooling
Red Flashing	Red Flashing	Red Flashing	Download
Green	Off	Red	CW start fail
Green	Off	Orange	Light exhausted
Off	Green	Off	LAN download processing
<b>Light error messages</b>			
Off	Off	Red	Light error in normal operation
Off	Off	Orange Flashing	Light is not lit up
<b>Thermal error messages</b>			
Red	Red	Off	Fan 1 error (the actual fan speed is outside the desired
Red	Red Flashing	Off	Fan 2 error (the actual fan speed is outside the desired
Red	Green	Off	Fan 3 error (the actual fan speed is outside the desired
Red	Green Flashing	Off	Fan 4 error (the actual fan speed is outside the desired
Red Flashing	Red	Off	Fan 5 error (the actual fan speed is outside the desired
Red Flashing	Red Flashing	Off	Fan 6 error (the actual fan speed is outside the desired
Green	Red	Off	Temperature 1 error (over limited temperature)
Green	Green Flashing	Off	Thermal IC #1 I2C Connection error

# Troubleshooting

## ? The projector does not turn on.

Cause	Remedy
There is no power from the power cable.	Plug the power cord into the AC inlet on the projector, and plug the power cord into the power outlet. If the power outlet has a switch, make sure that it is switched on.
Attempting to turn the projector on again during the cooling process.	Wait until the cooling down process has completed.

## ? No picture

Cause	Remedy
The video source is not turned on or connected correctly.	Turn the video source on and check that the signal cable is connected correctly.
The projector is not correctly connected to the input signal device.	Check the connection.
The input signal has not been correctly selected.	Select the correct input signal with the <b>SOURCE</b> key on the projector or remote control.

## ? Blurred image

Cause	Remedy
The projection lens is not correctly focused.	Adjust the focus of the lens using the focus ring.
The projector and the screen are not aligned properly.	Adjust the projection angle and direction as well as the height of the unit if necessary.

## ? Remote control does not work

Cause	Remedy
The battery is out of power.	Replace the battery with new one.
There is an obstacle between the remote control and the projector.	Remove the obstacle.
You are too far away from the projector.	Stand within 8 meters (26 feet) of the projector.

## ? The password is incorrect

Cause	Remedy
You do not remember the password.	Please see <a href="#">"Entering the password recall procedure" on page 29</a> for details.

# Specifications

 All specifications are subject to change without notice.

## Optical

### Resolution

LX890UST: 1024 x 768 XGA  
LW890UST: 1280 x 800 WXGA  
LH890UST: 1920 x 1080 1080p

### Display system

DLP® Chip

### Lens F/Number

F=2.4, f= 3.35mm

### Offset

LX890UST: 120+/-3 %  
LW890UST: 117.3+/-3 %  
LH890UST: 118.8+/-3 %

### Zoom ratio

1.0X

### Light source

Laser diode

## Electrical

### Power supply

AC100-240V, 4.50A,  
50-60 Hz (Automatic)

### Power consumption

380W (Max.); < 0.5W for normal standby mode; < 2W (when the Network function in the Standby Settings is on)

## Mechanical

### Weight

9.06 kg (19.97 lbs.)

## Output terminals

### RGB output

D-Sub 15-pin (female) x 1

### Speaker

10 watt x 1

### Audio signal output

PC audio jack x 1

## Control

### USB

PointWrite (USB mini B) x 1  
(Optional for PointWrite kit)

### RS-232 serial control

9 pin x 1

### LAN control

RJ45 x 1

### IR receiver x 1

## Input terminals

### Computer input

RGB input

D-Sub 15-pin (female) x 1

### Video signal input

S-VIDEO

Mini DIN 4-pin port x 1

VIDEO

RCA jack x 1

SD/HDTV signal input

Analog - Component RCA jack x 3  
(through RGB input)

Digital-HDMI x 2 (1 for MHL input)

### Audio signal input

PC audio jack x 1

RCA audio jack (L/R) x 2

### USB type A x 1

Supports 1.5A charger

### USB mini B x 1

Supports firmware upgrade

## Environmental Requirements

### Temperature

Operating: 0°C-40°C at sea level

Storage: -20°C-60°C at sea level

### Relative humidity

Operating: 10%-90% (without condensation)

Storage: 10%-90% (without condensation)

### Altitude

Operating: 0-1499 m at 0°C-35°C; 1500-3000

m at 0°C-30°C (with High Altitude Mode on)

Storage: 0-12200 m at 30°C

### Transporting

Original packing or equivalent is recommended.

### Repairing

Please visit below website and choose your country to find your service contact window.  
<http://www.benq.com/welcome>

# Dimensions

502.1 mm (W) × 164.5 mm (H) × 399.3 mm (D)

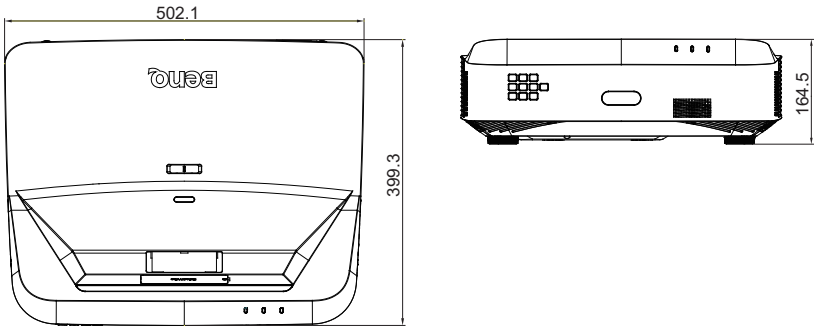

## Wall mount installation diagram

Wall mount screw: M4

(Max L = 25 mm; Min L = 20 mm)

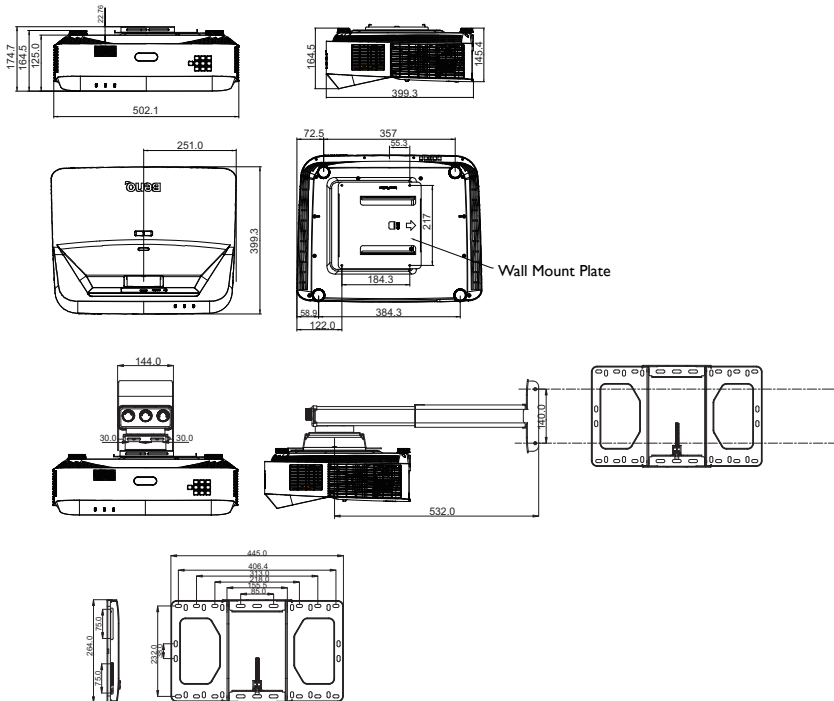

Unit: mm

# Timing chart

## I. VGA Analog

### Supported timing for PC input

Resolution	Timing	Horizontal Frequency (KHz)	Vertical Frequency (Hz)	Pixel Frequency (MHz)	3D Field Sequential	3D top bottom	3D side by side
640 x 480	VGA_60	59.94	31.469	25.175	⊙	⊙	⊙
	VGA_72	72.809	37.861	31.500			
	VGA_75	75	37.5	31.500			
	VGA_85	85.008	43.269	36.000			
720 x 400	720 x 400_70	70.087	31.469	28.3221			
800 x 600	SVGA_60	60.317	37.879	40.000	⊙	⊙	⊙
	SVGA_72	72.188	48.077	50.000			
	SVGA_75	75	46.875	49.500			
	SVGA_85	85.061	53.674	56.250			
	SVGA_120 (Reduce Blanking)	119.854	77.425	83.000	⊙		
1024 x 768	XGA_60	60.004	48.363	65.000	⊙	⊙	⊙
	XGA_70	70.069	56.476	75.000			
	XGA_75	75.029	60.023	78.750			
	XGA_85	84.997	68.667	94.500			
	XGA_120 (Reduce Blanking)	119.989	97.551	115.5	⊙		
1152 x 864	1152 x 864_75	75	67.5	108			
1024 x 576	BenQ Notebook Timing	60	35.82	46.966			
1024 x 600	BenQ Notebook Timing	64.995	41.467	51.419			
1280 x 720	1280 x 720_60	60	45	74.250	⊙	⊙	⊙
1280 x 768	1280 x 768_60	59.87	47.776	79.5	⊙	⊙	⊙
1280 x 800	WXGA_60	59.81	49.702	83.500	⊙	⊙	⊙
	WXGA_75	74.934	62.795	106.500			
	WXGA_85	84.88	71.554	122.500			
	WXGA_120 (Reduce Blanking)	119.909	101.563	146.25	⊙		
1280 x 1024	SXGA_60	60.02	63.981	108.000		⊙	⊙
	SXGA_75	75.025	79.976	135.000			
	SXGA_85	85.024	91.146	157.500			
1280 x 960	1280 x 960_60	60	60	108.000		⊙	⊙
	1280 x 960_85	85.002	85.938	148.500			
1360 x 768	1360 x 768_60	60.015	47.712	85.5		⊙	⊙
1440 x 900	WXGA+_60	59.887	55.935	106.500		⊙	⊙
1400 x 1050	SXGA+_60	59.978	65.317	121.750		⊙	⊙

1600 x 1200	UXGA	60	75	162.000		⊙	⊙
1680 x 1050	1680 x 1050_60	59.954	65.29	146.25		⊙	⊙
640 x 480 @67Hz	MAC13	66.667	35	30.240			
832 x 624 @75Hz	MAC16	74.546	49.722	57.280			
1024 x 768 @75Hz	MAC19	75.02	60.241	80.000			
1152 x 870 @75Hz	MAC21	75.06	68.68	100.000			

- The timings showing above may not be supported due to EDID file and VGA graphic card limitations. It is possible that some timings cannot be chosen.

## 2. HDMI Digital

### Supported timing for PC input

Resolution	Timing	Horizontal Frequency (KHz)	Vertical Frequency (Hz)	Pixel Frequency (MHz)	3D Field Sequential	3D top bottom	3D side by side
640 x 480	VGA_60	59.94	31.469	25.175	⊙	⊙	⊙
	VGA_72	72.809	37.861	31.500			
	VGA_75	75	37.5	31.500			
	VGA_85	85.008	43.269	36.000			
720 x 400	720 x 400_70	70.087	31.469	28.3221			
800 x 600	SVGA_60	60.317	37.879	40.000	⊙	⊙	⊙
	SVGA_72	72.188	48.077	50.000			
	SVGA_75	75	46.875	49.500			
	SVGA_85	85.061	53.674	56.250			
	SVGA_120 (Reduce Blanking)	119.854	77.425	83.000	⊙		
1024 x 768	XGA_60	60.004	48.363	65.000	⊙	⊙	⊙
	XGA_70	70.069	56.476	75.000			
	XGA_75	75.029	60.023	78.750			
	XGA_85	84.997	68.667	94.500			
	XGA_120 (Reduce Blanking)	119.989	97.551	115.5	⊙		
1152 x 864	1152 x 864_75	75	67.5	108			
1024 x 576	BenQ Notebook Timing	60	35.82	46.966			
1024 x 600	BenQ Notebook Timing	64.995	41.467	51.419			
1280 x 720	1280 x 720_60	60	45	74.250	⊙	⊙	⊙
1280 x 768	1280 x 768_60	59.87	47.776	79.5	⊙	⊙	⊙

1280 x 800	WXGA_60	59.81	49.702	83.500	⊙	⊙	⊙
	WXGA_75	74.934	62.795	106.500			
	WXGA_85	84.88	71.554	122.500			
	WXGA_120 (Reduce Blanking)	119.909	101.563	146.25	⊙		
1280 x 1024	SXGA_60	60.02	63.981	108.000		⊙	⊙
	SXGA_75	75.025	79.976	135.000			
	SXGA_85	85.024	91.146	157.500			
1280 x 960	1280 x 960_60	60	60	108.000		⊙	⊙
	1280 x 960_85	85.002	85.938	148.500			
1360 x 768	1360 x 768_60	60.015	47.712	85.5		⊙	⊙
1440 x 900	WXGA+_60	59.887	55.935	106.500		⊙	⊙
1400 x 1050	SXGA+_60	59.978	65.317	121.750		⊙	⊙
1600 x 1200	UXGA	60	75	162.000		⊙	⊙
1680 x 1050	1680 x 1050_60	59.954	65.29	146.25		⊙	⊙
640 x 480 @67Hz	MAC13	66.667	35	30.240			
832 x 624 @75Hz	MAC16	74.546	49.722	57.280			
1024 x 768 @75Hz	MAC19	75.02	60.241	80.000			
1152 x 870 @75Hz	MAC21	75.06	68.68	100.000			
1920 x 1080	1920 x 1080_60 (Reduce Blanking)	67.5	60	148.5		⊙	⊙
1920 x 1200	1920 x 1200_60 (Reduce Blanking)	59.95	74.038	154.000		⊙	⊙

The timings showing above may not be supported due to EDID file and VGA graphic card limitations. It is possible that some timings cannot be chosen.

## Supported timing for video input

Timing	Resolution	Horizontal Frequency (KHz)	Vertical Frequency (Hz)	Pixel Frequency (MHz)	3D Field Sequential	3D Frame Packing	3D Top-Bottom	3D Side by Side
480i	720 (1440) x 480	15.73	59.94	27	⊙			
480p	720 x 480	31.47	59.94	27	⊙			
576i	720 (1440) x 576	15.63	50	27				
576p	720 x 576	31.25	50	27				
720/50p	1280 x 720	37.5	50	74.25		⊙	⊙	⊙
720/60p	1280 x 720	45.00	60	74.25	⊙	⊙	⊙	⊙

1080/50i	1920 x 1080	28.13	50	74.25				⊙
1080/60i	1920 x 1080	33.75	60	74.25				⊙
1080/24P	1920 x 1080	27	24	74.25		⊙	⊙	⊙
1080/25P	1920 x 1080	28.13	25	74.25				
1080/30P	1920 x 1080	33.75	30	74.25				
1080/50P	1920 x 1080	56.25	50	148.5			⊙	⊙
1080/60P	1920 x 1080	67.5	60	148.5			⊙	⊙

### 3. Video

#### Supported timing for Video input

Video mode	Horizontal Frequency (kHz)	Vertical Frequency (Hz)	Color sub-carrier Frequency (MHz)	3D Field Sequential
NTSC	15.73	60	3.58	⊙
PAL	15.63	50	4.43	
SECAM	15.63	50	4.25 or 4.41	
PAL-M	15.73	60	3.58	
PAL-N	15.63	50	3.58	
PAL-60	15.73	60	4.43	
NTSC4.43	15.73	60	4.43	

#### Supported timing for Component-YPbPr input

Timing	Resolution	Horizontal Frequency (KHz)	Vertical Frequency (Hz)	Pixel Frequency (MHz)	3D Field Sequential
480i	720 x 480	15.73	59.94	13.5	⊙
480p	720 x 480	31.47	59.94	27	⊙
576i	720 x 576	15.63	50	13.5	
576p	720 x 576	31.25	50	27	
720/50p	1280 x 720	37.5	50	74.25	
720/60p	1280 x 720	45.00	60	74.25	⊙
1080/50i	1920 x 1080	28.13	50	74.25	
1080/60i	1920 x 1080	33.75	60	74.25	
1080/24P	1920 x 1080	27	24	74.25	
1080/25P	1920 x 1080	28.13	25	74.25	
1080/30P	1920 x 1080	33.75	30	74.25	
1080/50P	1920 x 1080	56.25	50	148.5	
1080/60P	1920 x 1080	67.5	60	148.5	



# Warranty and Copyright information

## Patents

Please go to <http://patmarking.benq.com/> for the details on BenQ projector patent coverage.

## Limited warranty

BenQ warrants this product against any defects in material and workmanship, under normal usage and storage.

Proof of purchase date will be required with any warranty claim. In the event this product is found to be defective within the warranty period, BenQ's only obligation and your exclusive remedy shall be replacement of any defective parts (labor included). To obtain warranty service, immediately notify the dealer from which you purchased the product of any defects.

Important: The above warranty shall be void if the customer fails to operate the product in accordance with BenQ's written instructions, especially the ambient humidity must be in-between 10% and 90%, temperature in-between 0°C and 35°C, altitude lower than 4920 feet, and avoiding to operate the projector in a dusty environment. This warranty gives you specific legal rights, and you may have other rights which vary from country to country.

For other information, please visit [www.BenQ.com](http://www.BenQ.com).

## Copyright

Copyright 2018 by BenQ Corporation. All rights reserved. No part of this publication may be reproduced, transmitted, transcribed, stored in a retrieval system or translated into any language or computer language, in any form or by any means, electronic, mechanical, magnetic, optical, chemical, manual or otherwise, without the prior written permission of BenQ Corporation.

## Disclaimer

BenQ Corporation makes no representations or warranties, either expressed or implied, with respect to the contents hereof and specifically disclaims any warranties, merchantability or fitness for any particular purpose. Further, BenQ Corporation reserves the right to revise this publication and to make changes from time to time in the contents hereof without obligation to notify any person of such revision or changes.

\*DLP, Digital Micromirror Device and DMD are trademarks of Texas Instruments. Others are copyrights of their respective companies or organizations.