

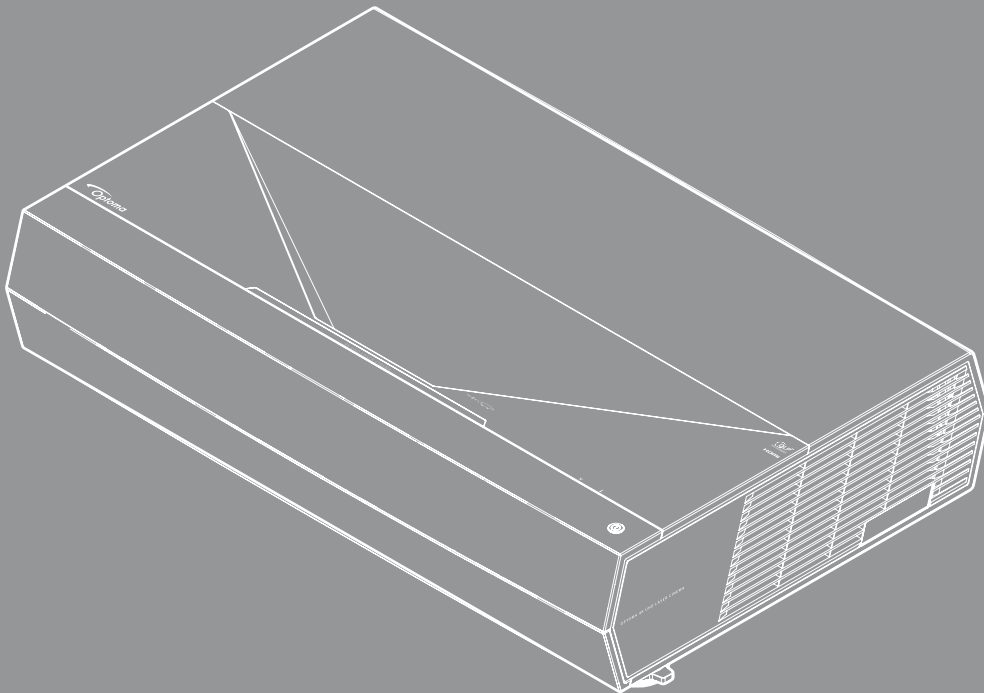

DLP® Projector



User manual



4K ULTRA HD™



HDMI™
HIGH-DEFINITION MULTIMEDIA INTERFACE

TABLE OF CONTENTS

| | |
|---|-----------|
| SAFETY | 4 |
| <i>Important Safety Instruction</i> | 4 |
| <i>Cleaning the Lens</i> | 5 |
| <i>Laser Radiation Safety Information</i> | 6 |
| <i>3D Safety Information</i> | 7 |
| <i>Copyright</i> | 8 |
| <i>Disclaimer</i> | 8 |
| <i>Trademark Recognition</i> | 8 |
| <i>FCC</i> | 8 |
| <i>Declaration of Conformity for EU countries</i> | 9 |
| <i>WEEE</i> | 9 |
| | |
| INTRODUCTION | 10 |
| <i>Package Overview</i> | 10 |
| <i>Standard accessories</i> | 10 |
| <i>Product Overview</i> | 11 |
| <i>Connections</i> | 12 |
| <i>Keypad and LED indicators</i> | 12 |
| <i>Remote control</i> | 13 |
| | |
| SETUP AND INSTALLATION | 14 |
| <i>Connecting sources to the projector</i> | 15 |
| <i>Adjusting the projector image</i> | 16 |
| <i>Remote setup</i> | 17 |
| | |
| USING THE PROJECTOR | 19 |
| <i>Powering on / off the projector</i> | 19 |
| <i>Selecting an input source</i> | 20 |
| <i>Menu navigation and features</i> | 21 |
| <i>OSD Menu tree</i> | 22 |
| <i>Display menu</i> | 27 |
| <i>Audio menu</i> | 33 |
| <i>Setup menu</i> | 33 |
| <i>Info menu</i> | 36 |

| | |
|--|-----------|
| ADDITIONAL INFORMATION..... | 37 |
| <i>Compatible resolutions.....</i> | <i>37</i> |
| <i>Image size and projection distance.....</i> | <i>42</i> |
| <i>Remote control codes.....</i> | <i>43</i> |
| <i>Troubleshooting.....</i> | <i>45</i> |
| <i>Warning indicators.....</i> | <i>46</i> |
| <i>Specifications.....</i> | <i>49</i> |
| <i>Optoma global offices.....</i> | <i>50</i> |

SAFETY

| | |
|---|---|
|  | The lightning flash with arrow head within an equilateral triangle is intended to alert the user to the presence of uninsulated "dangerous voltage" within the product's enclosure that may be of sufficient magnitude to constitute a risk of electric shock to persons. |
|  | The exclamation point within an equilateral triangle is intended to alert the user to the presence of important operating and maintenance (servicing) instructions in the literature accompanying the appliance. |

Please follow all warnings, precautions and maintenance as recommended in this user's guide.

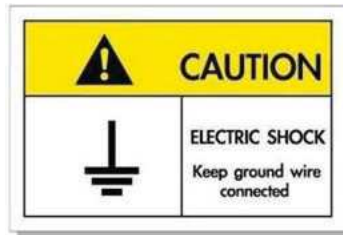

To avoid electric shock, the unit and its peripherals must be properly grounded (earthed).

This equipment is equipped with a three-pin grounding-type power plug.

Do not remove the grounding pin on the power plug.

This is a safety feature. If you are unable to insert the plug into the outlet, contact an electrician.

Do not defeat the purpose of the grounding plug.

Important Safety Instruction

- Do not block any ventilation openings. To ensure reliable operation of the projector and to protect from over heating, it is recommended to install the projector in a location that does not block ventilation. As an example, do not place the projector on a crowded coffee table, sofa, bed, etc. Do not put the projector in an enclosure such as a book case or a cabinet that restricts air flow.
- To reduce the risk of fire and/or electric shock, do not expose the projector to rain or moisture. Do not install near heat sources such as radiators, heaters, stoves or any other apparatus such as amplifiers that emits heat.
- Do not let objects or liquids enter the projector. They may touch dangerous voltage points and short out parts that could result in fire or electric shock.
- Do not use under the following conditions:
 - In extremely hot, cold or humid environments.
 - (i) Ensure that the ambient room temperature is within 0°C ~ 40°C (32°F ~ 104°F)
 - (ii) Relative humidity is 10% ~ 80%
 - In areas susceptible to excessive dust and dirt.
 - Near any appliance generating a strong magnetic field.
 - In direct sunlight.
- Do not use the unit if it has been physically damaged or abused. Physical damage/abuse would be (but not limited to):
 - Unit has been dropped.
 - Power supply cord or plug has been damaged.
 - Liquid has been spilled on to the projector.
 - Projector has been exposed to rain or moisture.
 - Something has fallen in the projector or something is loose inside.

- Do not place the projector on an unstable surface. The projector may fall over resulting in injury or the projector may become damaged.
- Do not block the light coming out of the projector lens when in operation. The light will heat the object and could melt, cause burns or start a fire.
- Please do not open or disassemble the projector as this may cause electric shock.
- Do not attempt to service the unit yourself. Opening or removing covers may expose you to dangerous voltages or other hazards. Please call Optoma before you send the unit for repair.
- See projector enclosure for safety related markings.
- The unit should only be repaired by appropriate service personnel.
- Only use attachments/accessories specified by the manufacturer.
- Do not look into straight into the projector lens during operation. The bright light may harm your eyes.
- When switching the projector off, please ensure the cooling cycle has been completed before disconnecting power. Allow 90 seconds for the projector to cool down.
- Turn off and unplug the power plug from the AC outlet before cleaning the product.
- Use a soft dry cloth with mild detergent to clean the display housing. Do not use abrasive cleaners, waxes or solvents to clean the unit.
- Disconnect the power plug from AC outlet if the product is not being used for a long period of time.
- Do not setup the projector in places where it might be subjected to vibration or shock.
- Do not touch the lens with bare hands.
- Remove battery/batteries from remote control before storage. If the battery/batteries are left in the remote for long periods, they may leak.
- Do not use or store the projector in places where smoke from oil or cigarettes may be present, as it can adversely affect the quality of the projector performance.
- Please follow the correct projector orientation installation as non standard installation may affect the projector performance.
- Use a power strip and or surge protector. As power outages and brown-outs can KILL devices.

Cleaning the Lens

- Before cleaning the lens, be sure to turn off the projector and unplug the power cord to allow it to completely cool down.
- Use a compressed air tank to remove the dust.
- Use a special cloth for cleaning lens and gently wipe the lens. Do not touch the lens with your fingers.
- Do not use alkaline/acid detergents or volatile solvents such as alcohol for cleaning lens. If the lens is damaged due to the cleaning process, it is not covered by the warranty.

Warning

- Do not use a spray containing flammable gases to remove dust or dirt from the lens. This may cause a fire due to excessive heat inside the projector.
- Do not clean the lens if the projector is warming up as this may cause the lens' surface film to peel off.
- Do not wipe or tap the lens with a hard object.

Laser Radiation Safety Information

- Complies with 21 CFR 1040.10 and 1040.11 except for conformance as a Risk Group 2 LIP as defined in IEC 62471-5:Ed. 1.0. For more information, see Laser Notice No. 57, dated May 8, 2019



IEC/EN 60825-1:2014 CLASS 1 LASER PRODUCT RISK GROUP 2
Complies with 21 CFR 1040.10 and 1040.11 except for conformance as a Risk Group 2 LIP as defined in IEC 62471-5:Ed. 1.0. For more information see Laser Notice No. 57, dated May 8, 2019.

IEC/EN 60825-1:2014 PRODUIT LASER DE CLASSE 1 GROUPE DE RISQUE 2
Conforme aux normes 21 CFR 1040.10 et 1040.11, à l'exception de la conformité en tant que LIP du groupe de risque 2 définie dans la CEI 62471-5: Ed. 1.0. Pour plus d'informations, voir l'avis au laser n° 57 du 8 mai 2019.

IEC/EN 60825-1:2014 等級1雷射產品RG2危險等級
除了IEC 62471-5:Ed.1.0中定義的RG2 LIP 危險等級以外，要符合21 CFR 1040.10和1040.11，更多相關資訊，請參閱2019年5月8日的第57號雷射公告。

IEC/EN 60825-1:2014 1类激光产品RG2危险等级
除了IEC 62471-5:Ed.1.0中定义的RG2 LIP 危险等级以外，要符合21 CFR 1040.10和1040.11，更多相关信息，请参阅2019年5月8日的第57号激光公告。



Failure to comply with the following could result in death or serious injury.

- This projector has built-in Class 4 laser module. Disassembly or modification is very dangerous and should never be attempted.
- Any operation or adjustment not specifically instructed by the user's guide creates the risk of hazardous laser radiation exposure.
- Do not open or disassemble the projector as this may cause damage by the exposure of laser radiation.
- Do not stare into beam when the projector is on. The bright light may result in permanent eye damage.
- When turning on the projector, make sure no one within projection range is looking at the lens.
- Without following the control, adjustment or operation procedure may cause damage by the exposure of laser radiation.
- Adequate instructions for assembly, operation, and maintenance, including clear warnings concerning precautions to avoid possible exposure to laser.

"WARNING: MOUNT ABOVE THE HEADS OF CHILDREN."
Additional warning against eye exposure for close exposures less than 1 m.
"AVERTISSEMENT : INSTALLER AU-DESSUS DE LA TÊTE DES ENFANTS."
Avertissement supplémentaire contre l'exposition oculaire pour des expositions à une distance de moins de 1 m.

警告：安装在高于孩童头顶处
关于小子 | 近距离眼睛暴露的附加警告

「警告：安装在高於兒童頭部處」
針對 1 m 以下近距離眼睛接觸的額外警告

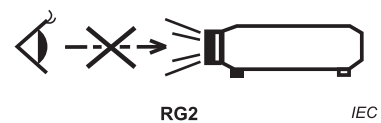

IEC 60825-1:2014 Class 1 RG2

IEC 62471-5:2015 RG2

- Additional instructions to supervise children, no staring, and not use optical aids.
- Additional instructions to install above the reach of children.
- Notice is given to supervise children and to never allow them to stare into the projector beam at any distance from the projector.
- Notice is given to use caution when using the remote control for starting the projector while in front of the projection lens.
- Notice is given to the user to avoid the use of optical aids such as binoculars or telescopes inside the beam.
- As with any bright light source, do not stare into the beam, RG2 IEC 62471-5:2015.
- WARNING: MOUNT ABOVE THE HEADS OF CHILDREN.** The use of a ceiling mount is recommended with this product to place it above the eyes of children.

3D Safety Information

Please follow all warnings and precautions as recommended before you or your child use the 3D function.

Warning

Children and teenagers may be more susceptible to health issues associated with viewing in 3D and should be closely supervised when viewing these images.

Photosensitive Seizure Warning and Other Health Risks

- Some viewers may experience an epileptic seizure or stroke when exposed to certain flashing images or lights contained in certain Projector pictures or video games. If you suffer from, or have a family history of epilepsy or strokes, please consult with a medical specialist before using the 3D function.
- Even those without a personal or family history of epilepsy or stroke may have an undiagnosed condition that can cause photosensitive epileptic seizures.
- Pregnant women, the elderly, sufferers of serious medical conditions, those who are sleep deprived or under the influence of alcohol should avoid utilizing the unit's 3D functionality.
- If you experience any of the following symptoms, stop viewing 3D pictures immediately and consult a medical specialist: (1) altered vision; (2) light-headedness; (3) dizziness; (4) involuntary movements such as eye or muscle twitching; (5) confusion; (6) nausea; (7) loss of awareness; (8) convulsions; (9) cramps; and/ or (10) disorientation. Children and teenagers may be more likely than adults to experience these symptoms. Parents should monitor their children and ask whether they are experiencing these symptoms.
- Watching 3D projection may also cause motion sickness, perceptual after effects, disorientation, eye strain and decreased postural stability. It is recommended that users take frequent breaks to lessen the potential of these effects. If your eyes show signs of fatigue or dryness or if you have any of the above symptoms, immediately discontinue use of this device and do not resume using it for at least thirty minutes after the symptoms have subsided.
- Watching 3D projection while sitting too close to the screen for an extended period of time may damage your eyesight. The ideal viewing distance should be at least three times the screen height. It is recommended that the viewer's eyes are level with the screen.
- Watching 3D projection while wearing 3D glasses for an extended period of time may cause a headache or fatigue. If you experience a headache, fatigue or dizziness, stop viewing the 3D projection and rest.
- Do not use the 3D glasses for any other purpose than for watching 3D projection.
- Wearing the 3D glasses for any other purpose (as general spectacles, sunglasses, protective goggles, etc.) may be physically harmful to you and may weaken your eyesight.
- Viewing in 3D projection may cause disorientation for some viewers. Accordingly, DO NOT place your 3D PROJECTOR near open stairwells, cables, balconies, or other objects that can be tripped over, run into, knocked down, broken or fallen over.

Copyright

This publication, including all photographs, illustrations and software, is protected under international copyright laws, with all rights reserved. Neither this manual, nor any of the material contained herein, may be reproduced without written consent of the author.

© Copyright 2021

Disclaimer

The information in this document is subject to change without notice. The manufacturer makes no representations or warranties with respect to the contents hereof and specifically disclaims any implied warranties of merchantability or fitness for any particular purpose. The manufacturer reserves the right to revise this publication and to make changes from time to time in the content hereof without obligation of the manufacturer to notify any person of such revision or changes.

Trademark Recognition

Kensington is a U.S. registered trademark of ACCO Brand Corporation with issued registrations and pending applications in other countries throughout the world.

HDMI, the HDMI Logo, and High-Definition Multimedia Interface are trademarks or registered trademarks of HDMI Licensing LLC in the United States and other countries.

DLP®, DLP Link and the DLP logo are registered trademarks of Texas Instruments and BrilliantColor™ is a trademark of Texas Instruments.

Amazon, Alexa and all related logos are trademarks of Amazon.com, Inc. or its affiliates.

All other product names used in this manual are the properties of their respective owners and are Acknowledged.

FCC

This device has been tested and found to comply with the limits for a Class B digital device pursuant to Part 15 of the FCC rules. These limits are designed to provide reasonable protection against harmful interference in a residential installation. This device generates, uses and can radiate radio frequency energy and, if not installed and used in accordance with the instructions, may cause harmful interference to radio communications.

However, there is no guarantee that interference will not occur in a particular installation. If this device does cause harmful interference to radio or television reception, which can be determined by turning the device off and on is encouraged to try to correct the interference by one or more of the following measures:

- Reorient or relocate the receiving antenna.
- Increase the separation between the device and receiver.
- Connect the device into an outlet on a circuit different from that to which the receiver is connected.
- Consult the dealer or an experienced radio/television technician for help.

Notice: Shielded cables

All connections to other computing devices must be made using shielded cables to maintain compliance with FCC regulations.

Caution

Changes or modifications not expressly approved by the manufacturer could void the user's authority, which is granted by the Federal Communications Commission, to operate this projector.

Operation Conditions

This device complies with Part 15 of the FCC Rules. Operation is subject to the following two conditions:

1. This device may not cause harmful interference and
2. This device must accept any interference received, including interference that may cause undesired operation.

Notice: Canadian users

This Class B digital apparatus complies with Canadian ICES-003 (B).

Remarque à l'intention des utilisateurs canadiens

Cet appareil numérique de la classe B est conforme à la norme NMB-003 (B) du Canada.

Declaration of Conformity for EU countries

- EMC Directive 2014/30/EU (including amendments)
- Low Voltage Directive 2014/35/EU
- Radio Equipment Directive (RED) 2014/53/EU

WEEE



Disposal instructions

Do not throw this electronic device into the trash when discarding. To minimize pollution and ensure utmost protection of the global environment, please recycle it.

INTRODUCTION

Package Overview

Carefully unpack and verify that you have the items listed below under standard accessories. Some of the items under optional accessories may not be available depending on the model, specification and your region of purchase. Please check with your place of purchase. Some accessories may vary from region to region.

The warranty card is only supplied in some specific regions. Please consult your dealer for detailed information.

Standard accessories

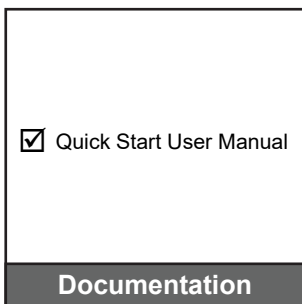
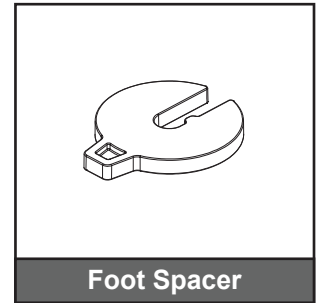
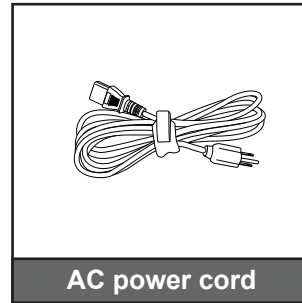
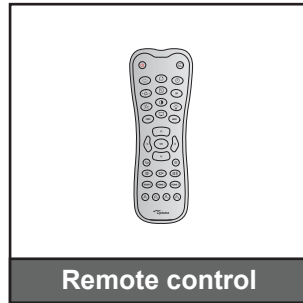
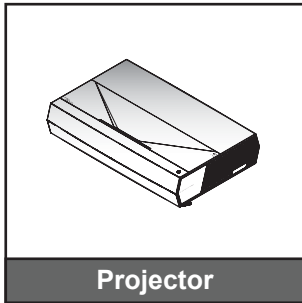

Note:

- The actual remote control may vary depending on the region.
- (*) For European warranty information, please visit www.optoma.com.



Please scan the QR code or visit the following URL: <https://www.optoma.com/support/download>

INTRODUCTION

Product Overview

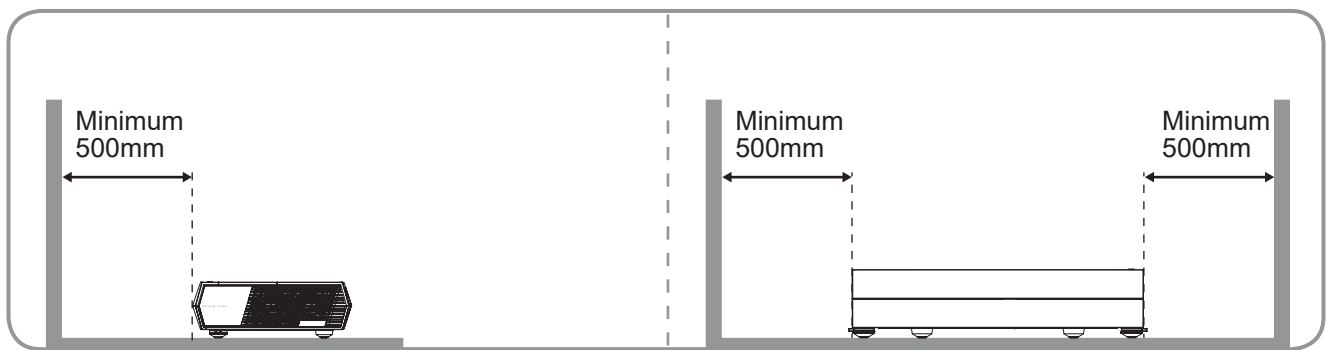
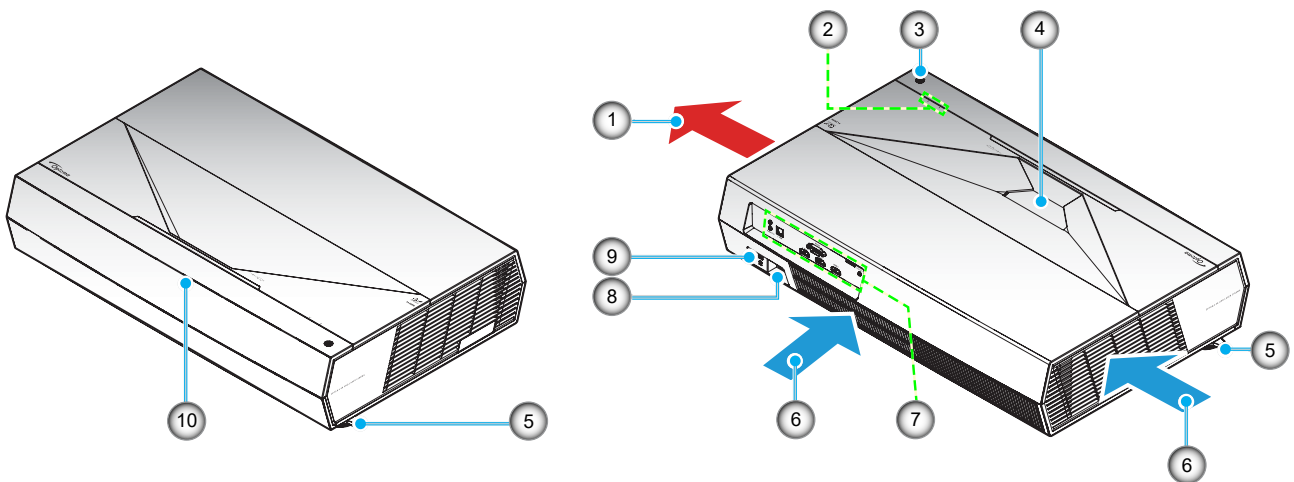

Note:

- Do not block projector intake and exhaust vents.
- When operating the projector in an enclosed space, allow at least 50cm (19") clearance around the intake and exhaust vents.

| No | Item | No | Item |
|----|----------------------|-----|-----------------------|
| 1. | Ventilation (outlet) | 6. | Ventilation (inlet) |
| 2. | LED Indicators | 7. | Input / Output |
| 3. | Power Button | 8. | Power Socket |
| 4. | Lens | 9. | Kensington™ Lock Port |
| 5. | Tilt-Adjustment Foot | 10. | IR Receiver |

INTRODUCTION

Connections

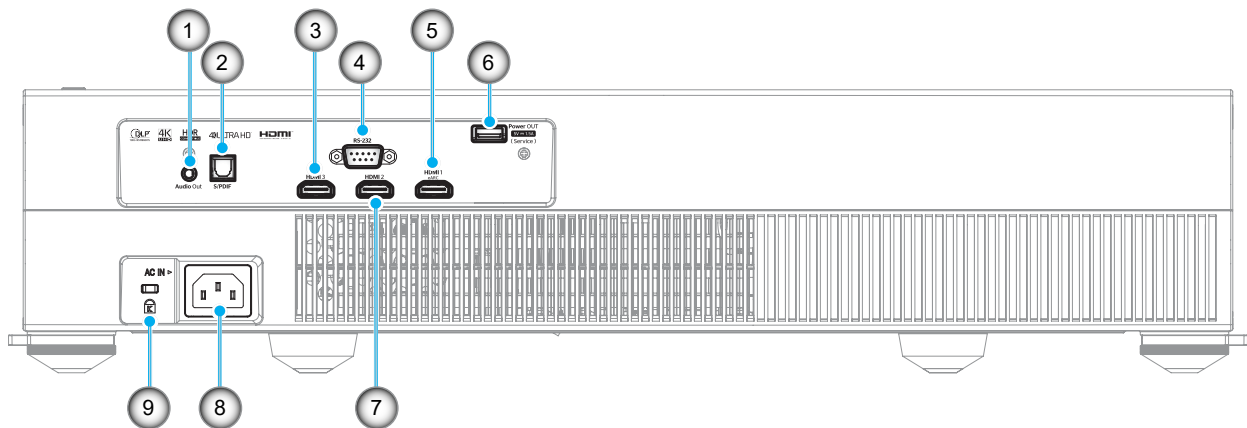

| No | Item | No | Item |
|----|--|----|-----------------------------|
| 1. | Audio Out Port | 6. | USB Port (Power 5V/1.5A)(*) |
| 2. | S/PDIF Port (PCM 2-channel, Digital 5.1) | 7. | HDMI 2 Port (HDMI v2.0) |
| 3. | HDMI 3 Port (HDMI v2.0) | 8. | Power Socket |
| 4. | RS-232 Port | 9. | Kensington™ Lock Port |
| 5. | HDMI 1 Port (HDMI v2.0 eARC) | | |

Note: (*) Not recommended for charging a cell phone.

Keypad and LED indicators

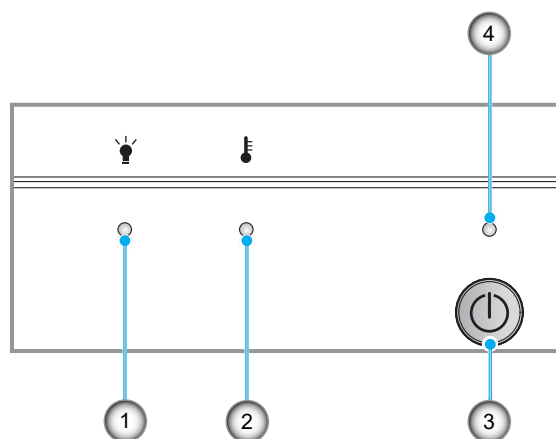

| No | Item | No | Item |
|----|------------------|----|--------------|
| 1. | Light Source LED | 3. | Power Button |
| 2. | Temp LED | 4. | Power LED |

INTRODUCTION

Remote control

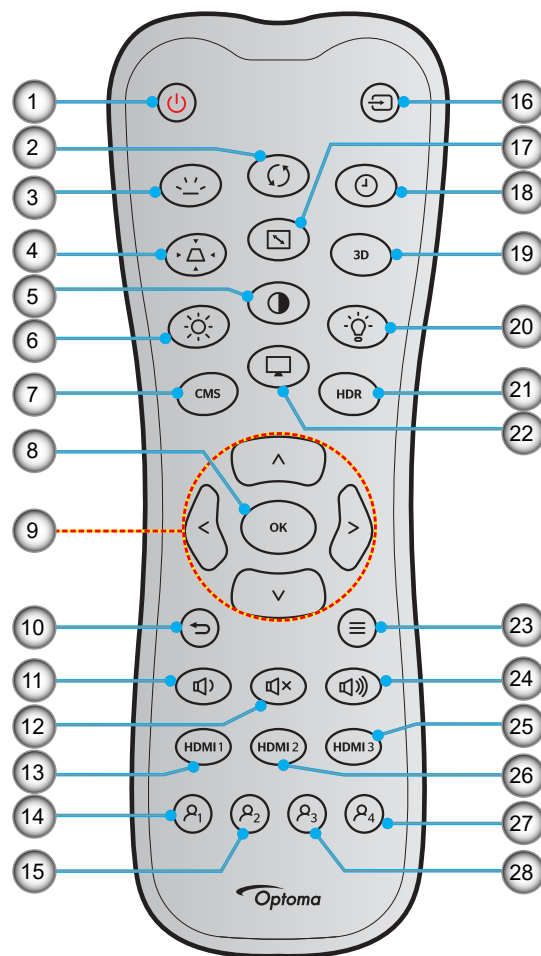

| No | Item | No | Item |
|-----|------------------------------|-----|--------------------|
| 1. | Power On | 15. | User2 (assignable) |
| 2. | Re-sync | 16. | Source |
| 3. | Backlight | 17. | Aspect Ratio |
| 4. | Keystone | 18. | Sleep Timer |
| 5. | Contrast | 19. | 3D Menu On / Off |
| 6. | Brightness | 20. | Lamp |
| 7. | CMS | 21. | HDR |
| 8. | Enter | 22. | Mode |
| 9. | Four Directional Select Keys | 23. | Menu |
| 10. | Return | 24. | Vol + |
| 11. | Vol - | 25. | HDMI3 |
| 12. | Mute | 26. | HDMI2 |
| 13. | HDMI1 | 27. | User4 (assignable) |
| 14. | User1 (assignable) | 28. | User3 (assignable) |

Note:

- The actual remote control may vary depending on the region.
- Some keys may have no function for models that do not support these features.

SETUP AND INSTALLATION

Your projector is designed to be installed in one of four possible positions.

Your room layout or personal preference will dictate which installation location you select. Take into consideration the size and position of your screen, the location of a suitable power outlet, as well as the location and distance between the projector and the rest of your equipment.

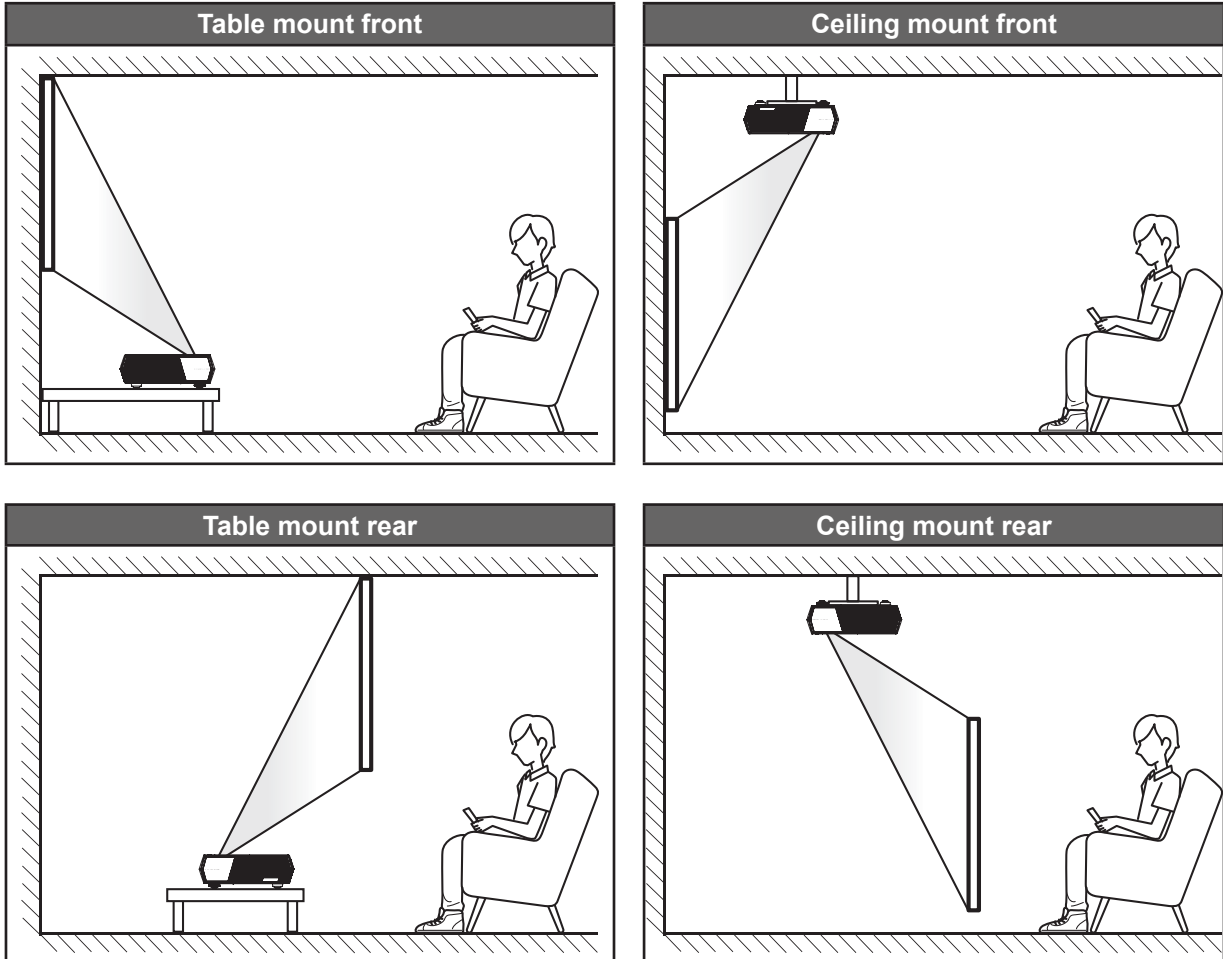

- How to determine projector location for a given screen size, please refer to distance table on page 42.
- How to determine screen size for a given distance, please refer to distance table on page 42.

Note:

- *The further away the projector is placed from the screen the projected image size increases and vertical offset also increases proportionally.*
- *The vertical offset may vary between projectors, due to the limitations of optical manufacturing. Additional adjustments may occur when switching projectors.*

IMPORTANT!

Do not operate the projector in any orientation other than table top or ceiling mount. The projector should be horizontal and not tilted either forwards/backwards or left/right. Any other orientation will invalidate the warranty and may shorten the lifetime of the projector lamp or the projector itself. For non-standard installation advise please contact Optoma.

SETUP AND INSTALLATION

Connecting sources to the projector

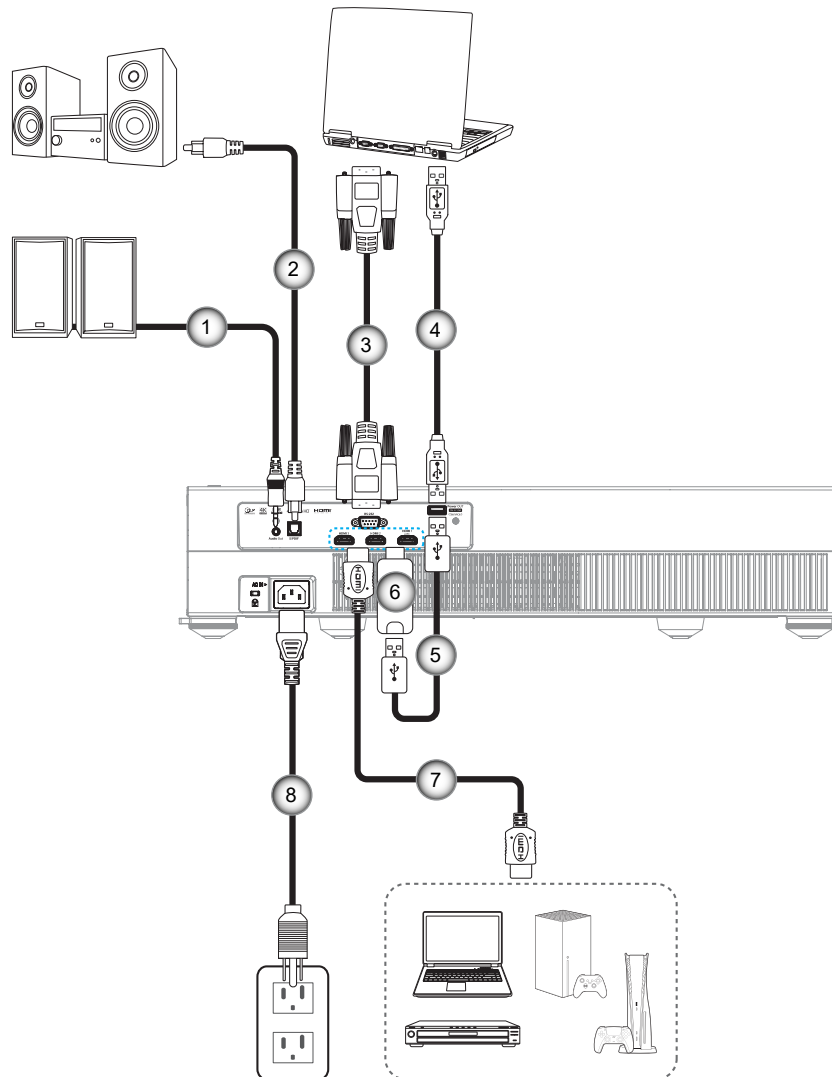

| No | Item |
|----|---|
| 1. | Audio Out Cable |
| 2. | S/PDIF Out Cable |
| 3. | RS232 Cable |
| 4. | USB Cable (Service only / DDP FW upgrade) |

| No | Item |
|----|-----------------|
| 5. | USB Power Cable |
| 6. | HDMI Dongle |
| 7. | HDMI Cable |
| 8. | Power Cord |

Note:

- You can connect a USB mouse or keyboard to the USB port.
- To ensure the best image quality and avoid connection errors, we recommend the use of Premium HDMI cables. For the cable lengths longer than 20-25 feet, we strongly recommend using Active Fiber HDMI cables.

SETUP AND INSTALLATION

Adjusting the projector image

Image height

The projector is equipped with elevator feet for adjusting the image height.

1. Locate the adjustable foot you wish to adjust on the underside of the projector.
2. Rotate the adjustable foot clockwise or counterclockwise to raise or lower the projector.

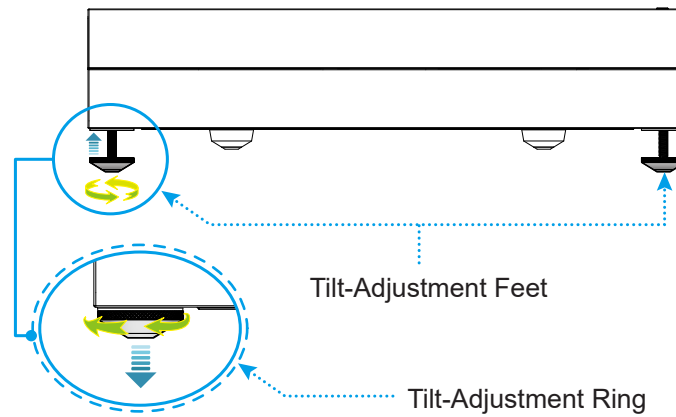

Note: If you want to level the projector, rotate the adjustable feet and attach a foot spacer to both feet. Then tighten the feet.

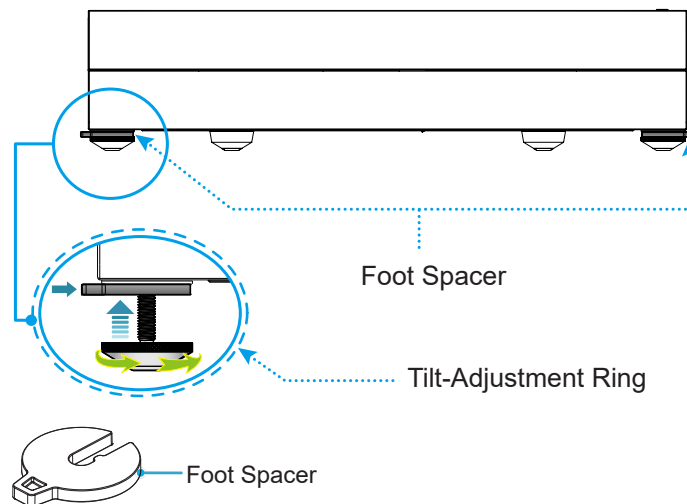

SETUP AND INSTALLATION

Remote setup

Installing / replacing the batteries

Two AAA size batteries are supplied for the remote control.

1. Remove the battery cover on the back of the remote control.
2. Insert AAA batteries in the battery compartment as illustrated.
3. Replace back cover on remote control.

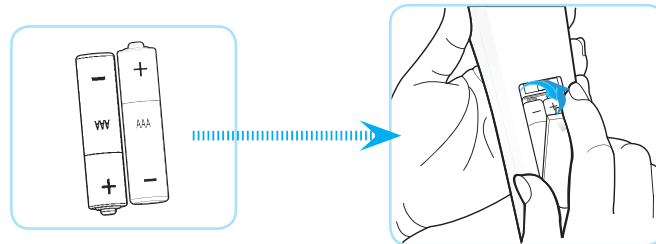

Note: Replace only with the same or equivalent type batteries.

CAUTION

Improper use of batteries can result in chemical leakage or explosion. Be sure to follow the instructions below.

- Do not mix batteries of different types. Different types of batteries have different characteristics.
- Do not mix old and new batteries. Mixing old and new batteries can shorten the life of new batteries or cause chemical leakage in old batteries.
- Remove batteries as soon as they are depleted. Chemicals that leak from batteries that come in contact with skin can cause a rash. If you find any chemical leakage, wipe thoroughly with a cloth.
- The batteries supplied with this product may have a shorter life expectancy due to storage conditions.
- If you will not be using the remote control for an extended period of time, remove the batteries.
- When you dispose of the batteries, you must obey the law in the relative area or country.

SETUP AND INSTALLATION

Effective range

Infra-Red (IR) remote control sensor is located on the front of the projector. Ensure to hold the remote control at an angle within $\pm 15^\circ$ perpendicular to the projector's IR remote control sensor to function correctly. The distance between the remote control and the sensor should not be longer than 6 meters (~19.6 feet).

You can also operate the remote control by pointing it to the projected image.

Note: When pointing the remote control directly (0 degrees angle) on the IR sensor, the distance between the remote control and the sensor should not be longer than 8 meters (~26.2 feet).

- Make sure that there are no obstacles between the remote control and the IR sensor on the projector that might obstruct the infra-red beam.
- Make sure the IR transmitter of the remote control is not being shined by sunlight or fluorescent lamps directly.
- Please keep the remote controller away from fluorescent lamps for over 2 meters or the remote controller might become malfunction.
- If the remote control is close to Inverter-Type fluorescent lamps, it might become ineffective from time to time.
- If the remote control and the projector are within a very short distance, the remote control might become ineffective.
- For Bluetooth pairing, after powering on the projector, make sure to aim the remote control to the area marked with a red circle on the image below.
- If the standby Power Mode is set to "Eco", after powering on the projector, make sure to aim the remote control to the IR receiver directly.

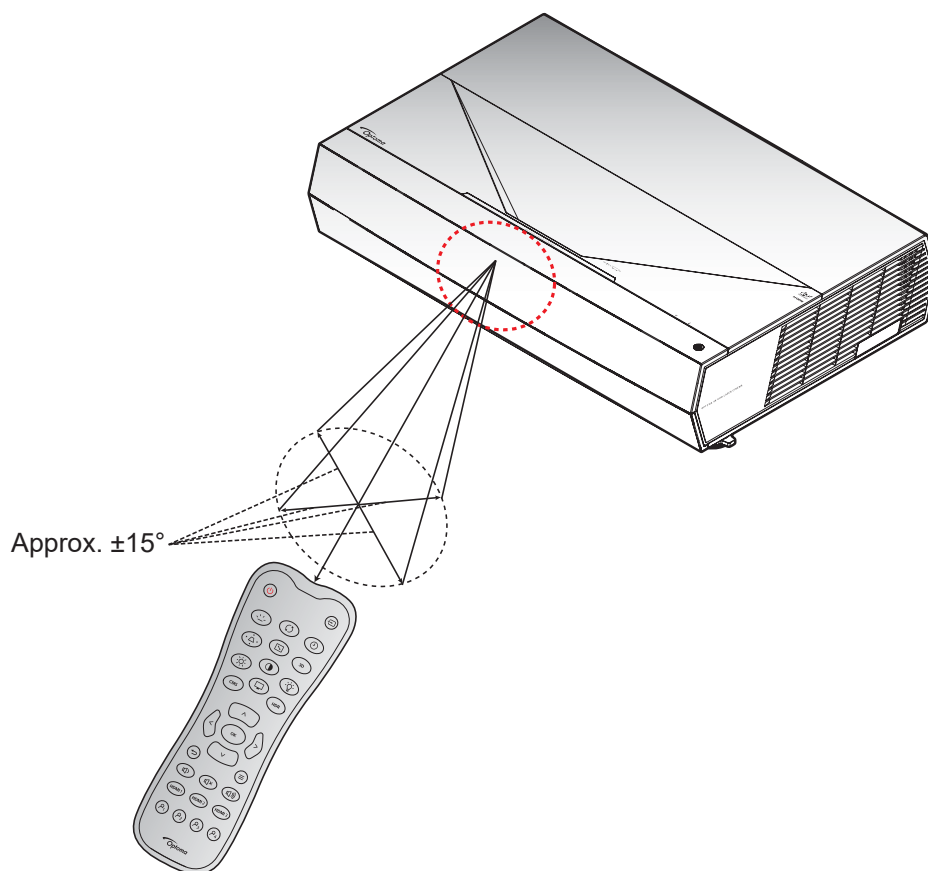

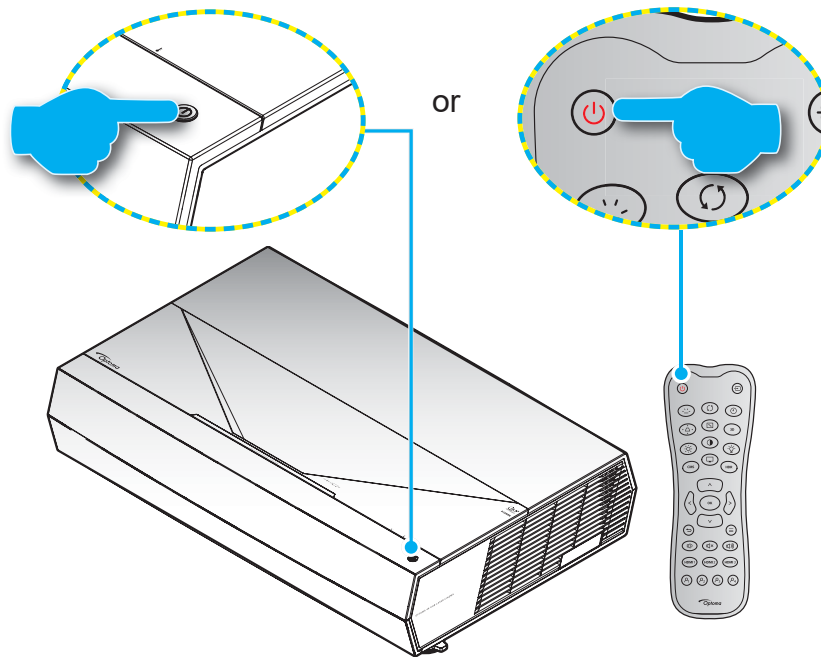

USING THE PROJECTOR

Powering on / off the projector





Powering on





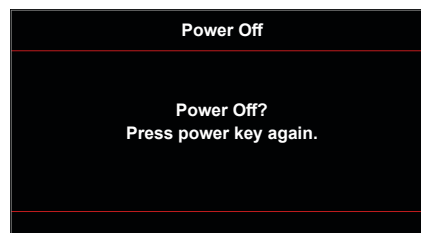

1. Securely connect the power lead and signal/source cable. When connected, the Power LED will turn red.
2. Turn on the projector by pressing the  button on the projector keypad or the  button on the remote control.
3. A start up screen will display in approximately 20 seconds and the Power LED will be flashing white.

Note: *The first time the projector is turned on, you will be prompted to select the preferred language, projection orientation, and other settings.*

Powering off

1. Turn off the projector by pressing the  button on the projector keypad or the  button on the remote control.
2. The following message will be displayed:



3. Press the  /  button again to confirm, otherwise the message will disappear after 10 seconds. When you press the  /  button for the second time, the projector will shut down.
4. The cooling fans will continue to operate for about 10 seconds for the cooling cycle and the Power LED will flash white. When the Power LED turns solid red, this indicates the projector has entered standby mode. If you wish to turn the projector back on, you must wait until the cooling cycle has finished and the projector has entered standby mode. When the projector is in standby mode, simply press the  /  button again to turn on the projector.
5. Disconnect the power lead from the electrical outlet and the projector.

Note: *It is not recommended that the projector is turned on immediately, right after a power off procedure.*

During startup the power LED is flashing white and during normal operation, the power LED is solid white.

USING THE PROJECTOR

Selecting an input source



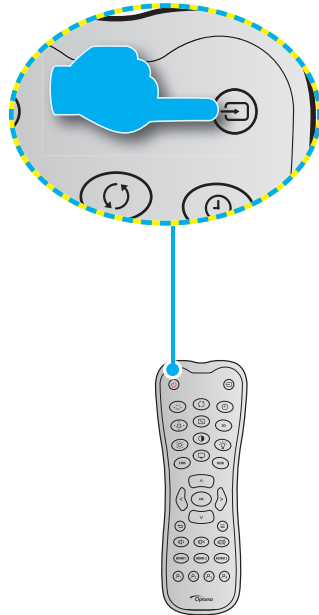







Turn on the connected source that you want to display on the screen, such as computer, notebook, video player, etc. The projector will automatically detect the source. If multiple sources are connected, press the **Source** button on the remote control to select the desired input.



USING THE PROJECTOR

Menu navigation and features

The projector has multilingual on-screen display menus that allow you to make image adjustments and change a variety of settings. The projector will automatically detect the source.

1. To open the OSD menu, press the  button on the remote control.
2. When OSD is displayed, use   keys to select any item in the main menu. While making a selection on a particular page, press the  button on the remote control to enter sub menu.
3. Use   keys to select the desired item in the sub menu and then press the  button to view further settings. Adjust the settings by using   keys.
4. Select the next item to be adjusted in the sub menu and adjust as described above.
5. Press the  button to confirm, and the screen will return to the main menu.
6. To exit, press the  button again. The OSD menu will close and the projector will automatically save the new settings.

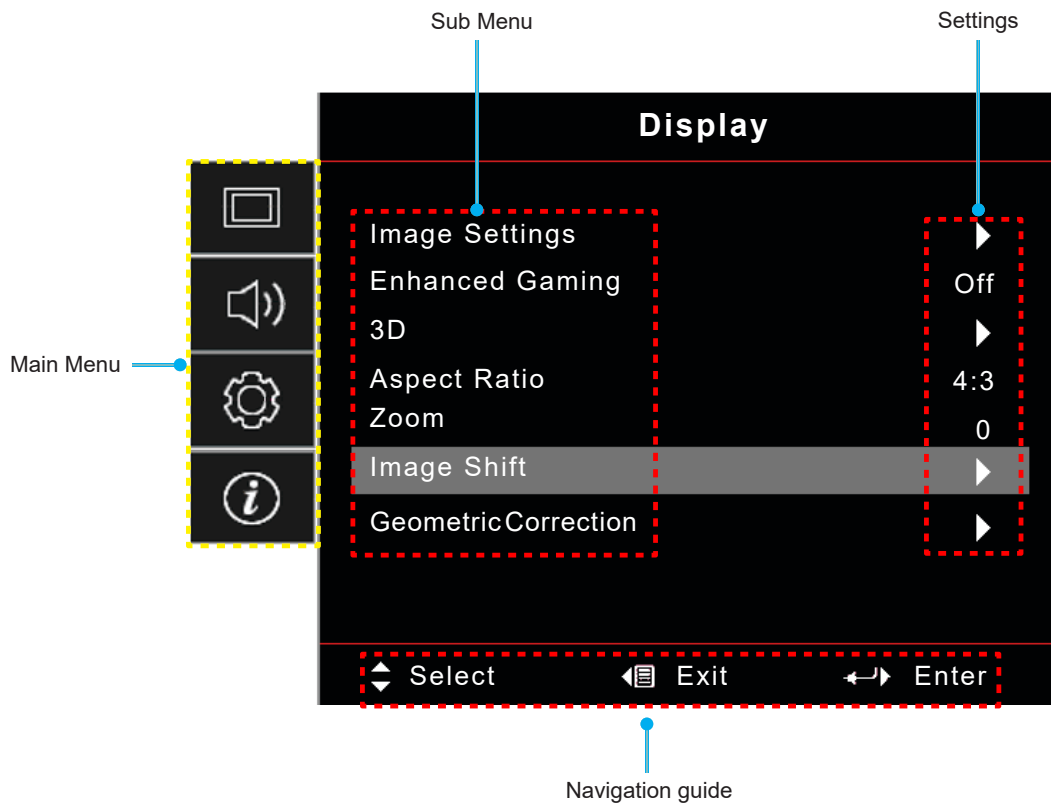

USING THE PROJECTOR

OSD Menu tree







Note: The OSD menu tree items and features are subject to models and region. Optoma reserve the right to add or remove items to improve product performance without notice.

| Main Menu | Sub Menu 1 | Sub Menu 2 | Sub Menu 3 | Sub Menu 4 | Values | | |
|-----------|----------------|--------------|---------------|------------------|----------------|--------------------|----------|
| Display | Image Settings | Display Mode | [Video] Mode | | Cinema | | |
| | | | | | Film | | |
| | | | | | HDR | | |
| | | | | | HLG | | |
| | | | | | HDR SIM. | | |
| | | | | | Game | | |
| | | | | | Reference | | |
| | | | | | Bright | | |
| | | | | | User | | |
| | | | | | 3D | | |
| | | | | | ISF Day | | |
| | | | | | ISF Night | | |
| | | | | | ISF 3D | | |
| | | | Wall Color | | Off (Default) | | |
| | | | | | Blackboard | | |
| | | | | | Light Yellow | | |
| | | | | | Light Green | | |
| | | | | | Light Blue | | |
| | | | | | Pink | | |
| | | | Dynamic Range | HDR / HLG | | Off | |
| | | | | | | Auto [Default] | |
| | | | | HDR Picture Mode | | Bright | |
| | | | | | | Standard [Default] | |
| | | | | | | Film | |
| | | | | HLG Picture Mode | | Detail | |
| | | | | | | Bright | |
| | | | | | | Standard [Default] | |
| | | | | | HDR-Brightness | | Film |
| | | | | | | | Detail |
| | | | | | | 0 ~ 10 | |
| | | | | Brightness | | | -50 ~ 50 |
| | | | | Contrast | | | -50 ~ 50 |
| | | | | Sharpness | | | 1 ~ 15 |
| | | | | Color | | | -50 ~ 50 |
| | | | | Tint | | | -50 ~ 50 |

USING THE PROJECTOR

| Main Menu | Sub Menu 1 | Sub Menu 2 | Sub Menu 3 | Sub Menu 4 | Values | |
|-----------|----------------|----------------|------------------------------|-------------------|-------------------|-----------------------|
| Display | Image Settings | Gamma | Film | | | |
| | | | Video | | | |
| | | | Graphics | | | |
| | | | Standard(2.2) | | | |
| | | | 1.8 | | | |
| | | | 2.0 | | | |
| | | | 2.4 | | | |
| | | Color Settings | BrilliantColor™ | | | 1 ~ 10 |
| | | | | Color Temperature | | Warm |
| | | | | | | Standard |
| | | | | | | Cool |
| | | | | | Cold | |
| | | | Color Matching | Color | | Red [Default] |
| | | | | | | Green |
| | | | | | | Blue |
| | | | | | | Cyan |
| | | | | | | Yellow |
| | | | | | | Magenta |
| | | | | | | White(*) |
| | | | | | Hue / R(*) | -50 ~ 50 [Default: 0] |
| | | | | | Saturation / G(*) | -50 ~ 50 [Default: 0] |
| | | | | | Gain / B(*) | -50 ~ 50 [Default: 0] |
| | | | | RGB Gain/Bias | Reset | |
| | | | | | Yes | |
| | | | Exit | | | |
| | | | Red Gain | | | -50 ~ 50 |
| | | | Green Gain | | | -50 ~ 50 |
| | | | Blue Gain | | | -50 ~ 50 |
| | | | Red Bias | | | -50 ~ 50 |
| | | | Green Bias | | | -50 ~ 50 |
| | | | Blue Bias | | -50 ~ 50 | |
| | | | Color Space (Not HDMI Input) | Reset | | Cancel [Default] |
| | | | | | Yes | |
| | | | | Exit | | |
| | | | Color Space (HDMI Input) | | | Auto [Default] |
| | | | | | | RGB |
| | | | | | | YUV |
| | | | | | Auto [Default] | |
| | | | | | RGB(0~255) | |
| | | | | | RGB(16~235) | |
| | | | | YUV | | |





USING THE PROJECTOR

| Main Menu | Sub Menu 1 | Sub Menu 2 | Sub Menu 3 | Sub Menu 4 | Values | |
|-----------|-----------------------|-----------------|---|------------|---|-------------------------|
| Display | Image Settings | Brightness Mode | | | DynamicBlack | |
| | | | | | Eco. | |
| | | | | | Constant Power Power =100%/95%/90%/85%/80%/75%/70%/65%/60%/55%/50% | |
| | | | | | Constant Luminance Power=85%/80%/75%/70% | |
| | | Reset | | | | |
| | Enhanced Gaming | | | | | Off |
| | | | | | | On |
| | 3D | 3D Mode | | | | Off [Default] |
| | | | | | | On |
| | | 3D Sync Invert | | | | On |
| | Aspect Ratio | | | | | Off [Default] |
| | | | | | | 4:3 |
| | | | | | | 16:9 |
| | | | | | | 21:9 |
| | | | | | | 32:9 |
| | | | | | | V-Stretch |
| | | | | | | Full screen |
| | Zoom | | | | | Auto |
| | Image Shift | | H  | | | -100 ~ 100 [Default: 0] |
| | | | V  | | | -100 ~ 100 [Default: 0] |
| | Geometric Correction | | Four Corner | | | |
| | | H Keystone | | | -10 ~ 10 [Default: 0] | |
| | | V Keystone | | | -10 ~ 10 [Default: 0] | |
| | | 3x3 Warp | | | | |
| | | Reset | | | | |
| Audio | Audio Mode | | | | Speaker / Audio Out [Default] | |
| | | | | | SPDIF / eARC | |
| | Mute | | | | | Off [Default] |
| | | | | | On | |
| Volume | | | | | 0 ~ 10 [Default: 5] | |
| Setup | Projection | | | | Front  [Default] | |
| | | | | | Rear  | |
| | | | | | Ceiling-top  | |
| | | | | | Rear-top  | |
| | Power Settings | Direct Power On | | | | Off [Default] |
| | | | | | | On |
| | | Signal Power On | | | | |
| | | | | | On | |
| | Auto Power Off (min.) | | | | 0 ~ 180 (5 min increments) [Default: 20] | |

USING THE PROJECTOR

| Main Menu | Sub Menu 1 | Sub Menu 2 | Sub Menu 3 | Sub Menu 4 | Values | |
|-----------|-----------------------|---------------------|----------------------|---------------|---|--------------------|
| Setup | Power Settings | Sleep Timer (min.) | Always On | | 0 ~ 990 (30 min increments) [Default: 0] | |
| | | | | | No [Default] | |
| | | | | | Yes | |
| | | | Power Mode (Standby) | | | Active (SmartHome) |
| | | | | Eco [Default] | | |
| | | USB Power (Standby) | | | Off [Default] | |
| | | | | On | | |
| | Security | Security | | | Off | |
| | | | | On | | |
| | | Security Timer | Month | | | |
| | | | Day | | | |
| | Hour | | | | | |
| | | Change Password | | | [Default: 1234] | |
| | HDMI Link Settings | HDMI Link | | | Off [Default] | |
| | | | | On | | |
| | | Inclusive of TV | | | No [Default] | |
| | | | | Yes | | |
| | | Power On Link | | | Mutual [Default] | |
| | | | | | PJ --> Device | |
| | | | | | Device --> PJ | |
| | | Power Off Link | | | Off [Default] | |
| | | | | On | | |
| | Test Pattern | | | | Green Grid | |
| | | | | | Magenta Grid | |
| | | | | | White Grid | |
| | | | | | White | |
| | | | | | Off | |
| | Remote Settings | User 1 | | | Fixed on "Focus -" | |
| | | User 2 | | | Fixed on "Focus +" | |
| | | User 3 | | | Fixed on "HDMI3" | |
| | Projector ID | | | | 00 ~ 99 | |
| | Focus | | | | (Press Left or Right) | |
| | Eye Protection Sensor | | | | On [Default] | |
| | | | | | Off | |
| | Options | Language | | | | English [Default] |
| | | | | | | Deutsch |
| | | | | | | Français |
| | | | | | | Italiano |
| | | | | | | Español |
| | | | | | | Português |
| | | | | | | 簡體中文 |
| | | | | | | 繁體中文 |
| | | | | | 日本語 | |
| | | | | | 한국어 | |
| | | | Русский | | | |

USING THE PROJECTOR

| Main Menu | Sub Menu 1 | Sub Menu 2 | Sub Menu 3 | Sub Menu 4 | Values | |
|-----------|------------------|-------------------|------------------|---------------------------------|--|---------------|
| Setup | Options | Menu Settings | Menu Location | | Top Left  | |
| | | | | | Top Right  | |
| | | | | | Center  [Default] | |
| | | | | | Bottom Left  | |
| | | | | | Bottom Right  | |
| | | | Menu Timer | | Off | |
| | | | | | 5sec | |
| | | | | | 10sec [Default] | |
| | | | | Auto Source | | Off [Default] |
| | | | | | | On |
| | | Input Source | | HDMI1 | | |
| | | | | HDMI2 | | |
| | | | | HDMI3 | | |
| | | Input Name | | HDMI1 | Default [Default] / Custom | |
| | | | | HDMI2 | Default [Default] / Custom | |
| | | | | HDMI3 | Default [Default] / Custom | |
| | | High Altitude | | | Off [Default] | |
| | | | | | On | |
| | | Display Mode Lock | | | Off [Default] | |
| | | | | | On | |
| | Information Hide | | | Off [Default] | | |
| | | | | On | | |
| | Logo | | | Default [Default] | | |
| | | | | Neutral | | |
| | Background Color | | | None [Default for Video/Pro-AV] | | |
| | | | | Blue [Default for Data model] | | |
| | | | | Red | | |
| | | | | Green | | |
| | | | Gray | | | |
| Reset | Reset OSD | | Cancel [Default] | | | |
| | | | Yes | | | |
| | Reset to Default | | Cancel [Default] | | | |
| | | | Yes | | | |
| Info | Regulatory | | | | | |
| | Serial Number | | | | | |
| | Source | | | | | |
| | Resolution | | | | 00x00 | |
| | Refresh Rate | | | | 0.00Hz | |
| | Display Mode | | | | | |
| | Projector ID | | | | 00~99 | |
| | Brightness Mode | | | | | |
| | FW Version | System | | | | |
| MCU | | | | | | |

Note: Functions vary depending on model definition.

USING THE PROJECTOR

Display menu

Image settings menu

Display Mode

There are several predefined display modes that you can choose from to suit your viewing preference. Each mode has been fine-tuned by our expert colour team to ensure superior colour performance for wide range of content.

- **Cinema:** Provides the best balance of detail and colors for watching movies.
- **HDR:** Delivers color that is highly accurate, exceeding the color performance of the other display modes. This mode decodes and displays High Dynamic Range (HDR) content for the deepest blacks, brightest whites, and vivid cinematic color using REC.2020 color gamut.
Note: *This mode will be automatically enabled if HDR is set to Auto (and HDR content is sent to projector – 4K UHD Blu-ray, 1080p/4K UHD HDR games, 4K UHD streaming video). While HDR mode is active, all other display modes will be greyed out.*
- **HLG:** Delivers color that is highly accurate, exceeding the color performance of the other display modes. This mode decodes and displays Hybrid Log content (HLG) content for the deepest blacks, brightest whites, and vivid cinematic color using REC.2020 color gamut.
Note: *This mode will be automatically enabled if HDR is set to Auto (and HLG content is sent to projector). While HLG mode is active, all other display modes will be greyed out.*
- **HDR SIM.:** Enhances non-HDR content with simulated High Dynamic Range (HDR). Choose this mode to enhance gamma, contrast, and color saturation for non-HDR content (720p and 1080p Broadcast/Cable TV, 1080p Blu-ray, non-HDR Games, etc).
Note: *This mode can ONLY be used with non-HDR content.*
- **Game:** Optimises your projector for maximum contrast and vivid colours allowing you to see shadow detail when playing video game.
Note: *This display mode cannot be used when viewing HDR video content or playing HDR games. To enable low input lag, please ensure the PC or console is connected to HDMI1 and enable Enhanced Game Mode.*
- **Reference:** This mode reproduces colours as close as possible the image the way the movie director intended. Color, color temperature, brightness, contrast and gamma settings are all configured to Rec.709 color gamut. Select this mode for the most accurate colour reproduction when watching movies.
- **Bright:** This mode is suitable for environments where extra-high brightness is required, such as using the projector in well-lit rooms.
- **User:** Memorizes user defined setting, tailor your own display mode settings.
- **3D:** Optimized settings for watching 3D content.
Note: *To experience the 3D effect, you will need to have compatible DLP Link 3D glasses. See 3D section for more information.*
- **ISF Day:** Save professionally calibrated picture settings optimized for day time viewing.
- **ISF Night:** Save professionally calibrated picture settings optimized for night time viewing.
- **ISF 3D:** Save professionally calibrated picture settings optimized for 3D viewing.

Note:

- ISF modes need to be professionally calibrated. To unlock and access ISF modes, you will need to enter the following code using the remote or keypad: Power > Up > Down > Up > Up.
- ISF modes are available only in Video mode.

USING THE PROJECTOR

- If HDR or HLG are enabled, Cinema, Film, Vivid, Game, Reference, and Bright options are grayed out.

Wall Color

Designed to adjust the colors of the projected image when projecting on to a wall without a screen. Each mode has been fine-tuned by our expert colour team to ensure superior color performance. There are several predefined modes that you can choose from to suit the colour of your wall. Select between off, blackboard, light yellow, light green, light blue, pink, and gray.

Note: *For accurate color reproduction, we recommend using a screen.*

Dynamic Range

Configure the High Dynamic Range (HDR) setting and its effect when displaying video from 4K Blu-ray players and streaming devices.

➤ **HDR/HLG**

- **Off:** Turn off HDR or HLG processing. When set to Off, the projector will NOT decode HDR or HLG content.
- **Auto:** Auto detect HDR signal.

➤ **HDR Picture Mode**

- **Bright:** Choose this mode for brighter more saturated colors.
- **Standard:** Choose this mode for natural looking colors with a balance of warm and cool tones.
- **Film:** Choose this mode for improved detail and image sharpness.
- **Detail:** The signal comes from OETF conversion to achieve the best color matching.

➤ **HLG Picture Mode**

- **Bright:** Choose this mode for brighter more saturated colors.
- **Standard:** Choose this mode for natural looking colors with a balance of warm and cool tones.
- **Film:** Choose this mode for improved detail and image sharpness.
- **Detail:** The signal comes from OETF conversion to achieve the best color matching.

➤ **HDR-Brightness**

- Adjust the brightness level of HDR.

Brightness

Adjust the brightness of the image.

Contrast

The contrast controls the degree of difference between the lightest and darkest parts of the picture.

Sharpness

Adjust the sharpness of the image.

Color

Adjust a video image from black and white to fully saturated color.

Tint

Adjust the color balance of red and green.

USING THE PROJECTOR

Gamma

Set up gamma curve type. After the initial setup and fine tuning is completed, utilize the Gamma Adjustment steps to optimize your image output.

- **Film:** For home theater.
- **Video:** For video or TV source.
- **Graphics:** For PC / Photo source.
- **Standard(2.2):** For standardized setting.
- **1.8 / 2.0 / 2.4:** For specific PC / Photo source. 2.4 can also be used for video content and games to enable deeper contrast.

Color Settings

Configure the color settings.

- **BrilliantColor™:** This adjustable item utilizes a new color-processing algorithm and enhancements to enable higher brightness while providing true, more vibrant colors in picture.
- **Color Temperature:** Select a color temperature from Warm, Standard, Cool, Cold.
- **Color Matching:** Select the following options:
 - Color: Adjust the red (R), green (G), blue (B), cyan (C), yellow (Y), magenta (M), and white (W) level of the image.
 - Hue: Adjust the color balance of red and green.
 - Saturation: Adjust a video image from black and white to fully saturated color.
 - Gain: Adjust the image brightness.
 - Reset: Return the factory default settings for color matching.
 - Exit: Exit the “Color Matching” menu.
- **RGB Gain/Bias:** This settings allows to configure the brightness (gain) and contrast (bias) of an image.
 - Reset: Return the factory default settings for RGB gain/bias.
 - Exit: Exit the “RGB Gain/Bias” menu.
- **Color Space:** Select an appropriate color matrix type from the following: Auto, RGB(0-255), RGB(16-235), and YUV.

Brightness Mode

Adjust the brightness mode settings.

- **DynamicBlack:** Use to automatically adjust the picture brightness in order to give optimum contrast performance.
- **Eco.:** Choose “Eco.” to dim the projector laser diode which will lower power consumption and extend the laser diode life.
- **Constant Power:** Choose the power percentage for brightness mode.
- **Constant Luminance:** Constant Luminance varies the strength of LD luminance such that the brightness maintains consistent with time.

Reset

Return the factory default settings for color settings.

USING THE PROJECTOR

Enhanced Gaming menu

Enable this feature to reduce response times (input latency) during gaming to 4ms*.

Note:

- Only support to HDMI1.
- *Only for 1080p 240Hz signals.
- The input lag by signals is described in the following table:
- The values in the table can vary slightly.

| Source Timing | Enhanced Gaming | Output | Output Resolution | Input Lag |
|---------------|-----------------|----------|-------------------|-----------|
| 1080p60 | On | 1080p60 | 1080p | 17ms |
| 1080p120 | On | 1080p120 | 1080p | 8.6ms |
| 1080p240 | On | 1080p240 | 1080p | 4ms |
| 4K60 | On | 4K60 | 4K | 16.9ms |
| 1080p60 | Off | 1080p60 | 1080p | 33.8ms |
| 1080p120 | Off | 1080p120 | 1080p | 17ms |
| 1080p240 | Off | 1080p240 | 1080p | 8.6ms |
| 4K60 | Off | 4K60 | 4K | 33.7ms |

- Please note that if “Enhanced Gaming” mode is enabled, the Aspect Ratio, Zoom, Image Shift, Four Corner, and H/V Keystone functions are disabled automatically. These functions will be enabled again if you disable “Enhanced Gaming” mode.

3D menu

3D Mode

Use this option to enable/disable the 3D mode function.

3D Sync Invert

Use this option to enable/disable the 3D sync invert function.

Aspect Ratio menu

Select the aspect ratio of the displayed image between the following options:

- **4:3:** This format is for 4:3 input sources.
- **16:9/21:9/32:9:** These formats are for 16:9/21:9/32:9 input sources, like HDTV and DVD enhanced for Wide screen TV.
- **V-Stretch:** This mode stretches a 2.35:1 image vertically removing the black bars.
- **Full Screen:** Use this special 2.0:1 aspect ratio to display both 16:9 and 2.35:1 aspect ratio movies without black bars at the top and bottom of the screen.
- **Auto:** Automatically selects the appropriate display format.

Note:

- The “Aspect Ratio” option is grayed out if the Enhanced Gaming, 3x3 Warp, or Four Corner functions are enabled.
- Detailed informations about V-Stretch mode:
 - Some Letter-Box Format DVDs are not enhanced for 16x9 TVs. In this situation, the image will not look right when displaying image in 16:9 mode. In this situation, please try to use the 4:3 mode to view the DVD. If the content is not 4:3, there will be black bars around the image in 16:9 display. For this type of content, you can use V-Stretch mode to fill the image on the 16:9 display.
 - If you use an external anamorphic lens, this V-Stretch mode also allows you to watch a 2.35:1 content (include Anamorphic DVD and HDTV film source) that supports anamorphic wide is

USING THE PROJECTOR

enhanced for 16x9 Display in a wide 2.35:1 image. In this case, there are no black bars. Light source power and vertical resolution are fully utilized.

- To use the Full Screen format, do the following:
 - a) Set the screen aspect ratio to 2.0:1.
 - b) Select "Full Screen" format.
 - c) Align the projector image correctly on the screen.

The mapping rule for 4K UHD DMD:

| 16 : 9 screen | 480i/p | 576i/p | 720p | 1080i/p | 2160p |
|---------------|---|--------|------|---------|-------|
| 4x3 | Scale to 2880 x 2160 | | | | |
| 16x9 | Scale to 3840 x 2160 | | | | |
| 21x9 | Scale to 3840 x 1644 | | | | |
| 32x9 | Scale to 3840 x 1080 | | | | |
| V-Stretch | Get the central 3840 x 1620 image, and then scale to 3840 x 2160 for display | | | | |
| Full screen | Scale to 5068 x 2852 (132% Enlarge), then get the central 3840 x 2160 image to display Note: Use this format to see the non-subtitle of 2.35:1 source to fulfill 100% of UHD DMD. | | | | |
| Auto | -If source is 4:3, auto resize to 2880 x 2160 -If source is 16:9 auto resize to 3840 x 2160 -If source is 15:9 auto resize to 3600 x 2160 -If source is 16:10 auto resize to 3456 x 2160 | | | | |

Auto mapping rule:

| | Input resolution | | Auto/Scale | |
|-------------|------------------|--------------|------------|------|
| | H-resolution | V-resolution | 3840 | 2160 |
| 4:3 | 800 | 600 | 2880 | 2160 |
| | 1024 | 768 | 2880 | 2160 |
| | 1280 | 1024 | 2880 | 2160 |
| | 1400 | 1050 | 2880 | 2160 |
| | 1600 | 1200 | 2880 | 2160 |
| Wide Laptop | 1280 | 720 | 3840 | 2160 |
| | 1280 | 768 | 3600 | 2160 |
| | 1280 | 800 | 3456 | 2160 |
| SDTV | 720 | 576 | 2700 | 2160 |
| | 720 | 480 | 3240 | 2160 |
| HDTV | 1280 | 720 | 3840 | 2160 |
| | 1920 | 1080 | 3840 | 2160 |

USING THE PROJECTOR

Zoom menu

Use to reduce or magnify an image on the projection screen.

Note: Zoom settings are retained on power cycle of the projector.

Image Shift menu

Adjust the projected image position horizontally (H) or vertically (V).

Note: The image size will reduce slightly when adjusting the horizontal and vertical keystone.

Geometric Correction menu

- **Four Corner:** This setting allows the projected image to be adjusted from each corner to make a square image when the projection surface is not level.
Note: While adjusting the Four Corner, the Zoom, Aspect Ratio, Image Shift, and 3x3 Warp menus are disabled. To enable Zoom, Aspect Ratio, and Image Shift, reset the Four Corner settings to the factory defaults.
- **H Keystone:** Adjust image distortion horizontally and make a squarer image. Horizontal keystone is used to correct a keystone image shape in which the left and right borders of the image are unequal in length. This is intended for use with horizontally on-axis applications.
- **V Keystone:** Adjust image distortion vertically and make a squarer image. Vertical keystone is used to correct a keystone image shape in which the top and bottom are slanted to one of the sides. This is intended when for use with vertically on-axis applications.
- **3x3 Warp:** Adjust the image distortion by 9 points correction.

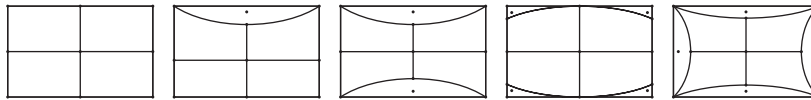

- **Reset:** Return the factory default settings for geometric connection.

Note: When using Enhanced Game Mode, 4 Corner, Horizontal Keystone, Vertical Keystone, and 3x3 warping will be disabled as the settings impact input lag. If you plan to use Enhanced Game Mode for low input lag, we strongly recommend setting up the projector without the use for 4 Corner, Horizontal Keystone, Vertical Keystone, and 3x3 warping.

USING THE PROJECTOR

Audio menu

Audio Mode

Select the appropriate audio mode.

Note:

- *The selected audio mode applies to all sources:*
- *The projector detects automatically Speaker / Audio Out mode.*
- *eARC function is supported only with HDMI1 source.*
- *If the current input audio format is not PCM, system will resync after audio mode has changed.*

Mute

Use this option to temporarily turn off the sound.

- **Off:** Choose “Off” to turn mute off.
- **On:** Choose “On” to turn mute on.

Note: Mute function affects both internal and external speaker volume.

Volume

Adjust the volume level.

Setup menu

Projection

Select the preferred projection between front, rear, ceiling-top, and rear-top.

Power Settings

Configure power settings.

- **Direct Power On:** Choose “On” to activate Direct Power mode. The projector will automatically power on when AC power is supplied, without pressing the “Power” key on the projector keypad or on the remote control.
- **Signal Power On:** Choose “On” to activate Signal Power mode. The projector will automatically power on when a signal is detected, without pressing the “Power” key on the projector Keypad or on the remote control.

Note:

- *If the “Signal Power On” option is turned “On”, the power consumption of the projector in standby mode will be over 3W.*
- *This function is applicable with HDMI source.*
- *“Signal Power On” supports only 1 port at a time.*
- **Auto Power Off (min):** Sets the countdown timer interval. The countdown timer will start, when there is no signal being sent to the projector. The projector will automatically power off when the countdown has finished (in minutes).
- **Sleep Timer (min.):** Configure the sleep timer.
 - Sleep Timer (min.): Sets the countdown timer interval. The countdown timer will start, with or without a signal being sent to the projector. The projector will automatically power off when the countdown has finished (in minutes).

Note: The Sleep Timer is reset every time when the projector is powered off.

- **Always On:** Check to set the sleep timer always on.

USING THE PROJECTOR

- **Power Mode (Standby):** Set the power mode setting.
 - Active: Choose “Active” to return to normal standby.
 - Eco: Choose “Eco.” to save power dissipation further < 0.5W.
- **USB Power (Standby):** Enable or disable the USB power function when the projector is in standby mode.

Security

Configure security settings.

- **Security:** Enable this function to prompt for a password before using the projector.
 - Off: Choose “Off” to be able to switch on the projector without password verification.
 - On: Choose “On” to use security verification when the turning on the projector.
- **Note:** *The default password is 1234.*
- **Security Timer:** Can be select the time (Month/Day/Hour) function to set the number of hours the projector can be used. Once this time has elapsed you will be requested to enter your password again.
- **Change Password:** Use to set or modify the password that is prompted when turning the projector on.

HDMI Link Settings

Note: *When you connect HDMI CEC-compatible devices to the projector with HDMI cables, you can control them on the same power on or power off status using the HDMI Link control feature in the projector’s OSD. This lets one device or multiple devices in a group power on or power off via HDMI Link Feature in a typical configuration, your DVD player may be connected to the projector through an amplifier or home theater system.*

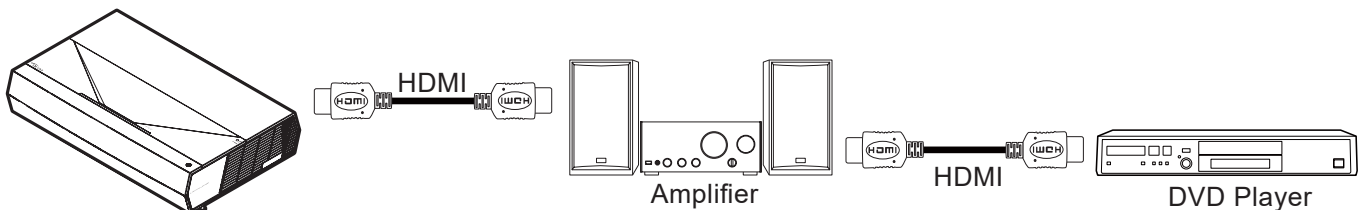

- **HDMI Link:** Enable/disable the HDMI Link function.
- **Inclusive of TV:** If the settings is set to “Yes” then the power on and power off link options are available.
- **Power On Link:** CEC power on command.
 - Mutual: Both projector and CEC device will be turned on simultaneously.
 - PJ → Device: The CEC device will be turned on only after the projector is switched on.
 - Device → PJ: The projector will be switched on only after the CEC device is turned on.
- **Power Off Link:** Enable this function to let both HDMI Link and projector to be automatically turned off at the same time.

Test Pattern

Select the test pattern from green grid, magenta grid, white grid, white, or disable this function (off).

Remote Settings

- **User1:** Fixed on “Focus -”.
- **User2:** Fixed on “Focus +”.
- **User3:** Fixed on “HDMI3”.

USING THE PROJECTOR

Projector ID

ID definition can be set up by menu (range 0-99), and allow user control an individual projector by using RS232 command.

Focus

Press the **User1** or **User2** button on the remote control to automatically adjust focus.

Eye Protection Sensor

Enable eye protection sensor to temporarily switch off the lights when objects are too close to the projector beam.

Options

Configure the projector options.

- **Language:** Select the multilingual OSD menu between English, German, French, Italian, Spanish, Portuguese, Simplified Chinese, Traditional Chinese, Japanese, Korean, and Russian.
- **Menu Settings:** Set the menu location on the screen and configure menu timer settings.
 - **Menu Location:** Select the menu location on the display screen.
 - **Menu Timer:** Set the duration where the OSD menu stays visible on the screen.
- **Auto Source:** Choose this option to let the projector automatically find an available input source.
- **Input Source:** Select the input source between HDMI1, HDMI2, and HDMI3.
- **Input Name:** Use to rename the input function for easier identification. The available options include HDMI1, HDMI2, and HDMI3.
- **High Altitude:** When "On" is selected, the fans will spin faster. This feature is useful in high altitude areas where the air is thin.
- **Display Mode Lock:** Choose "On" or "Off" to lock or unlock adjusting display mode settings.
- **Information Hide:** Enable this function to hide the information message.
 - **Off:** Choose "Off" to show the "searching" message.
 - **On:** Choose "On" to hide the info message.
- **Logo:** Use this function to set the desired startup screen. If changes are made, they will take effect the next time the projector is powered on.
 - **Default:** The default startup screen.
 - **Neutral:** Logo is not displayed on startup screen.
- **Background:** Use this function to display a blue, red, green, gray color, or none when no signal is available.

Reset

Reset the projector.

- **Reset OSD:** Return the factory default settings for OSD menu settings.
- **Reset to Default:** Return the factory default settings for all settings.

USING THE PROJECTOR

Info menu

View the projector information as listed below:

- Regulatory
- Serial Number
- Source
- Resolution
- Refresh Rate
- Display Mode
- Projector ID
- Brightness Mode
- FW Version

ADDITIONAL INFORMATION

Compatible resolutions

Video compatibility

| Signal | Resolution |
|--------|---|
| SDTV | 480i/p, 576i/p |
| HDTV | 720p (50/60Hz), 1080i (50/60Hz), 1080p (24/50/60Hz) |
| UHD | 2160p (24/50/60Hz) |

Video timing in details:

| Signal | Resolution | Refresh Rate (Hz) | Notes |
|--------------|-------------|-------------------|---------------|
| SDTV (480i) | 640 x 480 | 60 | For Component |
| SDTV (480p) | 640 x 480 | 60 | |
| SDTV (576i) | 720 x 576 | 50 | |
| SDTV (576p) | 720 x 576 | 50 | |
| HDTV (720p) | 1280 x 720 | 50/60 | |
| HDTV (1080i) | 1920 x 1080 | 50/60 | |
| HDTV (1080p) | 1920 x 1080 | 24/50/60 | |
| HDTV (1080p) | 1920 x 1080 | 240 | |
| WQHD(1440p) | 2560 x 1440 | 120 | |
| UHD (2160p) | 3840 x 2160 | 24/50/60 | |

Computer compatibility

VESA standards (Computer Signal (Analog RGB compatibility)):

| Signal | Resolution | Refresh Rate (Hz) | Notes for Mac |
|-------------|-----------------|-------------------|---------------|
| SVGA | 800 x 600 | 56/60/72 | Mac 60/72 |
| XGA | 1024 x 768 | 60/70/75 | Mac 60/70/75 |
| HDTV(720p) | 1280 x 720 | 50/60 | Mac 60 |
| WXGA | 1280 x 768 | 60/75 | Mac 60/75 |
| WXGA | 1280 x 800 | 60 | Mac 60 |
| WXGA | 1366 x 768 | 60 | Mac 60 |
| WXGA+ | 1440 x 900 | 60 | Mac 60 |
| SXGA | 1280 x 1024 | 60/75 | Mac 60/75 |
| UXGA | 1600 x 1200 | 60 | |
| HDTV(1080p) | 1920 x 1080 | 24/50/60 | Mac 60 |
| WUXGA | 1920 x 1200 (*) | 60 | Mac 60 |

Note: (*)1920 x 1200 @60Hz only supports RB(reduced blanking).

ADDITIONAL INFORMATION

Timing table for PC:

| Signal | Resolution | Frequency H. | Refresh Rate | Video | Digital | Note |
|----------|--------------|--------------|--------------|-------|---------|------|
| | | (KHz) | (Hz) | | | |
| SVGA | 800 x 600 | 35.2 | 56.3 | N/A | √ | 56Hz |
| SVGA | 800 x 600 | 37.9 | 60.3 | N/A | √ | 60Hz |
| SVGA | 800 x 600 | 46.9 | 75 | N/A | √ | N/A |
| SVGA | 800 x 600 | 48.1 | 72.2 | N/A | √ | 72Hz |
| SVGA | 800 x 600 | 53.7 | 85.1 | N/A | √ | 85Hz |
| SVGA | 832 x 624 | | 75 | N/A | √ | N/A |
| XGA | 1024 x 768 | 48.4 | 60 | N/A | √ | N/A |
| XGA | 1024 x 768 | 56.5 | 70.1 | N/A | √ | 70Hz |
| XGA | 1024 x 768 | 60 | 75 | N/A | √ | N/A |
| XGA | 1024 x 768 | 68.7 | 85 | N/A | √ | N/A |
| XGA | 1024 x 768 | | 120 | N/A | N/A | N/A |
| SXGA | 1152 x 864 | | 75 | N/A | √ | N/A |
| HD720 | 1280 x 720 | | 50 | N/A | √ | N/A |
| HD720 | 1280 x 720 | | 60 | N/A | √ | N/A |
| HD720 | 1280 x 720 | 92.62 | 120 | N/A | N/A | N/A |
| WXGA | 1280 x 768 | 47.4 | 60 | N/A | √ | N/A |
| WXGA | 1280 x 768 | | 75 | N/A | √ | N/A |
| WXGA | 1280 x 768 | | 85 | N/A | √ | N/A |
| WXGA-800 | 1280 x 800 | | 60 | N/A | √ | N/A |
| SXGA | 1280 x 1024 | 64 | 60 | N/A | √ | N/A |
| SXGA | 1280 x 1024 | 80 | 75 | N/A | √ | N/A |
| SXGA | 1280 x 1024 | 91.1 | 85 | N/A | √ | N/A |
| SXGA+ | 1400 x 1050 | | 60 | N/A | N/A | N/A |
| UXGA | 1600 x 1200 | 75 | 60 | N/A | √ | N/A |
| HD1080 | 1920 x 1080 | | 24 | N/A | √ | N/A |
| HD1080 | 1920 x 1080 | | 50 | N/A | √ | N/A |
| HD1080 | 1920 x 1080 | | 60 | N/A | √ | N/A |
| WUXGA | 1920 x 1200 | | 60 | N/A | √ | RB |
| HDTV | 1920 x 1080i | | 50 | N/A | √ | N/A |
| HDTV | 1920 x 1080i | | 60 | N/A | √ | N/A |
| HDTV | 1920 x 1080p | | 24 | N/A | √ | N/A |
| HDTV | 1920 x 1080p | | 50 | N/A | √ | N/A |
| HDTV | 1920 x 1080p | | 60 | N/A | √ | N/A |
| HDTV | 1280 x 720 | 45 | 60 | √ | N/A | N/A |
| HDTV | 1280 x 720p | | 50 | N/A | √ | N/A |
| HDTV | 1280 x 720p | | 60 | N/A | √ | N/A |
| SDTV | 720 x 576 | 31.3 | 50 | √ | N/A | N/A |
| SDTV | 720 x 576i | | 50 | N/A | √ | N/A |
| SDTV | 720 x 576p | | 50 | N/A | √ | N/A |
| SDTV | 720 x 480 | 31.5 | 60 | √ | N/A | N/A |
| SDTV | 720 x 480i | | 60 | N/A | √ | N/A |
| SDTV | 720 x 480p | | 60 | N/A | √ | N/A |

Note: “√” means the resolution is supported, “N/A” means the resolution is not supported.

ADDITIONAL INFORMATION

Computer Compatibility for MAC

| Resolution | Hz | Macbook Compatibility | Macbook Pro (Intel) Compatibility | Power Mac G5 Compatibility | Power Mac G4 Compatibility |
|-----------------|----|-----------------------|-----------------------------------|----------------------------|----------------------------|
| | | Digital | Digital | Digital | Digital |
| 800 x 600 | 60 | √ | √ | N/A | √ |
| 800 x 600 | 72 | √ | √ | N/A | √ |
| 800 x 600 | 75 | √ | √ | N/A | √ |
| 800 x 600 | 85 | √ | N/A | N/A | √ |
| 1024 x 768 | 60 | √ | √ | N/A | √ |
| 1024 x 768 | 70 | √ | √ | N/A | √ |
| 1024 x 768 | 75 | √ | √ | N/A | √ |
| 1024 x 768 | 85 | √ | √ | N/A | √ |
| 1280 x 720 | 60 | √ | √ | N/A | √ |
| 1280 x 768 | 60 | √ | √ | N/A | N/A |
| 1280 x 768 | 75 | N/A | N/A | N/A | √ |
| 1280 x 768 | 85 | N/A | N/A | N/A | N/A |
| 1280 x 800 | 60 | N/A | N/A | N/A | √ |
| 1280 x 1024 | 60 | √ | N/A | N/A | √ |
| 1280 x 1024 | 75 | √ | N/A | N/A | √ |
| 1920 x 1080 | 60 | √ | N/A | N/A | √ |
| 1920 x 1200 (*) | 60 | √ | N/A | N/A | √ |
| 3840 x 2160 | 60 | N/A | N/A | N/A | N/A |

Note:

- (*) 1920 x 1200 @ 60Hz only supports RB (reduced blanking).
- “√” means the resolution is supported, “N/A” means the resolution is not supported.

Input signal for HDMI

| Signal | Resolution | Refresh Rate (Hz) | Notes for Mac |
|-------------|-----------------|-------------------|-----------------|
| SVGA | 800 x 600 | 60/72/85/120 | Mac 60/72/85 |
| XGA | 1024 x 768 | 60/70/75/85/120 | Mac 60/70/75/85 |
| SDTV(480I) | 640 x 480 | 60 | |
| SDTV(480P) | 640 x 480 | 60 | |
| SDTV(576I) | 720 x 576 | 50 | |
| SDTV(576P) | 720 x 576 | 50 | |
| HDTV(720p) | 1280 x 720 | 50/60 | Mac 60 |
| WXGA | 1280 x 768 | 60/75/85 | Mac 75 |
| WXGA | 1280 x 800 | 60/120 | Mac 60 |
| WXGA(*2) | 1366 x 768 | 60 | |
| WXGA+ | 1440 x 900 | 60/120(RB) | Mac 60 |
| SXGA | 1280 x 1024 | 60/75/85 | Mac 60/75 |
| SXGA+ | 1400 x 1050 | 60/85 | |
| UXGA | 1600 x 1200 | 60/65/70/75/85 | |
| HDTV(1080I) | 1920 x 1080 | 50/60 | |
| HDTV(1080p) | 1920 x 1080 | 24/30/50/60/120 | Mac 60 |
| HDTV(1080p) | 1920 x 1080 | 240 | Mac 60 |
| WUXGA | 1920 x 1200(*1) | 60 | Mac 60RB |

ADDITIONAL INFORMATION

| Signal | Resolution | Refresh Rate (Hz) | Notes for Mac |
|------------|-------------|-------------------|---------------|
| WQHD | 2560 x 1440 | 60RB/120 | |
| UHD(2160p) | 3840 x 2160 | 24/30/50/60 | Mac 24/30 |
| UHD(2160p) | 4096 x 2160 | 24/30/50/60 | Mac 24 |

Note:

- (*1) 1920 x 1200 @ 60Hz only supports RB(reduced blanking).
- (*2) Windows 10 standard timing.

Extended Display Identification Data (EDID) tables

Digital signal (HDMI 2.0)

Digital Native resolution: 3840 x 2160 @ 60Hz

| B0/Established Timing | B0/Standard Timing | B0/Standard Timing | B1/Video Mode | B1/Detail Timing |
|-----------------------|--------------------|------------------------------|---------------------------|---------------------|
| 800 x 600 @ 56Hz | 1280 x 720 @ 60Hz | 3840 x 2160 @ 60Hz (default) | 1920 x 1080p @ 120Hz 16:9 | 2560 x 1440 @ 120Hz |
| 800 x 600 @ 72Hz | 1280 x 800 @ 60Hz | | 720 x 480p @ 60Hz 4:3 | 1920 x 1080 @ 240Hz |
| 800 x 600 @ 75Hz | 1280 x 1024 @ 60Hz | | 1920 x 1080i @ 60Hz 16:9 | |
| 832 x 624 @ 75Hz | 1920 x 1200 @ 60Hz | | 1920 x 1080i @ 50Hz 16:9 | |
| 1024 x 768 @ 60Hz | 800 x 600 @ 120Hz | | 1920 x 1080p @ 60Hz 16:9 | |
| 1024 x 768 @ 70Hz | 1024 x 768 @ 120Hz | | 1920 x 1080p @ 50Hz 16:9 | |
| 1024 x 768 @ 75Hz | 1280 x 800 @ 120Hz | | 1920 x 1080p @ 24Hz 16:9 | |
| 1280 x 1024 @ 75Hz | | | 3840 x 2160 @ 24Hz 16:9 | |
| 1152 x 870 @ 75Hz | | | 3840 x 2160 @ 25Hz 16:9 | |
| | | | 3840 x 2160 @ 30Hz 16:9 | |
| | | | 3840 x 2160 @ 50Hz 16:9 | |
| | | | 3840 x 2160 @ 60Hz 16:9 | |
| | | | 4096 x 2160 @ 24Hz | |
| | | | 4096 x 2160 @ 25Hz | |
| | | | 4096 x 2160 @ 30Hz | |
| | | | 4096 x 2160 @ 50Hz | |
| | | | 4096 x 2160 @ 60Hz | |
| | | | 720 x 480p @ 60Hz 16:9 | |
| | | | 1280x720p @ 60Hz 16:9 | |
| | | | 1280 x 720p @ 50Hz 16:9 | |
| | | | 720 x 576p @ 60Hz 16:9 | |

Note: Support 1920 x 1080 @ 50Hz

ADDITIONAL INFORMATION

3D Timing

HDMI1.4a 3D Timing For Blue-Ray 3D:

| Signal | Timing | Supported Port |
|-----------------------|----------------------------|---------------------|
| 720p (Frame Packing) | 1280 x 720 @ 50Hz | HDMI1, HDMI2, HDMI3 |
| 720p (Frame Packing) | 1280 x 720 @ 60Hz | HDMI1, HDMI2, HDMI3 |
| 1080p (Frame Packing) | 1920 x 1080 @ 23.98 / 24Hz | HDMI1, HDMI2, HDMI3 |

PC 3D Timing:

| Signal | Timing | Supported Port |
|------------------|---------------------|---------------------|
| Frame Sequential | 800 x 600 @ 120Hz | HDMI1, HDMI2, HDMI3 |
| Frame Sequential | 1024 x 768 @ 120Hz | HDMI1, HDMI2, HDMI3 |
| Frame Sequential | 1280 x 800 @ 120Hz | HDMI1, HDMI2, HDMI3 |
| Frame Sequential | 1920 x 1080 @ 120Hz | HDMI1, HDMI2, HDMI3 |

ADDITIONAL INFORMATION

Image size and projection distance

| Image Size (inch) | DF | | DR | | DT | | H Offset=121.5% ~ 130% | | L Offset=121.5% ~ 130% | |
|-------------------|-------|--------|-------|--------|-------|--------|---------------------------|----------------|---------------------------|-----------------|
| | m | inch | m | inch | m | inch | m | inch | m | inch |
| 85" | 0.530 | 20.876 | 0.147 | 5.774 | 0.166 | 6.518 | 0.176 ~ 0.266 | 6.92 ~ 10.462 | 0.241 ~ 0.313 | 9.507 ~ 12.327 |
| 90" | 0.558 | 21.983 | 0.175 | 6.881 | 0.194 | 7.625 | 0.189 ~ 0.284 | 7.447 ~ 11.198 | 0.271 ~ 0.344 | 10.658 ~ 13.547 |
| 100" | 0.615 | 24.197 | 0.231 | 9.095 | 0.250 | 9.839 | 0.216 ~ 0.322 | 8.501 ~ 12.668 | 0.33 ~ 0.407 | 13.003 ~ 16.04 |
| 110" | 0.671 | 26.411 | 0.287 | 11.309 | 0.306 | 12.053 | 0.243 ~ 0.359 | 9.555 ~ 14.139 | 0.391 ~ 0.472 | 15.381 ~ 18.579 |
| 120" | 0.727 | 28.625 | 0.343 | 13.522 | 0.362 | 14.266 | 0.269 ~ 0.396 | 10.609 ~ 15.61 | 0.452 ~ 0.537 | 17.779 ~ 21.147 |

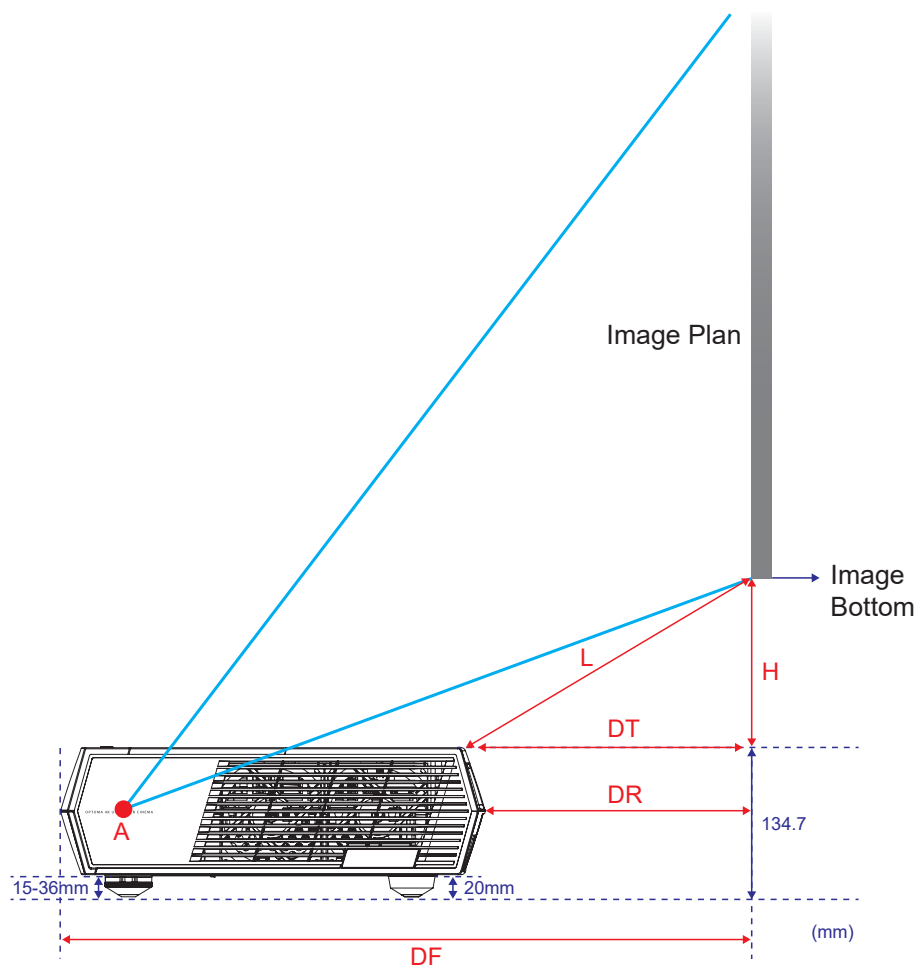











ADDITIONAL INFORMATION

Remote control codes



| Key | | Custom code | | Key Code | | Description |
|--------------|-----------|-------------|--------|----------|--------|---|
| | | Byte 1 | Byte 2 | Byte 3 | Byte 3 | |
| Power on | | 32 | CD | 02 | FD | Press to turn on the projector. |
| Source | | 32 | CD | C3 | 3C | Press "Source" to select an input signal. |
| Backlight | | N/A | | | | Backlight toggle. |
| Re-sync | | 32 | CD | C4 | 3B | Automatically synchronizes the projector to the input source. |
| Sleep Timer | | 32 | CD | 63 | 9C | Set the sleep timer interval. |
| Keystone | | 32 | CD | 7 | F8 | Adjust image distortion caused by tilting the projector. |
| Aspect Ratio | | 32 | CD | 64 | 9B | Press to change aspect ratio of a displayed image. |
| 3D | 3D | 32 | CD | 89 | 76 | Manually select a 3D mode that matches your 3D content. |
| Brightness | | 32 | CD | 41 | BE | Adjust the brightness of the image. |
| Contrast | | 32 | CD | 42 | BD | Control the degree of difference between the lightest and darkest parts of the picture. |

ADDITIONAL INFORMATION

| Key | | Custom code | | Key Code | | Description |
|---------------------|---|-------------|--------|----------|--------|--|
| | | Byte 1 | Byte 2 | Byte 3 | Byte 3 | |
| Lamp |  | 32 | CD | 0A | F5 | Select the brightness mode. |
| CMS | CMS | 32 | CD | 0B | F4 | Open the Optoma Color Management System (CMS). (not supported) |
| Mode |  | 32 | CD | 5 | FA | Select a display mode for optimized settings for different applications. Please see page 27. |
| HDR | HDR | 32 | CD | 0C | F3 | Configure the (HDR) settings. |
| Four direction keys | ^ | 32 | CD | 11 | EE | Select items or make adjustments to your selection. |
| | v | 32 | CD | 14 | EB | |
| | < | 32 | CD | 10 | EF | |
| | > | 32 | CD | 12 | ED | |
| Enter | OK | 32 | CD | 0F | F0 | Confirm your item selection. |
| Return |  | 32 | CD | 0D | F2 | Move to the previous menu. |
| Menu |  | 32 | CD | 0E | F1 | Display or exit the on-screen display menus for projector. |
| Vol - |  | 32 | CD | 8F | 70 | Adjust to decrease volume. |
| Mute |  | 32 | CD | 52 | AD | Mute audio. |
| Vol + |  | 32 | CD | 8C | 73 | Adjust to increase volume. |
| HDMI1 | HDMI 1 | 32 | CD | 16 | E9 | Select HDMI1 input source. |
| HDMI2 | HDMI 2 | 32 | CD | 30 | CF | Select HDMI2 input source. |
| HDMI3 | HDMI 3 | 32 | CD | 98 | 67 | Select HDMI3 input source. |
| User1 |  | 32 | CD | 36 | C9 | Fixed on "Focus -". |
| User2 |  | 32 | CD | 65 | 9A | Fixed on "Focus +". |
| User3 |  | 32 | CD | 66 | 99 | Fixed on "HDMI3". |
| User4 |  | 32 | CD | 09 | F6 | No function. |

ADDITIONAL INFORMATION

Troubleshooting

If you experience a problem with your projector, please refer to the following information. If a problem persists, please contact your local reseller or service center.

Image problems

- ❓ *No image appears on-screen*
 - Ensure all the cables and power connections are correctly and securely connected as described on page 15.
 - Ensure the pins of connectors are not crooked or broken.

- ❓ *Image is out of focus*
 - Make sure the projection screen is between the required distance from the projector. Refer to page 42.
 - Use the **User 1** and **User 2** buttons on the remote control to adjust focus.

- ❓ *The image is stretched when displaying 16:9 DVD title*
 - When you play anamorphic DVD or 16:9 DVD, the projector will show the best image in 16: 9 format on projector side.
 - If you play 4:3 format DVD title, please change the format as 4:3 in projector OSD.
 - Please setup the display format as 16:9 (wide) aspect ratio type on your DVD player.

- ❓ *Image is too small or too large*
 - Move the projector closer to or further from the screen.
 - Press "⏏" on the remote control, go to "OSD menu → Display → Aspect Ratio". Try the different settings.

- ❓ *Image has slanted sides:*
 - If possible, reposition the projector so that it is centered on the screen and below the bottom of the screen.

- ❓ *Image is reversed*
 - Select "OSD menu → Setup → Projection" and adjust the projection direction.

- ❓ *No sound*
 - Ensure that the "Mute" feature is not turned on.

- ❓ *No sound from HDMI ARC source*
 - Select "OSD menu → Audio → Audio Mode → Speaker / Audio Out, SPDIF / eARC". Try the different settings.

ADDITIONAL INFORMATION

Other problems



The projector stops responding to all controls

- If possible, turn off the projector, then unplug the power cord and wait at least 20 seconds before reconnecting power.

Remote control problems



If the remote control does not work

- Check the operating angle of the remote control is pointed within $\pm 15^\circ$ to the IR receivers on the projector.
- Make sure there are not any obstructions between the remote control and the projector. Move to within 6 meters (~19.6 feet) of the projector.
- Make sure batteries are inserted correctly.
- Replace batteries if they are exhausted.

Warning indicators

When the warning indicators (see below) light up or flash, the projector will automatically shutdown:

- “Light Source” LED indicator is lit red and if “On/Standby” indicator flashes red.
- “TEMP” LED indicator is lit red and if “On/Standby” indicator flashes red. This indicates the projector has overheated. Under normal conditions, the project can be switched back on.
- “TEMP” LED indicator flashes red and if “On/Standby” indicator flashes red.

Unplug the power cord from the projector, wait for 30 seconds and try again. If the warning indicator light up or flash, please contact your nearest service center for assistance.

ADDITIONAL INFORMATION

LED lightning messages

| Message | On/Standby LED | | Temp LED | Light Source LED |
|---------------------------------------|----------------|---|--------------|------------------|
| | (Red) | (White) | (Red) | (Red) |
| Standby state (Input power cord) | Steady light | | | |
| Power on (Warming) | | Flashing (0.5 sec off / 0.5 sec on) | | |
| Power on and light source lighting | | Steady light | | |
| Power off (Cooling) | | Flashing (0.5 sec off / 0.5 sec on). Back to red steady light when cooling fan turns off. | | |
| Quick Resume (100 secs) | | Flashing (0.25 sec off / 0.25 sec on). | | |
| Error (Light source failure) | Flashing | | | Steady light |
| Error (Fan failure) | Flashing | | Flashing | |
| Error (Over temp.) | Flashing | | Steady light | |

- Power off:

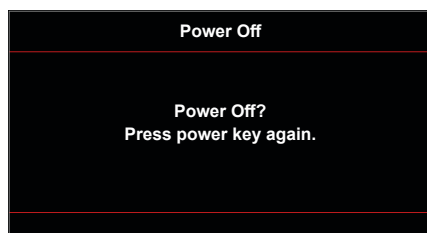

- Temperature warning:

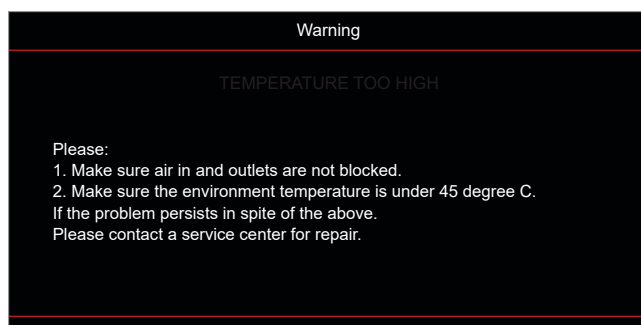

ADDITIONAL INFORMATION

- Fan failed:

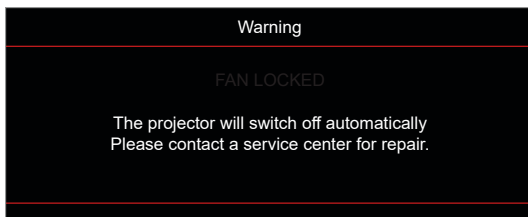

- Out of display range:

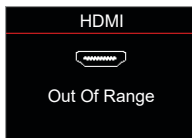

- Power down warning:

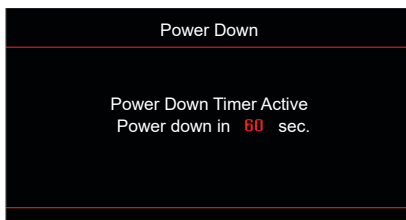

ADDITIONAL INFORMATION

Specifications

| Optical | Description |
|---------------------------|---|
| Technology | Texas Instrument DMD, 0.47"(dimension)/ 4K UHD HSSI DMD X1 S451 (Packing typing), with 4-Way XPR actuator |
| Output resolution | 4K UHD 3840 x 2160 at 60Hz |
| Maximum input resolution | 4096 x 2160 at 60Hz |
| Lens | <ul style="list-style-type: none">• Throw ratio: 0.254• F-stop: 2.04• Focal length: 525mm at 90"• Zoom range: N/A |
| Offset | 253.2 to 334.2 mm (122.5% to 129%) (full height) |
| Image size | 85" to 105", optimized at 90" |
| Projection distance | 478 mm at 85" to 590 mm at 105" |
| I/Os | <ul style="list-style-type: none">• HDMI V2.0 x3 Note: HDMI 1 port supports eARC and low latency.• USB-A for firmware upgrade and power 5V 1.5A• RS232C male (9-pin D-SUB)• Line out (3.5mm)• SPDIF Out (2 channels PCM, Digital (5.1)) |
| Colour | 1073.4 Million color |
| Scan rate | <ul style="list-style-type: none">• Horizontal scan rate: 31.0 to 135.0 KHz• Vertical scan rate: 24 to 120 Hz |
| Speaker | Yes, 10W x2 |
| Power consumption | <ul style="list-style-type: none">• Standby mode: < 0.5W• Brightness Mode: 100%<ul style="list-style-type: none">• 240W (typical) ±15% @ 110VAC• 230W (typical) ±15% @ 220VAC• Eco Mode: 80%<ul style="list-style-type: none">• 185W (typical) ±15% @ 110VAC• 175W (typical) ±15% @ 220VAC |
| Power requirement | 100 to 240V ±10%, AC 50/60Hz |
| Input current | 2.5A |
| Installation orientations | Front, Rear, Ceiling-top, Rear-top |
| Dimensions (W x D x H) | <ul style="list-style-type: none">• 576 x 383 x 114.7 mm (without feet) (22.6 x 15.0 x 4.5 inches)• 576 x 383 x 129.7 mm (with feet) (22.6 x 15.0 x 5.1 inches) |
| Weight | 8.4 kg (18.5 lbs) |
| Environmental | Operating in 0~40°C , 80% humidity (non-condensing) |

Note: All specifications are subject to change without notice.



ADDITIONAL INFORMATION

Optoma global offices

For service or support, please contact your local office.



USA

47697 Westinghouse Drive,
Fremont, CA 94539, USA
www.optomausa.com

 888-289-6786
 510-897-8601
 services@optoma.com



Canada

47697 Westinghouse Drive,
Fremont, CA 94539, USA
www.optomausa.com

 888-289-6786
 510-897-8601
 services@optoma.com

Latin America

47697 Westinghouse Drive,
Fremont, CA 94539, USA
www.optomausa.com

 888-289-6786
 510-897-8601
 services@optoma.com



Europe

Unit 1, Network 41, Bourne End Mills,
Hemel Hempstead, Herts,
HP1 2UJ, United Kingdom
www.optoma.eu
Service Tel : +44 (0)1923 691865

 +44 (0) 1923 691 800
 +44 (0) 1923 691 888
 service@tsc-europe.com



Benelux BV

Randstad 22-123
1316 BW Almere
The Netherlands
www.optoma.nl

 +31 (0) 36 820 0252
 +31 (0) 36 548 9052

France

Bâtiment E
81-83 avenue Edouard Vaillant
92100 Boulogne Billancourt, France

 +33 1 41 46 12 20
 +33 1 41 46 94 35
 savoptoma@optoma.fr



Spain

C/ José Hierro,36 Of. 1C
28522 Rivas VaciaMadrid,
Spain

 +34 91 499 06 06
 +34 91 670 08 32



Deutschland

Wiesenstrasse 21 W
D40549 Düsseldorf,
Germany

 +49 (0) 211 506 6670
 +49 (0) 211 506 66799
 info@optoma.de

Scandinavia

Lerpeveien 25
3040 Drammen
Norway

 +47 32 98 89 90
 +47 32 98 89 99
 info@optoma.no

PO.BOX 9515
3038 Drammen
Norway

Korea

<https://www.optoma.com/kr/>

Japan



<https://www.optoma.com/jp/>

Taiwan

<https://www.optoma.com/tw/>

China

Room 2001, 20F, Building 4,
No.1398 Kaixuan Road,
Changning District
Shanghai, 200052, China

 +86-21-62947376
 +86-21-62947375
www.optoma.com.cn

Australia

<https://www.optoma.com/au/>

