

SONY

VPL-VW675ES/VW385ES/VW285ES

Home Theater Projector



Look for The Angry Birds Movie on 4K Ultra HD



VPL-VW675ES/385ES



VPL-VW285ES



TRILUMINOS
DISPLAY



ProSelecta

View :: Compare :: Select - www.ProSelecta.com

Seeing is believing Experience the beauty of true 4K

Bring incredible 4K detail to your favorite movies

Imagine bringing the truly cinematic quality of 4K into your own home. Now you can make this a reality with our VPL-VW675ES/VW385ES/VW285ES series of Home Theater projectors. They produce true 4K resolution images with our native 4K (4096 x 2160) SXRD panels – that's over four times the quality of Full HD.

Designed for your home theater room and living room, the VPL-VW675ES/VW385ES/VW285ES deliver stunning, detail-packed images and incredibly lifelike color like never before. And with high brightness, you're guaranteed an exceptional picture even in well-lit rooms.



Breathtaking Picture Quality

Native 4K SXRD™ panel

The advanced SXRD (Silicon X-tal Reflective Display) panel technology featured in Sony's digital cinema projectors delivers native 4K (4096 x 2160) resolution images, with more than four times the detail of Full HD. Fine details are wonderfully clear and natural, without jagged edges or visible pixels.

Native 4K Panel

4096 x 2160
(8.8 million pixels)



See deeper blacks with 4K SXRD panels

Latest SXRD panels deliver even better contrast, as well as native 4K resolution. SXRD projection offers rich, inky blacks, as well as clear cinematic motion and image smoothness. Improvements to the silicon layer now mean even better light control, for precisely delivered shadows and blacks

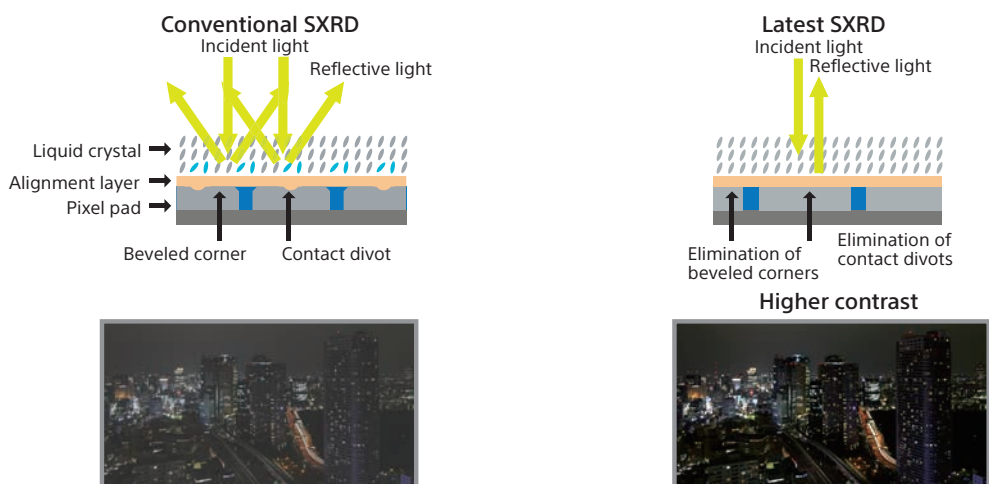

Simulated images

Sony's 4K Projection

With more than four times the resolution of Full HD, native 4K offers 8.8 million pixels (4096 x 2160) for a picture that's incredibly lifelike, which is why it is the resolution defined by the DCI (Digital Cinema Initiatives) for cinema distribution. See corner-to-corner clarity and watch movies from much closer than you would in Full HD.

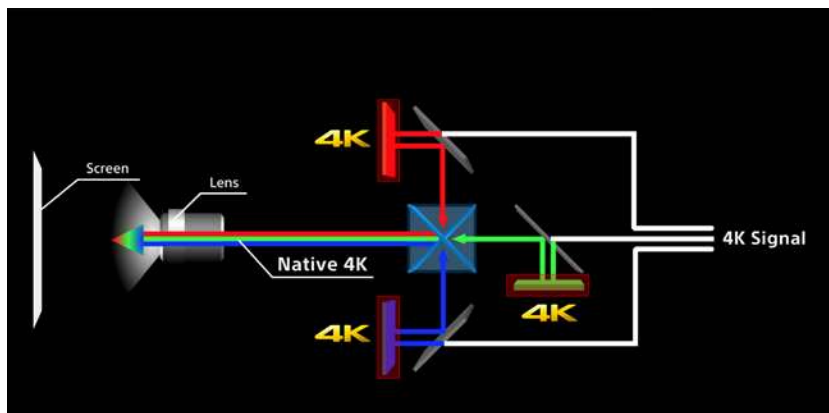

Bright Feel

Sony's SXR panels can achieve the highest contrast ratio compared to other devices. As a result of the high contrast, it gives you the feel of high brightness, and thus more immersiveness.



Standard Home Theater Projector



Sony Home Theater Projector

Simulated images

Remarkable Dynamic Contrast for Highest Picture Quality

With Sony's Advanced Iris3 technology, these projectors can achieve an incredible dynamic contrast for the best ever images.

* The VPL-VW675ES/VW385ES.

HDR Compatible

Get the most from your projector when viewing new UHD Blu-ray and streaming services with High Dynamic Range (HDR).

HDR video offers a vastly expanded brightness range to deliver far more realistic, high-contrast images and brilliant colors.

Compatible with both HDR10 and HLG (Hybrid Log-Gamma) formats, Sony's home projectors reproduce color and contrast faithfully to creators' intentions.

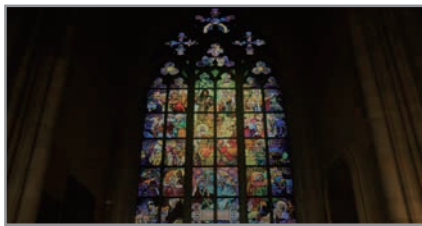

SDR*

* Standard Dynamic Range



HDR

Simulated images

The super-resolution Reality Creation

Sony's exclusive Reality Creation technology analyzes images right down to the pixel level.

It then employs pattern-matching algorithms developed over years of movie production to enhance crispness even without increasing digital picture noise. It also upscales existing full HD Blu-ray Disc™ and DVD movies to near 4K quality.

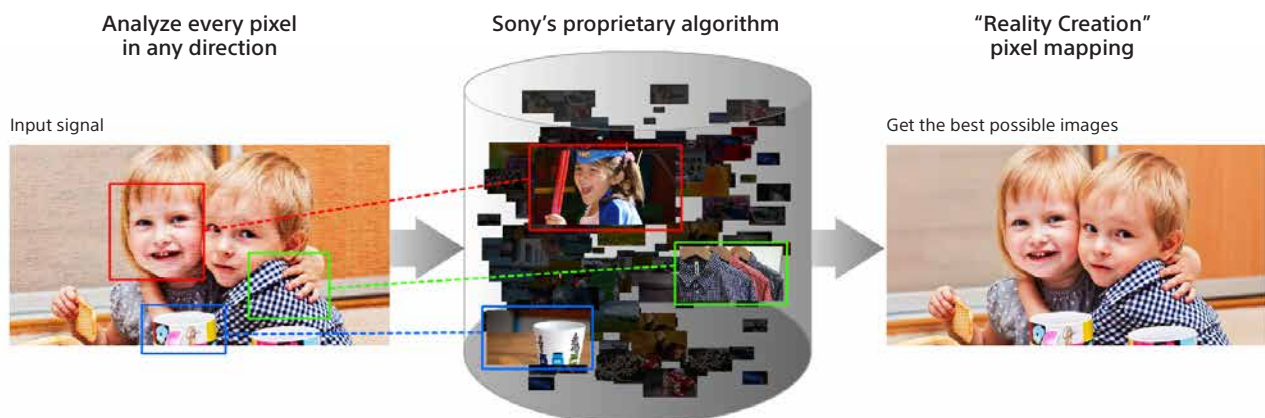

Picture patterning based on 10 years of accumulated expertise

TRILUMINOS™ Display

Discover true-to-life colors and tones. The projector incorporates TRILUMINOS color, reproducing more tones and textures than a standard projector system. Hard-to-reproduce crimson reds, aqua blues, and emerald greens are displayed beautifully, so landscapes and seascapes look more vivid. Faces look better, too, with skin tones more faithfully reproduced.



Simulated images

Advanced Motionflow™

Whatever you're watching, you'll enjoy a silk-smooth on-screen look in fast-moving action sequences with Motionflow. This innovative technology creates and inserts extra frames between the original frames, first comparing key visual factors on successive frames, then calculating the split second of missing action in the sequences. True Cinema 24p mode mimics true movie projection for cinema purists.



Without Motionflow



With Motionflow

Simulated images

Installation Advantages

Compact and Functional Design

Achieving such compact size, provides great flexibility for a variety of installation situations.

Wider Zoom and Shift Lens

The projectors offer a powered lens for zoom, shift and focus operations to provide maximum flexibility for home installations, including high ceiling mounting.

Front-facing Fan

Because the fan is positioned at the front, you don't need to leave a large gap between the back of the projector and the wall for air intake/exhaust when you install. This helps maximize the throw distance for bigger projected images.

Picture Position Memory Matches Movie Aspect Ratio

The projector has a set of memory registers to store the position of the lens (focus, zoom, shift). Users can match a movie's aspect ratio, including 1.78:1 and 2.35:1, and store these settings in the projector for easy recall.

* The VPL-VW675ES/VW385ES.

Screen 2.35:1



Position 1.78:1 Image 1.78:1

Screen 2.35:1

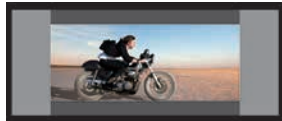

Position 1.78:1 Image 2.35:1

2.35:1 without picture position memory



Screen 2.35:1



Position 2.35:1 Image 2.35:1

2.35:1 with picture position memory

Simulated images

Electronic Panel Alignment

Ensures the red and blue elements in each pixel are precisely positioned against green. Adjustments can be made by as little as 0.1 pixels for optimum clarity.

User-friendly Functions

Built-in Auto Calibration

After extended periods, color can be automatically calibrated to the original factory condition. There's no need for extra calibration equipment or cameras; a built-in color sensor stores all the necessary information.

* The VPL-VW675ES/385ES.

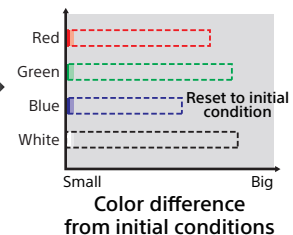
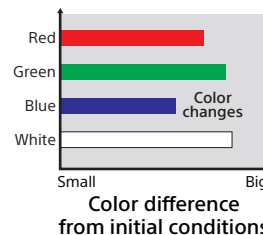

HDCP 2.2 Compatibility

Both HDMI inputs are compatible with HDCP 2.2 - the latest content protection standard.

Industry-standard RF 3D Compatible

A built-in RF transmitter synchronizes with most RF 3D glasses for wider coverage and greater stability, and there's no need for an external transmitter.

Long-lasting Lamp

By incorporating a high-performance lamp and advanced lamp-control technology, the projectors deliver an extremely long lamp replacement time of 6,000 hours*.

* Approximate recommended period, in low mode.

Low Latency Mode

A new feature for gamers. Experience our fastest ever response time between your controller and the screen for ultimate gaming action.

Easy Connectivity for Home Automation

Compatible with many home automation systems via an RJ45(IP), RS-232C, TRIGGER and IR IN interfaces.

Low fan noise at 26dB*

Whisper-quiet fan noise minimizes disturbance for your audience.

* Depends on the viewing environment or how the projector is used. 26dB is based on the typical environment.

Projection distance

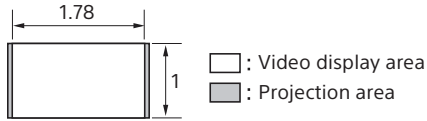

1.78:1 (16:9)		
Projection image size		Projection distance L
Diagonal	Width × Height	
80" (2.03 m)	1.77 × 1.00 (70 × 39)	2.44 – 5.01 (96 – 197)
100" (2.54 m)	2.21 × 1.25 (87 × 49)	3.05 – 6.28 (121 – 247)
120" (3.05 m)	2.66 × 1.49 (105 × 59)	3.67 – 7.55 (145 – 297)
150" (3.81 m)	3.32 × 1.87 (131 × 74)	4.60 – 9.44 (181 – 371)
200" (5.08 m)	4.43 × 2.49 (174 × 98)	6.15 – 12.61 (242 – 496)

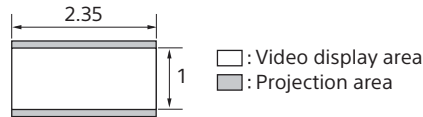

2.35:1		
Projection image size		Projection distance L
Diagonal	Width × Height	
80" (2.03 m)	1.87 × 0.80 (74 × 31)	2.41 – 4.96 (95 – 195)
100" (2.54 m)	2.34 × 0.99 (92 × 39)	3.02 – 6.22 (119 – 244)
120" (3.05 m)	2.80 × 1.19 (110 × 47)	3.64 – 7.47 (143 – 294)
150" (3.81 m)	3.51 × 1.49 (138 × 59)	4.55 – 9.35 (180 – 368)
200" (5.08 m)	4.67 × 1.99 (184 × 78)	6.08 – 12.48 (240 – 491)

Optional Accessories



LMP-H280 for VPL-VW675ES
 Projector Lamp (for replacement)



TDG-BT500A
 3D Glasses



LMP-H220 for VPL-VW385ES/VW285ES
 Projector Lamp (for replacement)

Connector Panel

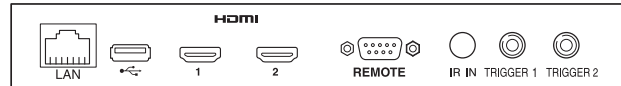

Dimensions

Units: inches (mm)

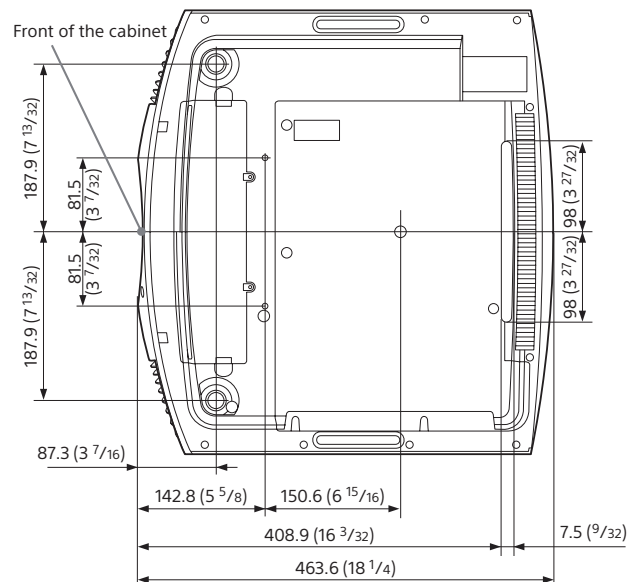
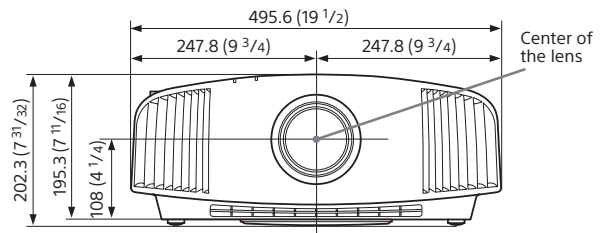

Specifications

		VPL-VW675ES	VPL-VW385ES	VPL-VW285ES
Display System		4K SXRD panel, projection system		
Display device	Size of effective display area	0.74" x 3		
	Number of pixels	26,542,080 (4096 x 2160 x 3) pixels		
Projection lens	Focus	Powered		
	Zoom	Powered (Approx. x 2.06)		
	Lens shift	Powered Vertical: +85% -80% Horizontal: +/-31%		
Light source	High-pressure mercury lamp, 280 W type	High-pressure mercury lamp, 225 W type		
Recommended lamp replacement time*1	6000 H (Lamp mode:Low)			
Screen size	60" to 300" (1,524 mm to 7,620 mm)			
Light output	1800 lm (Lamp mode: High)*2	1500 lm (Lamp mode: High)*2		
Color light output	1800 lm (Lamp mode: High)*2	1500 lm (Lamp mode: High)*2		
Dynamic contrast	350,000:1	200,000:1	-	
Displayable scanning frequency	Horizontal	19 kHz to 72 kHz		
	Vertical	48 Hz to 92 Hz		
Display resolution*3	Computer signal input	Maximum display resolution: 1920 x 1080 dots (HDMI Input only)		
	Video signal input	480/60p, 576/50p, 720/60p, 720/50p, 1080/60i, 1080/50i, 1080/60p, 1080/50p, 1080/24p, 3840 x 2160/24p, 3840 x 2160/25p, 3840 x 2160/30p, 3840 x 2160/50p*4, 3840 x 2160/60p*4, 4096 x 2160/24p, 4096 x 2160/25p, 4096 x 2160/30p, 4096 x 2160/50p*4, 4096 x 2160/60p*4		
OSD language	18-languages (English, Dutch, French, Italian, German, Spanish, Portuguese, Turkish, Polish, Russian, Swedish, Norwegian, Japanese, Simplified Chinese, Traditional Chinese, Korean, Thai, Arabic)			
INPUT OUTPUT (Computer / Video / Control)	HDMI1 / HDMI2*5	Digital (RGB/Y Pb/Cb Pr/Cr)		
	Trigger1 / Trigger2	Minijack, DC 12 V Max. 100 mA		
	Remote	RS-232C, D-sub 9-pin (female)		
	LAN	RJ45, 10Base-T/100BASE-TX		
	IR IN	Mini Jack		
	USB	DC 5V, Max. 500 mA		
Acoustic noise	26 dB			
Operating temperature / Operating humidity	41°F to 95°F (5°C to 35°C) / 35% to 85% (no condensation)			
Storage temperature / Storage humidity	-4°F to +140°F (-20°C to +60°C) / 10% to 90% (no condensation)			
Power requirements	AC 100 V to 240 V, 4.1 A to 1.7 A, 50/60Hz	AC 100 V to 240 V, 3.5A to 1.5A, 50/60Hz		
Power consumption		410 W		
	Standby	0.3 W (when "Remote Start" is set to "Off")		
	Networked Standby	1.0 W (LAN) (when "Remote Start" is set to "On") When a LAN terminal is not connected, it becomes a low power consumption mode (0.5 W).		
Dimensions (W x H x D) (without protrusions)	19 1/2 x 7 11/16 x 18 1/4 inches 495.6 x 195.3 x 463.6 mm			
Weight	Approx. 31 lb / 14 kg			
Supplied accessories	RM-PJ24 Remote Commander (1) : VPL-VW550ES/VW360ES, RM-PJ28 Remote Commander (1) : VPL-VW260ES, Size AA (R6) Manganese Batteries (2), Lens Cap (1), AC Power Cord (1), Operating Instructions (CD-ROM) (1), Quick Reference Manual (1)			
Replacement lamp	LMP-H280	LMP-H220		

*1 The figures are expected maintenance time and not guaranteed. They will depend on the environment or how the projector is used.

*2 The values are estimate.

*3 Displayed image may be converted for some input signals.

*4 YCbCr 4:2:0. And the displayed format is in 8bit

*5 Both HDMI inputs are compatible with HDCP2.2