

SONY

Data Projector
VPL-PHZ60/PHZ50



This manual is for those who encounter issues or have questions when using the Data Projector.
Not all models are available in all countries and area. Please check with your local Sony Authorized Dealer.

Before Use

[Checking the Supplied Accessories](#)

[Inserting the Battery into the Remote Commander](#)

Parts and Controls

[Parts and Controls \(Main Unit\)](#)

[Parts and Controls \(Connection Terminals\)](#)

[Parts and Controls \(Remote Commander and Control Panel\)](#)

Connecting

[Precautions When Connecting](#)

Connecting to a Computer

[Connecting to a Computer with an RGB Output Terminal](#)

[Connecting to a Computer with an HDMI Output Terminal](#)

[Connecting to a Computer via a Hub or Router](#)

Connecting to Video Equipment

[Connecting to a Video Device with a Video Output Terminal](#)

[Connecting to a Video Device with a Y PB PR Output Terminal](#)

[Connecting to a Video Device with an HDMI Output Terminal](#)

[Connecting to Audio Equipment](#)

[Fixing the HDMI Cable to the Projector](#)

[Connecting to an HDBaseT™ Device](#)

[Supplying the power to an external device](#)

Projecting

[Turning Power On/Off](#)

[Selecting the Menu Language](#)

[Projecting Images](#)

Adjusting

[Adjusting the Screen Focus](#)

[Adjusting the Screen Size](#)

[Adjusting the Screen Position](#)

[Changing the Screen Aspect Ratio](#)

Correcting a Trapezoidal Screen

[Correcting a Vertical Trapezoid](#)

[Correcting a Horizontal Trapezoid](#)

[Correcting Screen Distortion](#)

[Displaying Patterns](#)

[Using the Auto Adjustment Function](#)

Useful Functions

[Use the Intelligent Setting Function](#)

[Using the Digital Zoom Function](#)

[Using Eco Mode](#)

Adjustment and Setting Menus

[Navigating Menus](#)

Projection Setting Menu

- [Menu Operation: Intelligent Setting](#)

 - [Menu Operation: Picture Mode](#)

 - [Menu Operation: Reset](#)

 - [Menu Operation: Contrast](#)

 - [Menu Operation: Brightness](#)

 - [Menu Operation: Color](#)

 - [Menu Operation: Hue](#)

 - [Menu Operation: Color Temp.](#)

 - [Menu Operation: Sharpness](#)

 - [Menu Operation: Light Settings](#)

 - [Menu Operation: Expert Setting](#)
-

Screen Menu

- [Menu Operation: Aspect](#)

 - [Aspect Ratio](#)

 - [Menu Operation: Adjust Signal](#)
-

Function Menu

- [Menu Operation: Volume](#)

 - [Menu Operation: Speaker](#)

 - [Menu Operation: Speaker Setting](#)

 - [Menu Operation: Smart APA](#)

 - [Menu Operation: CC Display](#)

 - [Menu Operation: Background](#)

 - [Menu Operation: Start Up Image](#)

 - [Menu Operation: All Reset](#)
-

Operation Menu

- [Menu Operation: Language](#)

 - [Menu Operation: Menu Position](#)

 - [Menu Operation: Status](#)
-

[Menu Operation: IR Receiver](#)

[Menu Operation: Security Lock](#)

[Menu Operation: Control Key Lock](#)

[Menu Operation: Menu Settings Lock](#)

[Menu Operation: Set Password](#)

Connection/Power Menu

[Menu Operation: Network Setting](#)

[Menu Operation: Communication Mode](#)

[Menu Operation: HDBaseT Settings](#)

[Menu Operation: Dynamic Range](#)

[Menu Operation: Input-A Signal Sel.](#)

[Menu Operation: ECO](#)

[Menu Operation: Standby Mode](#)

[Menu Operation: Remote Start](#)

[Menu Operation: Direct Power On](#)

Installation Menu

[Menu Operation: Screen Fitting](#)

[Menu Operation: V Keystone](#)

[Menu Operation: H Keystone](#)

[Menu Operation: Corner Keystone](#)

[Menu Operation: Digital Shrink](#)

[Menu Operation: Image Flip](#)

[Menu Operation: High Altitude Mode](#)

[Menu Operation: Panel Alignment](#)

Information Menu

[Viewing the Projector Information](#)

Using Network Features

[Uses for Network Features](#)

[Displaying the Control Window of the Projector with a Web Browser](#)

[Operating the Control Panel](#)

[Using the E-mail Report Function](#)

[Configuring the Network Settings of the Projector](#)

Setting Projector Control Protocol

[Setting Advertisement](#)

[Setting PJ Link](#)

[Setting PJ Talk](#)

[Setting ADCP](#)

[Setting AMX DDDP/Crestron Room View](#)

[Resetting the Network Settings](#)

[Setting the Date and Time](#)

[Using the Software Update Function](#)

Using https Communication

[Configuring https Communication](#)

[Connecting with https for the First Time](#)

[Installing a CA Certificate to Your Computer](#)

[Deleting a CA Certificate Installed to Your Computer](#)

Precautions

Precautions

[On Installation](#)

[Precautions for Portrait Installation](#)

[On Cleaning the Lens and the Cabinet](#)

[On Illumination](#)

[On Heat Dissipation](#)

[On Screen](#)

[On Fan](#)

[On Inspection of Light Source Related Parts](#)

[On Disposing Used Products](#)

[On LCD Projector](#)

[On condensation](#)

[Notes on Security](#)

[Do not place this product close to medical devices](#)

[Disclaimer](#)

[Cleaning the Air Filter](#)

[Updating Software](#)

Specifications

[Specifications](#)

Pin Assignment

[Pin Assignment \(HDMI Terminal\)](#)

[Pin Assignment \(RGB Input Terminal\)](#)

[Pin Assignment \(RS-232C Terminal\)](#)

[Pin Assignment \(USB Terminal\)](#)

List of Compatible Signals

[Compatible Signal List \(Computer Signal\)](#)

[Compatible Signal List \(Video Signal\)](#)

Projection Distance

[Projection Distance](#)

[Projection Distance/Projection Distance Formula](#)

[Lens Shift Range](#)

Error Handling

[Reading the Indicator](#)

[Message List](#)

Troubleshooting

[No Power](#)

[No Image is Displayed](#)

[Cannot Connect to Computer](#)

[No On-screen Display](#)

[Screen Aspect Ratio is Strange/Screen Display is Small/Part of Image Not Displayed](#)

[Trapezoidal Screen](#)

[Edges of the image are cut off or dark](#)

[Screen Distortion](#)

[Screen is Too Dark/Bright](#)

[Blurry Screen](#)

[Screen Noise](#)

[No Sound](#)

[Remote Commander Does Not Function](#)

[Loud Fan](#)

Others

Notice on the Software

[Notifications Related to GNU GPL/LGPL-applicable Software](#)

[Other Software](#)

[Trademarks](#)

Data Projector
VPL-PHZ60/PHZ50

Checking the Supplied Accessories

Confirm that the following components are included. The () indicates the quantity of the component.

- Remote Commander (RM-PJ8) (1)
- Lithium battery (CR2025) (1)
The battery is already installed. Before using the Remote Commander, remove the insulation film.
- AC power cord (1)
- Mini D-sub 15-pin cable (1.8 m) (1)
(1-970-584-11/Sony)
- Setup Guide (1)

Data Projector
VPL-PHZ60/PHZ50

Inserting the Battery into the Remote Commander

The lithium battery is attached to the Remote Commander at the time of purchase. Before using the Remote Commander, remove the insulation film.

If the Remote Commander can no longer be operated, exchange the lithium battery for a new one by the following procedure.

1 Pull out the lithium battery compartment.

Pull the battery compartment toward you while releasing the lock.

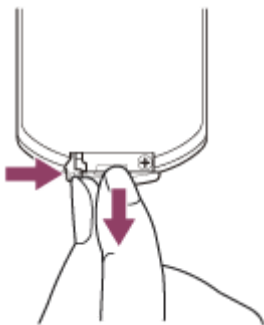

2 Insert a lithium battery.

The lithium battery should be placed in the compartment with the plus side facing up.

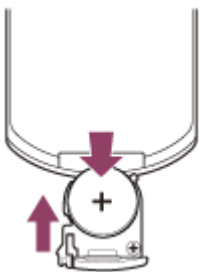

3 Close the lithium battery compartment.

Data Projector
VPL-PHZ60/PHZ50

Parts and Controls (Main Unit)

Top/Front /Right

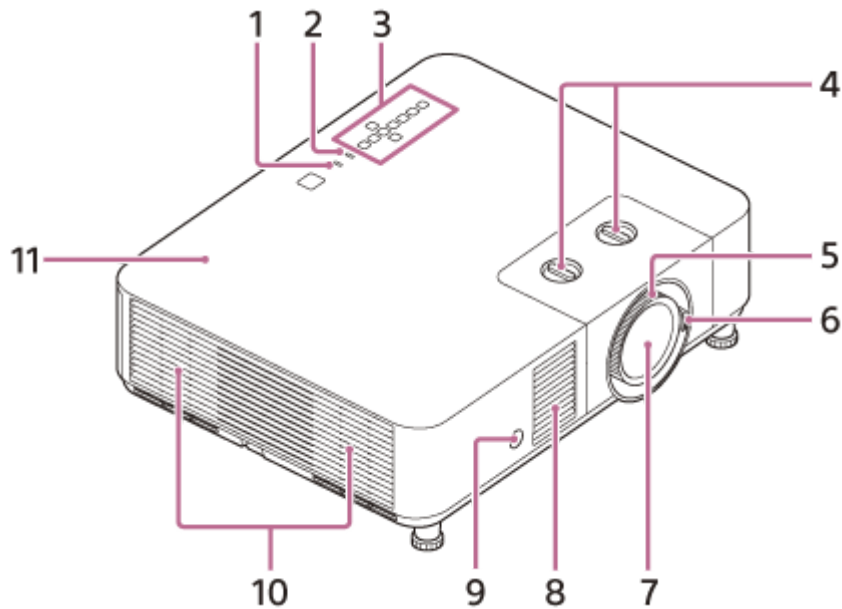

1. ON/STANDBY indicator
2. WARNING indicator
3. Control panel
4. Lens shift dial
5. Focus ring
6. Zoom lever
7. Projection lens
8. Ventilation holes (intake)
9. Remote control receiver
10. Ventilation holes (exhaust)
11. Top cover

Rear/Bottom

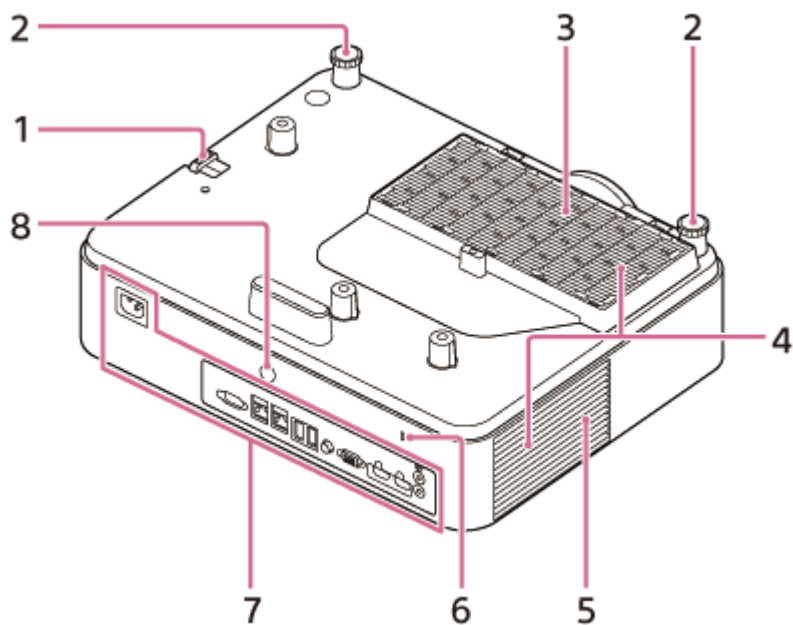

1. Antitheft bar

For attaching theft prevention chains (wires) and such sold commercially.

2. Front feet (adjustable)

3. Air filter cover

4. Ventilation holes (intake)

5. Speaker

6. Antitheft lock

For attaching theft prevention cables manufactured by Kensington.

For details, visit the Kensington website.

<https://www.kensington.com/>

7. Terminals

8. Remote control receiver

Caution



Do not place anything near the ventilation holes. The temperature may rise inside the unit, leading to a possible malfunction or fire. Do not place your hand or easily deformable objects near the ventilation holes (exhaust) and its vicinity. Doing so may result in the burning or deformation of these objects.

Related Topic

- [Parts and Controls \(Connection Terminals\)](#)
- [Parts and Controls \(Remote Commander and Control Panel\)](#)
- [Cleaning the Air Filter](#)
- [Reading the Indicator](#)

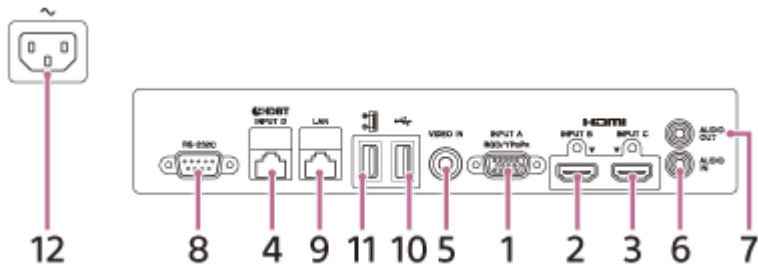
Parts and Controls (Connection Terminals)



- 1. Input A (INPUT A)**
Video: RGB/Y PB PR input terminal (RGB/Y PB PR)
- 2. Input B (INPUT B)**
Video: HDMI input terminal (HDMI)
Audio: HDMI input terminal (HDMI)
- 3. Input B (INPUT C)**
Video: HDMI input terminal (HDMI)
Audio: HDMI input terminal (HDMI)
- 4. Input D (INPUT D)**
HDBaseT terminal (HDBT)
- 5. Video (VIDEO IN)**
Video: Video input terminal
- 6. Audio (AUDIO IN)**
Audio: Audio input terminal
- 7. Audio (AUDIO OUT)**
Audio: Audio output terminal
- 8. RS-232C terminal (RS-232C)**
A control terminal compliant to RS-232C. Connect to the RS-232C computer terminal with an RS-232C cable (cross).
- 9. LAN terminal**
- 10. USB terminal (Type A) ()**
Terminal for software update
- 11. USB terminal (Type A)**
Dedicated terminal for power supply. USB power supply up to 5 V/2 A is available.
- 12. AC IN socket ()**
Connect the supplied AC power cord.

Related Topic

- [Connecting to a Computer with an RGB Output Terminal](#)
- [Connecting to a Computer with an HDMI Output Terminal](#)
- [Connecting to a Computer via a Hub or Router](#)
- [Connecting to a Video Device with a Video Output Terminal](#)
- [Connecting to a Video Device with a Y PB PR Output Terminal](#)
- [Connecting to a Video Device with an HDMI Output Terminal](#)
- [Connecting to Audio Equipment](#)
- [Connecting to an HDBaseT™ Device](#)
- [Supplying the power to an external device](#)

Parts and Controls (Remote Commander and Control Panel)

Remote Commander

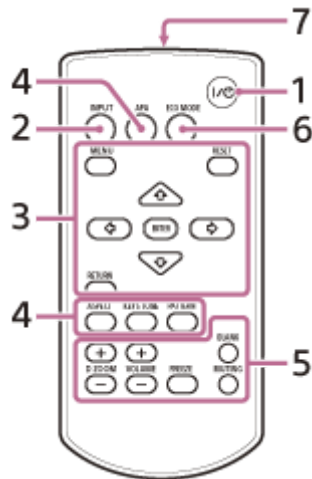

Control panel

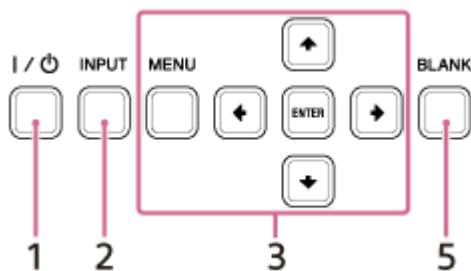

1. **I / ⏻ (On/Standby) key**
Turn on/Standby.
2. **INPUT (Input selection) key**
Select the input.
3. **MENU (Menu) key**
RESET (Reset) key
ENTER (Enter)/ ↑ / ↓ / ← / → (Arrow) keys
RETURN (Return) key
Perform menu operations, etc.
4. **ASPECT (Aspect) key**
Switch the aspect ratio of the projected image.
KEYSTONE (Trapezoidal correction) key/PATTERN (Pattern) key
Adjust the projected image.
APA (Auto Pixel Alignment) key
Adjust the input signal to fit to the screen automatically when there is a computer signal being input from the RGB input terminal (Input A).
5. **D ZOOM (Digital zoom) +/- key**
Zoom in or out on a part of the projected image. This can be used when there is a computer signal being input. However, depending on the input signal resolution, it may not be usable.
BLANK (Eliminate image) key
Temporarily turn off the projected image. Press again to release.
MUTING (Mute) key
When sound is output, temporarily mute the audio. Press again to release.
VOLUME (Sound volume) +/- key

Adjust the sound volume.

FREEZE (Freeze) key

Temporarily freeze the image. Press again to release.

6. ECO MODE (Eco Mode) key

Allows you to set to Eco Mode.

7. Infrared transmitter

Remote Commander Operation

- Direct the Remote Commander toward the remote control receiver.
- The shorter the distance between the Remote Commander and the projector, the wider the angle within which the Remote Commander can control the projector.
- If there is any obstruction between the Remote Commander and the remote control receiver on the projector, the projector may not be able to receive signals from the Remote Commander.

Related Topic

- [Turning Power On/Off](#)
- [Projecting Images](#)
- [Using the Digital Zoom Function](#)
- [Using Eco Mode](#)
- [Navigating Menus](#)

Data Projector
VPL-PHZ60/PHZ50

Precautions When Connecting

- Turn off all devices before making any connections.
- Use the proper cables for each connection.
- Firmly insert the cable plugs. Loose connections may reduce the performance of picture signals or cause a malfunction. When unplugging a cable, be sure to grip the plug, not the cable itself.
- For more information, refer also to the instruction manual of the device to be connected.
- Use a no-resistance audio cable.

Data Projector
VPL-PHZ60/PHZ50

Connecting to a Computer with an RGB Output Terminal

Connect the INPUT A terminal to a computer's RGB output terminal and the AUDIO IN terminal to a computer's audio output terminal.

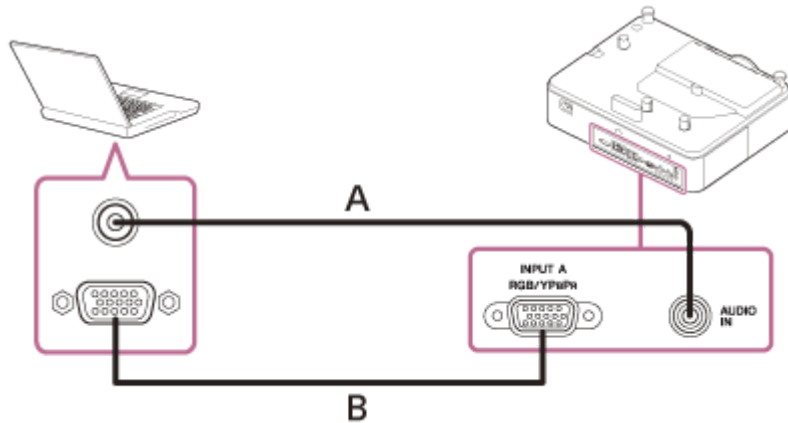

A: Audio cable (stereo mini plug) (not supplied)

B: Mini D-sub 15-pin cable (supplied)

Hint

- For the screen settings of your computer, it is recommended that you set the resolution of the external monitor to 1,920 × 1,200 pixels.

Related Topic

- [Parts and Controls \(Connection Terminals\)](#)
- [Precautions When Connecting](#)

Data Projector
VPL-PHZ60/PHZ50

Connecting to a Computer with an HDMI Output Terminal

Connect the INPUT B terminal or INPUT C terminal to a computer's HDMI output terminal.

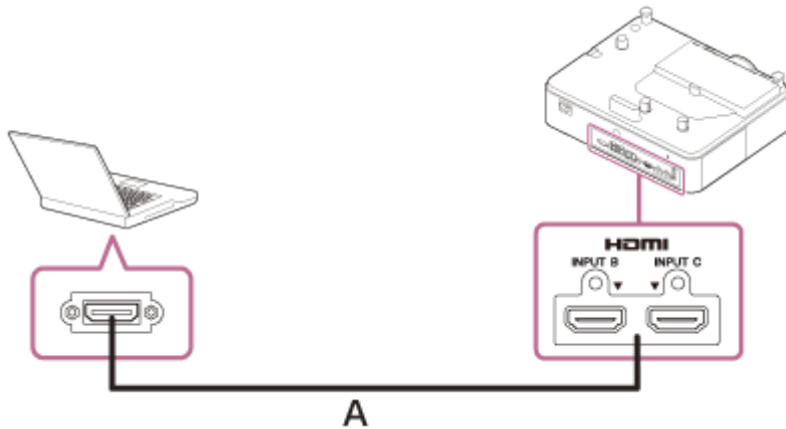

A: HDMI cable (not supplied)

Note

- Use an HDMI-compatible device with the HDMI Logo.
- Use a high speed HDMI cable(s) on which the cable type logo is specified. (Sony products are recommended.)
- The HDMI terminal of this projector is not compatible with DSD (Direct Stream Digital) signals and CEC (Consumer Electronics Control) signals.

Related Topic

- [Parts and Controls \(Connection Terminals\)](#)
- [Precautions When Connecting](#)

Connecting to a Computer via a Hub or Router

Connect the LAN terminal and the computer LAN terminal via a hub or router.

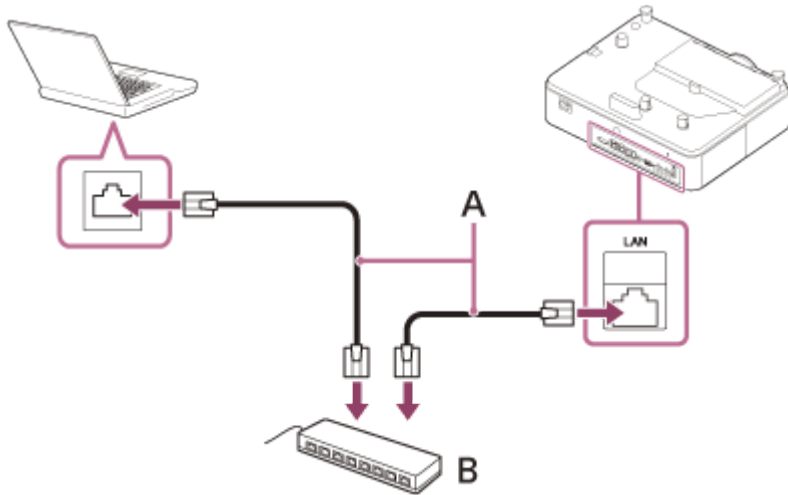

- A:** LAN cable (straight) (not supplied)
B: Hub or router, etc.

Note

- When using network features via the LAN terminal, be sure to check if [LAN Setting] is set to [LAN Port].
- Connect the projector to the network that is constructed to control the access from the internet, such as LAN. If the projector is connected directly to the internet, the security risk is increased.
- **When you monitor and control the projector via the network, display the control window of the projector with a web browser and enable the desired control protocol.**

Related Topic

- [Parts and Controls \(Connection Terminals\)](#)
- [Precautions When Connecting](#)
- [Menu Operation: HDBaseT Settings](#)
- [Setting Advertisement](#)
- [Setting PJ Link](#)
- [Setting PJ Talk](#)
- [Setting ADCP](#)

Data Projector
VPL-PHZ60/PHZ50

Connecting to a Video Device with a Video Output Terminal

Connect the VIDEO IN terminal to a video device's video output terminal, and the AUDIO IN terminal to a video device's audio output terminal.

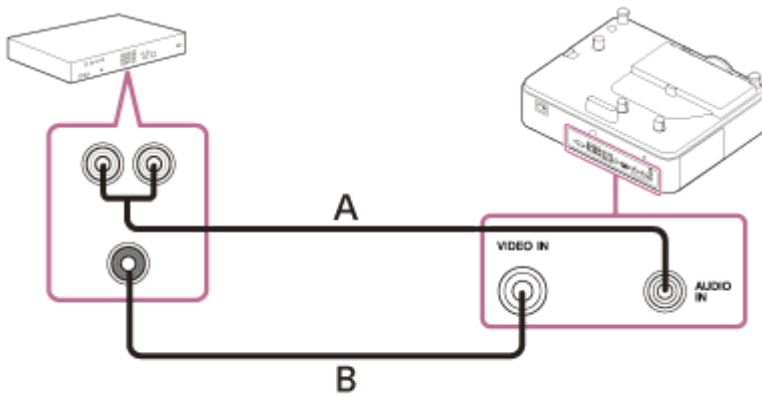

A: Audio cable (Pin plug x 2 - Stereo mini plug) (not supplied)

B: Video cable (not supplied)

Related Topic

- [Parts and Controls \(Connection Terminals\)](#)
- [Precautions When Connecting](#)

Data Projector
VPL-PHZ60/PHZ50

Connecting to a Video Device with a Y PB PR Output Terminal

Connect the INPUT A terminal to a video device's Y PB PR output terminal, and the AUDIO IN terminal to a video device's audio output terminal.

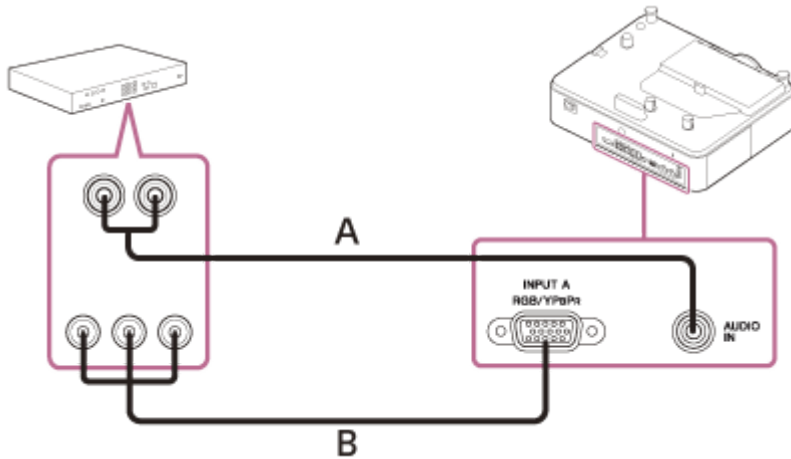

A: Audio cable (Pin plug x 2 - Stereo mini plug) (not supplied)

B: Component - Mini D-sub 15-pin cable (not supplied)

Related Topic

- [Parts and Controls \(Connection Terminals\)](#)
- [Precautions When Connecting](#)

Connecting to a Video Device with an HDMI Output Terminal

Connect the INPUT B terminal or INPUT C terminal to a video device's HDMI output terminal.

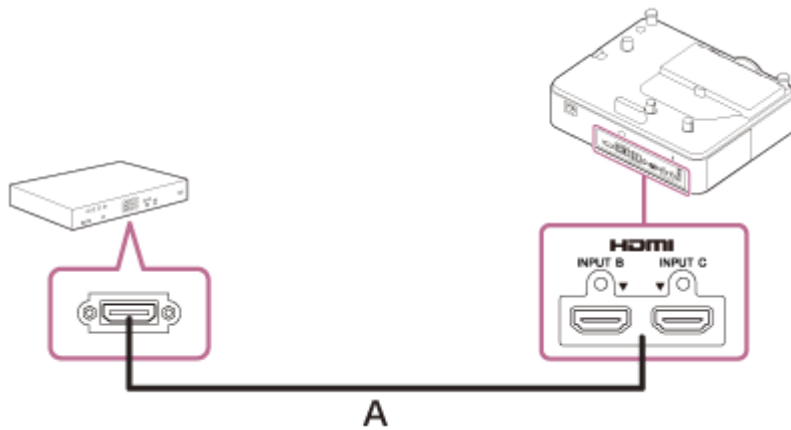

A: HDMI cable (not supplied)

Note

- Use an HDMI-compatible device with the HDMI Logo.
- Use a high speed HDMI cable(s) on which the cable type logo is specified. (Sony products are recommended.)
- The HDMI terminal of this projector is not compatible with DSD (Direct Stream Digital) signals and CEC (Consumer Electronics Control) signals.

Related Topic

- [Parts and Controls \(Connection Terminals\)](#)
- [Precautions When Connecting](#)

Data Projector
VPL-PHZ60/PHZ50

Connecting to Audio Equipment

By connecting the AUDIO OUT terminal and the audio input terminal of speakers with built-in amplifiers or other such devices, you can output the audio fed into the projector through the audio device. When [Speaker Setting] is set to [Always On] and the light is off, Input A becomes active.

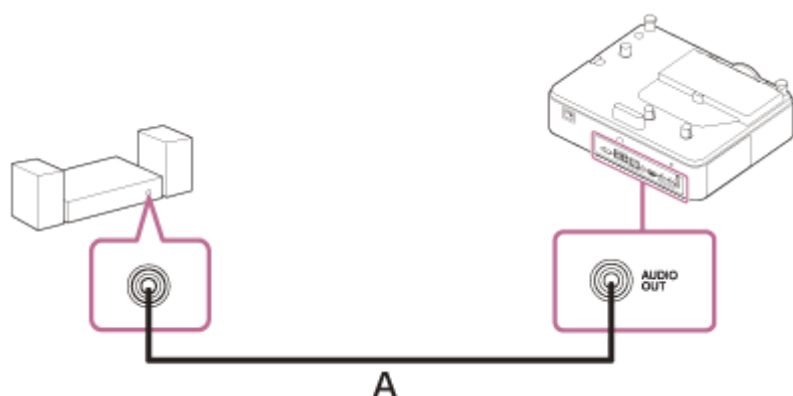

A: Audio cable (Stereo mini plug) (not supplied)

Related Topic

- [Parts and Controls \(Connection Terminals\)](#)
- [Precautions When Connecting](#)
- [Menu Operation: Speaker Setting](#)

Data Projector
VPL-PHZ60/PHZ50

Fixing the HDMI Cable to the Projector

If you wish to fix the HDMI cable to the projector, attach a commercially available cable tie or similar item (B) to the antitheft bar (A) on the bottom surface, and secure it as shown in the image.

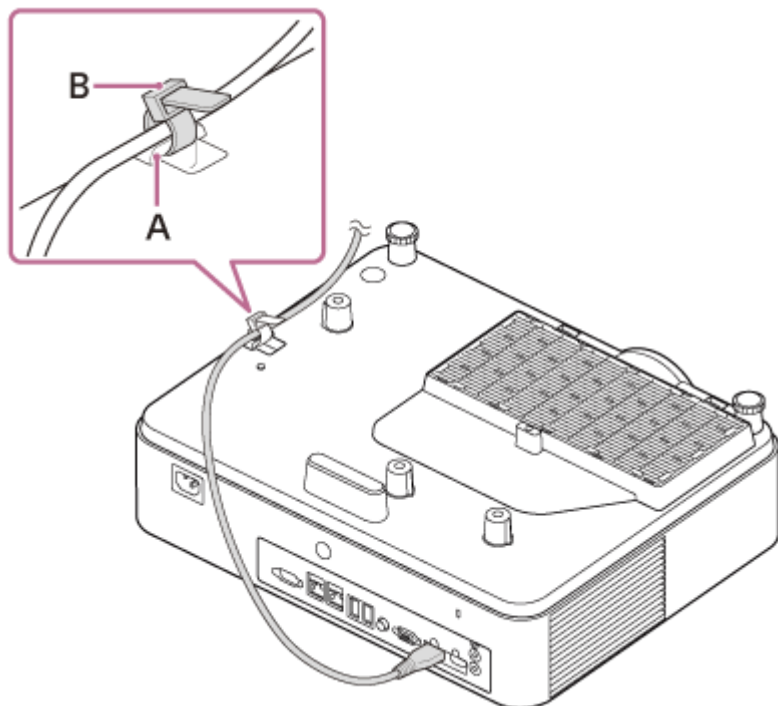

Related Topic

- [Parts and Controls \(Main Unit\)](#)

Connecting to an HDBaseT™ Device

The HDBaseT transmitter is used when connecting the projector to a computer, video device, or network equipment.

Note

- Ask a professional or Sony dealer to perform wiring. If wiring has been insufficiently performed, it affects the transmission characteristics of the cable, and causes broken or unstable images.
- Connect the cable directly to the HDBaseT transmitter without going through a hub or router.
- Use cables that meet the following conditions.
 - CAT5e or higher
 - Shielded type (covering connectors)
 - Straight wire connection
 - Single wire
- When installing the cables, use a cable tester, cable analyzer, or similar device to check if the cables meet the CAT5e or higher requirement. If there is a transit connector between this unit and the HDBaseT transmitter, include it when measuring.
- To reduce the affect of noise, install and use the cable in a manner where it is not rolled up and it is as straight as possible.
- Install the cable away from the other cables (especially the power cable).
- When installing multiple cables, do not bind them and keep the running parallel distance as short as possible.
- The transmittable distance of the cable is 100 m (approx. 328 feet) maximum. If it exceeds 100 m (approx. 328 feet), it may cause broken images or a malfunction in LAN communication. Do not use the HDBaseT transmitter beyond the maximum transmittable distance of the cable.
- For operation or function problems caused by devices of other manufacturers, contact the relevant manufacturer.

Connecting to a computer/video device

Connect the HDBaseT terminal to the HDMI output terminal on a computer or video device.

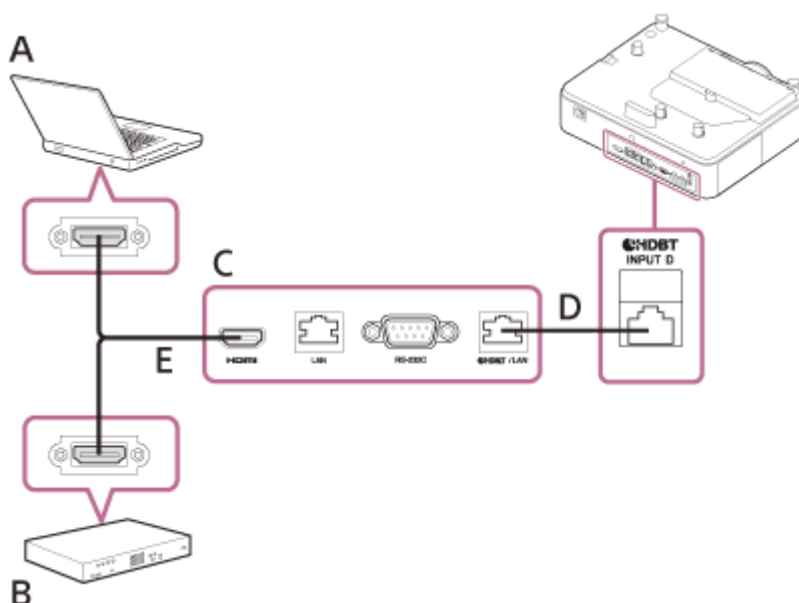

- A: Computer
- B: Video device
- C: HDBaseT transmitter

- D: LAN cable: STP cable with CAT5e or higher (straight type) (not supplied)
- E: HDMI cable (not supplied)

Connecting to a network equipment (using an HDBaseT terminal)

The HDBaseT terminal is used when connecting the projector to a network equipment to control the projector.

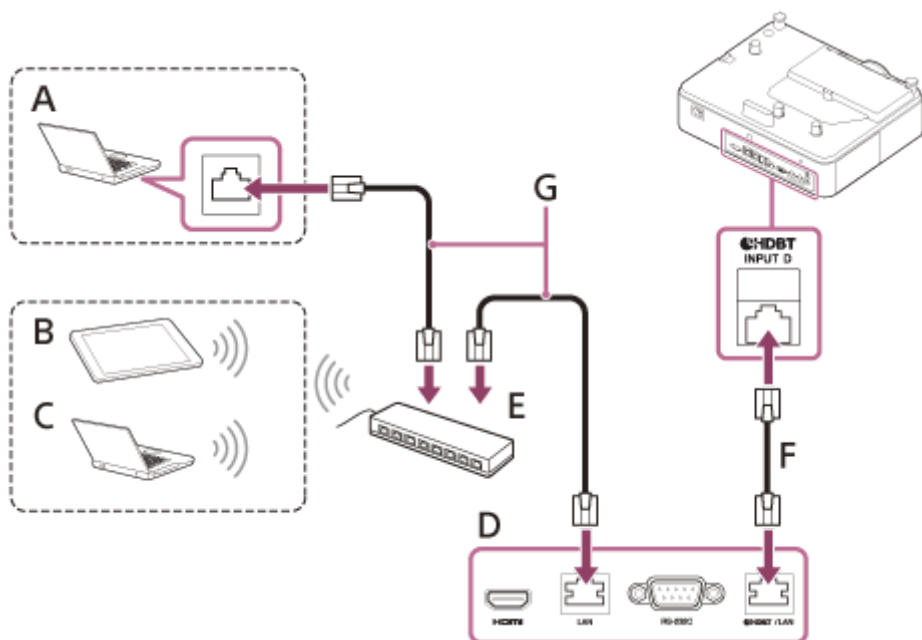

- A: Computer (Wired connection)
- B: Tablet PC/Smartphone
- C: Computer (Wireless connection)
- D: HDBaseT transmitter
- E: Hub, wireless router
- F: LAN cable: STP cable with CAT5e or higher (straight type) (not supplied)
- G: LAN cable (straight type) (not supplied)

Note

- When using the network features, make sure that [LAN Setting] is set to [via HDBaseT] under [HDBaseT Settings].
- Connect the projector directly to the HDBaseT transmitter without going through a hub or router.
- When connecting to XTP Systems manufactured by Extron Electronics, it is necessary to set [Extron XTP] to [On] under [HDBaseT Settings].
- When you monitor and control the projector via the network, access the Control Window of the projector via a Web browser and enable the desired control protocol.

Related Topic

- [Parts and Controls \(Connection Terminals\)](#)
- [Precautions When Connecting](#)
- [Menu Operation: HDBaseT Settings](#)
- [Uses for Network Features](#)

Data Projector
VPL-PHZ60/PHZ50

Supplying the power to an external device

The unit supplies power (5 V/2 A maximum) via the USB cable to the external device.
Connect the USB terminal (for power supply only) to the external device.

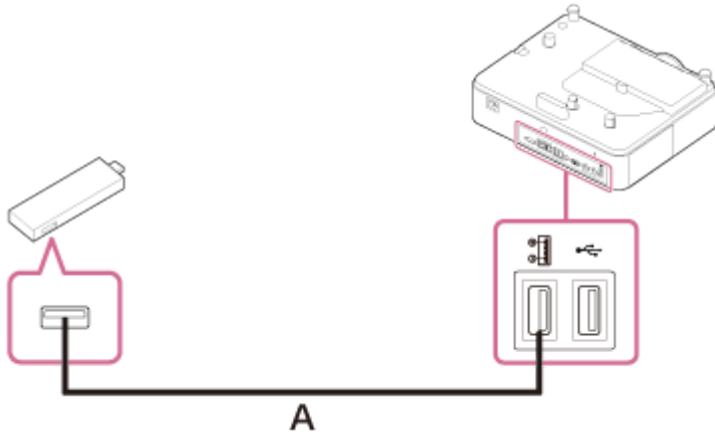

A: USB cable (Type A) (not supplied)

Note

- Use external devices with the appropriate specification for using this unit.
- If you connect the unit in wrong ways, the external device may cause a malfunction. In this case, Sony assumes no responsibility.
- If Standby Mode is [Low], you will no longer be able to supply the power while in Standby Mode.
- A power consumption of the connected device that exceeds the sharable power (5 V/2 A) cannot be used.

Related Topic

- [Parts and Controls \(Connection Terminals\)](#)
- [Precautions When Connecting](#)

Data Projector
VPL-PHZ60/PHZ50

Turning Power On/Off

- 1 Plug the AC power cord into a wall outlet.**
- 2 Turn on the projector.**
Press the  (On/Standby) key on the main unit or the Remote Commander.

Turning Power Off

- Press the  (On/Standby) key on the main unit or the Remote Commander.
The projector starts shutdown and turns off.
For long-term use, turn off the projector when not in use.
- Unplug the AC power cord from the wall outlet.

Related Topic

- [Parts and Controls \(Main Unit\)](#)
- [Parts and Controls \(Remote Commander and Control Panel\)](#)

Selecting the Menu Language

The factory setting for the language for displaying menus, messages, etc. is English. To change the on-screen language, proceed as follows:

1 Press the MENU key to display the menu screen.

If the display cannot be properly seen, adjust the focus, size, and position of the projected image.

2 Select the menu language.

1. Press the **▲** (Up) or **▼** (Down) key to select **☰** [Operation] (Operation), then press the ENTER key.
2. Press the **▲** (Up) or **▼** (Down) key to select **A** [Language] (Language), then press the ENTER key.

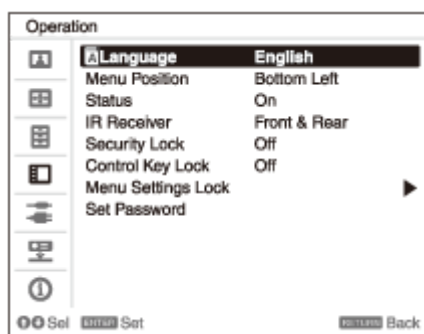

3. Press the **▲** / **▼** / **◀** / **▶** (Up/Down/Left/Right) key to select a language, then press the ENTER key.

3 Press the MENU key to turn off the menu screen.

Related Topic

- [Menu Operation: Language](#)

Data Projector
VPL-PHZ60/PHZ50



Projecting Images

The size of the projected image changes depending on the distance from the projector to the screen (projection distance). Install the projector so that it matches the screen size.

1 Press the  (On/Standby) key and turn on the projector.

2 Turn on the connected device.

3 Select the input source.

Press the INPUT key on the main unit or the Remote Commander to display the input select window. Press the INPUT key repeatedly or press the  /  (Up/Down) key to select the image to be projected.

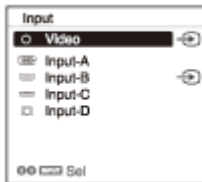

4 Change the computer screen output destination to an external display.

How the output destination is changed varies depending on the computer.
Ex.)

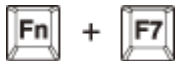

5 Adjust the focus, size and position of the projected image.

Related Topic

- [Projection Distance](#)
- [Lens Shift Range](#)
- [Adjusting the Screen Focus](#)
- [Adjusting the Screen Size](#)
- [Adjusting the Screen Position](#)

Data Projector
VPL-PHZ60/PHZ50

Adjusting the Screen Focus



Turn the focus ring to adjust the focus.

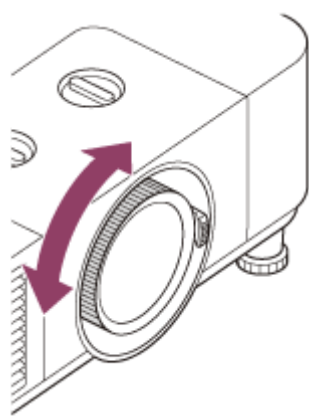

Related Topic

- [Parts and Controls \(Main Unit\)](#)

Data Projector
VPL-PHZ60/PHZ50

Adjusting the Screen Size



Turn the zoom lever to adjust the size.

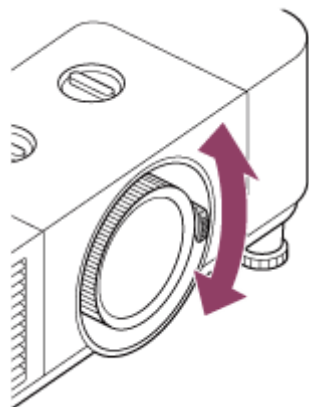

Related Topic

- [Parts and Controls \(Main Unit\)](#)

Data Projector
VPL-PHZ60/PHZ50

Adjusting the Screen Position

Adjusting the tilt of the projector by using lens shift



Turn the H lens shift dial to adjust the lens horizontally or turn the V lens shift dial to adjust the lens vertically.

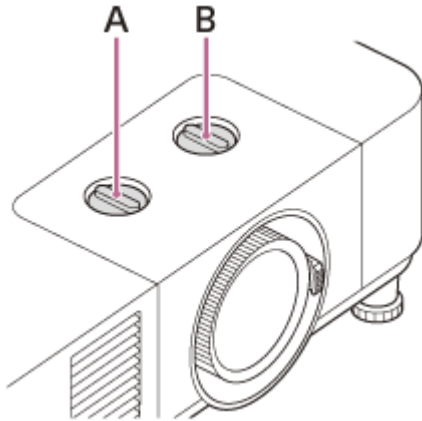

A: H lens shift dial

B: V lens shift dial

If you keep turning the lens shift dial, it will be difficult to turn it further at some point. In that case, turn the lens shift dial in the opposite direction to find the best position. For details on the adjustment range, refer to “[Lens Shift Range](#).”

Note

- While adjusting the lens shift, be careful not to look into the lens.
- When turning the H lens shift dial, the lens shift may move up or down. (When turning the V lens shift dial, the lens shift may move right or left.) In that case, adjust the lens shift with each dial again.

Adjusting the tilt of the projector with the front feet (adjustable)

Adjust the position of the projected screen by changing the angle of the projector using the front feet (adjustable).

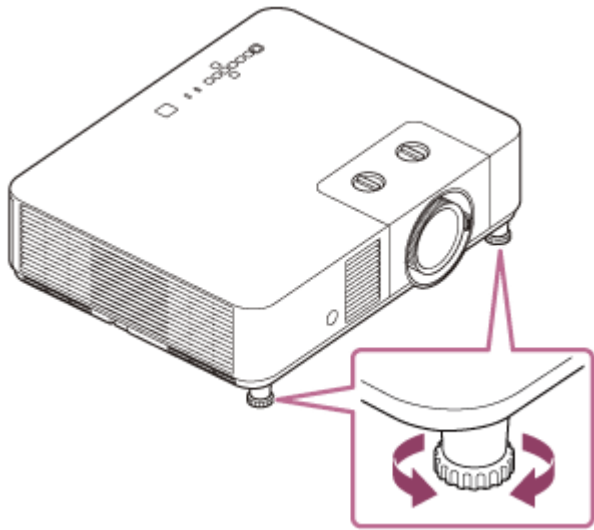

Note

- When adjusting the front feet (adjustable), be careful not to get your fingers caught.
- Do not forcefully press down on the projector with the front feet (adjustable) extended. This may result in malfunction.

Related Topic

- [Parts and Controls \(Main Unit\)](#)
- [Lens Shift Range](#)

Data Projector
VPL-PHZ60/PHZ50

Changing the Screen Aspect Ratio

Pressing the ASPECT key on the Remote Commander switches the aspect ratio of the projected screen.

Hint

- The screen aspect ratio can also be set from [Aspect] in the  [Screen] menu.

Related Topic

- [Parts and Controls \(Remote Commander and Control Panel\)](#)
- [Menu Operation: Aspect](#)

Correcting a Vertical Trapezoid

If the screen is trapezoidal, perform a keystone correction.

1 Press the KEYSTONE key on the Remote Commander once.

The adjustment menu will be displayed.

You can also display the adjustment menu from [V Keystone] in the  [Installation] menu.

2 Adjust the value with the  /  /  /  (Up/Down/Left/Right) keys.

A: Increasing the value in the positive direction makes the upper side screen width smaller.

B: Increasing the value in the negative direction makes the lower side screen width smaller.



Press the RESET key to return to the non-corrected state.

Note

- Because keystone correction is an electronic form of correction, the image quality may be reduced.
- If vertical correction (V keystone correction) and horizontal adjustment (H keystone correction) are performed at the same time, the values in each adjustment menu may not reach the maximum.

Related Topic

- [Parts and Controls \(Remote Commander and Control Panel\)](#)
- [Menu Operation: V Keystone](#)

Correcting a Horizontal Trapezoid

If the screen is trapezoidal, perform a keystone correction.

1 Press the KEYSTONE key on the Remote Commander twice.

The adjustment menu will be displayed.

You can also display the adjustment menu from [H Keystone] in the  [Installation] menu.

2 Adjust the value with the  /  /  /  (Up/Down/Left/Right) keys.

A: Increasing the value in the negative direction makes the left side of the screen smaller.

B: Increasing the value in the positive direction makes the right side of the screen smaller.



Press the RESET key to return to the non-corrected state.

Note

- Because keystone correction is an electronic form of correction, the image quality may be reduced.
- If vertical correction (V keystone correction) and horizontal adjustment (H keystone correction) are performed at the same time, the values in each adjustment menu may not reach the maximum.

Related Topic

- [Parts and Controls \(Remote Commander and Control Panel\)](#)
- [Menu Operation: H Keystone](#)

Correcting Screen Distortion

You can correct image distortion using the corner keystone function.

1 Press the KEYSTONE key on the Remote Commander three times.

The guide will be displayed.

You can also display the guide menu from [Corner Keystone] - [Adjust] in the  [Installation] menu.

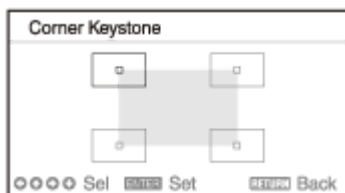

2 Select the corner you wish to correct using the  /  /  /  (Up/Down/Left/Right) keys.

3 Press the ENTER key.

The selected corner becomes a cursor display ().

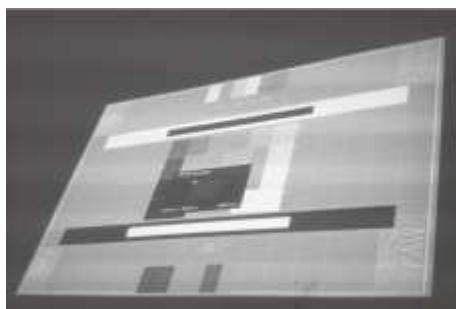

Cursor display example:



Adjustable in all directions



Only adjustable horizontally or downward.

4 Adjust the corner position with the  /  /  /  (Up/Down/Left/Right) keys.

When a distortion adjustment reaches the limit, the cursor will disappear.

Press the RESET key to return to the non-corrected state.

Related Topic

- [Parts and Controls \(Remote Commander and Control Panel\)](#)
- [Menu Operation: Corner Keystone](#)

5-025-459-11(1) Copyright 2020 Sony Corporation

Data Projector
VPL-PHZ60/PHZ50

Displaying Patterns

Pressing the PATTERN key on the Remote Commander allows you to display the ruled line pattern, lattice pattern, or adjustment pattern on the projected screen. Every time you press the PATTERN key, the pattern to be displayed switches.

Continue pressing the PATTERN key to return to the original screen.

Hint

- The ruled line pattern and lattice pattern can be used as auxiliary lines when drawing text and figures on a whiteboard or blackboard without using a computer.
- There are 2 types of color for the lines of the ruled line pattern and lattice pattern so you can select a line that is easier to see according to the color of the projected screen.

Related Topic

- [Parts and Controls \(Remote Commander and Control Panel\)](#)



Data Projector
VPL-PHZ60/PHZ50

Using the Auto Adjustment Function

When feeding a computer signal from the RGB input terminal (Input A), pressing the APA (Auto Pixel Alignment) key on the Remote Commander allows the projected screen phase, pitch, and shift to be automatically adjusted.

Pressing the APA key once more during adjustment will cancel the adjustment.

Hint



- APA can also be performed from [Adjust Signal] in the  [Screen] menu.
- Selecting [On] from [Smart APA] in the  [Function] menu will automatically perform APA when a computer signal is fed from the RGB input terminal (Input A).

Related Topic

- [Parts and Controls \(Remote Commander and Control Panel\)](#)
- [Menu Operation: Adjust Signal](#)
- [Menu Operation: Smart APA](#)

Use the Intelligent Setting Function

Optimize the image quality settings, light settings, and system cooling (fan speed) just by choosing the location that matches the environment where the projector is being used. The [Intelligent Setting] helps the projector remain in stable operation for long periods of time.

- 1 Press the MENU key to display the menu screen.
- 2 Set [Intelligent Setting] in the  [Projection Setting] menu to [On] and press the  (Right) key.

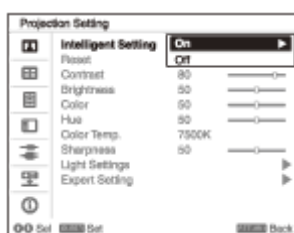

- 3 Select the location the projector is being used.



[Meeting/Class Room]

Optimizes the text and graphic quality so that they are displayed clearly. This is suitable for use in meeting rooms and classrooms.

[Museum]

Optimizes the color quality so that colors are reproduced accurately. This is suitable for use in quiet places such as galleries and museums.

[Entertainment]

Optimizes the image quality to achieve balance. This is suitable for use at theme parks, public entertainment facilities, conference rooms in the exhibition hall, and so on.

- 4 Select [Apply] and press the ENTER key.





Related Topic

- [Menu Operation: Intelligent Setting](#)

Data Projector
VPL-PHZ60/PHZ50

Using the Digital Zoom Function

Enlarge a portion of the projected image. This can be used when there is a computer signal being input. However, it may not be usable depending on the input signal resolution.

- 1 Press the D ZOOM + key to display the digital zoom icon on the projected screen.
- 2 Adjust the image position with the  /  /  /  (Up/Down/Left/Right) keys.
- 3 Press the D ZOOM + key to enlarge an image.
- 4 Repeatedly press the D ZOOM + key or the D ZOOM - key to change the magnification ratio.

The magnification ratio can be changed from 1x to 4x.
When you select 1x, you cannot adjust the image position.

To return to the original image, press the RESET key.

Related Topic

- [Parts and Controls \(Remote Commander and Control Panel\)](#)

Using Eco Mode

The [With No Input] and [With Static Signal] of the Eco Mode settings are easy to use.

Note

- If [ECO Mode] is set to [ECO] or if [Standby Mode] for [User] is set to [Low], you will no longer be able to use network control functions while in Standby Mode. If performing external control via networks and network control functions and so on, either do not select [ECO] or do not set [Standby Mode] for [User] to [Low].

- 1 Press the ECO MODE key to display the [ECO Mode] menu.

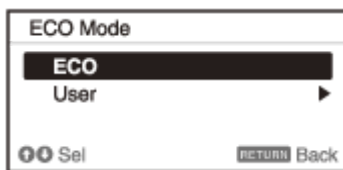

- 2 Press the **↑ / ↓** (Up/Down) key or the ECO MODE key, then select either [ECO] or [User] mode.

- [ECO]: Set each setting to the value that saves the most energy.
 - With No Input: [Standby]
 - With Static Signal: [Light Dimming]
- [User]: Configure the Eco Mode settings manually.

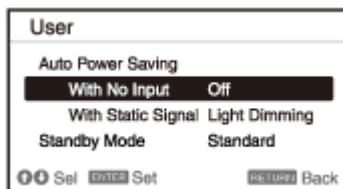

- 3 Press the RETURN key to return to the previous screen.

Related Topic

- [Parts and Controls \(Remote Commander and Control Panel\)](#)
- [Menu Operation: ECO](#)

Navigating Menus

Various projector adjustments and settings can be performed from the menu screen. Selecting an item with an arrow (▶) after the item name will display the items to be set in the next tier.

Note

- The images used in the explanation are for reference only. Please note that the items displayed may differ depending on the device you are using.

1 Press the MENU key.

The menu screen will be displayed.

2 Press the ▲ / ▼ (Up/Down) key to select the menu, then press either the ▶ (Right) key or the ENTER key.

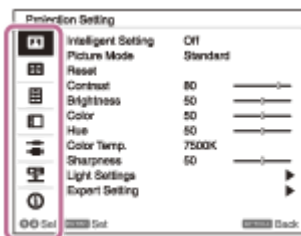

3 Press the ▲ / ▼ (Up/Down) key to select an item, then press either the ▶ (Right) key or the ENTER key.

To return to the configuration menu selection, press the ◀ (Left) key or the RETURN key.

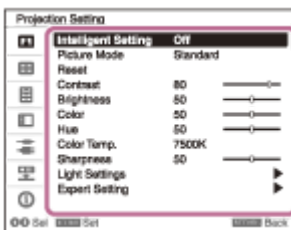

4 Configure and adjust the items.

The configuration method differs depending on the item.

If a further tier is displayed, select the item you wish to configure in accordance with Step 3, then press the ENTER key to confirm the configuration.

To return to the configuration item selection, press the ◀ (Left) key or the RETURN key. To reset the setting value of an item to its factory preset value, press the RESET key during setting or adjusting.

Navigating Pop-up Menus

Select items using the ▲ / ▼ / ◀ / ▶ (Up/Down/Left/Right) key.

Press the ENTER key to confirm the settings, and return to the previous screen.

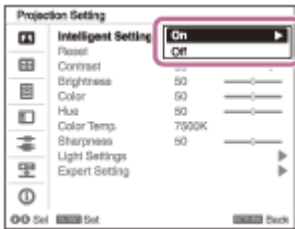

Navigating Settings Menus

Select items using the **↑** / **↓** (Up/Down) key.

Press the ENTER key to confirm the settings, and return to the previous screen.



Navigating Adjustment Menus

When increasing a value, press the **↑** (Up) or **➡** (Right) key.

When decreasing a value, press the **↓** (Down) or **⬅** (Left) key.

Press the ENTER key to confirm the settings, and return to the previous screen.



5 Press the MENU key to exit the menu screen.

If an operation has not been performed for some time, the menu screen will automatically disappear.

Related Topic

- [Parts and Controls \(Remote Commander and Control Panel\)](#)

Data Projector
VPL-PHZ60/PHZ50

Menu Operation: Intelligent Setting

Setting [Intelligent Setting] to [On] allows you to optimize the image quality settings, light settings, and system cooling (fan speed) just by choosing the location that matches the environment where the projector is being used. This setting helps the projector remain in stable operation for long periods of time.

- 1 Press the MENU key.
- 2 Select  [Projection Setting] - [Intelligent Setting] - [On] or [Off].
- 3 If [On] is selected, select the item you wish to configure in [Location].

Settings

[Meeting/Class Room]

Optimizes the text and graphic quality so that they are displayed clearly. This is suitable for use in meeting rooms and classrooms.

[Museum]

Optimizes the color quality so that colors are reproduced accurately. This is suitable for use in quiet places such as galleries and museums.

[Entertainment]

Optimizes the image quality to achieve balance. This is suitable for use at theme parks, public entertainment facilities, conference rooms in the exhibition hall, and so on.

Note

- If [Intelligent Setting] is [On], [Picture Mode] in the  [Projection Setting] menu cannot be configured.
- If there is no usage environment that corresponds to the choices for [Location], then choose the location with the characteristics closest to your environment.
[Location] cannot be configured for each input terminal.

Related Topic

- [Menu Operation: Picture Mode](#)

Data Projector
VPL-PHZ60/PHZ50

Menu Operation: Picture Mode

Configure the image quality.

- 1 Press the MENU key.
- 2 Select  [Projection Setting] - [Picture Mode] - The desired setting.

Settings

[Dynamic]

Sets the image quality to achieve balance between brightness and darkness.

[Standard]

Sets the image quality to achieve smooth and natural tones.

[Brightness Priority]

Makes the picture bright to suit a bright environment.

Note

- If [Intelligent Setting] in the  [Projection Setting] menu is [On], [Picture Mode] cannot be configured.

Related Topic

- [Menu Operation: Intelligent Setting](#)

Data Projector
VPL-PHZ60/PHZ50

Menu Operation: Reset

Return the image quality settings to their default values.

- 1 Press the MENU key.
- 2 Select  [Projection Setting] - [Reset].

Note

- The [Intelligent Setting] and [Picture Mode] values in the  [Projection Setting] menu will not return to default.

Related Topic

- [Menu Operation: Intelligent Setting](#)
- [Menu Operation: Picture Mode](#)

Data Projector
VPL-PHZ60/PHZ50

Menu Operation: Contrast

Adjust the image contrast.

1 Press the MENU key.

2 Select  [Projection Setting] - [Contrast] - Adjust the values.

The higher the setting, the greater the contrast. The lower the setting, the lower the contrast.

Data Projector
VPL-PHZ60/PHZ50

Menu Operation: Brightness

Adjust the image brightness (luminance).

1 Press the **MENU** key.

2 Select  **[Projection Setting] - [Brightness] - Adjust the values.**

The higher the setting, the brighter the image. The lower the setting, the darker the image.

Data Projector
VPL-PHZ60/PHZ50

Menu Operation: Color

Adjust the image color intensity.

1 Press the MENU key.

2 Select  [Projection Setting] - [Color] - Adjust the values.

The higher the setting, the greater the intensity. The lower the setting, the lower the intensity.

Data Projector
VPL-PHZ60/PHZ50

Menu Operation: Hue

Adjust the image color tone.

1 Press the **MENU** key.

2 Select  **[Projection Setting] - [Hue] - Adjust the values.**

The higher the setting, the more greenish the image becomes. The lower the setting, the more reddish the image becomes.

Data Projector
VPL-PHZ60/PHZ50

Menu Operation: Color Temp.

Adjust the image color temperature.

- 1 Press the **MENU** key.
- 2 Select  **[Projection Setting]** - **[Color Temp.]** - The desired setting.

Settings

[9300K]/[7500K]/[6500K]

The higher the temperature, the bluer the image tones become, and the lower the temperature, the redder the tones become.

[Brightness Priority]

Allows for the brightest projection image.

Data Projector
VPL-PHZ60/PHZ50

Menu Operation: Sharpness

Adjust the outlines of the image.

1 Press the MENU key.

2 Select  [Projection Setting] - [Sharpness] - Adjust the values.

The higher the setting, the sharper the image. The lower the setting, the softer the image.

Data Projector
VPL-PHZ60/PHZ50

Menu Operation: Light Settings

Adjust the laser light brightness.

- 1 Press the **MENU** key.
- 2 Select  **[Projection Setting]** - **[Light Settings]** - The desired setting.

Settings

[Dynamic Control]

[On]/[Off]: If set to [On], the brightness will automatically be adjusted according to the input image. For dark images, the brightness is adjusted as they are being projected, which can help save energy. Conversely, for bright images, the image brightness is not adjusted and the image remains bright.

[Light Output Mode]

Adjust the light source brightness.

- [Standard]: The image becomes bright and energy consumption increases.
- [Middle]: Energy consumption decreases, but the image becomes dark.
- [Extended]: The image becomes dark, but projection becomes possible for long periods of time.
- [Custom]: You can adjust brightness as prefer.

Note

- If [Intelligent Setting] in the  [Projection Setting] menu is [On], [Dynamic Control] cannot be configured.

Data Projector
VPL-PHZ60/PHZ50

Menu Operation: Expert Setting

Set the image quality to match the use location and image source.

- 1 Press the MENU key.
- 2 Select  [Projection Setting] - [Expert Setting] - The desired setting.

Settings

[Reality Creation]

Adjusts the detail and noise processing of images. (Super-resolution function)

- [On]: Adjusts the settings of [Reality Creation].
 - [Resolution]: When you increase the setting value, the texture and detail of the image become sharper.
 - [Test: On/Off]: Switches [On] and [Off] at a certain frequency to check the effect of [Reality Creation]. The display position of the status during the test works together with the [Menu Position] setting.
- [Off]: The [Reality Creation] function is not applied.

Note

- Depending on the input signals, image noise may become more prominent. In that case, adjust the settings of [Reality Creation] before use.

[Bright View]

Creates bright and sharp images suitable for projection in bright places maintaining color balance.

- [High]/[Middle]/[Low]: You can adjust the [Bright View].
- [Off]: The [Bright View] function is not applied.

[Gamma Mode]

- [2.2]: This is gamma correction for making the halftone brighter. This is suitable for projecting photos and vibrant images in bright locations.
- [2.4]: This is gamma correction for reproducing halftone more faithfully. This will project photos and other vibrant images with natural tones.
- [Gamma 3]: This is gamma correction for emphasizing bright portions of the image. Creates a balanced image.
- [DICOM GSDF Sim.]: Gamma setting is in accordance with the Grayscale Standard Display Function (GSDF) of the Digital Imaging and Communications in Medicine (DICOM) standards. This projector is not to be used as a device for medical diagnosis.

[Color Space]

Converts the color space.

- [Custom 1]: Produces images with vivid colors.
- [Custom 2]: Produces images with muted colors.
- [Custom 3]: Reproduces image colors true to the original image source.
 - [Color Select]: Select the color to adjust from [Red], [Green], and [Blue].
 - [Cyan - Red (x)]: Adjusts the chromaticity point of the selected color toward cyan-red (x).
 - [Magenta - Green (y)]: Adjusts the chromaticity point of the selected color toward magenta-green (y).

You can select R/G/B for the selected color space and adjust the R/G/B chromaticity points in the x and y directions in the CIExy chromaticity diagram respectively.

Related Topic

- [Menu Operation: Menu Position](#)

5-025-459-11(1) Copyright 2020 Sony Corporation

Menu Operation: Aspect

Set what aspect ratio images will be projected for each input signal.

- 1 Press the **MENU** key.
- 2 Select  **[Screen]** - **[Aspect]** - Item you wish to configure.

Settings

- For Computer Signal Input
 - [Full 1]: Maintain the aspect ratio and project onto the entire screen.
 - [Full 2]: Project onto the entire screen.
 - [Full 3]: Maintain the aspect ratio and project fully either vertically or horizontally in a resolution no higher than 1920 × 1080.
 - [Normal]: Project the original resolution onto the center of the screen without enlargement processing.
- For Video Signal Input
 - [4:3]: Fix the aspect ratio to 4:3 and project onto the entire screen.
 - [16:9]: Fix the aspect ratio to 16:9 and project onto the entire screen.
 - [Full]: Project onto the entire screen.
 - [Zoom]: Enlarge and project the center of the image.

Note

- Be aware that dividing, shrinking and stretching the display by the aspect ratio function for commercial purposes or public viewing at cafes, hotels, etc., may be in violation of the author's copyrights protected under copyright law.
- Depending on the input, items in [Aspect] or some settings may not be configured. In addition, the image may remain the same even if a different aspect ratio is set.
- Depending on the selected item, some parts of the screen may be displayed in black.

Related Topic

- [Aspect Ratio](#)

Aspect Ratio

Computer Signal

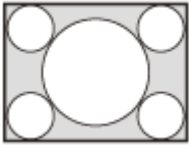
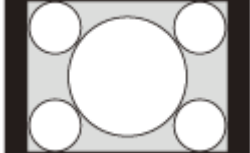
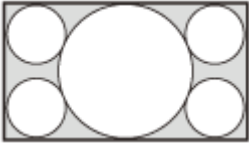
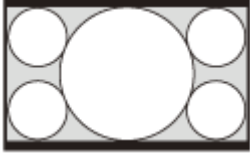
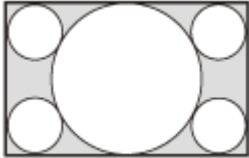
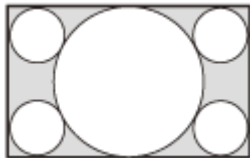
Input signal	Image projected using recommended setting values
4:3 	[Full 1] *1 *2 *3 
16:9 	[Full 1] *1 *2 *3 
16:10 	[Full 1] *3 

*1 Selecting [Normal] will project the image with the image signal resolution as-is without enlargement processing.



*2 Selecting [Full 2] will project the image onto the entire screen with the aspect ratio ignored.



*3 When the screen display position is adjusted for a 16:9 signal, inputting a 4:3 signal may result in the image not fitting on the screen vertically. If this occurs, select [Full 3].

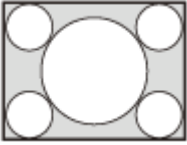
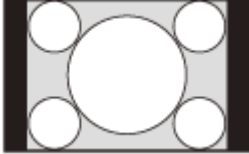
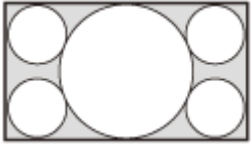
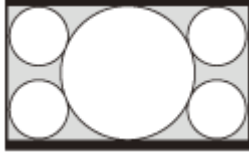

Video Signal

Input signal	Image projected using recommended setting values
4:3 	[4:3] *1 *2 
16:9 	[16:9] 

*1 Depending on the input signal, images may be displayed as follows. In this case, select [16:9].



*2 Depending on the input signal, images may be displayed as follows. In this case, select [Zoom].



Related Topic

- [Menu Operation: Aspect](#)

Data Projector
VPL-PHZ60/PHZ50

Menu Operation: Adjust Signal

Adjust the projected image for computer signal input. Adjust when the edges of the screen are cut off or the image quality is poor.

- 1 Press the MENU key.
- 2 Select  [Screen] - [Adjust Signal] - The desired setting.

Settings

[APA]

Pressing the ENTER key will automatically modify the screen into its optimal state. This item can be selected when a computer input signal is supplied from the RGB input terminal (Input A).

[Phase]

Adjust the input signal and display the pixel phase. Set it to the value that produces the clearest image. This item can be selected when a computer input signal is supplied from the RGB input terminal (Input A).

[Pitch]



Increasing the value will make the horizontal width (pitch) of the display pixels become larger, and decreasing it will make the width become smaller. This item can be selected when a computer input signal is supplied from the RGB input terminal (Input A).

[Shift]

- [H]: Increasing the value will make the screen move to the right, and decreasing the value will make it move to the left.
- [V]: Increasing the value will make the screen move up, and decreasing the value will make it move down.

This item can be selected when a signal is supplied from input terminal RGB/Y PB PR (Input A).

Note

- [APA] may not be able to function properly when there is a large black area around the projected image, and part of the image may not be displayed. In addition, depending on the input, the image may not be optimized. If this occurs, configure [Phase], [Pitch], and [Shift] manually.
- The value adjusted for [Pitch] will return to its factory setting if [APA] or [Smart APA] in the  [Function] menu is performed. If you wish to continue using the adjusted value, set [Smart APA] in the  [Function] menu to [Off].

Related Topic

- [Menu Operation: Smart APA](#)

Data Projector
VPL-PHZ60/PHZ50

Menu Operation: Volume

Adjust the volume.

1 Press the MENU key.

2 Select  [Function] - [Volume] - Adjust the values.

Increasing the value will increase the volume, and decreasing it will decrease the volume.

Data Projector
VPL-PHZ60/PHZ50

Menu Operation: Speaker

Set whether sound is output from the projector speakers.

1 Press the **MENU** key.

2 Select  **[Function] - [Speaker] - [On] or [Off]**.

Selecting **[On]** causes sound to be output from the projector speakers. If you do not wish for sound to be output from the speakers, select **[Off]**.

Data Projector
VPL-PHZ60/PHZ50

Menu Operation: Speaker Setting

Set whether the projector speakers are usable when the projector light is off. When [Speaker Setting] is set to [Always On] and the light is off, Input A becomes active.

- 1 Press the MENU key.
- 2 Select  [Function] - [Speaker Setting] - [Sync with Power] or [Always On].
Selecting [Always On] allows the projector speakers to be used even when the light is off.

Note

- Selecting [Always On] for the [Speaker Setting] will also set [Standby Mode] to [Standard].

Related Topic

- [Using Eco Mode](#)

Data Projector
VPL-PHZ60/PHZ50

Menu Operation: Smart APA

When a computer signal is supplied from the RGB input terminal (Input A), APA is activated automatically, and the screen is adjusted into its optimal state.

1 Press the MENU key.

2 Select  [Function] - [Smart APA] - [On] or [Off].

Selecting [On] allows APA to be activated automatically when a computer signal is supplied.

Related Topic

- [Menu Operation: Adjust Signal](#)

Data Projector
VPL-PHZ60/PHZ50

Menu Operation: CC Display

This operation controls the CC (Closed Captioning) setting.

- 1 Press the **MENU** key.
- 2 Select  **[Function] - [CC Display] - The desired setting.**

Settings

[CC1]/[CC2]/[CC3]/[CC4]/[Text1]/[Text2]/[Text3]/[Text4]

Select the CC (Closed Captioning) service (subtitles or textual information) that is displayed.

[Off]

CC (Closed Captioning) is not displayed.

Data Projector
VPL-PHZ60/PHZ50

Menu Operation: Background

Sets the background for when there is no input signal.

1 Press the **MENU** key.

2 Select  **[Function] - [Background] - [Blue], [Black], or [Image]**.

When set to **[Image]**, the Start Up Image is displayed.

Data Projector
VPL-PHZ60/PHZ50

Menu Operation: Start Up Image

Set whether the startup image is displayed during startup.

1 Press the **MENU** key.

2 Select  **[Function] - [Start Up Image] - [On] or [Off]**.

Selecting **[On]** will enable the startup image to be displayed during startup.

Data Projector
VPL-PHZ60/PHZ50

Menu Operation: All Reset

All settings are initialized to their factory preset values.

1 Press the **MENU** key.

2 Select  **[Function] - [All Reset]**.

When the [Do you wish to reset the settings to default values?] message is displayed, select [Yes].

Data Projector
VPL-PHZ60/PHZ50

Menu Operation: Language

Set the language used in the menu, messages, and so on.

- 1 Press the **MENU** key.
- 2 Select  **[Operation] - [Language] - The desired language.**

Related Topic

- [Selecting the Menu Language](#)

Data Projector
VPL-PHZ60/PHZ50

Menu Operation: Menu Position

For selecting the position of the menu displayed on the projected image.

- 1 Press the **MENU** key.
- 2 Select  **[Operation] - [Menu Position] - [Bottom Left] or [Center].**

Data Projector
VPL-PHZ60/PHZ50

Menu Operation: Status

Set whether the menu, messages, and so on are displayed.

- 1 Press the **MENU** key.
- 2 Select  **[Operation] - [Status] - [On] or [Off]**.

Settings

[On]

All screen displays become active.

[Off]

All screens except for the menu display, warning messages, notifications, and so on will not be displayed.

Data Projector
VPL-PHZ60/PHZ50

Menu Operation: IR Receiver

Selects the remote control receivers (IR Receiver) on the front and rear of the projector.

- 1 Press the MENU key.
- 2 Select  [Operation] - [IR Receiver] - [Front & Rear], [Front], or [Rear].

Menu Operation: Security Lock

Allows you to set a password and restrict users.

- 1 Press the MENU key.
- 2 Select  [Operation] - [Security Lock] - [On] and press the ENTER key.
- 3 Enter the set password.

Turning Off Security Lock

Selecting [Off] allows you to turn off Security Lock. This also requires the password to be entered.

Note

- If the password is entered incorrectly three times in a row, further operation is not allowed. In this case, press the  (On/Standby) key to put the projector on Standby, then turn the device on again.
- If you forget the password, you will be unable to use the projector, so exercise due caution. If you contact qualified Sony personnel, you can receive the password. This will require the projector's serial number and confirmation of the customer's information. (The confirmation method differs by country/region.)

Related Topic

- [Menu Operation: Set Password](#)

Data Projector
VPL-PHZ60/PHZ50

Menu Operation: Control Key Lock

Allows operation via the control panel to be deactivated.

- 1 Press the MENU key.
- 2 Select  [Operation] - [Control Key Lock] - [On] or [Off].
Selecting [On] deactivates operation via the control panel.

Operations Possible During Operation Lockout

The following operations are possible even when [Control Key Lock] is [On].

- **In Standby Mode, press and hold the  (On/Standby) key for approximately 10 seconds.**
The power will turn on.
- **With the power on, press and hold the MENU key for approximately 10 seconds.**
[Control Key Lock] will turn [Off], and the control panel will become operational.

Related Topic

- [Parts and Controls \(Remote Commander and Control Panel\)](#)

Data Projector
VPL-PHZ60/PHZ50

Menu Operation: Menu Settings Lock

Lock the menu settings.

- 1 Press the **MENU** key.
- 2 Select  [Operation] - [Menu Settings Lock] - The desired setting.

Settings

[Full]

Lock all menu settings.

[Startup]

Lock the settings when the projector is turned on. Settings can be changed while the projector is in use, but once the power is turned off, they will return to the originally locked settings.

[Update]

Selecting [Update] when [Startup] has been selected saves the changed settings and keeps them the same.

Note

- When performing [Menu Settings Lock] operations, the password must be entered. Set the password in [Set Password] in the  [Operation] menu.









Related Topic

- [Menu Operation: Set Password](#)

Data Projector
VPL-PHZ60/PHZ50

Menu Operation: Set Password

Set the password for the [Security Lock] and [Menu Settings Lock] operations.

- 1 Press the MENU key.
- 2 Select  [Operation] - [Set Password].
- 3 Use the MENU,  /  /  /  (Up/Down/Left/Right), and ENTER keys to enter the password.
The default factory setting password is "ENTER, ENTER, ENTER, ENTER."
- 4 Use the MENU,  /  /  /  (Up/Down/Left/Right), and ENTER keys to enter your new password.
- 5 Enter the new password again for confirmation.

Related Topic

- [Menu Operation: Security Lock](#)
- [Menu Operation: Menu Settings Lock](#)

Data Projector
VPL-PHZ60/PHZ50

Menu Operation: Network Setting

Set the network IP address.

- 1 Press the **MENU** key.
- 2 Select  **[Connection/Power] - [Network Setting] - [IP Address Setup] - The desired setting.**

Settings

[Auto(DHCP)]

Network settings are automatically assigned via the router or another device's DHCP server function.

[Manual]

Configure the network manually.

Note

- When setting the IP address manually, enter the IP address after changing the IP address setting to [Manual].

Data Projector
VPL-PHZ60/PHZ50

Menu Operation: Communication Mode

Configure the communication mode.

- 1 Press the MENU key.
- 2 Select  [Connection/Power] - [Network Setting] - [Communication Mode] - The desired setting.

Settings

[http]

Communicate with http only.

[http and https]

Communicate with both http and https.

[https]

Communicate with https only.

Related Topic

- [Configuring https Communication](#)

Data Projector
VPL-PHZ60/PHZ50

Menu Operation: HDBaseT Settings

Configure a connection to an HDBaseT device.

- 1 Press the MENU key.
- 2 Select  [Connection/Power] - [Network Setting] - [HDBaseT Settings] - The desired setting.

Settings

[LAN Setting]

[via HDBaseT]/[LAN Port]: You can select either via the LAN of the HDBaseT device connected to the HDBaseT terminal or via the network connection with the LAN terminal of the main unit.

[RS-232C Setting]

- [via HDBaseT]: You can connect this unit to the RS-232C terminal via the HDBaseT transmitter. (Baud rate: 9,600 bps)
- [RS-232C]: Use when connecting to the RS-232C terminal of this unit directly. (Baud rate: 38,400 bps)

[Extron XTP]

[On]/[Off]: Set to [On] when connecting the HDBaseT terminal of this unit to XTP Systems manufactured by Extron Electronics. Set to [Off] when connecting to other equipment.

Note

- When connecting via HDBaseT, only the 100BASE-TX can be used for connection. When using the LAN terminal of the main unit, you can connect with the 10BASE-T/100BASE-TX/1000BASE-T.
- The IP addresses when using HDBaseT and when using the LAN terminal should be set respectively.
 - Setting the IP address when using a LAN via HDBaseT.
Set [LAN Setting] to [via HDBaseT] in [HDBaseT Settings], then set the IP address in [Network Setting].
 - Setting the IP address when using the LAN terminal.
Set [LAN Setting] to [LAN Port] in [HDBaseT Settings], then set the IP address in [Network Setting].
- For details on XTP Systems, refer to the product catalog or brochure from Extron Electronics.

Related Topic

- [Connecting to an HDBaseT™ Device](#)

Data Projector
VPL-PHZ60/PHZ50

Menu Operation: Dynamic Range

Set the image input level for the INPUT B/INPUT C terminal.

- 1 Press the **MENU** key.
- 2 Select  **[Connection/Power] - [Dynamic Range] - The desired setting.**

Settings

[Auto]

Identify the image input level automatically.

[Limited]

Set when the image input level is between 16 and 235.

[Full]

Set when the image input level is between 0 and 255.

Note

- If the image output settings for the HDMI connection device are not correct, the bright sections and dark sections of the image may become too bright or dark, respectively.

Data Projector
VPL-PHZ60/PHZ50

Menu Operation: Input-A Signal Sel.

Set the image signal type for when Input A is selected.

- 1 Press the **MENU** key.
- 2 Select  **[Connection/Power] - [Input-A Signal Sel.] - The desired setting.**

Settings

[Auto]

Automatically choose the image signal type for when Input A is selected.

[Computer]/[Video GBR]/[Component]

The selected image signal type will be applied.

Note

- Even if [Auto] is set, the image may not be optimized depending on the input. If this occurs, configure manually in accordance with the connected device.

Menu Operation: ECO

- 1 Press the MENU key.
- 2 Select  [Connection/Power] - [ECO] - [Auto Power Saving] - The desired setting.

Settings

[With No Input]

[Light Cutoff]: If there is no signal input for approximately 2 minutes, the light will automatically turn off and the power consumption will be reduced. Inputting a signal or operating a key will turn the light back on. When the light is off, the ON/STANDBY indicator will be orange.

[Standby]: If there is no signal input for approximately 2 minutes, the projector will automatically go into Standby Mode.

[Off]: Disable the With No Input setting function.

[With Static Signal]

[Light Dimming]: If there has been no change to the image being input into the projector (approximately 10 seconds), the light mode settings will gradually reduce the light output (by approximately 10% - 15%). In addition, if there is no change detected in the input signal for an optionally set period of time ([5 min.]/[10 min.]/[15 min.]/[20 min.]/[Demo.]), the light output will be automatically reduced to approximately 5%. While the light output is being reduced, the [Light Dimming] message will be displayed. If [Demo.] is selected, the light will begin dimming after approximately 40 seconds. When a signal change, Remote Commander operation, or control panel operation is detected, it will revert to the original brightness.

[Off]: Disable the With Static Signal setting function.

Note

- If you do not want the projector to automatically enter Standby Mode when there is no input signal, set [With No Input] to [Off].
- Light reduction works gradually over time, so you may not notice that it is being reduced. For this reason, when the input signal changes and the light returns to its original brightness, you may notice that the light was reduced.
- The light output reduction amount differs depending on the [Light Output Mode] setting in the  [Projection Setting] menu.

Related Topic

- [Menu Operation: Light Settings](#)

Menu Operation: Standby Mode

Set the power consumption during Standby Mode.

- 1 Press the MENU key.
- 2 Select  [Connection/Power] - [ECO] - [Standby Mode] - [Standard] or [Low].
Selecting [Standard] will increase the power consumption during Standby Mode.

Note

- If Standby Mode is [Low], you will no longer be able to use networks and network control functions while in Standby Mode.

Hint

- Setting [Remote Start] to [On] will turn the projector on by sending special commands even when [Standby Mode] is set to [Low].

Data Projector
VPL-PHZ60/PHZ50

Menu Operation: Remote Start

Configure Remote Start. Setting [Remote Start] to [On] will turn on the projector by sending special commands even when [Standby Mode] is set to [Low].

1 Press the MENU key.

2 Select  [Connection/Power] - [ECO] - [Remote Start] - [On] or [Off].

Selecting [On] will allow you to supply power from the computer and so on to the projector when in a network-connected environment.

Note

- It is necessary to configure the network settings correctly and connect the projector to the network in advance.
- When supplying power to the projector using the Remote Start function, it is necessary to send special commands from the computer. Consult with qualified Sony personnel for details.
- Setting [Remote Start] to [On] will increase standby power consumption during Standby Mode.

Related Topic

- [Menu Operation: Network Setting](#)

Menu Operation: Direct Power On

Set whether power is set to On or Standby when plugging the AC power cord into an outlet.

1 Press the MENU key.

2 Select  [Connection/Power] - [Direct Power On] - [On] or [Off].

When [On] is selected, the projector is turned on and does not go into Standby Mode when the AC power cord is plugged into an outlet.

Hint

- When the power is turned off, you can disconnect the AC power cord without going into Standby Mode regardless of the [Direct Power On] settings.

Related Topic

- [Turning Power On/Off](#)

Data Projector
VPL-PHZ60/PHZ50

Menu Operation: Screen Fitting

Select the image distortion correction method.

1 Press the MENU key.

2 Select  [Installation] - [Screen Fitting] - [HV Keystone] or [Corner Keystone].

When you wish to use trapezoidal correction, select [HV Keystone], and when you wish to correct distortion, select [Corner Keystone].

Related Topic

- [Menu Operation: V Keystone](#)
- [Menu Operation: H Keystone](#)
- [Menu Operation: Corner Keystone](#)

Data Projector
VPL-PHZ60/PHZ50

Menu Operation: V Keystone

Adjust the projected image to a screen that has a vertical trapezoidal shape.
This is displayed when [HV Keystone] is selected for [Screen Fitting] in the  [Installation] menu.

1 Press the MENU key.

2 Select  [Installation] - [V Keystone].

3 Adjust the value with the  /  /  /  (Up/Down/Left/Right) keys.

Increasing the value in the positive direction makes the upper side screen width smaller, and increasing it in the negative direction makes the lower side screen width smaller.

Note

- Because keystone correction is an electronic form of correction, the image quality may be reduced.

Related Topic

- [Correcting a Vertical Trapezoid](#)
- [Menu Operation: Screen Fitting](#)

Data Projector
VPL-PHZ60/PHZ50

Menu Operation: H Keystone

Adjust the projected image to a screen that has a horizontal trapezoidal shape.
This is displayed when [HV Keystone] is selected for [Screen Fitting] in the  [Installation] menu.

1 Press the MENU key.

2 Select  [Installation] - [H Keystone].

3 Adjust the value with the  /  /  /  (Up/Down/Left/Right) keys.

Increasing the value in the positive direction makes the right side of the screen smaller, and increasing it in the negative direction makes the left side of the screen smaller.

Note

- Because keystone correction is an electronic form of correction, the image quality may be reduced.









Related Topic

- [Correcting a Horizontal Trapezoid](#)
- [Menu Operation: Screen Fitting](#)

Menu Operation: Corner Keystone

Corrects distortion of the image.

This is displayed when [Corner Keystone] is selected for [Screen Fitting] in the  [Installation] menu.

- 1 Press the MENU key.
- 2 Select  [Installation] - [Corner Keystone] - [Adjust].
- 3 Select the corner you wish to correct using the  /  /  /  (Up/Down/Left/Right) keys and press the ENTER key.
- 4 Adjust the corner position with the  /  /  /  (Up/Down/Left/Right) keys.

Selecting [Reset] resets the adjusted value and returns the image to an unadjusted state.

Note

- Because keystone correction is an electronic form of correction, the image quality may be reduced.

Related Topic

- [Correcting Screen Distortion](#)
- [Menu Operation: Screen Fitting](#)

Data Projector
VPL-PHZ60/PHZ50

Menu Operation: Digital Shrink

Allows you to shrink the projected image or adjust its position.

- 1 Press the **MENU** key.
- 2 Select  [Installation] - [Digital Shrink] - The desired setting.

Settings

[Digital Shrink]

Adjust the size of the projected image. Setting the value to "0" will leave the image in its original size. The shrinkage rate is 100% - 90%.

[Shift]

Adjust the projection position. The adjustable range changes depending on the shrinkage rate.

Note

- Because digital shrinkage is an electronic form of correction, the image quality may be reduced.
- While adjusting the digital shrinkage, pressing the ENTER key will take you to a shift adjustment menu.

Data Projector
VPL-PHZ60/PHZ50

Menu Operation: Image Flip

The image flips either horizontally or vertically depending on the installation method.

- 1 Press the **MENU** key.
- 2 Select  [Installation] - [Image Flip] - The desired setting.

Settings

[HV]

Flip the image horizontally and vertically.

[H]

Flip the image horizontally.

[V]

Flip the image vertically.

[Off]

Project the image without flipping it.

Data Projector
VPL-PHZ60/PHZ50

Menu Operation: High Altitude Mode

Set in accordance to the air pressure at the installation location.

- 1 Press the MENU key.
- 2 Select  [Installation] - [High Altitude Mode] - The desired setting.

Settings

[Level2]

Select when using the projector in a location at an altitude of 1,800 m (approx. 5,900 ft) or higher.

[Level1]

Select when using the projector in a location at an altitude from 1,000 m (approx. 3,280 ft) to 1,800 m (approx. 5,900 ft).

[Off]

Select when using the projector on level ground.

Note

- Using the projector with improper settings may affect the reliability of the components.

Data Projector
VPL-PHZ60/PHZ50

Menu Operation: Panel Alignment

This feature allows you to adjust the gaps in the color of characters or the picture. When set to [On], [Adjust Color] and [Pattern Color] can be assigned and adjusted.

- 1 Press the MENU key.
- 2 Select  [Installation] - [Panel Alignment] - The desired setting.

Settings

[Adjust Item]

Selects how to make adjustments from below.

- [Shift]: Shifts the whole picture and makes adjustments.
- [Zone]: Selects the desired range and makes adjustments.





[Adjust Color]

Assigns the desired color to adjust the gaps in color. Select [R] (Red) or [B] (Blue) to make adjustments based on "G" (Green).

[Pattern Color]

Select [R/G] (Red and Green) or [R/G/B] (White, all colors) when [Adjust Color] is [R] (Red). Select [B/G] (Blue and Green) or [R/G/B] (White, all colors) when the [Adjust Color] is [B] (Blue).

[Adjust]

The shift adjustment and zone adjustment of the color selected in [Adjust Color] can be made with  /  /  /  (Up/Down/Left/Right) keys.

[Reset]

The panel alignment settings are initialized to their factory preset values.

Note

- Depending on the adjustment value of [Panel Alignment], the color and resolution may be changed.

Data Projector
VPL-PHZ60/PHZ50

Viewing the Projector Information

View the projector model name, serial number, input signal type, light usage time, and other information.

- 1 Press the **MENU** key.
- 2 Select **i** [Information].

Items that Can be Viewed

[Model Name]

Displays the model name.

[Serial No.]

Displays the serial number.

[fH / fV]

Displays the horizontal/vertical frequency and signal type (resolution) of the current input signal.

[Light Timer]

Displays the light usage time thus far.

Note

- The horizontal/vertical frequency may not be displayed properly due to the input signal.

Uses for Network Features

Connecting a projector to a network allows you to do the following.

Use the projector with only necessary functions enabled.

- Confirm the current projector state using a web browser.
- Operate the projector remotely using a web browser.
- Receive a report from the projector via e-mail.
- Configure network settings for the projector.
- Perform control using various types of network surveillance and control protocol (Advertisement, ADCP, PJ Talk, PJ Link, SNMP, AMX DDDP (Dynamic Device Discovery Protocol), Crestron RoomView).
- Reset the network settings.
- Set the date and time.
- Update the software.
- Use https communication.

Note

- When connecting the projector to a network, consult the network administrator. Also, use a network environment with security measures in place.
- When using the projector upon connecting it to a network, open the projector's control panel via a network and change the factory settings of the access control settings. We also recommend that you change your password periodically.
- Once you have finished configuration via the browser, close the browser to log out.
- Please note that the images used in the explanation are for reference only. Some images may differ depending on what model you are using.
- Supported web browsers are Internet Explorer (version 11 or later), Safari, and Chrome.
- The only display language available is English.
- When accessing the projector from a computer, if the browser is set to "use a proxy server," click the checkmark and configure it to not use a proxy server.

Related Topic

- [Operating the Control Panel](#)
- [Using the E-mail Report Function](#)
- [Configuring the Network Settings of the Projector](#)
- [Resetting the Network Settings](#)
- [Setting the Date and Time](#)
- [Using the Software Update Function](#)
- [Configuring https Communication](#)

Data Projector
VPL-PHZ60/PHZ50

Displaying the Control Window of the Projector with a Web Browser

Display the control window of the projector with a web browser and configure the network settings.

- 1 Connect the projector and computer to a hub or router using LAN cables.
- 2 Press the **MENU** key and configure the projector's network settings from  [Connection/Power] - [Network Setting].
- 3 Start the web browser, enter the following into the address field, and press the Enter key.

http://xxx.xxx.xxx.xxx

(xxx.xxx.xxx.xxx: IP address of the projector)

The IP address of the projector can be confirmed from [Network Setting] in the  [Connection/Power] menu.

The control panel will be displayed in the browser.



Hint

- Once the network settings have been configured, the control panel can be displayed thereafter via the operation in Step 3 alone.
- For https communication, connect with http first, then configure https communication.

Related Topic

- [Connecting to a Computer via a Hub or Router](#)
- [Menu Operation: Network Setting](#)
- [Configuring https Communication](#)

Data Projector
VPL-PHZ60/PHZ50

Operating the Control Panel

From the control panel displayed in your browser, you can configure access privileges and confirm the projector state.

Switching Pages

Click the page toggle tab (A) to display the page you wish to configure.
When the tab of the target page is not displayed, scroll the bar under the tab to display it.

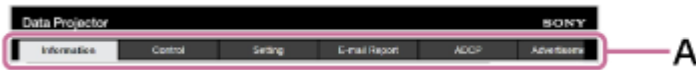

Administrator privileges will be required to access to the pages other than Information and Control.

Setting the Password

Upon clicking [Setting] in the page toggle tab, a login window will be displayed.

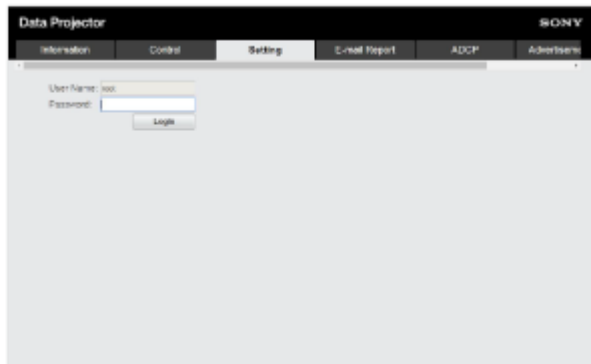

When accessing the [Setting] page for the first time, enter the User Name “root” and the Password “Projector.”
When logging in for the first time, a window prompting you to change your password will be displayed. Follow the instructions displayed and change your password.

Set Password

This is the first access to this page.
Please change the administrator's password to continue

New Password:

Confirm:

The initial password “Projector” cannot be set as the new password.
To change the password, set [Password] in the [Setting] page.

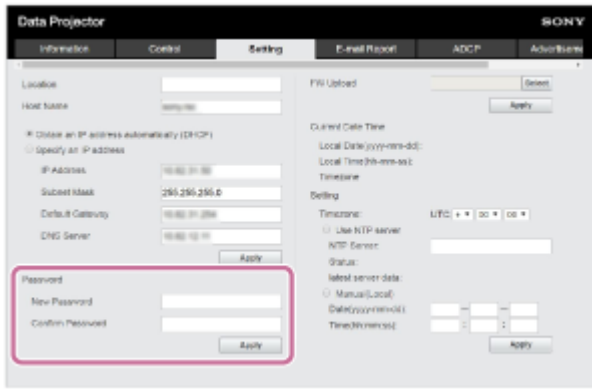

To enable the new password, enter the new password, then click [Apply].

Note

- If you forget your password, contact qualified Sony personnel. Your password will be reconfigured once your approval has been obtained.

Confirming the Projector State

Clicking the [Information] page toggle tab and opening the [Information] page allows you to confirm the projector's current state.



Operating the Projector

Clicking the [Control] page toggle tab and opening the [Control] page allows you to operate the projector.



The button functions are the same as those of the keys on the Remote Commander.

Using the E-mail Report Function

Configure the e-mail report function from the [E-mail Report] page.

Note

- The entered value will not be applied until [Apply] is clicked.

- 1 Click the [E-mail Report] tab and display the [E-mail Report] page.

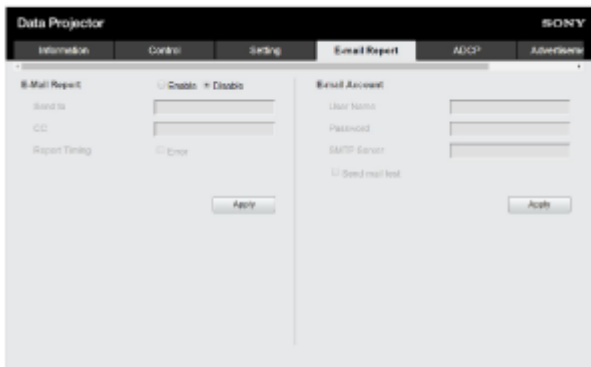

- 2 Select [Enable] in [E-mail Report].
- 3 Configure [Send to] and [CC].
- 4 Configure the [Report Timing] items.
- 5 Click [Apply].
- 6 Configure the [E-mail Account] items.
- 7 Check [Send mail test] and click [Apply].

A test e-mail will be sent to the set destination address.

Settings

[Send to], [CC]

Enter the destination e-mail address.

[Report Timing]

- [Over Light usage time]: Send a report when the light usage time elapses the specified time. [Error]: Send a report when the projector detects an error.

[E-mail Account]

- [User Name]: Enter the e-mail address.
- [SMTP Server]: Enter the transmission e-mail server (SMTP) address.

Note

- For networks performing Outbound Port25 Blocking, the e-mail report function cannot be used because the SMTP server cannot be connected to.
- You cannot enter the following characters in the text box: ‘ “ \ & < >

Configuring the Network Settings of the Projector

Configure the network functions from the [Setting] page.

Note

- The entered value will not be applied until [Apply] is clicked.

1 Click the [Setting] tab and display the [Setting] page.

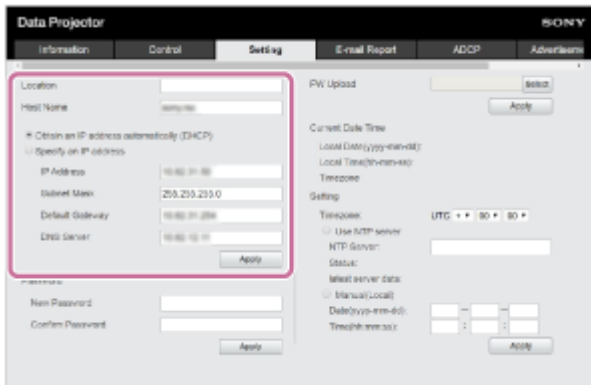

2 Configure [Location].

3 Configure [Host Name].

This host name must be the same as the Common Name (common name) of the certificate used when accessing via https communication. For details, refer to “[Configuring https Communication.](#)”

4 Configure [Obtain an IP address automatically (DHCP)] or [Specify an IP address].

5 Click [Apply].

Settings

[Obtain an IP address automatically (DHCP)]

Network settings are automatically assigned via the router or other device's DHCP server function. The values allocated by the DHCP server are displayed in [IP Address], [Subnet Mask], [Default Gateway], and [DNS Server].

[Specify an IP address]

Configure the network manually.

- [IP Address]: Enter the IP address of the projector.
- [Subnet Mask]: Enter the subnet mask of the projector.
- [Default Gateway]: Enter the default gateway of the projector.
- [DNS Server]: Enter the primary DNS server of the projector.

Related Topic

- [Configuring https Communication](#)

5-025-459-11(1) Copyright 2020 Sony Corporation

Setting Advertisement

Change the Advertisement control protocol settings from the [Advertisement / PJ Link / PJ Talk] page.

Note

- The entered value will not be applied until [Apply] is clicked.

- 1 Click the [Advertisement / PJ Link / PJ Talk] tab and display the [Advertisement / PJ Link / PJ Talk] page.

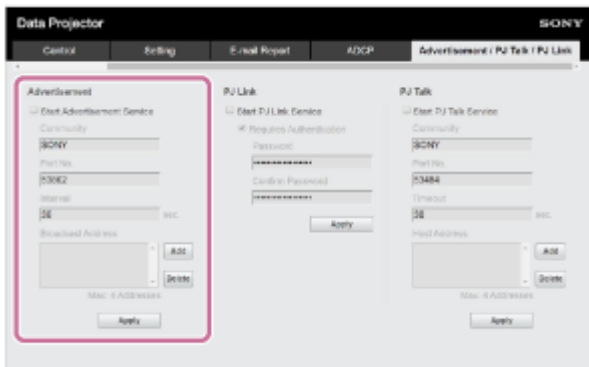

- 2 Configure each item under [Advertisement] and click [Apply].

Settings

[Start Advertisement Service]

Turn Advertisement on or off. The settings related to Advertisement are applied only if it is on. It is off in the default factory setting.

- [Community]: Enter the community names for Advertisement and PJ Talk. If changed, the PJ Talk community name changes as well. Only entries consisting of four alphanumeric characters are allowed. The default factory setting community name is "SONY." To avoid unauthorized access to the projector from another computer, we recommend changing the community name from the one in the factory setting.
- [Port No.]: Enter the Advertisement transmission port. The default factory setting Advertisement transmission port is "53862."
- [Interval]: Enter the Advertisement transmission interval (seconds). The Advertisement transmission interval in the default factory setting Advertisement transmission port is "30."
- [Broadcast Address]: Enter the Advertisement data transmission recipient. If nothing is entered, it will be broadcast on the same subnet.

Setting PJ Link

Change the PJ Link control protocol settings from the [Advertisement / PJ Link / PJ Talk] page.

Note

- The entered value will not be applied until [Apply] is clicked.

- 1 Click the [Advertisement / PJ Link / PJ Talk] tab and display the [Advertisement / PJ Link / PJ Talk] page.

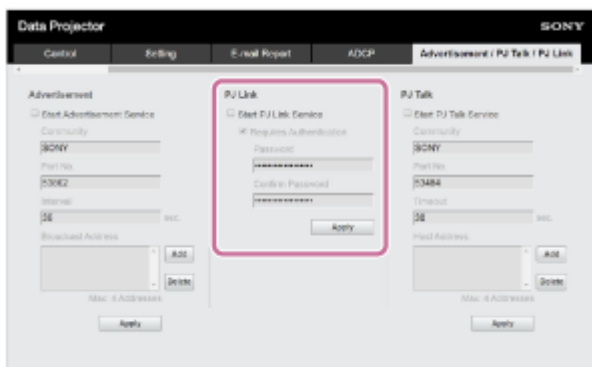

- 2 Configure each item under [PJ Link] and click [Apply].

Settings

[Start PJ Link Service]

Turn the PJ Link function on or off. The settings related to PJ Link are applied only if it is on. The function in the default factory setting is off.

- [Requires Authentication]: Turn the PJ Link authentication function on or off.
- [Password]: Enter the PJ Link authentication password. Refer to the PJ Link specifications for the default password.

Setting PJ Talk

Change the PJ Talk control protocol settings from the [Advertisement / PJ Link / PJ Talk] page.

Note

- The entered value will not be applied until [Apply] is clicked.

- 1 Click the [Advertisement / PJ Link / PJ Talk] tab and display the [Advertisement / PJ Link / PJ Talk] page.

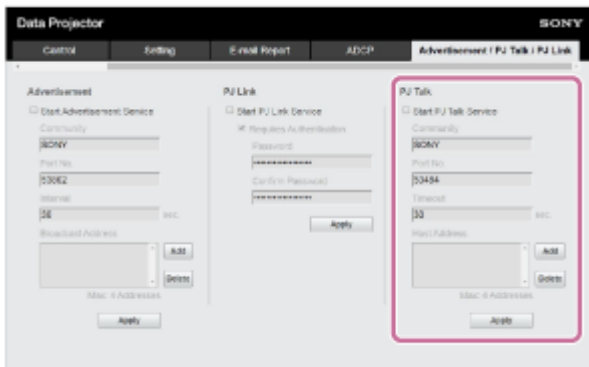

- 2 Configure each item under [PJ Talk] and click [Apply].

Settings

[Start PJ Talk Service]

Turn the PJ Talk setting on or off. The settings related to PJ Talk are applied only if it is on. The default factory setting function is off.

- [Community]: Enter the community names for Advertisement and PJ Talk. If changed, the Advertisement community name changes as well. Only entries consisting of four alphanumeric characters are allowed. The community name in the default factory setting is “SONY.” To avoid unauthorized access to the projector from another computer, we recommend changing the community name from the one used in the factory setting.
- [Port No.]: Enter the PJ Talk server port. The default factory setting PJ Talk server port is “53484.”
- [Timeout]: Enter the time (in seconds) until the connection is cut when PJ Talk communication is interrupted. The time in the default factory setting is “30.”
- [Host Address]: Enter the IP address allowed to be received by the PJ Talk server. If nothing is entered, commands can be received from any IP address. Once an IP address has been entered, access will only be allowed from the entered IP address. For security purposes, we recommend entering an IP address and restricting access.

Setting ADCP

Change the ADCP control protocol settings from the [ADCP] page.

Note

- The entered value will not be applied until [Apply] is clicked.

- 1 Click the [ADCP] tab and display the [ADCP] page.

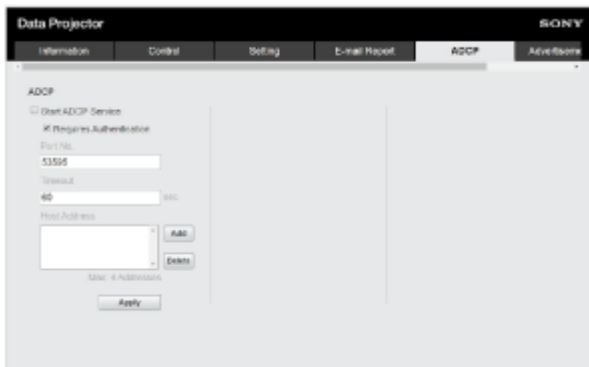

- 2 Configure each item and click [Apply].

Settings

[Start ADCP Service]

Turn ADCP on or off. The settings related to ADCP are applied only if it is on. It is off in the default factory setting.

- [Requires Authentication]: Turn the ADCP authentication function on or off. The web page administrator password is set for the password.
- [Port No.]: Enter the ADCP server port. The default factory setting ADCP server port is "53595."
- [Timeout]: Enter the time (in seconds) until the connection is cut when ADCP communication is interrupted. The time in the default factory setting is "60."
- [Host Address]: Enter the IP address allowed to be received by the ADCP server. If nothing is entered, commands can be received from any IP address. Once an IP address has been entered, access will only be allowed from the entered IP address. For security purposes, we recommend entering an IP address and restricting access.

Setting AMX DDDP/Crestron Room View

Set the system service functions from the [DDDP/Crestron Control] page.

Note

- The entered value will not be applied until [Apply] is clicked.

- 1 Click the [DDDP/Crestron Control] tab and display the [DDDP/Crestron Control] page.



- 2 Configure each item and click [Apply].

Settings

[DDDP]

[Start DDDP Service]: Turn the DDDP function on or off. For details, refer to the AMX Corporation DDDP protocol specifications. The default factory setting is off.

[Crestron Control]

[Start Crestron Service]: Turn the Crestron Control function on or off. For details, refer to the Crestron Corporation product catalog and so on.

- [IP Address]: Enter the Crestron system server.
- [IP ID]: Enter the CIP protocol IP ID.
- [Port No.]: Enter the CIP protocol server port number.

Data Projector
VPL-PHZ60/PHZ50

Resetting the Network Settings

Return all items that can be configured via a web browser to their factory settings.

- 1 Click the **[Reset]** tab and display the **[Reset]** page.

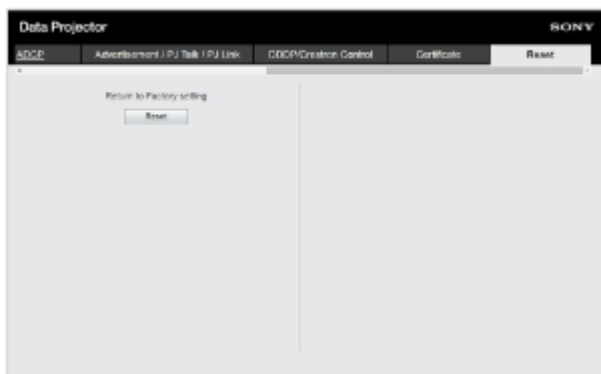

- 2 Click **[Reset]**.

Setting the Date and Time

Set the date and time.

The time can be set from either [Use NTP server] or [Manual(Local)].

- 1 Click the [Setting] tab and display the [Setting] page.

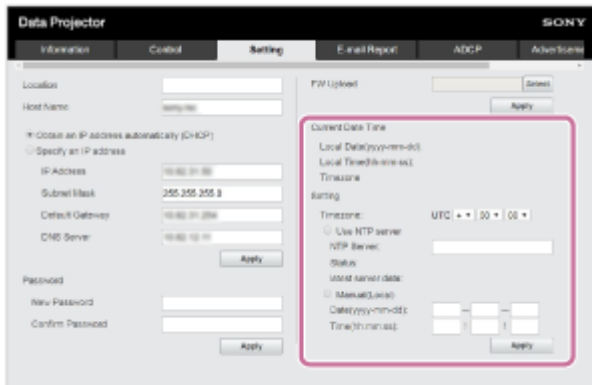

- 2 Configure each item under the Date and Time and click [Apply].

Settings

[Current Date Time]

The currently set time will be displayed in the local time zone.

[Setting]

Enter the following items and set the date and time.

- [Timezone]: Set the time zone. Daylight Savings Time is not supported.
- [Use NTP server]: Select this if you are retrieving the time via a network (NTP server).
 - [NTP Server]: Enter the NTP server.
 - [Status]: Displays the status of the connection to the NTP server.
 - [latest server data]: Displays the information most recently obtained from the NTP server.
- [Manual(Local)]: Select this if you will set the date and time manually.
 - [Date(yyyy-mm-dd)]: Enter the date.
 - [Time(hh:mm:ss)]: Enter the time.

Using the Software Update Function

The projector software can be updated via a network.
The update file can be downloaded from the Sony website.

Note

- The projector software can be updated via a network only when the projector is in Standby Mode.

- 1 Click the [Setting] tab and display the [Setting] page.

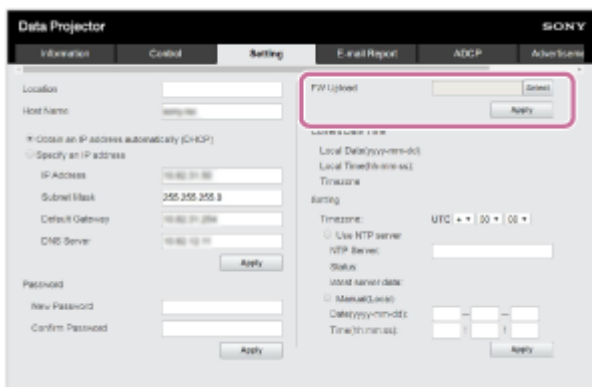

- 2 Click [Select] in [FW Upload] to select the file to be updated, then click [Apply].

Update preparation starts. A message will be displayed after preparation is complete.

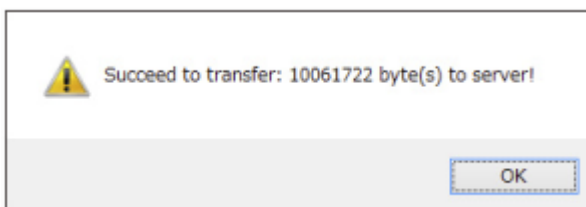

- 3 Click [OK].

An update confirmation message will be displayed.

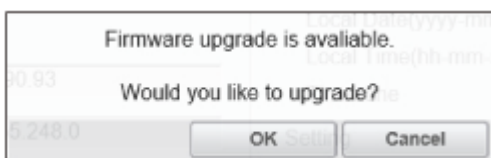

- 4 Click [OK].

Update starts.
The [Setting] page will be displayed again after update is complete.

Related Topic

- [Updating Software](#)

5-025-459-11(1) Copyright 2020 Sony Corporation

Configuring https Communication

Configure https communication on the [Certificate] page.

- 1 Click the [Certificate] tab and display the [Certificate] page.



- 2 Select [Communication Mode].

- [Http]: http connection only.
- [Http and Https]: https and http connection can be used at the same time.
- [Https]: https connection only.

Select [Https] for https connection. However, follow the steps in “[Connecting with https for the First Time](#)” to set up https connection for the first time.

The encryption protocol supported by the projector is TLS 1.2. In addition, the port number is set to 443.

- 3 Set a certificate.

- [Upload Trusted CA Certificate]: The certificate issued by a CA will be installed. Select a certificate saved in a folder on your computer. Click [Apply] to install it.

Supported certificate

- Format: PEM
- Extension: CRT, PEM
- Encryption: RSA
- Hash: SHA-256/SHA-384
- Key length: 512/1024/2048/4096 bit
- Common Name: Network host name
For Common Name, use the host name set under [Host Name] on the [Setting] page.
- Organization: Define by customer

- [Generate self issued certificate (for test only)]: The certificate generated within the projector (self-generating certificate) will be installed. Click [Apply] to install it.

You can use either the certificate issued by a CA or the certificate generated within the projector (self-generating certificate).

The installed certificate will be displayed in [Certificate information].

- [Status: OK]: When the certificate issued by a CA is installed and it is within the certification period.
- [Status: Expire]: When the certificate issued by a CA is installed but is past its expiration date.
- [Status: (blank)]: When a self-generating certificate is installed.

When Using the https Function

Use the host name set under [Host Name] on the [Setting] page to access the projector. Registration of the projector host name to the DNS server may be required depending on the operating environment. When accessing the projector with a different host name, such as the projector's IP address, a warning window may be displayed. In this case, continue with the procedure by referring to the instructions on the screen.

Example of the Screen for Internet Explorer (When the OS is Set to English)

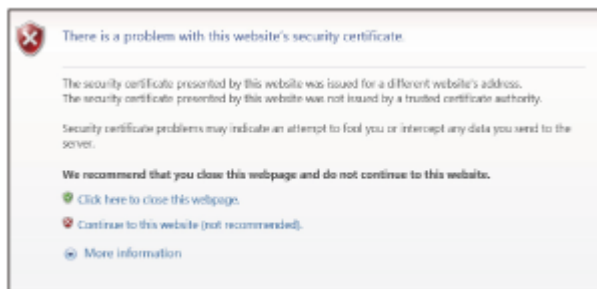

Note

- When using a self-generating certificate, proof of existence, which is one type of https communication, cannot be used for the following reasons.
 - The secret key generated by the projector is self-signed.
 - A value decided in advance is entered for the Distinguished Name (Common Name, etc.).
 - A certificate has not been issued by a CA trusted by the user's system.

For security purposes, we recommend using a self-generating certificate in the case complete security, such as operation tests, is not necessary.

- The last certificate becomes effective.
- When using a self-generating certificate, [Security Warning] may be displayed when using a browser and connecting with https. In this case, continue with the procedure by referring to the instructions on the screen.
- https connections may not be possible depending on the certificate installed in the projector. In this case, install a CA certificate to your computer. For details, refer to "[Installing a CA Certificate to Your Computer.](#)"
- Models sold in China do not include https functionality.
- If using the https function, be sure to adjust the projector date and time before configuration. If the date and time are not accurate, you may not be able to connect via a browser.

Related Topic

- [Menu Operation: Communication Mode](#)
- [Configuring the Network Settings of the Projector](#)
- [Connecting with https for the First Time](#)
- [Installing a CA Certificate to Your Computer](#)

Connecting with https for the First Time

If the https function works improperly when connecting only with https by setting [Communication Mode] to [Https], the computer cannot access the projector. To avoid this, confirm if the https connection is possible through the following steps.

- 1 Click [Certificate] and display the [Certificate] page.**
- 2 Set [Communication Mode] to [Http and Https].**
- 3 Install a certificate.**
For installing a certificate, please refer to “Set a certificate” in “[Configuring https Communication.](#)”
- 4 Close the web browser.**
- 5 Start the web browser to display the projector setting window with https connection.**
For the connection method, please refer to “When Using the https Function” in “[Configuring https Communication.](#)”
- 6 Confirm that the https connection is possible, and then set [Communication Mode] to [Https].**

If the setting window or web browser is closed due to https connection failure during confirmation, http connection is still possible as [Http and Https] is selected. Confirm the certificate setting with the http connection, and then confirm if the https connection becomes possible again.

Note

- When [Https] is selected in [Communication Mode] on the [Certificate] page, the computer cannot access the projector if the https connection fails. In this case, press the MENU button on the projector or Remote Commander to display the menu screen, and then select [Connection/Power] - [Network Setting] - [Communication Mode] - [http] to change the communication mode.

Related Topic

- [Configuring https Communication](#)

Data Projector
VPL-PHZ60/PHZ50

Installing a CA Certificate to Your Computer

Depending on the type of certificate installed to the projector, it may not be possible to connect to a network because the browser (Internet Explorer) does not display a dialog where you can decide whether or not to accept the certificate. In this case, follow the procedure below and install a CA certificate to your computer. (The following screens are examples when the OS is set to English.)

1 Save the signed CA certificate that is to be installed to the projector to your computer.

The standard certificate file extension is “.cer.” Double-click this file to display the certificate dialog.



2 Click [Install Certificate].

[Welcome to the Certificate Import Wizard] will be displayed.



3 Click [Next].

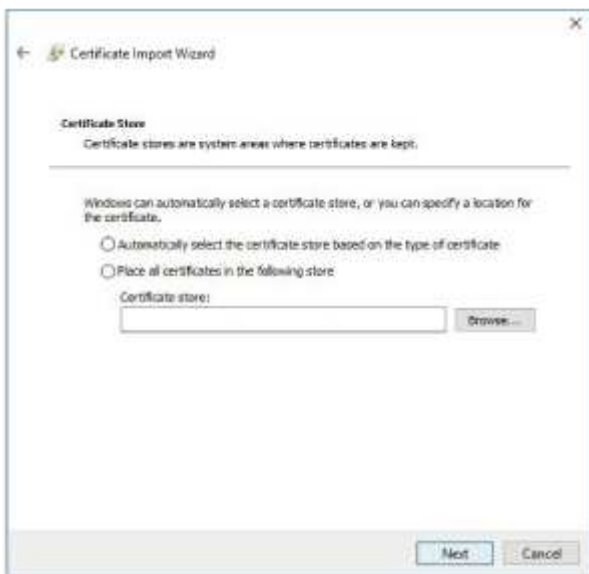

4 Select [Automatically select the certificate store based on the type of certificate] and click [Next].
[Completing the Certificate Import Wizard] will be displayed.



5

Confirm the content and click [Finish].

The CA certificate will be installed.

5-025-459-11(1) Copyright 2020 Sony Corporation

Deleting a CA Certificate Installed to Your Computer

Follow the procedure below to delete the CA certificate installed to your computer.

- 1 On Internet Explorer, select [Internet Options] from the [Tools] menu, select the [Contents] tab and [Certificate], then display the [Certificate] dialog.**

Example of the screen when the OS is set to English



- 2 Select the certificate you wish to delete.**

Normally, CA certificates are saved under [Trusted Root Certificate Authorities].

- 3 Click [Remove].**

The [Delete certificate?] confirmation dialog will appear.

- 4 Click [Yes].**

The certificate will be deleted.

Depending on the certificate type, this procedure may not be able to delete it. In this case, follow the procedure below, confirm the certificate installation status, then delete it.

Note

- Performing the following procedure requires that you log in as a user with administrator privileges.

- Open [Run] from the Windows menu, enter [mmc], then click [OK].
- On the "Console 1" screen, select [Add/Remove Snap-in] from the [File] menu.
The [Add/Remove Snap-in] dialog will appear.
- Select [Certificate] from the list and click [Add].
[Certificates snap-in] will be displayed.
- Select [Computer Account] as the certificate being managed for this snap-in and click [Next].

5. Select [Local Computer] as the computer being managed for this snap-in and click [Finish].
The item managing the [Certificate] will be displayed in the console root window. Confirm the certificate in question and delete it.

Data Projector
VPL-PHZ60/PHZ50

On Installation

- When installing the projector, leave space between any walls, etc. and the unit as illustrated.

Top view

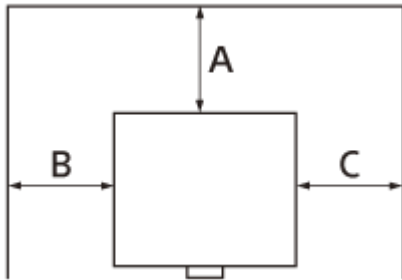

A: More than 50 cm (19 11/16 inches)

B: More than 50 cm (19 11/16 inches)

C: More than 50 cm (19 11/16 inches)

- Avoid using the projector if it is tilted more than 15 degrees horizontally.



- When the projector is installed in portrait mode, avoid using the projector if it is tilted more than 45 degrees.

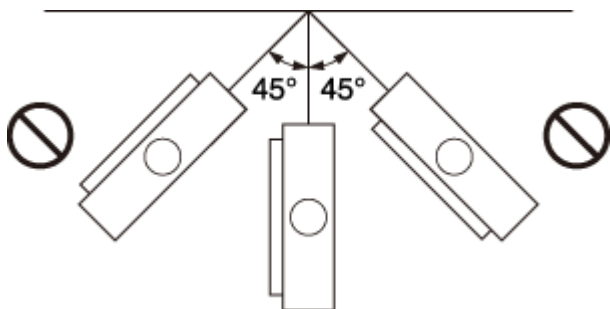

- Avoid using the projector in a location where the temperature or humidity is very high, or temperature is very low.



- Avoid installing the projector in a location subject to direct cool or warm air from an air-conditioner. Installing in such a location may cause malfunction of the projector due to moisture condensation or rise in temperature.

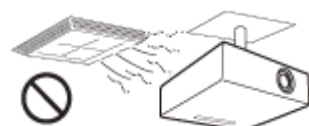

- Avoid installing the projector in a location near a heat or smoke sensor. Installing in such a location may cause malfunction of the sensor.

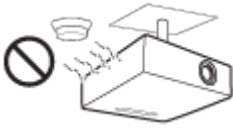

- Avoid installing the projector in a very dusty or extremely smoky environment. Otherwise, the air filter will become obstructed, and this may cause a malfunction of the projector or damage it.



- When using the unit in a location at an altitude of 1,000 m (approx. 3,280 ft) or higher, appropriately set [High Altitude Mode] in  [Installation] menu. Failing to do so could have adverse effects, such as reducing the reliability of certain components.

Related Topic

- [Menu Operation: High Altitude Mode](#)

Data Projector
VPL-PHZ60/PHZ50

Precautions for Portrait Installation

When installing the projector in portrait mode, make sure to position the projector with exhaust ventilation holes facing up, as illustrated.

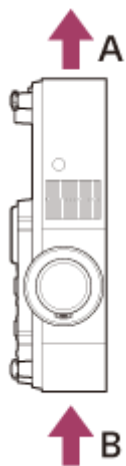

A: Ventilation holes (exhaust)

B: Ventilation holes (intake)

Related Topic

- [On Installation](#)
- [Menu Operation: High Altitude Mode](#)

Data Projector
VPL-PHZ60/PHZ50

On Cleaning the Lens and the Cabinet

- Be sure to disconnect the AC power cord from the wall outlet before cleaning.
- If you rub on the projector with a stained cloth, the cabinet may be scratched.
- If the projector is exposed to volatile materials such as insecticide, or the projector is in contact with a rubber or vinyl resin product for a long period of time, the projector may deteriorate or the coating may come off.
- Do not touch the lens with bare hands.
- On cleaning the lens surface:
Wipe the lens gently with a soft cloth, such as a glass cleaning cloth. Stubborn stains may be removed with a soft cloth lightly dampened with water. Never use solvent such as alcohol, benzene or thinner, or acid, alkaline or abrasive detergent, or a chemical cleaning cloth.
- On cleaning the cabinet:
Clean the cabinet gently with a soft cloth. Stubborn stains may be removed with a soft cloth lightly dampened with mild detergent solution and wrung, followed by wiping with a soft dry cloth. Never use solvent such as alcohol, benzene or thinner, or acid, alkaline or abrasive detergent, or a chemical cleaning cloth.

Data Projector
VPL-PHZ60/PHZ50

On Illumination

To obtain the best picture, the front of the screen should not be exposed to direct lighting or sunlight.

Data Projector
VPL-PHZ60/PHZ50

On Heat Dissipation

The temperature of the projector cabinet may increase during or immediately after use; however, this is not a malfunction.

Data Projector
VPL-PHZ60/PHZ50

On Screen

When using a screen with an uneven surface, stripes pattern may rarely appear on the screen depending on the distance between the screen and the projector or the zooming magnifications. This is not a malfunction of the projector.

Data Projector
VPL-PHZ60/PHZ50

On Fan

Since the projector is equipped with a fan inside to prevent internal temperature from rising, there may be some noise. This is a normal result of the manufacturing process and does not indicate a malfunction. If, however, in a case of abnormal noise, consult with qualified Sony personnel.

Data Projector
VPL-PHZ60/PHZ50

On Inspection of Light Source Related Parts

Since the projector uses a laser, when performing maintenance or inspection of light source related parts, particular attention and a safe environment are necessary. Be sure to consult with qualified Sony personnel.

Data Projector
VPL-PHZ60/PHZ50

On Disposing Used Products

Do not dispose the used products and general garbage together.
Correctly dispose of used products to avoid harming the environment or the health of yourself and others.
Follow the disposal regulations of your area.

5-025-459-11(1) Copyright 2020 Sony Corporation

Data Projector
VPL-PHZ60/PHZ50

On LCD Projector

The LCD projector is manufactured using high-precision technology. You may, however, see tiny black points and/or bright points (red, blue, or green) that continuously appear on the LCD projector. This is a normal result of the manufacturing process and does not indicate a malfunction. Also, when you use multiple LCD projectors to project onto a screen, even if they are of the same model, the color reproduction among projectors may vary, since color balance may be set differently from one projector to the next.

Data Projector
VPL-PHZ60/PHZ50

On condensation

If the room temperature where the projector is installed changes rapidly, or if the projector is moved suddenly from a cold to a warm place, condensation in the projector may occur.

As the condensation may cause malfunction, be careful in adjusting temperature settings of the air conditioner.

If condensation occurs, leave the projector turned on for about two hours before use.

Data Projector
VPL-PHZ60/PHZ50

Notes on Security

- SONY WILL NOT BE LIABLE FOR DAMAGES OF ANY KIND RESULTING FROM A FAILURE TO IMPLEMENT PROPER SECURITY MEASURES ON TRANSMISSION DEVICES, UNAVOIDABLE DATA LEAKS RESULTING FROM TRANSMISSION SPECIFICATIONS, OR SECURITY PROBLEMS OF ANY KIND.
 - Depending on the operating environment, unauthorized third parties on the network may be able to access the unit. When connecting the unit to the network, be sure to confirm that the network is protected securely.
 - From a safety standpoint, when using the unit connected with the network, it is strongly recommended to access the Control window via a Web browser and change the access limitation settings from the factory preset values. Also, it is recommended that you set a password with a sufficiently long character string that is hard to guess by others, and that you store it safely.
 - Do not browse any other website in the Web browser while making settings or after making settings. Since the login status remains in the Web browser, close the Web browser when you complete the settings to prevent unauthorized third parties from using the unit or harmful programs from running.
 - When connecting this product to a network, connect via a system that provides a protection function, such as a router or firewall. If connected without such protection, security issues may occur.
-

Related Topic

- [Operating the Control Panel](#)

Data Projector
VPL-PHZ60/PHZ50

Do not place this product close to medical devices

This product (including accessories) has magnet(s) which may interfere with pacemakers, programmable shunt valves for hydrocephalus treatment, or other medical devices. Do not place this product close to persons who use such medical devices. Consult your doctor before using this product if you use any such medical device.

5-025-459-11(1) Copyright 2020 Sony Corporation

Data Projector
VPL-PHZ60/PHZ50

Disclaimer

- Always verify that the unit is operating properly before use. SONY WILL NOT BE LIABLE FOR DAMAGES OF ANY KIND INCLUDING, BUT NOT LIMITED TO, COMPENSATION OR REIMBURSEMENT ON ACCOUNT OF THE LOSS OF PRESENT OR PROSPECTIVE PROFITS DUE TO FAILURE OF THIS UNIT, EITHER DURING THE WARRANTY PERIOD OR AFTER EXPIRATION OF THE WARRANTY, OR FOR ANY OTHER REASON WHATSOEVER.
- SONY WILL NOT BE LIABLE FOR CLAIMS OF ANY KIND MADE BY USERS OF THIS UNIT OR MADE BY THIRD PARTIES.
- SONY WILL NOT BE LIABLE FOR THE TERMINATION OR DISCONTINUATION OF ANY SERVICES RELATED TO THIS UNIT THAT MAY RESULT DUE TO CIRCUMSTANCES OF ANY KIND.

Cleaning the Air Filter

When the message that prompts cleaning the air filter appears, clean the air filter. If the dust cannot be removed from the air filter even after cleaning, replace the air filter with a new one. For details on a new air filter, consult with qualified Sony personnel.

Caution

If you continue to use the projector even after the message is displayed, dust may accumulate, clogging it. As a result, the temperature may rise inside the projector, leading to a possible malfunction or fire.

1 Turn off the projector and disconnect the AC power cord from a wall outlet.

2 To remove the air filter cover, lift it up while pressing the two levers.

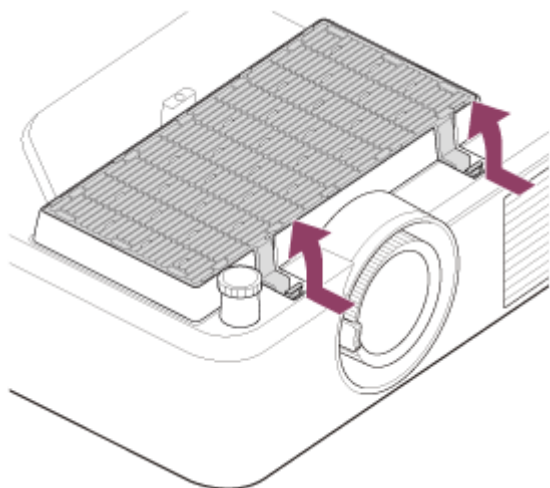

3 Remove the air filter from the air filter cover.

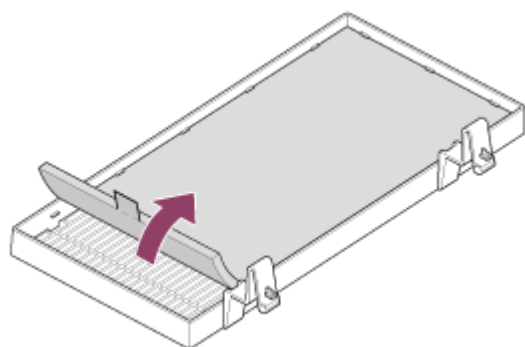

4 Clean the air filter with a vacuum cleaner.

5 Put the air filter back in the air filter cover, then attach the air filter cover to the unit.

Note

- If you remove the air filter cover while the power is turned on, you may accidentally touch the fan inside the projector, which may cause injury.

- Pull the air filter pull stick upwards when removing the air filter from the air filter cover. When attaching the air filter to the air filter cover, make sure the correct side is being attached so that the pull stick is protruding from the air filter.
- Securely attach the air filter to the air filter cover, taking care not to hit the hook of the air filter cover. If the air filter is attached to the air filter cover incorrectly, a malfunction may occur.
- Press the levers all the way inside the unit to lock it. If the air filter cover is attached to the unit incorrectly, a malfunction may occur.

Related Topic

- [Message List](#)

5-025-459-11(1) Copyright 2020 Sony Corporation

Data Projector
VPL-PHZ60/PHZ50

Updating Software

Here are instructions for updating the projector software.

Updating from a USB Drive

You can download the update file to your computer and copy it to a USB drive, then insert it into the projector's USB terminal to perform the update.

This method requires that you prepare your own USB drive, have a computer with internet connection, and be in an environment that allows the update file to be written to the USB drive.

The update file can be downloaded from the Sony website.

<https://pro.sony.com>

- 1 Copy the update file to the root folder of the USB drive.**
- 2 Turn off the projector and unplug the AC power cord.**
- 3 Insert the USB drive to the USB terminal of the projector.**
- 4 Plug the AC power cord to the wall outlet while pressing the INPUT key on the projector.**

The ON/STANDBY indicator lights up in red and then flashes in orange (updating software).
- 5 Release the INPUT key.**

The ON/STANDBY indicator remains lit in red when update is complete.
- 6 Press the  (On/Standby) key with the USB drive inserted.**

The ON/STANDBY indicator starts flashing in green.
When there is another update, the ON/STANDBY indicator remains lit in red and the update proceeds automatically.
When there is no additional update, the projector light turns on.
- 7 Remove the USB drive from the projector.**

If the projector light is on, turn off the projector to remove the USB drive.

Updating by Connecting to a Network

Connecting a computer to the LAN environment that the projector is connected to allows you to update the projector via a network.

The update file can be downloaded from the Sony website.

<https://pro.sony.com>

For details, refer to “Using the Software Update Function.”

Note

- This projector has been confirmed to be compatible with USB 2.0 drives with capacities of up to 8 GB. However, it is not guaranteed to work with all USB drives.

If formatting your USB drive, be sure that the file system is set to FAT32. Formatting with any other type of file system will make the drive incompatible with the projector.

- Some USB drives may be incompatible. For details, please check the aforementioned website.
- Do not disconnect the AC power cord during the software update process.

Related Topic

- [Using the Software Update Function](#)

5-025-459-11(1) Copyright 2020 Sony Corporation

Data Projector
VPL-PHZ60/PHZ50

Specifications

Optical System

Projection System

3 LCD system

Display Device

Effective Display Size

0.64 in (16.3 mm) × 3, 16:10 Aspect Ratio

Effective Pixels

6,912,000 pixels (1,920 × 1,200 pixels × 3)

Projection Lens

Focus Adjustment

Manual

Zoom Adjustment

Manual (1.6×)

Light Source

Laser diode

Projection Image Size

40 in - 300 in (1.02 m - 7.62 m)

Effective Light Flux (Brightness)

VPL-PHZ60: 6,000 lm ([Light Output Mode]: [Standard])

VPL-PHZ50: 5,000 lm ([Light Output Mode]: [Standard])

Electric System

Speaker

16 W × 1 (Monaural)

Supported Scan Frequency^{*1}

Horizontal: 15 kHz - 92 kHz, Vertical: 24 Hz - 92 Hz

Displayable Resolution^{*1}

For Computer Signal Input

Maximum Display Resolution: 1,920 × 1,200 pixels

For Video Signal Input

NTSC, PAL, SECAM, 480/60i, 576/50i, 480/60p, 576/50p, 720/60p, 720/50p, 1080/60i, 1080/50i, 1080/60p, 1080/50p, 1080/24p, 2160/30p^{*2}, 2160/25p^{*2}, 2160/24p^{*2}

Color System

NTSC3.58, PAL, SECAM, NTSC4.43, PAL-M, PAL-N, PAL60

^{*1} For details, refer to the supported signal table.

^{*2} Displayed only when the number of horizontal pixels is 3,840.

Input/Output Terminals

For Computer/Video Input and Output

Input A

RGB/Y PB PR Input Terminal: Mini D-sub 15 pin (Female), G with sync/Y: 1 Vp-p±2 dB, sync negative, 75 Ω terminated, RGB signal/PB PR signal: 0.7 Vp-p±2 dB, 75 Ω terminated, Sync signal: TTL level, high impedance, positive-negative polarity

Audio Input Terminal: Stereo mini jack, Rated input: 500 mVrms, Input impedance: 47 kΩ or above

Input B/Input C

HDMI Input Terminal: 19-pin HDMI, HDCP

Audio Input Terminal: HDMI audio supported

Input D

HDBaseT Input Terminal: RJ45, digital RGB/Y PB PR, HDCP supported, RS-232C, Ethernet (100Base-TX) transmission supported

Video Input

Video Input Terminal: Phono jack, 1 Vp-p±2 dB, sync negative, 75 Ω terminated

Audio Input Terminal: Shared with Input A

Output

Audio Output Terminal: Stereo mini jack, Stereo, 1 Vrms (maximum volume, when inputting 500 mVrms), Output impedance: 5 kΩ

Other Terminals

RS-232C Terminal: D-Sub 9 pin (Male)

LAN Terminal: RJ45, 10BASE-T/100BASE-TX

USB Terminal: Type A

USB Power Supply Terminal: Type A

Power Supply/Other

Operating Temperature (Operating Humidity)

0 °C to 40 °C (32 °F to 104 °F) (20% - 80% (No condensation))

Storage Temperature (Storage Humidity)

-10 °C to +60 °C (14 °F to 140 °F) (20% - 80% (No condensation))

Power Requirements

100 V to 240 V AC, 4.4 A – 1.9 A, 50/60 Hz

Power Consumption

AC 100 V to 120 V: 440 W

AC 220 V to 240 V: 418 W

Standby Power Consumption (Standby Mode)

0.5 W (When setting [Standby Mode] to [Low] and [Remote Start] to [Off])

Standby Power Consumption (Network Standby Mode)

1.0 W (When setting [Standby Mode] to [Low] and [Remote Start] to [On])

16.0 W (If all network ports are connected) (When setting [Standby Mode] to [Standard])

Heat Dissipation

AC 100 V to 120 V: 1,502 BTU/h

AC 220 V to 240 V: 1,427 BTU/h

Standard Dimensions (W/H/D)

422 mm × 129 mm × 338 mm (16 5/8 in × 5 3/32 in × 13 5/16 in)

422 mm × 100 mm × 333 mm (16 5/8 in × 3 15/16 in × 13 1/8 in) (Without projecting parts)

Mass

VPL-PHZ60: Approx. 7.0 kg (15 lb)

VPL-PHZ50: Approx. 6.6 kg (14 lb)

Supplied Accessories

Remote Commander (RM-PJ8) (1)

Lithium battery (CR2025) (1)

AC power cord (1)

Mini D-sub 15-pin cable (1.8 m) (1) (1-970-584-11/Sony)

Setup Guide (1)

Design and specifications of the unit, including the optional accessories, are subject to change without notice.

Related Topic

- [Compatible Signal List \(Computer Signal\)](#)
- [Compatible Signal List \(Video Signal\)](#)

Data Projector
VPL-PHZ60/PHZ50

Pin Assignment (HDMI Terminal)

HDMI Terminal (HDMI, Female)

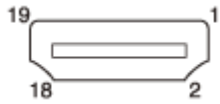

Pin Number	Function
1	T.M.D.S. Data2 +
2	T.M.D.S. Data2 Shield
3	T.M.D.S. Data2 -
4	T.M.D.S. Data1 +
5	T.M.D.S. Data1 Shield
6	T.M.D.S. Data1 -
7	T.M.D.S. Data0 +
8	T.M.D.S. Data0 Shield
9	T.M.D.S. Data0 -
10	T.M.D.S. Clock +
11	T.M.D.S. Clock Shield
12	T.M.D.S. Clock -
13	N.C.
14	RESERVED (N.C.)
15	SCL
16	SDA
17	DDC GND
18	+5 V Power
19	Hot Plug Detect

Data Projector
VPL-PHZ60/PHZ50

Pin Assignment (RGB Input Terminal)

RGB Input Terminal (Mini D-sub 15 pin, Female)

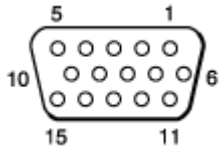

Pin Number	Function
1	Image Input (Red) R
2	Image Input (Green) G
3	Image Input (Blue) B
4	Ground
5	RESERVE
6	Ground (For red)
7	Ground (For green)
8	Ground (For blue)
9	Power input for DDC
10	Ground
11	Ground
12	DDC/SDA
13	Horizontal synchronization signal
14	Vertical synchronization signal
15	DDC/SCL

Data Projector
VPL-PHZ60/PHZ50

Pin Assignment (RS-232C Terminal)

RS-232C Terminal (D-Sub 9 pin, Male)

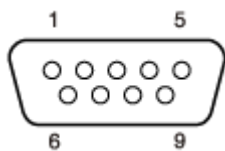

Pin Number	Function
1	NC
2	RXDA
3	TXDA
4	DTR
5	GND
6	NC
7	RTS
8	CTS
9	NC

Data Projector
VPL-PHZ60/PHZ50

Pin Assignment (USB Terminal)

USB Terminal (Type A, Female)

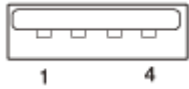

Pin Number	Function
1	V BUS (4.4 - 5.25 V)
2	Data -
3	Data +
4	Ground

USB Power Supply Terminal (Type A, Female)

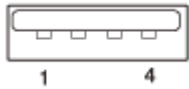

Pin Number	Function
1	V BUS (4.4 - 5.25 V)
2	N.C.
3	N.C.
4	Ground

Compatible Signal List (Computer Signal)

Note

- The projector may not be able to display the image properly if an input signal not listed in the table is used.
- With input signals that differ from the panel display resolution, the input signal may not be displayed at the same resolution, and the text, ruled line thickness, and so on may become unbalanced.
- The source device may not detect signals automatically, even if the signal to be input is a compatible signal. In this case, set the signal manually.

Resolution	fH[kHz]/fV[Hz]	INPUT A	INPUT B / INPUT C / INPUT D
640 x 350	31.5/70	Compatible	Not compatible
640 x 350	37.9/85	Compatible	Not compatible
640 x 400	31.5/70	Compatible	Not compatible
640 x 400	37.9/85	Compatible	Not compatible
640 x 480	31.5/60	Compatible	Compatible
640 x 480	35.0/67	Compatible	Not compatible
640 x 480	37.9/73	Compatible	Not compatible
640 x 480	37.5/75	Compatible	Not compatible
640 x 480	43.3/85	Compatible	Not compatible
800 x 600	35.2/56	Compatible	Not compatible
800 x 600	37.9/60	Compatible	Compatible
800 x 600	48.1/72	Compatible	Not compatible
800 x 600	46.9/75	Compatible	Not compatible
800 x 600	53.7/85	Compatible	Not compatible
832 x 624	49.7/75	Compatible	Not compatible
1024 x 768	48.4/60	Compatible	Compatible
1024 x 768	56.5/70	Compatible	Not compatible
1024 x 768	60.0/75	Compatible	Not compatible
1024 x 768	68.7/85	Compatible	Not compatible
1152 x 864	64.0/70	Compatible	Not compatible
1152 x 864	67.5/75	Compatible	Not compatible
1152 x 864	77.5/85	Compatible	Not compatible
1152 x 900	61.8/66	Compatible	Not compatible

Resolution	fH[kHz]/fV[Hz]	INPUT A	INPUT B / INPUT C / INPUT D
1280 x 960	60.0/60	Compatible	Compatible
1280 x 1024	64.0/60	Compatible	Compatible
1280 x 1024	80.0/75	Compatible	Not compatible
1280 x 1024	91.1/85	Compatible	Not compatible
1400 x 1050	65.3/60	Compatible	Compatible
1600 x 1200	75.0/60	Compatible	Compatible
1280 x 768	47.8/60	Not compatible	Compatible
1280 x 720	45.0/60	Compatible	Compatible *1
1920 x 1080	67.5/60	Compatible	Compatible *2
1366 x 768	47.7/60	Compatible	Compatible
1440 x 900	55.9/60	Compatible	Compatible
1680 x 1050	65.3/60	Not compatible	Compatible
1280 x 800	49.7/60	Compatible	Compatible
1920 x 1200	74.0/60	Compatible *3	Compatible *3

*1 Identified as a 720/60p video transmission signal.

*2 Identified as a 1080/60p video transmission signal.

*3 Only 1920 x 1200 VESA Reduced Blanking signals are compatible.

Compatible Signal List (Video Signal)

Note

- The projector may not be able to display the image properly if an input signal not listed in the table is used.
- With input signals that differ from the panel display resolution, the input signal may not be displayed at the same resolution, and the text, ruled line thickness, and so on may become unbalanced.
- The source device may not detect signals automatically, even if the signal to be input is a compatible signal. In this case, set the signal manually.

Signal Name	fV[Hz]	VIDEO IN	INPUT A* ¹	INPUT B / INPUT C / INPUT D
NTSC	60	Compatible	Not compatible	Not compatible
PAL/SECAM	50	Compatible	Not compatible	Not compatible
480i	60	Not compatible	Compatible	Compatible
576i	50	Not compatible	Compatible	Compatible
480p	60	Not compatible	Compatible	Compatible
576p	50	Not compatible	Compatible	Compatible
1080i	60	Not compatible	Compatible	Compatible
1080i	50	Not compatible	Compatible	Compatible
720p	60	Not compatible	Compatible	Compatible
720p	50	Not compatible	Compatible	Compatible
1080p	60	Not compatible	Compatible	Compatible
1080p	50	Not compatible	Compatible	Compatible
1080p	24	Not compatible	Not compatible	Compatible
2160p* ²	30	Not compatible	Not compatible	Compatible
2160p* ²	25	Not compatible	Not compatible	Compatible
2160p* ²	24	Not compatible	Not compatible	Compatible

*1 Only compatible with G/Y signal with sync.

*2 Displayed only when the number of horizontal pixels is 3,840. Not compatible with 2160/60p and 2160/50p signals.

Data Projector
VPL-PHZ60/PHZ50

Projection Distance

The projection distance is the distance from the front surface of the lens to the projection surface.

The projection screen height is the distance from the point of intersection (A in the image) of the line drawn perpendicular to the surface projected from the lens center and the projection surface, to the lower edge (upper edge when installed to the ceiling) of the projection screen.

For this projector, the projection distance value for when the projector is installed to the floor and to the ceiling is the same.

When installed to the floor/ceiling (install so that the projector upper surface is parallel with the ceiling)

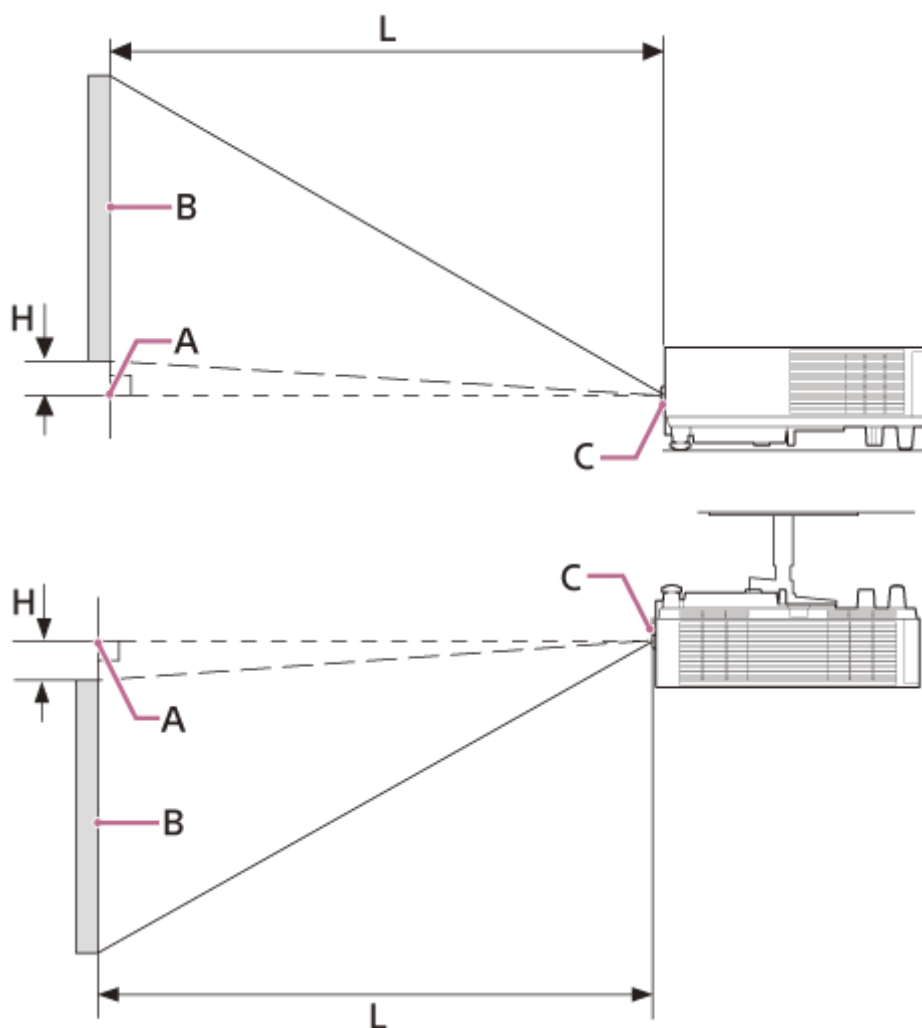

- A:** The point of intersection of the line drawn perpendicular to the surface projected from the lens center and the projection surface
- B:** Projection screen
- C:** Lens front surface
- H:** Projection screen height position
- L:** Projection distance

- Projection Distance/Projection Distance Formula

5-025-459-11(1) Copyright 2020 Sony Corporation

Data Projector
VPL-PHZ60/PHZ50

Projection Distance/Projection Distance Formula

Projection Distance

80-inch screen size (2.03 m) (Horizontal: 1.72 m × Vertical: 1.08 m) (Width 68 in × Height 42 in)

- Projection Distance L: 2.12 m - 3.39 m (84 in - 133 in)
- Projection Screen Height Position H (Minimum): -0.91 m (-36 in)
- Projection Screen Height Position H (Maximum): 0.05 m (2 in)

100-inch screen size (2.54 m) (Horizontal: 2.15 m × Vertical: 1.35 m) (Width 85 in × Height 53 in)

- Projection Distance L: 2.65 m - 4.24 m (105 in - 166 in)
- Projection Screen Height Position H (Minimum): -1.14 m (-45 in)
- Projection Screen Height Position H (Maximum): 0.06 m (2 in)

120-inch screen size (3.05 m) (Horizontal: 2.58 m × Vertical: 1.62 m) (Width 102 in × Height 64 in)

- Projection Distance L: 3.18 m - 5.09 m (126 in - 200 in)
- Projection Screen Height Position H (Minimum): -1.37 m (-54 in)
- Projection Screen Height Position H (Maximum): 0.08 m (3 in)

150-inch screen size (3.81 m) (Horizontal: 3.23 m × Vertical: 2.02 m) (Width 127 in × Height 79 in)

- Projection Distance L: 3.98 m - 6.36 m (157 in - 250 in)
- Projection Screen Height Position H (Minimum): -1.71 m (-67 in)
- Projection Screen Height Position H (Maximum): 0.10 m (3 in)

200-inch screen size (5.08 m) (Horizontal: 4.31 m × Vertical: 2.69 m) (Width 170 in × Height 106 in)

- Projection Distance L: 5.30 m - 8.48 m (209 in - 333 in)
- Projection Screen Height Position H (Minimum): -2.28 m (-90 in)
- Projection Screen Height Position H (Maximum): 0.13 m (5 in)

Projection Distance Formula

D: Screen Size (Inches)

Ex.) If the screen size is 80 inches, enter 80 for D.

H: Height from center of lens to bottom edge of screen

Formula 1 (Unit: m (in))

- Projection Distance L (Minimum): $L = 0.026483 \times D + 0.0001$ ($L = 1.042640 \times D + 0.0032$)
- Projection Distance L (Maximum): $L = 0.042417 \times D + 0.0000$ ($L = 1.669953 \times D + 0.0013$)

Formula 2 (Unit: m (in))

- Projection Screen Height Position H (Minimum): $H = -0.011443 \times D$ ($H = -0.450499 \times D$)
- Projection Screen Height Position H (Maximum): $H = 0.000673 \times D$ ($H = 0.026500 \times D$)

Related Topic

- [Projection Distance](#)

Data Projector
VPL-PHZ60/PHZ50

Lens Shift Range

The lens shift range represents the distance in percent (%) by which the lens can be shifted from the initial position of the projected image, with full width or full height of the projected image regarded as 100%.

Side view

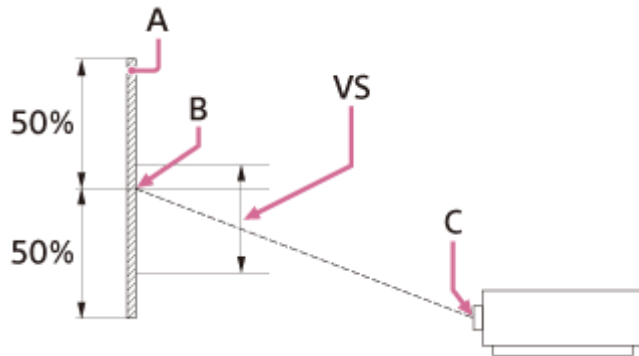

- A: Projected image
- B: Center of the projected image
- C: Center of the lens
- VS: Lens shift range

Top view

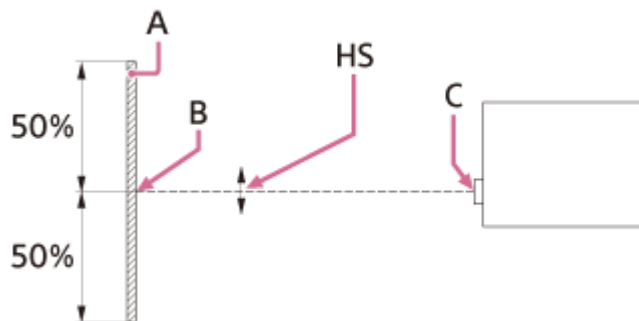

- A: Projected image
- B: Center of the projected image
- C: Center of the lens
- HS: Lens shift range

Lens shift range

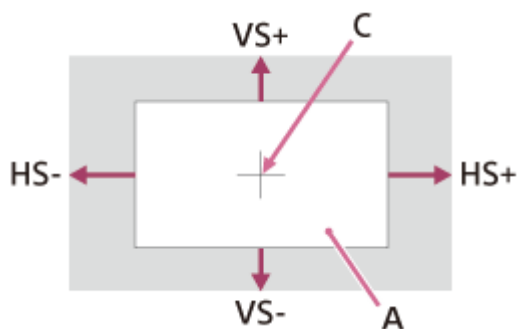

- A: Projected image

C: Center of the image

Shaded region: Lens shift range

VS+: Vertical lens shift range (up) [%]

VS-: Vertical lens shift range (down) [%]

HS+: Horizontal lens shift range (right) [%]

HS-: Horizontal lens shift range (left) [%]

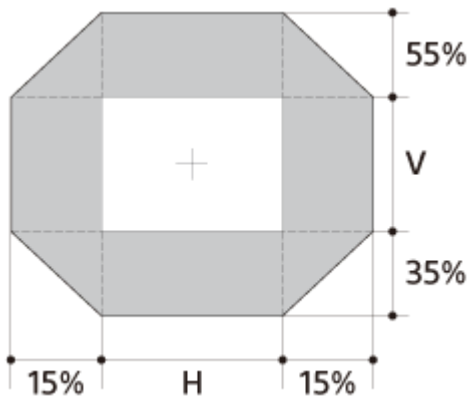

VS+ = 55 [%]

VS- = 35 [%]

HS+ = HS- = 15 [%]

VS+ [%] = 55 - 3.667 × (HS+ [%] or HS- [%])

VS- [%] = 35 - 2.333 × (HS+ [%] or HS- [%])

HS+ [%] = HS- [%] = 15 - 0.273 × VS+ [%]

HS+ [%] = HS- [%] = 15 - 0.429 × VS- [%]

Data Projector
VPL-PHZ60/PHZ50

Reading the Indicator

You can check the projector status or abnormality by checking the lighting/flashing status of the ON/STANDBY indicator and WARNING indicator.

If the indicators flash in red, follow the instructions under “Warning Indication and Remedies” to resolve the issue.

Top of the main unit

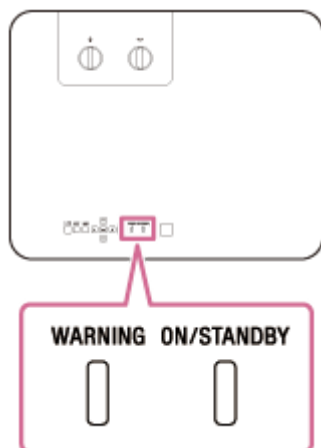

Status Indication

WARNING: Off, ON/STANDBY: Lights in red

WARNING ON/STANDBY



Standby mode

The power is supplied to the projector and the projector is in a standby mode according to the setting.

WARNING: Off, ON/STANDBY: Flashes in green

WARNING ON/STANDBY



Warm-up state

The projector is warming up after it is turned on.

WARNING: Off, ON/STANDBY: Lights in green

WARNING ON/STANDBY



Power on state

The projector is ready for projection.

WARNING: Off, ON/STANDBY: Lights in orange

WARNING ON/STANDBY



Other standby state

The projector is in With No Input (Light Cutoff) or the [Speaker Setting] is set to [Always On].

WARNING: Off, ON/STANDBY: Flashes in orange

WARNING ON/STANDBY



Updating software

The projector software is being updated.

Warning Indication and Remedies

WARNING: Flashes in red, ON/STANDBY: Lights in red

WARNING ON/STANDBY



Number of flashes: Twice

The top cover is not properly attached.

Check the attachment of the top cover. If it has been loosened due to a strong impact to the projector, consult with qualified Sony personnel.

Number of flashes: Three times

The light source does not light properly.

Unplug the AC power cord and make sure the ON/STANDBY indicator turns off, then plug the AC power cord into the wall outlet and turn on the projector.

WARNING: Flashes in red, ON/STANDBY: Flashes in red

Both indicators flash

WARNING ON/STANDBY



Number of flashes: Twice

The temperature in the projector is abnormal.

- Check if the air filter is clogged, then clean or replace it.
- Check if the ventilation holes (intake/exhaust) are not blocked by the wall or an object and secure a sufficient gap.
- Check the ambient temperature and use the projector within the range of operating temperature.

Note

- If the indicators flash in a manner other than described above, unplug the AC power cord and make sure the ON/STANDBY indicator turns off, then plug the AC power cord into the wall outlet and turn on the projector. If the problem still persists, consult with qualified Sony personnel.

Related Topic

- [Cleaning the Air Filter](#)

Message List

If a message such as one of the following appears on the screen, follow the instructions in the table to resolve the issue.



Message	Meaning/Solution
Clean the filter. Projector temperature is high. The light will turn off in 1 minute.	An increase in the inner projector temperature has been detected. Take the following measures. <ul style="list-style-type: none"> ● Confirm that the air filter is not blocked and either clean the filter or replace it. ● Confirm that the ventilation holes are not blocked by a wall or other object, and secure a sufficient gap. ● Check the projector's ambient temperature and use it within a temperature range in which it is operable. ● When using the projector in a location at a high altitude, appropriately set the High Altitude Mode.
Frequency is out of range!	Change the signal to one that is compatible with the projector from the playback device screen settings.
Please check Input-A Signal Sel.	Set [Input-A Signal Sel.] to [Auto] or a setting appropriate for the input signal.
Not applicable!	An invalid key was pressed.
The control keys are locked!	The panel key lock has been set.
Light Dimming	This is displayed when the light output decreases due to the settings for when there is no change in the signal. When a signal change or operation (Remote Commander or control panel) is detected, it will revert to its normal state.

Related Topic

- [Parts and Controls \(Main Unit\)](#)
- [Parts and Controls \(Remote Commander and Control Panel\)](#)
- [Menu Operation: Control Key Lock](#)
- [Menu Operation: Input-A Signal Sel.](#)
- [Menu Operation: ECO](#)
- [Cleaning the Air Filter](#)
- [Compatible Signal List \(Computer Signal\)](#)
- [Compatible Signal List \(Video Signal\)](#)

Data Projector
VPL-PHZ60/PHZ50

No Power

- Confirm that the AC power cord is firmly inserted.
 - If [Control Key Lock] is [On], power cannot be supplied via the  /  (On/Standby) key on the main unit. Set [Control Key Lock] in the  [Operation] menu to [Off].
-

Related Topic

- [Menu Operation: Control Key Lock](#)

Data Projector
VPL-PHZ60/PHZ50

No Image is Displayed

- Confirm that the cable connected to the playback device is firmly inserted.
 - Confirm that the computer's output settings are set to external monitor output.
For laptops, etc., setting the output signal to be output both to the computer's LCD and the external monitor may cause the image to not be displayed correctly on the external monitor. If this occurs, configure the computer's settings so that it only outputs to the external monitor.
 - Confirm that the input is selected correctly.
 - Confirm that the BLANK key is not pressed and that the image is not being deleted.
-

Related Topic

- [Parts and Controls \(Remote Commander and Control Panel\)](#)
- [Precautions When Connecting](#)
- [Projecting Images](#)

Data Projector
VPL-PHZ60/PHZ50

Cannot Connect to Computer

- Check the network settings.
-
-

Related Topic

- [Menu Operation: Network Setting](#)

5-025-459-11(1) Copyright 2020 Sony Corporation

Data Projector
VPL-PHZ60/PHZ50

No On-screen Display

- Set [Status] in the  [Operation] menu to [On].
-
-

Related Topic

- [Menu Operation: Status](#)

Data Projector
VPL-PHZ60/PHZ50

Screen Aspect Ratio is Strange/Screen Display is Small/Part of Image Not Displayed

- The screen may not be displayed properly sometimes if the input signal is not properly determined. If this occurs, manually configure [Aspect] in the  [Screen] menu.
-

Related Topic

- [Menu Operation: Aspect](#)

Data Projector
VPL-PHZ60/PHZ50

Trapezoidal Screen

- If the projection is diagonal relative to the projection surface, the screen will appear trapezoidal. If this occurs, you can use the keystone correction function to correct the issue.
-
-

Related Topic

- [Correcting a Vertical Trapezoid](#)
- [Correcting a Horizontal Trapezoid](#)

Data Projector
VPL-PHZ60/PHZ50

Edges of the image are cut off or dark

- If you use the lens shift function with a setting outside the recommended range, edges of the image may be cut off or appear dark. Use a setting within the normal range for the lens shift function.
-
-

Related Topic

- [Lens Shift Range](#)

Data Projector
VPL-PHZ60/PHZ50

Screen Distortion

- The corner keystone setting is active. Deactivate [Corner Keystone] in the  [Installation] menu.
-
-



Related Topic

- [Correcting Screen Distortion](#)

5-025-459-11(1) Copyright 2020 Sony Corporation

Data Projector
VPL-PHZ60/PHZ50

Screen is Too Dark/Bright

- The [Brightness], [Contrast], and [Light Output Mode] settings change the screen brightness. In the  [Projection Setting] menu, confirm that the values are set to appropriate values.
 - [With Static Signal] under [ECO] in the  [Connection/Power] menu is set to [Light Dimming].
 - If there is no image signal, power consumption is reduced, and the light intensity decreases.
 - When using the projector in a location where the surrounding temperature is high, the luminance is sometimes reduced to protect the projector.
-

Related Topic

- [Menu Operation: Contrast](#)
- [Menu Operation: Brightness](#)
- [Menu Operation: Light Settings](#)
- [Menu Operation: ECO](#)

Data Projector
VPL-PHZ60/PHZ50

Blurry Screen

- Adjust the focus.
 - The screen will blur if there is condensation on the lens. If there is condensation, keep the projector plugged in and let it sit for approximately two hours.
-
-

Related Topic

- [Adjusting the Screen Focus](#)
- [On condensation](#)

Data Projector
VPL-PHZ60/PHZ50

Screen Noise

- Confirm that the cable connected to the playback device is firmly inserted.
-
-

Related Topic

- [Precautions When Connecting](#)

5-025-459-11(1) Copyright 2020 Sony Corporation

Data Projector
VPL-PHZ60/PHZ50

No Sound

- Confirm that the cable that is connected to the playback device or the external audio device is firmly inserted.
 - Confirm that the external audio device is configured correctly.
 - If [Speaker] is set to [Off], there will be no sound output. Set [Speaker] in the  [Function] menu to [On].
 - If the MUTING key was pressed and the sound is muted, there will be no sound output. Press the MUTING key one more time.
 - Confirm that the volume is not set to the minimum.
-

Related Topic

- [Connecting to Audio Equipment](#)
- [Menu Operation: Speaker](#)

Data Projector
VPL-PHZ60/PHZ50

Remote Commander Does Not Function



- Confirm that the batteries are inserted correctly.
 - Confirm that the batteries are not depleted.
 - Check the setting for [IR Receiver].
-
-

Related Topic

- [Inserting the Battery into the Remote Commander](#)
- [Menu Operation: IR Receiver](#)

Data Projector
VPL-PHZ60/PHZ50

Loud Fan

- The noise from the fan may grow louder due to the following types of situations where it is necessary to cool the light source or other components.
 - Set [Light Output Mode] in [Light Settings] in the  [Projection Setting] menu to [Standard].
 - The projector is being used at a high altitude (set [High Altitude Mode] in the  [Installation] menu to [Level2] or [Level1]).
 - The projector is being used in a location where the surrounding temperature is high.
 - Confirm that the air filter is not blocked and either clean the filter or replace it.
 - Confirm that the ventilation holes are not blocked by a wall or other object, and a secure sufficient gap.
-

Related Topic

- [Cleaning the Air Filter](#)
- [On Installation](#)

Data Projector
VPL-PHZ60/PHZ50

Notifications Related to GNU GPL/LGPL-applicable Software

This product contains the following software that has received a GNU General Public License ("GPL" below) or GNU Lesser General Public License ("LGPL" below).

We hereby inform you that you have the right to obtain, alter, and redistribute the software source code in accordance with the attached GPL/LGPL conditions.

The source code is available on our website. It can be downloaded from the following URL:

<http://oss.sony.net/Products/Linux>

Please refrain from contacting us regarding the contents of the source code.

Listed below are the GNU GENERAL PUBLIC LICENSE and GNU LESSER GENERAL PUBLIC LICENSE.

GNU GENERAL PUBLIC LICENSE

Version 2, June 1991

Copyright © 1989, 1991 Free Software Foundation, Inc.,

51 Franklin Street, Fifth Floor, Boston, MA 02110-1301 USA

Everyone is permitted to copy and distribute verbatim copies of this license document, but changing it is not allowed.

Preamble

The licenses for most software are designed to take away your freedom to share and change it. By contrast, the GNU General Public License is intended to guarantee your freedom to share and change free software—to make sure the software is free for all its users. This General Public License applies to most of the Free Software Foundation's software and to any other program whose authors commit to using it. (Some other Free Software Foundation software is covered by the GNU Lesser General Public License instead.) You can apply it to your programs, too.

When we speak of free software, we are referring to freedom, not price.

Our General Public Licenses are designed to make sure that you have the freedom to distribute copies of free software (and charge for this service if you wish), that you receive source code or can get it if you want it, that you can change the software or use pieces of it in new free programs; and that you know you can do these things.

To protect your rights, we need to make restrictions that forbid anyone to deny you these rights or to ask you to surrender the rights. These restrictions translate to certain responsibilities for you if you distribute copies of the software, or if you modify it.

For example, if you distribute copies of such a program, whether gratis or for a fee, you must give the recipients all the rights that you have. You must make sure that they, too, receive or can get the source code. And you must show them these terms so they know their rights.

We protect your rights with two steps: (1) copyright the software, and (2) offer you this license which gives you legal permission to copy, distribute and/or modify the software.

Also, for each author's protection and ours, we want to make certain that everyone understands that there is no warranty for this free software. If the software is modified by someone else and passed on, we want its recipients to know that what they have is not the original, so that any problems introduced by others will not reflect on the original authors' reputations.

Finally, any free program is threatened constantly by software patents.

We wish to avoid the danger that redistributors of a free program will individually obtain patent licenses, in effect making the program proprietary. To prevent this, we have made it clear that any patent must be licensed for everyone's free use or not licensed at all.

The precise terms and conditions for copying, distribution and modification follow.

TERMS AND CONDITIONS FOR COPYING, DISTRIBUTION AND MODIFICATION

0. This License applies to any program or other work which contains a notice placed by the copyright holder saying it may be distributed under the terms of this General Public License. The "Program", below, refers to any such program or work, and a "work based on the Program" means either the Program or any derivative work under copyright law: that is to say, a work containing the Program or a portion of it, either verbatim or with modifications and/or translated into

another language. (Hereinafter, translation is included without limitation in the term "modification".) Each licensee is addressed as "you".

Activities other than copying, distribution and modification are not covered by this License; they are outside its scope. The act of running the Program is not restricted, and the output from the Program is covered only if its contents constitute a work based on the Program (independent of having been made by running the Program).

Notifications Related to GNU GPL/LGPL-applicable Software

Whether that is true depends on what the Program does.

1. You may copy and distribute verbatim copies of the Program's source code as you receive it, in any medium, provided that you conspicuously and appropriately publish on each copy an appropriate copyright notice and disclaimer of warranty; keep intact all the notices that refer to this License and to the absence of any warranty; and give any other recipients of the Program a copy of this License along with the Program. You may charge a fee for the physical act of transferring a copy, and you may at your option offer warranty protection in exchange for a fee.
2. You may modify your copy or copies of the Program or any portion of it, thus forming a work based on the Program, and copy and distribute such modifications or work under the terms of Section 1 above, provided that you also meet all of these conditions:
 - a) You must cause the modified files to carry prominent notices stating that you changed the files and the date of any change.
 - b) You must cause any work that you distribute or publish, that in whole or in part contains or is derived from the Program or any part thereof, to be licensed as a whole at no charge to all third parties under the terms of this License.
 - c) If the modified program normally reads commands interactively when run, you must cause it, when started running for such interactive use in the most ordinary way, to print or display an announcement including an appropriate copyright notice and a notice that there is no warranty (or else, saying that you provide a warranty) and that users may redistribute the program under these conditions, and telling the user how to view a copy of this License. (Exception: if the Program itself is interactive but does not normally print such an announcement, your work based on the Program is not required to print an announcement.) These requirements apply to the modified work as a whole. If identifiable sections of that work are not derived from the Program, and can be reasonably considered independent and separate works in themselves, then this License, and its terms, do not apply to those sections when you distribute them as separate works. But when you distribute the same sections as part of a whole which is a work based on the Program, the distribution of the whole must be on the terms of this License, whose permissions for other licensees extend to the entire whole, and thus to each and every part regardless of who wrote it. Thus, it is not the intent of this section to claim rights or contest your rights to work written entirely by you; rather, the intent is to exercise the right to control the distribution of derivative or collective works based on the Program. In addition, mere aggregation of another work not based on the Program with the Program (or with a work based on the Program) on a volume of a storage or distribution medium does not bring the other work under the scope of this License.
3. You may copy and distribute the Program (or a work based on it, under Section 2) in object code or executable form under the terms of Sections 1 and 2 above provided that you also do one of the following:
 - a) Accompany it with the complete corresponding machinereadable source code, which must be distributed under the terms of Sections 1 and 2 above on a medium customarily used for software interchange; or,
 - b) Accompany it with a written offer, valid for at least three years, to give any third party, for a charge no more than your cost of physically performing source distribution, a complete machine-readable copy of the corresponding source code, to be distributed under the terms of Sections 1 and 2 above on a medium customarily used for software interchange; or,
 - c) Accompany it with the information you received as to the offer to distribute corresponding source code. (This alternative is allowed only for noncommercial distribution and only if you received the program in object code or executable form with such an offer, in accord with Subsection b above.) The source code for a work means the preferred form of the work for making modifications to it. For an executable work, complete source code means all the source code for all modules it contains, plus any associated interface definition files, plus the scripts used to control compilation and installation of the executable. However, as a special exception, the source code distributed need not include anything that is normally distributed (in either source or binary form) with the major components (compiler, kernel, and so on) of the operating system on which the executable runs, unless that component itself accompanies the executable. If distribution of executable or object code is made by offering access to copy from a designated place, then offering equivalent access to copy the source code from the same place counts as distribution of the source code, even though third parties are not compelled to copy the source along with the object code.
4. You may not copy, modify, sublicense, or distribute the Program except as expressly provided under this License. Any attempt otherwise to copy, modify, sublicense or distribute the Program is void, and will automatically terminate your rights under this License. However, parties who have received copies, or rights, from you under this License will not have their licenses terminated so long as such parties remain in full compliance.
5. You are not required to accept this License, since you have not signed it. However, nothing else grants you permission to modify or distribute the Program or its derivative works. These actions are prohibited by law if you do not accept this License. Therefore, by modifying or distributing the Program (or any work based on the Program), you indicate your

acceptance of this License to do so, and all its terms and conditions for copying, distributing or modifying the Program or works based on it.

6. Each time you redistribute the Program (or any work based on the Program), the recipient automatically receives a license from the original licensor to copy, distribute or modify the Program subject to these terms and conditions. You may not impose any further restrictions on the recipients' exercise of the rights granted herein. You are not responsible for enforcing compliance by third parties to this License.

7. If, as a consequence of a court judgment or allegation of patent infringement or for any other reason (not limited to patent issues), conditions are imposed on you (whether by court order, agreement or otherwise) that contradict the conditions of this License, they do not excuse you from the conditions of this License. If you cannot distribute so as to satisfy simultaneously your obligations under this License and any other pertinent obligations, then as a consequence you may not distribute the Program at all. For example, if a patent license would not permit royalty-free redistribution of the Program by all those who receive copies directly or indirectly through you, then the only way you could satisfy both it and this License would be to refrain entirely from distribution of the Program. If any portion of this section is held invalid or unenforceable under any particular circumstance, the balance of the section is intended to apply and the section as a whole is intended to apply in other circumstances. It is not the purpose of this section to induce you to infringe any patents or other property right claims or to contest validity of any such claims; this section has the sole purpose of protecting the integrity of the free software distribution system, which is implemented by public license practices. Many people have made generous contributions to the wide range of software distributed through that system in reliance on consistent application of that system; it is up to the author/donor to decide if he or she is willing to distribute software through any other system and a licensee cannot impose that choice. This section is intended to make thoroughly clear what is believed to be a consequence of the rest of this License.

8. If the distribution and/or use of the Program is restricted in certain countries either by patents or by copyrighted interfaces, the original copyright holder who places the Program under this License may add an explicit geographical distribution limitation excluding those countries, so that distribution is permitted only in or among countries not thus excluded. In such case, this License incorporates the limitation as if written in the body of this License.

9. The Free Software Foundation may publish revised and/or new versions of the General Public License from time to time. Such new versions will be similar in spirit to the present version, but may differ in detail to address new problems or concerns. Each version is given a distinguishing version number. If the Program specifies a version number of this License which applies to it and "any later version", you have the option of following the terms and conditions either of that version or of any later version published by the Free Software Foundation. If the Program does not specify a version number of this License, you may choose any version ever published by the Free Software Foundation.

10. If you wish to incorporate parts of the Program into other free programs whose distribution conditions are different, write to the author to ask for permission. For software which is copyrighted by the Free Software Foundation, write to the Free Software Foundation; we sometimes make exceptions for this. Our decision will be guided by the two goals of preserving the free status of all derivatives of our free software and of promoting the sharing and reuse of software generally.

NO WARRANTY

11. BECAUSE THE PROGRAM IS LICENSED FREE OF CHARGE, THERE IS NO WARRANTY FOR THE PROGRAM, TO THE EXTENT PERMITTED BY APPLICABLE LAW. EXCEPT WHEN OTHERWISE STATED IN WRITING THE COPYRIGHT HOLDERS AND/OR OTHER PARTIES PROVIDE THE PROGRAM "AS IS" WITHOUT WARRANTY OF ANY KIND, EITHER EXPRESSED OR IMPLIED, INCLUDING, BUT NOT LIMITED TO, THE IMPLIED WARRANTIES OF MERCHANTABILITY AND FITNESS FOR A PARTICULAR PURPOSE. THE ENTIRE RISK AS TO THE QUALITY AND PERFORMANCE OF THE PROGRAM IS WITH YOU. SHOULD THE PROGRAM PROVE DEFECTIVE, YOU ASSUME THE COST OF ALL NECESSARY SERVICING, REPAIR OR CORRECTION.

12. IN NO EVENT UNLESS REQUIRED BY APPLICABLE LAW OR AGREED TO IN WRITING WILL ANY COPYRIGHT HOLDER, OR ANY OTHER PARTY WHO MAY MODIFY AND/OR REDISTRIBUTE THE PROGRAM AS PERMITTED ABOVE, BE LIABLE TO YOU FOR DAMAGES, INCLUDING ANY GENERAL, SPECIAL, INCIDENTAL OR CONSEQUENTIAL DAMAGES ARISING OUT OF THE USE OR INABILITY TO USE THE PROGRAM (INCLUDING BUT NOT LIMITED TO LOSS OF DATA OR DATA BEING RENDERED INACCURATE OR LOSSES SUSTAINED BY YOU OR THIRD PARTIES OR A FAILURE OF THE PROGRAM TO OPERATE WITH ANY OTHER PROGRAMS), EVEN IF SUCH HOLDER OR OTHER PARTY HAS BEEN ADVISED OF THE POSSIBILITY OF SUCH DAMAGES.

END OF TERMS AND CONDITIONS

How to Apply These Terms to Your New Programs

If you develop a new program, and you want it to be of the greatest possible use to the public, the best way to achieve this is to make it free software which everyone can redistribute and change under these terms.

To do so, attach the following notices to the program. It is safest to attach them to the start of each source file to most effectively convey the exclusion of warranty; and each file should have at least the "copyright" line and a pointer to where the full notice is found.

<one line to give the program's name and a brief idea of what it does.> Copyright © <year> <name of author>
This program is free software; you can redistribute it and/or modify it under the terms of the GNU General Public License as published by the Free Software Foundation; either version 2 of the License, or (at your option) any later version.
This program is distributed in the hope that it will be useful, but WITHOUT ANY WARRANTY; without even the implied warranty of MERCHANTABILITY or FITNESS FOR A PARTICULAR PURPOSE. See the GNU General Public License for more details.

You should have received a copy of the GNU General Public License along with this program; if not, write to the Free Software Foundation, Inc., 51 Franklin Street, Fifth Floor, Boston, MA 02110-1301 USA.

Also add information on how to contact you by electronic and paper mail.

If the program is interactive, make it output a short notice like this when it starts in an interactive mode:

Gnomovision version 69, Copyright © year name of author Gnomovision comes with ABSOLUTELY NO WARRANTY; for details type `show w'. This is free software, and you are welcome to redistribute it under certain conditions; type `show c' for details.

The hypothetical commands `show w' and `show c' should show the appropriate parts of the General Public License. Of course, the commands you use may be called something other than `show w' and `show c'; they could even be mouse-clicks or menu items--whatever suits your program.

You should also get your employer (if you work as a programmer) or your school, if any, to sign a "copyright disclaimer" for the program, if necessary. Here is a sample; alter the names:

Yoyodyne, Inc., hereby disclaims all copyright interest in the program `Gnomovision' (which makes passes at compilers) written by James Hacker.

<signature of Ty Coon>, 1 April 1989 Ty Coon, President of Vice

This General Public License does not permit incorporating your program into proprietary programs. If your program is a subroutine library, you may consider it more useful to permit linking proprietary applications with the library. If this is what you want to do, use the GNU Lesser General Public License instead of this License.

GNU LESSER GENERAL PUBLIC LICENSE

Version 2.1, February 1999

Copyright © 1991, 1999 Free Software Foundation, Inc.

51 Franklin St, Fifth Floor, Boston, MA 02110-1301 USA

Everyone is permitted to copy and distribute verbatim copies of this license document, but changing it is not allowed.

[This is the first released version of the Lesser GPL. It also counts as the successor of the GNU Library Public License, version 2, hence the version number 2.1.]

Preamble

The licenses for most software are designed to take away your freedom to share and change it. By contrast, the GNU General Public Licenses are intended to guarantee your freedom to share and change free software--to make sure the software is free for all its users.

This license, the Lesser General Public License, applies to some specially designated software packages--typically libraries--of the Free Software Foundation and other authors who decide to use it. You can use it too, but we suggest you first think carefully about whether this license or the ordinary General Public License is the better strategy to use in any particular case, based on the explanations below.

When we speak of free software, we are referring to freedom of use, not price. Our General Public Licenses are designed to make sure that you have the freedom to distribute copies of free software (and charge for this service if you wish); that you receive source code or can get it if you want it; that you can change the software and use pieces of it in new free programs; and that you are informed that you can do these things.

To protect your rights, we need to make restrictions that forbid distributors to deny you these rights or to ask you to surrender these rights. These restrictions translate to certain responsibilities for you if you distribute copies of the library or if you modify it.

For example, if you distribute copies of the library, whether gratis or for a fee, you must give the recipients all the rights that we gave you. You must make sure that they, too, receive or can get the source code. If you link other code with the library, you must provide complete object files to the recipients, so that they can relink them with the library after making changes to the library and recompiling it. And you must show them these terms so they know their rights.

We protect your rights with a two-step method: (1) we copyright the library, and (2) we offer you this license, which gives you legal permission to copy, distribute and/or modify the library.

To protect each distributor, we want to make it very clear that there is no warranty for the free library. Also, if the library is modified by someone else and passed on, the recipients should know that what they have is not the original version, so that the original author's reputation will not be affected by problems that might be introduced by others.

Finally, software patents pose a constant threat to the existence of any free program. We wish to make sure that a company cannot effectively restrict the users of a free program by obtaining a restrictive license from a patent holder.

Therefore, we insist that any patent license obtained for a version of the library must be consistent with the full freedom of use specified in this license.

Most GNU software, including some libraries, is covered by the ordinary GNU General Public License. This license, the GNU Lesser General Public License, applies to certain designated libraries, and is quite different from the ordinary General Public License. We use this license for certain libraries in order to permit linking those libraries into nonfree programs.

When a program is linked with a library, whether statically or using a shared library, the combination of the two is legally speaking a combined work, a derivative of the original library. The ordinary General Public License therefore permits such linking only if the entire combination fits its criteria of freedom. The Lesser General Public License permits more lax criteria for linking other code with the library.

We call this license the "Lesser" General Public License because it does Less to protect the user's freedom than the ordinary General Public License. It also provides other free software developers Less of an advantage over competing non-free programs. These disadvantages are the reason we use the ordinary General Public License for many libraries. However, the Lesser license provides advantages in certain special circumstances.

For example, on rare occasions, there may be a special need to encourage the widest possible use of a certain library, so that it becomes a de-facto standard. To achieve this, non-free programs must be allowed to use the library. A more frequent case is that a free library does the same job as widely used non-free libraries. In this case, there is little to gain by limiting the free library to free software only, so we use the Lesser General Public License.

In other cases, permission to use a particular library in non-free programs enables a greater number of people to use a large body of free software. For example, permission to use the GNU C Library in non-free programs enables many more people to use the whole GNU operating system, as well as its variant, the GNU/Linux operating system.]

Although the Lesser General Public License is Less protective of the users' freedom, it does ensure that the user of a program that is linked with the Library has the freedom and the wherewithal to run that program using a modified version of the Library.]

The precise terms and conditions for copying, distribution and modification follow. Pay close attention to the difference between a "work based on the library" and a "work that uses the library". The former contains code derived from the library, whereas the latter must be combined with the library in order to run.

TERMS AND CONDITIONS FOR COPYING, DISTRIBUTION AND MODIFICATION

0. This License Agreement applies to any software library or other program which contains a notice placed by the copyright holder or other authorized party saying it may be distributed under the terms of this Lesser General Public License (also called "this License"). Each licensee is addressed as "you". A "library" means a collection of software functions and/or data prepared so as to be conveniently linked with application programs (which use some of those functions and data) to form executables. The "Library", below, refers to any such software library or work which has been distributed under these terms. A "work based on the Library" means either the Library or any derivative work under copyright law: that is to say, a work containing the Library or a portion of it, either verbatim or with modifications and/or translated straightforwardly into another language. (Hereinafter, translation is included without limitation in the term "modification".) "Source code" for a work means the preferred form of the work for making modifications to it. For a library, complete source code means all the source code for all modules it contains, plus any associated interface definition files, plus the scripts used to control compilation and installation of the library. Activities other than copying, distribution and modification are not covered by this License; they are outside its scope. The act of running a program using the Library is not restricted, and output from such a program is covered only if its contents constitute a work based on the Library (independent of the use of the Library in a tool for writing it). Whether that is true depends on what the Library does and what the program that uses the Library does.

1. You may copy and distribute verbatim copies of the Library's complete source code as you receive it, in any medium, provided that you conspicuously and appropriately publish on each copy an appropriate copyright notice and disclaimer of warranty; keep intact all the notices that refer to this License and to the absence of any warranty; and distribute a copy of this License along with the Library. You may charge a fee for the physical act of transferring a copy, and you may at your option offer warranty protection in exchange for a fee.

2. You may modify your copy or copies of the Library or any portion of it, thus forming a work based on the Library, and copy and distribute such modifications or work under the terms of Section 1 above, provided that you also meet all of these conditions:

a) The modified work must itself be a software library.

b) You must cause the files modified to carry prominent notices stating that you changed the files and the date of any change.

c) You must cause the whole of the work to be licensed at no charge to all third parties under the terms of this License.

d) If a facility in the modified Library refers to a function or a table of data to be supplied by an application program that uses the facility, other than as an argument passed when the facility is invoked, then you must make a good faith effort to ensure that, in the event an application does not supply such function or table, the facility still operates, and performs whatever part of its purpose remains meaningful. (For example, a function in a library to compute square roots has a purpose that is entirely well-defined independent of the application. Therefore, Subsection 2d requires that any

application-supplied function or table used by this function must be optional: if the application does not supply it, the square root function must still compute square roots.) These requirements apply to the modified work as a whole. If identifiable sections of that work are not derived from the Library, and can be reasonably considered independent and separate works in themselves, then this License, and its terms, do not apply to those sections when you distribute them as separate works. But when you distribute the same sections as part of a whole which is a work based on the Library, the distribution of the whole must be on the terms of this License, whose permissions for other licensees extend to the entire whole, and thus to each and every part regardless of who wrote it. Thus, it is not the intent of this section to claim rights or contest your rights to work written entirely by you; rather, the intent is to exercise the right to control the distribution of derivative or collective works based on the Library. In addition, mere aggregation of another work not based on the Library with the Library (or with a work based on the Library) on a volume of a storage or distribution medium does not bring the other work under the scope of this License.

3. You may opt to apply the terms of the ordinary GNU General Public License instead of this License to a given copy of the Library. To do this, you must alter all the notices that refer to this License, so that they refer to the ordinary GNU General Public License, version 2, instead of to this License. (If a newer version than version 2 of the ordinary GNU General Public License has appeared, then you can specify that version instead if you wish.) Do not make any other change in these notices. Once this change is made in a given copy, it is irreversible for that copy, so the ordinary GNU General Public License applies to all subsequent copies and derivative works made from that copy. This option is useful when you wish to copy part of the code of the Library into a program that is not a library.

4. You may copy and distribute the Library (or a portion or derivative of it, under Section 2) in object code or executable form under the terms of Sections 1 and 2 above provided that you accompany it with the complete corresponding machine-readable source code, which must be distributed under the terms of Sections 1 and 2 above on a medium customarily used for software interchange. If distribution of object code is made by offering access to copy from a designated place, then offering equivalent access to copy the source code from the same place satisfies the requirement to distribute the source code, even though third parties are not compelled to copy the source along with the object code.

5. A program that contains no derivative of any portion of the Library, but is designed to work with the Library by being compiled or linked with it, is called a "work that uses the Library". Such a work, in isolation, is not a derivative work of the Library, and therefore falls outside the scope of this License. However, linking a "work that uses the Library" with the Library creates an executable that is a derivative of the Library (because it contains portions of the Library), rather than a "work that uses the library". The executable is therefore covered by this License. Section 6 states terms for distribution of such executables. When a "work that uses the Library" uses material from a header file that is part of the Library, the object code for the work may be a derivative work of the Library even though the source code is not. Whether this is true is especially significant if the work can be linked without the Library, or if the work is itself a library. The threshold for this to be true is not precisely defined by law. If such an object file uses only numerical parameters, data structure layouts and accessors, and small macros and small inline functions (ten lines or less in length), then the use of the object file is unrestricted, regardless of whether it is legally a derivative work. (Executables containing this object code plus portions of the Library will still fall under Section 6.) Otherwise, if the work is a derivative of the Library, you may distribute the object code for the work under the terms of Section 6. Any executables containing that work also fall under Section 6, whether or not they are linked directly with the Library itself.

6. As an exception to the Sections above, you may also combine or link a "work that uses the Library" with the Library to produce a work containing portions of the Library, and distribute that work under terms of your choice, provided that the terms permit modification of the work for the customer's own use and reverse engineering for debugging such modifications. You must give prominent notice with each copy of the work that the Library is used in it and that the Library and its use are covered by this License. You must supply a copy of this License. If the work during execution displays copyright notices, you must include the copyright notice for the Library among them, as well as a reference directing the user to the copy of this License. Also, you must do one of these things:

a) Accompany the work with the complete corresponding machine-readable source code for the Library including whatever changes were used in the work (which must be distributed under Sections 1 and 2 above); and, if the work is an executable linked with the Library, with the complete machine-readable "work that uses the Library", as object code and/or source code, so that the user can modify the Library and then relink to produce a modified executable containing the modified Library. (It is understood that the user who changes the contents of definitions files in the Library will not necessarily be able to recompile the application to use the modified definitions.)

b) Use a suitable shared library mechanism for linking with the Library. A suitable mechanism is one that (1) uses at run time a copy of the library already present on the user's computer system, rather than copying library functions into the executable, and (2) will operate properly with a modified version of the library, if the user installs one, as long as the modified version is interface-compatible with the version that the work was made with.

c) Accompany the work with a written offer, valid for at least three years, to give the same user the materials specified in Subsection 6a, above, for a charge no more than the cost of performing this distribution.

d) If distribution of the work is made by offering access to copy from a designated place, offer equivalent access to copy the above specified materials from the same place.

e) Verify that the user has already received a copy of these materials or that you have already sent this user a copy. For an executable, the required form of the "work that uses the Library" must include any data and utility programs needed

for reproducing the executable from it. However, as a special exception, the materials to be distributed need not include anything that is normally distributed (in either source or binary form) with the major components (compiler, kernel, and so on) of the operating system on which the executable runs, unless that component itself accompanies the executable. It may happen that this requirement contradicts the license restrictions of other proprietary libraries that do not normally accompany the operating system. Such a contradiction means you cannot use both them and the Library together in an executable that you distribute.

7. You may place library facilities that are a work based on the Library side-by-side in a single library together with other library facilities not covered by this License, and distribute such a combined library, provided that the separate distribution of the work based on the Library and of the other library facilities is otherwise permitted, and provided that you do these two things:

- a) Accompany the combined library with a copy of the same work based on the Library, uncombined with any other library facilities. This must be distributed under the terms of the Sections above.
- b) Give prominent notice with the combined library of the fact that part of it is a work based on the Library, and explaining where to find the accompanying uncombined form of the same work.

8. You may not copy, modify, sublicense, link with, or distribute the Library except as expressly provided under this License. Any attempt otherwise to copy, modify, sublicense, link with, or distribute the Library is void, and will automatically terminate your rights under this License. However, parties who have received copies, or rights, from you under this License will not have their licenses terminated so long as such parties remain in full compliance.

9. You are not required to accept this License, since you have not signed it. However, nothing else grants you permission to modify or distribute the Library or its derivative works. These actions are prohibited by law if you do not accept this License. Therefore, by modifying or distributing the Library (or any work based on the Library), you indicate your acceptance of this License to do so, and all its terms and conditions for copying, distributing or modifying the Library or works based on it.

10. Each time you redistribute the Library (or any work based on the Library), the recipient automatically receives a license from the original licensor to copy, distribute, link with or modify the Library subject to these terms and conditions. You may not impose any further restrictions on the recipients' exercise of the rights granted herein. You are not responsible for enforcing compliance by third parties with this License.

11. If, as a consequence of a court judgment or allegation of patent infringement or for any other reason (not limited to patent issues), conditions are imposed on you (whether by court order, agreement or otherwise) that contradict the conditions of this License, they do not excuse you from the conditions of this License. If you cannot distribute so as to satisfy simultaneously your obligations under this License and any other pertinent obligations, then as a consequence you may not distribute the Library at all. For example, if a patent license would not permit royalty-free redistribution of the Library by all those who receive copies directly or indirectly through you, then the only way you could satisfy both it and this License would be to refrain entirely from distribution of the Library. If any portion of this section is held invalid or unenforceable under any particular circumstance, the balance of the section is intended to apply, and the section as a whole is intended to apply in other circumstances. It is not the purpose of this section to induce you to infringe any patents or other property right claims or to contest validity of any such claims; this section has the sole purpose of protecting the integrity of the free software distribution system which is implemented by public license practices. Many people have made generous contributions to the wide range of software distributed through that system in reliance on consistent application of that system; it is up to the author/donor to decide if he or she is willing to distribute software through any other system and a licensee cannot impose that choice. This section is intended to make thoroughly clear what is believed to be a consequence of the rest of this License.

12. If the distribution and/or use of the Library is restricted in certain countries either by patents or by copyrighted interfaces, the original copyright holder who places the Library under this License may add an explicit geographical distribution limitation excluding those countries, so that distribution is permitted only in or among countries not thus excluded. In such case, this License incorporates the limitation as if written in the body of this License.

13. The Free Software Foundation may publish revised and/or new versions of the Lesser General Public License from time to time. Such new versions will be similar in spirit to the present version, but may differ in detail to address new problems or concerns. Each version is given a distinguishing version number. If the Library specifies a version number of this License which applies to it and "any later version", you have the option of following the terms and conditions either of that version or of any later version published by the Free Software Foundation. If the Library does not specify a license version number, you may choose any version ever published by the Free Software Foundation.

14. If you wish to incorporate parts of the Library into other free programs whose distribution conditions are incompatible with these, write to the author to ask for permission. For software which is copyrighted by the Free Software Foundation, write to the Free Software Foundation; we sometimes make exceptions for this. Our decision will be guided by the two goals of preserving the free status of all derivatives of our free software and of promoting the sharing and reuse of software generally.

NO WARRANTY

15. BECAUSE THE LIBRARY IS LICENSED FREE OF CHARGE, THERE IS NO WARRANTY FOR THE LIBRARY, TO THE EXTENT PERMITTED BY APPLICABLE LAW. EXCEPT WHEN OTHERWISE STATED IN WRITING THE

COPYRIGHT HOLDERS AND/OR OTHER PARTIES PROVIDE THE LIBRARY "AS IS" WITHOUT WARRANTY OF ANY KIND, EITHER EXPRESSED OR IMPLIED, INCLUDING, BUT NOT LIMITED TO, THE IMPLIED WARRANTIES OF MERCHANTABILITY AND FITNESS FOR A PARTICULAR PURPOSE. THE ENTIRE RISK AS TO THE QUALITY AND PERFORMANCE OF THE LIBRARY IS WITH YOU. SHOULD THE LIBRARY PROVE DEFECTIVE, YOU ASSUME THE COST OF ALL NECESSARY SERVICING, REPAIR OR CORRECTION.

16. IN NO EVENT UNLESS REQUIRED BY APPLICABLE LAW OR AGREED TO IN WRITING WILL ANY COPYRIGHT HOLDER, OR ANY OTHER PARTY WHO MAY MODIFY AND/OR REDISTRIBUTE THE LIBRARY AS PERMITTED ABOVE, BE LIABLE TO YOU FOR DAMAGES, INCLUDING ANY GENERAL, SPECIAL, INCIDENTAL OR CONSEQUENTIAL DAMAGES ARISING OUT OF THE USE OR INABILITY TO USE THE LIBRARY (INCLUDING BUT NOT LIMITED TO LOSS OF DATA OR DATA BEING RENDERED INACCURATE OR LOSSES SUSTAINED BY YOU OR THIRD PARTIES OR A FAILURE OF THE LIBRARY TO OPERATE WITH ANY OTHER SOFTWARE), EVEN IF SUCH HOLDER OR OTHER PARTY HAS BEEN ADVISED OF THE POSSIBILITY OF SUCH DAMAGES.

END OF TERMS AND CONDITIONS

How to Apply These Terms to Your New Libraries

If you develop a new library, and you want it to be of the greatest possible use to the public, we recommend making it free software that everyone can redistribute and change. You can do so by permitting redistribution under these terms (or, alternatively, under the terms of the ordinary General Public License).

To apply these terms, attach the following notices to the library. It is safest to attach them to the start of each source file to most effectively convey the exclusion of warranty; and each file should have at least the "copyright" line and a pointer to where the full notice is found.

<one line to give the library's name and a brief idea of what it does.>

Copyright © <year> <name of author>

This library is free software; you can redistribute it and/or modify it under the terms of the GNU Lesser General Public License as published by the Free Software Foundation; either version 2.1 of the License, or (at your option) any later version.

This library is distributed in the hope that it will be useful, but WITHOUT ANY WARRANTY; without even the implied warranty of MERCHANTABILITY or FITNESS FOR A PARTICULAR PURPOSE. See the GNU Lesser General Public License for more details.

You should have received a copy of the GNU Lesser General Public License along with this library; if not, write to the Free Software Foundation, Inc., 51 Franklin St, Fifth Floor, Boston, MA 02110-1301 USA

Also add information on how to contact you by electronic and paper mail.

You should also get your employer (if you work as a programmer) or your school, if any, to sign a "copyright disclaimer" for the library, if necessary. Here is a sample; alter the names:

Yoyodyne, Inc., hereby disclaims all copyright interest in the library `Frob' (a library for tweaking knobs) written by James Random Hacker.

<signature of Ty Coon>, 1 April 1990 Ty Coon, President of Vice

That's all there is to it!

Data Projector
VPL-PHZ60/PHZ50

Other Software

This product includes the following software.
Please refrain from contacting us regarding the contents of the source code.

Boot

Boost Software License - Version 1.0 - August 17th, 2003

Permission is hereby granted, free of charge, to any person or organization obtaining a copy of the software and accompanying documentation covered by this license (the "Software") to use, reproduce, display, distribute, execute, and transmit the Software, and to prepare derivative works of the Software, and to permit third-parties to whom the Software is furnished to do so, all subject to the following:

The copyright notices in the Software and this entire statement, including the above license grant, this restriction and the following disclaimer, must be included in all copies of the Software, in whole or in part, and all derivative works of the Software, unless such copies or derivative works are solely in the form of machine-executable object code generated by a source language processor.

THE SOFTWARE IS PROVIDED "AS IS", WITHOUT WARRANTY OF ANY KIND, EXPRESS OR IMPLIED, INCLUDING BUT NOT LIMITED TO THE WARRANTIES OF MERCHANTABILITY, FITNESS FOR A PARTICULAR PURPOSE, TITLE AND NON-INFRINGEMENT. IN NO EVENT SHALL THE COPYRIGHT HOLDERS OR ANYONE DISTRIBUTING THE SOFTWARE BE LIABLE FOR ANY DAMAGES OR OTHER LIABILITY, WHETHER IN CONTRACT, TORT OR OTHERWISE, ARISING FROM, OUT OF OR IN CONNECTION WITH THE SOFTWARE OR THE USE OR OTHER DEALINGS IN THE SOFTWARE.

civetweb-1.11

Civetweb License

Included with all features.

Copyright (c) 2013-2018 The CivetWeb developers ([CREDITS.md]
(<https://github.com/civetweb/civetweb/blob/master/CREDITS.md>))

Copyright (c) 2004-2013 Sergey Lyubka

Copyright (c) 2013 No Face Press, LLC (Thomas Davis)

Copyright (c) 2013 F-Secure Corporation

Permission is hereby granted, free of charge, to any person obtaining a copy of this software and associated documentation files (the "Software"), to deal in the Software without restriction, including without limitation the rights to use, copy, modify, merge, publish, distribute, sublicense, and/or sell copies of the Software, and to permit persons to whom the Software is furnished to do so, subject to the following conditions:

The above copyright notice and this permission notice shall be included in

all copies or substantial portions of the Software.

THE SOFTWARE IS PROVIDED "AS IS", WITHOUT WARRANTY OF ANY KIND, EXPRESS OR IMPLIED, INCLUDING BUT NOT LIMITED TO THE WARRANTIES OF MERCHANTABILITY, FITNESS FOR A PARTICULAR PURPOSE AND NONINFRINGEMENT. IN NO EVENT SHALL THE AUTHORS OR COPYRIGHT HOLDERS BE LIABLE FOR ANY CLAIM, DAMAGES OR OTHER LIABILITY, WHETHER IN AN ACTION OF CONTRACT, TORT OR OTHERWISE, ARISING FROM, OUT OF OR IN CONNECTION WITH THE SOFTWARE OR THE USE OR OTHER DEALINGS IN THE SOFTWARE.

jpeg-lib-6b

this software is based in part on the work of the Independent JPEG Group

jwt-cpp

MIT License

Copyright (c) 2018 Dominik Thalhammer

Permission is hereby granted, free of charge, to any person obtaining a copy of this software and associated documentation files (the "Software"), to deal in the Software without restriction, including without limitation the rights to use, copy, modify, merge, publish, distribute, sublicense, and/or sell copies of the Software, and to permit persons to whom the Software is furnished to do so, subject to the following conditions:

The above copyright notice and this permission notice shall be included in all copies or substantial portions of the Software.

THE SOFTWARE IS PROVIDED "AS IS", WITHOUT WARRANTY OF ANY KIND, EXPRESS OR IMPLIED, INCLUDING BUT NOT LIMITED TO THE WARRANTIES OF MERCHANTABILITY, FITNESS FOR A PARTICULAR PURPOSE AND NONINFRINGEMENT. IN NO EVENT SHALL THE AUTHORS OR COPYRIGHT HOLDERS BE LIABLE FOR ANY CLAIM, DAMAGES OR OTHER LIABILITY, WHETHER IN AN ACTION OF CONTRACT, TORT OR OTHERWISE, ARISING FROM, OUT OF OR IN CONNECTION WITH THE SOFTWARE OR THE USE OR OTHER DEALINGS IN THE SOFTWARE.

openssl 1.0.2t

LICENSE ISSUES

=====

The OpenSSL toolkit stays under a double license, i.e. both the conditions of the OpenSSL License and the original SSLeay license apply to the toolkit. See below for the actual license texts. Actually both licenses are BSD-style Open Source licenses. In case of any license issues related to OpenSSL please contact openssl-core@openssl.org.

OpenSSL License

=====

Copyright (c) 1998-2018 The OpenSSL Project. All rights reserved.

Redistribution and use in source and binary forms, with or without modification, are permitted provided that the following conditions are met:

1. Redistributions of source code must retain the above copyright notice, this list of conditions and the following disclaimer.

2. Redistributions in binary form must reproduce the above copyright notice, this list of conditions and the following disclaimer in the documentation and/or other materials provided with the distribution.

3. All advertising materials mentioning features or use of this software must display the following acknowledgment:
"This product includes software developed by the OpenSSL Project for use in the OpenSSL Toolkit. (<http://www.openssl.org/>)"

4. The names "OpenSSL Toolkit" and "OpenSSL Project" must not be used to endorse or promote products derived from this software without prior written permission. For written permission, please contact openssl-core@openssl.org.

5. Products derived from this software may not be called "OpenSSL" nor may "OpenSSL" appear in their names without prior written permission of the OpenSSL Project.

6. Redistributions of any form whatsoever must retain the following acknowledgment:
"This product includes software developed by the OpenSSL Project for use in the OpenSSL Toolkit (<http://www.openssl.org/>)"

THIS SOFTWARE IS PROVIDED BY THE OpenSSL PROJECT ``AS IS" AND ANY EXPRESSED OR IMPLIED WARRANTIES, INCLUDING, BUT NOT LIMITED TO, THE IMPLIED WARRANTIES OF MERCHANTABILITY AND FITNESS FOR A PARTICULAR PURPOSE ARE DISCLAIMED. IN NO EVENT SHALL THE OpenSSL PROJECT OR ITS CONTRIBUTORS BE LIABLE FOR ANY DIRECT, INDIRECT, INCIDENTAL, SPECIAL, EXEMPLARY, OR CONSEQUENTIAL DAMAGES (INCLUDING, BUT NOT LIMITED TO, PROCUREMENT OF SUBSTITUTE GOODS OR SERVICES; LOSS OF USE, DATA, OR PROFITS; OR BUSINESS INTERRUPTION) HOWEVER CAUSED AND ON ANY THEORY OF LIABILITY, WHETHER IN CONTRACT, STRICT LIABILITY, OR TORT (INCLUDING NEGLIGENCE OR OTHERWISE) ARISING IN ANY WAY OUT OF THE USE OF THIS SOFTWARE, EVEN IF ADVISED OF THE POSSIBILITY OF SUCH DAMAGE.

=====

This product includes cryptographic software written by Eric Young (eay@cryptsoft.com). This product includes software written by Tim Hudson (tjh@cryptsoft.com).

Original SSLeay License

Copyright (C) 1995-1998 Eric Young (eay@cryptsoft.com)
All rights reserved.

This package is an SSL implementation written by Eric Young (eay@cryptsoft.com).
The implementation was written so as to conform with Netscapes SSL.

This library is free for commercial and non-commercial use as long as the following conditions are aheared to. The following conditions apply to all code found in this distribution, be it the RC4, RSA, lhash, DES, etc., code; not just the SSL code. The SSL documentation

included with this distribution is covered by the same copyright terms except that the holder is Tim Hudson (tjh@cryptsoft.com).

Copyright remains Eric Young's, and as such any Copyright notices in the code are not to be removed.

If this package is used in a product, Eric Young should be given attribution as the author of the parts of the library used.

This can be in the form of a textual message at program startup or in documentation (online or textual) provided with the package.

Redistribution and use in source and binary forms, with or without modification, are permitted provided that the following conditions are met:

1. Redistributions of source code must retain the copyright notice, this list of conditions and the following disclaimer.
2. Redistributions in binary form must reproduce the above copyright notice, this list of conditions and the following disclaimer in the documentation and/or other materials provided with the distribution.
3. All advertising materials mentioning features or use of this software must display the following acknowledgement:

"This product includes cryptographic software written by Eric Young (eay@cryptsoft.com)"

The word 'cryptographic' can be left out if the routines from the library being used are not cryptographic related :-).

4. If you include any Windows specific code (or a derivative thereof) from the apps directory (application code) you must include an acknowledgement: "This product includes software written by Tim Hudson (tjh@cryptsoft.com)"

THIS SOFTWARE IS PROVIDED BY ERIC YOUNG ``AS IS'' AND ANY EXPRESS OR IMPLIED WARRANTIES, INCLUDING, BUT NOT LIMITED TO, THE IMPLIED WARRANTIES OF MERCHANTABILITY AND FITNESS FOR A PARTICULAR PURPOSE ARE DISCLAIMED. IN NO EVENT SHALL THE AUTHOR OR CONTRIBUTORS BE LIABLE FOR ANY DIRECT, INDIRECT, INCIDENTAL, SPECIAL, EXEMPLARY, OR CONSEQUENTIAL DAMAGES (INCLUDING, BUT NOT LIMITED TO, PROCUREMENT OF SUBSTITUTE GOODS OR SERVICES; LOSS OF USE, DATA, OR PROFITS; OR BUSINESS INTERRUPTION) HOWEVER CAUSED AND ON ANY THEORY OF LIABILITY, WHETHER IN CONTRACT, STRICT LIABILITY, OR TORT (INCLUDING NEGLIGENCE OR OTHERWISE) ARISING IN ANY WAY OUT OF THE USE OF THIS SOFTWARE, EVEN IF ADVISED OF THE POSSIBILITY OF SUCH DAMAGE.

The licence and distribution terms for any publically available version or derivative of this code cannot be changed. i.e. this code cannot simply be copied and put under another distribution licence [including the GNU Public Licence.]

7-Zip source code

License for use and distribution

7-Zip Copyright (C) 1999-2016 Igor Pavlov.

Licenses for files are:

- 1) CPP/7zip/Compress/Rar* files: GNU LGPL + unRAR restriction
- 2) All other files: GNU LGPL

The GNU LGPL + unRAR restriction means that you must follow both GNU LGPL rules and unRAR restriction rules.

GNU LGPL information

This library is free software; you can redistribute it and/or modify it under the terms of the GNU Lesser General Public License as published by the Free Software Foundation; either version 2.1 of the License, or (at your option) any later version.

This library is distributed in the hope that it will be useful, but WITHOUT ANY WARRANTY; without even the implied warranty of MERCHANTABILITY or FITNESS FOR A PARTICULAR PURPOSE. See the GNU Lesser General Public License for more details.

You should have received a copy of the GNU Lesser General Public License along with this library; if not, write to the Free Software Foundation, Inc., 51 Franklin Street, Fifth Floor, Boston, MA 02110-1301 USA

unRAR restriction

The decompression engine for RAR archives was developed using source code of unRAR program.
All copyrights to original unRAR code are owned by Alexander Roshal.

The license for original unRAR code has the following restriction:

The unRAR sources cannot be used to re-create the RAR compression algorithm, which is proprietary. Distribution of modified unRAR sources in separate form or as a part of other software is permitted, provided that it is clearly stated in the documentation and source comments that the code may not be used to develop a RAR (WinRAR) compatible archiver.

--
Igor Pavlov

zlib-1.2.7
ZLIB DATA COMPRESSION LIBRARY

zlib 1.2.7 is a general purpose data compression library. All the code is thread safe. The data format used by the zlib library is described by RFCs (Request for Comments) 1950 to 1952 in the files <http://tools.ietf.org/html/rfc1950> (zlib format), rfc1951 (deflate format) and rfc1952 (gzip format).

All functions of the compression library are documented in the file `zlib.h` (volunteer to write man pages welcome, contact zlib@gzip.org). A usage example of the library is given in the file `test/example.c` which also tests that the library is working correctly. Another example is given in the file `test/minigzip.c`. The compression library itself is composed of all source files in the root directory.

To compile all files and run the test program, follow the instructions given at the top of `Makefile.in`. In short `./configure; make test`, and if that goes well, `make install` should work for most flavors of Unix. For Windows, use one of the special makefiles in `win32/` or `contrib/vstudio/`. For VMS, use `make_vms.com`.

Questions about zlib should be sent to [<zlib@gzip.org>](mailto:zlib@gzip.org), or to Gilles Vollant [<info@winimage.com>](mailto:info@winimage.com) for the Windows DLL version. The zlib home page is

<http://zlib.net/> . Before reporting a problem, please check this site to verify that you have the latest version of zlib; otherwise get the latest version and check whether the problem still exists or not.

PLEASE read the zlib FAQ http://zlib.net/zlib_faq.html before asking for help.

Mark Nelson <markn@ieee.org> wrote an article about zlib for the Jan. 1997 issue of Dr. Dobbs's Journal; a copy of the article is available at <http://marknelson.us/1997/01/01/zlib-engine/> .

The changes made in version 1.2.7 are documented in the file ChangeLog.

Unsupported third party contributions are provided in directory contrib/ .

zlib is available in Java using the `java.util.zip` package, documented at <http://java.sun.com/developer/technicalArticles/Programming/compression/> .

A Perl interface to zlib written by Paul Marquess <pmqs@cpan.org> is available at CPAN (Comprehensive Perl Archive Network) sites, including <http://search.cpan.org/~pmqs/IO-Compress-Zlib/> .

A Python interface to zlib written by A.M. Kuchling <amk@amk.ca> is available in Python 1.5 and later versions, see <http://docs.python.org/library/zlib.html> .

zlib is built into tcl: <http://wiki.tcl.tk/4610> .

An experimental package to read and write files in .zip format, written on top of zlib by Gilles Vollant <info@winimage.com>, is available in the contrib/minizip directory of zlib.

Notes for some targets:

- For Windows DLL versions, please see `win32/DLL_FAQ.txt`
- For 64-bit Irix, `deflate.c` must be compiled without any optimization. With `-O`, one `libpng` test fails. The test works in 32 bit mode (with the `-n32` compiler flag). The compiler bug has been reported to SGI.
- zlib doesn't work with gcc 2.6.3 on a DEC 3000/300LX under OSF/1 2.1 it works when compiled with `cc`.
- On Digital Unix 4.0D (formerly OSF/1) on AlphaServer, the `cc` option `-std1` is necessary to get `gzprintf` working correctly. This is done by `configure`.
- zlib doesn't work on HP-UX 9.05 with some versions of `/bin/cc`. It works with other compilers. Use "make test" to check your compiler.
- `gzdopen` is not supported on RISCOS or BEOS.
- For PalmOs, see <http://palmzlib.sourceforge.net/>

Acknowledgments:

The deflate format used by zlib was defined by Phil Katz. The deflate and zlib specifications were written by L. Peter Deutsch. Thanks to all the people who reported problems and suggested various improvements in zlib; they are too numerous to cite here.

Copyright notice:

(C) 1995-2012 Jean-loup Gailly and Mark Adler

This software is provided 'as-is', without any express or implied warranty. In no event will the authors be held liable for any damages arising from the use of this software.

Permission is granted to anyone to use this software for any purpose, including commercial applications, and to alter it and redistribute it freely, subject to the following restrictions:

1. The origin of this software must not be misrepresented; you must not claim that you wrote the original software. If you use this software in a product, an acknowledgment in the product documentation would be appreciated but is not required.
2. Altered source versions must be plainly marked as such, and must not be misrepresented as being the original software.
3. This notice may not be removed or altered from any source distribution.

Jean-loup Gailly Mark Adler
jloup@gzip.org madler@alumni.caltech.edu

If you use the zlib library in a product, we would appreciate *not* receiving lengthy legal documents to sign. The sources are provided for free but without warranty of any kind. The library has been entirely written by Jean-loup Gailly and Mark Adler; it does not include third-party code.

If you redistribute modified sources, we would appreciate that you include in the file ChangeLog history information documenting your changes. Please read the FAQ for more information on the distribution of modified source versions.

Net-SNMP

License

Various copyrights apply to this package, listed in various separate parts below. Please make sure that you read all the parts.

---- Part 1: CMU/UCD copyright notice: (BSD like) ----

Copyright 1989, 1991, 1992 by Carnegie Mellon University

Derivative Work - 1996, 1998-2000

Copyright 1996, 1998-2000 The Regents of the University of California

All Rights Reserved

Permission to use, copy, modify and distribute this software and its documentation for any purpose and without fee is hereby granted, provided that the above copyright notice appears in all copies and that both that copyright notice and this permission notice appear in supporting documentation, and that the name of CMU and The Regents of the University of California not be used in advertising or publicity pertaining to distribution of the software without specific written permission.

CMU AND THE REGENTS OF THE UNIVERSITY OF CALIFORNIA DISCLAIM ALL WARRANTIES WITH REGARD TO THIS SOFTWARE, INCLUDING ALL IMPLIED WARRANTIES OF MERCHANTABILITY AND FITNESS. IN NO EVENT SHALL CMU OR THE REGENTS OF THE UNIVERSITY OF CALIFORNIA BE LIABLE FOR ANY SPECIAL, INDIRECT OR CONSEQUENTIAL DAMAGES OR ANY DAMAGES WHATSOEVER RESULTING FROM THE LOSS OF USE, DATA OR PROFITS, WHETHER IN AN ACTION OF CONTRACT, NEGLIGENCE OR OTHER TORTIOUS ACTION, ARISING OUT OF OR IN CONNECTION WITH THE USE OR PERFORMANCE OF THIS SOFTWARE.

---- Part 2: Networks Associates Technology, Inc copyright notice (BSD) ----

Copyright (c) 2001-2003, Networks Associates Technology, Inc

All rights reserved.

Redistribution and use in source and binary forms, with or without modification, are permitted provided that the following conditions are met:

* Redistributions of source code must retain the above copyright notice, this list of conditions and the following disclaimer.

* Redistributions in binary form must reproduce the above copyright notice, this list of conditions and the following disclaimer in the documentation and/or other materials provided with the distribution.

* Neither the name of the Networks Associates Technology, Inc nor the names of its contributors may be used to endorse or promote products derived from this software without specific prior written permission.

THIS SOFTWARE IS PROVIDED BY THE COPYRIGHT HOLDERS AND CONTRIBUTORS "AS IS" AND ANY EXPRESS OR IMPLIED WARRANTIES, INCLUDING, BUT NOT LIMITED TO, THE IMPLIED WARRANTIES OF MERCHANTABILITY AND FITNESS FOR A PARTICULAR PURPOSE ARE DISCLAIMED. IN NO EVENT SHALL THE COPYRIGHT HOLDERS OR CONTRIBUTORS BE LIABLE FOR ANY DIRECT, INDIRECT, INCIDENTAL, SPECIAL, EXEMPLARY, OR CONSEQUENTIAL DAMAGES (INCLUDING, BUT NOT LIMITED TO, PROCUREMENT OF SUBSTITUTE GOODS OR SERVICES; LOSS OF USE, DATA, OR PROFITS; OR BUSINESS INTERRUPTION) HOWEVER CAUSED AND ON ANY THEORY OF LIABILITY, WHETHER IN CONTRACT, STRICT LIABILITY, OR TORT (INCLUDING NEGLIGENCE OR OTHERWISE) ARISING IN ANY WAY OUT OF THE USE OF THIS SOFTWARE, EVEN IF ADVISED OF THE POSSIBILITY OF SUCH DAMAGE.

---- Part 3: Cambridge Broadband Ltd. copyright notice (BSD) ----

Portions of this code are copyright (c) 2001-2003, Cambridge Broadband Ltd. All rights reserved.

Redistribution and use in source and binary forms, with or without modification, are permitted provided that the following conditions are met:

* Redistributions of source code must retain the above copyright notice, this list of conditions and the following disclaimer.

* Redistributions in binary form must reproduce the above copyright notice, this list of conditions and the following disclaimer in the documentation and/or other materials provided with the distribution.

* The name of Cambridge Broadband Ltd. may not be used to endorse or promote products derived from this software without specific prior written permission.

THIS SOFTWARE IS PROVIDED BY THE COPYRIGHT HOLDER "AS IS" AND ANY EXPRESS OR IMPLIED WARRANTIES, INCLUDING, BUT NOT LIMITED TO, THE IMPLIED WARRANTIES OF MERCHANTABILITY AND FITNESS FOR A PARTICULAR PURPOSE ARE DISCLAIMED. IN NO EVENT SHALL THE COPYRIGHT HOLDER BE LIABLE FOR ANY DIRECT, INDIRECT, INCIDENTAL, SPECIAL, EXEMPLARY, OR CONSEQUENTIAL DAMAGES (INCLUDING, BUT NOT LIMITED TO, PROCUREMENT OF SUBSTITUTE GOODS OR SERVICES; LOSS OF USE, DATA, OR PROFITS; OR BUSINESS INTERRUPTION) HOWEVER CAUSED AND ON ANY THEORY OF LIABILITY, WHETHER IN CONTRACT, STRICT LIABILITY, OR TORT (INCLUDING NEGLIGENCE OR OTHERWISE) ARISING IN ANY WAY OUT OF THE USE OF THIS SOFTWARE, EVEN IF ADVISED OF THE POSSIBILITY OF SUCH DAMAGE.

---- Part 4: Sun Microsystems, Inc. copyright notice (BSD) ----

Copyright (c) 2003 Sun Microsystems, Inc., 4150 Network Circle, Santa Clara, California 95054, U.S.A. All rights reserved.

Use is subject to license terms below.

This distribution may include materials developed by third parties.

Sun, Sun Microsystems, the Sun logo and Solaris are trademarks or registered trademarks of Sun Microsystems, Inc. in the U.S. and other countries.

Redistribution and use in source and binary forms, with or without modification, are permitted provided that the following conditions are met:

* Redistributions of source code must retain the above copyright notice, this list of conditions and the following disclaimer.

* Redistributions in binary form must reproduce the above copyright notice, this list of conditions and the following disclaimer in the documentation and/or other materials provided with the distribution.

* Neither the name of the Sun Microsystems, Inc. nor the names of its contributors may be used to endorse or promote products derived from this software without specific prior written permission.

THIS SOFTWARE IS PROVIDED BY THE COPYRIGHT HOLDERS AND CONTRIBUTORS "AS IS" AND ANY EXPRESS OR IMPLIED WARRANTIES, INCLUDING, BUT NOT LIMITED TO, THE IMPLIED WARRANTIES OF MERCHANTABILITY AND FITNESS FOR A PARTICULAR PURPOSE ARE DISCLAIMED. IN NO EVENT SHALL THE COPYRIGHT HOLDERS OR CONTRIBUTORS BE LIABLE FOR ANY DIRECT, INDIRECT, INCIDENTAL, SPECIAL, EXEMPLARY, OR CONSEQUENTIAL DAMAGES (INCLUDING, BUT NOT LIMITED TO, PROCUREMENT OF SUBSTITUTE GOODS OR SERVICES; LOSS OF USE, DATA, OR PROFITS; OR BUSINESS INTERRUPTION) HOWEVER CAUSED AND ON ANY THEORY OF LIABILITY, WHETHER IN CONTRACT, STRICT LIABILITY, OR TORT (INCLUDING NEGLIGENCE OR OTHERWISE) ARISING IN ANY WAY OUT OF THE USE OF THIS SOFTWARE, EVEN IF ADVISED OF THE POSSIBILITY OF SUCH DAMAGE.

---- Part 5: Sparta, Inc copyright notice (BSD) ----

Copyright (c) 2003-2013, Sparta, Inc

All rights reserved.

Redistribution and use in source and binary forms, with or without modification, are permitted provided that the following conditions are met:

* Redistributions of source code must retain the above copyright notice, this list of conditions and the following disclaimer.

* Redistributions in binary form must reproduce the above copyright notice, this list of conditions and the following disclaimer in the documentation and/or other materials provided with the distribution.

* Neither the name of Sparta, Inc nor the names of its contributors may be used to endorse or promote products derived from this software without specific prior written permission.

THIS SOFTWARE IS PROVIDED BY THE COPYRIGHT HOLDERS AND CONTRIBUTORS "AS IS" AND ANY EXPRESS OR IMPLIED WARRANTIES, INCLUDING, BUT NOT LIMITED TO, THE IMPLIED WARRANTIES OF MERCHANTABILITY AND FITNESS FOR A PARTICULAR PURPOSE ARE DISCLAIMED. IN NO EVENT SHALL THE COPYRIGHT HOLDERS OR CONTRIBUTORS BE LIABLE FOR ANY DIRECT, INDIRECT, INCIDENTAL, SPECIAL, EXEMPLARY, OR CONSEQUENTIAL DAMAGES (INCLUDING, BUT NOT LIMITED TO, PROCUREMENT OF SUBSTITUTE GOODS OR SERVICES; LOSS OF USE, DATA, OR PROFITS; OR BUSINESS INTERRUPTION) HOWEVER CAUSED AND ON ANY THEORY OF LIABILITY, WHETHER IN CONTRACT, STRICT LIABILITY, OR TORT (INCLUDING NEGLIGENCE OR OTHERWISE) ARISING IN ANY WAY OUT OF THE USE OF THIS SOFTWARE, EVEN IF ADVISED OF THE POSSIBILITY OF SUCH DAMAGE.

---- Part 6: Cisco/BUPTNIC copyright notice (BSD) ----

Copyright (c) 2004, Cisco, Inc and Information Network

Center of Beijing University of Posts and Telecommunications.

All rights reserved.

Redistribution and use in source and binary forms, with or without modification, are permitted provided that the following conditions are met:

* Redistributions of source code must retain the above copyright notice, this list of conditions and the following disclaimer.

* Redistributions in binary form must reproduce the above copyright notice, this list of conditions and the following disclaimer in the documentation and/or other materials provided with the distribution.

* Neither the name of Cisco, Inc, Beijing University of Posts and Telecommunications, nor the names of their contributors may be used to endorse or promote products derived from this software without specific prior written permission.

THIS SOFTWARE IS PROVIDED BY THE COPYRIGHT HOLDERS AND CONTRIBUTORS ``AS IS" AND ANY EXPRESS OR IMPLIED WARRANTIES, INCLUDING, BUT NOT LIMITED TO, THE IMPLIED WARRANTIES OF MERCHANTABILITY AND FITNESS FOR A PARTICULAR PURPOSE ARE DISCLAIMED. IN NO EVENT SHALL THE COPYRIGHT HOLDERS OR CONTRIBUTORS BE LIABLE FOR ANY DIRECT, INDIRECT, INCIDENTAL, SPECIAL, EXEMPLARY, OR CONSEQUENTIAL DAMAGES (INCLUDING, BUT NOT LIMITED TO, PROCUREMENT OF SUBSTITUTE GOODS OR SERVICES; LOSS OF USE, DATA, OR PROFITS; OR BUSINESS INTERRUPTION) HOWEVER CAUSED AND ON ANY THEORY OF LIABILITY, WHETHER IN CONTRACT, STRICT LIABILITY, OR TORT (INCLUDING NEGLIGENCE OR OTHERWISE) ARISING IN ANY WAY OUT OF THE USE OF THIS SOFTWARE, EVEN IF ADVISED OF THE POSSIBILITY OF SUCH DAMAGE.

----- Part 7: Fabasoft R&D Software GmbH & Co KG copyright notice (BSD) -----

Copyright (c) Fabasoft R&D Software GmbH & Co KG, 2003

oss@fabasoft.com

Author: Bernhard Penz <bernhard.penz@fabasoft.com>

Redistribution and use in source and binary forms, with or without modification, are permitted provided that the following conditions are met:

* Redistributions of source code must retain the above copyright notice, this list of conditions and the following disclaimer.

* Redistributions in binary form must reproduce the above copyright notice, this list of conditions and the following disclaimer in the documentation and/or other materials provided with the distribution.

* The name of Fabasoft R&D Software GmbH & Co KG or any of its subsidiaries, brand or product names may not be used to endorse or promote products derived from this software without specific prior written permission.

THIS SOFTWARE IS PROVIDED BY THE COPYRIGHT HOLDER ``AS IS" AND ANY EXPRESS OR IMPLIED WARRANTIES, INCLUDING, BUT NOT LIMITED TO, THE IMPLIED WARRANTIES OF MERCHANTABILITY AND FITNESS FOR A PARTICULAR PURPOSE ARE DISCLAIMED. IN NO EVENT SHALL THE COPYRIGHT HOLDER BE LIABLE FOR ANY DIRECT, INDIRECT, INCIDENTAL, SPECIAL, EXEMPLARY, OR CONSEQUENTIAL DAMAGES (INCLUDING, BUT NOT LIMITED TO, PROCUREMENT OF SUBSTITUTE GOODS OR SERVICES; LOSS OF USE, DATA, OR PROFITS; OR BUSINESS INTERRUPTION) HOWEVER CAUSED AND ON ANY THEORY OF LIABILITY, WHETHER IN CONTRACT, STRICT LIABILITY, OR TORT (INCLUDING NEGLIGENCE OR OTHERWISE) ARISING IN ANY WAY OUT OF THE USE OF THIS SOFTWARE, EVEN IF ADVISED OF THE POSSIBILITY OF SUCH DAMAGE.

----- Part 8: Apple Inc. copyright notice (BSD) -----

Copyright (c) 2007 Apple Inc. All rights reserved.

Redistribution and use in source and binary forms, with or without modification, are permitted provided that the following conditions are met:

1. Redistributions of source code must retain the above copyright notice, this list of conditions and the following disclaimer.

2. Redistributions in binary form must reproduce the above copyright notice, this list of conditions and the following disclaimer in the documentation and/or other materials provided with the distribution.

3. Neither the name of Apple Inc. ("Apple") nor the names of its contributors may be used to endorse or promote products derived

from this software without specific prior written permission.

THIS SOFTWARE IS PROVIDED BY APPLE AND ITS CONTRIBUTORS "AS IS" AND ANY EXPRESS OR IMPLIED WARRANTIES, INCLUDING, BUT NOT LIMITED TO, THE IMPLIED WARRANTIES OF MERCHANTABILITY AND FITNESS FOR A PARTICULAR PURPOSE ARE DISCLAIMED. IN NO EVENT SHALL APPLE OR ITS CONTRIBUTORS BE LIABLE FOR ANY DIRECT, INDIRECT, INCIDENTAL, SPECIAL, EXEMPLARY, OR CONSEQUENTIAL DAMAGES (INCLUDING, BUT NOT LIMITED TO, PROCUREMENT OF SUBSTITUTE GOODS OR SERVICES; LOSS OF USE, DATA, OR PROFITS; OR BUSINESS INTERRUPTION) HOWEVER CAUSED AND ON ANY THEORY OF LIABILITY, WHETHER IN CONTRACT, STRICT LIABILITY, OR TORT (INCLUDING NEGLIGENCE OR OTHERWISE) ARISING IN ANY WAY OUT OF THE USE OF THIS SOFTWARE, EVEN IF ADVISED OF THE POSSIBILITY OF SUCH DAMAGE.

---- Part 9: ScienceLogic, LLC copyright notice (BSD) ----

Copyright (c) 2009, ScienceLogic, LLC

All rights reserved.

Redistribution and use in source and binary forms, with or without modification, are permitted provided that the following conditions are met:

* Redistributions of source code must retain the above copyright notice, this list of conditions and the following disclaimer.

* Redistributions in binary form must reproduce the above copyright notice, this list of conditions and the following disclaimer in the documentation and/or other materials provided with the distribution.

* Neither the name of ScienceLogic, LLC nor the names of its contributors may be used to endorse or promote products derived from this software without specific prior written permission.

THIS SOFTWARE IS PROVIDED BY THE COPYRIGHT HOLDERS AND CONTRIBUTORS "AS IS" AND ANY EXPRESS OR IMPLIED WARRANTIES, INCLUDING, BUT NOT LIMITED TO, THE IMPLIED WARRANTIES OF MERCHANTABILITY AND FITNESS FOR A PARTICULAR PURPOSE ARE DISCLAIMED. IN NO EVENT SHALL THE COPYRIGHT HOLDERS OR CONTRIBUTORS BE LIABLE FOR ANY DIRECT, INDIRECT, INCIDENTAL, SPECIAL, EXEMPLARY, OR CONSEQUENTIAL DAMAGES (INCLUDING, BUT NOT LIMITED TO, PROCUREMENT OF SUBSTITUTE GOODS OR SERVICES; LOSS OF USE, DATA, OR PROFITS; OR BUSINESS INTERRUPTION) HOWEVER CAUSED AND ON ANY THEORY OF LIABILITY, WHETHER IN CONTRACT, STRICT LIABILITY, OR TORT (INCLUDING NEGLIGENCE OR OTHERWISE) ARISING IN ANY WAY OUT OF THE USE OF THIS SOFTWARE, EVEN IF ADVISED OF THE POSSIBILITY OF SUCH DAMAGE.

---- Part 10: Lennart Poettering copyright notice (BSD-like) ----

Copyright 2010 Lennart Poettering

Permission is hereby granted, free of charge, to any person obtaining a copy of this software and associated documentation files (the "Software"), to deal in the Software without restriction, including without limitation the rights to use, copy, modify, merge, publish, distribute, sublicense, and/or sell copies of the Software, and to permit persons to whom the Software is furnished to do so, subject to the following conditions:

The above copyright notice and this permission notice shall be included in all copies or substantial portions of the Software.

THE SOFTWARE IS PROVIDED "AS IS", WITHOUT WARRANTY OF ANY KIND, EXPRESS OR IMPLIED, INCLUDING BUT NOT LIMITED TO THE WARRANTIES OF MERCHANTABILITY, FITNESS FOR A PARTICULAR PURPOSE AND NONINFRINGEMENT. IN NO EVENT SHALL THE AUTHORS OR COPYRIGHT HOLDERS BE LIABLE FOR ANY CLAIM, DAMAGES OR OTHER LIABILITY, WHETHER IN AN ACTION OF CONTRACT, TORT OR OTHERWISE, ARISING FROM, OUT OF OR IN

CONNECTION WITH THE SOFTWARE OR THE USE OR OTHER DEALINGS IN THE SOFTWARE.

---- Part 11: IETF copyright notice (BSD) ----

Copyright (c) 2013 IETF Trust and the persons identified as authors of the code. All rights reserved.

Redistribution and use in source and binary forms, with or without modification, are permitted provided that the following conditions are met:

* Redistributions of source code must retain the above copyright notice, this list of conditions and the following disclaimer.

* Redistributions in binary form must reproduce the above copyright notice, this list of conditions and the following disclaimer in the documentation and/or other materials provided with the distribution.

* Neither the name of Internet Society, IETF or IETF Trust, nor the names of specific contributors, may be used to endorse or promote products derived from this software without specific prior written permission.

THIS SOFTWARE IS PROVIDED BY THE COPYRIGHT HOLDERS AND CONTRIBUTORS "AS IS" AND ANY EXPRESS OR IMPLIED WARRANTIES, INCLUDING, BUT NOT LIMITED TO, THE IMPLIED WARRANTIES OF MERCHANTABILITY AND FITNESS FOR A PARTICULAR PURPOSE ARE DISCLAIMED. IN NO EVENT SHALL THE COPYRIGHT OWNER OR CONTRIBUTORS BE LIABLE FOR ANY DIRECT, INDIRECT, INCIDENTAL, SPECIAL, EXEMPLARY, OR CONSEQUENTIAL DAMAGES (INCLUDING, BUT NOT LIMITED TO, PROCUREMENT OF SUBSTITUTE GOODS OR SERVICES; LOSS OF USE, DATA, OR PROFITS; OR BUSINESS INTERRUPTION) HOWEVER CAUSED AND ON ANY THEORY OF LIABILITY, WHETHER IN CONTRACT, STRICT LIABILITY, OR TORT (INCLUDING NEGLIGENCE OR OTHERWISE) ARISING IN ANY WAY OUT OF THE USE OF THIS SOFTWARE, EVEN IF ADVISED OF THE POSSIBILITY OF SUCH DAMAGE.

---- Part 12: Arista Networks copyright notice (BSD) ----

Copyright (c) 2013, Arista Networks, Inc.

All rights reserved.

Redistribution and use in source and binary forms, with or without modification, are permitted provided that the following conditions are met:

* Redistributions of source code must retain the above copyright notice, this list of conditions and the following disclaimer.

* Redistributions in binary form must reproduce the above copyright notice, this list of conditions and the following disclaimer in the documentation and/or other materials provided with the distribution.

* Neither the name of Arista Networks, Inc. nor the names of its contributors may be used to endorse or promote products derived from this software without specific prior written permission.

THIS SOFTWARE IS PROVIDED BY THE COPYRIGHT HOLDERS AND CONTRIBUTORS "AS IS" AND ANY EXPRESS OR IMPLIED WARRANTIES, INCLUDING, BUT NOT LIMITED TO, THE IMPLIED WARRANTIES OF MERCHANTABILITY AND FITNESS FOR A PARTICULAR PURPOSE ARE DISCLAIMED. IN NO EVENT SHALL THE COPYRIGHT HOLDERS OR CONTRIBUTORS BE LIABLE FOR ANY DIRECT, INDIRECT, INCIDENTAL, SPECIAL, EXEMPLARY, OR CONSEQUENTIAL DAMAGES (INCLUDING, BUT NOT LIMITED TO, PROCUREMENT OF SUBSTITUTE GOODS OR SERVICES; LOSS OF USE, DATA, OR PROFITS; OR BUSINESS INTERRUPTION) HOWEVER CAUSED AND ON ANY THEORY OF LIABILITY, WHETHER IN CONTRACT, STRICT LIABILITY, OR TORT (INCLUDING NEGLIGENCE OR OTHERWISE) ARISING IN ANY WAY OUT OF THE USE OF THIS SOFTWARE, EVEN IF ADVISED OF THE POSSIBILITY OF SUCH DAMAGE.

---- Part 13: VMware, Inc. copyright notice (BSD) ----

Copyright (c) 2016, VMware, Inc.

All rights reserved.

Redistribution and use in source and binary forms, with or without modification, are permitted provided that the following conditions are met:

* Redistributions of source code must retain the above copyright notice, this list of conditions and the following disclaimer.

* Redistributions in binary form must reproduce the above copyright notice, this list of conditions and the following disclaimer in the documentation and/or other materials provided with the distribution.

* Neither the name of VMware, Inc. nor the names of its contributors may be used to endorse or promote products derived from this software without specific prior written permission.

THIS SOFTWARE IS PROVIDED BY THE COPYRIGHT HOLDERS AND CONTRIBUTORS ``AS IS" AND ANY EXPRESS OR IMPLIED WARRANTIES, INCLUDING, BUT NOT LIMITED TO, THE IMPLIED WARRANTIES OF MERCHANTABILITY AND FITNESS FOR A PARTICULAR PURPOSE ARE DISCLAIMED. IN NO EVENT SHALL THE COPYRIGHT HOLDERS OR CONTRIBUTORS BE LIABLE FOR ANY DIRECT, INDIRECT, INCIDENTAL, SPECIAL, EXEMPLARY, OR CONSEQUENTIAL DAMAGES (INCLUDING, BUT NOT LIMITED TO, PROCUREMENT OF SUBSTITUTE GOODS OR SERVICES; LOSS OF USE, DATA, OR PROFITS; OR BUSINESS INTERRUPTION) HOWEVER CAUSED AND ON ANY THEORY OF LIABILITY, WHETHER IN CONTRACT, STRICT LIABILITY, OR TORT (INCLUDING NEGLIGENCE OR OTHERWISE) ARISING IN ANY WAY OUT OF THE USE OF THIS SOFTWARE, EVEN IF ADVISED OF THE POSSIBILITY OF SUCH DAMAGE.

---- Part 14: USC/Information Sciences Institute copyright notice (BSD) ----

Copyright (c) 2017-2018, Information Sciences Institute

All rights reserved.

Redistribution and use in source and binary forms, with or without modification, are permitted provided that the following conditions are met:

* Redistributions of source code must retain the above copyright notice, this list of conditions and the following disclaimer.

* Redistributions in binary form must reproduce the above copyright notice, this list of conditions and the following disclaimer in the documentation and/or other materials provided with the distribution.

* Neither the name of Information Sciences Institute nor the names of its contributors may be used to endorse or promote products derived from this software without specific prior written permission.

THIS SOFTWARE IS PROVIDED BY THE COPYRIGHT HOLDERS AND CONTRIBUTORS ``AS IS" AND ANY EXPRESS OR IMPLIED WARRANTIES, INCLUDING, BUT NOT LIMITED TO, THE IMPLIED WARRANTIES OF MERCHANTABILITY AND FITNESS FOR A PARTICULAR PURPOSE ARE DISCLAIMED. IN NO EVENT SHALL THE COPYRIGHT HOLDERS OR CONTRIBUTORS BE LIABLE FOR ANY DIRECT, INDIRECT, INCIDENTAL, SPECIAL, EXEMPLARY, OR CONSEQUENTIAL DAMAGES (INCLUDING, BUT NOT LIMITED TO, PROCUREMENT OF SUBSTITUTE GOODS OR SERVICES; LOSS OF USE, DATA, OR PROFITS; OR BUSINESS INTERRUPTION) HOWEVER CAUSED AND ON ANY THEORY OF LIABILITY, WHETHER IN CONTRACT, STRICT LIABILITY, OR TORT (INCLUDING NEGLIGENCE OR OTHERWISE) ARISING IN ANY WAY OUT OF THE USE OF THIS SOFTWARE, EVEN IF ADVISED OF THE POSSIBILITY OF SUCH DAMAGE.

Data Projector
VPL-PHZ60/PHZ50

Trademarks

- Kensington is a registered trademark of Kensington Technology Group.
- The terms HDMI and HDMI High-Definition Multimedia Interface, and the HDMI Logo are trademarks or registered trademarks of HDMI Licensing Administrator, Inc. in the United States and other countries.
- Internet Explorer is a registered trademark of Microsoft Corporation in the United States and/or other countries.
- Safari is a registered trademark of Apple Corporation in the United States and/ or other countries.
- Chrome is a trademark of Google LLC.
- PJLink is a registered trademark of Japan Business Machine and Information System Industries Association.
- AMX is a trademark of AMX Corporation.
- Crestron RoomView is a trademark of Crestron Corporation.
- HDBaseT™ and the HDBaseT Alliance logo are trademarks of the HDBaseT Alliance.
- Extron and XTP Systems are trademarks of RGB Systems, Inc.
- All other trademarks and registered trademarks are trademarks or registered trademarks of their respective holders. In this manual, ™ and ® marks are not specified.

