

InFocus

IN3102 IN3104 IN3106 IN3108



DisplayLink™
certified

Regulatory models W3220, W3240 and W3260

010-0710-03



Declaration of Conformity

Manufacturer: InFocus Corporation, 13190 SW 68th Parkway, Portland, Oregon 97223-8368 USA

We declare under our sole responsibility that this projector conform to the following directives and norms:

EMC Directive 2004/108/EC

EMC: EN 55022

EN 55024

EN 61000-3-2

EN 61000-3-3

Low Voltage Directive 2006/95/EC

Safety: IEC 60950-1: 1st Edition

Trademarks

DisplayLink is a trademark of DisplayLink Corporation.

Apple, Macintosh, and PowerBook are trademarks or registered trademarks of Apple Computer, Inc. IBM is a trademark or registered trademark of International Business Machines, Inc. Microsoft, PowerPoint, and Windows are trademarks or registered trademarks of Microsoft Corporation. Adobe and Acrobat are trademarks or registered trademarks of Adobe Systems Incorporated. DLP® and the DLP logo are registered trademarks of Texas Instruments and BrilliantColor™ is a trademark of Texas Instruments. InFocus, In Focus, and INFOCUS (stylized) are either registered trademarks or trademarks of InFocus Corporation in the United States and other countries.

FCC Warning

Note: This equipment has been tested and found to comply with the limits for a Class B digital device, pursuant to part 15 of the FCC Rules. These limits are designed to provide reasonable protection against harmful interference in a residential installation. This equipment generates, uses and can radiate radio frequency energy and, if not installed and used in accordance with the instructions, may cause harmful interference to radio communications. However, there is no guarantee that interference will not occur in a particular installation. If this equipment does cause harmful interference to radio or television reception, which can be determined by turning the equipment off and on, the user is encouraged to try to correct the interference by one or more of the following measures:

--Reorient or relocate the receiving antenna.

--Increase the separation between the equipment and receiver.

--Connect the equipment into an outlet on a circuit different from that to which the receiver is connected.

--Consult the dealer or an experienced radio/TV technician for help.

Changes or modifications not expressly approved by InFocus Corporation may void authority to operate the equipment.

Canada

This Class B digital apparatus complies with Canadian ICES-003.

Cet appareil numérique de la classe B est conforme à la norme NMB-003 du Canada.

Agency Approvals

UL, cUL

Other specific Country Approvals may apply. Please see product certification label.

This document applies to regulatory models W3220, W3240, and W3260.

Input ratings: 3.3 - 1.2A (W3220, W3260), 3.9 - 1.4A (W3240)

InFocus reserves the right to alter product offerings and specifications at any time without notice.

Table of Contents

Introduction	3
Positioning the projector	5
Projector and device connector guide	6
Connecting a computer source	9
Required computer connections (DisplayLink or VESA)	9
Optional computer connections	9
Displaying an image	10
Adjusting the image	11
Connecting a video device	12
Video device connections	13
Composite video connection	13
HDMI 1.3 connection	13
S-video connection	13
VESA connection	13
Component video connection	13
Shutting down the projector	14
Troubleshooting your setup	14
Using the remote control	22
Using the audio	23
Using the keypad buttons	24
Optimizing computer images	25
Presentation features	25
Optimizing video images	26
Customizing the projector	26
Using the menus	27
Basic Picture menu	28
Advanced Picture menu	29
Setup menu	30
Status and Service menu	32
Maintenance	33
Cleaning the lens	33
Using the security lock	33
Replacing the projection lamp	34

Important Operating Considerations for Safety

- Place the projector in a horizontal position no greater than 15 degrees off axis.
- Locate the projector in a well-ventilated area without any obstructions to intake or exhaust vents. Do not place the projector on a tablecloth or other soft covering that may block the vents.
- Locate the projector at least 4' (1.2 m) away from any heating or cooling vents.
- Use only InFocus-approved ceiling mounts. **Warning:** To prevent eye injury if the projector is ceiling mounted, wear protective eyewear before opening lamp door. A warning sticker is included with the user documentation. Place this sticker on the lamp door if the projector is mounted on the ceiling.
- Only genuine InFocus lamps are tested for use in this projector. InFocus is not liable for the performance, safety or certification of any other lamps. The use of other lamps violates the projector warranty and voids all certification marks on this projector.
- Use only the power cord provided. A surge-protected power strip is recommended.
- Refer to this guide for proper startup and shutdown procedures.
- Hg – Lamp contains mercury. Manage in accordance with local disposal laws. See www.lamprecycle.org.
- In the unlikely event of a lamp rupture, particles may exit through the projector side vents. When the projector is turned on, keep people, food, and drinks out of the "keep out" area under and around the projector, as indicated by the "X" areas below.

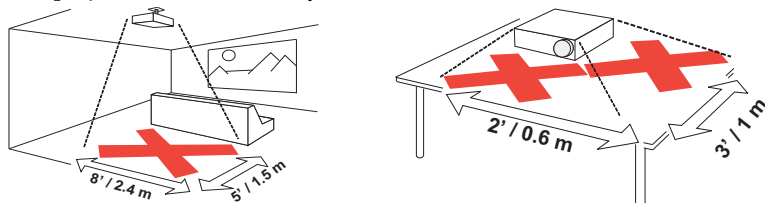

Follow these instructions to help ensure image quality and lamp life over the life of the projector. Failure to follow these instructions may affect the warranty. For complete details of the warranty, see the Warranty Booklet.

Introduction

Your new digital projector is simple to connect, easy to use, and straightforward to maintain. It is a versatile projector that is flexible enough for business presentations and home video viewing too. The IN3102/IN3104 has native XGA 1024x768 resolution, and the IN3106/IN3108 has WXGA 1280x800 resolution. This guide applies to all products. They are compatible with a wide variety of computers and video devices.

Product specifications

To read the latest specifications on your multimedia projector, be sure to visit our website at www.infocus.com, as specifications are subject to change.

Accessories

The standard accessories that came with your projector are listed in the included Quick Start Poster/Booklet. Optional accessories can be found on our website at www.infocus.com or at your retailer or dealer.

Online registration

Register your projector on our website at www.infocus.com/register to activate your warranty and receive product updates, announcements, and registration incentives.

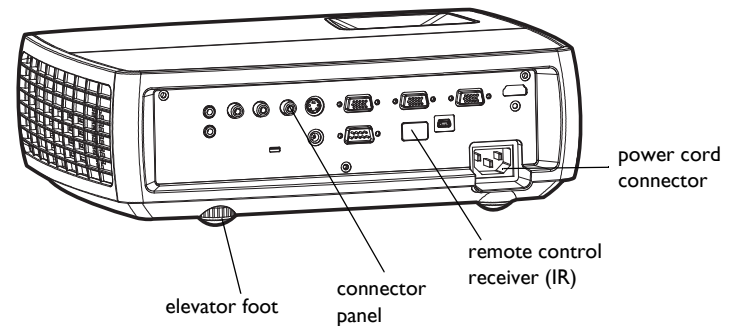
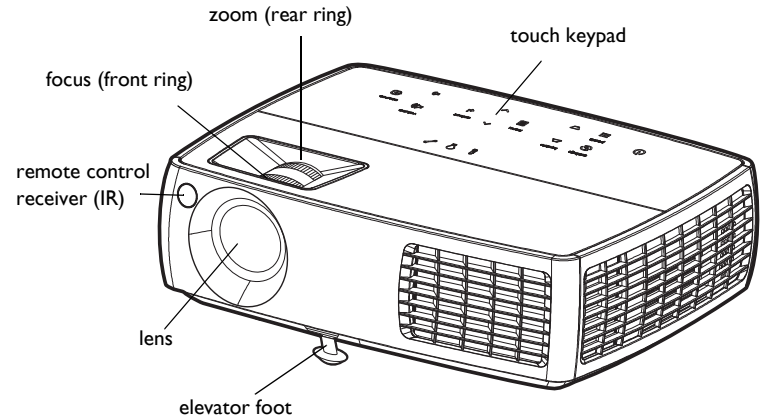

Connector panel

The projector provides both computer and video connection options, including:

- VESA computer (2)
- HDMI, for computer (1) and for video (1)
- S-video
- Composite video
- Separate audio inputs for video and computer
- USB DisplayLink connector, for computer audio/video input. This USB connection also provides slide advance (and mouse control when used with an optional remote control only)

The projector also provides the following connectors:

- Monitor out, to provide an image on your desktop computer as well as on the projection screen
- Audio out, to provide sound for external speakers
- A 5 volt DC output (see below)

It also has an RS-232 connector for serial control. The Command Line Interface (CLI) specifications and commands are on our website.

NOTE: DisplayLink video and audio is not sent to monitor out and audio out.

5 volt DC output

The 3.5mm mini-jack triggers provide a 5 volt, 2 amp DC output. It provides a constant output while the projector is on. It is designed to provide power for an InFocus LiteShow II wireless device, which allows wireless projection. More information can be found on our website at

www.infocus.com or at your retailer or dealer.

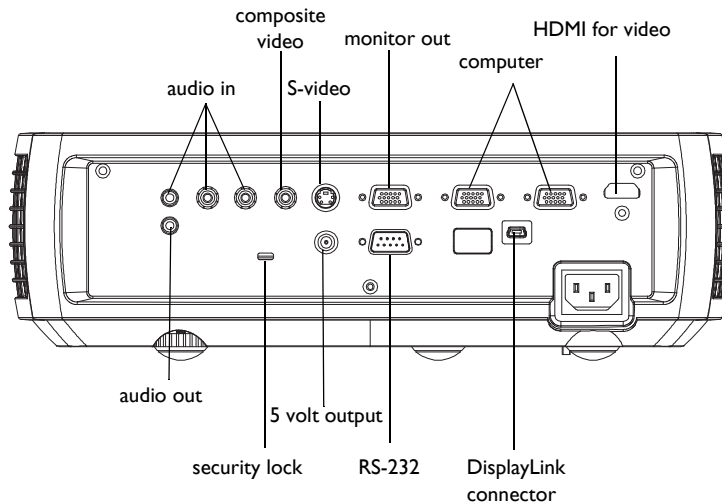

Positioning the projector

To determine where to position the projector, consider the size and shape of your screen, the location of your power outlets, and the distance between the projector and the rest of your equipment. Here are some general guidelines:

- Position the projector on a flat surface at a right angle to the screen. The projector must be at least 4.9 feet (1.5m) from the projection screen.
- Position the projector within 10 feet (3m) of your power source and within 6 feet (1.8m) of your video device (unless you purchase extension cables). To ensure adequate cable access, do not place the projector within 6 inches (.15m) of a wall or other object.
- If you are installing the projector on the ceiling, refer to the installation guide that comes with the Ceiling Mount Kit for more information. To turn the image upside down, see “Ceiling mount” on page 31. We recommend using an InFocus authorized ceiling mount.
- Position the projector the desired distance from the screen. The distance from the lens of the projector to the screen, the zoom setting, and the video format determine the size of the projected image.
- The image exits the projector at a given angle. IN3102/IN3104 image offset is 115%; IN3106/IN3108 image offset is 112.4%. This means if you have an image 10’ high, the bottom of the image will be 1.5’ (IN3102/IN3104) and 1.24’ (IN3106/IN3108) above the center of the lens.

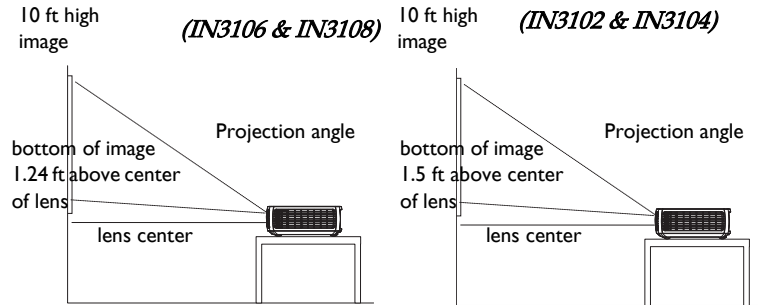

Table 1: (IN3102 & IN3104)
Range of distance to the screen for a given screen size

Diagonal Screen Size (inches/m)	Distance to screen	
	Maximum distance (feet/m)	Minimum Distance (feet/m)
60/1.5	8.6/2.6	7.8/2.4
80/2.0	11.5/3.5	10.4/3.2
90/2.3	12.9/3.9	11.7/3.6
150/3.8	21.5/6.6	19.5/5.9

Table 2: (IN3106 & IN3108)
Range of distance to the screen for a given screen size

Diagonal Screen Size (inches/m)	Distance to screen	
	Maximum distance (feet/m)	Minimum Distance (feet/m)
60/1.5	7.3/2.2	6.5/2.0

Table 2: (IN3106 & IN3108)

Range of distance to the screen for a given screen size

Diagonal Screen Size (inches/m)	Distance to screen	
	Maximum distance (feet/m)	Minimum Distance (feet/m)
80/2.0	9.7/2.9	8.7/2.7
90/2.3	10.9/3.3	9.8/3.0
150/3.8	18.1/5.5	16.3/5.0

Projector and device connector guide

The following illustration and table should help you find the connectors to use and obtain the best resolution possible from your input devices, such as computers, standard VCRs, DVD players (progressive and interlaced), HDTV sources (1080i, 1080p and 720p HDTV formats), TV and satellite tuners, camcorders, video games (progressive and interlaced), and laser disc players.

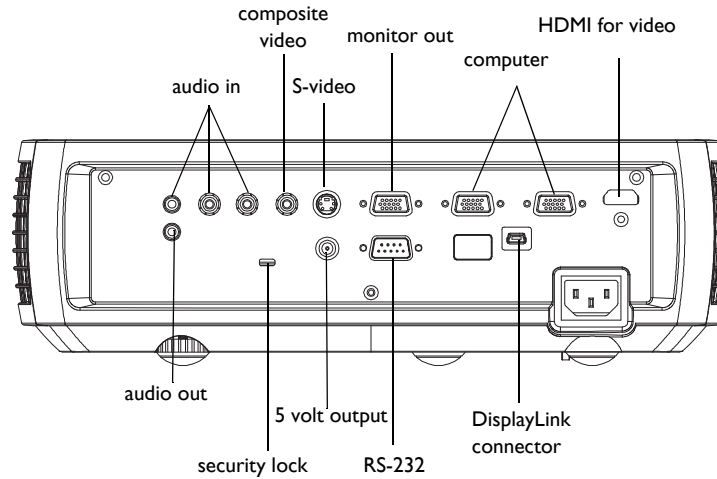

Video Device	Video Compatibility	If Your Device Connector Is	Attach to Adapter or Labeled Connector on Projector	For Setup Instructions, see	Comments
Standard Broadcast TV (not HDTV) via: cable, digital cable, satellite TV, DVD, or VCR	NTSC, PAL, and SECAM formats	Composite video or S-video	Video 3 or Video 2	Composite video connection on page 14. S-video connection on page 14	Not for progressive (i.e. HDTV) sources. See page 9.
Standard Video Camera	NTSC, PAL, and SECAM formats	Composite video or S-video	Video 3 or Video 2	Composite video connection on page 14. S-video connection on page 14	Not for progressive (i.e. HDTV) sources. See page 9.
Standard Video Game	NTSC, PAL, and SECAM formats	Composite video or S-video	Video 3 or Video 2	Composite video connection on page 14. S-video connection on page 14	Not for progressive (i.e. HDTV) sources. See page 9.

Video Device	Video Compatibility	If Your Device Connector Is	Attach to Adapter or Labeled Connector on Projector	For Setup Instructions, see	Comments
HDTV (High Definition TV)	1080i, 1080p, 720p	VGA	Computer 3 or Computer 2	VESA connection on page 14	
	Component 480i	Component video	Computer 3 or Computer 2 via optional VESA to Component adapter	Component video connection on page 14	
			HDMI	HDMI connection on page 14	
Progressive DVD	1080i, 1080p, 720p	VGA	Computer 3 or Computer 2	VESA connection on page 14	
	Component 480p and 480i	Component video	Computer 3 or Computer 2 via optional VESA to Component adapter	Component video connection on page 14	
			HDMI	HDMI connection on page 14	
Progressive Video Game	1080i, 1080p, 720p	VGA	Computer 3 or Computer 2	VESA connection on page 14	
	Component 480p and 480i	Component video	Computer 3 or Computer 2 via optional VESA to Component adapter	Component video connection on page 14	
			HDMI	HDMI connection on page 14	

Connecting a computer source

Required computer connections (DisplayLink or VESA)

If your computer has Windows XP SP2 or newer*, connect the USB cable between your computer's USB port and the projector's **DisplayLink connector**, then follow the instructions on the screen. See the DisplayLink Manager User's Guide for more information.

* For the latest information about support for other operating systems (including Apple), go to www.infocus.com/support/displaylink

Or, connect one end of the provided computer cable to the **Computer 2** or **Computer 3** connector on the projector and the other to the VESA connector on your computer. If you are using a desktop computer, you will need to disconnect the monitor cable from the computer's video port first (you can connect this monitor cable to the **Monitor Out** connector on the projector, see below).

Connect the black power cord to the **Power** connector on the side of the projector and to your electrical outlet. The Power light on the Status Indicator Panel (page 15) turns amber.

NOTE: Always use the power cord that shipped with the projector.

Optional computer connections

To get sound from the projector, connect an audio cable (optional cable, not included) to your computer and to the **Audio In Computer** connector on the projector. You may also need an adapter.

If you are using a desktop computer and want to see the image on your computer screen as well as on the projection screen, connect the computer's monitor cable to the **Monitor Out** connector on the projector.

NOTE: DisplayLink video and audio is not sent to monitor out and audio out.

To advance slides in a PowerPoint presentation using the remote control, plug the USB cable into the USB mouse connector on your computer and the **DisplayLink** connector on the projector.

connect USB cable

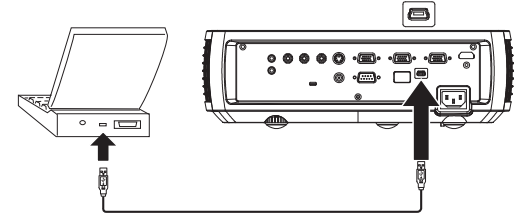

connect computer cable

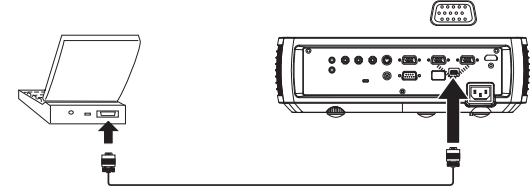

connect power cord

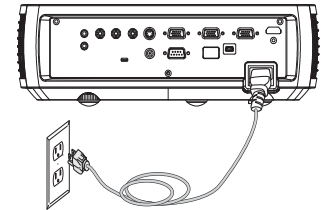

connect audio cable

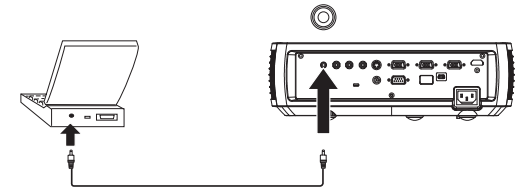

connect monitor cable

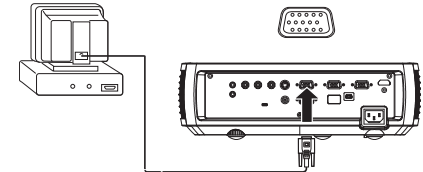

Displaying an image

Touch the **Power** button.

The Power button blinks green and the fans start to run. When the lamp comes on, the start up screen displays and the Power button is steady green. It can take a minute for the image to achieve full brightness.

? No start up screen? Get help on page 16.

Turn on your computer or video device.

The image should appear on the projection screen. If it doesn't, press the **Source** button on the projector's keypad or remote.

If you are using a VESA cable to connect your computer to the projector (instead of DisplayLink):

If using a laptop, make sure its external video port is active.

Many laptops do not automatically turn on their external video port when a projector is connected. Usually a key combination like FN + F8 or CRT/LCD key turns the external display on and off. Locate a function key labeled CRT/LCD or a function key with a monitor symbol. Press FN and the labeled function key simultaneously. **Refer to your laptop's documentation to learn your laptop's key combination.**

? No laptop image? Try pressing the **Auto Image** button on the keypad. Get help on page 16.

? Is your laptop connected to the projector's DisplayLink connector? See the InFocus DisplayLink Manager User's Guide for troubleshooting information.

press Power button

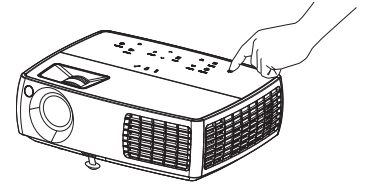

turn on computer or video device

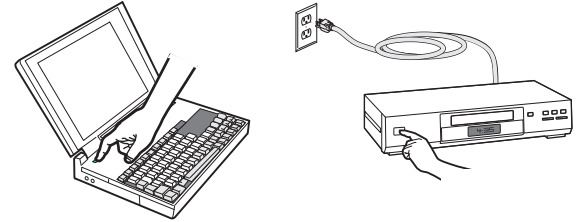

activate laptop's external port



monitor key or
LCD/CRT key

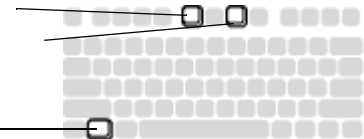

FN key

Adjusting the image

If necessary, adjust the height of the projector by pressing the elevator foot release button to extend the foot.

If necessary, rotate the leveling foot located at the rear of the projector.

Avoid placing your hands near the hot exhaust vent at the side of the projector.

Position the projector the desired distance from the screen at a 90 degree angle to the screen.

See page 5 for a table listing screen sizes and distances.

Adjust the zoom or focus.

If the image is not square, first make sure that the projector is perpendicular to the screen. If the image is larger or smaller on the top or bottom edge of the screen, press the top **Keystone** button to reduce the upper part of the image, and press the bottom **Keystone** button to reduce the lower part.

If the left or right side of the screen is larger or smaller the other, you can turn the projector to the left or to the right a few degrees to square the image.

Adjust the Contrast or Brightness in the Basic Picture menu. See page 29 for help with these menu adjustments.

For Aspect Ratio, keep in mind that DVD players must be configured for 16:9 in order to view the highest quality image. For more information regarding Aspect Ratio, see page 13.

adjust height

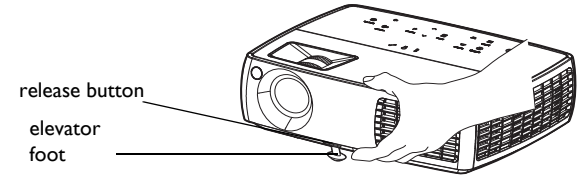

adjust distance

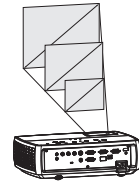

adjust zoom or focus

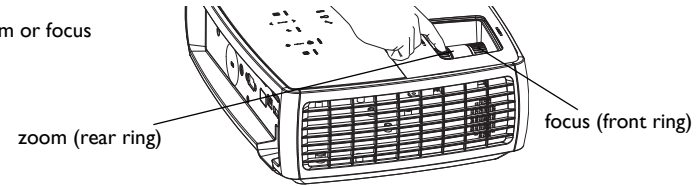

adjust keystone

keystone

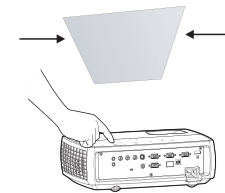

adjust Basic Picture menu



Connecting a video device

You can connect video devices such as VCRs, DVD players, camcorders, digital cameras, video game consoles, HDTV receivers, and TV tuners to the projector. You can connect the audio directly to the projector to get sound from the built-in speaker, or you can bypass the projector's audio system and connect the audio directly from your source to a stereo or home theater system.

You can connect the projector to most video devices that can output video. You cannot directly connect the coaxial cable that enters your house from a cable or satellite company, the signal must pass through a tuner first. Examples of tuners are digital cable boxes, VCRs, digital video recorders, and satellite TV boxes. Basically, any device that can change channels is considered a tuner.

Before connecting your projector, you should decide which aspect ratio you want to use. The projector's Aspect Ratio setting is accessed through the Resize button on the remote or through the projector's Basic Picture Menu. See page 29 for more information.

What is Aspect Ratio?

Aspect ratio is the ratio of the image width to image height. TV screens are usually 4:3. HDTV and most DVDs are 16:9. If you're projecting onto a screen, the size/shape of the screen may determine which aspect ratio to use. If you are projecting onto a blank wall, you don't have the screen size restriction. What you plan to project will also help you choose between 4:3 and 16:9. Most TV shows are 4:3, while most movies are 16:9.

If you have a 16:9 screen then you should select an aspect ratio of 16:9 for anamorphic movies or HDTV, and Native for 4:3 content. If you have a 4:3 screen you should still use 16:9 for anamorphic movies or HDTV, but you also have the option of using either 4:3 (to fill the screen) or Native (for direct pixel mapping) for 4:3 content. Keep in mind that anamorphic movies only appear correctly if the DVD player is set to output to a 16:9 television.

4:3 screen

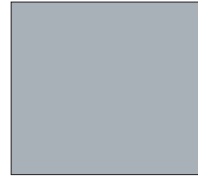

16:9 screen

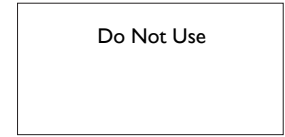

4:3 mode



16:9 mode



Native mode (NTSC only)

Video device connections

No video cables are provided with the projector. You can order cables from InFocus or provide your own.

Composite video connection

Plug the composite video cable's yellow connector into the video-out connector on the video device. Plug the other yellow connector into the yellow **Video 3** connector on the projector.

Plug the white connector of a Mini-plug audio Y-cable into the left audio out connector on the video device and plug the red connector into the right audio out connector on the video device. Plug the other end of the cable into the **Audio In Video** connector on the projector.

Keep in mind that video output from composite connections is not as high quality as S-video.

HDMI 1.3 connection

HDMI is a standard, uncompressed, all-digital audio/video interface. HDMI provides an interface between sources, such as set-top boxes, DVD players, and receivers and your projector. Plug an HDMI cable into the video-out connector on the video device and into the HDMI connector on the projector.

To take advantage of HDMI 1.3 Deep Color (30 bit) you must have a 1.3-compatible source.

S-video connection

If your video device uses a round, four-prong S-video connector, plug an S-video cable into the S-video connector on your video device and into the **Video 2** connector on the projector. Use the audio cable as described above.

Keep in mind that S-video delivers higher quality video output than composite.

VESA connection

If your video device has a 15-pin VGA output, plug one end of the included computer cable into the VGA connector on your video source. This connector may be labeled "To Monitor" on the video source. Plug the computer cable into the **Computer 3** or **Computer 2** connector on the projector.

Component video connection

If your HD video device has component connectors, an optional Component to VESA adapter can be used. Plug the component cable into the video device. Plug the other end of the component cable into the adapter and plug the adapter into the **Computer 3** or **Computer 2** connector. Component offers the highest quality video output.

Shutting down the projector

The projector automatically displays a black screen after no active source is detected for 30 minutes. This black screen helps preserve the life of the projector. The image returns when an active source is detected or a remote or keypad button is pressed.

Screen Save Time

You can make the black screen appear after a preset number of minutes by turning on the Screen Save Time feature in the Setup menu. See page 31.

Auto Off Time

The projector also has an Auto Off Time feature that automatically turns the projector off after no active sources are detected and no user interaction with the projector is performed for 30 minutes. By default, this feature is off. You can change the length of time, see page 31.

Turning off the projector

To turn the projector off, press the **Power** button on the remote or keypad. The lamp turns off and the LED blinks amber for 1 minute while the fans continue to run to cool the lamp. When the lamp has cooled, the LED lights amber and the fans stop. Unplug the power cable to completely power off the projector.

Troubleshooting your setup

If your image appears correctly on the screen, skip to the next section. If it does not, troubleshoot the setup.

The Status Indicator Panel on top of the projector indicates the state of the projector and can help you troubleshoot.

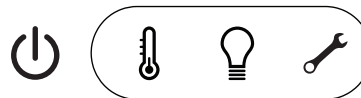



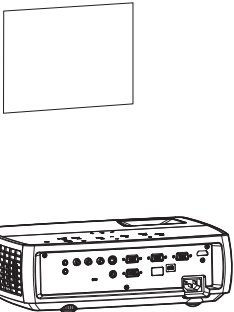
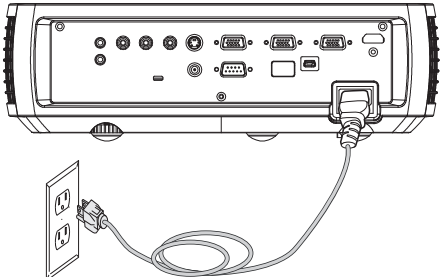
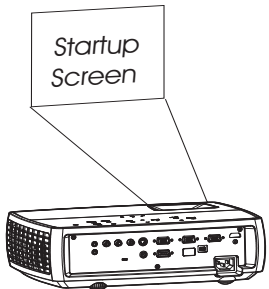
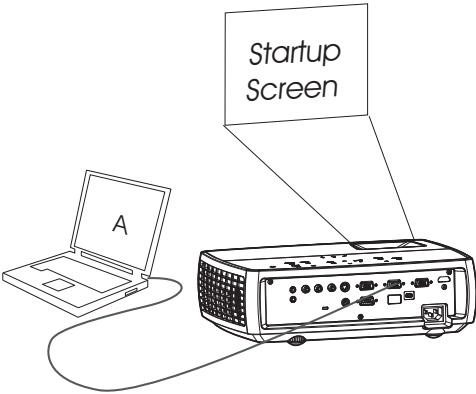

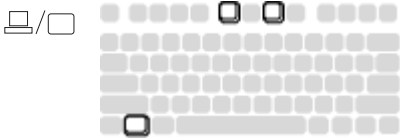
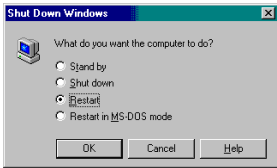
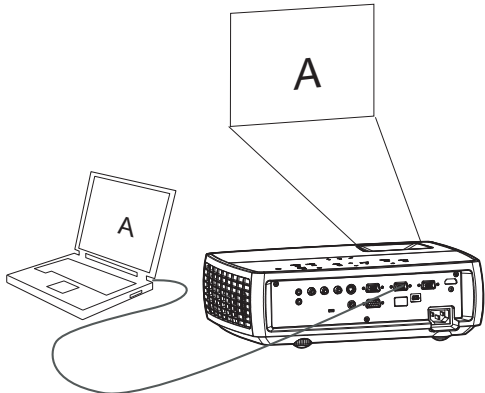

Table 3: Status indicator light behavior and meaning

Icon	Meaning
Power, solid amber 	The projector is plugged in.
Power, blinking green	The power button has been pressed and the software is initializing.
Power, solid green	The projector is on and initialized.
Power, blinking amber	The power button has been pressed to turn the projector off and the fans are running to cool the projector.
Thermometer 	The projector is too hot. Make sure the vents aren't blocked (see page 21). Turn off the projector and wait one minute, then turn the projector on again. Contact Technical Support if the problem persists. Visit www.infocus.com/support to contact service.
Lamp 	Turn off the projector and wait one minute, then turn the projector on again. If the lamp light turns on again, replace the lamp and reset the lamp timer.
Wrench/Service 	Turn off the projector and wait one minute, then turn the projector on again. If the service lamp turns on again, service is required. Visit www.infocus.com/support to contact service.

Problem	Solution	Result
<p data-bbox="48 123 243 149">No start up screen</p> 	<p data-bbox="661 123 1015 177">Plug power cord into the projector press power button</p> 	<p data-bbox="1183 123 1328 149">Correct image</p> 
<p data-bbox="48 499 338 522">Only start up screen appears</p> 	<p data-bbox="661 487 1154 556">If your computer is using the projector's DisplayLink connector, see the DisplayLink User's Guide for troubleshooting information.</p> <p data-bbox="661 579 946 625">Press the Source button  activate laptop's external port</p>  <p data-bbox="677 832 815 855">Restart laptop</p> 	<p data-bbox="1183 493 1449 516">Computer image projected</p> 

Prolem

No computer image, just the words “Signal out of range”

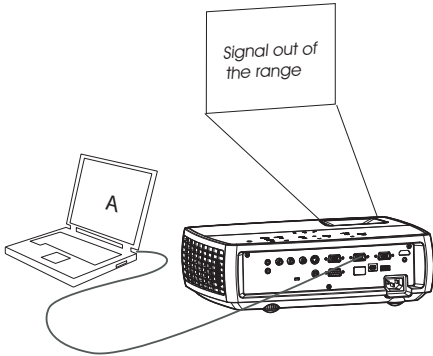

Solution

Press the Auto Image button on keypad adjust computer refresh rate in Control Panel > Display > Settings > Advanced > Adapter (location varies by operating system)

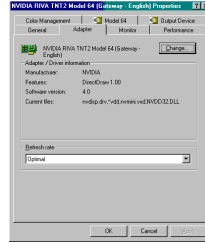

You may also need to set a different resolution on your computer, as shown in the following problem, “image fuzzy or cropped”

Result

Computer image projected

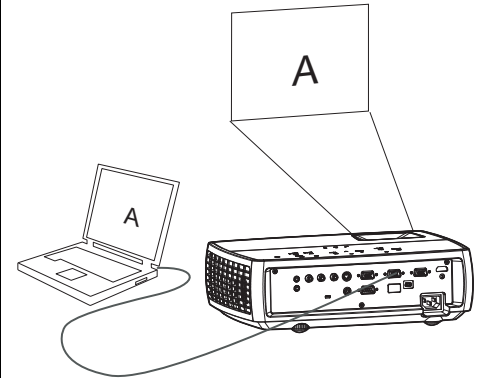

Only my laptop’s background appears, not the Desktop icons

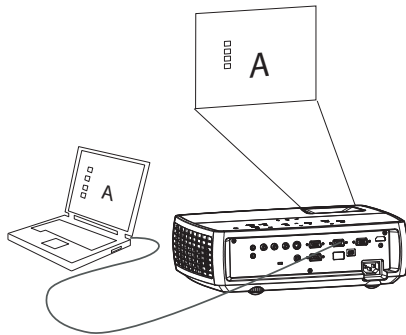



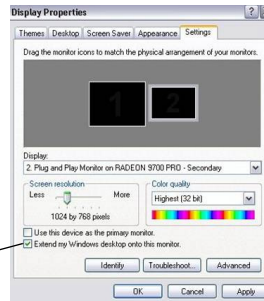

If your computer is using the DisplayLink connector, use DisplayLink Manager software to change the display mode from Extended Desktop to Duplicated Desktop. See the DisplayLink Manager User’s Guide for more information. Disable “Extend my Windows Desktop” in Control Panel > Display > Settings > Display 2 (location varies by operating system)



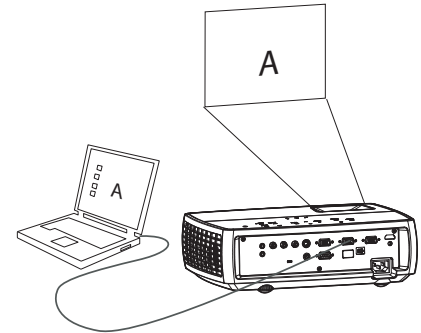

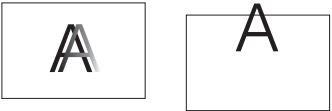
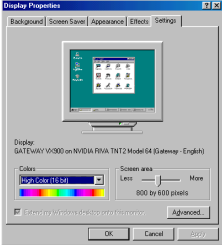

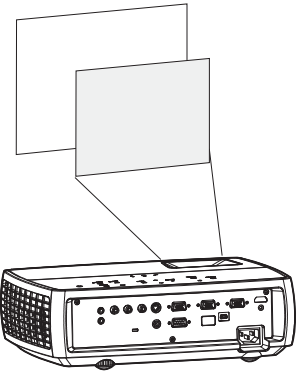
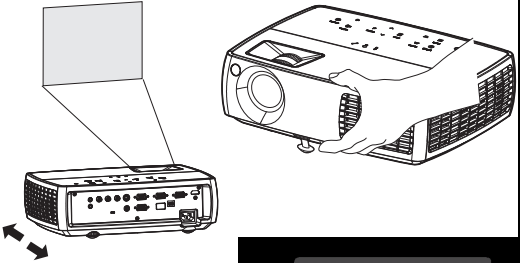

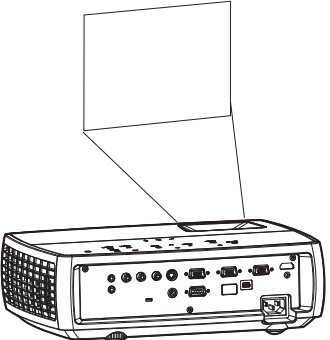

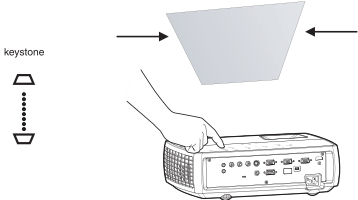

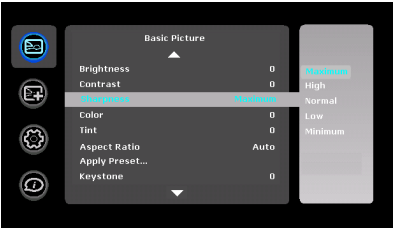

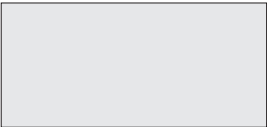

Uncheck this option, then click Apply

Background and Desktop projected

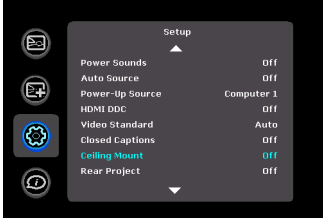

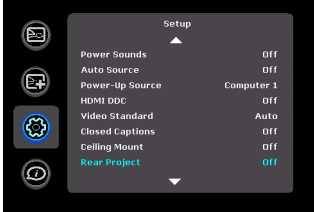
Problem	Solution	Result
<p>Image fuzzy or cropped</p> 	<p>Set your computer's display resolution to the native resolution of the projector (Start > Settings > Control Panel > Display > Settings tab)</p> <p>For a laptop, disable laptop monitor or turn-on dual-display mode</p> 	<p>Image clear and not cropped</p> 
<p>Image not centered on screen</p> 	<p>Move projector, adjust zoom, adjust height</p>  <p>Adjust horizontal or vertical position in Advanced Picture menu</p> 	<p>Correct image</p> 

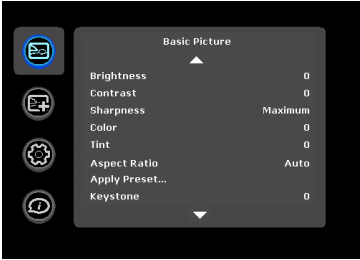
Prolem	Solution	Result
<p data-bbox="48 89 225 114">Image not square</p> 	<p data-bbox="604 89 876 114">Adjust Keystone on keypad</p> 	<p data-bbox="1182 89 1315 114">Square image</p> 
<p data-bbox="48 337 211 362">Image not sharp</p> 	<p data-bbox="604 337 1029 362">Adjust Sharpness in the Basic Picture menu</p> 	<p data-bbox="1182 337 1328 362">Correct image</p> 
<p data-bbox="48 613 416 638">Image does not fit 4:3 or 16:9 screen</p> 	<p data-bbox="604 613 1024 668">Change aspect ratio to 4:3 or 16:9 in Basic Picture>Aspect ratio menu</p> 	<p data-bbox="1182 613 1328 638">Correct image</p> 

Prolem	Solution	Result
<p>Image upside down</p> 	<p>Turn off Ceiling Mount in Setup menu</p> 	<p>Correct image</p> 
<p>Image reversed left to right</p> 	<p>Turn off Rear Project in Setup menu</p> 	<p>Correct image</p> 
<p>Projected colors don't match source</p> 	<p>Adjust color, tint, brightness, contrast in the Basic Picture menu</p> 	<p>Correct image</p> 

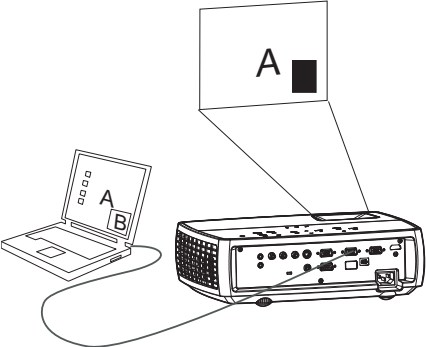
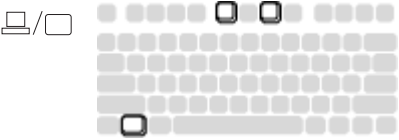
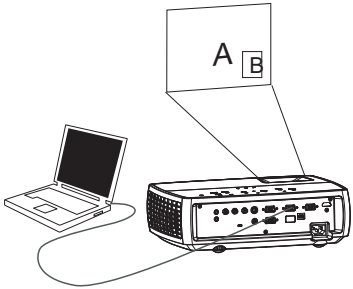
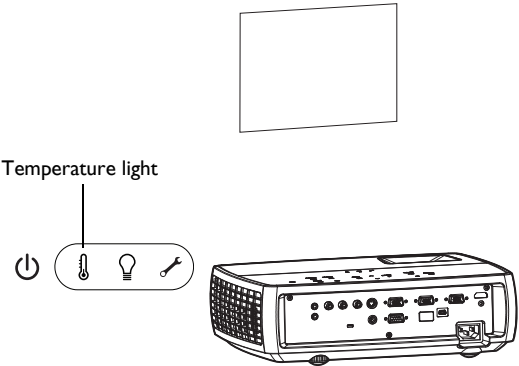
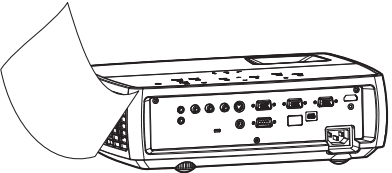
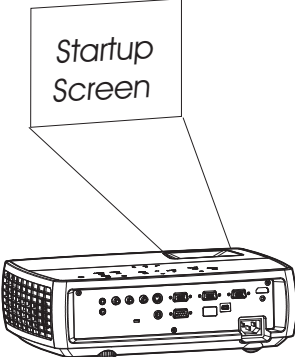
Problem	Solution	Result
<p>The video embedded in my PowerPoint presentation does not play on the screen</p> 	<p>If your computer is using the projector's DisplayLink connector, see the DisplayLink User's Guide for video troubleshooting information. Turn off the internal LCD display on your laptop</p> 	<p>Embedded video plays correctly</p> 
<p>Lamp won't turn on, Temperature light is on</p> 	<p>Make sure vents aren't blocked, turn off the projector and allow it to cool for one minute</p> 	<p>Lamp turns on</p> 

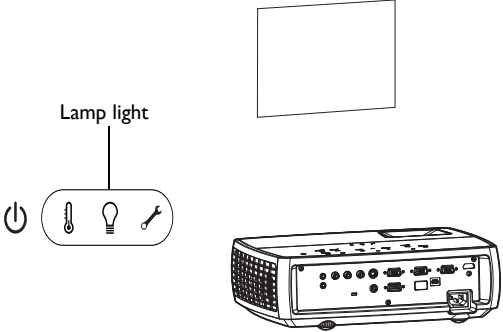
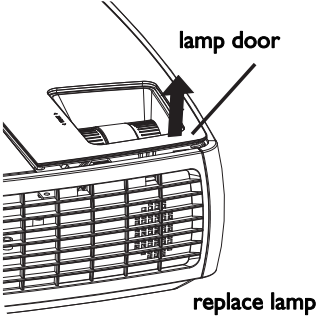
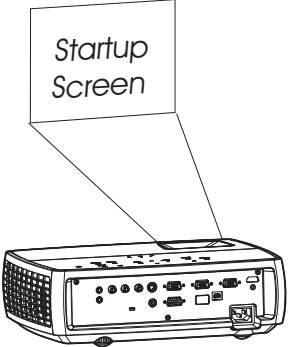
Problem	Solution	Result
<p data-bbox="48 89 531 142">“Replace lamp” message appears at startup, lamp won’t turn on, Lamp light is turned on</p> 	<p data-bbox="604 101 968 126">Lamp must be replaced (see page 35)</p> 	<p data-bbox="1180 82 1326 107">Lamp turns on</p> 

Still need assistance?

If you need assistance, visit our website at www.infocus.com/service or call us. Check out our HOW TO section there for additional information on using this projector for home theater or gaming applications. See the Quick Start Poster/Booklet for support contact information.

This product is backed by a limited warranty. An extended warranty plan may be purchased from your dealer. When sending the projector in for repair, we recommend shipping the unit in its original packing material, or having a professional packaging company pack the unit. Please insure your shipment for its full value.

Using the remote control

The remote uses two (2) provided AA batteries. They are easily installed by removing the cover from the remote's back, aligning the + and - ends of the batteries, sliding them into place, and then replacing the cover.

Caution: When replacing the batteries, be aware that using batteries other than the type provided with the projector may risk severe damage to the remote. When disposing of the batteries, be sure to do so in an environmentally proper manner.

To operate, point the remote at the front of the projector (not at the computer). The range of optimum operation is about 15 feet (4.5m).

Press the remote's **Power** button to turn the projector on and off (see page 15 for shutdown info).

Press the remote's **Menu** button to open the projector's menu system. Use the arrow buttons to navigate, and the **Select** button to select features and adjust values in the menus. See page 28 for more info on the menus.

The remote also has a **Source** button to switch between sources.

The remote also has:

- **Volume** buttons to adjust the sound.
- **Custom** button that can be assigned to a special function, like Blank Screen or Freeze (see page 31).
- **Source** button to switch between sources.
- **Blank** button to blank the screen.
- **Presets** button to select stored settings (see page 29).
- **Mute** button to silence the audio.
- **Auto Image** button to resynch the projector to the source
- **Resize** button to switch among aspect ratios (see page 29).

Troubleshooting the remote

- Make sure the batteries are installed in the proper orientation and are not dead.
- Make sure you're pointing the remote at the projector or the screen, not the computer, and are within the remote range of 15 feet (4.5m). For best results, point the remote at the projector.

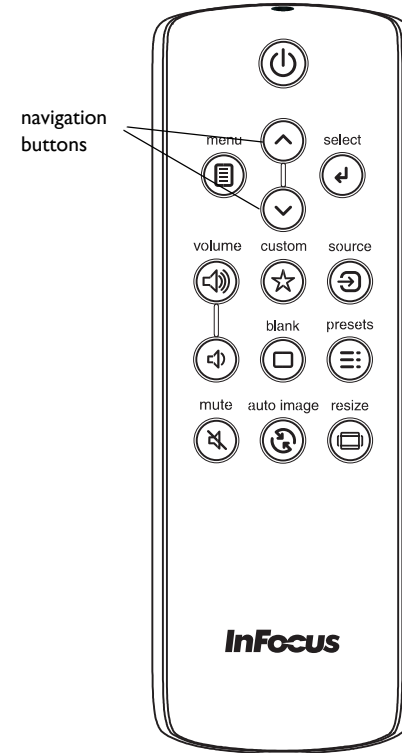

Using the audio

Using the projector's speakers

When the computer is using the DisplayLink connector, both audio and video are sent over the USB cable to the projector and audio will play from the projector's speakers.

For inputs other than DisplayLink, to use the projector's speakers, connect the audio source to the Audio In Computer or Video connectors.

To adjust the volume, press the **Volume** buttons on the keypad or remote.

Troubleshooting Audio

If you aren't hearing the audio, check the following:

- If your computer is using the projector's DisplayLink connector, see the InFocus DisplayLink Manager User's Guide for audio troubleshooting information
- Make sure the audio cable is connected to the correct Audio In connector, Computer or Video.
- Make sure the volume is turned up enough. Press the **Volume** button on the keypad or remote.
- Make sure the correct source is active.
- Make sure that you are connected to an "audio out" connector on the source as opposed to a "line-in" or "microphone" connector.
- Adjust the audio source.
- If playing a video, make sure the playback has not been paused.

Connecting external speakers

The projector can be attached to external amplified speakers by connecting a 3.5mm stereo audio cable from the **Audio Out** connector on the projector to the amplified speakers.

Alternatively, you can bypass the projector's audio system and connect the audio directly from your source to a stereo or home theater system.

connect audio cable

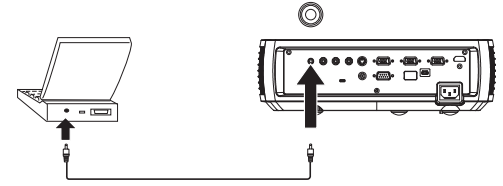

adjust volume

volume

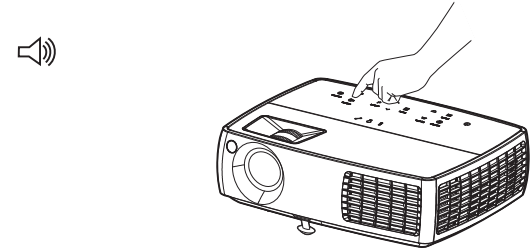

external speakers with own power source

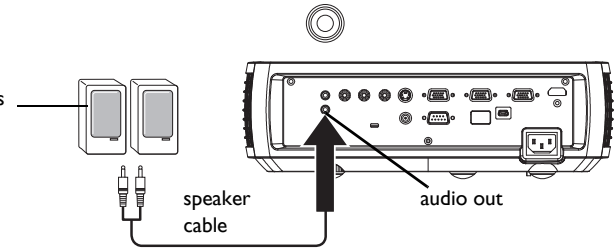

Using the keypad buttons

Most buttons are described in detail in other sections, but here is an overview of their functions:

Power—turns the projector on and off (page 11).

Auto Image—resets the projector to the source.

Presets—cycles through the available preset settings (page 29).

Keystone—adjusts squareness of the image (page 12).

Menu—opens the on-screen menus (page 28).

Select—confirms choices made in the menus (page 28).

Up/Down arrows—navigates to and adjusts settings in the menus (page 28).

Volume—adjusts sound (page 24).

Source—changes the active source (page 11).

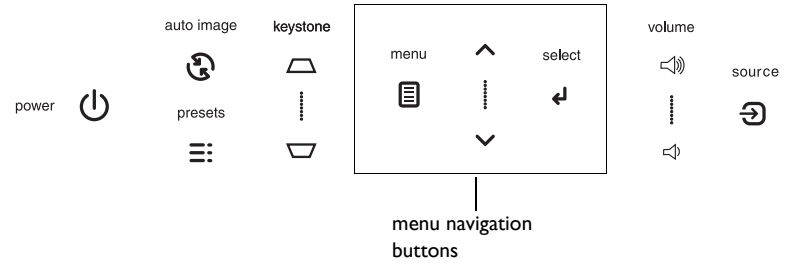

Optimizing computer images

After the projector is running and the image is on the screen, you can optimize the image using the onscreen menus. For general information on using the menus, see page 28.

- Adjust the Keystone, Contrast, or Brightness in the Basic Picture menu (page 29).
- Change the Aspect Ratio. Choose the option that best fits your input source (page 29).
- Adjust the Color Temperature in the Advanced Picture menu (page 29).
- Adjust the Phase, Tracking, or Horizontal or Vertical position in the Advanced Picture menu (page 30).
- Once you have optimized the image for a particular source, you can save the settings using Presets. This allows you to quickly recall these settings later (page 29).
- If your computer is using the projector's DisplayLink connector, see the InFocus DisplayLink Manager User's Guide for information about optimizing images.

Presentation features

Several features are provided to make giving presentations easier. Here is an overview, details are found in the menu section.

- The Custom key allows you to assign various features to the button. The default effect is Source Info, which displays information about the projector and current source. See page 31 for details.
- The Search Screen option lets you change the appearance of the blank screen and start up screen (page 32).
- Two options, Auto Off and Screen Save Time, are provided to automatically shut down the projector after several minutes of inactivity or display a black screen. This helps preserve lamp life (page 31).

Optimizing video images

After your video device is connected properly and the image is on the screen, you can optimize the image using the onscreen menus. For general information on using the menus, see page 28.

- Adjust the Keystone, Contrast, Brightness, Color, or Tint in the Basic Picture menu (page 29).
- Change the Aspect Ratio. Choose the option that best fits your input source (page 29).
- Select a Sharpness setting (page 29).
- Adjust the Color Temperature. Select a listed warmth value (page 30).
- Turn on Overscan to remove noise on the edges of the image (page 30).

Customizing the projector

You can customize the projector for your specific setup and needs. See page 31 to page 32 for details on these features.

- For rear projection, turn Rear Project on in the **Setup** menu.
- For ceiling mounted projection, turn Ceiling Mount on in the **Setup** menu.
- Specify which source the projector checks first for active video during power-up.
- Specify the function of the Custom key on the remote.
- Turn the projector's display messages on and off.
- Turn on power saving features.
- Specify appearance of blank screen and startup screen.
- Specify the language viewed on the menus.
- Save settings for the active source as a preset.

Dynamic Messaging

You can use Command Line Interface (CLI) commands to display text messages on the projector (for example, to display urgent alert messages to employees). This requires a connection to the projector's RS-232 serial control connector. Go to our support website to download the RS-232 command reference for your projector.

Using the menus

To open the menus, press the **Menu** button on the keypad or remote. (The menus automatically close after 60 seconds if no buttons are pressed.) Use the arrow buttons to move up and down to highlight the desired menu, then press the **Select** button.

To change a menu setting, highlight it, press **Select**, then use the up and down arrow buttons to adjust the value or select an option or turn the feature on or off. Press **Select** to confirm your changes. Use the arrows to navigate to another setting. When your adjustments are complete, press **Menu** to access a different menu; press the **Menu** button at any time to navigate to the higher-level menu and ultimately close the menus.

The menus are grouped by usage:

- The Basic Picture menu provides common image adjustments.
- The Advanced Picture menu provides more complex image adjustments.
- The Setup menu provides set-up type adjustments that are not changed often.
- The Status and Service menu provides information about the projector and source.

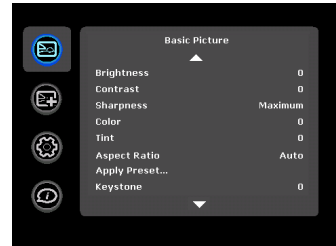
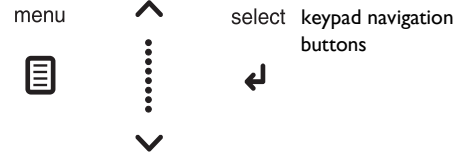

Basic Picture menu

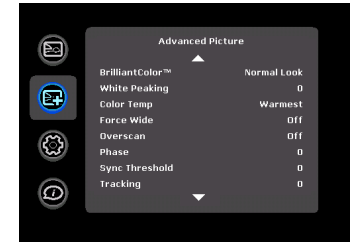

Advanced Picture menu



Setup menu

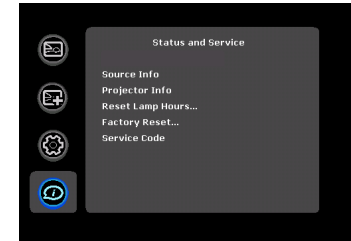

Status and Service menu

Basic Picture menu

To adjust the following settings, highlight the setting, press **Select**, use the up and down arrows to adjust the values, then press **Select** to confirm the changes.

Brightness: changes the intensity of the image.

Contrast: controls the degree of difference between the lightest and darkest parts of the picture and changes the amount of black and white in the image.

Sharpness: (video sources only) changes the clarity of the edges of a video image. Select a sharpness setting.

Color: adjusts a video image from black and white to fully saturated color. The color setting applies to video sources only.

Tint: adjusts the red-green color balance in the image of NTSC video images. The tint setting applies to NTSC video sources only.

Aspect Ratio: Aspect ratio is the ratio of the image width to image height. TV screens are usually 4:3. HDTV and most DVDs are 16:9.

Select Auto to have the projector choose the ratio. Choose Native to see the unmodified input with no resizing by the projector. Select 16:9 to watch enhanced widescreen DVDs.

For more information regarding Aspect Ratio, see page 13.

Apply Preset...: Presets are provided that optimize the projector for displaying computer presentations and video images under certain conditions.

There is also a user-definable preset. To set this preset, adjust the image and select Save User in the Presets menu. You can recall these settings in the future by selecting the User preset.

Keystone: adjusts the image vertically and makes a squarer image. You can also adjust keystone from the keypad.

Digital Zoom: changes the size of projector's display area. If the display area has been resized by this setting, it can be moved by changing the **Horz Shift** and **Vert Shift** settings.

Horz Shift/Vert Shift: moves the display area horizontally or vertically if its size has been changed by the **Digital Zoom** setting.



Basic Picture menu



Aspect ratio

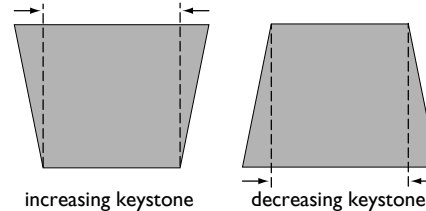

Advanced Picture menu

BrilliantColor™ : produces an expanded on-screen color spectrum that delivers enhanced color saturation for bright, true-to-life images. Choose Normal Look for most video sources and Bright Look for most computer sources.

White Peaking: (video sources only) increases the brightness of whites that are near 100%.

Color Temperature: changes the intensity of the colors. Select a listed relative warmth value.

Force wide: when this is off, the analog locking algorithms choose the standard mode resolution (4:3) as the preferred default resolution. When this is on, the analog locking algorithms choose wide mode resolution (16:10) as the preferred default resolution.

Overscan: removes noise around the video image.

Phase: adjusts the horizontal phase of a computer source.

Sync Threshold: (progressive signals only) If a hardware device, such as a DVD player, is not syncing properly with the projector, select this option to help it to sync when connected to the projector.

Tracking: adjusts the vertical scan of a computer source.

Color Space: This option applies to computer and component video sources. It allows you to select a color space that has been specifically tuned for the input signal. When Auto is selected, the projector automatically determines the standard. To choose a different setting, turn off Auto, then choose RGB for computer sources or choose either REC709 or REC601 for component video sources.

Gamma: select the appropriate gamma from among Video, Film, Bright, and CRT.

Horizontal/Vertical Position: adjusts the position of a computer source.

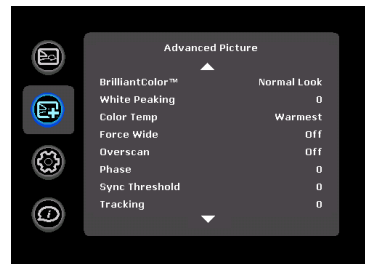

Advanced Picture menu

Setup menu

Language: allows you to select a language for the onscreen display.

Key Click: turns the key click sound on or off. When this setting is on, pressing keys on the keypad causes the projector's speaker to play a "click" sound.

Custom Key: allows you to assign a different function to the Custom button, allowing you to quickly and easily use the effect. Highlight an effect and press **Select** to choose a different one.

- **Source Info:** the default action. Shows the Source Info menu.
- **Projector Info:** Shows the Projector Info menu.
- **Aspect Ratio:** toggles among 4:3, 16:9, and Native (see page 13 and page 29).
- **Auto Image:** resets the projector to the source (page 25).
- **Overscan:** removes noise around the image.
- **Blank Screen:** displays an empty screen.
- **Freeze Screen:** pauses the projected image.
- **Mute:** turns off all sound.
- **Source:** cycles through available sources.

Blank Key: Select what to display when the blank key on the remote is depressed: your custom snapshot, a solid color screen (blue, black or white), the factory logo screen, a timer, or test patterns. The timer option is useful for classroom tests or break times during meetings.

AC Power On: When this feature is on, the projector automatically turns on when electrical power is connected. This allows control of ceiling mounted projectors with a wall power switch.

Auto Off Time: automatically turns the projector off after no signals are detected for a preset number of minutes. If an active signal is received before the projector powers down, the image will be displayed.

Screen Save Time: automatically blanks the screen with a black color after no signals are detected for a preset number of minutes. The image returns when an active source is detected or a remote or keypad button is pressed.

Lamp Low Power: toggles between on and off. Turn it on to lower the light output of the lamp. This also lowers the fan speed, making the projector quieter.

Power Sounds: controls whether the projector makes a sound when powered on and off.

Auto Source: When this feature is On, the projector automatically finds the active source, checking the selected Power-up Source first. When this feature is Off, the projector defaults to the source selected in Power-up Source. To display another source, you must manually select one by pressing the **Source** button on the remote or keypad.



Setup menu

Power-up Source: determines which source the projector checks first for active video during power-up.

HDMI DDC: When this feature is set to On, the projector will support an older DVD player for HDMI port.

Video Standard: When this feature is set to Auto, the projector attempts to automatically pick the video standard based on the input signal it receives. (The video standard options may vary depending on your region of the world.) If the projector is unable to detect the correct standard, the colors may not look right or the image may appear "torn." If this happens, manually select a video standard by selecting NTSC, PAL, or SECAM from the Video Standard menu.

Closed Captions: controls closed caption display while audio is not muted. If this setting is not off, and audio is not muted, and the source is NTSC and

contains captions on the selected channel, then the projector must display caption text overlaid on the image.

Ceiling Mount: turns the image upside down for ceiling-mounted projection.

Rear Project: reverses the image so you can project from behind a translucent screen.

Auto Keystone: automatically adjusts vertical image.

Prevent PC Screen Saver: prevents your computer from going into Screen Save mode. The projector must be connected to the PC via a USB cable for this feature to work.

Search Screen: allows you to display a blank screen instead of the default screen at startup, and when no source is detected.

Take Snapshot...: Captures the current image and allows it to be used as the search screen image.

Show Messages: displays status messages (such as “Searching”) in the lower-left corner of the screen.

Menu Offset: allows you to change the position of the On Screen Display items.

Menu Transparency: allows you to change how much of the projected image behind the menu you can see. As the value increases, more of the image behind the menu is visible.

Magnify Controls: determines whether the select key can be used to change magnify settings when the OSD menu is not visible.

PIN Protect: The PIN (personal identification number) feature allows you to password protect your projector. Once you enable the PIN feature, you must enter the PIN before you can project an image. The default PIN on this projector is **Menu-Up-Down-Select-Source**. Use the navigation buttons on the remote or keypad to enter the correct 5-button press sequence. When all 5 numbers are entered correctly, press the **Select** button on the remote or keypad to select OK. If the message “Wrong PIN” appears, verify the code and re-enter it. If you mis-enter a number, you must enter 5 numbers and

press the **Select** button in order to access the “Wrong PIN” message and re-enter the code.

To enter the PIN at projector startup:

Power up the projector. The “Enter PIN” dialog box appears after the startup screen. Enter the PIN. Use the navigation buttons on the remote or keypad to enter the correct button press sequence. See the description above for instructions.

To change the PIN:

Select “Change PIN...” in the Setup menu. Enter the existing PIN. Enter the new PIN. You can navigate between OK and Cancel by pressing the up and down buttons on the keypad. Select OK or Cancel by pressing the **Select** button. Verify the new PIN.

If you lose or forget your custom PIN:

Contact InFocus support. Go to www.infocus.com/support

Computer 2 SCART: Selects SCART connection type between RGB and composite.

Serial Port, Baud Rate: selects the serial port and baud rate.

Serial Port Echo: controls whether the serial port echoes characters.

Status and Service menu

Source Info: a read-only display of current source settings.

Projector Info: a read-only display of current projector settings.

Reset Lamp Hours: resets the lamp hours used counter in the Projector Info menu to zero. Do this only after changing the lamp.

Factory Reset: restores all settings to their default.

Service Code: only used by authorized service personnel.

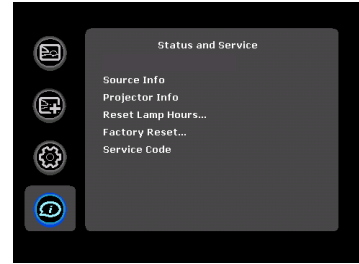

Status and Service menu

Maintenance

Cleaning the lens

- 1 Apply a non-abrasive camera lens cleaner to a soft, dry cloth.
 - Avoid using an excessive amount of cleaner, and don't apply the cleaner directly to the lens. Abrasive cleaners, solvents or other harsh chemicals might scratch the lens.
- 2 Lightly wipe the cleaning cloth over the lens in a circular motion.

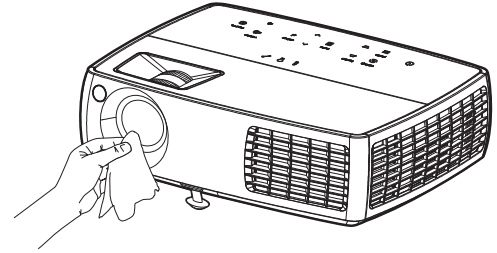

Using the security lock

The projector has a security lock for use with a PC Guardian Cable Lock System. Refer to the information that came with the lock for instructions on how to use it.

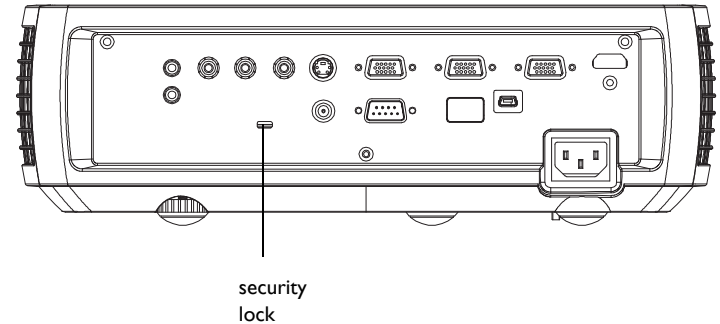

Replacing the projection lamp

The Lamp Hours timer in the Projector Info menu counts the number of hours the lamp has been in use. Twenty hours before the lamp life expires, the message “Replace lamp” appears on the screen at startup.

- **NOTE:** Be sure to use the InFocus lamp module designed for this projector. You can order new lamps from www.infocus.com (in select areas), your retailer or your dealer. **Only genuine InFocus lamps are tested for use in this projector.** Use of non InFocus lamps may cause electrical shock and fire, and may void the projector warranty. InFocus is not liable for the performance, safety or certification of any other lamps.

WARNINGS:

- The projector uses a high-pressure mercury glass lamp. The lamp may fail prematurely, or it may rupture with a popping sound if jolted, scratched, or handled while hot. The risk of lamp failure or rupture also increases as the lamp age increases; please replace the lamp when you see the “Replace Lamp” message.
- To avoid burns, allow the projector to cool for at least 60 minutes before you replace the lamp.
- Unplug the power cord before replacing the lamp.
- Do not drop the lamp module. The glass may shatter and cause injury.
- Do not touch the glass surface of the lamp module. Fingerprints can obscure projection sharpness and may cause the glass to shatter.
- Be extremely careful when removing the lamp housing. In the unlikely event that the lamp ruptures, small glass fragments may be generated. The lamp module is designed to contain most of these fragments, but use caution when removing it.
- Before replacing a ruptured lamp, clean the lamp compartment and dispose of cleaning materials. Wash hands after lamp replacement.
- When replacing the lamp while the projector is ceiling-mounted, wear protective eyewear to prevent eye injury.

- Hg – Lamp contains mercury. Manage in accordance with local disposal laws. See www.lamprecycle.org.

- 1 Turn off the projector and unplug the power cord.
- 2 Wait 60 minutes to allow the projector to cool thoroughly.
- 3 Remove the lamp door by: (a) removing the screw (labeled “1”) on the side of the lamp door, (b) turning the lamp cover knob (labeled “2”) counterclockwise to push up the lamp cover, and (c) lifting the door off.

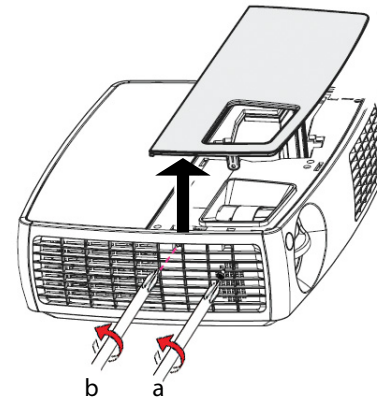
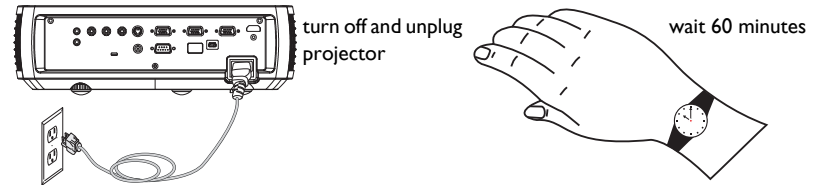

- 4 Loosen the captive screws that attach the lamp housing to the projector. Carefully remove the lamp housing. Dispose of the lamp in an environmentally proper manner.
- 5 Install the new lamp module and tighten the screws.
- 6 Replace the lamp door by sliding it into place.
- 7 Plug in the power cord and press the **Power** button to turn the projector back on.
- 8 To reset the lamp hour timer, navigate to the **Status and Service** menu and select **Reset Lamp Hours** (page 33).

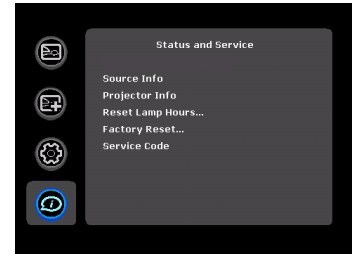
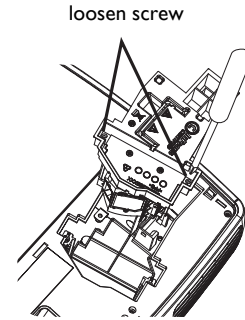

INDEX

Numerics

- 16x9 vs 4x3 12
- 5 volt DC output 4

A

- AC Power On 30
- Advanced menu 29
- Apply Preset 28
- Aspect Ratio 12, 28, 30
- Audio In Computer connector 9
- Audio In connector 13
- Audio Out connector 23
- Auto Image 30
- Auto Off Time 30
- Auto Source 30

B

- Blank Key 30
- Blank Screen 30
- Brightness 28
- BrilliantColor 29

C

- cable box 12
- Ceiling Mount 30
- Cleaning the lens 33
- Closed Captions 30
- Color Space 29
- Color Temperature 29
- Computer In connector 9
- Connecting
 - external speakers 23
 - computer 9
 - video device 12
- Connector on Projector 7, 8
- Connector panel 4
- contacting InFocus 21
- Contrast 28
- Custom Key 30
- Custom key 25
- customer service contact information 21

- Customizing the projector 26

D

- DVDs 28

F

- Factory Reset 32
- focus 11
- Force wide 29
- Freeze Screen 30

G

- Gamma 29

H

- HDMI 1.3 connection 13
- HDMI DDC 30
- HDTV 6, 28
- Horizontal 29

I

- Image
 - Size 5
 - Optimization 25

K

- Key Click 30
- keypad buttons 24
- Keystone 28
- keystone, adjusting 11

L

- Lamp hours, resetting 35
- Lamp Low Power 30
- Language 30
- laptop video port activation 10
- LEDs 14
- leveling foot 11

M

- Maintaining the projector 33
- Menu button 27
- menu usage 27
- Monitor Out connector 9
- Mute 30

O

- Optimizing images 25
- Optimizing video 26

Overscan 29, 30

P

Phase 29

Picture menu 28

Power connector 9

power cord 9

Power Sounds 30

Power-up Source 30

Presentation features 25

Projection distance 5

Projector

Connector panel 4

Customization 26

Image Size 5

keypad buttons 24

Maintenance 33

menus 27

offset 5

Registering 3

security lock 33

Status indicator panel 14

connecting computers 9

connecting video devices 12

positioning 5

setting up 5

shutting down 14

troubleshooting problems 14

Projector Info 30

R

Rear 31

Registering your projector 3

remote control 22

Reset 32

Resetting the projector 32

RS-232 4

S

Safety Considerations 2

Screen Aspect 12

Screen Save 14, 30

Screen triggers 4

Search Screen 31

security lock 33

Service 32

Service Code 32

Sharpness 28

shutting down the projector 14

Source 30

Source Info 30

speakers, connecting external 23

Status indicator panel 14

S-video connector 13

Sync Threshold 29

T

Tint 28

Tracking 29

troubleshooting 14

TV tuner 12

U

USB 4, 9

V

Vertical 29

video optimizing 26

Video Standard 30

Volume button 23

W

warranty 21

White Peaking 29

Z

zoom 11