



DLP® Projector

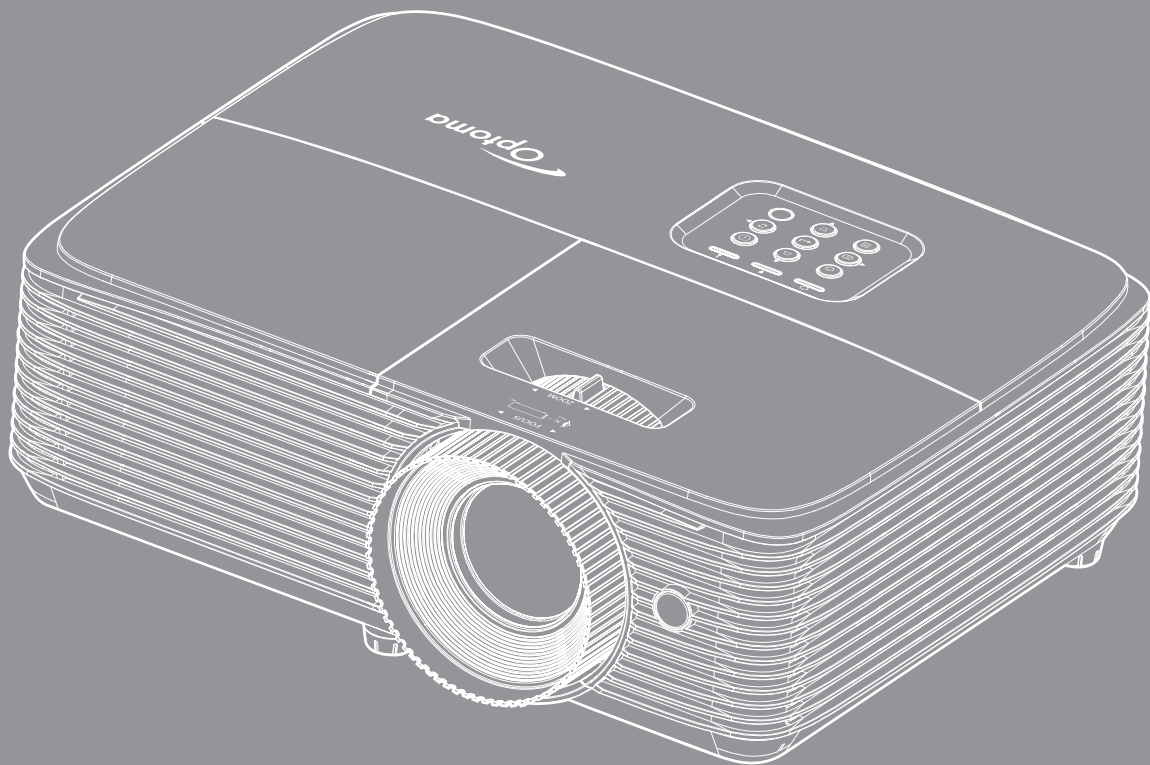

TABLE OF CONTENTS

| | |
|---|-----------|
| SAFETY | 4 |
| <i>Important Safety Instruction.....</i> | <i>4</i> |
| <i>3D Safety Information.....</i> | <i>5</i> |
| <i>Copyright.....</i> | <i>6</i> |
| <i>Disclaimer.....</i> | <i>6</i> |
| <i>Trademark Recognition</i> | <i>6</i> |
| <i>FCC</i> | <i>7</i> |
| <i>Declaration of Conformity for EU countries</i> | <i>7</i> |
| <i>WEEE.....</i> | <i>7</i> |
| INTRODUCTION..... | 8 |
| <i>Package Overview.....</i> | <i>8</i> |
| <i>Standard accessories.....</i> | <i>8</i> |
| <i>Optional accessories.....</i> | <i>8</i> |
| <i>Product Overview</i> | <i>9</i> |
| <i>Connections.....</i> | <i>10</i> |
| <i>Keypad</i> | <i>13</i> |
| <i>Remote control 1</i> | <i>14</i> |
| <i>Remote control 2.....</i> | <i>15</i> |
| <i>Remote control 3.....</i> | <i>16</i> |
| <i>Remote control 4.....</i> | <i>17</i> |
| SETUP AND INSTALLATION..... | 18 |
| <i>Installing the projector</i> | <i>18</i> |
| <i>Adjusting the projector image.....</i> | <i>28</i> |
| USING THE PROJECTOR..... | 31 |
| <i>Powering on / off the projector.....</i> | <i>31</i> |
| <i>Selecting an input source</i> | <i>32</i> |
| <i>Menu navigation and features</i> | <i>33</i> |
| <i>OSD Menu tree (WUXGA and 1080P models).....</i> | <i>35</i> |
| <i>OSD Menu tree (SVGA, XGA, and WXGA models)</i> | <i>44</i> |
| <i>Display image settings menu.....</i> | <i>51</i> |
| <i>Display 3D menu</i> | <i>54</i> |
| <i>Display aspect ratio menu</i> | <i>54</i> |
| <i>Display edge mask menu</i> | <i>61</i> |
| <i>Display zoom menu.....</i> | <i>61</i> |
| <i>Display image shift menu</i> | <i>61</i> |
| <i>Display keystone menu</i> | <i>61</i> |
| <i>Audio mute menu</i> | <i>61</i> |
| <i>Audio volume menu.....</i> | <i>61</i> |
| <i>Setup projection menu.....</i> | <i>62</i> |
| <i>Setup screen type menu.....</i> | <i>62</i> |

| | |
|--|----|
| <i>Setup lamp settings menu</i> | 62 |
| <i>Setup filter settings menu</i> | 62 |
| <i>Setup power settings menu</i> | 62 |
| <i>Setup security menu</i> | 63 |
| <i>Setup HDMI link settings menu</i> | 64 |
| <i>Setup test pattern menu</i> | 64 |
| <i>Setup remote settings menu</i> | 64 |
| <i>Setup projector ID menu</i> | 65 |
| <i>Setup options menu</i> | 65 |
| <i>Setup reset menu</i> | 66 |
| <i>Network LAN menu</i> | 66 |
| <i>Network control menu</i> | 67 |
| <i>Setup network control settings menu</i> | 68 |
| <i>Info menu</i> | 73 |

MAINTENANCE 74

| | |
|--|----|
| <i>Replacing the lamp</i> | 74 |
| <i>Installing and cleaning the dust filter</i> | 76 |

ADDITIONAL INFORMATION 77

| | |
|--|----|
| <i>Compatible resolutions</i> | 77 |
| <i>Image size and projection distance</i> | 80 |
| <i>Projector dimensions and ceiling mount installation</i> | 84 |
| <i>IR remote control 1 codes</i> | 85 |
| <i>IR remote control 2 codes</i> | 87 |
| <i>IR remote control 3 codes</i> | 89 |
| <i>IR remote control 4 codes</i> | 91 |
| <i>Troubleshooting</i> | 93 |
| <i>Warning indicators</i> | 95 |
| <i>Specifications</i> | 97 |
| <i>Optoma global offices</i> | 98 |

SAFETY

| | |
|---|---|
|  | The lightning flash with arrow head within an equilateral triangle is intended to alert the user to the presence of uninsulated "dangerous voltage" within the product's enclosure that may be of sufficient magnitude to constitute a risk of electric shock to persons. |
|  | The exclamation point within an equilateral triangle is intended to alert the user to the presence of important operating and maintenance (servicing) instructions in the literature accompanying the appliance. |

Please follow all warnings, precautions and maintenance as recommended in this user's guide.

Important Safety Instruction



- Do not stare into the beam, RG2.
As with any bright source, do not stare into the direct beam, RG2 IEC 62471-5:2015.
- Do not block any ventilation openings. To ensure reliable operation of the projector and to protect from over heating, it is recommended to install the projector in a location that does not block ventilation. As an example, do not place the projector on a crowded coffee table, sofa, bed, etc. Do not put the projector in an enclosure such as a book case or a cabinet that restricts air flow.
- To reduce the risk of fire and/or electric shock, do not expose the projector to rain or moisture. Do not install near heat sources such as radiators, heaters, stoves or any other apparatus such as amplifiers that emits heat.
- Do not let objects or liquids enter the projector. They may touch dangerous voltage points and short out parts that could result in fire or electric shock.
- Do not use under the following conditions:
 - In extremely hot, cold or humid environments.
 - (i) Ensure that the ambient room temperature is within 5°C ~ 40°C
 - (ii) Relative humidity is 10% ~ 85%
 - In areas susceptible to excessive dust and dirt.
 - Near any appliance generating a strong magnetic field.
 - In direct sunlight.
- Do not use the projector in places where flammable gases or explosives gases may be present in the atmosphere. The lamp inside the projector becomes very hot during operation and the gases may ignite and result in a fire.
- Do not use the unit if it has been physically damaged or abused. Physical damage/abuse would be (but not limited to):
 - Unit has been dropped.
 - Power supply cord or plug has been damaged.
 - Liquid has been spilled on to the projector.
 - Projector has been exposed to rain or moisture.
 - Something has fallen in the projector or something is loose inside.
- Do not place the projector on an unstable surface. The projector may fall over resulting in injury or the projector may become damaged.
- Do not block the light coming out of the projector lens when in operation. The light will heat the object and could melt, cause burns or start a fire.

- Please do not open or disassemble the projector as this may cause electric shock.
- Do not attempt to service the unit yourself. Opening or removing covers may expose you to dangerous voltages or other hazards. Please call Optoma before you send the unit for repair.
- See projector enclosure for safety related markings.
- The unit should only be repaired by appropriate service personnel.
- Only use attachments/accessories specified by the manufacturer.
- Do not look into straight into the projector lens during operation. The bright light may harm your eyes.
- When replacing the lamp, please allow the unit to cool down. Follow instructions as described on pages 74-75.
- This projector will detect the life of the lamp itself. Please be sure to change the lamp when it shows warning messages.
- Reset the "Lamp Reset" function from the on-screen display "Setup lamp settings" menu after replacing the lamp module.
- When switching the projector off, please ensure the cooling cycle has been completed before disconnecting power. Allow 90 seconds for the projector to cool down.
- When the lamp is approaching to the end of its life time, the message "Lamp life exceeded." will show on the screen. Please contact your local reseller or service center to change the lamp as soon as possible.
- Turn off and unplug the power plug from the AC outlet before cleaning the product.
- Use a soft dry cloth with mild detergent to clean the display housing. Do not use abrasive cleaners, waxes or solvents to clean the unit.
- Disconnect the power plug from AC outlet if the product is not being used for a long period of time.

Note: *When the lamp reaches the end of its life, the projector will not turn back on until the lamp module has been replaced. To replace the lamp, follow the procedures listed under "Replacing the Lamp" section on pages 74-75.*

- *Do not setup the projector in places where it might be subjected to vibration or shock.*
- *Do not touch the lens with bare hands*
- *Remove battery/batteries from remote control before storage. If the battery/batteries are left in the remote for long periods, they may leak.*
- *Do not use or store the projector in places where smoke from oil or cigarettes may be present, as it can adversely affect the quality of the projector performance.*
- *Please follow the correct projector orientation installation as non standard installation may affect the projector performance.*
- *Use a power strip and or surge protector. As power outages and brown-outs can KILL devices.*

3D Safety Information

Please follow all warnings and precautions as recommended before you or your child use the 3D function.

Warning

Children and teenagers may be more susceptible to health issues associated with viewing in 3D and should be closely supervised when viewing these images.

Photosensitive Seizure Warning and Other Health Risks

- Some viewers may experience an epileptic seizure or stroke when exposed to certain flashing images or lights contained in certain Projector pictures or video games. If you suffer from, or have a family history of epilepsy or strokes, please consult with a medical specialist before using the 3D function.
- Even those without a personal or family history of epilepsy or stroke may have an undiagnosed condition that can cause photosensitive epileptic seizures.
- Pregnant women, the elderly, sufferers of serious medical conditions, those who are sleep deprived or under the influence of alcohol should avoid utilizing the unit's 3D functionality.

- If you experience any of the following symptoms, stop viewing 3D pictures immediately and consult a medical specialist: (1) altered vision; (2) light-headedness; (3) dizziness; (4) involuntary movements such as eye or muscle twitching; (5) confusion; (6) nausea; (7) loss of awareness; (8) convulsions; (9) cramps; and/ or (10) disorientation. Children and teenagers may be more likely than adults to experience these symptoms. Parents should monitor their children and ask whether they are experiencing these symptoms.
- Watching 3D projection may also cause motion sickness, perceptual after effects, disorientation, eye strain and decreased postural stability. It is recommended that users take frequent breaks to lessen the potential of these effects. If your eyes show signs of fatigue or dryness or if you have any of the above symptoms, immediately discontinue use of this device and do not resume using it for at least thirty minutes after the symptoms have subsided.
- Watching 3D projection while sitting too close to the screen for an extended period of time may damage your eyesight. The ideal viewing distance should be at least three times the screen height. It is recommended that the viewer's eyes are level with the screen.
- Watching 3D projection while wearing 3D glasses for an extended period of time may cause a headache or fatigue. If you experience a headache, fatigue or dizziness, stop viewing the 3D projection and rest.
- Do not use the 3D glasses for any other purpose than for watching 3D projection.
- Wearing the 3D glasses for any other purpose (as general spectacles, sunglasses, protective goggles, etc.) may be physically harmful to you and may weaken your eyesight.
- Viewing in 3D projection may cause disorientation for some viewers. Accordingly, DO NOT place your 3D PROJECTOR near open stairwells, cables, balconies, or other objects that can be tripped over, run into, knocked down, broken or fallen over.

Copyright

This publication, including all photographs, illustrations and software, is protected under international copyright laws, with all rights reserved. Neither this manual, nor any of the material contained herein, may be reproduced without written consent of the author.

© Copyright 2018

Disclaimer

The information in this document is subject to change without notice. The manufacturer makes no representations or warranties with respect to the contents hereof and specifically disclaims any implied warranties of merchantability or fitness for any particular purpose. The manufacturer reserves the right to revise this publication and to make changes from time to time in the content hereof without obligation of the manufacturer to notify any person of such revision or changes.

Trademark Recognition

Kensington is a U.S. registered trademark of ACCO Brand Corporation with issued registrations and pending applications in other countries throughout the world.

HDMI, the HDMI Logo, and High-Definition Multimedia Interface are trademarks or registered trademarks of HDMI Licensing LLC in the United States and other countries.

DLP®, DLP Link and the DLP logo are registered trademarks of Texas Instruments and BrilliantColor™ is a trademark of Texas Instruments.

All other product names used in this manual are the properties of their respective owners and are Acknowledged.

DARBEE is a trademark by Darbee Products, Inc.

MHL, Mobile High-Definition Link and the MHL Logo are trademarks or registered trademarks of MHL Licensing, LLC.

FCC

This device has been tested and found to comply with the limits for a Class B digital device pursuant to Part 15 of the FCC rules. These limits are designed to provide reasonable protection against harmful interference in a residential installation. This device generates, uses and can radiate radio frequency energy and, if not installed and used in accordance with the instructions, may cause harmful interference to radio communications.

However, there is no guarantee that interference will not occur in a particular installation. If this device does cause harmful interference to radio or television reception, which can be determined by turning the device off and on is encouraged to try to correct the interference by one or more of the following measures:

- Reorient or relocate the receiving antenna.
- Increase the separation between the device and receiver.
- Connect the device into an outlet on a circuit different from that to which the receiver is connected.
- Consult the dealer or an experienced radio/television technician for help.

Notice: Shielded cables

All connections to other computing devices must be made using shielded cables to maintain compliance with FCC regulations.

Caution

Changes or modifications not expressly approved by the manufacturer could void the user's authority, which is granted by the Federal Communications Commission, to operate this projector.

Operation Conditions

This device complies with Part 15 of the FCC Rules. Operation is subject to the following two conditions:

1. This device may not cause harmful interference and
2. This device must accept any interference received, including interference that may cause undesired operation.

Notice: Canadian users

This Class B digital apparatus complies with Canadian ICES-003.

Remarque à l'intention des utilisateurs canadiens

Cet appareil numérique de la classe B est conforme à la norme NMB-003 du Canada.

Declaration of Conformity for EU countries

- EMC Directive 2014/30/EC (including amendments)
- Low Voltage Directive 2014/35/EC
- R & TTE Directive 1999/5/EC (if product has RF function)

WEEE



Disposal instructions

Do not throw this electronic device into the trash when discarding. To minimize pollution and ensure utmost protection of the global environment, please recycle it.

INTRODUCTION

Package Overview

Carefully unpack and verify that you have the items listed below under standard accessories. Some of the items under optional accessories may not be available depending on the model, specification and your region of purchase. Please check with your place of purchase. Some accessories may vary from region to region.

The warranty card is only supplied in some specific regions. Please consult your dealer for detailed information.

Standard accessories

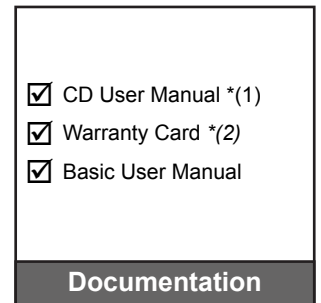
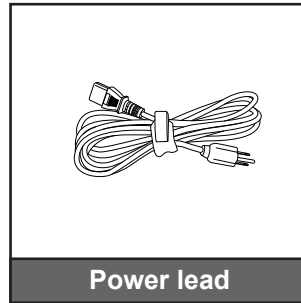
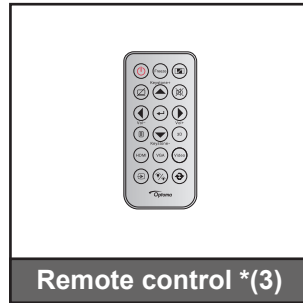
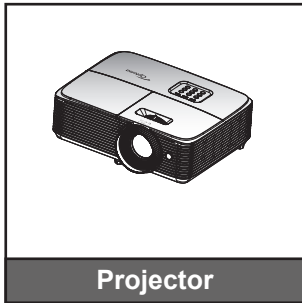

Note:

- *The remote control is shipped with the battery.*
- *^{*(1)} For European User Manual please visit www.optomaeurope.com.*
- *^{*(2)} For European warranty information please visit www.optomaeurope.com.*
- *^{*(3)} The actual remote control may vary depending on the region.*

Optional accessories

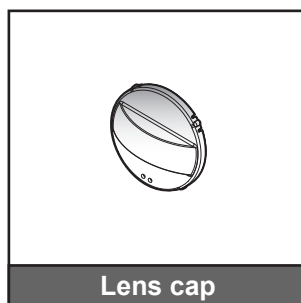
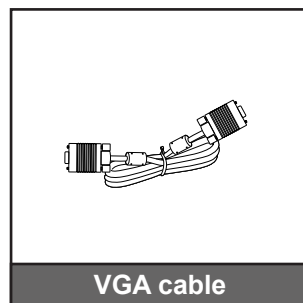

Note: *Optional accessories vary depending on model, specification and region.*

INTRODUCTION

Product Overview

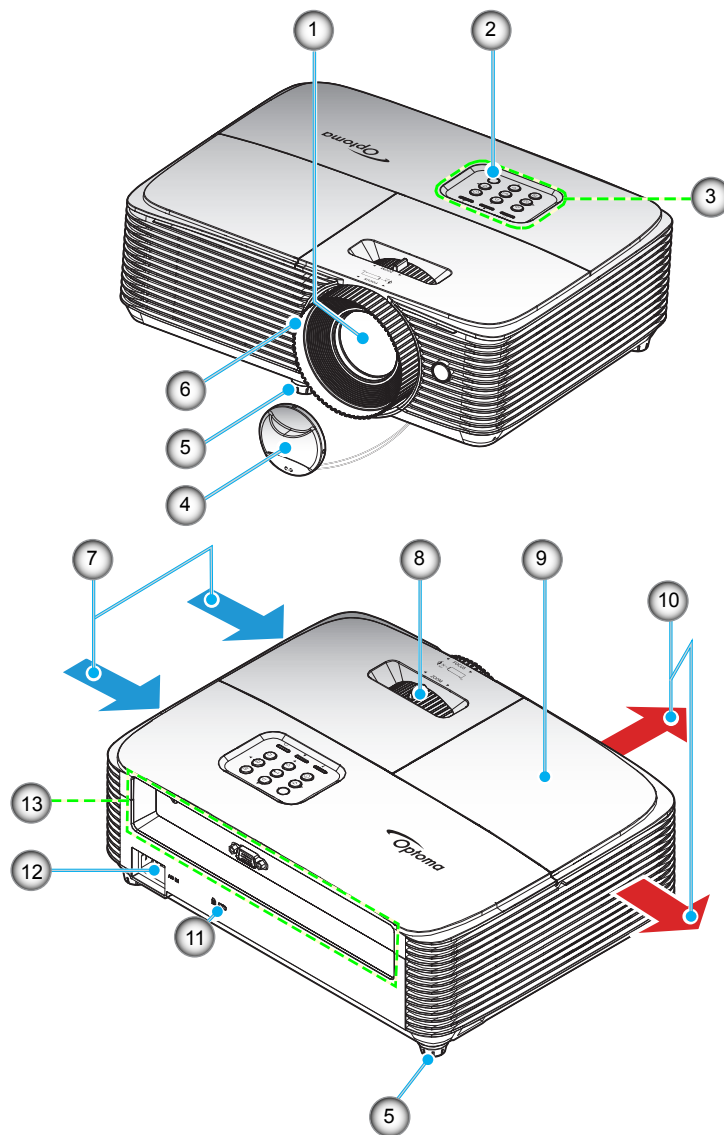

Note: Keep a minimum distance of 20 cm between the “inlet” and “outlet” labels.

| No | Item | No | Item |
|----|----------------------|-----|-----------------------|
| 1. | Lens | 8. | Zoom Lever |
| 2. | IR Receiver | 9. | Lamp Cover |
| 3. | Keypad | 10. | Ventilation (outlet) |
| 4. | Lens Cap | 11. | Kensington™ Lock Port |
| 5. | Tilt-Adjustment Foot | 12. | Power Socket |
| 6. | Focus Ring | 13. | Input / Output |
| 7. | Ventilation (inlet) | | |

INTRODUCTION

Connections

WUXGA_1080P (Type 1 (8 IO))

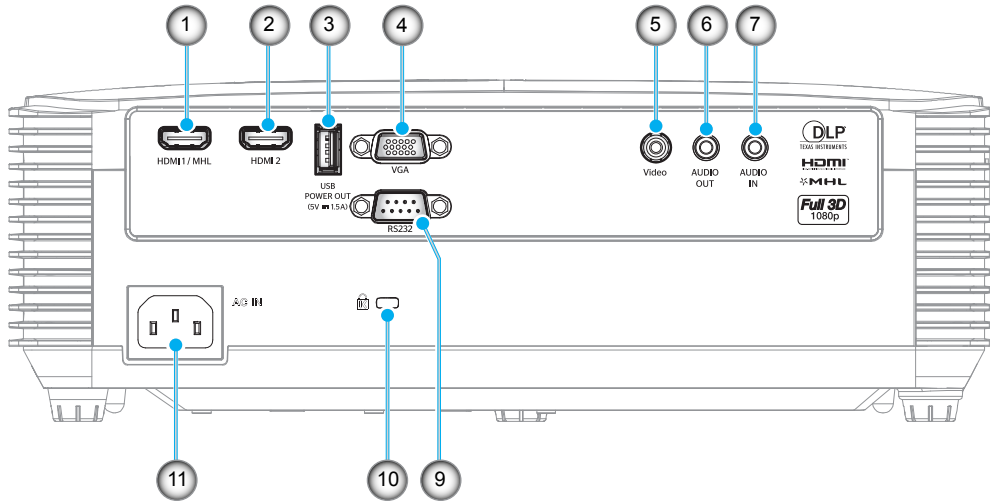

WUXGA_1080P (Type 2 (9 IO))

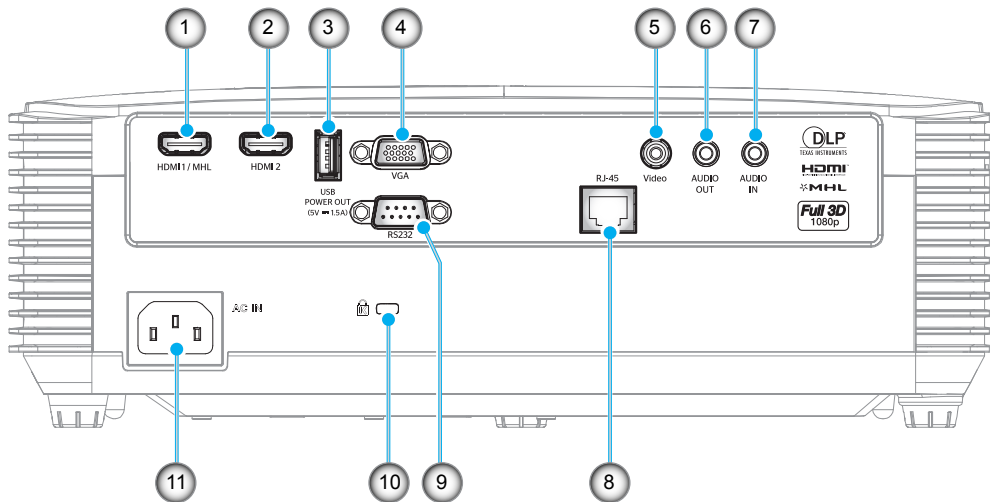

| No | Item | Type 1 (8 IO) | Type 2 (9 IO) |
|-----|---|---------------|---------------|
| 1. | HDMI 1 / MHL Connector | √ | √ |
| 2. | HDMI 2 Connector | √ | √ |
| 3. | USB Power Out (5V---1.5A) Connector / MOUSE / SERVICE Connector | √ | √ |
| 4. | VGA Connector | √ | √ |
| 5. | Video Connector | √ | √ |
| 6. | AUDIO OUT Connector | √ | √ |
| 7. | AUDIO IN Connector | √ | √ |
| 8. | RJ-45 Connector | N/A | √ |
| 9. | RS-232 Connector | √ | √ |
| 10. | Kensington™ Lock Port | √ | √ |
| 11. | Power Socket | √ | √ |

Note: “√” means the item is supported, “N/A” means the item is not available.

Note:

- Remote mouse requires special remote control.
- The I/Os depend on the projector you purchased, please check the physical product for reference.

INTRODUCTION

SVGA_XGA_WXGA (Type 3 (3 IO))

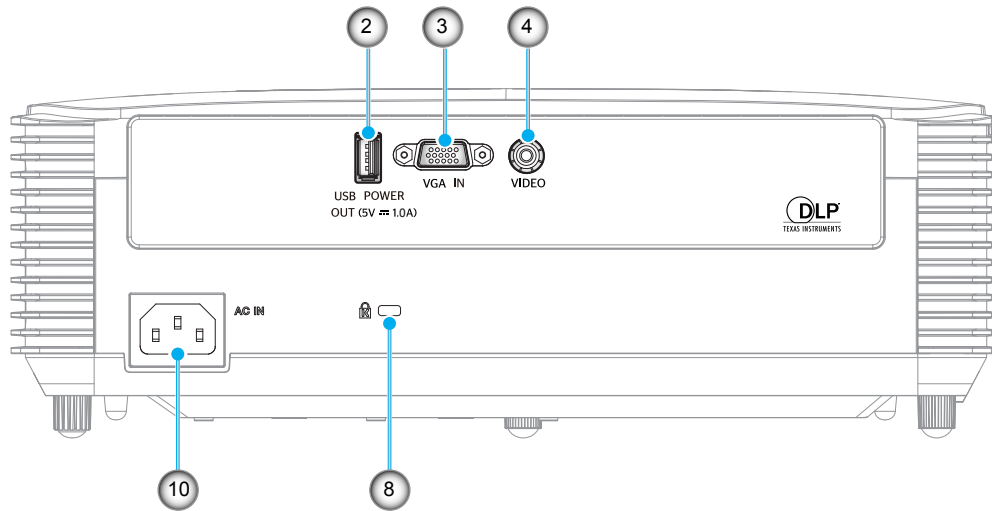

SVGA_XGA_WXGA (Type 4 (6 IO))

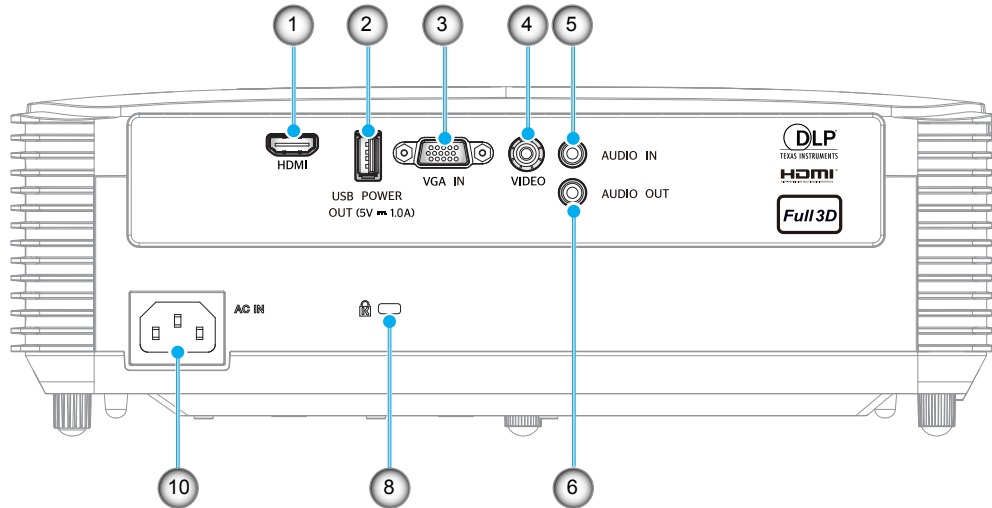

SVGA_XGA_WXGA (Type 5 (8 IO))

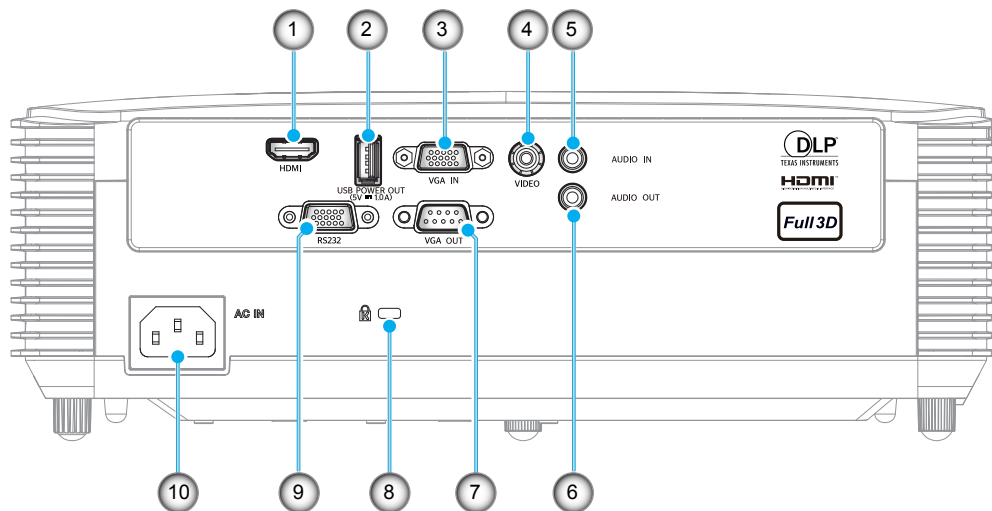

INTRODUCTION

| No | Item | Type 3 (3 IO) | Type 4 (6 IO) | Type 5 (8 IO) |
|-----|--|---------------|---------------|---------------|
| 1. | HDMI Connector | N/A | √ | √ |
| 2. | USB Power Out (5V $\overline{=}$ 1A) Connector / MOUSE / SERVICE Connector | √ | √ | √ |
| 3. | VGA IN Connector | √ | √ | √ |
| 4. | VIDEO Connector | √ | √ | √ |
| 5. | AUDIO IN Connector | N/A | √ | √ |
| 6. | AUDIO OUT Connector | N/A | √ | √ |
| 7. | VGA OUT Connector | N/A | N/A | √ |
| 8. | Kensington™ Lock Port | √ | √ | √ |
| 9. | RS232 Connector | N/A | N/A | √ |
| 10. | Power Socket | √ | √ | √ |

Note: “√” means the item is supported, “N/A” means the item is not available.

Note:

- Remote mouse requires special remote control.
- The I/Os depend on the projector you purchased, please check the physical product for reference.

INTRODUCTION

Keypad

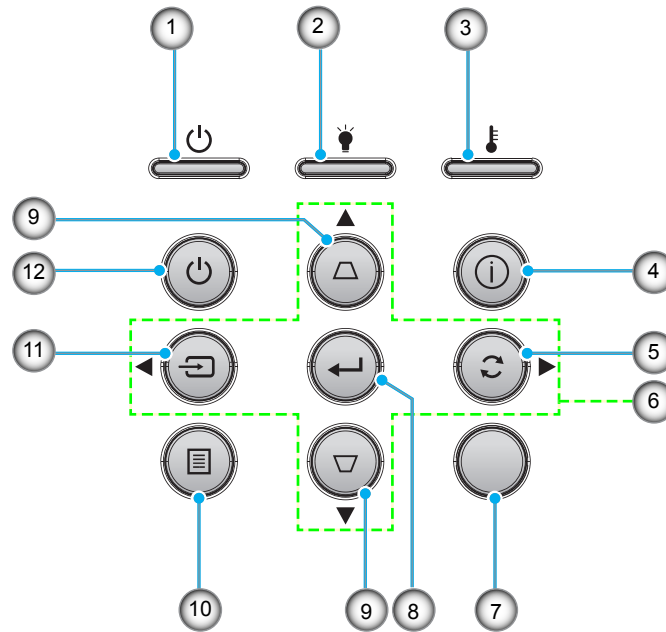

| No | Item | No | Item |
|----|------------------------------|-----|---------------------|
| 1. | On/Standby LED | 7. | IR Receiver |
| 2. | Lamp LED | 8. | Enter |
| 3. | Temp LED | 9. | Keystone Correction |
| 4. | Information | 10. | Menu |
| 5. | Re-Sync | 11. | Source |
| 6. | Four Directional Select Keys | 12 | Power |

INTRODUCTION

Remote control 1

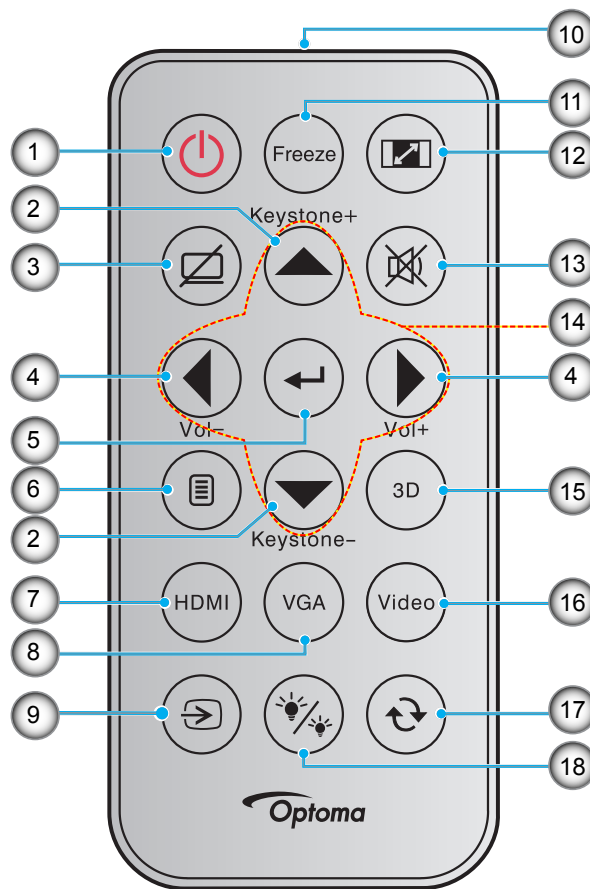

| No | Item | No | Item |
|----|----------------|-----|------------------------------|
| 1. | Power On / Off | 10. | IR LED Indicator |
| 2. | Keystone + / - | 11. | Freeze |
| 3. | AV Mute | 12. | Aspect Ratio |
| 4. | Volume - / + | 13. | Mute |
| 5. | Enter | 14. | Four Directional Select Keys |
| 6. | Menu | 15. | 3D |
| 7. | HDMI | 16. | Video |
| 8. | VGA | 17. | Resync |
| 9. | Source | 18. | Brightness Mode |

Note:

- The actual remote control may vary depending on the region.
- Some keys may have no function for models that do not support these features.
- Before using the remote control for the first time, remove the transparent insulation tape. See page 29 for battery installation.

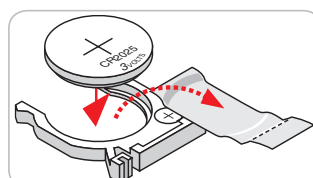

INTRODUCTION

Remote control 2

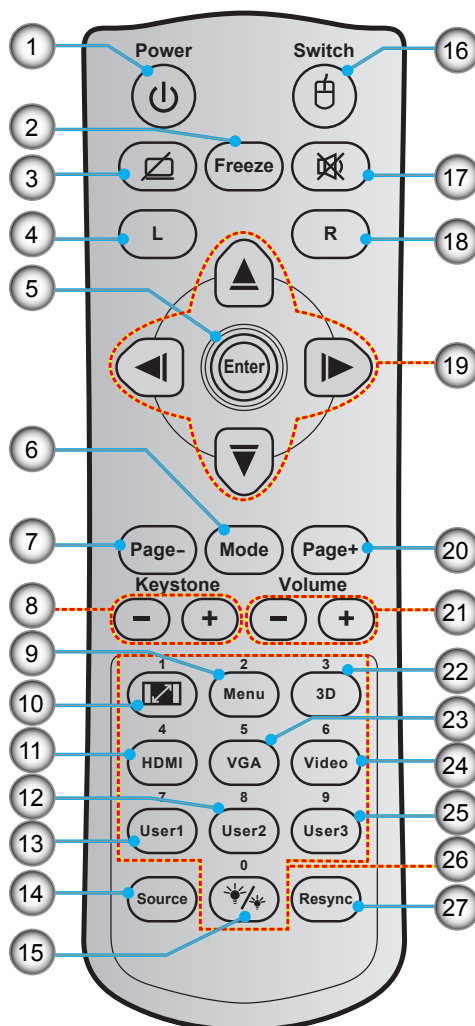

| No | Item | No | Item |
|-----|----------------------------|-----|------------------------------|
| 1. | Power On / Off | 15. | Brightness Mode |
| 2. | Freeze | 16. | Mouse On / Off |
| 3. | Display Blank / Audio Mute | 17. | Mute |
| 4. | Mouse Left Click | 18. | Mouse Right Click |
| 5. | Enter | 19. | Four Directional Select Keys |
| 6. | Mode | 20. | Page + |
| 7. | Page - | 21. | Volume - / + |
| 8. | Keystone - / + | 22. | 3D Menu On / Off |
| 9. | Menu | 23. | VGA |
| 10. | Aspect Ratio | 24. | Video |
| 11. | HDMI | 25. | User 3 |
| 12. | User 2 | 26. | Numeric Keypad (0-9) |
| 13. | User 1 | 27. | Resync |
| 14. | Source | | |

Note:

- The actual remote control may vary depending on the region.
- Some keys may have no function for models that do not support these features.

INTRODUCTION

Remote control 3

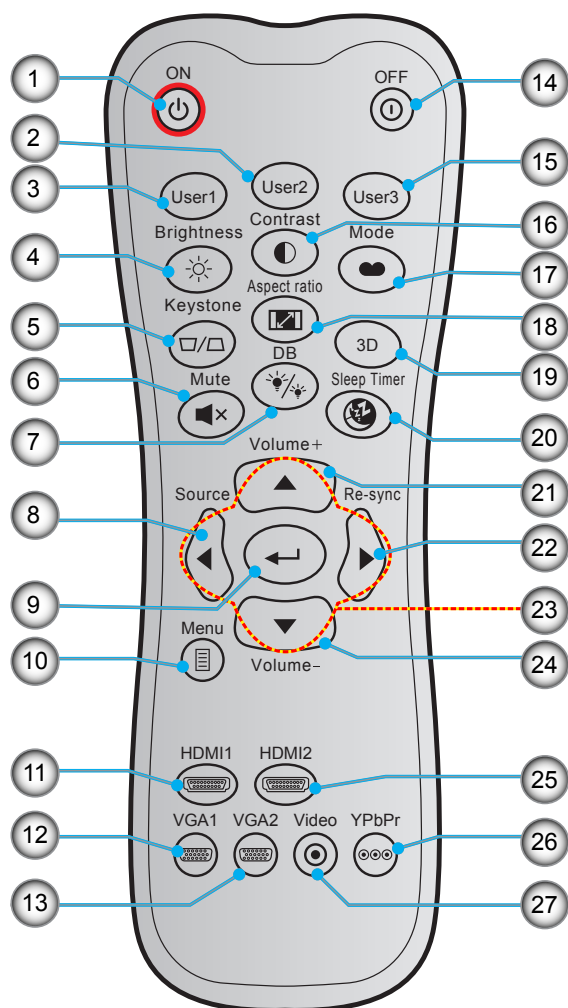

| No | Item | No | Item |
|-----|----------------------|-----|------------------------------|
| 1. | Power On | 15. | User 3 |
| 2. | User 2 | 16. | Contrast |
| 3. | User 1 | 17. | Display Mode |
| 4. | Brightness | 18. | Aspect Ratio |
| 5. | Keystone | 19. | 3D Menu On / Off |
| 6. | Mute | 20. | Sleep Timer |
| 7. | DB (Dynamic Black) | 21. | Volume + |
| 8. | Source | 22. | Re-Sync |
| 9. | Enter | 23. | Four Directional Select Keys |
| 10. | Menu | 24. | Volume - |
| 11. | HDMI1 | 25. | HDMI2 |
| 12. | VGA1 (not supported) | 26. | YPbPr (not supported) |
| 13. | VGA2 (not supported) | 27. | Video (not supported) |
| 14. | Power Off | | |

Note:

- The actual remote control may vary depending on the region.
- Some keys may have no function for models that do not support these features.

INTRODUCTION

Remote control 4

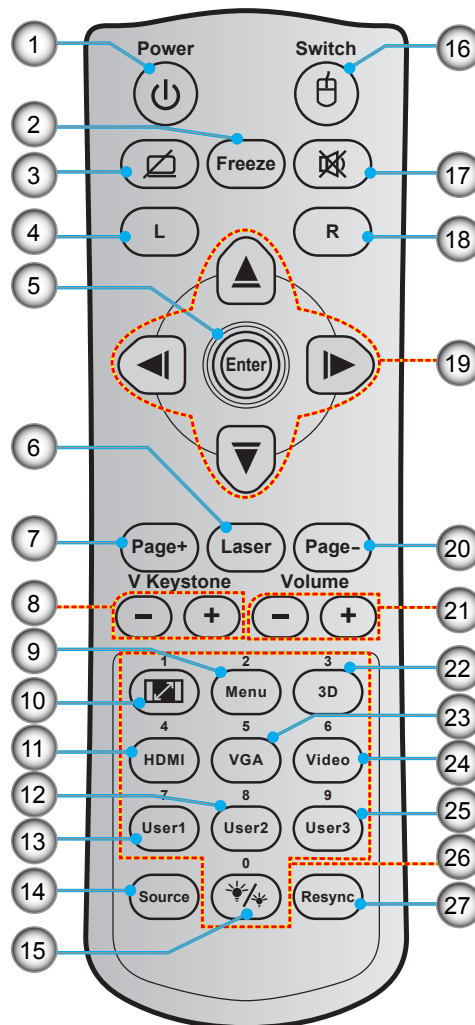

| No | Item | No | Item |
|-----|----------------------------|-----|------------------------------|
| 1. | Power On / Off | 15. | Brightness Mode |
| 2. | Freeze | 16. | Mouse On / Off |
| 3. | Display Blank / Audio Mute | 17. | Mute |
| 4. | Mouse Left Click | 18. | Mouse Right Click |
| 5. | Enter | 19. | Four Directional Select Keys |
| 6. | Laser | 20. | Page - |
| 7. | Page + | 21. | Volume - / + |
| 8. | V Keystone - / + | 22. | 3D Menu On / Off |
| 9. | Menu | 23. | VGA |
| 10. | Aspect Ratio | 24. | Video |
| 11. | HDMI | 25. | User 3 |
| 12. | User 2 | 26. | Numeric Keypad (0-9) |
| 13. | User 1 | 27. | Resync |
| 14. | Source | | |

Note:

- The actual remote control may vary depending on the region.
- Some keys may have no function for models that do not support these features.

SETUP AND INSTALLATION

Installing the projector

Your projector is designed to be installed in one of four possible positions.

Your room layout or personal preference will dictate which installation location you select. Take into consideration the size and position of your screen, the location of a suitable power outlet, as well as the location and distance between the projector and the rest of your equipment.

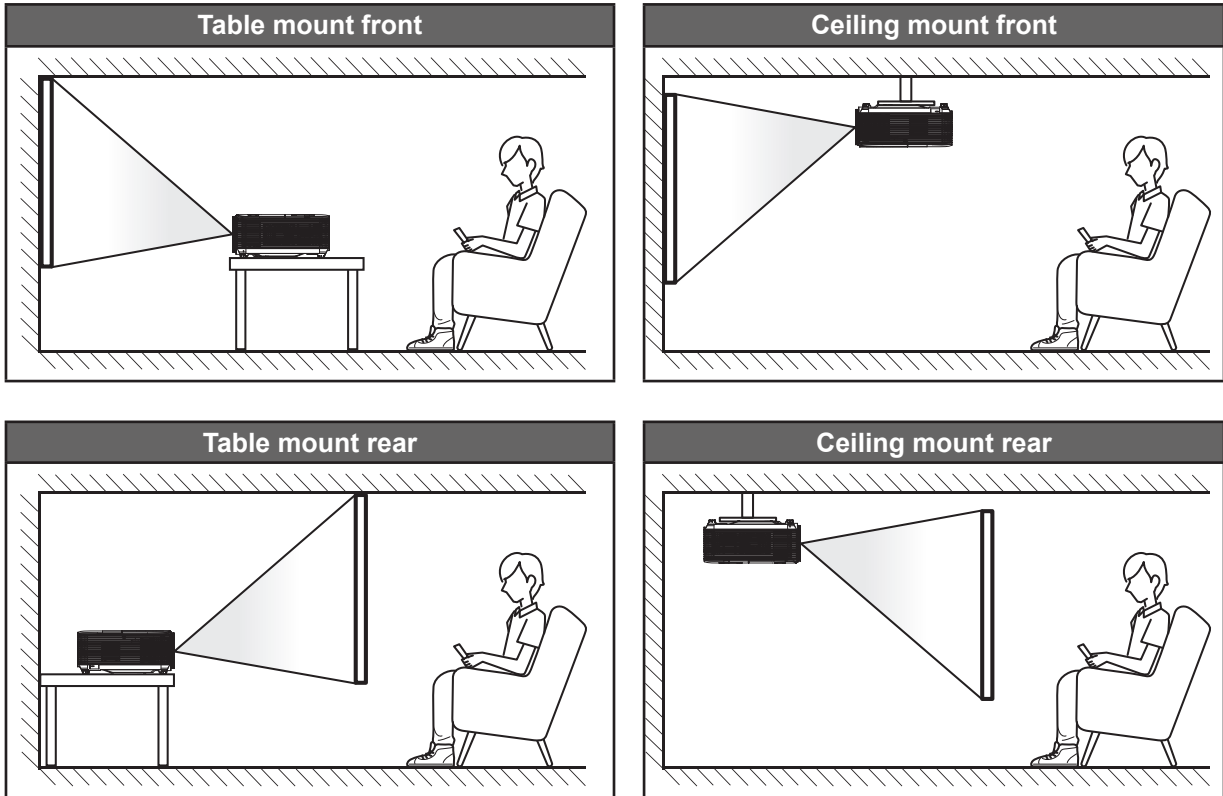

Projector should be placed flat on a surface and 90 degrees / perpendicular to the screen.

- How to determine projector location for a given screen size, please refer to distance table on pages 79-83.
- How to determine screen size for a given distance, please refer to distance table on pages 79-83.

Note: The further away the projector is placed from the screen the projected image size increases and vertical offset also increases proportionally.

IMPORTANT!

Do not operate the projector in any orientation other than table top or ceiling mount. The projector should be horizontal and not tilted either forwards/backwards or left/right. Any other orientation will invalidate the warranty and may shorten the lifetime of the projector lamp or the projector itself. For non standard installation advise please contact Optoma.

SETUP AND INSTALLATION

Projector installation notice (WUXGA_1080P)

- Place the projector in a horizontal position.
The tilt angle of the projector should not exceed 15 degrees, nor should the projector be installed in any way other than the desktop and ceiling mount, otherwise lamp life could decrease dramatically, and may lead to other **unpredictable damages**.

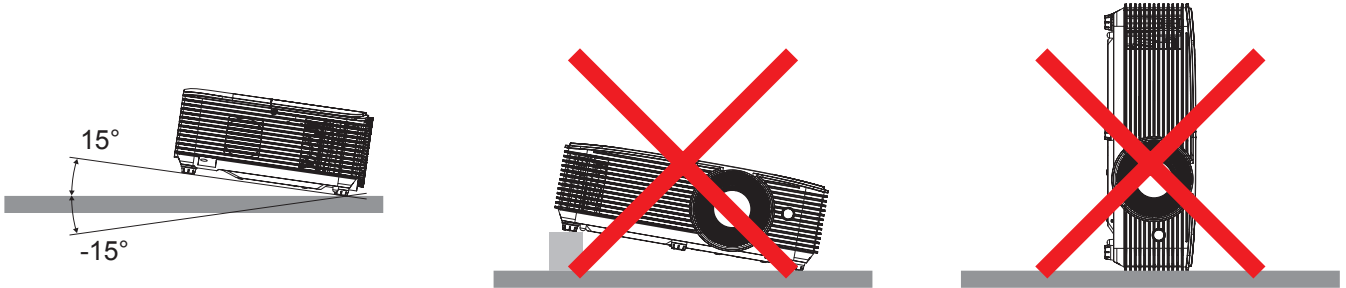

- Allow at least 30 cm clearance around the exhaust vent.

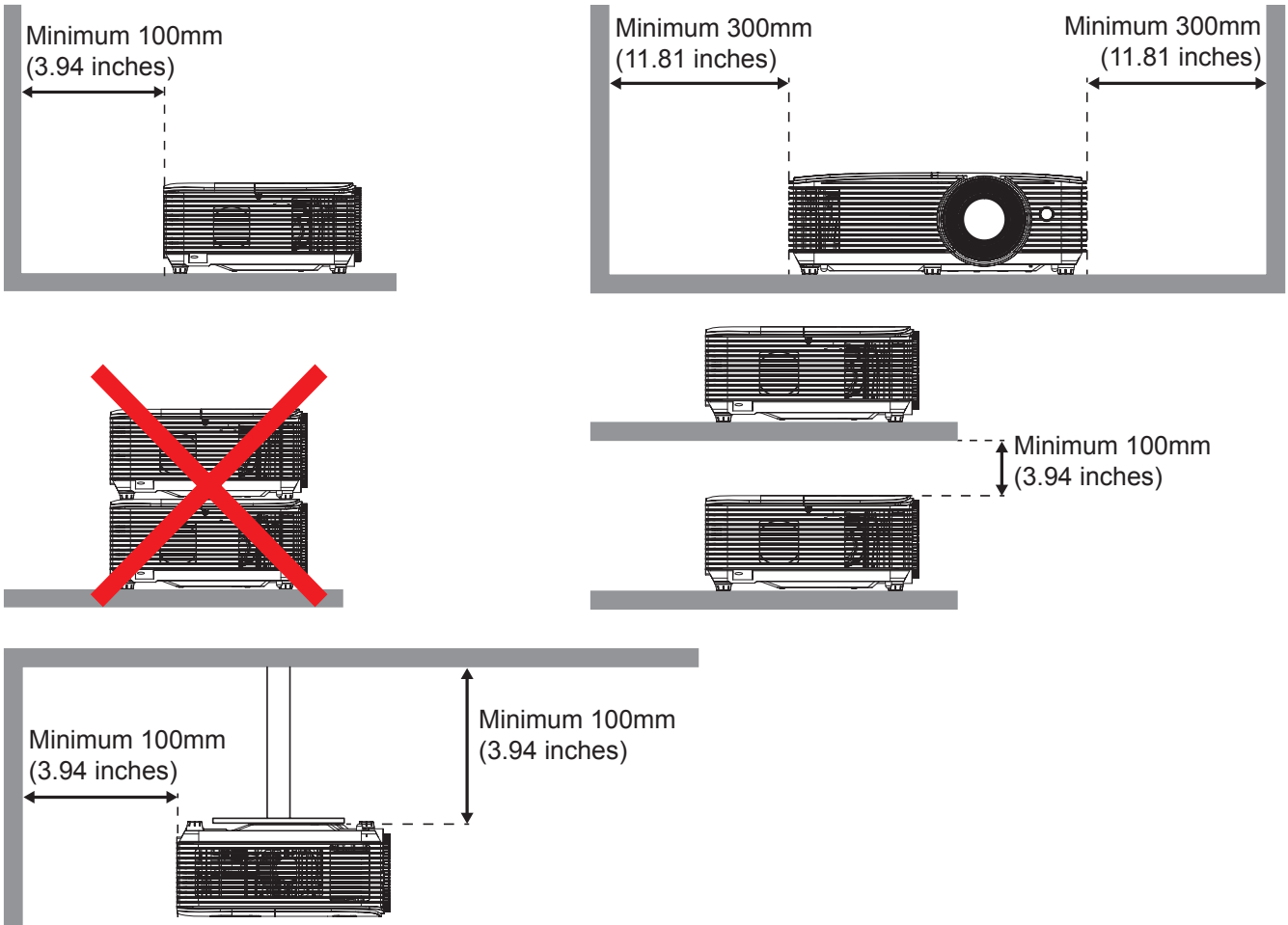

- Ensure that the intake vents do not recycle hot air from the exhaust vent.
- When operating the projector in an enclosed space, ensure that the surrounding air temperature within the enclosure does not exceed operation temperature while the projector is running, and the air intake and exhaust vents are unobstructed.
- All enclosures should pass a certified thermal evaluation to ensure that the projector does not recycle exhaust air, as this may cause the device to shutdown even if the enclosure temperature is within the acceptable operation temperature range.

SETUP AND INSTALLATION

Projector installation notice (SVGA_XGA_WXGA)

- Place the projector in a horizontal position.
The tilt angle of the projector should not exceed 15 degrees, nor should the projector be installed in any way other than the desktop and ceiling mount, otherwise lamp life could decrease dramatically, and may lead to other **unpredictable damages**.

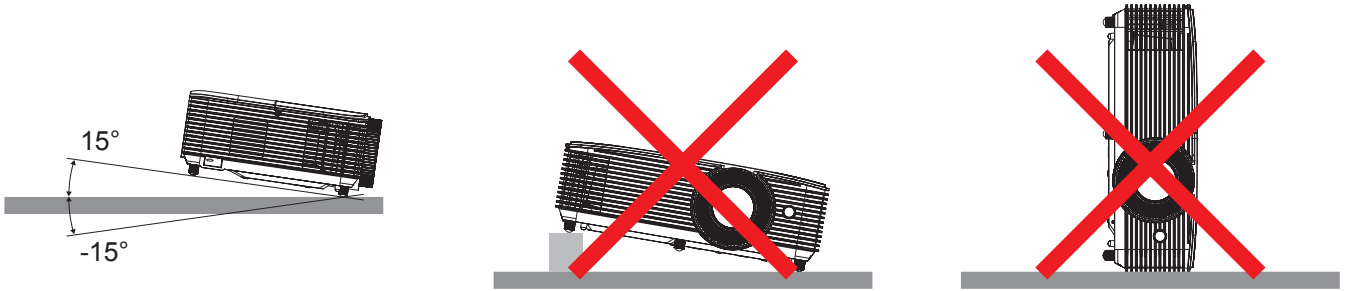

- Allow at least 30 cm clearance around the exhaust vent.

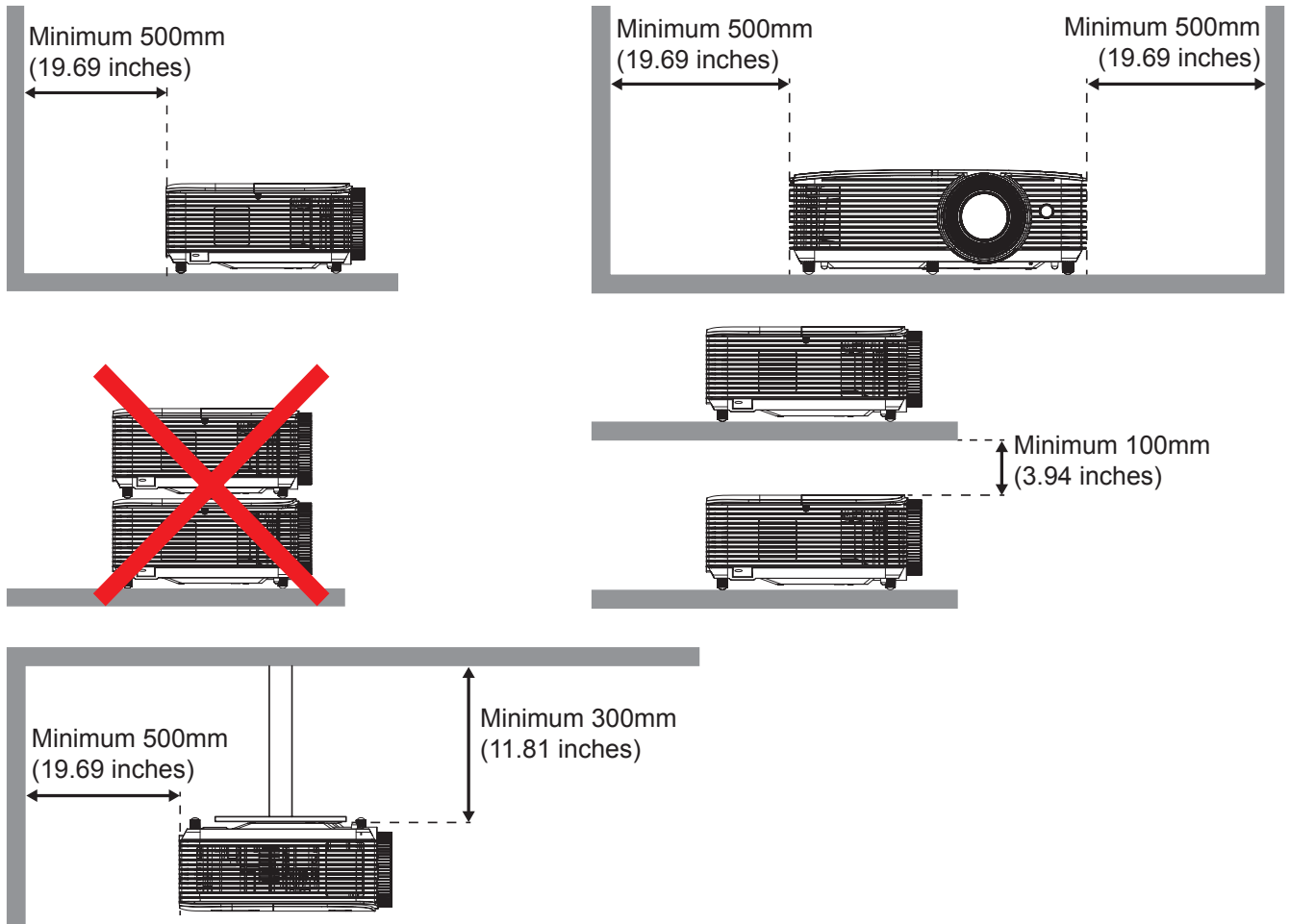

- Ensure that the intake vents do not recycle hot air from the exhaust vent.
- When operating the projector in an enclosed space, ensure that the surrounding air temperature within the enclosure does not exceed operation temperature while the projector is running, and the air intake and exhaust vents are unobstructed.
- All enclosures should pass a certified thermal evaluation to ensure that the projector does not recycle exhaust air, as this may cause the device to shutdown even if the enclosure temperature is within the acceptable operation temperature range.

SETUP AND INSTALLATION

WUXGA_1080P (Type 1 (8 IO))

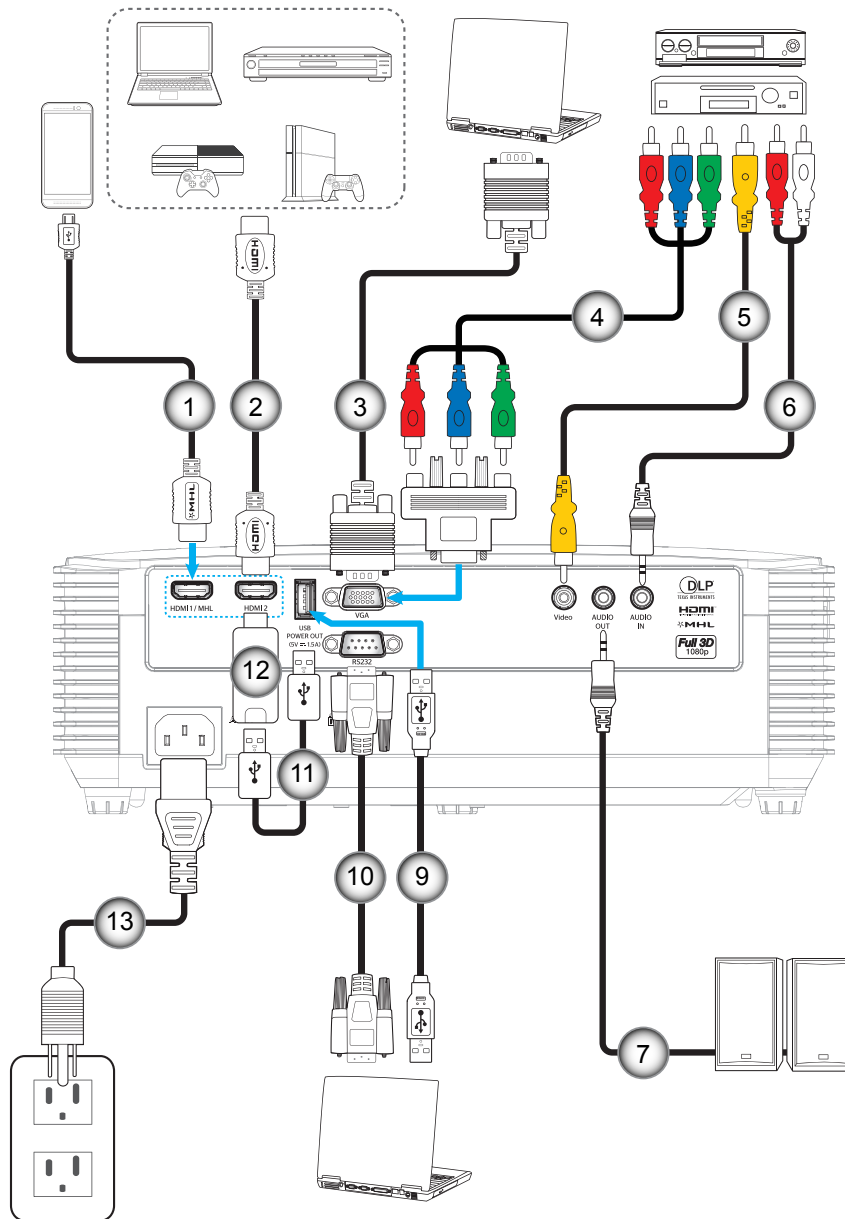

SETUP AND INSTALLATION

WUXGA_1080P (Type 2 (9 IO))

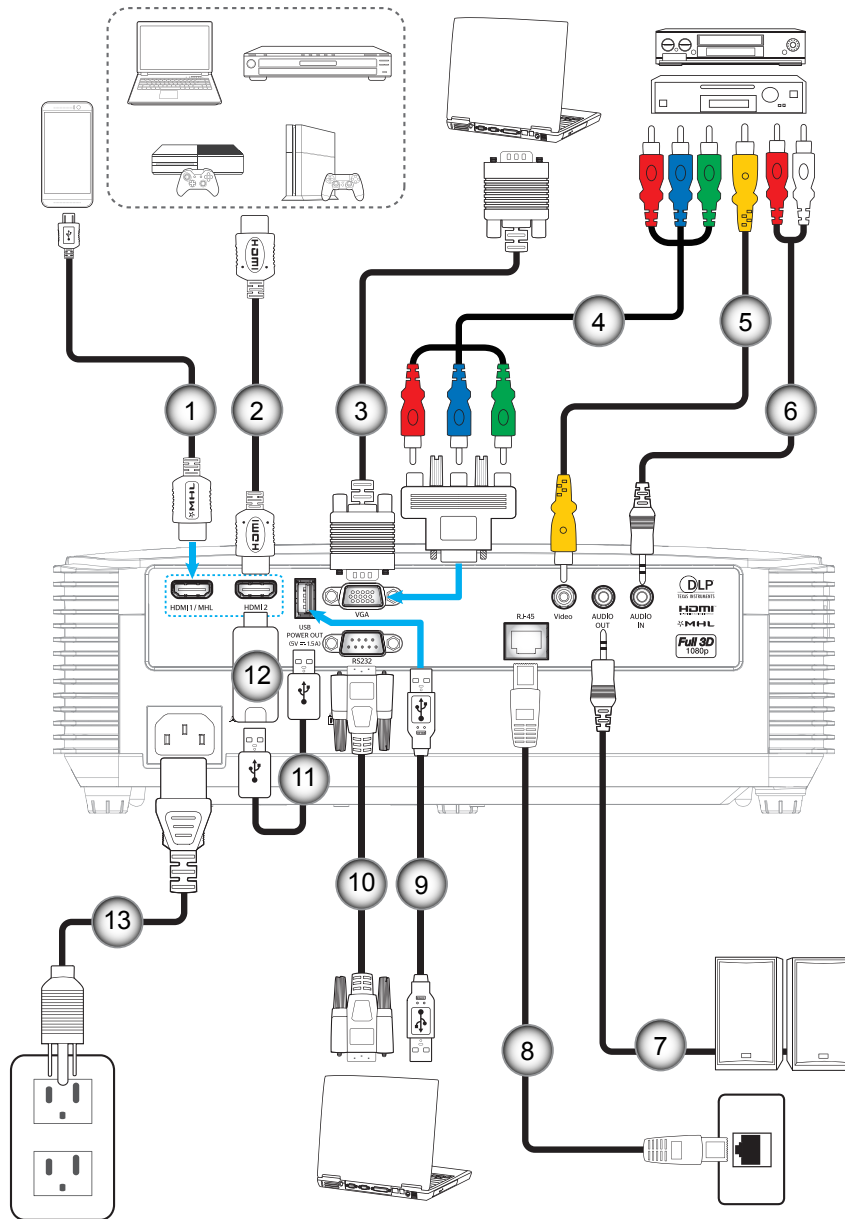

SETUP AND INSTALLATION

| No | Item | Type 1 (8 IO) | Type 2 (9 IO) |
|-----|---------------------------|---------------|---------------|
| 1. | MHL Cable | √ | √ |
| 2. | HDMI Cable | √ | √ |
| 3. | VGA In Cable | √ | √ |
| 4. | RCA Component Cable | √ | √ |
| 5. | Video Cable | √ | √ |
| 6. | Audio In Cable | √ | √ |
| 7. | Audio Out Cable | √ | √ |
| 8. | RJ-45 Cable | N/A | √ |
| 9. | USB Cable (mouse control) | √ | √ |
| 10. | RS232 Cable | √ | √ |
| 11. | USB Power Cable | √ | √ |
| 12. | HDMI Stick | √ | √ |
| 13. | Power Cord | √ | √ |

Note: “√” means the item is supported, “N/A” means the item is not available.

SETUP AND INSTALLATION

SVGA_XGA_WXGA (Type 3 (3 IO))

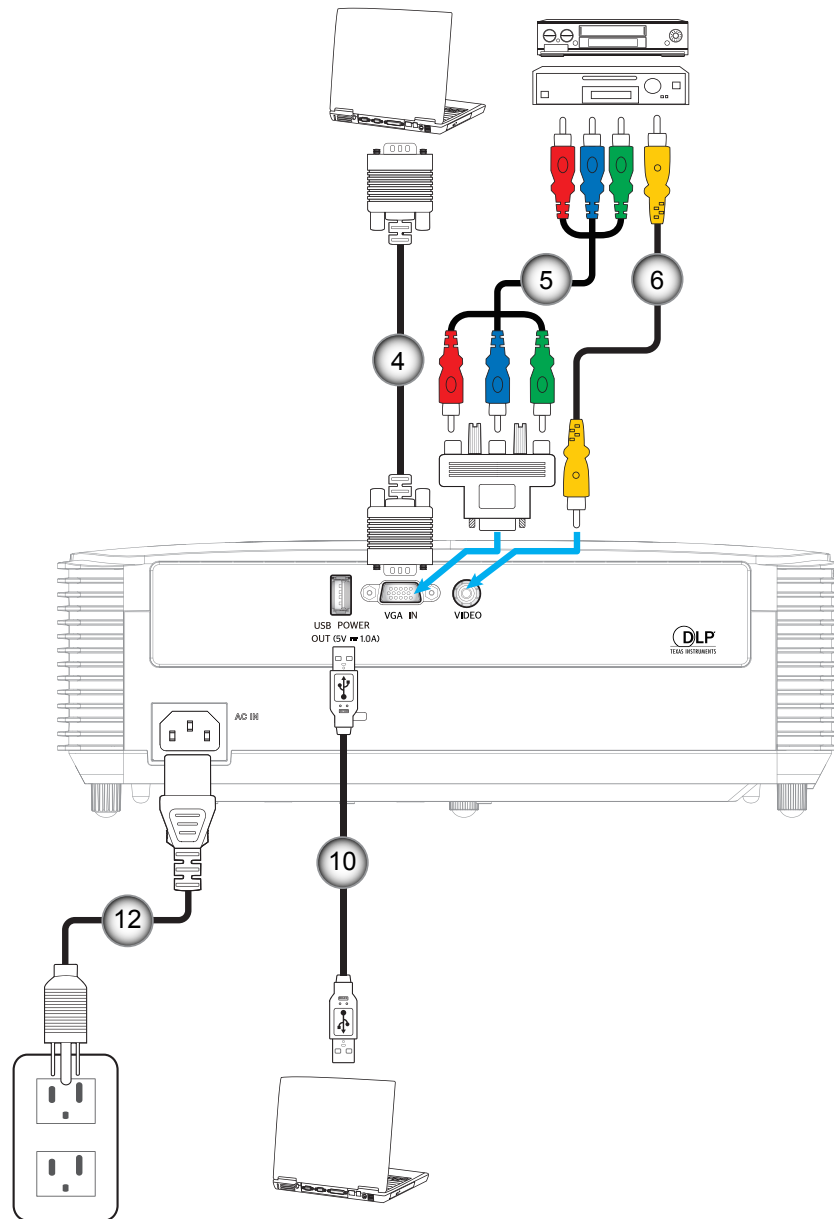

SETUP AND INSTALLATION

SVGA_XGA_WXGA (Type 4 (6 IO))

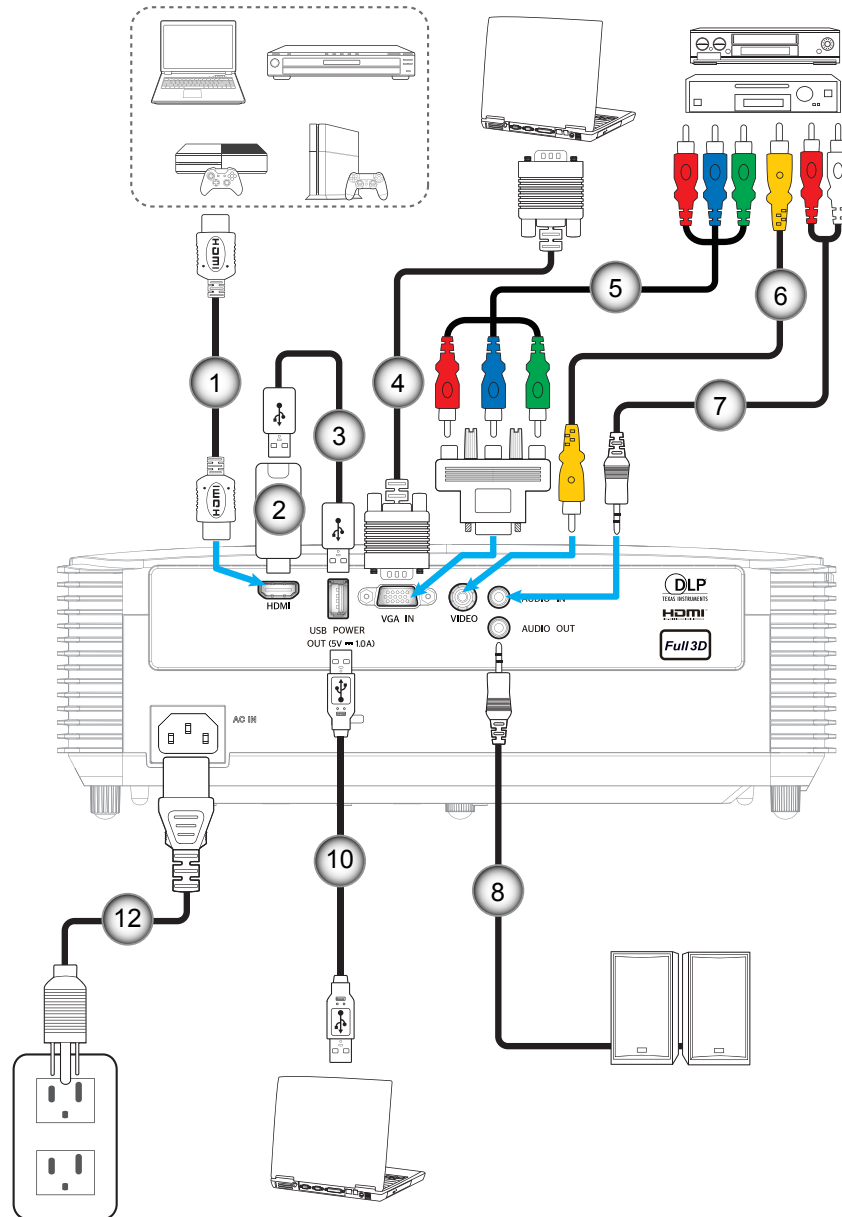

SETUP AND INSTALLATION

SVGA_XGA_WXGA (Type 5 (8 IO))

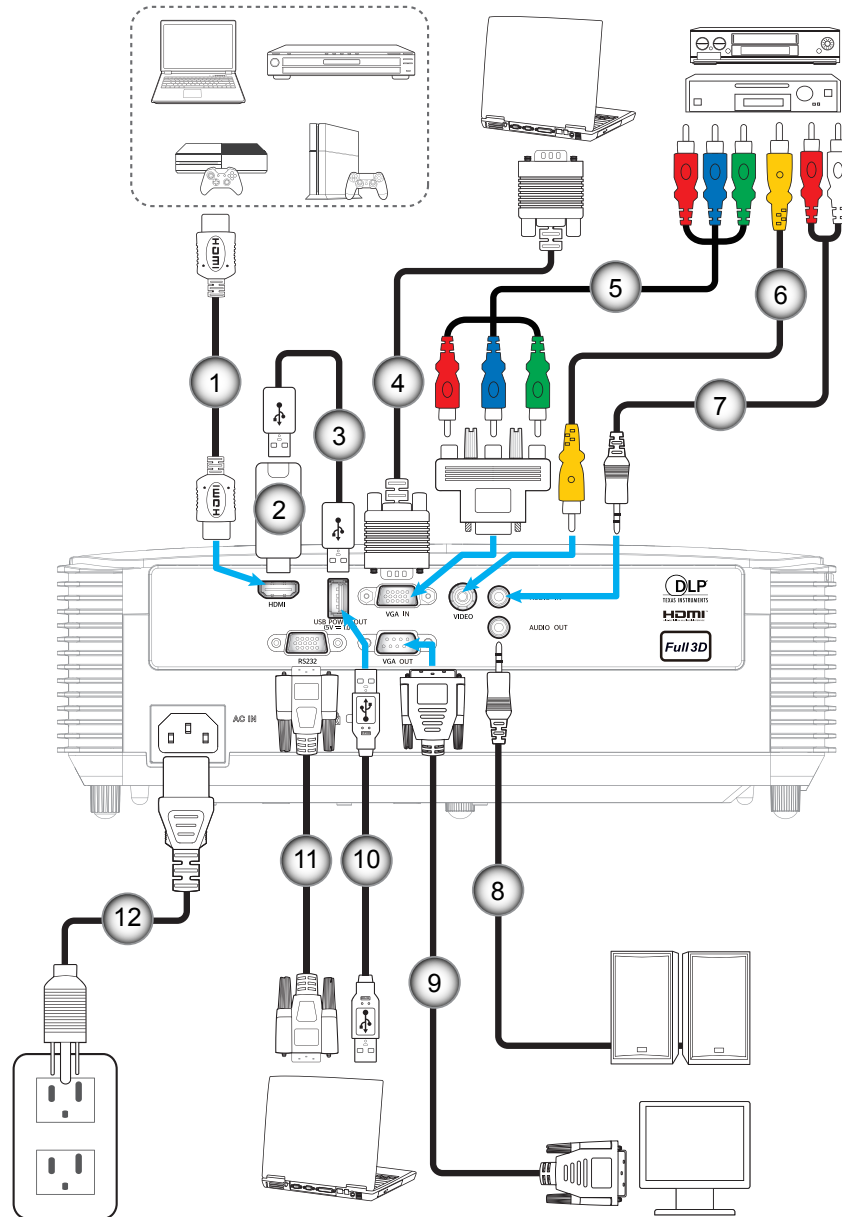

SETUP AND INSTALLATION

| No | Item | Type 3 (3 IO) | Type 4 (6 IO) | Type 5 (8 IO) |
|-----|---------------------------|---------------|---------------|---------------|
| 1. | HDMI Cable | N/A | √ | √ |
| 2. | HDMI Stick | N/A | √ | √ |
| 3. | USB Power Cable | N/A | √ | √ |
| 4. | VGA In Cable | √ | √ | √ |
| 5. | RCA Component Cable | √ | √ | √ |
| 6. | Video Cable | √ | √ | √ |
| 7. | Audio In Cable | N/A | √ | √ |
| 8. | Audio Out Cable | N/A | √ | √ |
| 9. | VGA out Cable | N/A | N/A | √ |
| 10. | USB Cable (mouse control) | √ | √ | √ |
| 11. | RS232 Cable | N/A | N/A | √ |
| 12. | Power Cord | √ | √ | √ |

Note: “√” means the item is supported, “N/A” means the item is not available.

SETUP AND INSTALLATION

Adjusting the projector image

Image height

The projector is equipped with elevator feet for adjusting the image height.

1. Locate the adjustable foot you wish to adjust on the underside of the projector.
2. Rotate the adjustable foot clockwise or counterclockwise to raise or lower the projector.

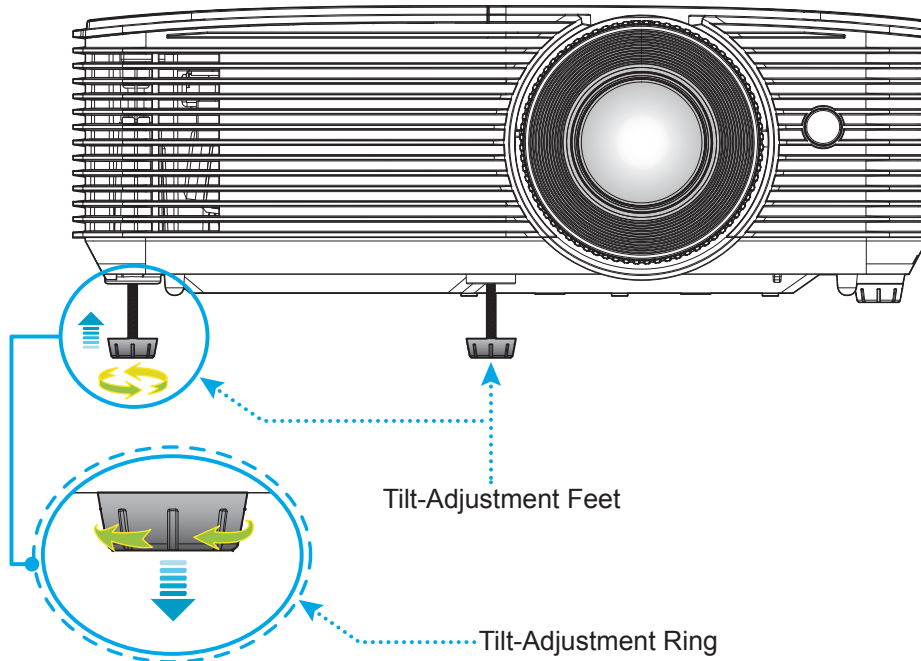

Zoom and focus

- To adjust the image size, turn the zoom lever clockwise or counterclockwise to increase or decrease the projected image size.
- To adjust the focus, turn the focus ring clockwise or counterclockwise until the image is sharp and legible.

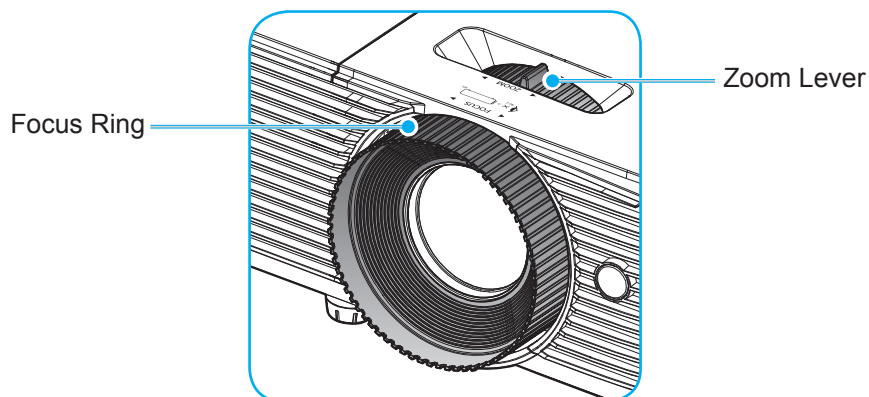

Note: The projector will focus at a distance of 1m to 10m (WUXGA and 1080P models) or 1m to 12m (SVGA, XGA, and WXGA models).

SETUP AND INSTALLATION

Installing / replacing the batteries

1. Press firmly and slide the battery cover off.
2. Install new battery into the compartment. Remove the old battery and install new one (CR2025). Ensure that the side with a “+” is facing up.
3. Put the cover back.

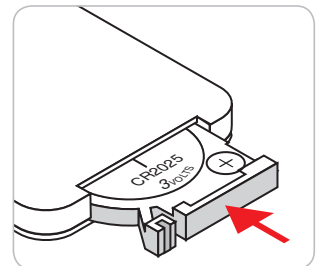
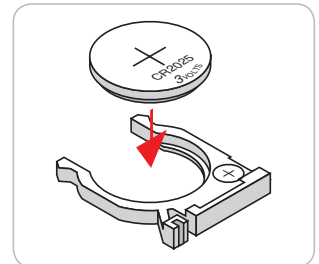
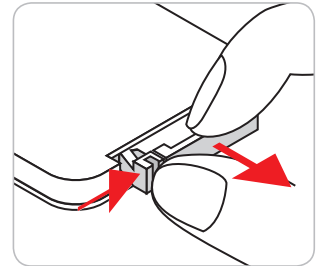

CAUTION: To ensure safe operation, please observe the following precautions:

- Use CR2025 type battery.
- Avoid contact with water or liquid.
- Do not expose the remote control to moisture or heat.
- Do not drop the remote control.
- If the battery has leaked in the remote control, carefully wipe the case clean and install new battery.
- Risk of an explosion if battery is replaced by an incorrect type.
- Dispose of used battery according to the instructions.

SETUP AND INSTALLATION

Effective range

Infra-Red (IR) remote control sensor is located on top of the projector. Ensure to hold the remote control at an angle within 30 degrees perpendicular to the projector's top IR remote control sensor to function correctly. The distance between the remote control and the sensor should not be longer than 6 meters (~ 20 feet).

Note: When pointing the remote control directly (0 degrees angle) on the IR sensor, the distance between the remote control and the sensor should not be longer than 8 meters (~ 26 feet).

- Make sure that there are no obstacles between the remote control and the IR sensor on the projector that might obstruct the infra-red beam.
- Make sure the IR transmitter of the remote control is not being shined by sunlight or fluorescent lamps directly.
- Please keep the remote controller away from fluorescent lamps for over 2 meters or the remote controller might become malfunction.
- If the remote control is close to Inverter-Type fluorescent lamps, it might become ineffective from time to time.
- If the remote control and the projector are within a very short distance, the remote control might become ineffective.
- When you aim at the screen, the effective distance is less than 6 meters from the remote control to the screen and reflecting the IR beams back to the projector. However, the effective range might change according to screens.

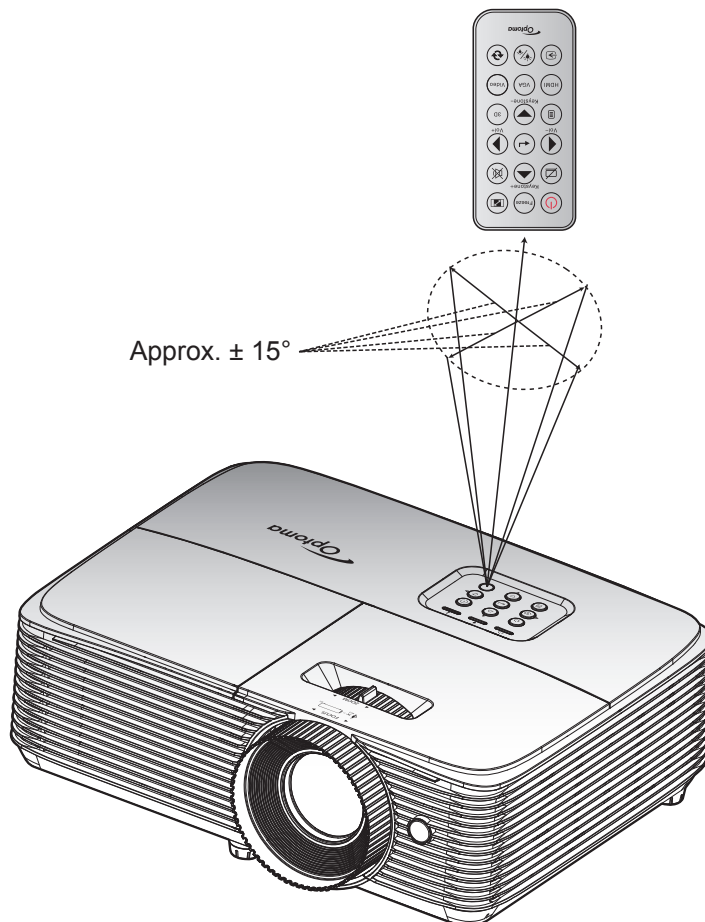

USING THE PROJECTOR

Powering on / off the projector

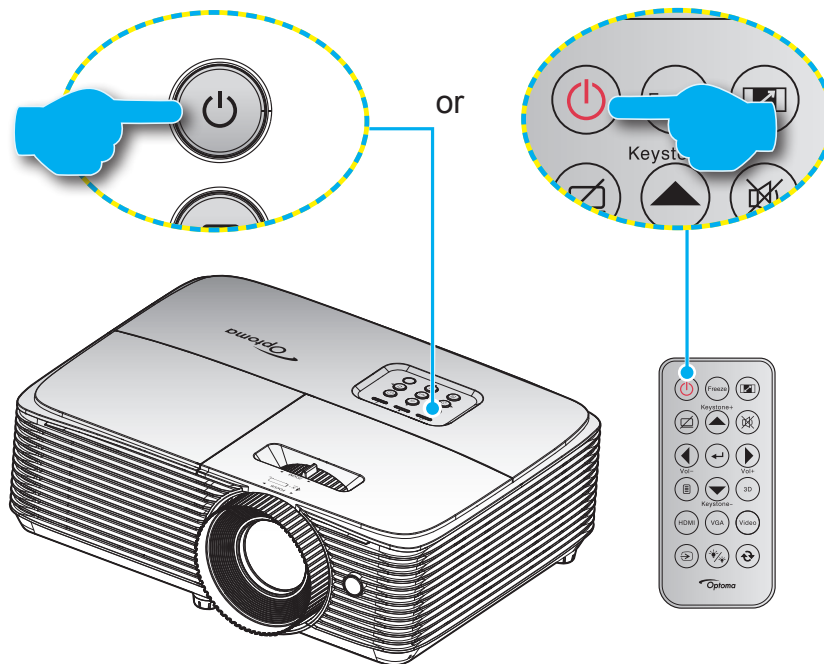

Powering on

1. Securely connect the power lead and signal/source cable. When connected, the On/Standby LED will turn red.
2. Turn on the projector by pressing the "⏻" either on the projector keypad or the remote control.
3. A start up screen will display in approximately 10 seconds and the On/Standby LED will be flashing green or flashing blue.

Note: The first time the projector is turned on, you will be prompted to select the preferred language, projection orientation, and other settings.

Powering off

1. Turn off the projector by pressing the "⏻" either on the projector keypad or the remote control.
2. The following message will be displayed:

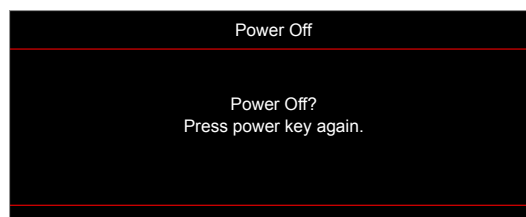

3. Press the "⏻" again to confirm, otherwise the message will disappear after 15 seconds. When you press the "⏻" button for the second time, the projector will shut down.
4. The cooling fans will continue to operate for about 10 seconds for the cooling cycle and the On/Standby LED will flash green or flash blue. When the On/Standby LED turns solid red, this indicates the projector has entered standby mode. If you wish to turn the projector back on, you must wait until the cooling cycle has finished and the projector has entered standby mode. When the projector is in standby mode, simply press the "⏻" button again to turn on the projector.
5. Disconnect the power lead from the electrical outlet and the projector.

Note: It is not recommended that the projector is turned on immediately, right after a power off procedure.

USING THE PROJECTOR

Selecting an input source



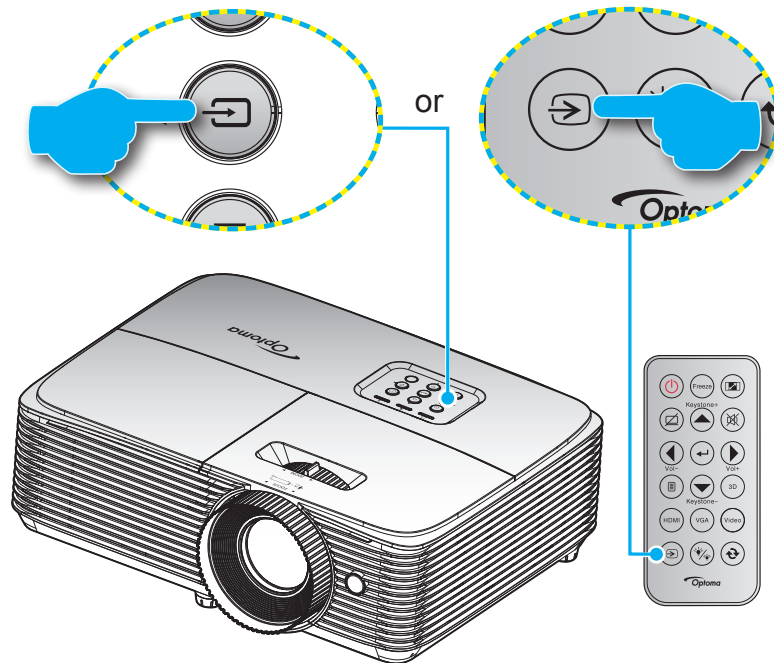











Turn on the connected source that you want to display on the screen, such as computer, notebook, video player, etc. The projector will automatically detect the source. If multiple sources are connected, push the source button on the projector keypad or the remote control to select the desired input.



USING THE PROJECTOR

Menu navigation and features

The projector has multilingual on-screen display menus that allow you to make image adjustments and change a variety of settings. The projector will automatically detect the source.

1. To open the OSD menu, press  on the remote control or the projector keyboard.
2. When OSD is displayed, use   keys to select any item in the main menu. While making a selection on a particular page, press  or  key to enter sub menu.
3. Use   keys to select the desired item in the sub menu and then press  or  key to view further settings. Adjust the settings by using   keys.
4. Select the next item to be adjusted in the sub menu and adjust as described above.
5. Press the  or  to confirm, and the screen will return to the main menu.
6. To exit, press the  or  again. The OSD menu will close and the projector will automatically save the new settings.

WUXGA and 1080P Models

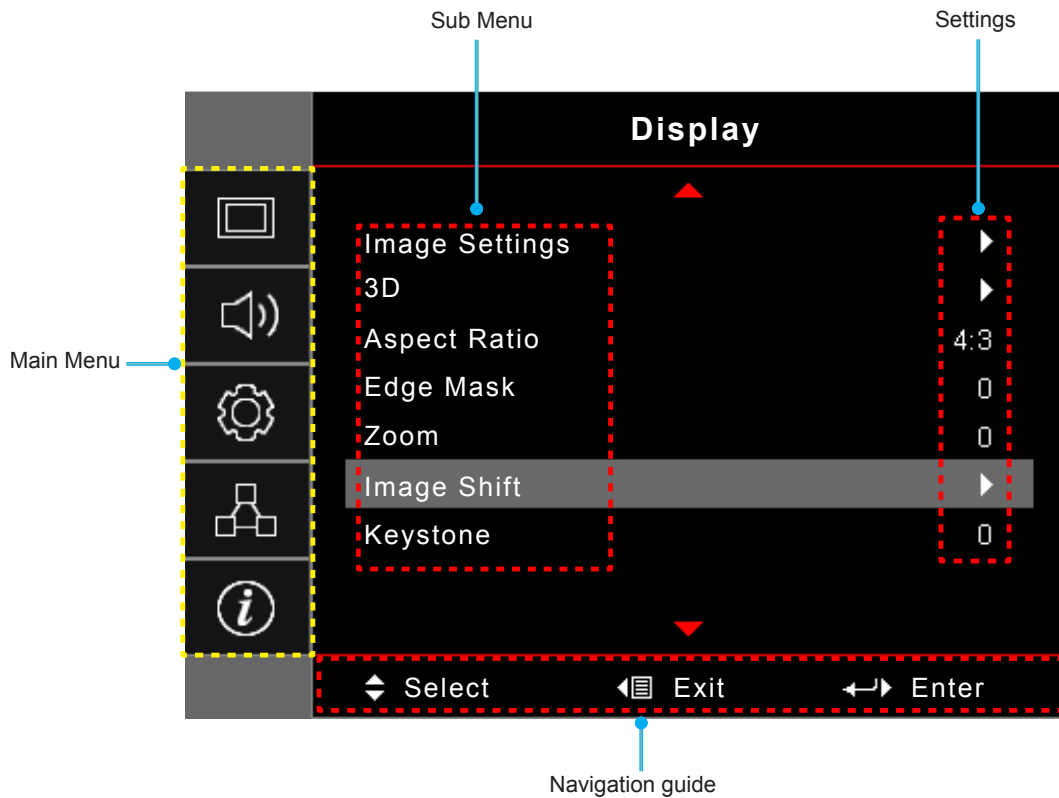

USING THE PROJECTOR

SVGA, XGA, and WXGA Models

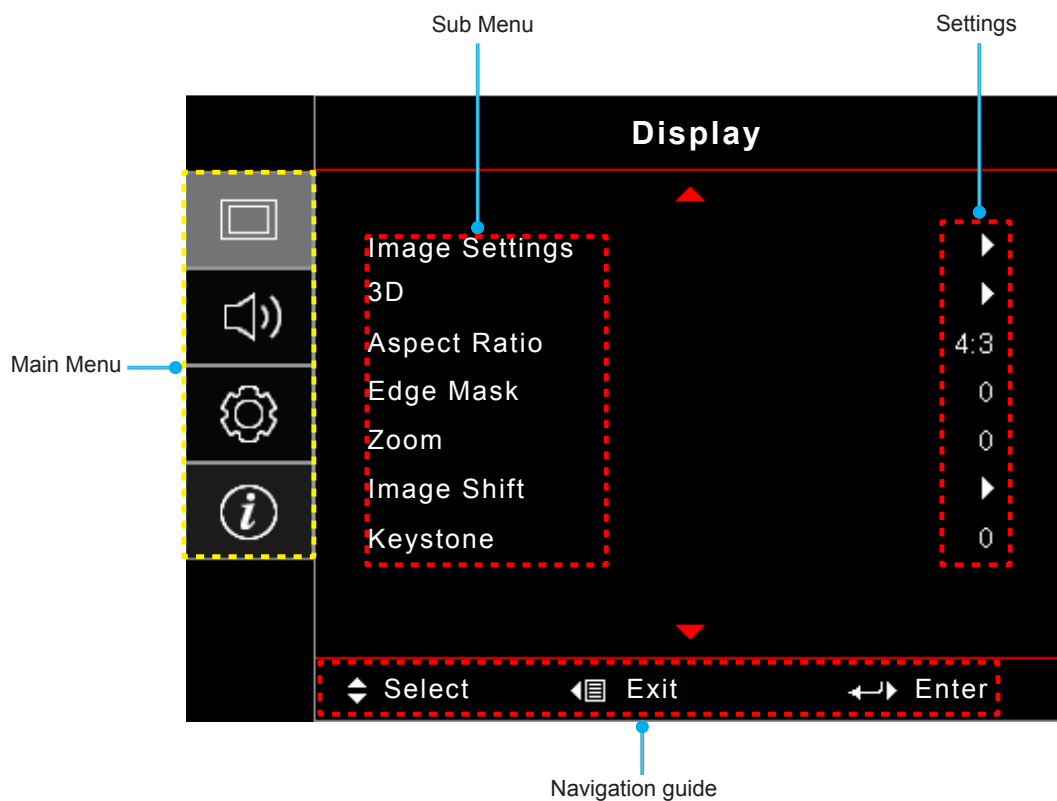

USING THE PROJECTOR







OSD Menu tree (WUXGA and 1080P models)

| Main Menu | Sub Menu | Sub Menu 2 | Sub Menu 3 | Sub Menu 4 | Values | |
|------------|----------------|----------------|---------------------|------------|-------------------|-------------|
| Display | Image Settings | Display Mode | [Data] | | Presentation | |
| | | | | | Bright | |
| | | | | | Cinema | |
| | | | | | Game | |
| | | | | | sRGB | |
| | | | | | DICOM SIM. | |
| | | | | | User | |
| | | | | | 3D | |
| | | Wall Color | | | Off [Default] | |
| | | | | | Blackboard | |
| | | | | | Light Yellow | |
| | | | | | Light Green | |
| | | | | | Light Blue | |
| | | | | | Pink | |
| | | | | | Gray | |
| | | Brightness | | | -50~50 | |
| | | Contrast | | | -50~50 | |
| | | Sharpness | | | 1~15 | |
| | | Color | | | -50~50 | |
| | | Tint | | | -50~50 | |
| | | Gamma | | | Film | |
| | | | | | Video | |
| | | | | | Graphics | |
| | | | | | Standard(2.2) | |
| | | | | | 1.8 | |
| | | | | | 2.0 | |
| | | | | | 2.4 | |
| | | Color Settings | BrilliantColor™ | | 1~10 | |
| | | | | | Color Temperature | [Data mode] |
| | | | | | | Warm |
| | | | Medium | | | |
| | | | Color Matching | | | Cool |
| Color | R [Default] | | | | | |
| | G | | | | | |
| | B | | | | | |
| | C | | | | | |
| | Y | | | | | |
| | M | | | | | |
| | W | | | | | |
| Hue | | | -50~50 [Default: 0] | | | |
| Saturation | | | -50~50 [Default: 0] | | | |
| Gain | | | -50~50 [Default: 0] | | | |

USING THE PROJECTOR

| Main Menu | Sub Menu | Sub Menu 2 | Sub Menu 3 | Sub Menu 4 | Values |
|-----------|----------------|-----------------|------------------------------|---|------------------|
| Display | Image Settings | Color Settings | Color Matching | Reset | Cancel [Default] |
| | | | | Exit | Yes |
| | | | RGB Gain/Bias | Red Gain | -50~50 |
| | | | | Green Gain | -50~50 |
| | | | | Blue Gain | -50~50 |
| | | | | Red Bias | -50~50 |
| | | | | Green Bias | -50~50 |
| | | | | Blue Bias | -50~50 |
| | | | | Reset | Cancel [Default] |
| | | | Exit | Yes | |
| | | | Color Space [Not HDMI Input] | | Auto [Default] |
| | | | | | RGB |
| | | | | | YUV |
| | | | Color Space [HDMI Input] | | Auto [Default] |
| | | | | | RGB(0~255) |
| | | | | | RGB(16~235) |
| | | | | YUV | |
| | | | White Level | 0~31 (depends on signal) | |
| | | | Black Level | -5~5 (depends on signal) | |
| | | | IRE | 0 | |
| | | | | 7.5 | |
| | | Signal | Automatic | Off | |
| | | | | On [Default] | |
| | | | Frequency | -10~10 (depends on signal) [Default: 0] | |
| | | | Phase | 0~31 (depends on signal) [Default: 0] | |
| | | | H. Position | -5~5 (depends on signal) [Default: 0] | |
| | | | V. Position | -5~5 (depends on signal) [Default: 0] | |
| | | Exit | | | |
| | | Brightness Mode | [Lamp Base - Data] | Bright | |
| | | | | Eco. | |
| | | | | Dynamic | |
| | | | | Eco+ | |
| | | Reset | | | |

USING THE PROJECTOR

| Main Menu | Sub Menu | Sub Menu 2 | Sub Menu 3 | Sub Menu 4 | Values | |
|-------------|---|----------------|------------|------------|---|---------------------|
| Display | 3D | 3D Mode | | | Off | |
| | | | | | DLP-Link [Default] | |
| | | | | | IR | |
| | | 3D->2D | | | 3D [Default] | |
| | | | | | L | |
| | | | | | R | |
| | | 3D Format | | | Auto [Default] | |
| | | | | | SBS | |
| | | | | | Top and Bottom | |
| | | 3D sync invert | | | Frame Sequential | |
| | | | | On | | |
| | Aspect Ratio | | | | | Off [Default] |
| | | | | | | 4:3 |
| | | | | | | 16:9 |
| | | | | | | 16:10 [WUXGA model] |
| | | | | | | LBX |
| | | | | | | Native |
| Edge Mask | | | | | Auto | |
| Zoom | | | | | 0~10 [Default: 0] | |
| Image shift | | | | | -5~25 [Default: 0] | |
| |  H | | | | -50~50 [Default: 0] | |
| |  V | | | | -50~50 [Default: 0] | |
| Keystone | | | | | -40~40 | |
| Audio | Mute | | | | Off [Default] | |
| | | | | | On | |
| Volume | | | | | 0-10 [Default: 5] | |
| Setup | Projection | | | | Front  [Default] | |
| | | | | | Rear  | |
| | | | | | Ceiling-top  | |
| | | | | | Rear-top  | |
| | Screen Type | [WUXGA model] | | | | 16:9 |
| | | | | | | 16:10 [Default] |
| | Lamp Settings | Lamp Reminder | | | | Off |
| | | | | | | On [Default] |
| | | | | | Cancel [Default] | |
| | Lamp Reset | | | | Yes | |

USING THE PROJECTOR

| Main Menu | Sub Menu | Sub Menu 2 | Sub Menu 3 | Sub Menu 4 | Values | |
|-----------|----------------------|---------------------------|-----------------|---------------|--|-----|
| Setup | Filter Settings | Optional Filter Installed | | | Yes | |
| | | | | | No | |
| | | Filter Usage Hours | | | (Read only) | |
| | | | | | | |
| | | Filter Reminder | | | Off | |
| | | | | | 300hr | |
| | | | | | 500hr [Default] | |
| | | | | | 800hr | |
| | | Filter Reset | | | 1000hr | |
| | | | | | Cancel [Default] | |
| | Power Settings | Direct Power On | | | Off [Default] | |
| | | | | | On | |
| | | Signal Power On | | | Off [Default] | |
| | | | | | On | |
| | | Auto Power Off (min) | | | 0~180 (5 min increments) [Default: 20] | |
| | | | | | 0~990 (30 min increments) [Default: 0] | |
| | | Sleep Timer (min) | Always On | | No [Default] | |
| | | | | | Yes | |
| | | Quick Resume | | | Off [Default] | |
| | | | | | On | |
| | Power Mode (Standby) | | | Active | | |
| | | | | Eco [Default] | | |
| | USB Power | | | Off | | |
| | | | | On | | |
| | Security | Security | | | Off | |
| | | | | | On | |
| | | Security Timer | | Month | | |
| | | | | Day | | |
| | | | | Hour | | |
| | | Change Password | | | | |
| | | | | | | |
| | | HDMI Link Settings | HDMI Link | | | Off |
| | | | | | | On |
| | | | Inclusive of TV | | | No |
| | | | | | Yes | |
| | Power On Link | | | | Mutual | |
| | | | | | PJ --> Device | |
| | Power Off Link | | | | Device --> PJ | |
| | | | | | Off | |
| | | | | On | | |





USING THE PROJECTOR

| Main Menu | Sub Menu | Sub Menu 2 | Sub Menu 3 | Sub Menu 4 | Values | | |
|-----------|--|-------------|------------|------------|--------------|---------------|--------------------------|
| Setup | Test Pattern | | | | Green Grid | | |
| | | | | | Magenta Grid | | |
| | | | | | White Grid | | |
| | | | | | White | | |
| | | | | | Off | | |
| | Remote Settings [depends on remote] | IR Function | | | | On | |
| | | | | | | Off | |
| | | User1 | | | | | HDMI 2 |
| | | | | | | | Test Pattern |
| | | | | | | | LAN (Type 2 (9 IO) only) |
| | | | | | | | Brightness |
| | | | | | | | Contrast |
| | | | | | | | Sleep Timer [Default] |
| | | | | | | | Color Matching |
| | | | | | | | Color Temp |
| | | | | | | | Gamma |
| | | | | | | | Projection |
| | | | | | | | Lamp Settings |
| | | | | | | | Zoom |
| | | | | | | | Freeze |
| | | | | | | | MHL |
| | | | User2 | | | | |
| | | | | | | | Test Pattern |
| | | | | | | | LAN (Type 2 (9 IO) only) |
| | | | | | | | Brightness |
| | | | | | | | Contrast |
| | | | | | | | Sleep Timer |
| | | | | | | | Color Matching [Default] |
| | | | | | | | Color Temp |
| | | | | | | | Gamma |
| | | | | | | Projection | |
| | | | | | | Lamp Settings | |
| | | | | | Zoom | | |
| | | | | Freeze | | | |
| | | | | MHL | | | |

USING THE PROJECTOR

| Main Menu | Sub Menu | Sub Menu 2 | Sub Menu 3 | Sub Menu 4 | Values | |
|-----------|--|------------------|------------|------------|--------------------------|-------------------|
| Setup | Remote Settings [depends on remote] | User3 | | | HDMI 2 | |
| | | | | | Test Pattern | |
| | | | | | LAN (Type 2 (9 IO) only) | |
| | | | | | Brightness | |
| | | | | | Contrast | |
| | | | | | Sleep Timer | |
| | | | | | Color Matching | |
| | | | | | Color Temp [Default] | |
| | | | | | Gamma | |
| | | | | | Projection | |
| | | | | | Lamp Settings | |
| | | | | | Zoom | |
| | | | | | Freeze | |
| | | | | | MHL | |
| | | Projector ID | | | 0~99 | |
| | | Options | Language | | | English [Default] |
| | | | | | Deutsch | |
| | | | | | Français | |
| | | | | | Italiano | |
| | | | | | Español | |
| | | | | | Português | |
| | | | | | Polski | |
| | | | | | Nederlands | |
| | | | | | Svenska | |
| | | | | | Norsk/Dansk | |
| | | | | | Suomi | |
| | | | | | ελληνικά | |
| | | | | | 繁體中文 | |
| | | | | | 简体中文 | |
| | | | | | 日本語 | |
| | | | | | 한국어 | |
| | | | | | Русский | |
| | | | | | Magyar | |
| | | | | Čeština | | |
| | | عربي | | | | |
| | | ไทย | | | | |
| | | Türkçe | | | | |
| | | فارسی | | | | |
| | | Tiếng Việt | | | | |
| | | Bahasa Indonesia | | | | |
| | | Română | | | | |
| | | Slovenčina | | | | |

USING THE PROJECTOR

| Main Menu | Sub Menu | Sub Menu 2 | Sub Menu 3 | Sub Menu 4 | Values | | |
|-----------|----------|-------------------|---------------|-------------------|---------------|---------------|--|
| Setup | Options | Closed Captioning | | | CC1 | | |
| | | | | | CC2 | | |
| | | | | | Off [Default] | | |
| | | Menu Settings | Menu Location | | | | Top left  |
| | | | | | | | Top right  |
| | | | | | | | Center  [Default] |
| | | | | | | | Bottom left  |
| | | | | | | | Bottom right  |
| | | | Menu Timer | | | | Off |
| | | | | | | | 5sec |
| | | | | | | | 10sec [Default] |
| | | | Auto Source | | | | Off [Default] |
| | | | | | | On | |
| | | Input Source | | | | HDMI1/MHL | |
| | | | | | | HDMI2 | |
| | | | | | | VGA | |
| | | | | | | Video | |
| | | Input Name | HDMI1/MHL | | | | Default [Default] |
| | | | | | | | Custom |
| | | | HDMI2 | | | | Default [Default] |
| | | | | | | | Custom |
| | | | VGA | | | | Default [Default] |
| | | | | | | | Custom |
| | | | Video | | | | Default [Default] |
| | | | | | | | Custom |
| | | High Altitude | | | | Off [Default] | |
| | | | | | | On | |
| | | Display Mode Lock | | | | Off [Default] | |
| | | | | | | On | |
| | | Keypad Lock | | | | Off [Default] | |
| | | | | | | On | |
| | | Information Hide | | | | Off [Default] | |
| | | | | | | On | |
| Logo | | | | Default [Default] | | | |
| | | | | Neutral | | | |

USING THE PROJECTOR

| Main Menu | Sub Menu | Sub Menu 2 | Sub Menu 3 | Sub Menu 4 | Values |
|---------------------------------------|----------|----------------------|--------------------------------------|--------------------------------------|--|
| Setup | Options | Background Color | | | None [Default: for Video/Pro-AV] |
| | | | | | Blue [Default for Data model] |
| | | | | | Red |
| | | | | | Green |
| | | | | | Grey |
| | | | | | Logo |
| | Reset | Reset OSD | | | Cancel [Default] |
| | | Reset to Default | | | Yes |
| Network (Type 2 (9 IO) only) | LAN | Network Status | | | (read only) |
| | | MAC Address | | | (read only) |
| | | DHCP | | | Off [Default] |
| | | | | | On |
| | | IP Address | | | 192.168.0.100 [Default] |
| | | Subnet Mask | | | 255.255.255.0 [Default] |
| | | Gateway | | | 192.168.0.254 [Default] |
| | | DNS | | | 192.168.0.51 [Default] |
| | Reset | | | | |
| | Control | Crestron | | | Off |
| | | | | | On [Default] Note: Port 41794. |
| | | Extron | | | Off |
| | | | | | On [Default] Note: Port 2023. |
| | | PJ Link | | | Off |
| | | | | | On [Default] Note: Port 4352 |
| | | AMX Device Discovery | | | Off |
| | | | | | On [Default] Note: Port 9131 |
| | | Telnet | | | Off |
| | | | | On [Default] Note: Port 23 | |
| HTTP | | | Off | | |
| | | | On [Default] Note: Port 80 | | |

USING THE PROJECTOR

| Main Menu | Sub Menu | Sub Menu 2 | Sub Menu 3 | Sub Menu 4 | Values | |
|-------------|----------------------|------------|------------|------------|--------|------|
| Information | Regulatory | | | | | |
| | Serial Number | | | | | |
| | Source | | | | | |
| | Resolution | | | | 00x00 | |
| | Refresh Rate | | | | 0.00Hz | |
| | Display Mode | | | | | |
| | Power mode (Standby) | | | | | |
| | Lamp Hours | Bright | | | | 0 hr |
| | | Eco. | | | | 0 hr |
| | | Dynamic | | | | 0 hr |
| | | Eco+ | | | | 0 hr |
| | | Total | | | | |
| | Network Status | | | | | |
| | IP Address | | | | | |
| | Projector ID | | | | 00~99 | |
| | Filter Usage Hours | | | | | |
| | Brightness Mode | | | | | |
| FW Version | System | | | | | |
| | LAN | | | | | |
| | MCU | | | | | |

Note:

- *The “Lamp Reset” in OSD will only reset both Lamp Hours in OSD and Lamp Hours in service mode. The Projection Hours in service mode will not be reset.*
- *Each display mode can be adjusted and saved the value.*
- *In 3D timing mode, the zoom/edge mask will be disabled to prevent from image break.*
- *The available menu options vary depending on the model type.*

USING THE PROJECTOR







OSD Menu tree (SVGA, XGA, and WXGA models)

| Main Menu | Sub Menu | Sub Menu 2 | Sub Menu 3 | Sub Menu 4 | Values | |
|------------|----------------|----------------|---------------------|------------|-------------------|-------------|
| Display | Image Settings | Display Mode | [Data] | | Presentation | |
| | | | | | Bright | |
| | | | | | Cinema | |
| | | | | | Game | |
| | | | | | sRGB | |
| | | | | | DICOM SIM. | |
| | | | | | User | |
| | | | | | 3D | |
| | | Wall Color | | | Off [Default] | |
| | | | | | Blackboard | |
| | | | | | Light Yellow | |
| | | | | | Light Green | |
| | | | | | Light Blue | |
| | | | | | Pink | |
| | | | | | Gray | |
| | | Brightness | | | -50~50 | |
| | | Contrast | | | -50~50 | |
| | | Sharpness | | | 1~15 | |
| | | Color | | | -50~50 | |
| | | Tint | | | -50~50 | |
| | | Gamma | | | Film | |
| | | | | | Video | |
| | | | | | Graphics | |
| | | | | | Standard(2.2) | |
| | | | | | 1.8 | |
| | | | | | 2.0 | |
| | | | | | 2.4 | |
| | | Color Settings | BrilliantColor™ | | 1~10 | |
| | | | | | Color Temperature | [Data mode] |
| | | | | | | Warm |
| | | | Medium | | | |
| | | | Color Matching | | | Cool |
| Color | R [Default] | | | | | |
| | G | | | | | |
| | B | | | | | |
| | C | | | | | |
| | Y | | | | | |
| | M | | | | | |
| | W | | | | | |
| Hue | | | -50~50 [Default: 0] | | | |
| Saturation | | | -50~50 [Default: 0] | | | |
| Gain | | | -50~50 [Default: 0] | | | |

USING THE PROJECTOR

| Main Menu | Sub Menu | Sub Menu 2 | Sub Menu 3 | Sub Menu 4 | Values |
|-----------|----------------|-----------------|------------------------------|---|------------------|
| Display | Image Settings | Color Settings | Color Matching | Reset | Cancel [Default] |
| | | | | | Yes |
| | | | | Exit | |
| | | | RGB Gain/Bias | Red Gain | -50~50 |
| | | | | Green Gain | -50~50 |
| | | | | Blue Gain | -50~50 |
| | | | | Red Bias | -50~50 |
| | | | | Green Bias | -50~50 |
| | | | | Blue Bias | -50~50 |
| | | | | Reset | Cancel [Default] |
| | | | | Yes | |
| | | | Exit | | |
| | | | Color Space [Not HDMI Input] | | Auto [Default] |
| | | | | | RGB |
| | | | | | YUV |
| | | | Color Space [HDMI Input] | | Auto [Default] |
| | | | | | RGB(0~255) |
| | | | | | RGB(16~235) |
| | | | | YUV | |
| | | White Level | 0~31 (depends on signal) | | |
| | | Black Level | -5~5 (depends on signal) | | |
| | | IRE | | 0 | |
| | | | | 7.5 | |
| | | Signal | Automatic | | Off |
| | | | | | On [Default] |
| | | | Frequency | -10~10 (depends on signal) [Default: 0] | |
| | | | Phase | 0~31 (depends on signal) [Default: 0] | |
| | | | H. Position | -5~5 (depends on signal) [Default: 0] | |
| | | | V. Position | -5~5 (depends on signal) [Default: 0] | |
| | | Exit | | | |
| | | Brightness Mode | | [Lamp Base - Data] | Bright |
| | | | | | Eco. |
| | Dynamic | | | | |
| | Eco+ | | | | |
| Reset | | | | | |

USING THE PROJECTOR

| Main Menu | Sub Menu | Sub Menu 2 | Sub Menu 3 | Sub Menu 4 | Values | |
|-------------|---------------|---|------------|------------|---|----------------------------------|
| Display | 3D | 3D Mode | | | Off | |
| | | | | | DLP-Link [Default] | |
| | | | | | IR | |
| | | 3D->2D | | | 3D [Default] | |
| | | | | | L | |
| | | | | | R | |
| | | 3D Format | | | Auto [Default] | |
| | | | | | SBS | |
| | | | | | Top and Bottom | |
| | | 3D sync invert | | | Frame Sequential | |
| | | | | On | | |
| | Aspect Ratio | | | | | Off [Default] |
| | | | | | | 4:3 |
| | | | | | | 16:9 |
| | | | | | | 16:10 [WXGA model] |
| | | | | | | LBX [except SVGA and XGA models] |
| | | | | | | Native |
| | Edge Mask | | | | | Auto |
| | Zoom | | | | | 0~10 [Default: 0] |
| Image shift | |  H | | | -5~25 [Default: 0] | |
| | |  V | | | -50~50 [Default: 0] | |
| Keystone | | | | | -40~40 [Default: 0] | |
| Audio | Mute | | | | Off [Default] | |
| | | | | | On | |
| | Volume | | | | 0-10 [Default: 5] | |
| Setup | Projection | | | | Front  [Default] | |
| | | | | | Rear  | |
| | | | | | Ceiling-top  | |
| | | | | | Rear-top  | |
| | Screen Type | [WXGA model] | | | | 16:9 |
| | | | | | | 16:10 [Default] |
| | Lamp Settings | Lamp Reminder | | | | Off |
| | | | | | | On [Default] |
| | Lamp Reset | | | | Cancel [Default] | |
| | | | | | Yes | |





USING THE PROJECTOR

| Main Menu | Sub Menu | Sub Menu 2 | Sub Menu 3 | Sub Menu 4 | Values | |
|-----------|-----------------|---------------------------|-----------------|------------|---|-----|
| Setup | Filter Settings | Optional Filter Installed | | | Yes | |
| | | | | | No | |
| | | Filter Usage Hours | | | (Read only) | |
| | | | | | | |
| | | Filter Reminder | | | Off | |
| | | | | | 300hr | |
| | | | | | 500hr [Default] | |
| | | | | | 800hr | |
| | | Filter Reset | | | 1000hr | |
| | | | | | Cancel [Default] | |
| | Power Settings | Direct Power On | | | Off [Default] | |
| | | | | | On | |
| | | Signal Power On | | | Off [Default] | |
| | | | | | On | |
| | | Auto Power Off (min) | | | 0~180 (5 min increments) [Default: 20] | |
| | | | | | 0~990 (30 min increments) [Default: 0] | |
| | | Sleep Timer (min) | Always On | | No [Default] | |
| | | | | | Yes | |
| | | Quick Resume | | | Off [Default] | |
| | | | | | On | |
| | | Power Mode (Standby) | | | Active | |
| | | | | | Eco [Default] | |
| | | USB Power | | | Off | |
| | | | | | On | |
| | Security | Security | | | Off | |
| | | | | | On | |
| | | Security Timer | | Month | | |
| | | | | Day | | |
| | | | | Hour | | |
| | | Change Password | | | | |
| | | | | | | |
| | | HDMI Link Settings | HDMI Link | | | Off |
| | | | | | | On |
| | | | Inclusive of TV | | | No |
| | | | | | Yes | |
| | Power On Link | | | | Mutual | |
| | | | | | PJ --> Device | |
| | Power Off Link | | | | Device --> PJ | |
| | | | | | Off | |
| | | | | On | | |

USING THE PROJECTOR

| Main Menu | Sub Menu | Sub Menu 2 | Sub Menu 3 | Sub Menu 4 | Values | | |
|-----------|--|-------------|------------|------------|--------------|----------------------|--------------------------|
| Setup | Test Pattern | | | | Green Grid | | |
| | | | | | Magenta Grid | | |
| | | | | | White Grid | | |
| | | | | | White | | |
| | | | | | Off | | |
| | Remote Settings [depends on remote] | IR Function | | | | On | |
| | | | | | | Off | |
| | | User 1 | | | | | Test Pattern |
| | | | | | | | Brightness |
| | | | | | | | Contrast |
| | | | | | | | Sleep Timer [Default] |
| | | | | | | | Color Matching |
| | | | | | | | Color Temp |
| | | | | | | | Gamma |
| | | | | | | | Projection |
| | | | | | | | Lamp Settings |
| | | | | | | | Zoom |
| | | | | | | Freeze | |
| | | User 2 | | | | | Test Pattern |
| | | | | | | | Brightness |
| | | | | | | | Contrast |
| | | | | | | | Sleep Timer |
| | | | | | | | Color Matching [Default] |
| | | | | | | | Color Temp |
| | | | | | | | Gamma |
| | | | | | | | Projection |
| | | | | | | | Lamp Settings |
| | | | | | | | Zoom |
| | | | | | | Freeze | |
| | | User 3 | | | | | Test Pattern |
| | | | | | | | Brightness |
| | | | | | | | Contrast |
| | | | | | | | Sleep Timer |
| | | | | | | Color Matching | |
| | | | | | | Color Temp [Default] | |
| | | | | | | Gamma | |
| | | | | | | Projection | |
| | | | | | | Lamp Settings | |
| | | | | | Zoom | | |
| | | | | Freeze | | | |

USING THE PROJECTOR

| Main Menu | Sub Menu | Sub Menu 2 | Sub Menu 3 | Sub Menu 4 | Values |
|-----------|--------------|-----------------|---------------|-------------------|--|
| Setup | Projector ID | | | | 0~99 |
| | Options | Language | | | English [Default] |
| | | | | | Deutsch |
| | | | | | Français |
| | | | | | Italiano |
| | | | | | Español |
| | | | | | Português |
| | | | | | Polski |
| | | | | | Nederlands |
| | | | | | Svenska |
| | | | | | Norsk/Dansk |
| | | | | | Suomi |
| | | | | | ελληνικά |
| | | | | | 繁體中文 |
| | | | | | 简体中文 |
| | | | | | 日本語 |
| | | | | | 한국어 |
| | | | | | Русский |
| | | | | | Magyar |
| | | | | | Čeština |
| | | | | | عربي |
| | | | | | ไทย |
| | | | | | Türkçe |
| | | | | | فارسی |
| | | | | | Tiếng Việt |
| | | | | | Bahasa Indonesia |
| | | | | | Română |
| | | | | | Slovenčina |
| | | | | Closed Captioning | |
| | | | | | CC2 |
| | | | | | Off [Default] |
| | | Menu Settings | Menu Location | | Top left  |
| | | | | | Top right  |
| | | | | | Center  [Default] |
| | | | | | Bottom left  |
| | | | | | Bottom right  |
| | | | Menu Timer | | Off |
| | | | | 5sec | |
| | | 10sec [Default] | | | |
| | Auto Source | | | Off [Default] | |
| | | | | On | |

USING THE PROJECTOR

| Main Menu | Sub Menu | Sub Menu 2 | Sub Menu 3 | Sub Menu 4 | Values | |
|------------------|----------|-------------------|------------------|------------|----------------------------------|-------------------|
| Setup | Options | Input Source | | | HDMI | |
| | | | | | VGA | |
| | | | | | Video | |
| | | Input Name | HDMI | | | Default [Default] |
| | | | | | | Custom |
| | | | VGA | | | Default [Default] |
| | | | | | | Custom |
| | | | Video | | | Default [Default] |
| | | | | | | Custom |
| | | High Altitude | | | Off [Default] | |
| | | | | | On | |
| | | Display Mode Lock | | | Off [Default] | |
| | | | | | On | |
| | | Keypad Lock | | | Off [Default] | |
| | | | | | On | |
| | | Information Hide | | | Off [Default] | |
| | | | | | On | |
| | | Logo | | | Default [Default] | |
| | | | | | Neutral | |
| | | Background Color | | | None [Default: for Video/Pro-AV] | |
| | | | | | Blue [Default for Data mode] | |
| | | | | | Red | |
| | | | | | Green | |
| | | | | | Grey | |
| | | | | | Logo | |
| | | Reset OSD | | | Cancel [Default] | |
| | | | | | Yes | |
| Reset to Default | | | Cancel [Default] | | | |
| | | | Yes | | | |

USING THE PROJECTOR

| Main Menu | Sub Menu | Sub Menu 2 | Sub Menu 3 | Sub Menu 4 | Values | |
|-------------|----------------------|------------|------------|------------|--------|-------|
| Information | Regulatory | | | | | |
| | Serial Number | | | | | |
| | Source | | | | | |
| | Resolution | | | | 00x00 | |
| | Refresh Rate | | | | 0.00Hz | |
| | Display Mode | | | | | |
| | Power mode (Standby) | | | | | |
| | Lamp Hours | Bright | | | | 0 hr |
| | | Eco | | | | 0 hr |
| | | Dynamic | | | | 0 hr |
| | | Eco+ | | | | 0 hr |
| | | Total | | | | |
| | Projector ID | | | | | 00~99 |
| | Filter Usage Hours | | | | | |
| | Brightness Mode | | | | | |
| | FW Version | System | | | | |
| MCU | | | | | | |

Note:

- The “Lamp Reset” in OSD will only reset both Lamp Hours in OSD and Lamp Hours in service mode. The Projection Hours in service mode will not be reset.
- Each display mode can be adjusted and saved the value.
- In 3D timing mode, the zoom/edge mask will be disabled to prevent from image break.
- The available menu options vary depending on the model type.

Display menu

Display image settings menu

Display Mode (Data mode)

There are many factory presets optimized for various types of images.

- **Presentation:** This mode is suitable for showing PowerPoint presentations when the projector is connected to the PC.
- **Bright:** Maximum brightness from PC input.
- **Cinema:** Select this mode for home theater.
- **Game:** Select this mode to increase the brightness and response time level for enjoying video games.
- **sRGB:** Standardized accurate color.
- **DICOM SIM.:** This mode can project a monochrome medical image such as an X ray radiography, MRI, etc.
- **User:** Memorize user’s settings.
- **3D:** To experience the 3D effect, you need to have 3D glasses. Make sure your PC/portable device has a 120 Hz signal output quad buffered graphics card and a 3D Player installed.

USING THE PROJECTOR

Wall Color

Use this function to obtain an optimized screen image according to the wall color. Select between off, blackboard, light yellow, light green, light blue, pink, and gray.

Brightness

Adjust the brightness of the image.

Contrast

The contrast controls the degree of difference between the lightest and darkest parts of the picture.

Sharpness

Adjust the sharpness of the image.

Color

Adjust a video image from black and white to fully saturated color.

Tint

Adjust the color balance of red and green.

Gamma

Set up gamma curve type. After the initial setup and fine tuning is completed, utilize the Gamma Adjustment steps to optimize your image output.

- **Film:** For home theater.
- **Video:** For video or TV source.
- **Graphics:** For PC / Photo source.
- **Standard(2.2):** For standardized setting.
- **1.8/ 2.0/ 2.4:** For specific PC / Photo source.

Color Settings

Configure the color settings.

- **BrilliantColor™:** This adjustable item utilizes a new color-processing algorithm and enhancements to enable higher brightness while providing true, more vibrant colors in picture.
- **Color Temperature (Data mode):** Select a color temperature from Warm, Medium, or Cool.
- **Color Matching:** Select the following options:
 - **Color:** Adjust the red (R), green (G), black (B), cyan (C), yellow (Y), magenta (M), and white (W) level of the image.
 - **Hue:** Adjust the color balance of red and green.
 - **Saturation:** Adjust a video image from black and white to fully saturated color.
 - **Gain:** Adjust the image brightness.
 - **Reset:** Return the factory default settings for color matching.
 - **Exit:** Exit the “Color Matching” menu.
- **RGB Gain/Bias:** This settings allows to configure the brightness (gain) and contrast (bias) of an image.
 - **Reset:** Return the factory default settings for RGB gain/bias.
 - **Exit:** Exit the “RGB Gain/Bias” menu.

USING THE PROJECTOR



- **Color Space (non-HDMI input only):** Select an appropriate color matrix type from the following: AUTO, RGB, or YUV.
- **Color Space (HDMI input only):** select an appropriate color matrix type from the following: Auto, RGB(0-255), RGB(16-235), and YUV.
- **White Level:** Allow user to adjust White Level when inputting Video signals.
Note: *White level can only be adjusted for Video input source.*
- **Black Level:** Allow user to adjust Black Level when inputting Video signals.
Note: *Black level can only be adjusted for Video input source.*
- **IRE:** Allow user to adjust IRE value when inputting Video signals.
Note:
 - *IRE is only available with NTSC video format.*
 - *IRE can only be adjusted for Video input sources.*

Signal

Adjust the signal options.

- **Automatic:** Configure automatically the signal (the frequency and phase items are grayed out). If automatic is disabled, the frequency and phase items will appear for tuning and saving the settings.
- **Frequency:** Change the display data frequency to match the frequency of your computer's graphic card. Use this function only if the image appears to flicker vertically.
- **Phase:** Synchronize the signal timing of the display with the graphic card. If the image appears to be unstable or flickers, use this function to correct it.
- **H. Position:** Adjust the horizontal positioning of the image.
- **V. Position:** Adjust the vertical positioning of the image.
- **Exit:** Exit the "Signal" menu.

Note: *Signal can only be adjusted for RGB/Component input sources.*

Brightness Mode (Lamp base data)

Adjust the brightness mode settings for lamp-based projectors.

- **Bright:** Choose "Bright" to increase the brightness.
- **Eco.:** Choose "Eco." to dim the projector lamp which will lower power consumption and extend the lamp life.
- **Dynamic:** Choose "Dynamic" to dim the lamp power which will be based on brightness level of the content and adjust lamp power consumption between 100% and 30% dynamically. The lamp life will be extended.
- **Eco+:** When Eco+ mode is activated, the brightness level of the content is automatically detected to significantly reduced lamp power consumption (up to 70%) during periods of inactivity.

USING THE PROJECTOR

Reset

Return the factory default settings for color settings.

Display 3D menu

3D Mode

Use this option to disable the 3D function or select the appropriate the 3D function.

- **Off:** Select “Off” to turn off 3D mode.
- **DLP-Link:** Select to use optimized settings for DLP 3D Glasses.
- **IR:** Select “IR” to use optimized setting for IR 3D Glasses.

3D → 2D

Use this option to specify how the 3D content should appear on the screen.

- **3D:** Display 3D signal.
- **L (Left):** Display the left frame of 3D content.
- **R (Right):** Display the right frame of 3D content.

3D Format

Use this option to select the appropriate 3D format content.

- **Auto:** When a 3D identification signal is detected, the 3D format is selected automatically.
- **SBS:** Display 3D signal in “Side-by-Side” format.
- **Top and Bottom:** Display 3D signal in “Top and Bottom” format.
- **Frame Sequential:** Display 3D signal in “Frame Sequential” format.

3D Sync Invert

Use this option to enable/disable the 3D sync invert function.

Display aspect ratio menu

Aspect Ratio

Select the aspect ratio of the displayed image between the following options:

- **4:3:** This format is for 4:3 input sources.
- **16:9:** This format is for 16:9 input sources, like HDTV and DVD enhanced for Wide screen TV.
- **16:10 (WXGA and WUXGA models only):** This format is for 16:10 input sources, like widescreen laptops.
- **LBX (except SVGA and XGA models):** This format is for non-16x9, letterbox source and if you use external 16x9 lens to display 2.35:1 aspect ratio in full resolution.
- **Native:** This format displays the original image without any scaling.
- **Auto:** Automatically selects the appropriate display format.

USING THE PROJECTOR

Note:

- It is considered normal that black bars appear on the right side and left side of the image with the resolution of WUXGA; and around the image with a resolution of 1080p in each aspect mode.
- The black bars and boarder will change in size depending on the aspect ratio.

- Black bars
- WUXGA active area
- 1080p active area

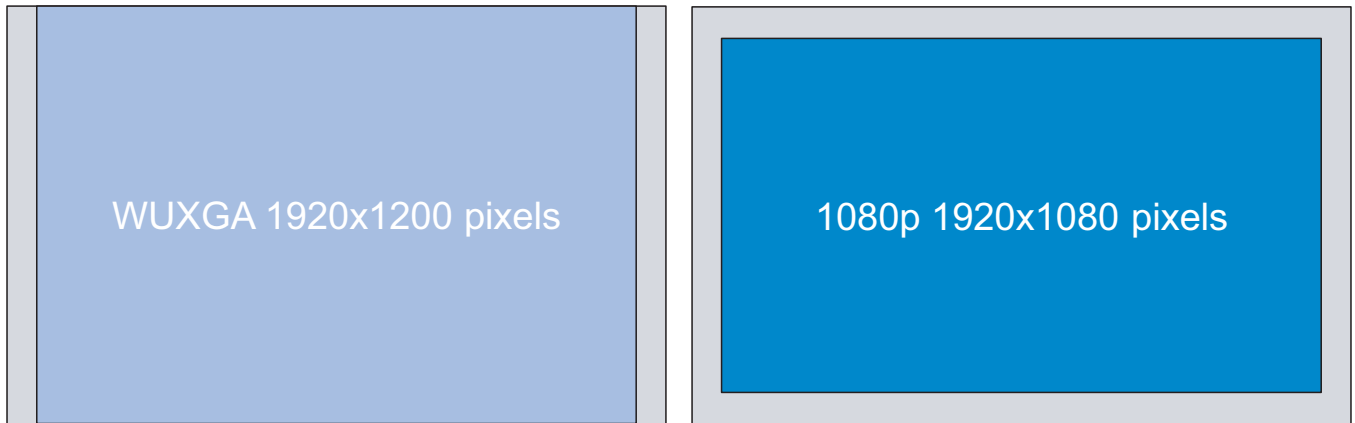

For projectors with a resolution of WUXGA (1920 × 1200)

| Format | Aspect ratio | | |
|--------|--------------|------|-----|
| | 16:10 | 16:9 | 4:3 |
| Native | | | |
| 16:9 | | | |
| Full | | | |
| Zoom | | | |
| Auto | | | |

USING THE PROJECTOR

Note:

- *Detailed informations about LBX mode:*
 - *Some Letter-Box Format DVDs are not enhanced for 16x9 TVs. In this situation, the image will not look right when displaying image in 16:9 mode. In this situation, please try to use the 4:3 mode to view the DVD. If the content is not 4:3, there will be black bars around the image in 16:9 display. For this type of content, you can use LBX mode to fill the image on the 16:9 display.*
 - *If you use an external anamorphic lens, this LBX mode also allows you to watch a 2.35:1 content (include Anamorphic DVD and HDTV film source) that supports anamorphic wide is enhanced for 16x9 Display in a wide 2.35:1 image. In this case, there are no black bars. Lamp power and vertical resolution are fully utilized.*
- *To use the superwide format, do the following:*
 - a) *Set the screen aspect ratio to 2.0:1.*
 - b) *Align the projector image correctly on the screen.*

1080P scaling table:

| 16:9 screen | 480i/p | 576i/p | 1080i/p | 720p | PC |
|-------------|---|--------|---------|------|----|
| 4x3 | Scale to 1440x1080. | | | | |
| 16x9 | Scale to 1920x1080. | | | | |
| LBX | Scale to 1920x1440, then get the central 1920x1080 image to display. | | | | |
| Native mode | -1:1 mapping centered. -No scaling will be made; the image is displayed with the resolution based on input source. | | | | |
| Auto | -If this format is selected, screen type will auto become 16:9 (1920x1080). -If source is 4:3, auto resize to 1440 x1080. -If source is 16:9 auto resize to 1920x1080. -If source is 16:10 auto resize to 1920x1200 and cut 1920x1080 area to display. | | | | |

1080P auto mapping rule:

| Auto | Input resolution | | Auto/Scale | |
|-------------|------------------|--------------|------------|------|
| | H-resolution | V-resolution | 1920 | 1080 |
| 4:3 | 640 | 480 | 1440 | 1080 |
| | 800 | 600 | 1440 | 1080 |
| | 1024 | 768 | 1440 | 1080 |
| | 1280 | 1024 | 1440 | 1080 |
| | 1400 | 1050 | 1440 | 1080 |
| | 1600 | 1200 | 1440 | 1080 |
| Wide Laptop | 1280 | 720 | 1920 | 1080 |
| | 1280 | 768 | 1800 | 1080 |
| | 1280 | 800 | 1728 | 1080 |
| SDTV | 720 | 576 | 1350 | 1080 |
| | 720 | 480 | 1620 | 1080 |
| HDTV | 1280 | 720 | 1920 | 1080 |
| | 1920 | 1080 | 1920 | 1080 |

USING THE PROJECTOR

WXGA scaling table (screen type 16:10):

Note:

- Supported screen type 16:9 (1280x720), 16:10 (1280x800).
- When screen type is 16:9 there is no 16x10 format in this condition.
- When screen type is 16:10 there is no 16x9 format in this condition.
- If user change to auto, will auto change the display mode at same time.

| 16 : 10 screen | 480i/p | 576i/p | 1080i/p | 720p | PC |
|----------------|--|--------|-------------------------------|--------------------|-----------------------|
| 4x3 | Scale to 1066x800. | | | | |
| 16x10 | Scale to 1280x800. | | | | |
| LBX | Scale to 1280x960, then get the central 1280x800 image to display. | | | | |
| Native mode | 1:1 mapping centered. | | 1:1 mapping display 1280x800. | 1280x720 centered. | 1:1 mapping centered. |
| Auto | -Input source will be fit into 1280x800 display area and be kept its original aspect ratio. -If source is 4:3, auto resize to 1066x800. -If source is 16:9 auto resize to 1280x720. -If source is 15:9 auto resize to 1280x768. -If source is 16:10 auto resize to 1280 x 800. | | | | |

WXGA auto mapping rule (screen type 16:10):

| Auto | Input resolution | | Auto/Scale | |
|-------------|------------------|--------------|------------|-----|
| | H-resolution | V-resolution | 1280 | 800 |
| 4:3 | 640 | 480 | 1066 | 800 |
| | 800 | 600 | 1066 | 800 |
| | 1024 | 768 | 1066 | 800 |
| | 1280 | 1024 | 1066 | 800 |
| | 1400 | 1050 | 1066 | 800 |
| | 1600 | 1200 | 1066 | 800 |
| Wide Laptop | 1280 | 720 | 1280 | 720 |
| | 1280 | 768 | 1280 | 768 |
| | 1280 | 800 | 1280 | 800 |
| SDTV | 720 | 576 | 1280 | 720 |
| | 720 | 480 | 1280 | 720 |
| HDTV | 1280 | 720 | 1280 | 720 |
| | 1920 | 1080 | 1280 | 720 |

USING THE PROJECTOR

WXGA scaling table (screen type 16:9):

| 16 : 9 screen | 480i/p | 576i/p | 1080i/p | 720p | PC |
|---------------|--|--------|-------------------------------|--------------------|-----------------------|
| 4x3 | Scale to 960x720. | | | | |
| 16x9 | Scale to 1280x720. | | | | |
| LBX | Scale to 1280x960, then get the central 1280x720 image to display. | | | | |
| Native mode | 1:1 mapping centered. | | 1:1 mapping display 1280x720. | 1280x720 centered. | 1:1 mapping centered. |
| Auto | -If this format is select, Screen type will auto become 16:9 (1280x720). -If source is 4:3, auto resize to 960x720. -If source is 16:9 auto resize to 1280x720. -If source is 15:9 auto resize to 1200x720. -If source is 16:10 auto resize to 1152x720. | | | | |

WXGA auto mapping rule (screen type 16:9):

| Auto | Input resolution | | Auto/Scale | |
|-------------|------------------|--------------|------------|-----|
| | H-resolution | V-resolution | 1280 | 720 |
| 4:3 | 640 | 480 | 960 | 720 |
| | 800 | 600 | 960 | 720 |
| | 1024 | 768 | 960 | 720 |
| | 1280 | 1024 | 960 | 720 |
| | 1400 | 1050 | 960 | 720 |
| | 1600 | 1200 | 960 | 720 |
| Wide Laptop | 1280 | 720 | 1280 | 720 |
| | 1280 | 768 | 1200 | 720 |
| | 1280 | 800 | 1152 | 720 |
| SDTV | 720 | 576 | 1280 | 720 |
| | 720 | 480 | 1280 | 720 |
| HDTV | 1280 | 720 | 1280 | 720 |
| | 1920 | 1080 | 1280 | 720 |

SVGA and XGA scaling table:

| Source | 480i/p | 576i/p | 1080i/p | 720p |
|-------------|---|--------|---------|------|
| 4x3 | Scale to 1024x768. | | | |
| 16x9 | Scale to 1024x576. | | | |
| Native mode | No scaling will be made; the resolution is dependent on which input source and is then displayed. | | | |
| Auto | -If source is 4:3, auto resize to 1024x768. -If source is 16:9 auto resize to 1024x576. -If source is 15:9 auto resize to 1024x614. -If source is 16:10 auto resize to 1024x640. | | | |

USING THE PROJECTOR

SVGA and XGA auto mapping rule (screen type 16:9):

| Auto | Input resolution | | Auto/Scale | |
|-------------|------------------|--------------|------------|-----|
| | H-resolution | V-resolution | 1024 | 768 |
| 4:3 | 640 | 480 | 1024 | 768 |
| | 800 | 600 | 1024 | 768 |
| | 1024 | 768 | 1024 | 768 |
| | 1600 | 1200 | 1024 | 768 |
| Wide Laptop | 1280 | 720 | 1024 | 576 |
| | 1280 | 768 | 1024 | 614 |
| | 1280 | 800 | 1024 | 640 |
| SDTV | 720 | 576 | 1024 | 576 |
| | 720 | 480 | 1024 | 576 |
| HDTV | 1280 | 720 | 1024 | 576 |
| | 1920 | 1080 | 1024 | 576 |

WUXGA scaling table (screen type 16:10):

Note:

- Supported screen type 16:10 (1920x1200), 16:9 (1920x1080).
- When screen type is 16:9 there is no 16x10 format in this condition.
- When screen type is 16:10 there is no 16x9 format in this condition.
- If user change to auto, will auto change the display mode at same time.

| 16 : 10 screen | 480i/p | 576i/p | 1080i/p | 720p | PC |
|----------------|---|--------|---------|------|----|
| 4x3 | Scale to 1600x1200. | | | | |
| 16x10 | Scale to 1920x1200. | | | | |
| LBX | Scale to 1920x1440, then get the central 1920x1200 image to display. | | | | |
| Native mode | -1:1 mapping centered. -No scaling will be made; the resolution is dependent on which input source and is then displayed. | | | | |
| Auto | -If this format is select, screen type will auto become 16:10 (1920x1200). -If source is 4:3, auto resize to 1600x1200. -If source is 16:9 auto resize to 1920x1080. -If source is 16:10 auto resize to 1920x1200. | | | | |

USING THE PROJECTOR

WUXGA auto mapping rule (screen type 16:10):

| Auto | Input resolution | | Auto/Scale | |
|-------------|------------------|--------------|------------|------|
| | H-resolution | V-resolution | 1920 | 1200 |
| 4:3 | 640 | 480 | 1600 | 1200 |
| | 800 | 600 | 1600 | 1200 |
| | 1024 | 768 | 1600 | 1200 |
| | 1280 | 1024 | 1600 | 1200 |
| | 1400 | 1050 | 1600 | 1200 |
| | 1600 | 1200 | 1600 | 1200 |
| Wide Laptop | 1280 | 720 | 1920 | 1080 |
| | 1280 | 768 | 1920 | 1152 |
| | 1280 | 800 | 1920 | 1200 |
| SDTV | 720 | 576 | 1500 | 1200 |
| | 720 | 480 | 1800 | 1200 |
| HDTV | 1280 | 720 | 1920 | 1080 |
| | 1280 | 1080 | 1920 | 1080 |

WUXGA scaling table (screen type 16:9):

| 16 : 9 screen | 480i/p | 576i/p | 1080i/p | 720p | PC |
|---------------|--|--------|---------|------|----|
| 4x3 | Scale to 1440x1080. | | | | |
| 16x9 | Scale to 1920x1080. | | | | |
| LBX | Scale to 1920x1440, then get the central 1920x1080 image to display. | | | | |
| Native mode | -1:1 mapping centered. -No scaling will be made; the resolution is dependent on which input source and is then displayed. | | | | |
| Auto | -If this format is select, Screen type will auto become 16:9 (1920x1080). -If source is 4:3, auto resize to 1440x1080. -If source is 16:9 auto resize to 1920x1080. -If source is 16:10 auto resize to 1920x1200 and cut 1920x1080 area to display. | | | | |

WUXGA auto mapping rule (screen type 16:9):

| Auto | Input resolution | | Auto/Scale | |
|-------------|------------------|--------------|------------|------|
| | H-resolution | V-resolution | 1920 | 1080 |
| 4:3 | 640 | 480 | 1440 | 1080 |
| | 800 | 600 | 1440 | 1080 |
| | 1024 | 768 | 1440 | 1080 |
| | 1280 | 1024 | 1440 | 1080 |
| | 1400 | 1050 | 1440 | 1080 |
| | 1600 | 1200 | 1440 | 1080 |
| Wide Laptop | 1280 | 720 | 1920 | 1080 |
| | 1280 | 768 | 1800 | 1080 |
| | 1280 | 800 | 1728 | 1080 |
| SDTV | 720 | 576 | 1350 | 1080 |
| | 720 | 480 | 1620 | 1080 |
| HDTV | 1280 | 720 | 1920 | 1080 |
| | 1920 | 1080 | 1920 | 1080 |

USING THE PROJECTOR

Display edge mask menu

Edge Mask

Use this function to remove the video encoding noise on the edge of video source.

Display zoom menu

Zoom

Use to reduce or magnify an image on the projection screen.

Display image shift menu

Image Shift

Adjust the projected image position horizontally (H) or vertically (V).

Display keystone menu

Keystone

Adjust the image distortion caused by tilting the projector.

Audio menu

Audio mute menu

Mute

Use this option to temporarily turn off the sound.

- **On:** Choose the “On” to turn mute on.
- **Off:** Choose the “Off” to turn mute off.

Note:

- *“Mute” function affects both internal and external speaker volume.*
- *When an external speaker is connected, the internal speaker is automatically muted.*

Audio volume menu

Volume

Adjust the audio volume level.

USING THE PROJECTOR

Setup menu

Setup projection menu

Projection

Select the preferred projection between front, rear, ceiling-top, and rear-top.

Setup screen type menu

Screen Type (for WXGA and WUXGA models only)

Choose the screen type from 16:9 and 16:10.

Setup lamp settings menu

Lamp Reminder

Choose this function to show or to hide the warning message when the changing lamp message is displayed. The message will appear 30 hours before suggested replacement of lamp.

Lamp Reset

Resets the lamp hour counter after replacing the lamp.

Setup filter settings menu

Optional Filter Installed

Set the warning message setting.

- **Yes:** Display warning message after 500 hours of use.

Note: “Filter Usage Hours / Filter Reminder / Filter Reset” will only appear when “Optional Filter Installed” is “Yes”.

- **No:** Turn off warning message.

Filter Usage Hours

Display the filter time.

Filter Reminder

Choose this function to show or hide the warning message when the changing filter message is displayed. The available options include Off, 300hr, 500hr, 800hr, and 1000hr.

Filter Reset

Reset the dust filter counter after replacing or cleaning the dust filter.

Setup power settings menu

Direct Power On

Choose “On” to activate Direct Power mode. The projector will automatically power on when AC power is supplied, without pressing the “Power” key on the projector keypad or on the remote control.

Signal Power On

Choose “On” to activate Signal Power mode. The projector will automatically power on when a signal is detected, without pressing the “Power” key on the projector Keypad or on the remote control.

Note:

- *If the “Signal Power On” option is turned “On”, the power consumption of the projector in standby mode will be over 3W.*
- *Due to the ErP directive, this feature is not available on models found in EMEA.*

USING THE PROJECTOR

Auto Power Off (min.)

Sets the countdown timer interval. The countdown timer will start, when there is no signal being sent to the projector. The projector will automatically power off when the countdown has finished (in minutes).

Sleep Timer (min.)

Configure the sleep timer.

- **Sleep Timer (min):** Sets the countdown timer interval. The countdown timer will start, with or without a signal being sent to the projector. The projector will automatically power off when the countdown has finished (in minutes).
Note: *The Sleep Timer is reset every time when the projector is powered off.*
- **Always On:** Check to set the sleep timer always on.

Quick Resume

Set the quick resume setting.

- **On:** If the projector is accidentally turned off, this feature allows the projector to be instantly powered on again, if selected within a period of 100 seconds.
- **Off:** The fan will start cooling the system after 10 seconds when user turns off the projector.

Power Mode (Standby)

Set the power mode setting.

- **Active:** Choose "Active" to return to normal standby.
- **Eco:** Choose "Eco." to save power dissipation further < 0.5W.

Note: *The fans will still run in active standby if "Signal Power On" is enabled.*

USB Power

Set the USB power settings.

- **On:** The projector is always powered on by a USB power source.
- **Off:** The USB Power function is off.
- **Auto:** The projector is automatically powered on by a USB power source.

Setup security menu

Security

Enable this function to prompt for a password before using the projector.

- **On:** Choose "On" to use security verification when the turning on the projector.
- **Off:** Choose "Off" to be able to switch on the projector without password verification.

Security Timer

Can be select the time (Month/Day/Hour) function to set the number of hours the projector can be used. Once this time has elapsed you will be requested to enter your password again.

Change Password

Use to set or modify the password that is prompted when turning the projector on.

USING THE PROJECTOR

Setup HDMI link settings menu

Note:

- When you connect HDMI CEC-compatible devices to the projector with HDMI cables, you can control them on the same power on or power off status using the HDMI Link control feature in the projector's OSD. This lets one device or multiple devices in a group power on or power off via HDMI Link Feature in a typical configuration, your DVD player may be connected to the projector through an amplifier or home theater system.

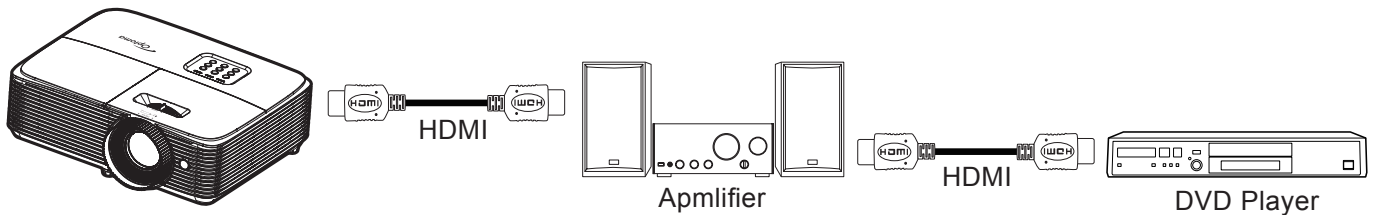

HDMI Link

Enable/disable the HDMI Link function. The inclusive TV, power on link, and power off link options will only be available if the setting is set to "On".

Inclusive of TV

Set to "Yes" if you prefer both TV and projector to be automatically turned off at the same time. To prevent both devices from being turned off at the same time, set the setting to "No".

Power On Link

CEC power on command.

- **Mutual:** Both projector and CEC device will be turned on simultaneously.
- **PJ -> Device:** The CEC device will be turned on only after the projector is switched on.
- **Device -> PJ:** The projector will be switched on only after the CEC device is turned on.

Power Off Link

Enable this function to let both HDMI Link and projector to be automatically turned off at the same time.

Setup test pattern menu

Test Pattern

Select the test pattern from green grid, magenta grid, white grid, white or disable this function (off).

Setup remote settings menu

IR Function

Set the IR function setting.

- **On:** Choose "On", the projector can be operated by the remote control from top IR receiver.
- **Off:** Choose "Off", the projector can't be operated by the remote control. By selecting "Off", you will be able to use the Keypad keys.

User1/ User2/ User3 (Type 1)

Assign the default function for User1, User2, or User3 between HDMI 2, test pattern, brightness, contrast, sleep timer, color matching, color temp, gamma, projection, lamp settings, zoom, freeze, and MHL.

USING THE PROJECTOR

User1/ User2/ User3 (Type 2)

Assign the default function for User1, User2, or User3 between HDMI 2, test pattern, LAN, brightness, contrast, sleep timer, color matching, color temp, gamma, projection, lamp settings, zoom, freeze, and MHL.

User1/ User2/ User3 (Type 3, Type 4, and Type 5)

Assign the default function for User1, User2, or User3 between test pattern, brightness, contrast, sleep timer, color matching, color temp, gamma, projection, lamp settings, zoom, and freeze.

Setup projector ID menu

Projector ID

ID definition can be set up by menu (range 0-99), and allow user control an individual projector by using RS232 command.

Setup options menu

Language

Select the multilingual OSD menu between English, German, French, Italian, Spanish, Portuguese, Polish, Dutch, Swedish, Norwegian/Danish, Finnish, Greek, traditional Chinese, simplified Chinese, Japanese, Korean, Russian, Hungarian, Czechoslovak, Arabic, Thai, Turkish, Farsi, Vietnamese, Indonesian, Romanian, and Slovakian.

Closed Captioning

Closed Captioning is a text version of the program sound or other information displayed on the screen. If the input signal contains closed captions, you can turn on the feature and watch the channels. The available options include "Off", "CC1", and "CC2".



Note: *Closed Captioning is only available for Video NTSC.*

Menu Settings

Set the menu location on the screen and configure menu timer settings.

- **Menu Location:** Select the menu location on the display screen.
- **Menu Timer:** Set the duration where the OSD menu stays visible on the screen.

Auto Source

If you set this option "On" and press the  button on the projector keypad or  button on the remote control then the next available input source is selected automatically. Set "Off" to disable auto source function.

Input Source (WUXGA and 1080P models)

Select the input source between HDMI1/MHL, HDMI2, VGA, and Video.

Input Source (SVGA, XGA, and WXGA models)

Select the input source between HDMI, VGA, and Video.

Input Name (WUXGA and 1080P models)

Use to rename the input function for easier identification. The available options include HDMI1/MHL, HDMI2, VGA, and Video.

Input Name (SVGA, XGA, and WXGA models)

Use to rename the input function for easier identification. The available options include HDMI, VGA, and Video.

High Altitude

When "On" is selected, the fans will spin faster. This feature is useful in high altitude areas where the air is thin.

Display Mode Lock

Choose "On" or "Off" to lock or unlock adjusting display mode settings.

USING THE PROJECTOR

Keypad Lock

When the keypad lock function is “On”, the Keypad will be locked. However, the projector can be operated by the remote control. By selecting “Off”, you will be able to reuse the Keypad.

Information Hide

Enable this function to hide the information message.

- **Off:** Choose “On” to hide the info message.
- **On:** Choose “Off” to show the “searching” message.

Logo

Use this function to set the desired startup screen. If changes are made, they will take effect the next time the projector is powered on.

- **Default:** The default startup screen.
- **Neutral:** Logo is not displayed on startup screen.

Background Color

Use this function to display a blue, red, green, grey color, none, or logo screen when no signal is available.

Note: *If the background color is set to “None”, then the background color is black.*

Setup reset menu

Reset OSD

Return the factory default settings for OSD menu settings.

Reset to Default

Return the factory default settings for Setup menu settings.

Network menu (Type 2)

Network LAN menu

Network Status

Display the network connection status (read-only).

MAC Address

Display the MAC address (read-only).

DHCP

Use this option to enable or disable the DHCP function.

- **On:** Projector will obtain an IP address automatically from your network.
- **Off:** To assign IP, subnet mask, gateway, and DNS configuration manually.

Note: *Exiting OSD will automatically apply the entered values.*

IP Address

Display the IP address.

Subnet Mask

Display subnet mask number.

Gateway

Display the default gateway of the network connected to the projector.

USING THE PROJECTOR

DNS

Display the DNS number.

How to use web browser to control your projector

1. Turn "On" the DHCP option on projector to allow a DHCP server to automatically assign an IP address.
2. Open the web browser in your PC and type in the projector's IP address ("Network > LAN > IP Address").
3. Enter the user name and password, and click "Login".
The projector's configuration web interface opens.

Note:

- The default user name and password is "admin".
- The steps in this section is based on Windows 7 operating system.

Making a direct connection from your computer to the projector*

1. Turn "Off" the DHCP option on the projector.
2. Configure the IP address, Subnet Mask, Gateway, and DNS on projector ("Network > LAN").
3. Open **Network and Sharing Center** page on your PC, and assign the identical network parameters to your PC as set on projector. Click "OK" to save the parameters.

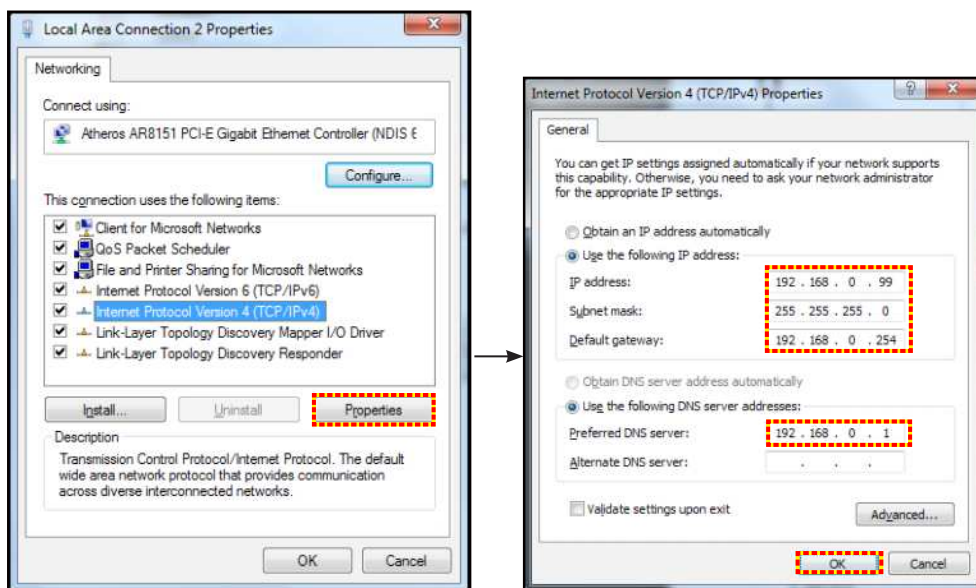

4. Open the web browser on your PC and type in to the URL field the IP address, assigned in step 3. Then press "Enter" key.

Reset

Reset all values for LAN parameters.

Network control menu

Crestron

Use this function to select the network function (port: 41794).

For more information, please visit <http://www.crestron.com> and www.crestron.com/getroomview.

Extron

Use this function to select the network function (port: 2023).

PJ Link

Use this function to select the network function (port: 4352).

USING THE PROJECTOR

AMX Device Discovery

Use this function to select the network function (port: 9131).

Telnet

Use this function to select the network function (port: 23).

HTTP

Use this function to select the network function (port: 80).

Setup network control settings menu

LAN RJ45 function

For simplicity and ease of operation, the projector provides diverse networking and remote management features. The LAN / RJ45 function of the projector through a network, such as remotely manage: Power On / Off, brightness, and contrast settings. Also, you can view the projector status information, such as: Video- Source, Sound-Mute, etc.

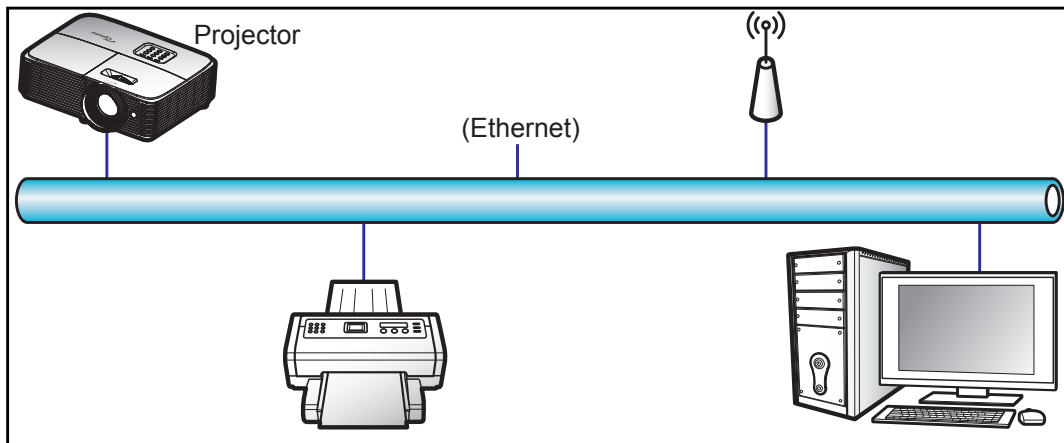

Wired LAN terminal functionalities

This projector can be controlled by using a PC (laptop) or other external device via LAN / RJ45 port and compatible with Crestron / Extron / AMX (Device -Discovery) / PJLink.

- Crestron is a registered trademark of Crestron Electronics, Inc. of the United States.
- Extron is a registered trademark of Extron Electronics, Inc. of the United States.
- AMX is a registered trademark of AMX LLC of the United States.
- PJLink applied for trademark and logo registration in Japan, the United States of America, and other countries by JBMIA.

The projector is supported by the specified commands of the Crestron Electronics controller and related software, for example RoomView®.

<http://www.crestron.com/>

This projector is compliant to support Extron device(s) for reference.

<http://www.extron.com/>

This projector is supported by AMX (Device Discovery).

<http://www.amx.com/>

This projector supports all commands of PJLink Class1 (Version 1.00).

<http://pjlink.jbmia.or.jp/english/>

For more detailed information about the various types of external devices which can be connected to the LAN /

USING THE PROJECTOR

RJ45 port and remote control the projector, as well as the supported commands for these external devices, please contact the Support-Service directly.

LAN RJ45

1. Connect an RJ45 cable to RJ45 ports on the projector and the PC (laptop).

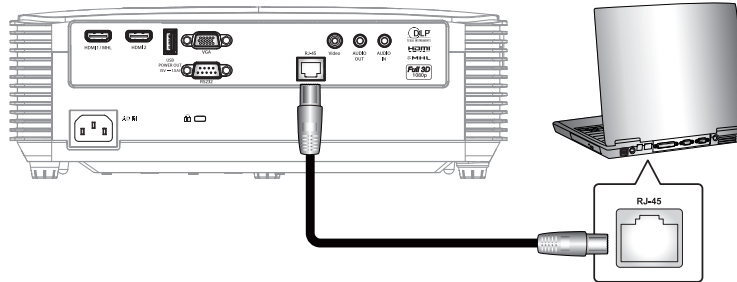

2. On the PC (Laptop), select **Start > Control Panel > Network Connections**.



3. Right-click on the **Local Area Connection**, and select **Property**.

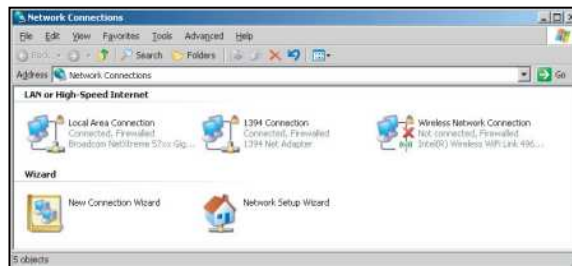

4. In the **Properties** window, select the **General** tab, and select **Internet Protocol (TCP / IP)**.

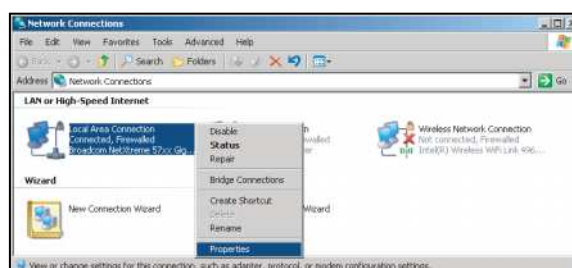

USING THE PROJECTOR

- Click "Properties".

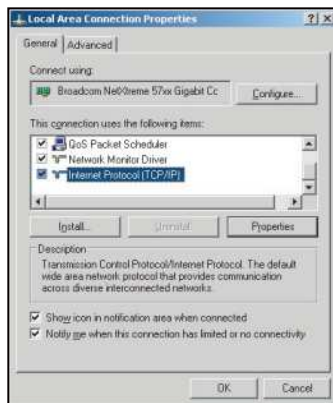

- Type in the IP address and Subnet mask, then press "OK".



- Press the "Menu" button on the projector.
- Open on projector **Network > LAN**.
- Enter the following connection parameters:
 - DHCP: Off
 - IP Address: 192.168.0.100
 - Subnet Mask: 255.255.255.0
 - Gateway: 192.168.0.254
 - DNS: 192.168.0.1
- Press "Enter" to confirm settings.
- Open a web browser, for example Microsoft Internet Explorer with Adobe Flash Player 9.0 or higher installed.
- In the Address bar, input the projector's IP address: 192.168.0.100.



- Press "Enter".

USING THE PROJECTOR

The projector is setup for remote management. The LAN / RJ45 function displays as follows:

Information page

Model: Optoma | Tool | Info | Contact IT Help

Optoma

Projector Information

Projector Name: Optoma 1000
Location:
Firmware Version:
MAC Address: 00:50:41:7F:D4:40
Resolution: NTSC
Lamp Hours: 3
Assigned to: Optoma Projector

Projector Status

Power Status: Power On
Source: Video
Display Mode: Cinema
Projection: Front
Brightness Mode: Bright
Error Status: 0:No Error

exit

CRESTRON connected | Expansion Options

Main page

Model: Optoma | Tool | Info | Contact IT Help

Optoma

Power | Vol - | Mute | Vol +

Sources List

VGA
Video
HDMI 1/MHL
HDMI 2

Menu | Re-Sync
Enter
AV mute | Source

Freeze | Contrast | Brightness | Sharpness

CRESTRON connected | Expansion Options

Tool page

Model: Optoma | Tool | Info | Contact IT Help

Optoma

Crestron Control

IP Address: 192.168.0.7
IP ID: 7
Port: 41794
Send

Projector

Projector Name: Optoma 1000
Location:
Assigned to: Optoma Projector
Send

DHCP: Enabled
IP Address: 192.168.0.100
Subnet Mask: 255.255.255.0
Default Gateway: 192.168.0.254
DNS Server: 192.168.0.1
Send

User Password

Enabled
New Password:
Confirm:
Send

Admin Password

Enabled
New Password:
Confirm:
Send

exit

CRESTRON connected | Expansion Options

Contact IT helpdesk

Title | X

Send

USING THE PROJECTOR

RS232 by Telnet Function

There is alternative RS232 command control way, in projector so called “RS232 by TELNET” for LAN / RJ45 interface.

Quick Start-Guide for “RS232 by Telnet”

- Check and get the IP address on OSD of the projector.
- Make sure that the PC / laptop can access the web-page of the projector.
- Make sure that “Windows Firewall” setting is set disabled in case of “TELNET” function filtering out by PC / laptop.



1. Select **Start > All Programs.> Accessories > Command Prompt.**

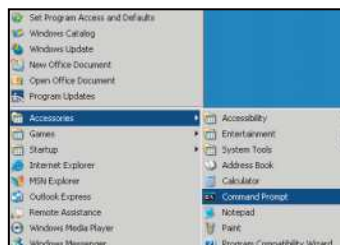

2. Input the command format as follows:
 - telnet ttt.xxx.yyy.zzz 23 (“Enter” key pressed)
 - (ttt.xxx.yyy.zzz: IP-Address of the projector)
3. If Telnet-Connection ready, and user can have RS232 command input, then “Enter” key pressed, the RS232 command will be workable.

Specification for “RS232 by TELNET”:

1. Telnet: TCP.
2. Telnet port: 23 (for more detail, kindly please get contact with the service agent or team).
3. Telnet utility: Windows “TELNET.exe” (console mode).
4. Disconnection for RS232-by-Telnet control normally: Close
5. Windows Telnet utility directly after TELNET connection ready.
 - Limitation 1 for Telnet-Control: there is less than 50 bytes for successive network payload for Telnet-Control application.
 - Limitation 2 for Telnet-Control: there is less than 26 bytes for one complete RS232 command for Telnet-Control.
 - Limitation 3 for Telnet-Control: Minimum delay for next RS232 command must be more than 200 (ms).

USING THE PROJECTOR

Info menu

Info menu

View the projector information as listed below:

- Regulatory
- Serial Number
- Source
- Resolution
- Refresh Rate
- Display Mode
- Power Mode (Standby)
- Lamp Hours
- Network Status (Type 2 only)
- IP Address (Type 2 only)
- Projector ID
- Filter Usage Hours
- Brightness Mode
- FW Version

MAINTENANCE

Replacing the lamp

The projector automatically detects the lamp life. When the lamp life is nearing the end of use, a warning message will appear on the screen.



When you see this message, please contact your local reseller or service center to change the lamp as soon as possible. Make sure the projector has been cooled down for at least 30 minutes before changing the lamp.



Warning: If ceiling mounted, please use caution when opening the lamp access panel. It is recommended to wear safety glasses if changing the bulb when ceiling mounted. Caution must be used to prevent any loose parts from falling out of projector.



Warning: Lamp compartment is hot! Allow it to cool down before changing lamp!



Warning: To reduce the risk of personal injury, do not drop the lamp module or touch the lamp bulb. The bulb may shatter and cause injury if it is dropped.

MAINTENANCE

Replacing the lamp (continued)

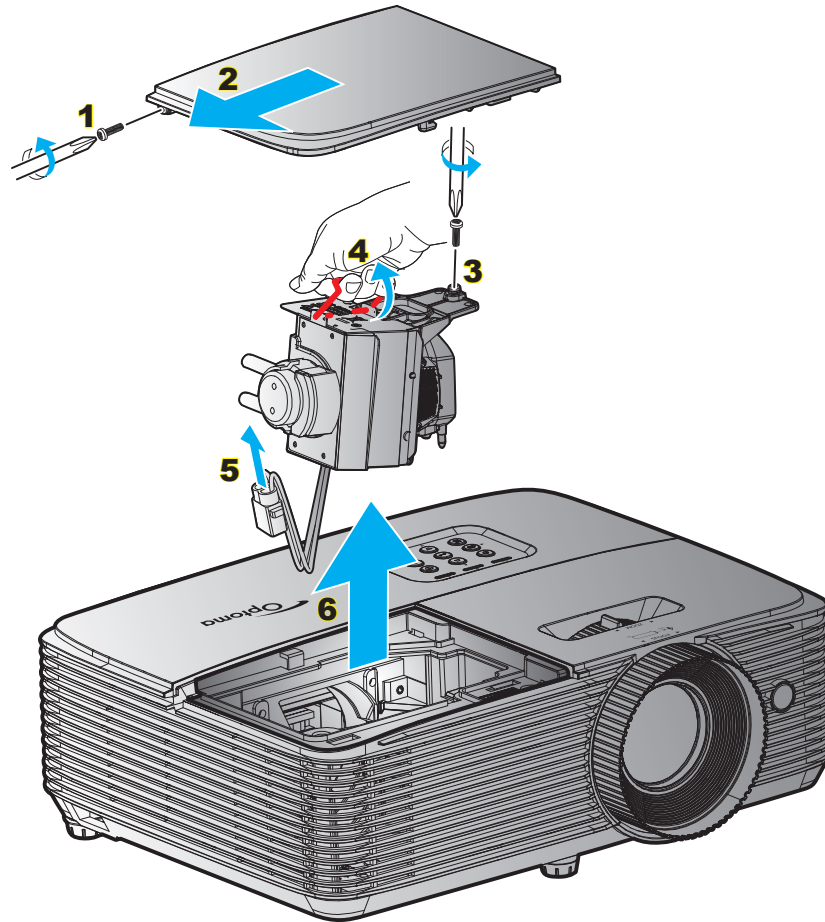

Procedure:

1. Switch off the power to the projector by pressing the "⏻" button on the remote control or the projector keypad.
2. Allow the projector to cool down for at least 30 minutes.
3. Disconnect the power cord.
4. Unscrew the screw on the cover. **1**
5. Remove the cover. **2**
6. Unscrew the screw on the lamp module. **3**
7. Lift up the lamp handle. **4**
8. Remove the lamp cord. **5**
9. Remove the lamp module carefully. **6**
10. To replace the lamp module, reverse the previous steps.
11. Turn on the projector and reset the lamp timer.
12. Lamp Reset: (i) Press "Menu" → (ii) Select "Setup" → (iii) Select "Lamp Settings" → (iv) Select "Lamp Reset" → (v) Select "Yes".

Note:

- The screw on the lamp cover and the lamp cannot be removed.
- The projector cannot be turned on if the lamp cover has not been placed back on the projector.
- Do not touch the glass area of the lamp. Hand oil can cause the lamp shatter. Use a dry cloth to clean the lamp module if it was accidentally touched.

MAINTENANCE

Installing and cleaning the dust filter

Installing the dust filter

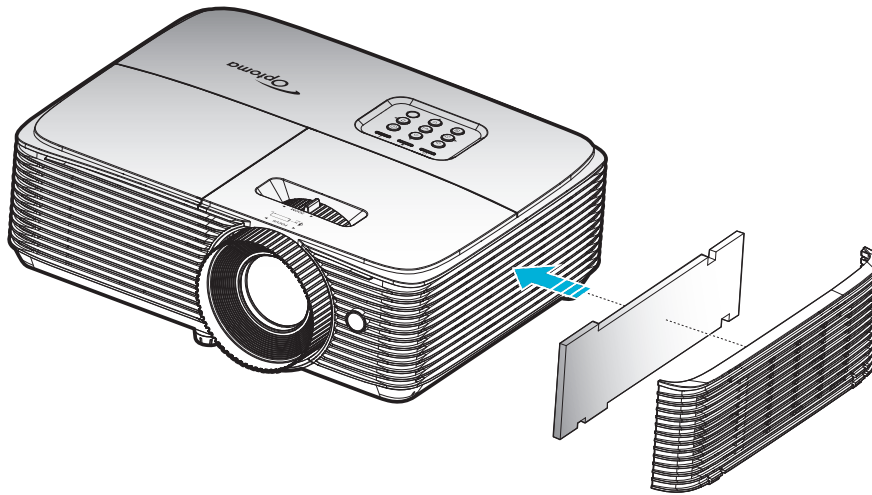

Note: Dust filters are only required/supplied in the selected regions with excessive dust.

Cleaning the dust filter

We recommend you to clean the dust filter every three months. Clean it more often if the projector is used in a dusty environment.

Procedure:

1. Switch off the power to the projector by pressing the "⏻" button on the remote control or the projector keypad.
2. Disconnect the power cord.
3. Remove the dust filter carefully. **1**
4. Clean or replace the dust filter. **2**
5. To install the dust filter, reverse the previous steps.

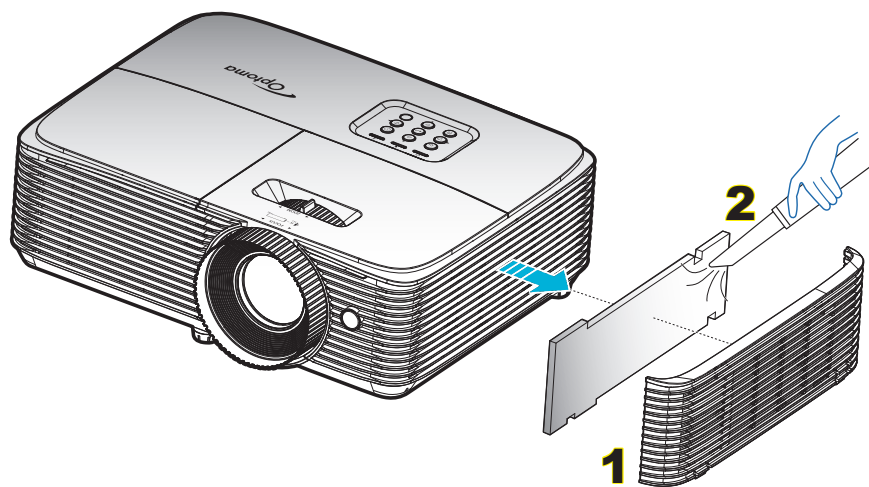

ADDITIONAL INFORMATION

Compatible resolutions

Digital compatibility

| B0/Established Timing | B0/Standard Timing | B0/Detail Timing | B1/Video Mode | B1/Detail Timing |
|-----------------------|--------------------|---|-----------------------|-------------------|
| 720x400 @ 70Hz | SVGA: | Native timing: | 640x480p @ 60Hz | 720x480p @ 60Hz |
| 640x480 @ 60Hz | 800x600 @ 120Hz | | | |
| 640x480 @ 67Hz | 1024x768 @ 120Hz | XGA: 1024x768 @ 60Hz | 720x480p @ 60Hz | 1280x720p @ 60Hz |
| 640x480 @ 72Hz | 1280x800 @ 60Hz | WXGA: 1280x800 @ 60Hz; 1280x720 @ 60Hz | 1280x720p @ 60Hz | 1366x768 @ 60Hz |
| 640x480 @ 75Hz | 1280x1024 @ 60Hz | 1080P: 1920x1080 @ 60Hz | 1920x1080i @ 60Hz | 1920x1080i @ 50Hz |
| 800x600 @ 56Hz | 1680x1050 @ 60Hz | WUXGA: 1920x1200 @ 60Hz | 720(1440)x480i @ 60Hz | 1920x1080p @ 60Hz |
| 800x600 @ 60Hz | 1280x720 @ 60Hz | | 1920x1080p @ 60Hz | |
| 800x600 @ 72Hz | 1280x720 @ 120Hz | | 720x576p @ 50Hz | |
| 800x600 @ 75Hz | 1600x1200 @ 60Hz | | 1280x720p @ 50Hz | |
| 832x624 @ 75Hz | XGA/WXGA: | | 1920x1080i @ 50Hz | |
| 1024x768 @ 60Hz | 1440x900 @ 60Hz | | 720(1440)x576i @ 50Hz | |
| 1024x768 @ 70Hz | 1024x768 @ 120Hz | | 1920x1080p @ 50Hz | |
| 1024x768 @ 75Hz | 1280x800 @ 60Hz | | 1920x1080p @ 24Hz | |
| 1280x1024 @ 75Hz | 1280x1024 @ 60Hz | | 1920x1080p @ 30Hz | |
| 1152x870 @ 75Hz | 1680x1050 @ 60Hz | | | |
| | 1280x720 @ 60Hz | | | |
| | 1280x720 @ 120Hz | | | |
| | 1600x1200 @ 60Hz | | | |
| | 1080P and WUXGA: | | | |
| | 1280x720 @ 60Hz | | | |
| | 1280x800 @ 60Hz | | | |
| | 1280x1024 @ 60Hz | | | |
| | 1400x1050 @ 60Hz | | | |
| | 1600x1200 @ 60Hz | | | |
| | 1280x768 @ 60Hz | | | |
| | 1440x900 @ 60Hz | | | |
| | 1280x720 @ 120Hz | | | |
| | 1024x768 @ 120Hz | | | |

ADDITIONAL INFORMATION

Analog compatibility

| B0/Established Timing | B0/Standard Timing | B0/Detail Timing | B1/Video Mode | B1/Detail Timing |
|-----------------------|--------------------|---|---------------|------------------|
| 720x400 @ 70Hz | SVGA: | Native timing: | | 1366x768 @ 60Hz |
| 640x480 @ 60Hz | 800x600 @ 120Hz | | | |
| 640x480 @ 67Hz | 1024x768 @ 120Hz | XGA: 1024x768 @ 60Hz | | |
| 640x480 @ 72Hz | 1280x800 @ 60Hz | WXGA: 1280x800 @ 60Hz; 1280x720 @ 60Hz | | |
| 640x480 @ 75Hz | 1280x1024 @ 60Hz | 1080P: 1920x1080 @ 60Hz | | |
| 800x600 @ 56Hz | 1680x1050 @ 60Hz | WUXGA: 1920x1200 @ 60Hz | | |
| 800x600 @ 60Hz | 1280x720 @ 60Hz | | | |
| 800x600 @ 72Hz | 1280x720 @ 120Hz | | | |
| 800x600 @ 75Hz | 1600x1200 @ 60Hz | | | |
| 832x624 @ 75Hz | XGA/WXGA: | | | |
| 1024x768 @ 60Hz | 1440x900 @ 60Hz | | | |
| 1024x768 @ 70Hz | 1024x768 @ 120Hz | | | |
| 1024x768 @ 75Hz | 1280x800 @ 60Hz | | | |
| 1280x1024 @ 75Hz | 1280x1024 @ 60Hz | | | |
| 1152x870 @ 75Hz | 1680x1050 @ 60Hz | | | |
| | 1280x720 @ 60Hz | | | |
| | 1280x720 @ 120Hz | | | |
| | 1600x1200 @ 60Hz | | | |
| | 1080P and WUXGA: | | | |
| | 1280x720 @ 60Hz | | | |
| | 1280x800 @ 60Hz | | | |
| | 1280x1024 @ 60Hz | | | |
| | 1400x1050 @ 60Hz | | | |
| | 1600x1200 @ 60Hz | | | |
| | 1280x768 @ 60Hz | | | |
| | 1440x900 @ 60Hz | | | |
| | 1280x720 @ 120Hz | | | |
| | 1024x768 @ 120Hz | | | |

ADDITIONAL INFORMATION

True 3D video compatibility

| | | Input timing | | | | |
|-------------------------|--------------------|-------------------------------|----------------------|--------------------|----------------|--|
| | | | | | | |
| Input resolution | HDMI 1.4a 3D Input | 1280x720P @ 50Hz | Top - and - Bottom | | | |
| | | 1280x720P @ 60Hz | Top - and - Bottom | | | |
| | | 1280x720P @ 50Hz | Frame packing | | | |
| | | 1280x720P @ 60Hz | Frame packing | | | |
| | | 1920x1080i @ 50 Hz | Side- by-Side (Half) | | | |
| | | 1920x1080i @ 60 Hz | Side- by-Side (Half) | | | |
| | | 1920x1080P @ 24 Hz | Top - and- Bottom | | | |
| | | 1920x1080P @ 24 Hz | Frame packing | | | |
| | | HDMI 1.3 | 1920x1080i @ 50Hz | Side-by-Side(Half) | SBS mode is on | |
| | | | 1920x1080i @ 60Hz | | | |
| | 1280x720P @ 50Hz | | | | | |
| | 1280x720P @ 60Hz | | | | | |
| | 800x600 @ 60Hz | | | | | |
| | 1024x768 @ 60Hz | | | | | |
| | 1280x800 @ 60Hz | | Top-and-Bottom | TAB mode is on | | |
| | 1920x1080i @ 50Hz | | | | | |
| | 1920x1080i @ 60Hz | | | | | |
| | 1280x720P @ 50Hz | | | | | |
| | 1280x720P @ 60Hz | | | | | |
| | 800x600 @ 60Hz | | | | | |
| 1024x768 @ 60Hz | HQFS | 3D format is Frame sequential | | | | |
| 1280x800 @ 60Hz | | | | | | |
| | 480i | | | | | |

Note:

- If 3D input is 1080p@24hz, the DMD should replay with integral multiple with 3D mode.
- Support NVIDIA 3DTV Play if there is no patent fee from Optoma. 1080i@25hz and 720p@50hz will run in 100 hz; other 3D timing will run in 120hz.
- 1080p@24hz will run in 144Hz.

ADDITIONAL INFORMATION

Image size and projection distance

WUXGA

| Desired Distance (m) | Screen size | | Top | Screen size | | Top |
|----------------------|-----------------|-----------------|--------------------------------|-----------------|-----------------|--------------------------------|
| | (Min zoom) | | | (Max zoom) | | |
| | Diagonal (inch) | W (cm) x H (cm) | From base to top of image (cm) | Diagonal (inch) | W (cm) x H (cm) | From base to top of image (cm) |
| 1.2 | 27.06 | 58 x 36 | 40 | 35 | 76 x 47 | 52 |
| 2 | 45 | 97 x 61 | 67 | 59 | 126 x 79 | 87 |
| 2.5 | 56 | 121 x 76 | 83 | 73 | 158 x 99 | 109 |
| 3 | 68 | 146 x 91 | 100 | 88 | 190 x 118 | 130 |
| 3.5 | 79 | 170 x 106 | 117 | 103 | 221 x 138 | 152 |
| 4 | 90 | 194 x 121 | 134 | 117 | 253 x 158 | 174 |
| 5 | 113 | 243 x 152 | 167 | 147 | 316 x 197 | 217 |
| 6 | 135 | 291 x 182 | 200 | 176 | 379 x 237 | 261 |
| 7 | 158 | 340 x 212 | 234 | 205 | 442 x 276 | 304 |
| 8 | 180 | 389 x 243 | 267 | 235 | 505 x 316 | 347 |
| 9 | 203 | 437 x 273 | 301 | 264 | 569 x 355 | 391 |
| 10.2 | 230 | 495 x 310 | 341 | 299.15 | 644 x 403 | 443 |

Note: Zoom ratio is 1.3x.

| Desired image size | | Distance (m) | | Top (cm) |
|--------------------|-----------------|--------------|----------|---------------------------|
| Diagonal (inch) | W (cm) x H (cm) | Max zoom | Min zoom | From base to top of image |
| 34 | 73 x 46 | 1.2 | 1.5 | 50 |
| 50 | 108 x 67 | 1.7 | 2.2 | 74 |
| 60 | 129 x 81 | 2.0 | 2.7 | 89 |
| 70 | 151 x 94 | 2.4 | 3.1 | 104 |
| 80 | 172 x 108 | 2.7 | 3.5 | 118 |
| 90 | 194 x 121 | 3.1 | 4.0 | 133 |
| 100 | 215 x 135 | 3.4 | 4.4 | 148 |
| 120 | 258 x 162 | 4.1 | 5.3 | 178 |
| 150 | 323 x 202 | 5.1 | 6.7 | 222 |
| 200 | 431 x 269 | 6.8 | 8.9 | 296 |
| 250 | 538 x 337 | 8.5 | 11.1 | 370 |
| 300 | 646 x 404 | 10.2 | 13.3 | 444 |

Note: Zoom ratio is 1.3x.

ADDITIONAL INFORMATION

1080p

| Desired Distance (m) | Screen size | | Top | Screen size | | Top |
|----------------------|-----------------|-----------------|--------------------------------|-----------------|-----------------|--------------------------------|
| | (Min zoom) | | | (Max zoom) | | |
| | Diagonal (inch) | W (cm) x H (cm) | From base to top of image (cm) | Diagonal (inch) | W (cm) x H (cm) | From base to top of image (cm) |
| 1.2 | 26.33 | 58 x 33 | 38 | 34 | 76 x 43 | 49 |
| 2 | 44 | 97 x 55 | 63 | 57 | 126 x 71 | 82 |
| 2.5 | 55 | 121 x 68 | 79 | 71 | 158 x 89 | 103 |
| 3 | 66 | 146 x 82 | 95 | 86 | 190 x 107 | 124 |
| 3.5 | 77 | 170 x 96 | 111 | 100 | 221 x 124 | 144 |
| 4 | 88 | 194 x 109 | 127 | 114 | 253 x 142 | 165 |
| 5 | 110 | 243 x 137 | 158 | 143 | 316 x 178 | 206 |
| 6 | 132 | 291 x 164 | 190 | 171 | 379 x 213 | 247 |
| 7 | 154 | 340 x 191 | 222 | 200 | 442 x 249 | 289 |
| 8 | 176 | 389 x 219 | 254 | 228 | 505 x 284 | 330 |
| 9 | 197 | 437 x 246 | 285 | 257 | 569 x 320 | 371 |
| 10.5 | 230 | 510 x 287 | 333 | 299.62 | 663 x 373 | 433 |

Note: Zoom ratio is 1.3x.

| Desired image size | | Distance (m) | | Top (cm) |
|--------------------|-----------------|--------------|----------|---------------------------|
| Diagonal (inch) | W (cm) x H (cm) | Max zoom | Min zoom | From base to top of image |
| 34 | 75 x 42 | 1.2 | 1.5 | 49 |
| 50 | 111 x 62 | 1.8 | 2.3 | 72 |
| 60 | 133 x 75 | 2.1 | 2.7 | 87 |
| 70 | 155 x 87 | 2.5 | 3.2 | 101 |
| 80 | 177 x 100 | 2.8 | 3.6 | 116 |
| 90 | 199 x 112 | 3.2 | 4.1 | 130 |
| 100 | 221 x 125 | 3.5 | 4.6 | 144 |
| 120 | 266 x 149 | 4.2 | 5.5 | 173 |
| 150 | 332 x 187 | 5.3 | 6.8 | 217 |
| 200 | 443 x 249 | 7.0 | 9.1 | 289 |
| 250 | 553 x 311 | 8.8 | 11.4 | 361 |
| 300 | 664 x 374 | 10.5 | 13.7 | 433 |

Note: Zoom ratio is 1.3x.

ADDITIONAL INFORMATION

SVGA

| Diagonal length (inch) Size of (16:9) Screen | Screen Size W x H | | | | Projection Distance (D) | | | | Offset (Hd) | |
|---|-------------------|--------|--------|--------|-------------------------|------|--------|-------|-------------|--------|
| | (m) | | (inch) | | (m) | | (feet) | | (m) | (inch) |
| | Width | Height | Width | Height | Wide | Tele | Wide | Tele | | |
| 36 | 0.73 | 0.55 | 28.80 | 21.6 | 1.4 | 1.6 | 4.59 | 5.25 | 0.08 | 3.15 |
| 40 | 0.81 | 0.61 | 32.00 | 24 | 1.6 | 1.8 | 5.25 | 5.91 | 0.09 | 3.54 |
| 50 | 1.02 | 0.76 | 40.00 | 30 | 2.0 | 2.2 | 6.56 | 7.22 | 0.12 | 4.72 |
| 60 | 1.22 | 0.91 | 48.00 | 36 | 2.4 | 2.6 | 7.87 | 8.53 | 0.14 | 5.51 |
| 70 | 1.42 | 1.07 | 56.00 | 42 | 2.8 | 3.1 | 9.19 | 10.17 | 0.16 | 6.30 |
| 80 | 1.63 | 1.22 | 64.00 | 48 | 3.2 | 3.5 | 10.50 | 11.48 | 0.18 | 7.09 |
| 90 | 1.83 | 1.37 | 72.00 | 54 | 3.5 | 4.0 | 11.48 | 13.12 | 0.21 | 8.27 |
| 100 | 2.03 | 1.52 | 80.00 | 60 | 3.9 | 4.4 | 12.80 | 14.44 | 0.23 | 9.06 |
| 120 | 2.44 | 1.83 | 96.00 | 72 | 4.7 | 5.3 | 15.42 | 17.39 | 0.27 | 10.63 |
| 150 | 3.05 | 2.29 | 120.00 | 90 | 5.9 | 6.6 | 19.36 | 21.65 | 0.34 | 13.39 |
| 180 | 3.66 | 2.74 | 144.00 | 108 | 7.1 | 7.9 | 23.29 | 25.92 | 0.41 | 16.14 |
| 200 | 4.06 | 3.05 | 160.00 | 120 | 7.9 | 8.8 | 25.92 | 28.87 | 0.46 | 18.11 |
| 250 | 5.08 | 3.81 | 200.00 | 150 | 9.9 | 11.0 | 32.48 | 36.09 | 0.57 | 22.44 |
| 300 | 6.10 | 4.57 | 240.00 | 180 | 11.8 | 13.2 | 38.71 | 43.31 | 0.69 | 27.17 |

Note:

- Vertical Lens Shift values are always calculated from the Center of Projection Lens. Therefore the distance 5.2 cm (2.05 inch) from the Base to the Center of Projection Lens needs to be added to each Vertical Lens Shift value.
- Zoom ratio is 1.1x.

XGA

| Diagonal length (inch) Size of (16:9) Screen | Screen Size W x H | | | | Projection Distance (D) | | | | Offset (Hd) | |
|---|-------------------|--------|--------|--------|-------------------------|------|--------|-------|-------------|--------|
| | (m) | | (inch) | | (m) | | (feet) | | (m) | (inch) |
| | Width | Height | Width | Height | Wide | Tele | Wide | Tele | | |
| 36 | 0.73 | 0.55 | 28.80 | 21.6 | 1.4 | 1.6 | 4.59 | 5.25 | 0.08 | 3.15 |
| 40 | 0.81 | 0.61 | 32.00 | 24 | 1.6 | 1.8 | 5.25 | 5.91 | 0.09 | 3.54 |
| 50 | 1.02 | 0.76 | 40.00 | 30 | 2.0 | 2.2 | 6.56 | 7.22 | 0.12 | 4.72 |
| 60 | 1.22 | 0.91 | 48.00 | 36 | 2.4 | 2.6 | 7.87 | 8.53 | 0.14 | 5.51 |
| 70 | 1.42 | 1.07 | 56.00 | 42 | 2.8 | 3.1 | 9.19 | 10.17 | 0.16 | 6.30 |
| 80 | 1.63 | 1.22 | 64.00 | 48 | 3.2 | 3.5 | 10.50 | 11.48 | 0.18 | 7.09 |
| 90 | 1.83 | 1.37 | 72.00 | 54 | 3.5 | 4.0 | 11.48 | 13.12 | 0.21 | 8.27 |
| 100 | 2.03 | 1.52 | 80.00 | 60 | 3.9 | 4.4 | 12.80 | 14.44 | 0.23 | 9.06 |
| 120 | 2.44 | 1.83 | 96.00 | 72 | 4.7 | 5.3 | 15.42 | 17.39 | 0.27 | 10.63 |
| 150 | 3.05 | 2.29 | 120.00 | 90 | 5.9 | 6.6 | 19.36 | 21.65 | 0.34 | 13.39 |
| 180 | 3.66 | 2.74 | 144.00 | 108 | 7.1 | 7.9 | 23.29 | 25.92 | 0.41 | 16.14 |
| 200 | 4.06 | 3.05 | 160.00 | 120 | 7.9 | 8.8 | 25.92 | 28.87 | 0.46 | 18.11 |
| 250 | 5.08 | 3.81 | 200.00 | 150 | 9.9 | 11.0 | 32.48 | 36.09 | 0.57 | 22.44 |
| 300 | 6.10 | 4.57 | 240.00 | 180 | 11.8 | 13.2 | 38.71 | 43.31 | 0.69 | 27.17 |

Note:

- Vertical Lens Shift values are always calculated from the Center of Projection Lens. Therefore the distance 5.2 cm (2.05 inch) from the Base to the Center of Projection Lens needs to be added to each Vertical Lens Shift value.
- Zoom ratio is 1.1x.

ADDITIONAL INFORMATION

WXGA

| Diagonal length (inch) Size of (16:9) Screen | Screen Size W x H | | | | Projection Distance (D) | | | | Offset (Hd) | |
|---|-------------------|--------|--------|--------|-------------------------|------|--------|-------|-------------|--------|
| | (m) | | (inch) | | (m) | | (feet) | | (m) | (inch) |
| | Width | Height | Width | Height | Wide | Tele | Wide | Tele | | |
| 36 | 0.78 | 0.48 | 30.53 | 19.08 | 1.4 | 1.6 | 4.59 | 5.25 | 0.06 | 2.36 |
| 40 | 0.86 | 0.54 | 33.92 | 21.2 | 1.6 | 1.8 | 5.25 | 5.91 | 0.07 | 2.76 |
| 50 | 1.08 | 0.67 | 42.40 | 26.5 | 2.0 | 2.2 | 6.56 | 7.22 | 0.09 | 3.54 |
| 60 | 1.29 | 0.81 | 50.88 | 31.8 | 2.4 | 2.7 | 7.87 | 8.86 | 0.10 | 3.94 |
| 70 | 1.51 | 0.94 | 59.36 | 37.1 | 2.8 | 3.1 | 9.19 | 10.17 | 0.12 | 4.72 |
| 80 | 1.72 | 1.08 | 67.84 | 42.4 | 3.2 | 3.6 | 10.50 | 11.81 | 0.13 | 5.12 |
| 90 | 1.94 | 1.21 | 76.32 | 47.7 | 3.6 | 4.0 | 11.81 | 13.12 | 0.15 | 5.91 |
| 100 | 2.15 | 1.35 | 84.80 | 53 | 4.0 | 4.5 | 13.12 | 14.76 | 0.16 | 6.30 |
| 120 | 2.58 | 1.62 | 101.76 | 63.6 | 4.8 | 5.4 | 15.75 | 17.72 | 0.20 | 7.87 |
| 150 | 3.23 | 2.02 | 127.20 | 79.5 | 6.0 | 6.7 | 19.69 | 21.98 | 0.25 | 9.84 |
| 180 | 3.88 | 2.42 | 152.64 | 95.4 | 7.2 | 8.0 | 23.62 | 26.25 | 0.30 | 11.81 |
| 200 | 4.31 | 2.69 | 169.60 | 106 | 8.0 | 8.9 | 26.25 | 29.20 | 0.34 | 13.39 |
| 250 | 5.38 | 3.37 | 212.00 | 132.5 | 10.0 | 11.1 | 32.81 | 36.42 | 0.41 | 16.14 |
| 300 | 6.46 | 4.04 | 254.40 | 159 | 12.0 | 13.4 | 39.37 | 43.96 | 0.50 | 19.69 |

Note:

- Vertical Lens Shift values are always calculated from the Center of Projection Lens. Therefore the distance 5.2 cm (2.05 inch) from the Base to the Center of Projection Lens needs to be added to each Vertical Lens Shift value.
- Zoom ratio is 1.1x.

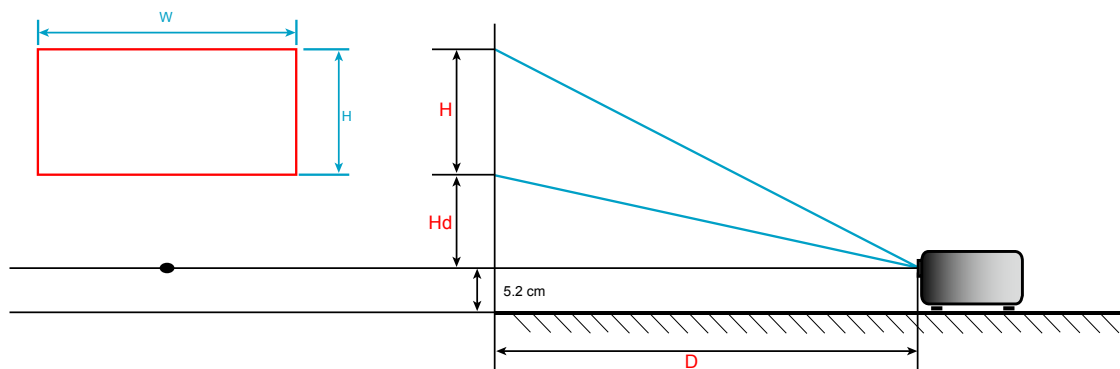

ADDITIONAL INFORMATION

Projector dimensions and ceiling mount installation

1. To prevent damage to your projector, please use the Optoma ceiling mount.
2. If you wish to use a third party ceiling mount kit, please ensure the screws used to attach a mount to the projector meet the following specifications:
 - Screw type: M4*3
 - Minimum screw length: 10mm

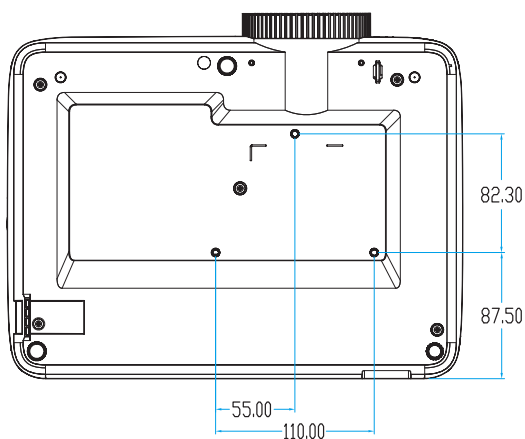
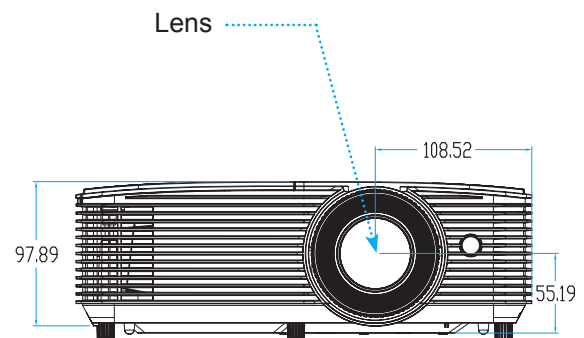
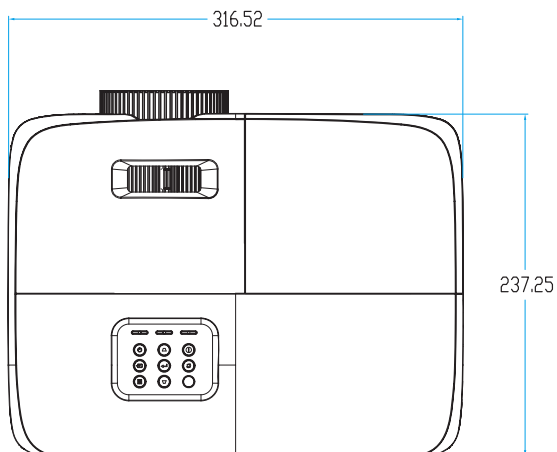

Unit: mm

Note: Please note that damage resulting from incorrect installation will void the warranty.



Warning:

- If you buy a ceiling mount from another company, please be sure to use the correct screw size. Screw size will vary depending on the thickness of the mounting plate.
- Be sure to keep at least 10 cm gap between the ceiling and the bottom of the projector.
- Avoid installing the projector near a heat source.







ADDITIONAL INFORMATION

IR remote control 1 codes



| Key legend | Description | Key code |
|----------------|--|---|
| Power | Press to turn on / off the projector. | 81 |
| Freeze | Press to freeze the projector image. | 8B |
| Aspect | Press to change aspect ratio of a displayed image. | 98 |
| AV mute | Press to turn off/ on projector built-in speaker | 8A |
| Keystone+/up | <ul style="list-style-type: none"> Press to adjust image distortion caused by tilting the projector. Press to navigate up. | C6 |
| Mute | Press to momentarily turn off / on the audio. | 92 |
| Left/Vol- | <ul style="list-style-type: none"> Press to adjust to decrease the volume. Press to navigate left. | C8 |
| Enter | Confirm your item selection. | -C5 (for OSD) -CA (for emulation of USB mouse via USB) |
| Right/Vol+ | <ul style="list-style-type: none"> Press to adjust to increase the volume. Press to navigate right. | C9 |
| Menu | Press to display or exit the on-screen display menus for projector. | 88 |
| Down/Keystone- | <ul style="list-style-type: none"> Press to adjust image distortion caused by tilting the projector. Press to navigate down. | C7 |
| 3D | Press to manually select a 3D mode that matches your 3D content. | 93 |

ADDITIONAL INFORMATION

| Key legend | | Description | Key code |
|-----------------|---|---|----------|
| HDMI |  | Press to choose HDMI source. | 86 |
| VGA |  | Press to choose VGA source. | 8E |
| Video |  | Press to choose video source. | CE |
| Source |  | Press to select an input signal. | C3 |
| Brightness mode |  | Press to automatically adjust the picture brightness to give an optimum contrast performance. | 87 |
| ReSync |  | Automatically synchronize the projector to the input source. | C4 |

ADDITIONAL INFORMATION

IR remote control 2 codes

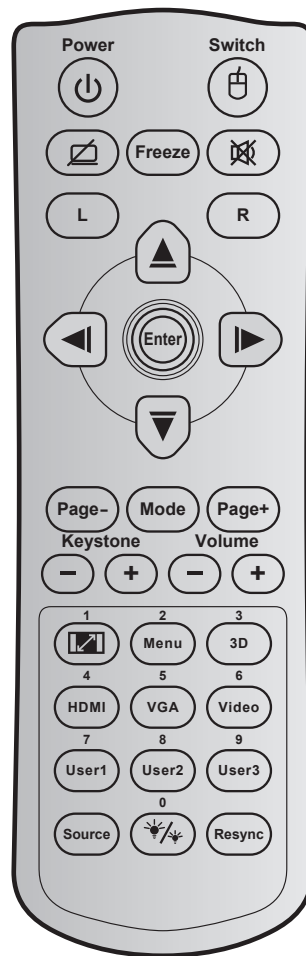

| Key | Key code | Printing-key definition | Description |
|------------------------------|----------|-------------------------|--|
| Power | 81 | Power on/off | Press to turn on / off the projector. |
| Switch | 3E | Switch | Press to switch the USB mouse on / off. |
| Display blank / audio mute | 8A | | Press to hide / unhide the screen picture and turn off / on audio. |
| Freeze | 8B | Freeze | Press to freeze the projector image. |
| Mute | 92 | | Press to momentarily turn off / on the audio. |
| Mouse left click | CB | L | Use as mouse left click. |
| Mouse right click | CC | R | Use as mouse right click. |
| Four directional select keys | C6 | Up arrow | Use ▲ ▼ ◀ ▶ to select items or make adjustments to your selection. |
| | C8 | Left arrow | |
| | C9 | Right arrow | |
| | C7 | Down arrow | |
| Enter | C5 | Enter | Confirm your item selection. |
| | CA | Enter | |
| Page - | C2 | Page- | Press to page down. |

ADDITIONAL INFORMATION

| Key | | Key code | Printing-key definition | Description |
|------------------------------------|--|----------|-------------------------|--|
| Mode | | 95 | Mode | Press to switch Display mode on or off. |
| Page + | | C1 | Page+ | Press to page up. |
| Keystone | | 85 | Keystone+ | Press to adjust image distortion caused by tilting the projector. |
| | | 84 | Keystone- | |
| Volume | | 8C | Volume + | Press to adjust to increase / decrease the volume. |
| | | 8F | Volume - | |
| Aspect ratio / 1 | | 98 | / 1 | <ul style="list-style-type: none"> Press to change aspect ratio of a displayed image. Use as numeric keypad number "1". |
| Menu / 2 | | 88 | Menu/2 | <ul style="list-style-type: none"> Press to display or exit the on-screen display menus for projector. Use as numeric keypad number "2". |
| 3D / 3 | | 93 | 3D/3 | <ul style="list-style-type: none"> Press to manually select a 3D mode that matches your 3D content. Use as numeric keypad number "3". |
| HDMI / 4 | | 86 | HDMI/4 | <ul style="list-style-type: none"> Press to choose HDMI source. Use as numeric keypad number "4". |
| VGA / 5 | | D0 | VGA/5 | <ul style="list-style-type: none"> Press to choose VGA source. Use as numeric keypad number "5". |
| Video / 6 | | D1 | Video/6 | <ul style="list-style-type: none"> Press to choose composite video source. Use as numeric keypad number "6". |
| User1 / 7; User2 / 8; User3 / 9 | | D2 | User 1/7 | <ul style="list-style-type: none"> User defined keys. Please see page 64 to setup. Use as numeric keypad numbers "7", "8", and "9" accordingly. |
| | | D3 | User 2/8 | |
| | | D4 | User 3/9 | |
| Source | | C3 | Source | Press to select an input signal. |
| Brightness mode / 0 | | 96 | / 0 | <ul style="list-style-type: none"> Press to automatically adjust the picture brightness to give an optimum contrast performance. Use as numeric keypad number "0". |
| Re-sync | | C4 | Re-Sync | Press to automatically synchronize the projector to the input source. |





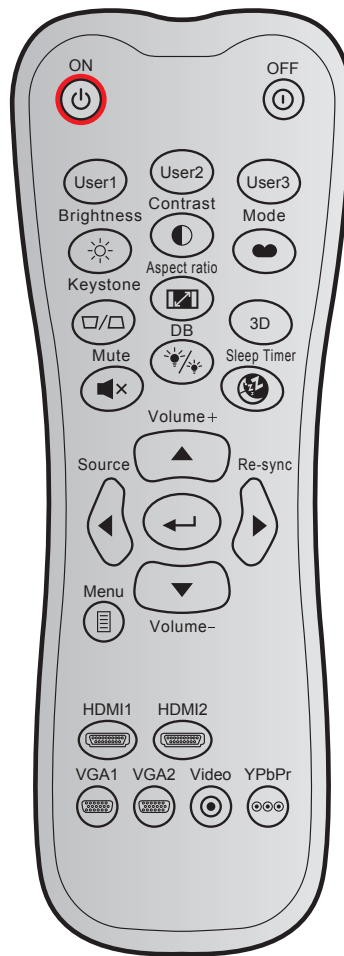









ADDITIONAL INFORMATION

IR remote control 3 codes



| Key | | Custom code | | Data code | Printing-key definition | Description |
|--------------|--|-------------|--------|-----------|-------------------------|--|
| | | Byte 1 | Byte 2 | Byte 3 | | |
| Power on | | 32 | CD | 02 | ON | Press to turn on the projector. |
| Power off | | 32 | CD | 2E | OFF | Press to turn off the projector. |
| User 1 | | 32 | CD | 36 | User1 | User defined keys. Please see page 64 to setup. |
| User 2 | | 32 | CD | 65 | User2 | |
| User 3 | | 32 | CD | 66 | User3 | |
| Brightness | | 32 | CD | 41 | Brightness | Adjust the brightness of the image. |
| Contrast | | 32 | CD | 42 | Contrast | Control the degree of difference between the lightest and darkest parts of the picture. |
| Display mode | | 32 | CD | 05 | Mode | Select a display mode for optimized settings for different applications. Please see page 51. |
| Keystone | | 32 | CD | 07 | Keystone | Adjust image distortion caused by tilting the projector. |
| Aspect ratio | | 32 | CD | 64 | Aspect ratio | Press to change aspect ratio of a displayed image. |

ADDITIONAL INFORMATION

| Key | | Custom code | | Data code | Printing-key definition | Description |
|---------------------|---|-------------|--------|-----------|---|--|
| | | Byte 1 | Byte 2 | Byte 3 | | |
| 3D | | 32 | CD | 89 | 3D | Manually select a 3D mode that matches your 3D content. |
| Volume + |  | 32 | CD | 09 | Volume + | Adjust to increase volume. |
| Four direction keys |  | 32 | CD | 11 | ▲ | Use ▲, ◀, ▶, or ▼ to select items or make adjustments to your selection. |
| | | 32 | CD | 10 | ◀ | |
| | | 32 | CD | 12 | ▶ | |
| | | 32 | CD | 14 | ▼ | |
| Source |  | 32 | CD | 18 | Source | Press “Source” to select an input signal. |
| Enter key |  | 32 | CD | 0F |  | Confirm your item selection. |
| Re-sync |  | 32 | CD | 04 | Re-sync | Automatically synchronizes the projector to the input source. |
| Volume - |  | 32 | CD | 0C | Volume - | Adjust to decrease volume. |
| Menu |  | 32 | CD | 0E | Menu | Display or exit the on-screen display menus for projector. |
| HDMI 1 |  | 32 | CD | 16 | HDMI1 | Press “HDMI1” to choose source from HDMI 1 / MHL connector. |
| HDMI 2 |  | 32 | CD | 30 | HDMI2 | Press “HDMI2” to choose source from HDMI 2 connector. |
| VGA 1 |  | 32 | CD | 1B | VGA1 | No function |
| VGA 2 |  | 32 | CD | 1E | VGA2 | No function |
| Video |  | 32 | CD | 1C | Video | No function |
| YPbPr |  | 32 | CD | 17 | YPbPr | No function |

ADDITIONAL INFORMATION

IR remote control 4 codes

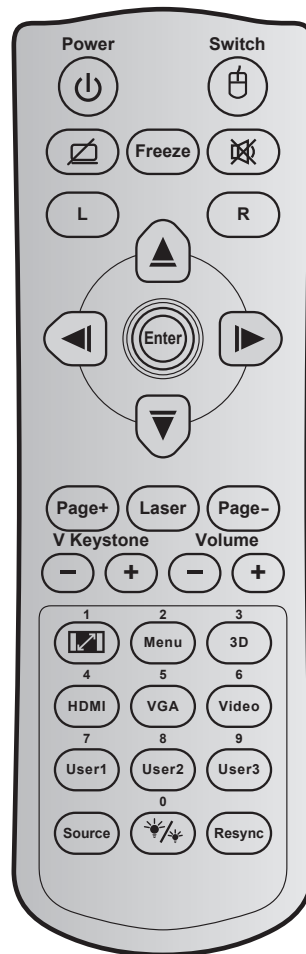

| Key | Key code | Printing-key definition | Description |
|------------------------------|----------|-------------------------|--|
| Power | 81 | Power on/off | Press to turn on / off the projector. |
| Switch | 3E | Switch | Press to switch the USB mouse on / off. |
| Display blank / audio mute | 8A | | Press to hide / unhide the screen picture and turn off / on audio. |
| Freeze | 8B | Freeze | Press to freeze the projector image. |
| Mute | 92 | | Press to momentarily turn off / on the audio. |
| Mouse left click | CB | L | Use as mouse left click. |
| Mouse right click | CC | R | Use as mouse right click. |
| Four directional select keys | C6 | Up arrow | Use ▲ ▼ ◀ ▶ to select items or make adjustments to your selection. |
| | C8 | Left arrow | |
| | C9 | Right arrow | |
| | C7 | Down arrow | |
| Enter | C5 | Enter | Confirm your item selection. |
| | CA | Enter | |
| Page - | C2 | Page- | Press to page down. |







| Key | | Key code | Printing-key definition | Description |
|------------------------------------|--|----------|-------------------------|--|
| Laser | | N/A | Laser | Use as laser pointer. |
| Page + | | C1 | Page+ | Press to page up. |
| V Keystone | | 85 | Keystone+ | Press to adjust image distortion caused by tilting the projector. |
| | | 84 | Keystone- | |
| Volume | | 8C | Volume + | Press to adjust to increase / decrease the volume. |
| | | 8F | Volume - | |
| Aspect ratio / 1 | | 98 | / 1 | <ul style="list-style-type: none"> Press to change aspect ratio of a displayed image. Use as numeric keypad number "1". |
| Menu / 2 | | 88 | Menu/2 | <ul style="list-style-type: none"> Press to display or exit the on-screen display menus for projector. Use as numeric keypad number "2". |
| 3D / 3 | | 93 | 3D/3 | <ul style="list-style-type: none"> Press to manually select a 3D mode that matches your 3D content. Use as numeric keypad number "3". |
| HDMI / 4 | | 86 | HDMI/4 | <ul style="list-style-type: none"> Press to choose HDMI source. Use as numeric keypad number "4". |
| VGA / 5 | | D0 | VGA/5 | <ul style="list-style-type: none"> Press to choose VGA source. Use as numeric keypad number "5". |
| Video / 6 | | D1 | Video/6 | <ul style="list-style-type: none"> Press to choose composite video source. Use as numeric keypad number "6". |
| User1 / 7; User2 / 8; User3 / 9 | | D2 | User 1/7 | <ul style="list-style-type: none"> User defined keys. Please see page 45 to setup. Use as numeric keypad numbers "7", "8", and "9" accordingly. |
| | | D3 | User 2/8 | |
| | | D4 | User 3/9 | |
| Source | | C3 | Source | Press to select an input signal. |
| Brightness mode / 0 | | 96 | / 0 | <ul style="list-style-type: none"> Press to automatically adjust the picture brightness to give an optimum contrast performance. Use as numeric keypad number "0". |
| Re-sync | | C4 | Re-Sync | Press to automatically synchronize the projector to the input source. |

ADDITIONAL INFORMATION

Troubleshooting

If you experience a problem with your projector, please refer to the following information. If a problem persists, please contact your local reseller or service center.

Image problems

-  *No image appears on-screen*
- Ensure all the cables and power connections are correctly and securely connected as described in the "Installation" section.
 - Ensure the pins of connectors are not crooked or broken.
 - Check if the projection lamp has been securely installed. Please refer to the "Replacing the Lamp" section.
 - Ensure that the "AV Mute" feature is not turned on.
-  *Image is out of focus*
- Adjust the Focus Ring on the projector lens.
 - Make sure the projection screen is between the required distance from the projector. (Please refer to pages 79-83).
-  *The image is stretched when displaying 16:9 DVD title*
- When you play anamorphic DVD or 16:9 DVD, the projector will show the best image in 16: 9 format on projector side.
 - If you play the LBX format DVD title, please change the format as LBX in projector OSD.
 - If you play 4:3 format DVD title, please change the format as 4:3 in projector OSD.
 - Please setup the display format as 16:9 (wide) aspect ratio type on your DVD player.
-  *Image is too small or too large*
- Adjust the Zoom Lever on the top of the projector.
 - Move the projector closer to or further from the screen.
 - Press "Menu" on the projector panel, go to "Display > Aspect Ratio". Try the different settings.
-  *Image has slanted sides:*
- If possible, reposition the projector so that it is centered on the screen and below the bottom of the screen.
 - Use "Display > Keystone" from the OSD to make an adjustment.
-  *Image is reversed*
- Select "Setup > Projection" from the OSD and adjust the projection direction.
-  *Blurry double image*
- Press "3D" button and switch to "Off" to avoid normal 2D image is blurry double image.

ADDITIONAL INFORMATION



Two images, side-by-side format

- Press "3D" button and switch to "SBS" for input signal is HDMI 1.3 2D 1080i side-by-side.



Image does not display in 3D

- Check if the battery of 3D glasses is drained.
- Check if the 3D glasses is turned on.
- When the input signal is HDMI 1.3 2D (1080i side-by-side half), press "3D" button and switch to "SBS".

Other problems



The projector stops responding to all controls

- If possible, turn off the projector, then unplug the power cord and wait at least 20 seconds before reconnecting power.



Lamp burns out or makes a popping sound

- When the lamp reaches its end of life, it will burn out and may make a loud popping sound. If this happens, the projector will not turn on until the lamp module has been replaced. To replace the lamp, follow the procedures in the "Replacing the Lamp" section on pages 74-75.

Remote control problems



If the remote control does not work

- Check the operating angle of the remote control is pointed within $\pm 15^\circ$ to the IR receiver on the projector.
- Make sure there are not any obstructions between the remote control and the projector. Move to within 6 m (20 ft) of the projector.
- Make sure batteries are inserted correctly.
- Replace batteries if they are exhausted.

ADDITIONAL INFORMATION





Warning indicators

When the warning indicators (see below) light up or flash, the projector will automatically shutdown:

- "LAMP" LED indicator is lit red and if "On/Standby" indicator flashes red.
- "TEMP" LED indicator is lit red and if "On/Standby" indicator flashes red. This indicates the projector has overheated. Under normal conditions, the project can be switched back on.
- "TEMP" LED indicator flashes red and if "On/Standby" indicator flashes red.

Unplug the power cord from the projector, wait for 30 seconds and try again. If the warning indicator light up or flash, please contact your nearest service center for assistance.

LED lightning messages

| Message |  Power LED |  Power LED |  Temp-LED |  Lamp-LED |
|----------------------------------|---|--|--|--|
| | (Red) | (Green or Blue) | (Red) | (Red) |
| Standby state (Input power cord) | Steady light | | | |
| Power on (Warming) | | Flashing (0.5 sec off / 0.5 sec on) | | |
| Power on & Lamp lighting | | Steady light | | |
| Power off (Cooling) | | Flashing (0.5 sec off / 0.5 sec light). Back to red steady light when cooling fan turns off. | | |
| Quick Resume (100 secs) | | Flashing (0.25 sec off / 0.25 sec on) | | |
| Error (Lamp fail) | Flashing | | | Steady light |
| Error (Fan failure) | Flashing | | Flashing | |
| Error (Over Temp) | Flashing | | Steady light | |

- Power off:

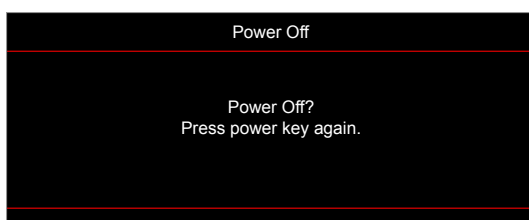

- Lamp warning:

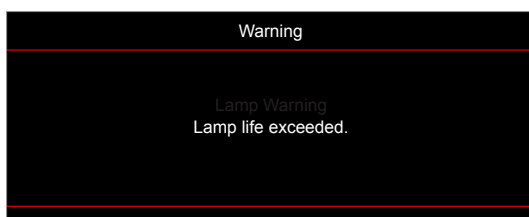

ADDITIONAL INFORMATION

- Temperature warning:

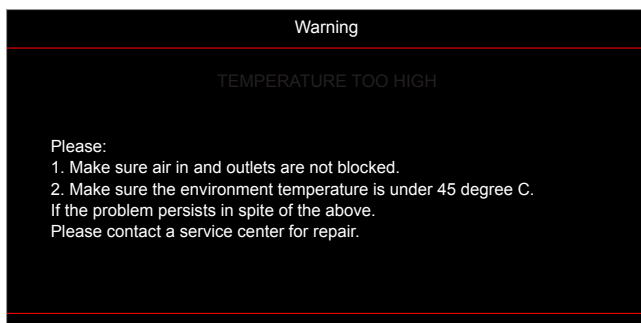

- Fan failed:

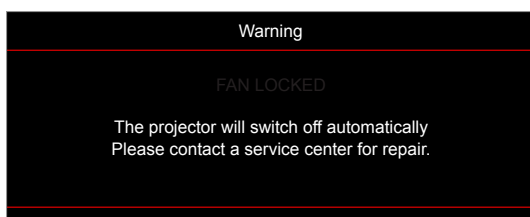

- Out of display range:

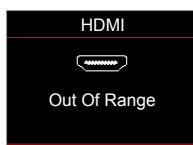

- Power down warning:

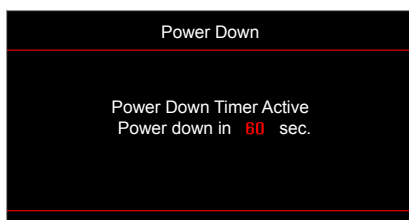

- Security timer alarm:



ADDITIONAL INFORMATION

Specifications

| Optical | Description |
|-----------------------|--|
| Native resolution | 1080P / WUXGA / SVGA / XGA / WXGA |
| Lens | Manual zoom and manual focus |
| Image size (diagonal) | 1080P: - 26"~299" WUXGA: - 27"~299" SVGA / XGA / WXGA: - 27.78"~304.4" |
| Projection distance | 1080P / WUXGA: - 1m ~ 10m (focus range) SVGA / XGA / WXGA: - 1m ~ 12m (focus range) |

| Electrical | Description |
|--------------------|---|
| Color reproduction | 1073.4 Million color |
| Scan rate | - Horizontal scan rate: 15.375~91.146 KHz - Vertical scan rate: 50~ 85 Hz (120Hz for 3D feature projector) |
| Built-in speaker | Yes, 10W |
| USB power out | - WUXGA_1080P: 5V ~ 1.5A - SVGA_XGA_WXGA: 5V ~ 1A |
| Power requirement | 100 - 240V AC 50/60Hz |
| Input current | 2.8-1.0 A |

| Mechanical | Description |
|--------------------------|--|
| Installation orientation | Front, Rear, Ceiling - Top, Rear - Top |
| Dimensions | - 316 mm (W) x 243.5 mm (D) x 98 mm (H) (without feet) - 316 mm (W) x 243.5 mm (D) x 108.5 mm (H) (with feet) |
| Weight | 2.9 kg |
| Environmental conditions | Operating in 5 ~ 40°C , 10% to 85% humidity (non-condensing) |

Note: All specifications are subject to change without notice.



ADDITIONAL INFORMATION

Optoma global offices

For service or support, please contact your local office.



USA

3178 Laurelview Ct.
Fremont, CA 94538, USA
www.optomausa.com

 888-289-6786
 510-897-8601
 services@optoma.com



Canada

3178 Laurelview Ct.
Fremont, CA 94538, USA
www.optomausa.com

 888-289-6786
 510-897-8601
 services@optoma.com



Latin America

3178 Laurelview Ct.
Fremont, CA 94538, USA
www.optomausa.com

 888-289-6786
 510-897-8601
 services@optoma.com



Europe

Unit 1, Network 41, Bourne End Mills
Hemel Hempstead, Herts,
HP1 2UJ, United Kingdom
www.optoma.eu
Service Tel : +44 (0)1923 691865

 +44 (0) 1923 691 800
 +44 (0) 1923 691 888
 service@tsc-europe.com



Benelux BV

Randstad 22-123
1316 BW Almere
The Netherlands
www.optoma.nl

 +31 (0) 36 820 0252
 +31 (0) 36 548 9052



France

Bâtiment E
81-83 avenue Edouard Vaillant
92100 Boulogne Billancourt, France

 +33 1 41 46 12 20
 +33 1 41 46 94 35
 savoptoma@optoma.fr



Spain

C/ José Hierro,36 Of. 1C
28522 Rivas VaciaMadrid,
Spain

 +34 91 499 06 06
 +34 91 670 08 32



Deutschland

Wiesenstrasse 21 W
D40549 Düsseldorf,
Germany

 +49 (0) 211 506 6670
 +49 (0) 211 506 66799
 info@optoma.de

Scandinavia



Lerpeveien 25
3040 Drammen
Norway

 +47 32 98 89 90
 +47 32 98 89 99
 info@optoma.no

PO.BOX 9515
3038 Drammen
Norway

Korea

WOOMI TECH.CO.,LTD.
4F, Minu Bldg.33-14, Kangnam-Ku,
Seoul,135-815, KOREA
korea.optoma.com

 +82+2+34430004
 +82+2+34430005

Japan

東京都足立区綾瀬3-25-18
株式会社オーエス
コンタクトセンター:0120-380-495

 info@os-worldwide.com
www.os-worldwide.com



Taiwan

12F., No.213, Sec. 3, Beixin Rd.,
Xindian Dist., New Taipei City 231,
Taiwan, R.O.C.
www.optoma.com.tw

 +886-2-8911-8600
 +886-2-8911-6550
 services@optoma.com.tw
asia.optoma.com



Hong Kong

Unit A, 27/F Dragon Centre,
79 Wing Hong Street,
Cheung Sha Wan,
Kowloon, Hong Kong

 +852-2396-8968
 +852-2370-1222
www.optoma.com.hk

China

5F, No. 1205, Kaixuan Rd.,
Changning District
Shanghai, 200052, China

 +86-21-62947376
 +86-21-62947375
www.optoma.com.cn



P/N:36.7AZ01G002-A