

Table of Contents

Table of Contents1

Usage Notice2

Safety Information	2
Precautions	3
Eye Safety Warnings	5
Product Features	5

Introduction6

Package Overview	6
Product Overview	7
Main Unit.....	7
Control Panel	8
Connection Ports	9
Remote Control.....	10

Installation11

Connecting the Projector.....	11
Install the Projector Lens	11
Connect to Computer/Notebook	12
Connect to Video Sources	13
Powering On/Off the Projector	14
Powering On the Projector.....	14
Powering Off the Projector.....	15
Warning Indicator.....	16
Adjusting the Projected Image	17
Adjusting the Projector's Height.....	17
Adjusting the Projector's Position	18

User Controls21



Control Panel & Remote Control	21
Control Panel.....	21
Remote Control.....	23
Remote Code Setting	25
Cable Connection for Wired Control.....	26
On-screen Display Menus	27
How to operate	27
Menu Tree	28
IMAGE	30
IMAGE Advanced	32
DISPLAY	34
DISPLAY Geometry *	37
DISPLAY PIP	39

DISPLAY 3D	40
SETUP	41
SETUP Lens Function	43
SETUP Security	44
SETUP Signal (RGB).....	45
SETUP Signal (Video)	46
SETUP Audio Settings.....	47
SETUP Advanced	48
SETUP Network.....	49
SETUP Image Blending *	54
OPTIONS.....	55
OPTIONS Lamp Settings.....	57
OPTIONS Remote Settings	58
OPTIONS Advanced.....	59
Network Application System Introduction *	60
How to use Web Control	60
How to use the Card Reader	67
How to use the Optoma Presenter	70

Appendices.....74

Troubleshooting	74
Image Problems.....	74
Replacing the Lamp	78
Replacing the AFCM	80
Replacing the Geo Module.....	82
Compatibility Modes	83
Remote Key Code.....	85
RS232 Commands and Protocol Function List.....	86
RS232 Pin Assignments	86
RS232 Protocol Function List	87
Ceiling Mount Installation	91
Optoma Global Offices	92
Regulation & Safety Notices.....	94
FCC Notice	94
Declaration of Conformity for EU countries	95

Safety Information

	The lightning flash with arrow head within an equilateral triangle is intended to alert the user to the presence of uninsulated "dangerous voltage" within the product's enclosure that may be of sufficient magnitude to constitute a risk of electric shock to persons.
	The exclamation point within an equilateral triangle is intended to alert the user to the presence of important operating and maintenance (servicing) instructions in the literature accompanying the appliance.

WARNING: TO REDUCE THE RISK OF FIRE OR ELECTRIC SHOCK, DO NOT EXPOSE THIS APPLIANCE TO RAIN OR MOISTURE. DANGEROUS HIGH VOLTAGES ARE PRESENT INSIDE THE ENCLOSURE. DO NOT OPEN THE CABINET. REFER SERVICING TO QUALIFIED PERSONNEL ONLY.

Class A emissions limits

This Class A digital apparatus meets all requirements of the Canadian Interference-Causing Equipment Regulations.

Important Safety Instruction

1. Do not block any ventilation openings. To ensure reliable operation of the projector and to protect from over heating, it is recommended to install the projector in a location that does not block ventilation. As an example, do not place the projector on a crowded coffee table, sofa, bed, etc. Do not put the projector in an enclosure such as a book case or a cabinet that restricts air flow.
2. Do not use the projector near water or moisture. To reduce the risk of fire and/or electric shock, do not expose the projector to rain or moisture.
3. Do not install near heat sources such as radiators, heaters, stoves or any other apparatus such as amplifiers that emits heat.
4. Clean only with dry cloth.
5. Only use attachments/accessories specified by the manufacturer.
6. Do not use the unit if it has been physically damaged or abused. Physical damage/abuse would be (but not limited to):
 - Unit has been dropped.
 - Power supply cord or plug has been damaged.
 - Liquid has been spilled on to the projector.
 - Projector has been exposed to rain or moisture.
 - Something has fallen in the projector or something is loose inside.Do not attempt to service the unit yourself. Opening or removing covers may expose you to dangerous voltages or other hazards. Please call Optoma before you send the unit for repair.
7. Do not let objects or liquids enter the projector. They may touch dangerous voltage points and short out parts that could result in fire or electric shock.
8. See projector enclosure for safety related markings.
9. The unit should only be repaired by appropriate service personnel.

Precautions



Please follow all warnings, precautions and maintenance as recommended in this user's guide.

- ■ Warning- Do not look into the projector's lens when the lamp is on. The bright light may hurt your eyes.
- ■ Warning- To reduce the risk of fire or electric shock, do not expose this projector to rain or moisture.
- ■ Warning- Please do not open or disassemble the projector as this may cause electric shock.
- ■ Warning- When replacing the lamp, please allow the unit to cool down. Follow instructions as described on pages 78-79.
- ■ Warning- This projector will detect the life of the lamp itself. Please be sure to change the lamp when it shows warning messages.
- ■ Warning- Reset the "Lamp Reset" function from the on-screen display "OPTIONS | Lamp Settings" menu after replacing the lamp module (refer to page 57).
- ■ Warning- When switching the projector off, please ensure the cooling cycle has been completed before disconnecting power. Allow 60 seconds for the projector to cool down.
- ■ Warning- Do not use lens cap when projector is in operation.
- ■ Warning- When the lamp is approaching the end of its lifetime, the message "Lamp Warning: Lamp life exceeded." will show on the screen. Please contact your local reseller or service center to change the lamp as soon as possible.
- ■ Warning- Do not look into or point the laser pointer on your remote control into your or someone's eyes. Laser pointer can cause permanent damage to eyesight.
- ■ Warning- Do not transport the projector with any lens installed.

Usage Notice

Do:

- ❖ Turn off and unplug the power plug from the AC outlet before cleaning the product.
- ❖ Use a soft dry cloth with mild detergent to clean the display housing.
- ❖ Disconnect the power plug from AC outlet if the product is not being used for a long period of time.

Do not:

- ❖ Block the slots and openings on the unit provided for ventilation.
- ❖ Use abrasive cleaners, waxes or solvents to clean the unit.
- ❖ Use under the following conditions:
 - In extremely hot, cold or humid environments.
 - ▶ Ensure that the ambient room temperature is within 5°C ~ 40°C
 - ▶ Relative humidity is 10% ~ 85%
 - In areas susceptible to excessive dust and dirt.
 - Near any appliance generating a strong magnetic field.
 - In direct sunlight.

Eye Safety Warnings



- ■ Avoid staring/facing directly into the projector beam at all times. Keep your back to the beam as much as possible.
- ■ When projector is used in a classroom, adequately supervise students when they are asked to point out something on the screen.
- ■ In order to minimize the lamp power, use room blinds to reduce ambient light levels.

Product Features

- ■ XGA (1024 x 768) / WXGA (1280 x 800) Native resolution
- ■ HD compatible – 1080p supported
- ■ Extensive optional lens
- ■ Wide lens shift range for installation flexibility
- ■ Single lamp system
- ■ Comprehensive input/output terminals and control interfaces
- ■ Network support

Introduction

Package Overview

Unpack and inspect the box contents to ensure all parts listed below are in the box. If something is missing, please contact your nearest customer service.

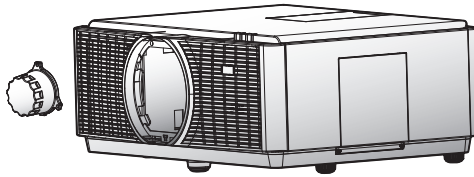

Projector with lens cover

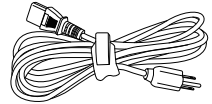

Power Cord 3.0m



- ❖ Due to different applications in each Country, some regions may have different accessories.
- ❖ (*) Optional accessory

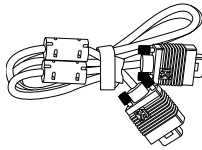

VGA Cable 1.8m



Remote Control



2 x AA Batteries



Remote Control Adapter *

Documentation:

- User's Manual
- Warranty Card
- Quick Start Card
- WEEE Card (for EMEA only)

Product Overview

Main Unit

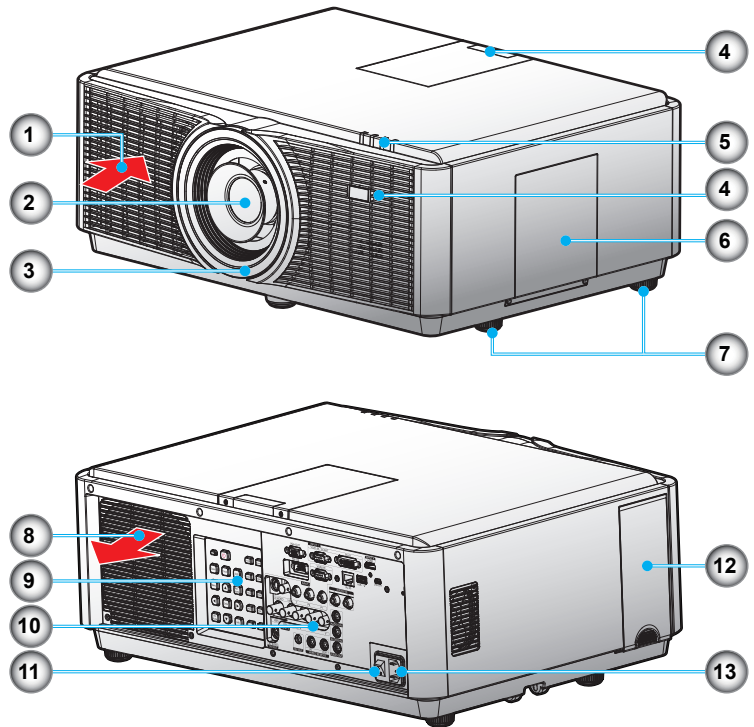

❖ Do not block projector in/out air vents and keep 30cm clearance around vents for air flow concern.

- | | |
|-------------------------|-------------------------------------|
| 1. Ventilation (inlet) | 8. Ventilation (outlet) |
| 2. Projection Lens | 9. Control Panel |
| 3. Lens Ring Cover | 10. Input / Output Connection Ports |
| 4. IR Receivers | 11. Power Switch |
| 5. LED Indicators | 12. AFCM Door |
| 6. Lamp Door | 13. Power Socket |
| 7. Tilt-Adjustment Feet | |

Control Panel

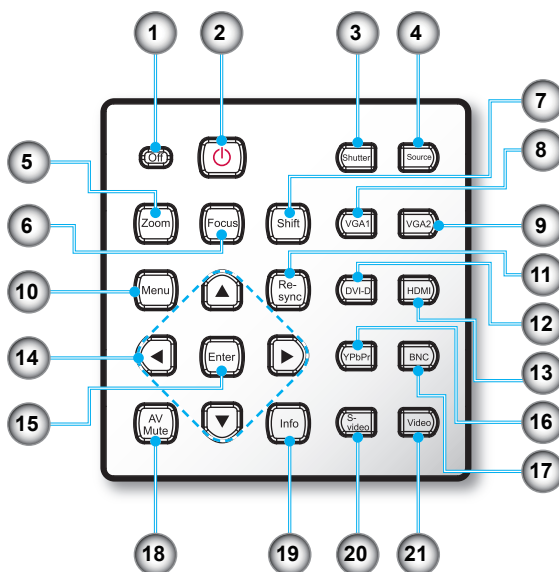

1. Off
2. Power button
3. Shutter
4. Source
5. Zoom
6. Focus
7. Shift
8. VGA 1
9. VGA 2
10. Menu
11. Re-Sync
12. DVI-D
13. HDMI
14. Four Directional Select Keys
15. Enter
16. YPbPr
17. BNC
18. AV Mute
19. Info. (Information)
20. S-Video
21. Video

Connection Ports

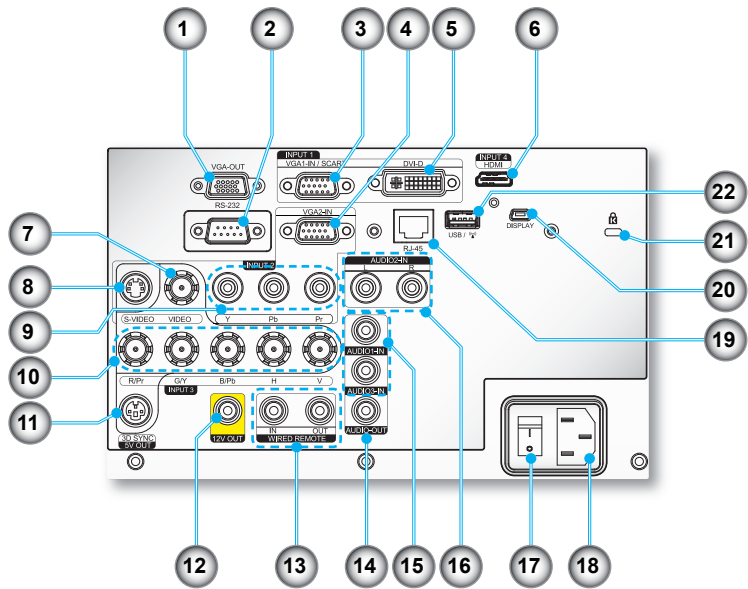

❖ (*) It does not support for basic model.

- | | |
|--|---|
| 1. VGA-Out Connector (Monitor Loop-through Output) | 11. 3D Sync Out (5V) Connector |
| 2. RS-232 Connector (9-pin DIN Type) | 12. 12V Trigger Relay Connector (12V, 250mA. 3.5mm Mini Jack) |
| 3. VGA1-In/SCART Connector (PC Analog Signal/Component Video Input/HDTV/YPbPr) | 13. In/Out Wired Remote Connector (3.5mm jack) |
| 4. VGA2-In Connector (PC Analog Signal/Component Video Input/HDTV/YPbPr) | 14. Audio Output Connector (3.5mm Mini Jack) * |
| 5. DVI-D Connector | 15. Audio Input Connector (3.5mm Mini Jack) * |
| 6. HDMI Connector | 16. Left/Right RCA Audio Input Connector * |
| 7. Composite Video Input Connector | 17. Power Switch |
| 8. S-Video Input Connector | 18. Power Socket |
| 9. Component Video Input Connector (YPbPr) | 19. RJ-45 Networking Connector |
| 10. BNC Input Connector (YPbPr/RGBHV) | 20. Mini USB B Connector (For display over USB purpose) * |
| | 21. Kensington™ Lock Port |
| | 22. USB A Connector / ^(*) (Wireless Dongle) * |

Remote Control

1. Power On
2. Standby
3. Function 1 / Function 2
(Programmable see P.58)
4. Lens Function:
(1) Lens Focus
(2) Lens Zoom
(3) Lens Shift
5. LED Indicator
6. Source
7. Volume +/-
8. Shutter
9. Keystone
10. Display Mode
11. HDMI
12. DVI
13. Re-Sync
14. Information
15. Numbered Keypad
16. YPbPr
17. All
18. Video
19. ID
20. BNC
21. VGA 2
22. VGA 1
23. S-Video
24. Format (Image Aspect Ratio)
25. Menu
26. Four Directional Select Keys
27. Enter
28. Test Pattern
29. AV Mute

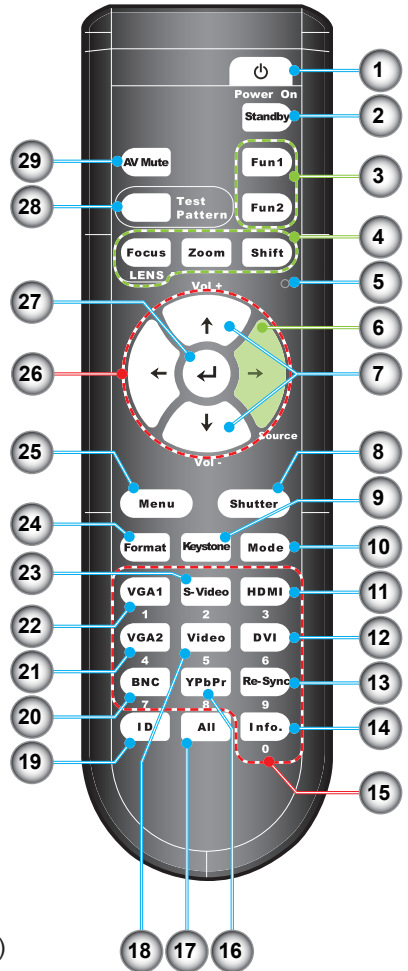

❖ Number keypad
(for password
input exclude "0",
"0" can not use
as part of the
password)

Connecting the Projector Install the Projector Lens



- ❖ Before installing or replacing the lens, switch off the power of the projector.
- ❖ Avoid using the remote control or projector keypad button to adjust the lens shift or zoom/focus while the lens attachment process is carried out.



Warning: Do not transport the projector with any lens installed.

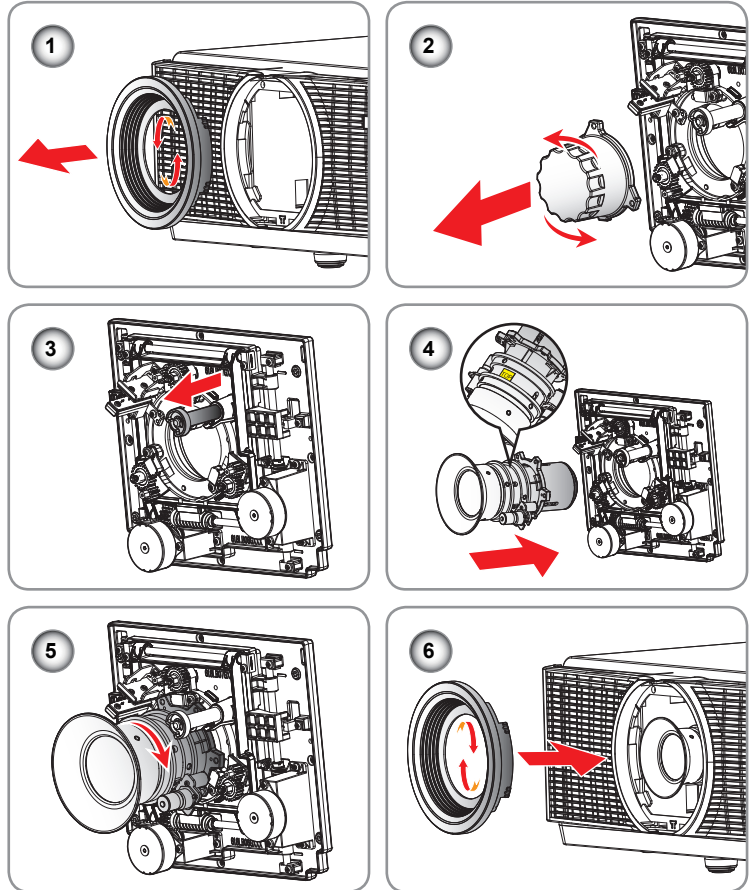

Lens Installing Procedure:

1. Remove the lens ring cover. **1**
2. Remove the lens cap counterclockwise. **2**
3. Pull the bar to release the lock. **3**
4. Be sure the label of lens is upward and then push the lens into the position. **4**
5. Rotate the lens clockwise to lock the lens. **5**
6. Put the lens ring cover back to its place. **6**

Connect to Computer/Notebook

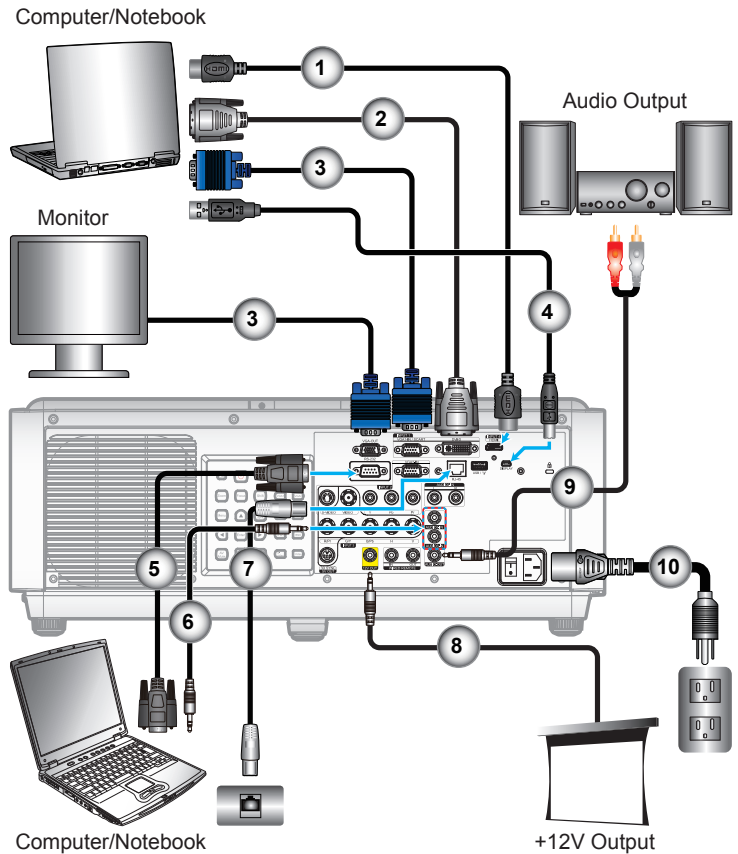

❖ Due to the difference in applications for each country, some regions may have different accessories.

❖ (*) Optional accessory

- | | |
|------------------|---------------------------|
| 1. HDMI Cable * | 6. Audio Cable * |
| 2. DVI-D Cable* | 7. Network Cable * |
| 3. VGA Cable | 8. 12V DC Jack * |
| 4. USB Cable * | 9. Audio Cable Jack/RCA * |
| 5. RS232 Cable * | 10. Power Cord |

Connect to Video Sources

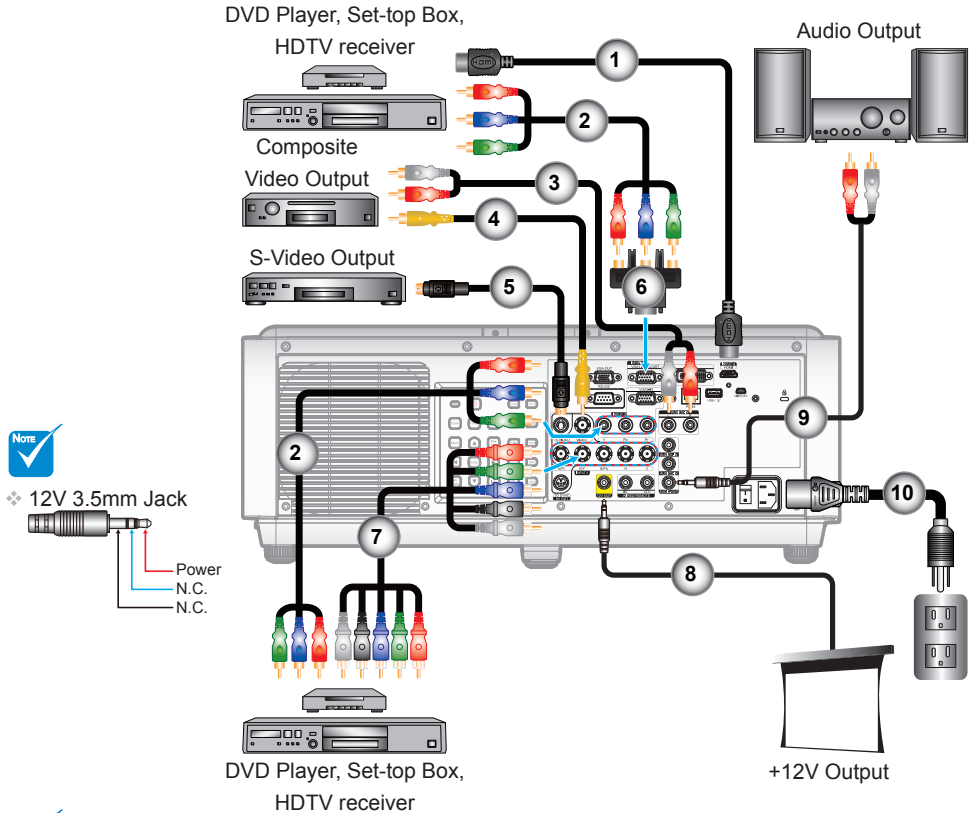

❖ 12V 3.5mm Jack

Power
N.C.
N.C.



❖ Due to the difference in applications for each country, some regions may have different accessories.

❖ (*) Optional accessory

1. HDMI Cable *
2. RCA Component Cable for YPbPr *
3. Audio Cable RCA/RCA *
4. Composite Video Cable *
5. S-Video Cable *
6. 15-Pin to 3 RCA Component/HDTV Adaptor *
7. BNC Cable *
8. 12V 3.5mm Jack *
9. Audio Cable Jack/RCA *
10. Power Cord

Powering On/Off the Projector

Powering On the Projector



❖ When Power mode (Standby) is set to Eco, the VGA and RJ45 will be deactivated when the projector is in standby.

1. Securely connect the power cord. Power on the switch **1** and the Power LED flashes Red.
2. Turn on the lamp by pressing “” button either on the rear of the projector or on the remote control. The Power LED will now turn blue. **2**

The startup screen will display in approximately 10 seconds. The first time you use the projector, you will be asked to select the preferred language and power saving mode.

3. Turn on and connect the source that you want to display on the screen (computer, notebook, video player, etc). The projector will detect the source automatically. If not, push menu button and go to “OPTIONS”.

Make sure that the “Source Lock” has been set to “Off”.

- ❖ If you connect multiple sources at the same time, press the direct source buttons on the control panel or on the remote control to switch between inputs.



❖ Turn on the projector first and then select the signal sources.

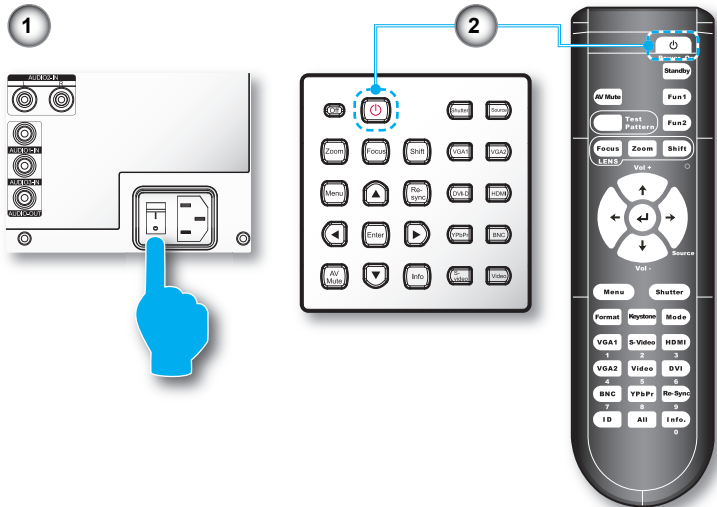

Powering Off the Projector

1. Press the “Standby” button on the remote control or “Off” on the control panel to turn off the projector. **1**

The following message will be displayed on the screen.

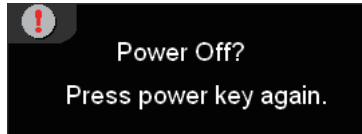

Press the “ Standby ” button on the remote control or “Off” on the control panel again **1** to confirm otherwise the message will disappear after 15 seconds. When you pressing for the second time, the projector will shut down.

2. The cooling fans continue to operate for about 60 seconds for cooling cycle and the POWER LED will flash Blue. When the POWER LED turns red, the projector has entered standby mode. If you wish to turn the projector back on, you must wait until the projector has completed the cooling cycle and has entered standby mode. Once in standby mode, simply press the “⏻” button either on the rear of the projector or on the remote control to restart the projector. **2**
3. Power off the switch. **3**
4. Disconnect the power cord from the electrical outlet and from the projector.
5. Do not turn on the projector immediately following the power off procedure.

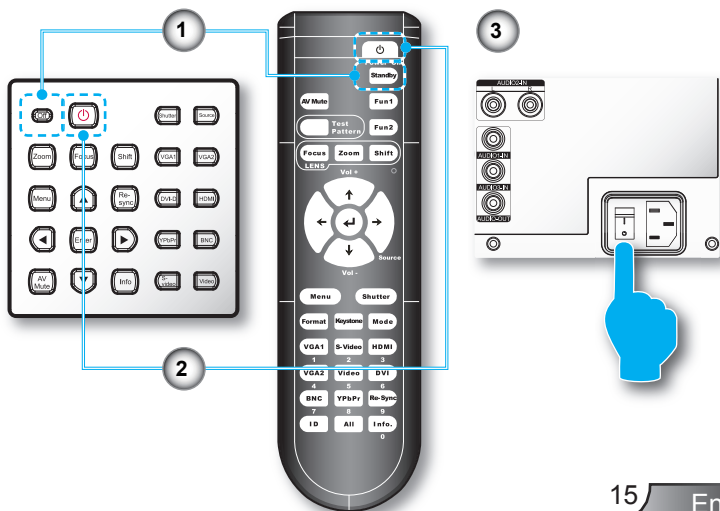



- ❖ Contact the nearest service center if the projector displays these symptoms. See pages 92-93 for more information.

Warning Indicator

When the warning indicators (see below) come on, the projector will automatically shutdown:

- ❖ “LAMP” LED indicator is lit orange and if “POWER” LED indicator flashes red.
- ❖ “TEMP” LED indicator is lit red and if “POWER” LED indicator flashes red. This indicates the projector has overheated. Under normal conditions, the projector can be switched back on.
- ❖ “TEMP” LED indicator flashes red and if “POWER” LED indicator flashes red.

Unplug the power cord from the projector, wait for 30 seconds and try again. If the warning indicator light up again, please contact your nearest service center for assistance.

Adjusting the Projected Image

Adjusting the Projector's Height

The projector is equipped with elevator feet for adjusting the image height.

1. Locate the adjustable foot you wish to modify on the underside of the projector.
2. Rotate the adjustable ring clockwise to raise the projector or counter clockwise to lower it. Repeat with the remaining feet as needed.

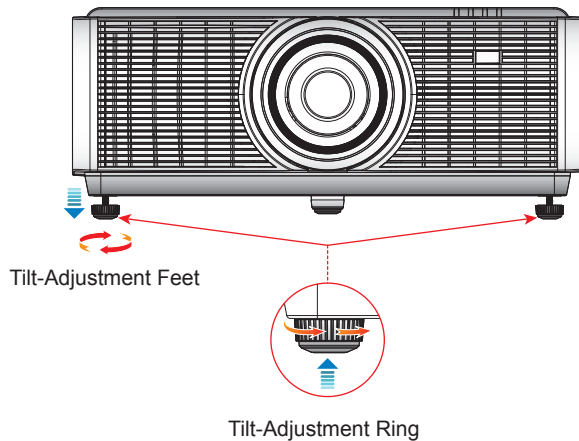

Adjusting the Projector's Position

To determine where to position the projector, consider the size and shape of your screen, the location of your power outlets, and the distance between the projector and the rest of your equipment.

XGA

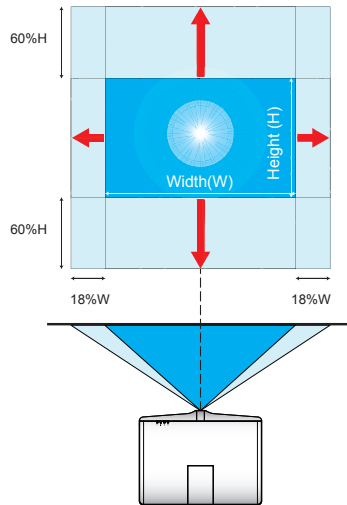

WXGA

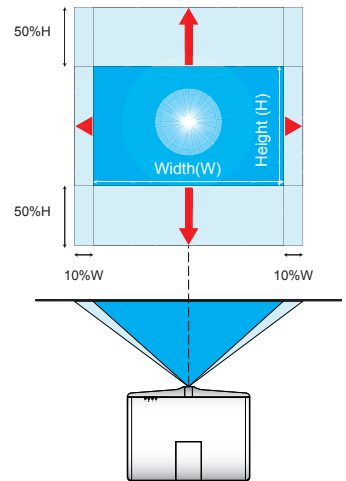

❖ These tables are for user's reference only.

Lens

Optoma Model Name	A02	A01	A03
Focal Length (f) (mm)	18.07	14.05	22.61
F number	2	2.3	2.3
Zoom Range (Ratio)	1.25	1.28	1.9
Zoom & Focus Adjustment	Motorized		
Motorized Lens Shift (XGA)	Horizontal : +/-18%, Vertical : +/-60%		
Motorized Lens Shift (WXGA)	Horizontal : +/-10%, Vertical : +/-50%		

User Controls



❖ Projection distance: From screen to lens.

A02				
Screen size	Projection Distance (mm)			
	XGA		WXGA	
(inch)	Wide	Tele	Wide	Tele
40	1290	1620	1090	1370
50	1620	2030	1370	1720
60	1950	2445	1650	2065
70	2280	2855	1930	2415
80	2610	3270	2210	2765
90	2940	3680	2490	3115
100	3270	4095	2765	3465
150	4920	6155	4165	5215
200	6570	8220	5560	6960
250	8220	10280	6960	8705
300	9870	12345	8360	10450
350	11525	14405	9760	12200
400	13175	16470	11155	13945
450	14825	18530	12555	15695
500	16475	20590	13955	17440

A01				
Screen size	Projection Distance (mm)			
	XGA		WXGA	
(inch)	Wide	Tele	Wide	Tele
40	1000	1290	845	1090
50	1255	1620	1065	1370
60	1515	1950	1258	1650
70	1775	2280	1500	1930
80	2030	2610	1720	2210
90	2285	2940	1940	2490
100	2545	3270	2160	2770
150	3830	4920	3250	4170
200	5120	6570	4345	5570
250	6410	8220	5440	6970
300	7695	9870	6540	8375
350	8985	11520	7625	9770
400	10270	13160	8720	11160
450	11560	14810	9800	12560
500	12845	16460	10890	13960

User Controls

A03				
Screen size	Projection Distance (mm)			
	XGA		WXGA	
(inch)	Wide	Tele	Wide	Tele
40	1590	3090	1340	2610
50	2005	3875	1690	3275
60	2420	4665	2040	3945
70	2830	5450	2390	4610
80	3245	6235	2740	5275
90	3660	7025	3090	5945
100	4070	7810	3440	6610
150	6140	11740	5185	9945
200	8205	15675	6935	13275
250	10270	19605	8685	16610
300	12335	23540	10435	19940
350	14400	27470	12185	23275
400	16470	31405	13935	26610
450	18535	35335	15685	29940
500	20600	39270	17435	33275

Control Panel & Remote Control Control Panel



Using the Control Panel

Off		Turn off the projector.
Power On		Turn on the projector.
Shutter		Open/close the built-in shutter.
Source		Press "SOURCE" to select an input signal.
Zoom		Adjust lens zoom function.
Focus		Adjust lens focus function.
Shift		Adjust Lens shift up/down/left/right.
VGA 1		Press "VGA 1" to choose source from VGA1-IN connector.
VGA 2		Press "VGA 2" to choose source from VGA2-IN connector.
Menu		Press "Menu" to launch the on-screen display (OSD) menu. To exit OSD, Press "Menu" again.

User Controls

Using the Control Panel

Re-Sync	Automatically synchronize the projector to the input source.
DVI-D	Press “DVI-D” to choose source from DVI-D connector.
HDMI	Press “HDMI” to choose source from HDMI connector.
Four Directional Select Keys	Use to ▲▼◀▶ select items or make adjustments to your selection.
Enter	Confirm your item selection.
YPbPr	Press “YPbPr” to choose component video source.
BNC	Press “BNC” to choose source from BNC (YPbPr/RGBHV) connector.
AV Mute	Momentarily turns off/on the audio and video.
Info. (Information)	Display the projector’s information.
S-Video	Press “S-Video” to choose source from S-Video connector.
Video	Press “Video” to choose composite video source.

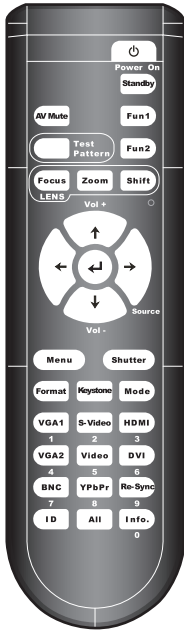

Remote Control

Using the Remote Control

Power On		Turn on the projector.
Standby		Turn off the projector.
Function 1		Adjust Function 1 settings.
Function 2		Adjust Function 2 settings.
Lens Focus		Adjust lens focus function.
Lens Zoom		Adjust lens zoom function.
Lens Shift		Adjust Lens shift up/down/left/right.
LED Indicator		Indicate Lens function status. LED indicator light that is in use.
Source		Press "SOURCE" to select an input signal.
Volume +/-		Adjust to increase / decrease the volume.
Shutter		Open/close the built-in shutter.
Keystone		Adjust image distortion caused by tilting the projector.
Display Mode		Select the display mode from Presentation, Bright, Movie, sRGB, Blackboard, Classroom, DICOM SIM., 3D, ISF Day, ISF Night and User.
HDMI		Press "HDMI" to choose source from HDMI connector.
DVI		Press "DVI" to choose source from DVI-D connector.
Re-Sync		Automatically synchronize the projector to the input source.
Info. (Information)		Display the projector's information.
Numbered Keypad		Press "1~9" to input a password in the "Security" settings.
YPbPr		Press "YPbPr" to choose component video source.

User Controls

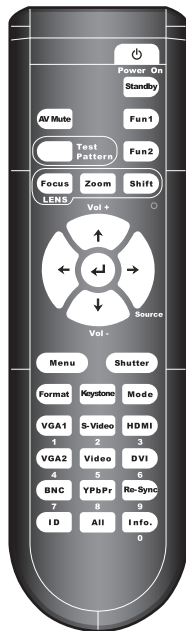

Using the Remote Control

All	Restore the default remote code.
Video	Press "Video" to choose composite video source.
ID	Set the remote code.
BNC	Press "BNC" to choose source from BNC (YPbPr/RGBHV) connector.
VGA 2	Press "VGA 2" to choose source from VGA2-IN connector.
VGA 1	Press "VGA 1" to choose source from VGA1-IN connector.
S-Video	Press "S-Video" to choose source from S-Video connector.
Format	Select the desired aspect ratio.
Menu	Press "Menu" to launch the on-screen display (OSD) menu. To exit OSD, Press "Menu" again.
Four Directional Select Keys	Use to ▲▼◀▶ select items or make adjustments to your selection.
Enter	↵ Confirm your item selection.
Test Pattern	Display a test pattern.
AV Mute	Momentarily turns off/on the audio and video.

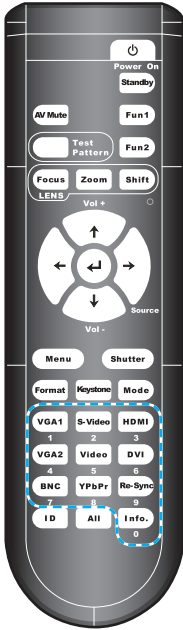

Remote Code Setting

Default code setting (common code): 00

The default code of remote control can be set by pressing "All" key continuously until LED indicator quickly blinking 3 times. (around 3 seconds) Regardless of projector's remote code, the remote control can operate each projector simultaneously if the remote code of remote control is set at default code.

Remote code setting: 01 ~ 99

The remote code of the remote control can be changed by pressing the "ID" continuously until LED indicator slowly blinking (around 3 seconds,) and then pressing double digit numbered buttons (01~99) as the code number. The LED indicator will blink three times quickly as setting success. If the setting process don't be completed in 10 seconds, the process will be time out and keep original remote code.

Sleep mode

Remote control will enter sleep mode as below conditions:

- ❖ No key press
- ❖ Press multi keys simultaneously
- ❖ Press one key over 60 seconds continuously

Backlight

- ❖ Backlight will turn on as pressing any key
- ❖ If backlight turn on 10 seconds continuously and no operated, the backlight will turn off gradually in 5 seconds.

Cable Connection for Wired Control

As remote control connects with projector by cable

- ❖ IR emitter signal will be cut off.
- ❖ No extra setting need.

Projector (I)

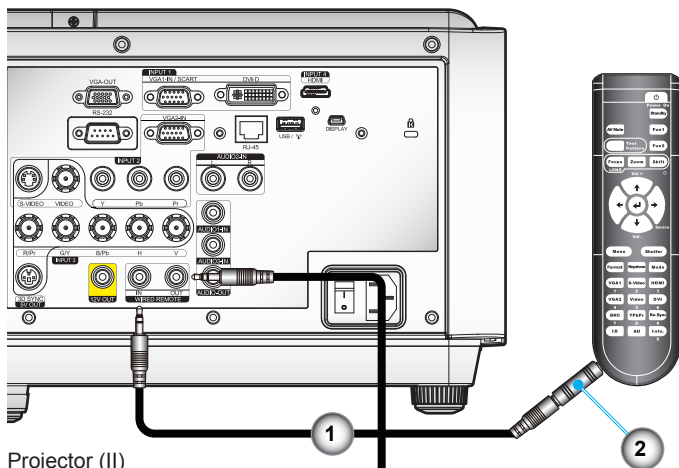

Projector (II)

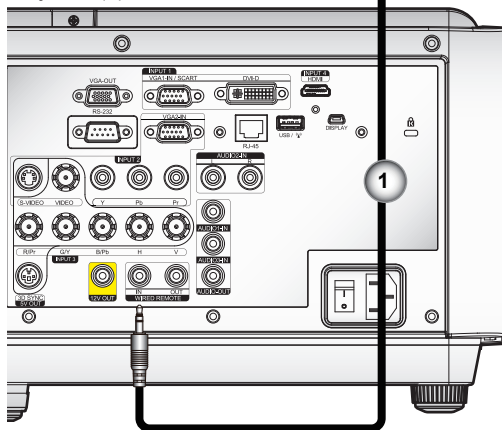

- ❖ (*) Optional accessory
- ❖ Use cable length of 20m or less, if the length of cable exceeds 20m, the remote control may not work normally.

1. Audio Cable Jack/Jack *
2. Remote Control Adapter (3.5mm to 2.5mm Mini Jack) *

On-screen Display Menu

The Projector has multilingual On-screen Display menus that allow you to make image adjustments and change a variety of settings. The projector will automatically detect the source.

How to operate



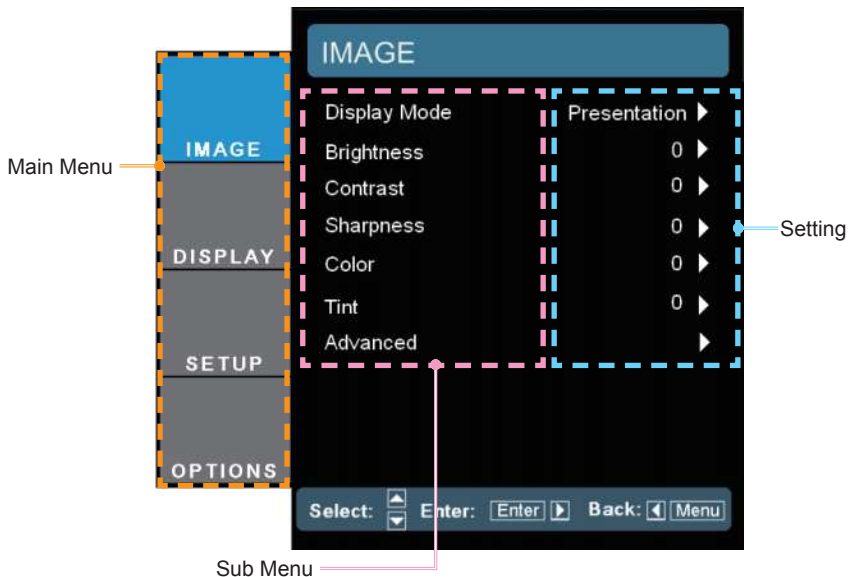

1. To open the OSD menu, press “Menu” on the Remote Control or Control Panel.
2. When OSD is displayed, use ▲▼ keys to select any item in the main menu. While making a selection on a particular page, press ► or “Enter” key to enter sub menu.
3. Use ▲▼ keys to select the desired item in the sub menu and then press ► or “Enter” key to view further settings. Adjust the settings by ◀▶ key.
4. Select the next item to be adjusted in the sub menu and adjust as described above.
5. Press “Enter” to confirm, and the screen will return to the main menu.
6. To exit, press “Menu” again. The OSD menu will close and the projector will automatically save the new settings.



Menu Tree



- ❖ Please note that the on-screen display (OSD) menus vary according to the signal type selected and the projector model you are using.
- ❖ (*) Optional function

Main Menu	Sub Menu	Settings		
IMAGE	Display Mode	Presentation / Bright / Movie / sRGB / Blackboard / Classroom / DICOM SIM. / ISF Day / ISF Night / 3D / User		
	Brightness	-50~50		
	Contrast	-50~50		
	Sharpness	1~15		
	Color	-50~50		
	Tint	-50~50		
	Advanced	Noise Reduction	0~10	
		BrilliantColor™	0~10	
		Gamma	Film / Video / Graphics / Standard	
		DynamicBlack	Off / On	
		TrueVivid	0~5	
		Color Temp.	Warm / Medium / Cold	
		Color Space	Auto / RGB / YUV	
		Color Space (HDMI)	Auto / RGB (0-255) / RGB (16-235) / YUV	
		Color Settings	Red Gain / Green Gain / Blue Gain / Red Bias / Green Bias / Blue Bias / Reset / Yes	
		Input Source	VGA1 / VGA2 / HDMI / DVI / BNC / Component / S-Video / Video / Flash Drive / Network Display / USB Display	
		Exit		
		DISPLAY	Format	(XGA) 4:3 / 16:9-I / 16:9-II / Native / Auto
			Format	(WXGA) 4:3 / 16:9 or 16:10 / LBX / Native / Auto
	Zoom		-20~50	
Edge Mask	0~5			
H Image Shift	-50~50			
V Image Shift	-50~50			
* Geometry	Off			
	Keystone		Horizontal / Vertical / Pin Cushion/Barrel / Rotation	
	4-Corner		 / Digital Shift	
	Curve		Point 1 / Point 2 / Point 3 / Point 4 / Point 5 / Point 6 / Point 7 / Point 8 / Point 9	
PC Mode				
V Keystone			-20~20	
PIP	Screen			
	PIP Location			
	PIP Size	1/16 / 1/25 / 1/36		
	PIP Source			
	Swap			
	Exit			
3D	3D Mode	Off / DLP-Link / VESA 3D		
	3D Sync. Invert	Off / On		
	Exit			
SETUP	Language	English / Deutsch / Français / Italiano / Español / Português / Svenska / Nederlands / Norsk / Dansk / Polski / Suomi / Русский / ελληνική / Magyar / Čeština / العربية / فارسی / 繁體中文 / 简体中文 / 한국어 / ไทย / Türkçe / Tiếng Việt		
	Projection			
	Screen Type	16:10 / 16:9		
	Menu Location			
	Lens Function	Focus		
		Zoom		
		Lens shift	Lock / Unlock	
		Lens Type	A01 / A02 / A03	
		Lens calibration	Yes / No	
		Blending Pattern	Off / Green / Magenta	
Exit				
Security	Security Timer	Month / Day / Hour / Exit		
	Change Password			
	Security	Off / On		
	Exit			

User Controls



❖ (*) Optional function

Main Menu	Sub Menu	Settings	
SETUP	Signal (RGB)	Frequency	0-100
		Phase	-50-50
		H. Position	-50-50
		V. Position	-50-50
		Automatic	Enable / Disable
		Exit	
	Signal (Video)	White Level	-50-50
		Black Level	-50-50
		Saturation	-50-50
		IRE	0 / 7.5
		EXIT	
	Projector ID		
	Audio Settings	Internal Speaker	Off / On
		Mute	Off / On
		Volume	0-10
		Audio Input	Default / Audio 1 / Audio 2 / Audio 3
		Exit	
		Advanced	Logo
	Network	Logo Capture	
		Closed Captioning	CC1 / CC2 / Off
		Exit	
Network State		Month / Day / Hour / Exit	
DHCP			
Image Blending	IP Address	Off / On	
	Subnet mask		
	Gateway		
	DNS		
	Apply	Yes / No	
	Exit		
	Blending	Off / On	
	Crop	Off / On	
	Overlap		
	Bright Adj.	Overlap / Non Overlap / Exit	
Gamma	1.8 / 2 / 2.2		
Exit			
OPTIONS	Source Lock	Off / On	
	High Altitude	Off / On	
	Information Hide	Off / On	
	Keypad Lock	Off / On	
	Test Pattern	None / Grid / White	
	Background Color	Blue / Black / Red / Green / White	
	Lamp Settings	Lamp Hours	
		Lamp Reminder	Off / On
		Brightness Mode	Bright / Eco. / ImageAI
		Lamp Reset	Yes / No
		Exit	
	Remote Settings	Function 1	Brightness / PIP / Projection
		Function 2	Contrast / PIP Source / PIP Swap / Color
		Top IR Sensor	Off / On
		Front IR Sensor	Off / On
		Remote Code	00-99
		Exit	
	12V Trigger	Off / On	
	Advanced	Direct Power On	Off / On
		Signal Power On	Off / On
		Auto Power Off (min.)	0-180
Sleep Timer (min.)		0-995	
Power Mode (Standby)		Active / Eco.	
Baudrate		9600 / 19200 / 38400	
Exit			
VGA Out		Auto / VGA1 / VGA2	
Information			
Reset		Yes / No	

IMAGE

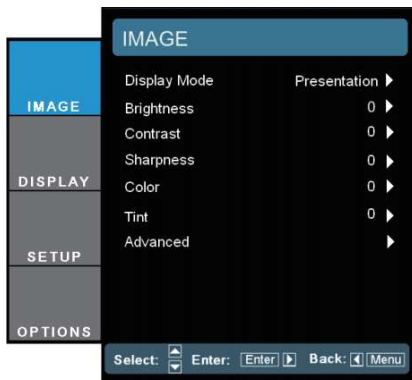

Display Mode

There are many factory presets optimized for various types of images.

- ▶ Presentation: Good color and brightness from PC input.
- ▶ Bright: Maximum brightness from PC input.
- ▶ Movie: For home theater.
- ▶ sRGB: Standardised accurate color.
- ▶ Blackboard: This mode should be selected to achieve optimum color settings when projecting onto a blackboard (green).
- ▶ Classroom: This mode is recommended for projecting in a classroom.
- ▶ DICOM SIM.: This display mode simulates the greyscale/gamma performance of equipment used for "Digital Imaging and Communications in Medicine" (DICOM).

IMPORTANT: This mode should NEVER be used for medical diagnosis, it is for education/training purposes only.

- ▶ 3D: Recommended setting for 3D mode enabled. Any further adjustments by the user in 3D will be saved in this mode for further use.
- ▶ User: User's settings.

Brightness

Adjust the brightness of the image.

- ▶ Press the ◀ to darken image.
- ▶ Press the ▶ to lighten the image.



- ❖ 3D mode only supports below 3D sources.
Input source timing-120Hz frame sequential:
 1. 1280x720
120Hz
 2. 1024x768
120Hz
 3. 800x600
120Hz



❖ “Color” and “Tint” are only supported for composite and component sources.

Contrast

The contrast controls the degree of difference between the lightest and darkest parts of the picture.

- ▶ Press the ◀ to decrease the contrast.
- ▶ Press the ▶ to increase the contrast.

Sharpness

Adjust the sharpness of the image.

- ▶ Press the ◀ to decrease the sharpness.
- ▶ Press the ▶ to increase the sharpness.

Color

Adjust a video image from black and white to fully saturated color.

- ▶ Press the ◀ to decrease the color saturation in the image.
- ▶ Press the ▶ to increase the color saturation in the image.

Tint

Adjust the color balance of red and green.

- ▶ Press the ◀ to increase the amount of green in the image.
- ▶ Press the ▶ to increase the amount of red in the image.

IMAGE | Advanced



Noise Reduction

The motion Adaptive Noise Reduction reduces the amount of visible noise interlaced signals. The range is from “0” to “10”. (0: Off)

BrilliantColor™

This adjustable item utilizes a new color-processing algorithm and system level enhancements to enable higher brightness while providing true, more vibrant colors in picture. The range is from “0” to “10”. If you prefer a stronger enhanced image, adjust toward the maximum setting. For a smoother, more natural image, adjust toward the minimum setting.

Gamma

This allows you to choose a gamma table that has been fine-tuned to bring out the best image quality for the input.

- ▶ Film: for home theater.
- ▶ Video: for video or TV source.
- ▶ Graphics: for image source.
- ▶ Standard: for standardized setting.

DynamicBlack

DynamicBlack enables the projector to automatically optimize the display of dark movie scenes enabling them to be shown in incredible detail.

True Vivid

This adjustable item utilizes a new color-processing algorithm and enhancements to enable the picture’s vividness to be significantly increased.

Color Temp.

If set to cold temperature, the image looks more blueish (cold image). If set to warm temperature, the image looks more reddish (warm image).



❖ “DynamicBlack” is only available when “3D Mode” is “Off.”



- ❖ “RGB(0-255)” and “RGB(16-235)” are only supported for HDMI source.

Color Space

Select an appropriate color matrix type from AUTO, RGB, RGB(0-255), RGB(16-235) or YUV.

Color Settings

Press **←** into the next menu and then use **▲** or **▼** to select item.

- ▶ Red Gain/Green Gain/Blue Gain/Red Bias/Green Bias/Blue Bias: Use **◀** or **▶** to Red, Green, or Blue for brightness (Gain) and contrast (Bias).
- ▶ Reset: Choose “Yes” to return the factory default settings for color adjustments.



Input Source

Use this option to enable / disable input sources. Press **←** to enter the sub menu and select which sources you require. Press “Enter” to finalize the selection. The projector will not search for inputs that are not selected.

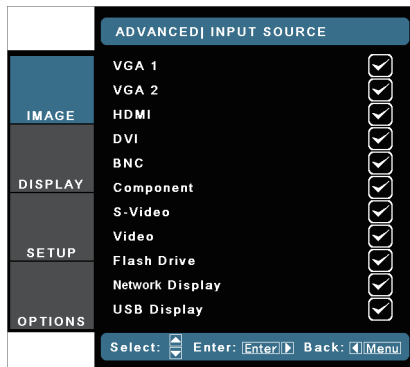

DISPLAY

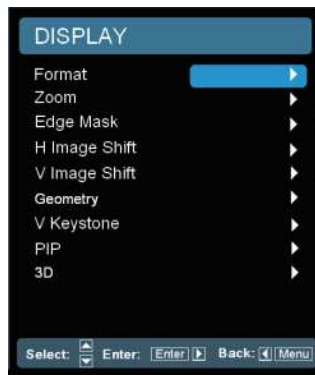

Format

Use this function to choose your desired aspect ratio.

XGA

- ▶ 4:3: This format is for 4x3 input sources.
- ▶ 16:9-I: This format is for 16x9 input sources, like HDTV and DVD enhanced for Wide screen TV. (576i/p)
- ▶ 16:9-II: This format is for 16x9 input sources, like HDTV and DVD enhanced for Wide screen TV. (480i/p)
- ▶ Native: This format displays the original image without any scaling.
- ▶ AUTO: Automatically selects the appropriate display format. When input is 4:3, the image is displayed as 4:3. When input is 16:9 above, the image is displayed as 16:9-I.

Source	480i/p	576i/p	1080i/p	720p	PC
4:3	1024 x 768 center				
16:9-I	1024 x 576 center				
16:9-II	854 x 480 center				
Native	No resize image, 1:1 mapping and centered. This format shows the original image without scaling.				
Auto	With PC input (VGA/ HDMI), the Aspect Ratio displayed as default will depend on the source input. When input is 4:3, the image is displayed as 4:3 When input is 16:9 above, the image is displayed as 16:9-I.				

WXGA

- ▶ 4:3: This format is for 4x3 input sources.
- ▶ 16:9: This format is for 16x9 input sources, like HDTV and DVD enhanced for Wide screen TV.
- ▶ 16:10: This format is for 16x10 input sources, like wide screen laptop.
- ▶ LBX: This format is for non-16x9, letterbox source and for users who use external 16x9 lens to display 2.35:1 aspect ratio using full resolution.
- ▶ Native: This format displays the original image without any scaling.
- ▶ AUTO: Automatically selects the appropriate display format.

16:10 Screen	480i/p	576i/p	1080i/p	720p	PC
4:3	1066 x 800 center				
16:10	1280 x 800 center				
LBX	1280 x 960 center, then get the central 1280 x 800 image to display.				
Native	1:1 mapping centered		1:1 mapping display 1280 x 800	1280 x 720 centered	1:1 mapping centered
Auto	If this format is select, Screen type will auto become 16:10. (1280 x 800) If source is 4:3, auto resize to 1066 x 800. If source is 16:9, auto resize to 1280 x 720. If source is 15:9, auto resize to 1280 x 768. If source is 16:10, auto resize to 1280 x 800.				

16:9 Screen	480i/p	576i/p	1080i/p	720p	PC
4:3	960 x 720 center				
16:9	1280 x 720 center				
LBX	1280 x 960 center, then get the central 1280 x 720 image to display.				
Native	1:1 mapping centered		1:1 mapping display 1280 x 720	1280 x 720 centered	1:1 mapping centered
Auto	If this format is select, Screen type will auto become 16:9. (1280 x 720) If source is 4:3, auto resize to 960 x 720. If source is 16:9, auto resize to 1280 x 720. If source is 15:9, auto resize to 1200 x 720 area to display. If source is 16:10, auto resize to 1152 x 720 area to display.				

User Controls



- ❖ Each I/O has different settings of “Edge Mask”.
- ❖ “Edge Mask” and “Zoom” can’t work at same time.

Zoom

- ▶ Press the ◀ to reduce the size of an image.
- ▶ Press the ▶ to magnify an image on the projection screen.

Edge Mask

Edge mask function removes the noise in a video image. Edge mask the image to remove video encoding noise on the edge of video source.

H Image Shift

Shift the projected image position horizontally.

V Image Shift

Shift the projected image position vertically.

V Keystone

Press the ◀ or ▶ to adjust image distortion vertically and make a squarer image.

DISPLAY | Geometry *

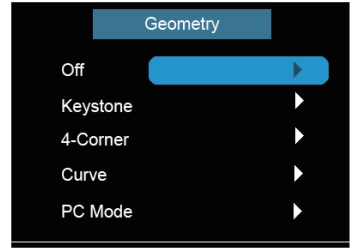

❖ (*) Optional function

Off

Choose the “Off” to disable the geometry function.

Keystone

This allows you to correct the keystone distortion.

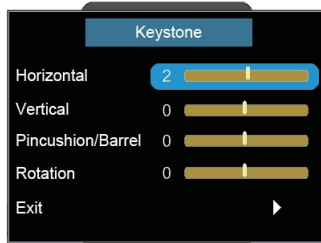

- ▶ Horizontal: Press the ◀ or ▶ to adjust the keystone horizontally and make a squarer image.
- ▶ Vertical: Press the ◀ or ▶ to adjust the keystone vertically and make a squarer image.

Resolution	Degrees of keystone Correction	
	Horizontal	Vertical
XGA	+/- 40	+/- 40
WXGA	+/- 40	+/- 40

- ▶ Pincushion/Barrel: Press the ◀ or ▶ to adjust the pincushion/barrel distortion. +/- 20% pincushion and barrel distortion correction.

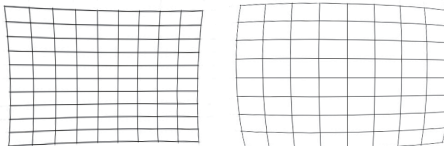

- ▶ Rotation: Press the ◀ or ▶ to adjust the angle of image. Rotation angles can reach to +/- 90 degree.

User Controls

4-Corner

This allows you to correct the trapezoidal distortion.

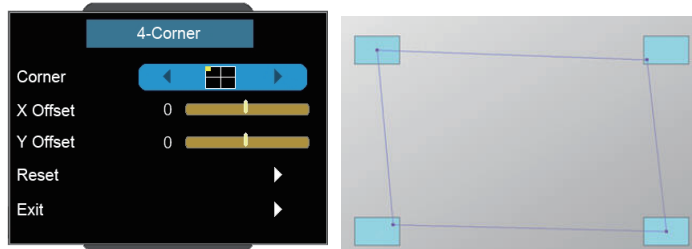

- ▶ 4 Corner position adjustments: Top Left, Bottom Left, Top Right, Bottom Right and All. Maximum is 5%.
- ▶ Press the ◀ or ▶ to adjust x/y offset of each corner image.

Curve

This allows you to adjust the curve of point 1~9.

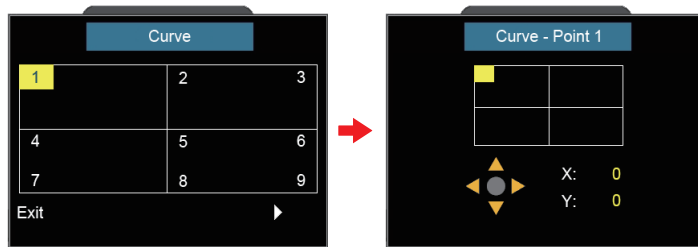

- ▶ The screen is separated into 4 (2x2) grids and you can adjust every point of grids.





PC Mode

Enable RJ45 control with PC software that allows user to control geometry.

DISPLAY | PIP



Screen

- ▶  Single: Projection single screen.
- ▶  PIP Window: Main screen is large screen; PIP screen is small and displays in the corner of the main screen.
- ▶  Split Screen: Main screen and PIP screen are equal sizes and side by side.

PIP Location

Choose the PIP screen position on the display screen.

PIP Size

Choose the PIP size from 1/16, 1/25 or 1/36 on the display screen.

PIP Source

Choose the PIP source to switch PIP screen source.

Swap

Press **↵** to swap main screen and PIP screen.

Some source/signal combinations may not be compatible with PIP function. Please refer to the table below:

PIP Source	Main Source							
	DVI-D	HDMI (v1.3)	BNC	VGA2	VGA1	S-Video	CVBS	Component
DVI-D	X	X	X	X	V	V	V	V
HDMI (v1.3)	X	X	X	X	V	V	V	V
BNC	X	X	X	X	V	V	V	V
VGA2	X	X	X	X	V	V	V	V
VGA1	V	V	V	V	X	X	X	X
S-Video	V	V	V	V	X	X	X	X
CVBS	V	V	V	V	X	X	X	X
Component	V	V	V	V	X	X	X	X

V: compatible X: not compatible

DISPLAY | 3D

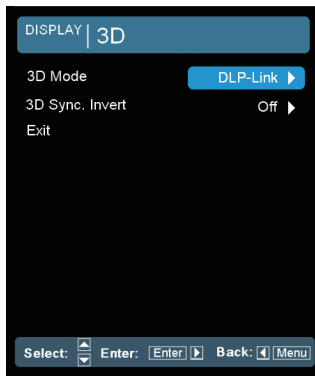

- ❖ “3D Sync Invert” is only available when “3D Mode” is enabled.
- ❖ Compatible 3D source, 3D content and active shutter glasses are required for 3D viewing.

3D Mode

- ▶ Off: Select “Off” to turn 3D settings off for 3D images.
- ▶ DLP Link: Select “DLP Link” to use optimized settings for DLP Link 3D images.
- ▶ VESA 3D: Select “VESA 3D” to use optimized setting for VESA 3D images.

3D Sync. Invert

- ▶ Press the “On” to invert left and right frame contents.
- ▶ Press the “Off” for default frame contents.

SETUP

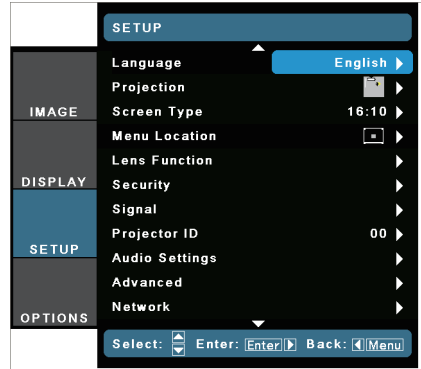





Language

Choose the multilingual OSD menu. Press ◀ or ▶ into the sub menu and then use the ▲ or ▼ to select your preferred language. Press “Enter” to finalize the selection.



❖ Rear-Desktop and Rear-Ceiling are to be used with a translucent screen.

Projection

- ▶  **Front-Desktop**
This is the default selection. The image is projected straight on the screen.
- ▶  **Rear-Desktop**
When selected, the image will appear reversed.
- ▶  **Front-Ceiling**
When selected, the image will turn upside down.
- ▶  **Rear-Ceiling**
When selected, the image will appear reversed in upside down position.

User Controls



❖ “Screen Type” is only available for WXGA model.

Screen Type

Choose the screen type from 16:10 or 16:9.

Menu Location

Choose the menu location on the display screen.

Projector ID

ID definition can be set up by menu (range 0-99), and allow user control an individual projector by RS232. Refer to pages 87-90 for the complete list of RS232 commands.

SETUP *(Continued)*



❖ “Image Blending” is only available when “Geometry” is enabled.

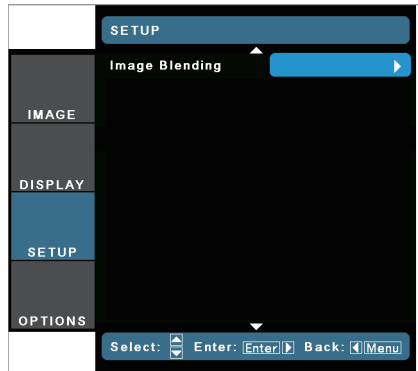

SETUP | **Lens Function**



Focus

Adjust focus function on the projected image.

Zoom

Adjust zoom function on the projected image.

Lens Shift

Shift the projected image.

- ▶ Lock: This function can not be used by user.
- ▶ Unlock: This function can be used by user.

Lens Type

Choose the lens type from A01, A02 or A03.

Lens Calibration

Perform calibration and return lens to the center position.

Blending Pattern

Show grid pattern for using image blending.

- ▶ Off: Choose "Off" to turn off grid pattern.
- ▶ Green: Choose "Green" to show green grid pattern for using image blending.
- ▶ Magenta: Choose "Magenta" to show magenta grid pattern for using image blending.

SETUP | Security

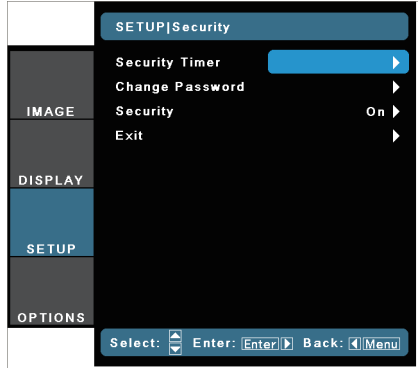

- ❖ Password default value is “1234” (first time).

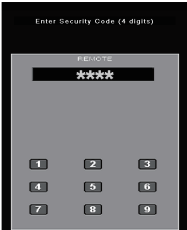

- ❖ Always keep the password in your files. If the password is forgotten or lost, the projector will have to be sent to your local authorized service center.

Security Timer

- ▶ On: Choose “On” to use security verification when turning on projector.
- ▶ Off: Choose “Off” to be able to switch on the projector without password verification.

Change Password

- ▶ First time:
 1. Press “←” to set the password.
 2. The password has to be 4 digits.
 3. Use number button on the remote to enter your new password and then press “←” key to confirm your password.
- ▶ Change Password:
 1. Press “←” to input old password.
 2. Use number button to enter current password and then press “←” to confirm.
 3. Enter new password (4 digits in length) using the number buttons on the remote, then press “←” to confirm.
 4. Enter new password again and press “←” to confirm.
- ▶ If the incorrect password is entered 3 times, the projector will automatically shut down.
- ▶ If you have forgotten your password, please contact your local office for support.

Security

- ▶ On: Choose “On” to use security verification when turning on projector.
- ▶ Off: Choose “Off” to be able to switch on the projector without password verification.

SETUP | Signal (RGB)

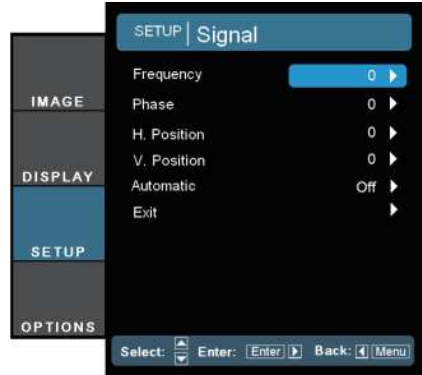

❖ “Signal” is only supported in Analog VGA (RGB) signal.

Frequency

Change the display data frequency to match the frequency of your computer's graphic card. Use this function only if the image appears to flicker vertically.

Phase

Synchronize the signal timing of the display with the graphic card. If the image appears to be unstable or flickers, use this function to correct it.

H. Position

- ▶ Press the ◀ to move the image left.
- ▶ Press the ▶ to move the image right.

V. Position

- ▶ Press the ◀ to move the image down.
- ▶ Press the ▶ to move the image up.

Automatic

Automatically detects the signal. If you use this function, the phase, frequency items are grayed out, and if signal is not automatic, the phase, frequency items will appear for user to manually tune and saved in settings after that for next time projector turns off and on again.

SETUP | Signal (Video)

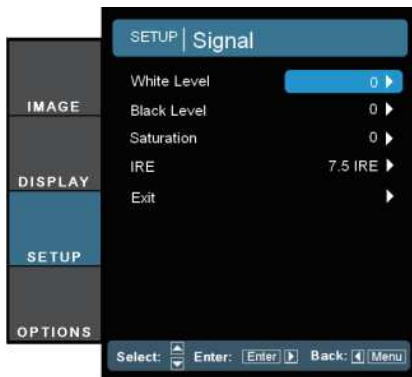

- ❖ “Signal” is not supported when the source is HDMI or DVI-D.

White Level

Allow user adjust White Level when inputting S-Video or Video/ CVBS signals.

Black Level

Allow user adjust Black Level when inputting S-Video or Video/ CVBS signals.

Saturation

Adjust a video image from black and white to fully saturated color.

- ▶ Press the ◀ to decrease the amount of saturation in the image.
- ▶ Press the ▶ to increase the amount of saturation in the image.

IRE

Adjust measurement of composite video signals.



- ❖ “IRE” is only supported on NTSC signal.

SETUP | Audio Settings

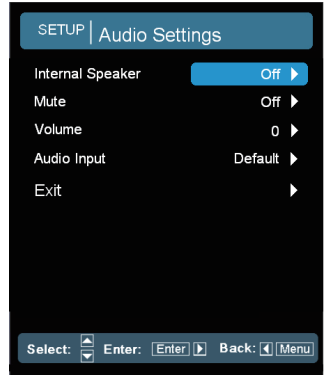

Internal Speaker

Choose the “On” or “Off” to turn on or off the internal speaker.

Mute

- ▶ Choose the “On” to turn mute on.
- ▶ Choose the “Off” to turn mute off.

Volume

- ▶ Press the ◀ to decrease the volume.
- ▶ Press the ▶ to increase the volume.

Audio Input

The default audio settings are on the back panel of the projector. Use this option to reassign any of the Audio Inputs (1 ,2 or 3) to the current image source. Each Audio input can be assigned to more than one video source.

- ▶ Audio 1: VGA 1.
- ▶ Audio 2: VGA 2.
- ▶ Audio 3: S-Video/Video.
- ▶ Default: Set Input back to default video source.

SETUP | Advanced

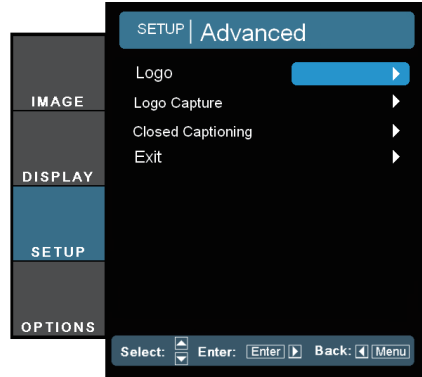

- ❖ For successful logo capture, please ensure that the input signal does not exceed the projector's native resolution. (1280 x 800 or 1280 x 720).
- ❖ Do not use signal with de-interlace.
- ❖ Do not turn off the projector during logo capturing.

Logo

Use this function to set the desired startup screen. If changes are made they will take effect the next time the projector is powered on.

- ▶ Optoma: The default startup screen.
- ▶ Neutral: Logo is not displayed on startup screen.
- ▶ User: Use stored picture from "Logo Capture" function.

Logo Capture

Press **←** to capture an image of the picture currently displayed on screen.

Closed Captioning

If changes are made they will take effect the next time the projector is powered on.

- ▶ Off: select "off" to turn off the closed captioning feature.
- ▶ CC1: CC1 language: American English.
- ▶ CC2: CC2 language (depending on the TV channel of the user): Spanish, French, Portuguese, German, Danish.

SETUP | Network

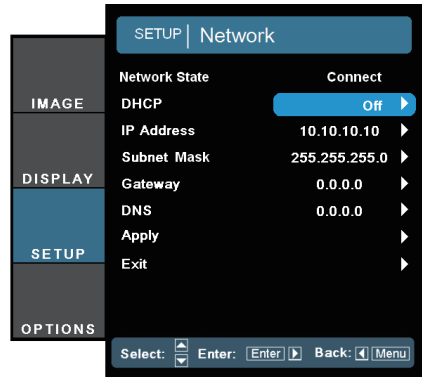

Network State

Display the network connection status.

DHCP

Use this function to select your desired startup screen. If you change the setting from one to another, when you exit the OSD menu, the new setting will take effect on next open.

- ▶ On: Assign an IP address to the projector from an external DHCP server automatically.
- ▶ Off: Assign an IP address manually.

IP Address

Select an IP address.

Subnet Mask

Select subnet mask number.

Gateway

Select the default gateway of the network connected to the projector.

DNS

Select DNS number.

Apply

Press “←” and then choose “Yes” to apply the selection.

User Controls

How to use web browser to control your projector

1. Turn on DHCP to allow the DHCP server to automatically assign an IP, or manually enter the required network information.

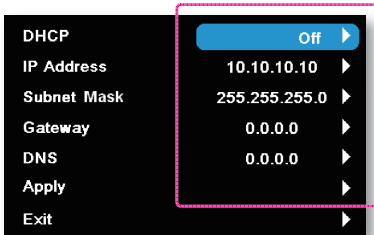

2. Then choose apply and press “↵” button to complete the configuration process.
3. Open your web browser and type in the projector’s IP address from the OSD LAN screen. The following web page will display as below:

Please note, each field can only contain a limited number of characters, as shown in the table below. (spaces and the other punctuation included):

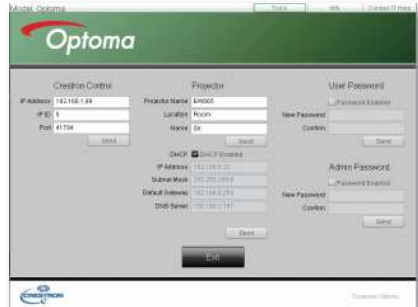

4. If connecting the projector to external Crestron control hardware, the settings can be found in the [tools] tab. (see picture).

Category	Item	Input-Length (characters)
Crestron Control	IP Address	15
	IP ID	2
	Port	5
Projector	Projector Name	10
	Location	9
	Assigned To	9
Network Configuration	DHCP (Enabled)	(N/A)
	IP Address	15
	Subnet Mask	15
	Default Gateway	15
	DNS Server	15
User Password	Enabled	(N/A)
	New Password	15
	Confirm	15
Admin Password	Enabled	(N/A)
	New Password	15
	Confirm	15

User Controls

When making a direct connection from your computer to the projector

Step 1: Find an IP Address (192.168.0.100) from LAN function of projector.

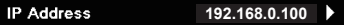

IP Address 192.168.0.100

Step 2: Select “Apply” and push the “Enter” button. Once the setting is saved, exit the OSD by pushing “Menu” button.

Step 3: To open Network Connections, click **Start**, click **Control Panel**, click **Network and Internet Connections**, and then click **Network Connections**. Click the connection you want to configure, and then, under **Network Tasks**, click **Change settings of this connection**.

Step 4: On the **General** tab, under **This connection uses the following items**, click **Internet Protocol (TCP/IP)**, and then click **“Properties”**.

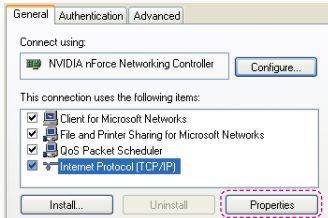

Step 5: Click **Use the following IP address**, and type in as below:

- 1) IP address: 192.168.0.101
- 2) Subnet mask: 255.255.255.0
- 3) Default gateway: 192.168.0.254

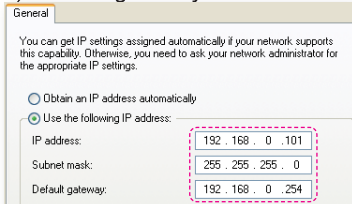

Step 6: To open Internet Options, click IE web browser, click Internet Options, click the **Connections** tab and click **“LAN Settings...”**

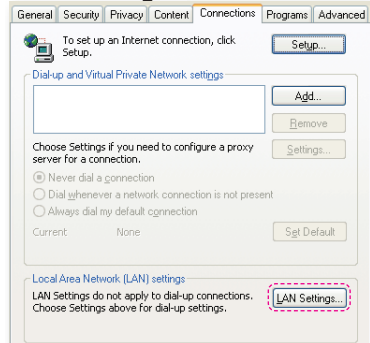

Step 7: All items in the **Local Area Network (LAN) Setting** window must be unchecked. Then click **“OK”** button twice.

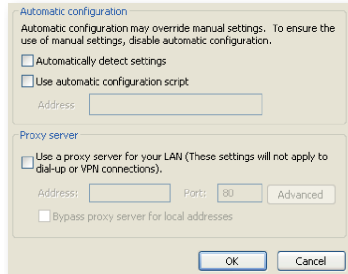

Step 8: Connect a cat5 Ethernet cross-over cable between the projector and the computer.

User Controls



❖ Crestron RoomView function support is dependent on models.

Crestron RoomView Control Tool

Crestron RoomView™ provides a central monitoring station for 250+ control systems on a single Ethernet network (more are possible, the number depends on the combination of IP ID and IP address). Crestron RoomView monitors each projector, including projector's online status, system power, lamp life, network setting and hardware faults, plus any custom attribute as defined by the Administrator.

The Administrator can add, delete, or edit room information, contact information and events, which are logged automatically by the software for all users. (Operation UI as following image)

1. Main Screen



2. Edit Room

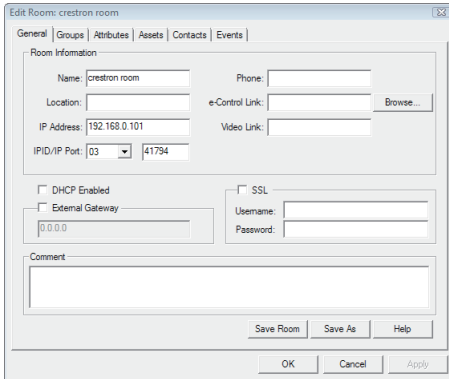

3. Edit Attribute

General | Alert | Groups | Contacts

Attribute Properties

Signal Name: Graphic: Off On

Device:

Signal Type:

Join Number: Default Max. Value:

Options

Apply attribute to all rooms Display on main view

Apply attribute to all contacts Show on context menu

Record attribute changes to log

4. Edit Event

General | Rooms

Event Properties

Name: Enable this event

Type: Repeat event

Join:

Schedule

Start Date: Weekdays Weekends

End Date: Monday Saturday

Time: Tuesday Sunday

Wednesday

Thursday

Friday

For more information, please visit
<http://www.crestron.com> & www.crestron.com/getroomview.

SETUP | Image Blending *

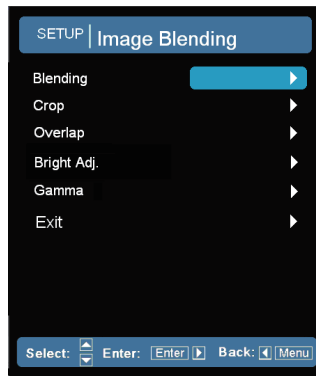

❖ (*) Optional function

Blending

- ▶ Choose the “On” to turn blending on.
- ▶ Choose the “Off” to turn blending off.

Crop

- ▶ Choose the “On” to turn crop on.
- ▶ Choose the “Off” to turn crop off.

Overlap

This allows you to set the overlap edge of blending area.

Bright Adj.

This allows you to adjust the brightness of the blending area.

Gamma

This allows you to select the gamma mode.

OPTIONS

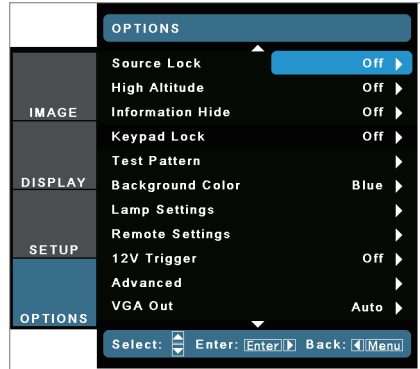

- ❖ Press direct source key on remote controller, it will change source directly and automatically set the Source Lock to “ON”.
- ❖ To turn off the keypad lock, press and hold “Enter” key on top of the projector for 5 seconds.

Source Lock

- ▶ On: The projector will only search current input connection.
- ▶ Off: The projector will search for other signals if the current input signal is lost.

High Altitude

When “On” is selected, the fans will spin faster. This feature is useful in high altitude areas where the air is thin.

Information Hide

- ▶ On: Choose “On” to hide the info message.
- ▶ Off: Choose “Off” to show the “searching” message.

Keypad Lock

When the keypad lock function is “On”, the control panel will be locked however, the projector can be operated by the remote control. By selecting “Off”, you will be able to reuse the control panel.

Test Pattern

Display a test pattern. There are Grid, White and None.

Background Color

Use this feature to display a “Blue”, “Black”, or “Gray” screen when no signal is available.

12V Trigger

12V trigger provides a standard trigger for motorized screens.

VGA Out

Use this feature to display the screen from input source.

- ▶ Auto: In standby mode (active), the default VGA out loops through from VGA1; unless VGA2 locked in last operation, VGA2 will loop through to VGA out.
- ▶ VGA 1: Choose the VGA 1-In input connector.
- ▶ VGA 2: Choose the VGA 2-In input connector.

OPTIONS (Continued)

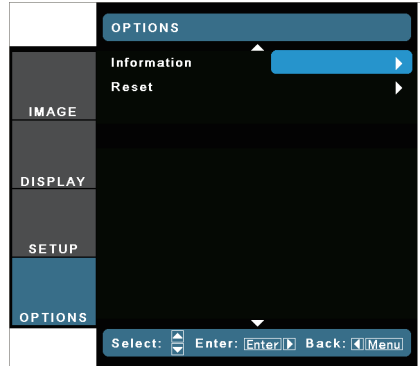

- ❖ Remote code: show the remote code of the projector.
- ❖ Remote code(Active): show the remote code of the remote control.

Information

Display the projector information for source, resolution, and software version on the screen.

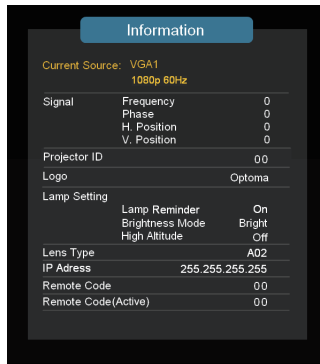

Reset

Choose “Yes” to return the display parameters on all menus to the factory default settings.

OPTIONS | Lamp Settings

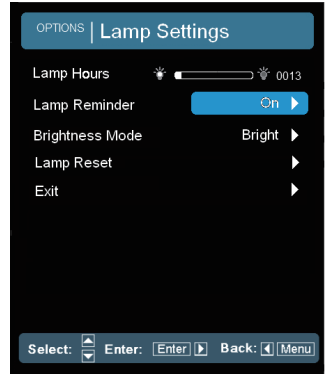

Lamp Hours

Display the projection time.

Lamp Reminder

Choose this function to show or to hide the warning message when the changing lamp message is displayed.

The message will appear 30 hours before suggested replacement of lamp.

Brightness Mode

- ▶ Bright: Choose “Bright” to increase the brightness.
- ▶ Eco: Choose “Eco” to dim the projector lamp which will lower power consumption and extend the lamp life.
- ▶ Image AI: Image AI improves the contrast of the picture by optimizing the brightness of the lamp according to the picture content.

Lamp Reset

Reset the lamp hour counter after replacing the lamp.



- ❖ When ambient temperature is over 35°C, the projector will switch to “Eco Mode” automatically.

OPTIONS | Remote Settings

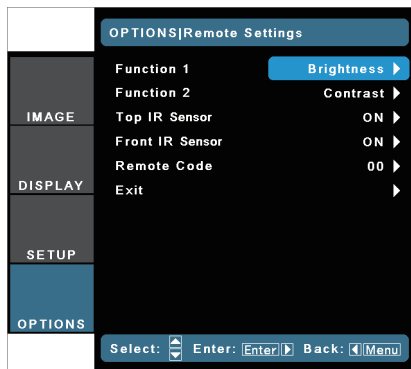

Function 1

Choose your desired function from “Brightness”, “PIP” or “Projection”.

Function 2

Choose your desired function from “Contrast”, “PIP Source”, “PIP Swap” or “Color”.

Top IR Sensor

When this function is “On”, the projector can be operated by the remote control from top IR receiver.

By selecting “Off”, you will be able to use the control panel keys or operate by the remote control from front IR receiver.

Front IR Sensor

When this function is “On”, the projector can be operated by the remote control from front IR receiver.

By selecting “Off”, you will be able to use the control panel keys or operate by the remote control from top IR receiver.

Remote Code

Set remote code of the projector.

- ▶ Default code (common code): 00
- ▶ Remote code: 01 ~ 99

OPTIONS | Advanced



Direct Power On

Choose “On” to activate Direct Power mode. The projector will automatically power on when AC power is supplied, without pressing the “ ϕ ” key on the projector control panel or on the remote control.

Signal Power On

The projector will power on when it receives a signal. This eliminates the need to use the “Power” button on the remote control or the projector keypad.

Auto Power Off (min)

Sets the countdown timer interval. The countdown timer will start, when there is no signal being sent to the projector. The projector will automatically power off when the countdown has finished (in minutes).

Sleep Timer (min)

Sets the countdown timer interval. The countdown timer will start, with or without a signal being sent to the projector. The projector will automatically power off when the countdown has finished (in minutes).

Power Mode (Standby)

- ▶ Eco.: Choose “Eco.” to save power dissipation further < 0.5W.
- ▶ Active: Choose “Active” to return to normal standby and the VGA out port will be enabled.

Baudrate

Select RS232 baudrate from “9600”, “19200”, or “38400”.



❖ Eco (<0.5W) mode will disable the VGA-out and RJ45 functions when the projector is in standby.



❖ (*) This function does not support for basic model.

Network Application System

Introduction *

Network application system include Optoma Presenter System, Web Control System and Multi-media Card Reader. Application which can bring the high performance in network projection. Base on network protocol, user can configure the projector remotely. It supports to connect the PC with Projector by USB, Ethernet, and Wireless. This project makes full use of the network capability. It allows the administrator to control all the projectors in one building by one PC. When some emergencies happen, the projector can send out alert information to administrator by email and web page. It can read more than one USB device directly and show all the images in it.

This project consists of three software applications which make full use of the network and USB capability:

- *Web Control*
- *Card Reader*
- *Optoma Presenter*

How to use Web Control

The Web Control application allows user to configure the projector remotely base on various network protocol. It is convenient for administrator to control the whole projectors in one building by one PC.

1. Start the web browser, and enter the IP address of the projector in URL: <http://IP-address>, the log-in web page is displayed.



User Controls

- There are 3 options in this page.
 - Click “Download”, it displays the interface to download the software of “Optoma Presenter”.
 - Click “Crestron”, to enter the control page of Flash UI.
 - Click “Admin”, the log-in page shows up.
- Enter the password and click [Login] button, and then main page is displayed. The default password is “admin” when target system is brand new. The maximum password is 8 characters with any characters except “space”.
- Click “Logout”, it returns back to log-in page.



System Status

This page indicates the information of Model Name, Versions, LAN Status and Wireless Status.

General Setup

Password of entering control web page can be changed here. Old password is requested when changing a new password.



Projector Control

All items in this page is the detail options about how to control the projector more smoothly. Example: Power On/OFF, Source change, Brightness, This page will refresh the status currently of all the items in few seconds.



Alert Setup

This page is to set up the alert notification for kinds of error types by sending mail. Alert type is multi-options.



SMTP Mail Setup

This page is to set up the details of mail sending, ex. mail server IP address, user name, password and mail address of receivers. (Note: Multi-receivers are separated by semicolon.)



Network Setup

This page is to set up network parameters of IP, DHCP Server, and wireless.

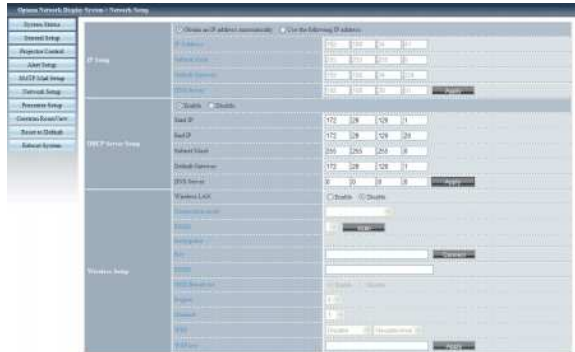

- *IP Setup:* Click “Obtain an IP address automatically” as auto mode; click “Use the following IP Address” as static mode, IP Address/Subnet Mask/Default Gateway/ DNS Server are required to be filled and then click “Apply” button.
- *DHCP Server Setup:* Enable/Disable, Start IP, End IP, Subnet Mask, Default Gateway, DNS server.
- *Wireless Setup:* Connect with wireless dongle, and then setup WLAN mode, SSID, KEY, Channel etc.

Presenter Setup

Admin password/User password is used to change the password for admin/user in target side.





Click “Connection Control” to enter “Connection Status”



- *Conference Control:* Click “On” or “Off” to enable/disable conference control mode.

User Controls

Click the following icons under “Play Control”

- : Click to disconnect host PC.
- : Click to switch session to background.
- : Click to change display region.

Crestron RoomView

This is the control page of Flash UI.

Click “Power” to control power on/off of projector.

Click “Vol-, Mute, Vol+” to control volume.

In the SourceList, it includes all sources that the projector can process.

Click “Menu” to open menu; click “Source” to choose next source; click “Auto” to detect the source automatically; click “Blank” for AV mute function.

“Contrast, Brightness, Color, Sharpness, Zoom, Freeze” can be adjusted in the control panel below.



User Controls

Click “Tools”, the following items are included:

Modal: Optoma | Tools | Info | Contact Us Help

Optoma

Crestron Control	Projector	User Password
IP Address: 192.168.1.88	Projector Name: EW605	<input type="checkbox"/> Password Enabled
IP ID: 8	Location: Room	New Password: <input type="text"/>
Port: 41704	Name: 01	Confirm: <input type="text"/>
<input type="button" value="Send"/>	<input type="button" value="Send"/>	<input type="button" value="Send"/>
DHCP <input checked="" type="checkbox"/> DHCP Enabled		
IP Address: 192.168.0.22	Subnet Mask: 255.255.255.0	Admin Password: <input type="text"/>
Default Gateway: 192.168.0.254	DNS Server: 192.168.0.1	<input type="checkbox"/> Password Enabled
<input type="button" value="Send"/>	<input type="button" value="Send"/>	New Password: <input type="text"/>
		Confirm: <input type="text"/>
		<input type="button" value="Send"/>

CRESTRON OPTOMA | Crestron Optima

- *Crestron Control: the basic network information of the control system device.*
 - *Projector: the ID of each projector in a building for Administrator to control.*
 - *User Password: change user's password.*
 - *Default Language: set the default language.*
 - *DHCP: enable/disable DHCP and the details of network card.*
 - *Admin Password: change administrator's password.*
- After change each items, click “Send” button to make it effect.

Click “Info” to show information and status of this projector.

Modal: Optoma | Tools | Info | Contact Us Help

Optoma

Projector Information	Projector Status
Projector Name: EW605	Power Status: On
Location: Room	Source: HDMI
Firmware Version: B18	Preset Mode: Movie
Mac Address: 00:01:02:03:04:05	Projector Position: Front Desktop
Resolution: 0x0 0Hz	Lamp Mode: Bright
Lamp Hours: 73	Error Status: <input type="text"/>
Assigned To: 01	

CRESTRON OPTOMA | Crestron Optima

User Controls

Click “Help” to inform administrator to do related protection or operation.

Reset to Default

Click “Apply” to reset system to the default settings.

Click “Flash Upgrade” to upgrade the Firmware from USB disk, which has been inserted in projector.



Reboot System

Click “Reboot” to reboot system.



How to use the Card Reader

The Card Reader application can display packaged images in a USB flash device.

1. Plugging the USB device into USB port of projector, source of Flash Drive is detected, and then USB Flash Devices Detection Screen is displayed. It supports 3 USB devices at the same time.



2. Press "Enter" to enter Thumbnail mode, different photos in different folders can be chosen; press "Menu" to open menu. The following buttons are supported in the user interface:



- *Previous*: Move the selected item left. (Go to previous page when this is the most left item)
- *Next*: Move the selected item right. (Go to next page when this is the most right item.)
- *Display*: Display the selected image or folder.
- *Thumbnail*: Enter the Thumbnail Display Mode.
- *Slide Show*: Enter the Slide Show Mode.
- *Name Order*: Sort files/folders in name order.
- *Extend Order*: Sort files/folders in extended order.
- *SizeOrder*: Sort files/folders in size order.
- *TimeOrder*: Sort files/folders in time order.
- *Projector Menu*: Enter OSD menu.

User Controls

- *File Name On/OFF: Enable/Disable file name display in Thumbnail Display Mode.*

Press Up/Down/Left/Right key to choose different functions.

3. In the menu of Thumbnail mode, choose Display function, or choose file and press “Enter” to enter Display mode. The following buttons are supported in the user interface:



- *Display: Enter the Image Display Mode.*
- *Thumbnail: Enter the Thumbnail Display Mode.*
- *Slide Show: Enter the Slide Show Mode.*
- *Actual Size: Display in actual size of the image.*
- *Best Fit: Display the image in best fit to the screen.*
- *EXIF Disp OFF/On: Enable/Disable EXIF information display.*
- *+90/-90 deg: Rotate 90/-90 degree.*

Press Up/Down/Left/Right key to choose different functions.

4. Press the SlideShow key to enter the Slide Show Mode. The following buttons are supported in the user interface:



- *Stop: Stop Slide Show Mode.*
- *Delay 3/4/5: Slide Show delay in seconds.*

User Controls

- *Slide Effect: Following modes are supported. (Slide Right/Slide Down/Slide Up/Slide Auto)*
 - *Repeat ON/OFF: Enable/Disable Slide Show Repeat Mode.*
- Press Up/Down/Left/Right key to choose different functions.

When the image can NOT be displayed due to memory limitation or can NOT support image format, the specific image is displayed on the center of the screen.

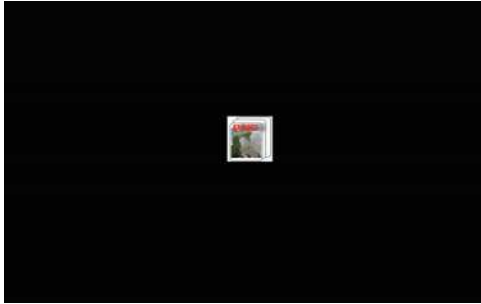

How to use the Optoma Presenter

Optoma Presenter application allows remote desktop from a host PC to be displayed on the network display through Ethernet, USB, or Wireless transports. It can adapt to different network settings (DHCP, fixed IP, and direct link by USB/Ethernet cable).

This software can be downloaded from web page.

Before using this function, a USB cable is needed to connect the Projector and PC Host directly. When the connection is OK, the PC will show a USB device disk. 





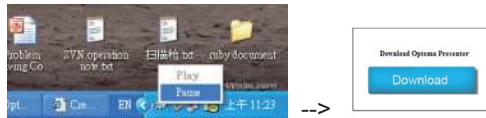

Select "Optoma Presenter", and then run "autorun.exe" to start USB Display. 

1. Press the Autorun icon in the right-down region to pause or play the USB display.



2. After installation in PC, double click the program of Optoma Presenter to enter main window.



-  : Connect and search network display.
-  : Stop/Start displaying desktop contents to connected network display.
-  : Select display region.
-  : Configure Optoma Presenter.
-  : Manage all connected network displays.
-  : Disconnect all connections.

User Controls

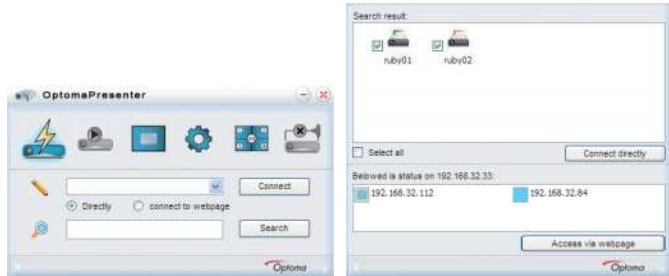

Click the button  to enter Connect and Search Menu.

1. Enter IP address of projector, select the option “Directly”, and then click “Connect” button to enter log-in interface; or Click “Search” button to search the projectors on network and select projectors to connect.



2. Input “User type” and “Password” in log-in interface. Display port can be selected, default is “Full screen”.



3. After log-in, Optoma Presenter will modify PC resolution to Ruby supported resolution, and the buttons  and  become available.

Click the button  to select the size of projection region, including Full screen, Fixed Size and Alterable mode.



User Controls



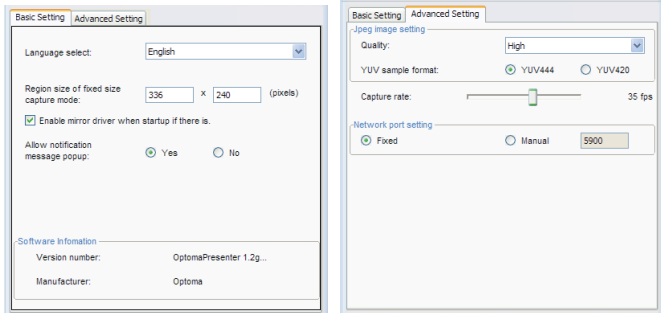

Click the button  to enter Setting interface, including Basic Setting and Advanced Setting.







- *Basic Setting: Select Language, Region size of fixed size capture mode and allow notification message popup.*
- *Advanced Setting: select JPEG image quality, YUV sample format and network port.*

Click the button  to control all the users and all the projectors connected to the same projector.







-  : For Administrator user login.
-  : For Normal user login.
-  : Status of the connection for connected.
-  : Status of the connection for not connected.
-  : For the status and display position of local screen on the network display, change it by clicking on it and a dialog box appears.

User Controls

- : Click this unlock icon, the password can be changed. (Password change to target network display, only a connection with an Administrator user logged in can change the password.)
- : Click this lock icon will result in no response.
- : Disconnect with target network display.
- : Connect the target network display via a webpage front end.

User of Admin type is able to view a menu page with a list of PCs connected to the target network display.





- : For the other PCs.
- : For the current PC.
- : Options of display port in which the highlight one is the current status, click on one of them to change the display port.
- : Disconnect the PC from a network display.

Troubleshooting

If you experience a problem with your projector, please refer to the following information. If a problem persists, please contact your local reseller or service center.

Image Problems

-  No image appears on-screen
- ▶ Ensure all the cables and power connections are correctly and securely connected as described in the “Installation” section.
 - ▶ Ensure the pins of connectors are not crooked or broken.
 - ▶ Check if the projection lamp has been securely installed. Please refer to the “Replacing the Lamp” section.
 - ▶ Make sure you have removed the lens cap and the projector is switched on.
 - ▶ Ensure that the “AV Mute” feature is not turned on.
-  Partial, scrolling or incorrectly displayed image
- ▶ Press “Re-SYNC” on the remote.
 - ▶ If you are using a PC:
For Windows 95, 98, 2000, XP, Windows 7:
 1. Open the “My Computer” icon, the “Control Panel” folder, and then double click on the “Display” icon.
 2. Select the “Settings” tab.
 3. Verify that your display resolution setting is lower than or equal to UXGA (1600 x 1200).
 4. Click on the “Advanced Properties” button.
If the projector is still not projecting the whole image, you will also need to change the monitor display you are using. Refer to the following steps.
 5. Verify the resolution setting is lower than or equal to UXGA (1600 x 1200).
 6. Select the “Change” button under the “Monitor” tab.
 7. Click on “Show all devices”. Next, select “Standard monitor types” under the SP box; choose the resolution mode you need under the “Models” box.
 8. Verify that the resolution setting of the monitor display is lower than or equal to UXGA (1600 x 1200).

- ▶ If you are using a Notebook:
 1. First, follow the steps above to adjust resolution of the computer.
 2. Press the appropriate keys listed below for your notebook manufacturer to send signal out from notebook to projector. Example: [Fn]+[F4]

Acer ⇒	[Fn]+[F5]	Gateway ⇒	[Fn]+[F4]
Asus ⇒	[Fn]+[F8]	IBM/Lenovo ⇒	[Fn]+[F7]
Dell ⇒	[Fn]+[F8]	HP/Compaq ⇒	[Fn]+[F4]
Mac Apple: System Preference ⇒ Display ⇒ Arrangement ⇒ Mirror display			

- ▶ If you experience difficulty changing resolutions or your monitor freezes, restart all equipment including the projector.

The screen of the Notebook or PowerBook computer is not displaying your presentation

- ▶ If you are using a Notebook PC
Some Notebook PCs may deactivate their own screens when a second display device is in use. Each has a different way to be reactivated. Refer to your computer's manual for detailed information.

Image is unstable or flickering







- ▶ Use "Phase" to correct it. See page 45 for more information.
- ▶ Change the monitor color setting on your computer.

Image has vertical flickering bar

- ▶ Use "Frequency" to make an adjustment. See page 45 for more information.
- ▶ Check and re-configure the display mode of your graphic card to make it compatible with the projector.

Image is out of focus

- ▶ Make sure the projector cap is removed.
- ▶ Adjust the Focus function for the projector lens.
- ▶ Make sure the projection screen is between the required distance. See pages 18-20.

-  The image is stretched when displaying 16:9 DVD title
- ▶ When you play anamorphic DVD or 16:9 DVD, the projector will show the best image when the projector display mode is set to 16:9 in the OSD.
 - ▶ If you play 4:3 format DVD titles, please change the format to 4:3 in the projector OSD.
 - ▶ If the image is still stretched, you will also need to adjust the aspect ratio by referring to the following:
 - ▶ Please setup the display format as 16:9 (wide) aspect ratio type on your DVD player.
-  Image is too small or too large
- ▶ Move the projector closer to or further from the screen.
 - ▶ Press "Menu" on the projector panel or projector panel, go to "Display → Format" and try the different settings.
-  Image has slanted sides
- ▶ If possible, reposition the projector so that it is horizontally centered on the screen and below the bottom of the screen.
 - ▶ Press "Keystone" button on the remote control, until the sides are vertical.
-  Image is reversed
- ▶ Select "SETUP → Projection" from the OSD and adjust the projection direction.
-  The projector stops responding to all controls
- ▶ If possible, turn off the projector, then unplug the power cord and wait at least 60 seconds before reconnecting power.
 - ▶ Check that "Keypad Lock" is not activated by trying to control the projector with the remote control.
-  Lamp burns out or makes a popping sound
- ▶ When the lamp reaches its end of life, it will burn out and may make a loud popping sound. If this happens, the projector will not turn on until the lamp module has been replaced. To replace the lamp, follow the procedures in the "Replacing the Lamp" section on pages 78-79.



- ❖ Steady light ⇨ ☀
- ❖ No light ⇨ ○

LED Lighting Messages

Message	⏻		🔑	💡	🔄
	Power LED		Temp LED	Lamp LED	Shutter LED
	(Red)	(Blue)	(Red)	(Orange)	(Orange)
Standby State (Input power cord)	Flashing	○	○	○	○
Power on (Warming)	○	Flashing	○	○	○
Power on & Lamp lighting	○	☀	○	○	○
Power off (Cooling)	○	Flashing	○	○	○
Error (Lamp fail)	Flashing	○	○	☀	○
Error (Fan fail)	Flashing	○	Flashing	○	○
Error (Over Temp.)	Flashing	○	☀	○	○
Burn in (Lamp off)	Flashing	Flashing	○	○	○
Shutter on	○	○	○	○	☀

On Screen Messages

- ▶ Lamp warning:



If the remote control does not work

- ▶ Check the operating angle of the remote control is within $\pm 30^\circ$ both horizontally and vertically of one of the IR receivers on the projector.
- ▶ Make sure there are not any obstructions between the remote control and the projector. Move to within 12 m ($\pm 0^\circ$) of the projector.
- ▶ Make sure the batteries are inserted correctly.
- ▶ Replace batteries if they are exhausted.
- ▶ Ensure that you have set your remote to the correct IR code set (see page 25).

Replacing the Lamp

A warning message will be displayed once the lamp has surpassed life expectancy.

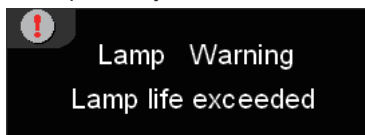

At this point, it is recommended to change the lamp as soon as possible. Please contact your local reseller or Optoma to acquire a lamp.

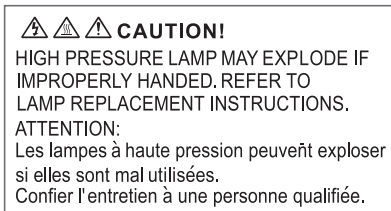

Warning: If ceiling mounted, please use caution when opening the lamp access panel. It is recommended to wear safety glasses if changing the bulb when ceiling mounted. "Caution must be used to prevent any loose parts from falling out of projector."



Warning: Lamp compartment is hot! Allow it to cool down before changing lamp!



Warning: To reduce the risk of personal injury, do not drop the lamp module or touch the lamp bulb. The bulb may shatter and cause injury if it is dropped.



- ❖ The screws on the lamp door and the lamp are not detachable.
- ❖ The projector cannot be turned on if the lamp cover is open.
- ❖ Do not touch the glass area of the lamp. Hand oil can cause the lamp to shatter. Use a dry cloth to clean the lamp module if it was accidentally touched.

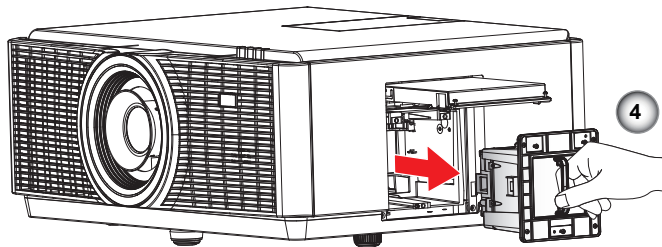
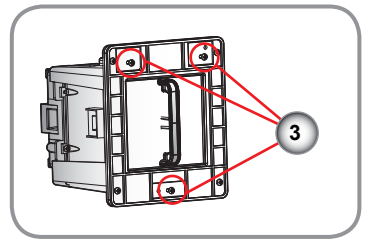
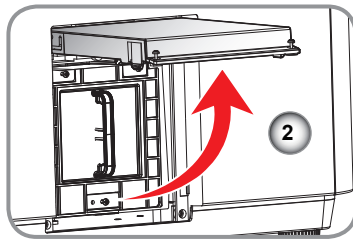
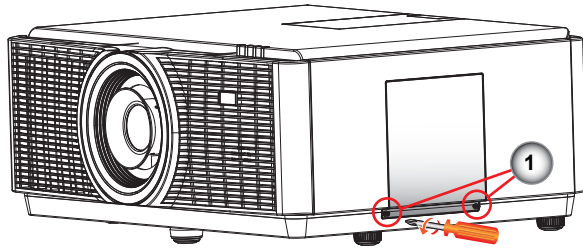

Lamp Replacing Procedure:

1. Switch off the power to the projector by pressing the “” button.
2. Allow the projector to cool down for at least 30 minutes.
3. Disconnect the power cord.
4. Unscrew the two screws on the lamp door. **1**
5. Open and pull up the lamp door. **2**
6. Unscrew the three screws on the lamp housing. **3**
7. Pull out the lamp module slowly and carefully. **4**

To replace the lamp module, reverse the previous steps.

8. Turn on the projector and use “Lamp Reset” after the lamp module is replaced.

Lamp Reset: (i) Press “Menu” → (ii) Select “OPTIONS” → (iii) Select “Lamp Settings” → (iv) Select “Lamp Reset” → (v) Select “Yes”.



❖ AFCM is an acronym for Auto Filter Cleaning Module.

Replacing the AFCM

A warning message will be displayed once the AFCM has surpassed life expectancy.

Please replace filter

At this point, it is recommended to change the AFCM as soon as possible. Please contact your local reseller or Optoma to acquire a AFCM.

If the prior message is ignored for a period of time, a warning message will be displayed and then the projector will be shut down automatically.



**Filter need replaced right away
system will be shut down**

At this point, it is recommended to change the AFCM as soon as possible. Please contact your local reseller or Optoma to acquire a AFCM.

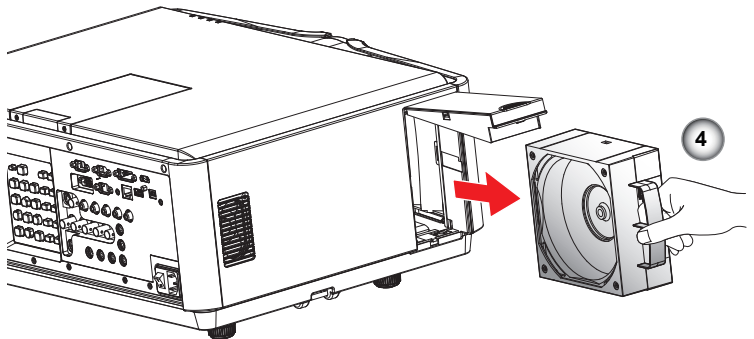
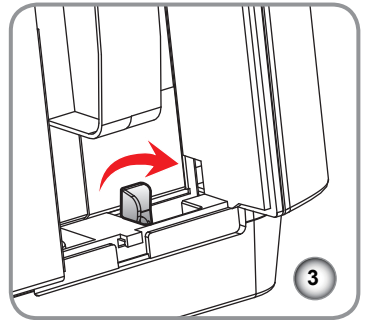
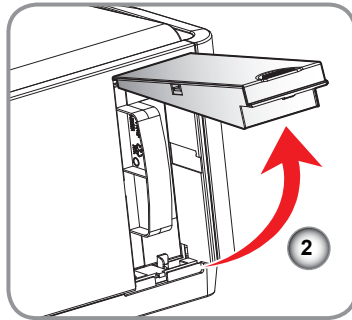
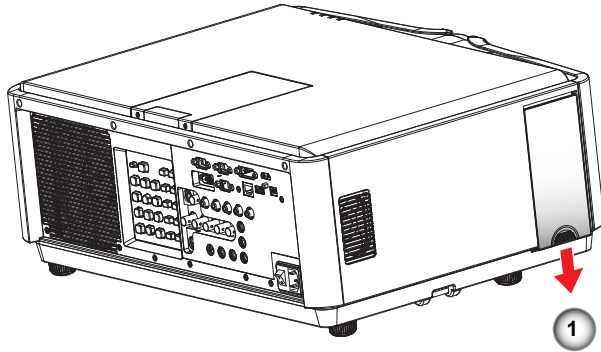

AFCM Replacing Procedure:

1. Gently push down the AFCM door. **1**
2. Lift the AFCM door. **2**
3. Turn the latch clockwise. **3**
4. Gently pull out the AFCM module. **4**

To install the AFCM, reverse the previous steps.

Replacing the Geo Module

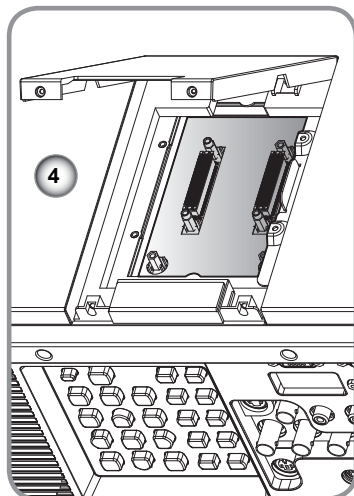
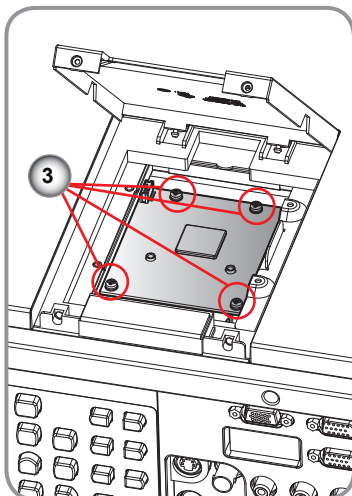
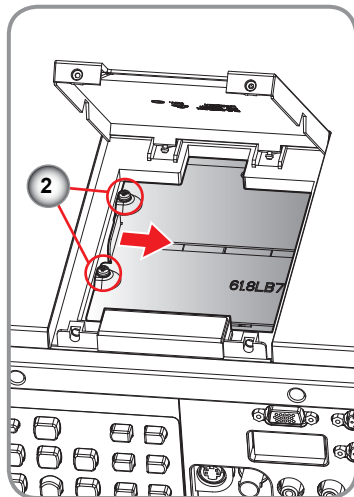
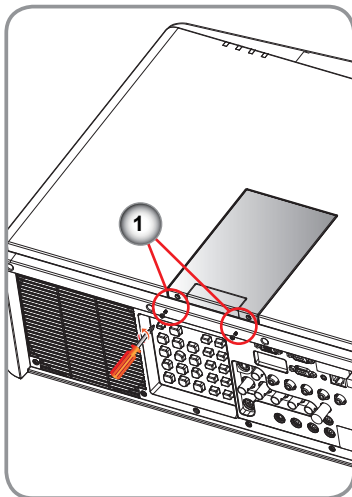

Geo Module Replacing Procedure:

1. Remove the 2 screws on Geo cover and then raise the Geo cover. **1**
2. Remove the 2 screws and slide Geo shielding cover to the right. **2**
3. Remove 4 remaining screws and dummy board. **3**
4. Replace the Geo module and reassemble. **4**

To install the Geo module, reverse the previous steps.

Compatibility Modes

► Computer Compatibility (PC)

Signal	Resolution	Frequency H. (KHz)	Refresh Rate (Hz)	Video	Digital	Analog
NTSC	-	15.734	60	V	-	-
PAL/SECAM	-	15.625	50	V	-	-
	640 x 350	31.5	70.1	X	V	V
	640 x 400	37.9	85.1	X	V	V
	720 x 400	31.5	70	X	V	V
	720 x 400	37.9	85	X	V	V
	720 x 576		50	X	V	V
VGA	640 x 480	31.5	60	X	V	V
	640 x 480		67	X	V	V
	640 x 480	37.9	72.8	X	V	V
	640 x 480	37.5	75	X	V	V
	640 x 480	43.3	85	X	V	V
SVGA	800 x 600	35.2	56.3	X	V	V
	800 x 600	37.9	60.3	X	V	V
	800 x 600	46.9	75	X	V	V
	800 x 600	48.1	72.2	X	V	V
	800 x 600	53.7	85.1	X	V	V
	832 x 624		75	X	V	V
XGA	1024 x 768	48.4	60	X	V	V
	1024 x 768	56.5	70.1	X	V	V
	1024 x 768	60	75	X	V	V
	1024 x 768	68.7	85	X	V	V
	1152 x 864		75	X	V	V
HD720	1280 x 720		50	X	V	V
	1280 x 720		60	X	V	V
WXGA	1280 x 768	47.4	60	X	V	V
	1280 x 768		75	X	V	V
	1280 x 768		85	X	V	V
WXGA-800	1280 x 800		60	X	V	V
SXGA	1280 x 1024	64	60	X	V	V
	1280 x 1024	80	75	X	V	V
	1280 x 1024	91.1	85	X	V	V
SXGA+	1400 x 1050		60	X	V	-
UXGA	1600 x 1200	75	60	X	V	V
HD1080	1920 x 1080		24	X	V	V
	1920 x 1080		50	X	V	V
	1920 x 1080		60	X	V	V
WUXGA	1920 x 1200		60	X	V	V

Appendices

Signal	Resolution	Frequency H. (KHz)	Refresh Rate (Hz)	Video	Digital	Analog
HDTV	1920 x 1080	33.8	30	V	-	-
	1920 x 1080		25	V	-	-
	1920 x 1080i	28.1	50	-	V	V
	1920 x 1080i		60	-	V	V
	1920 x 1080p		24	-	V	V
	1920 x 1080p		25	-	V	V
	1920 x 1080p	45	30	-	V	V
	1920 x 1080p		50	-	V	V
	1920 x 1080p		60	-	V	V
	1920 x 1080p		60	-	V	V
SDTV	1280 x 720	31.3	60	V	-	-
	1280 x 720p		50	-	V	V
	1280 x 720p		60	-	V	V
	720 x 576	31.5	50	V	-	-
	720 x 576i		50	-	V	V
	720 x 576p		50	-	V	V
	720 x 480		60	V	-	-
	720 x 480i		60	-	V	V
720 x 480p	60	-	V	V		



❖ 1920 x 1200
@60hz only support RB (reduced blanking).

❖ Computer Compatibility for MAC

Resolution	Refresh Rate (Hz)	Macbook compatibility		Macbook Pro (Intel) compatibility		Power Mac G5 compatibility		Power Mac G4 compatibility	
		Digital	Analog	Digital	Analog	Digital	Analog	Digital	Analog
800 x 600	60	V	V	V	V	-	-	V	-
800 x 600	72	V	V	V	V	-	V	V	V
800 x 600	75	V	V	V	V	-	V	V	V
800 x 600	85	V	V	-	V	-	V	V	V
1024 x 768	60	V	V	V	V	-	V	V	V
1024 x 768	70	V	V	V	V	-	V	V	V
1024 x 768	75	V	V	V	V	-	V	V	V
1024 x 768	85	V	V	V	V	-	V	V	V
1280 x 720	60	V	V	V	V	-	V	V	V
1280 x 768	60	V	V	V	V	-	-	-	V
1280 x 768	75	-	V	-	V	-	V	V	V
1280 x 768	85	-	V	-	V	-	-	-	V
1280 x 800	60	-	V	-	V	-	V	V	V
1280 x 1024	60	V	-	-	V	-	V	V	V
1280 x 1024	75	V	-	-	V	-	V	V	-
1920 x 1080	60	V	-	-	V	-	V	V	V
1920 x 1200	60	V	-	-	V	-	V	V	V

Remote Key Code

Default custom code => 32CD

Mode 01 ~ 99 => 3201 ~ 3299

Key name	Custom code		Data	Key name	Custom code		Data
	Byte 1	Byte 2	Byte 3		Byte 1	Byte 2	Byte 3
Power On	32	CD	02	Menu	32	CD	0E
Standby	32	CD	33	Keystone	32	CD	07
Test Pattern	32	CD	34	Format	32	CD	15
AV Mute	32	CD	03	Shutter	32	CD	32
Fun1	32	CD	26	DVI	32	CD	31
Fun2	32	CD	27	Info.	32	CD	25
Shift	32	CD	2F	Re-Sync	32	CD	04
Zoom	32	CD	2A	YPbPr	32	CD	17
Focus	32	CD	28	HDMI	32	CD	16
Up	32	CD	11	S-Video	32	CD	1D
Right	32	CD	12	VGA1	32	CD	1B
Down	32	CD	14	VGA2	32	CD	1E
Left	32	CD	10	BNC	32	CD	1A
Enter	32	CD	0F	Video	32	CD	1C
Mode	32	CD	05				

RS232 Commands and Protocol Function List RS232 Pin Assignments

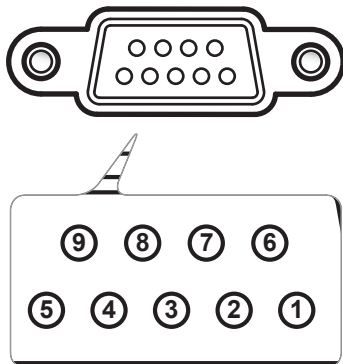

- ❖ RS232 shell is grounded.
- ❖ RS232 interface need use swap pin for RS232 communication.

Pin No.	PC Side	Projector Side (RS232 Terminal)
1	N/A	N/A
2	RXD	RXD
3	TXD	TXD
4	N/A	N/A
5	GND	GND
6	N/A	N/A
7	N/A	N/A
8	N/A	N/A
9	N/A	N/A

RS232 Protocol Function List

Optoma RS232 Command Table

Baud Rate : 9600

Data Bits: 8

Parity: None

Stop Bits: 1

Flow Control : None

UART16550 FIFO: Disable

Projector Return (Pass): F

Projector Return (Fail): F

Note : There is a <CR> after all ASCII commands

OD is the HEX code for <CR> in ASCII code

XX=01-99, projector's ID, XX=00 is for all projectors

SEND to projector

232 ASCII Code	HEX Code	Function	Description
~XX00 1	7E 30 30 30 20 31 0D	Power	On
~XX00 0	7E 30 30 30 20 30 0D		Off
~XX00 1 ~nnnn	7E 30 30 30 20 31 20 a OD	Power ON with Password	~nnnn = ~0000 (a=7E 30 30 30 30) ~ ~9999(a=7E 39 39 39 39)
~XX01 1	7E 30 30 30 31 20 31 0D	Resync	
~XX02 1	7E 30 30 30 32 20 31 0D	AV Mute	On
~XX02 0	7E 30 30 30 32 20 30 0D		Off
~XX03 1	7E 30 30 30 33 20 31 0D	Mute	On
~XX03 0	7E 30 30 30 33 20 30 0D		Off
~XX04 1	7E 30 30 30 34 20 31 0D	Freeze	
~XX04 0	7E 30 30 30 34 20 30 0D	Unfreeze	
~XX05 1	7E 30 30 30 35 20 31 0D	Zoom Plus	
~XX06 1	7E 30 30 30 36 20 31 0D	Zoom Minus	
~XX07 1	7E 30 30 30 37 20 31 0D	Up (Pan under zoom)	
~XX08 1	7E 30 30 30 38 20 31 0D	Down (Pan under zoom)	
~XX09 1	7E 30 30 30 39 20 31 0D	Left (Pan under zoom)	
~XX10 1	7E 30 30 31 30 20 31 0D	Right (Pan under zoom)	
~XX11 1	7E 30 30 31 31 20 31 0D	IR function	On All
~XX11 0	7E 30 30 31 31 20 30 0D		Off All
~XX11 2	7E 30 30 31 31 20 32 0D		Off Front
~XX11 3	7E 30 30 31 31 20 33 0D		Off Top
~XX12 1	7E 30 30 31 32 20 31 0D	Direct Source Command	HDMI
~XX12 2	7E 30 30 31 32 20 32 0D		DVI
~XX12 4	7E 30 30 31 32 20 34 0D		BNC
~XX12 5	7E 30 30 31 32 20 35 0D		VGA 1
~XX12 6	7E 30 30 31 32 20 36 0D		VGA 2
~XX12 9	7E 30 30 31 32 20 39 0D		S-Video
~XX12 10	7E 30 30 31 32 20 31 30 0D		Video
~XX12 14	7E 30 30 31 32 20 31 34 0D		Component
~XX12 17	7E 30 30 31 32 20 31 37 0D		Flash Drive
~XX12 18	7E 30 30 31 32 20 31 38 0D		Presenter
~XX12 19	7E 30 30 31 32 20 31 39 0D		USB Display
~XX20 1	7E 30 30 32 30 20 31 0D	Display Mode	Presentation
~XX20 2	7E 30 30 32 30 20 32 0D		Bright
~XX20 3	7E 30 30 32 30 20 33 0D		Movie
~XX20 4	7E 30 30 32 30 20 34 0D		sRGB
~XX20 5	7E 30 30 32 30 20 35 0D		User
~XX20 10	7E 30 30 32 30 20 31 30 0D		DICOM Sim.
~XX20 7	7E 30 30 32 30 20 37 0D		ISF Day/Blackboard
~XX20 8	7E 30 30 32 30 20 38 0D		ISF Night/ Classroom
~XX20 9	7E 30 30 32 30 20 39 0D		3D
~XX21 n	7E 30 30 32 31 20 a OD	Brightness	n = -50 (a=2D 35 30) ~ 50(a=35 30)
~XX22 n	7E 30 30 32 32 20 a OD	Contrast	n = -50 (a=2D 35 30) ~ 50(a=35 30)
~XX23 n	7E 30 30 32 33 20 a OD	Sharpness	n = 1 (a=31) ~ 15(a=31 35)
~XX44 n	7E 30 30 34 24 20 a OD	Tint	n = -50 (a=2D 35 30) ~ 50(a=35 30)
~XX45 n	7E 30 30 34 35 20 a OD	Color	n = -50 (a=2D 35 30) ~ 50(a=35 30)
~XX24 n	7E 30 30 32 34 20 a OD	RGB Gain/Bias	Red Gain n = -50 (a=2D 35 30) ~ 50(a=35 30)
~XX25 n	7E 30 30 32 35 20 a OD		Green Gain n = -50 (a=2D 35 30) ~ 50(a=35 30)
~XX26 n	7E 30 30 32 36 20 a OD		Blue Gain n = -50 (a=2D 35 30) ~ 50(a=35 30)
~XX27 n	7E 30 30 32 37 20 a OD		Red Bias n = -50 (a=2D 35 30) ~ 50(a=35 30)
~XX28 n	7E 30 30 32 38 20 a OD		Green Bias n = -50 (a=2D 35 30) ~ 50(a=35 30)
~XX29 n	7E 30 30 32 39 20 a OD		Blue Bias n = -50 (a=2D 35 30) ~ 50(a=35 30)
~XX33 1	7E 30 30 33 32 20 31 0D		Reset
~XX34 n	7E 30 30 33 34 20 a OD	BrilliantColor™	n = 0 (a=30) ~ 10 (a=31 30)
~XX35 1	7E 30 30 33 35 20 31 0D	Gamma	Film
~XX35 2	7E 30 30 33 35 20 32 0D		Video
~XX35 3	7E 30 30 33 35 20 33 0D		Graphics
~XX35 4	7E 30 30 33 35 20 34 0D		Standard
~XX182 n	7E 30 30 31 38 32 20 a OD	Film	Curve Type n = -7 (a=2D 37) ~ 7(a=37)
~XX183 n	7E 30 30 31 38 33 20 a OD		Offset n = -5 (a=2D 35) ~ 5(a=35)
~XX206 1	7E 30 30 32 30 36 20 31 0D		Reset
~XX184 n	7E 30 30 31 38 34 20 a OD	Video	Curve Type n = -7 (a=2D 37) ~ 7(a=37)
~XX185 n	7E 30 30 31 38 35 20 a OD		Offset n = -5 (a=2D 35) ~ 5(a=35)
~XX207 1	7E 30 30 32 30 37 20 31 0D		Reset
~XX186 n	7E 30 30 31 38 36 20 a OD	Graphics	Curve Type n = -7 (a=2D 37) ~ 7(a=37)
~XX187 n	7E 30 30 31 38 37 20 a OD		Offset n = -5 (a=2D 35) ~ 5(a=35)
~XX208 1	7E 30 30 32 30 38 20 31 0D		Reset
~XX188 n	7E 30 30 31 38 38 20 a OD	Standard	Curve Type n = -7 (a=2D 37) ~ 7(a=37)
~XX189 n	7E 30 30 31 38 39 20 a OD		Offset n = -5 (a=2D 35) ~ 5(a=35)
~XX209 1	7E 30 30 32 30 39 20 31 0D		Reset
~XX36 1	7E 30 30 33 36 20 31 0D	Color Temp.	Warm
~XX36 2	7E 30 30 33 36 20 32 0D		Medium
~XX36 3	7E 30 30 33 36 20 33 0D		Cold
~XX37 1	7E 30 30 33 37 20 31 0D	Color Space	Auto
~XX37 2	7E 30 30 33 37 20 32 0D		RGB(0-255)
~XX37 3	7E 30 30 33 37 20 33 0D		YUV
~XX37 4	7E 30 30 33 37 20 34 0D		RGB(16-255)
~XX196 n	7E 30 30 31 39 36 20 a OD	Noise Reduction	n = 0 (a=30) ~ 10(a=31 30)

Appendices

~XX191 1	7E 30 30 31 39 31 20 31 00	DynamicBlack	On	
~XX191 0	7E 30 30 31 39 31 20 30 00		Off	
~XX39 1	7E 30 30 33 39 20 31 00	Input Source	HDMI	
~XX39 2	7E 30 30 33 39 20 32 00		DVI	
~XX39 4	7E 30 30 33 39 20 34 00		BNC	
~XX39 5	7E 30 30 33 39 20 35 00		VGA 1	
~XX39 6	7E 30 30 33 39 20 36 00		VGA 2	
~XX39 8	7E 30 30 33 39 20 38 00		3xRCA Component	
~XX39 9	7E 30 30 33 39 20 39 00		S-Video	
~XX39 10	7E 30 30 33 39 20 31 30 00		Video	
~XX39 12	7E 30 30 33 39 20 31 32 00		Flash Drive	
~XX39 13	7E 30 30 33 39 20 31 33 00		Presenter	
~XX39 14	7E 30 30 33 39 20 31 34 00		USB Display	
~XX60 1	7E 30 30 36 30 20 31 00	Format	4:3	
~XX60 2	7E 30 30 36 30 20 32 00		16:9-I/16:9	
~XX60 3	7E 30 30 36 30 20 33 00		16:9-II/16:10	
~XX60 5	7E 30 30 36 30 20 35 00		LBX	
~XX60 6	7E 30 30 36 30 20 36 00		Native	
~XX60 7	7E 30 30 36 30 20 37 00		Auto	
~XX61 n	7E 30 30 36 31 20 a 00	Edge Mask		n = 0 (a=30) ~ 5(a=5)
~XX62 n	7E 30 30 36 32 20 a 00	Zoom		n = -20 (a=2D 32 30) ~ 50(a=35 30)
~XX63 n	7E 30 30 36 33 20 a 00	H Image Shift		n = -50 (a=2D 35 30) ~ 50(a=35 30)
~XX64 n	7E 30 30 36 34 20 a 00	V Image Shift		n = -24 (a=2D 32 34) ~ 24(a=32 34)
~XX66 n	7E 30 30 36 36 20 a 00	V Keystone		n = -20 (a=2D 32 30) ~ 20(a=32 30)
~XX230 0	7E 30 30 32 33 30 20 30 00	3D Mode	Off	
~XX230 1	7E 30 30 32 33 30 20 31 00		DLP-Link	
~XX230 3	7E 30 30 32 33 30 20 33 00		VESA 3D/IR	
~XX231 1	7E 30 30 32 33 31 20 31 00	3D Sync. Invert	On	
~XX231 0	7E 30 30 32 33 31 20 30 00		Off	
~XX302 0	7E 30 30 33 30 32 20 30 00	PIP Screen	Off	
~XX302 1	7E 30 30 33 30 32 20 31 00		PIP	
~XX302 2	7E 30 30 33 30 32 20 32 00		SBS	
~XX303 1	7E 30 30 33 30 33 20 31 00	PIP Location	Top Left	
~XX303 2	7E 30 30 33 30 33 20 32 00		Top Right	
~XX303 3	7E 30 30 33 30 33 20 33 00		Bottom Left	
~XX303 4	7E 30 30 33 30 33 20 34 00		Bottom Right	
~XX304 1	7E 30 30 33 30 34 20 31 00	PIP Size	1/16	
~XX304 2	7E 30 30 33 30 34 20 32 00		1/25	
~XX304 3	7E 30 30 33 30 34 20 33 00		1/36	
~XX305 1	7E 30 30 33 30 35 20 31 00	PIP Source	HDMI	
~XX305 2	7E 30 30 33 30 35 20 32 00		VGA 1	
~XX305 3	7E 30 30 33 30 35 20 33 00		Component	
~XX305 5	7E 30 30 33 30 35 20 35 00		VGA 2	
~XX305 6	7E 30 30 33 30 35 20 36 00		BNC	
~XX305 7	7E 30 30 33 30 35 20 37 00		S-Video	
~XX305 8	7E 30 30 33 30 35 20 38 00		Video	
~XX306 1	7E 30 30 33 30 36 20 31 00	PIP SWAP		
~XX70 1	7E 30 30 37 30 20 31 00	Language	English	
~XX70 2	7E 30 30 37 30 20 32 00		German	
~XX70 3	7E 30 30 37 30 20 33 00		French	
~XX70 4	7E 30 30 37 30 20 34 00		Italian	
~XX70 5	7E 30 30 37 30 20 35 00		Spanish	
~XX70 6	7E 30 30 37 30 20 36 00		Portuguese	
~XX70 7	7E 30 30 37 30 20 37 00		Polish	
~XX70 8	7E 30 30 37 30 20 38 00		Dutch	
~XX70 9	7E 30 30 37 30 20 39 00		Swedish	
~XX70 10	7E 30 30 37 30 20 31 30 00		Norwegian/Danish	
~XX70 11	7E 30 30 37 30 20 31 31 00		Finnish	
~XX70 12	7E 30 30 37 30 20 31 32 00		Greek	
~XX70 13	7E 30 30 37 30 20 31 33 00		Traditional Chinese	
~XX70 14	7E 30 30 37 30 20 31 34 00		Simplified Chinese	
~XX70 16	7E 30 30 37 30 20 31 36 00		Korean	
~XX70 17	7E 30 30 37 30 20 31 37 00		Russian	
~XX70 18	7E 30 30 37 30 20 31 38 00		Hungarian	
~XX70 19	7E 30 30 37 30 20 31 39 00		Czech	
~XX70 20	7E 30 30 37 30 20 32 30 00		Arabic	
~XX70 21	7E 30 30 37 30 20 32 31 00		Thai	
~XX70 22	7E 30 30 37 30 20 32 32 00		Turkish	
~XX70 23	7E 30 30 37 30 20 32 33 00		Farsi	
~XX70 25	7E 30 30 37 30 20 32 35 00		Vietnamese	
~XX71 1	7E 30 30 37 31 20 31 00	Projection	Front-Desktop	
~XX71 2	7E 30 30 37 31 20 32 00		Rear-Desktop	
~XX71 3	7E 30 30 37 31 20 33 00		Front-Ceiling	
~XX71 4	7E 30 30 37 31 20 34 00		Rear-Ceiling	
~XX72 1	7E 30 30 37 32 20 31 00	Menu Location	Top Left	
~XX72 2	7E 30 30 37 32 20 32 00		Top Right	
~XX72 3	7E 30 30 37 32 20 33 00		Center	
~XX72 4	7E 30 30 37 32 20 34 00		Bottom Left	
~XX72 5	7E 30 30 37 32 20 35 00		Bottom Right	
~XX91 1	7E 30 30 39 31 20 31 00	Signal	Automatic On	
~XX91 0	7E 30 30 39 31 20 30 00		Automatic Off	
~XX73 n	7E 30 30 37 33 20 a 00		Frequency	n = 0 (a=30) ~ 100(a=31 30 30)
~XX74 n	7E 30 30 37 34 20 a 00		Phase	n = -50 (a=2D 35 30) ~ 50(a=35 30)
~XX75 n	7E 30 30 37 35 20 a 00		H. Position	n = -50 (a=2D 35 30) ~ 50(a=35 30)
~XX76 n	7E 30 30 37 36 20 a 00		V. Position	n = -50 (a=2D 35 30) ~ 50(a=35 30)
~XX200 n	7E 30 30 32 30 30 20 a 00		White Level	n = -50 (a=2D 35 30) ~ 50(a=35 30)
~XX201 n	7E 30 30 32 30 31 20 a 00		Black Level	n = -50 (a=2D 35 30) ~ 50(a=35 30)
~XX202 n	7E 30 30 32 30 32 20 a 00		Saturation	n = -50 (a=2D 35 30) ~ 50(a=35 30)
~XX203 n	7E 30 30 32 30 33 20 a 00		Hue	n = -50 (a=2D 35 30) ~ 50(a=35 30)
~XX204 1	7E 30 30 32 30 34 20 31 00		IRE 0	

Appendices

~XX204 0	7E 30 30 32 30 34 20 30 0D		IRE 7.5		
~XX77 n	7E 30 30 37 37 20 aabccc 0D	Security	Security Timer		n=mm/dd/hh mm= 01 (aa = 30 31) ~ 12 (bb = 31 32) dd= 01 (aa = 30 31) ~ 31 (bb = 33 31) hh= 00 (aa = 30 30) ~ 24 (bb = 32 34)
~XX78 1	7E 30 30 37 38 20 31 0D		On		
~XX78 0 ~nnnn	7E 30 30 37 38 20 30 20 a 0D		Off		~nnnn = ~0000 (a=7E 30 30 30) - ~9999(a=7E 39 39 39 39) n = 00 (a=30 30) ~ 99 (a=39 39)
~XX79 n	7E 30 30 37 39 20 a 0D	Project ID	On		
~XX310 1	7E 30 30 33 31 30 20 31 0D	Internal Speaker	On		
~XX310 0	7E 30 30 33 31 30 20 30 0D		Off		
~XX80 1	7E 30 30 38 30 20 31 0D	Mute	On		
~XX80 0	7E 30 30 38 30 20 30 0D		Off		n = 00 (a=30 30) ~ 10 (a=31 30)
~XX81 n	7E 30 30 38 30 20 a 0D	Volume	Default		
~XX89 0	7E 30 30 38 39 20 30 0D	Audio Input	Audio 1		
~XX89 1	7E 30 30 38 39 20 31 0D		Audio 2		
~XX89 2	7E 30 30 38 39 20 32 0D		Audio 3		
~XX89 3	7E 30 30 38 39 20 33 0D		Optoma		
~XX82 1	7E 30 30 38 32 20 31 0D	Logo	User		
~XX82 2	7E 30 30 38 32 20 32 0D		Neutral		
~XX82 3	7E 30 30 38 32 20 33 0D				
~XX83 1	7E 30 30 38 33 20 31 0D	Logo Capture	CC1		
~XX88 1	7E 30 30 38 38 20 31 0D	Closed Captioning	CC2		
~XX88 2	7E 30 30 38 38 20 32 0D		Off		
~XX88 0	7E 30 30 38 38 20 30 0D		Lock		
~XX84 1	7E 30 30 38 34 20 31 0D	Len Shift	Unlock		
~XX84 2	7E 30 30 38 34 20 32 0D		Up		
~XX84 3	7E 30 30 38 34 20 33 0D		Down		
~XX84 4	7E 30 30 38 34 20 34 0D		Left		
~XX84 5	7E 30 30 38 34 20 35 0D		Right		
~XX84 6	7E 30 30 38 34 20 36 0D		Lock		
~XX85 1	7E 30 30 38 35 20 31 0D	Zoom/Focus	Unlock		
~XX85 2	7E 30 30 38 35 20 32 0D		Zoom+		
~XX307 1	7E 30 30 33 30 37 20 31 0D	Zoom	Zoom+		
~XX307 2	7E 30 30 33 30 37 20 32 0D		Zoom-		
~XX308 1	7E 30 30 33 30 38 20 31 0D	Focus	Focus+		
~XX308 2	7E 30 30 33 30 38 20 32 0D		Focus-		
~XX90 1	7E 30 30 39 30 20 31 0D	Screen Type	16:10		
~XX90 0	7E 30 30 39 30 20 30 0D		16:9		
~XX100 1	7E 30 30 31 30 30 20 31 0D	Source Lock	On		
~XX100 0	7E 30 30 31 30 30 20 30 0D		Off		
~XX101 1	7E 30 30 31 30 31 20 31 0D	High Altitude	On		
~XX101 0	7E 30 30 31 30 31 20 30 0D		Off		
~XX102 1	7E 30 30 31 30 32 20 31 0D	Information Hide	On		
~XX102 0	7E 30 30 31 30 32 20 30 0D		Off		
~XX103 1	7E 30 30 31 30 33 20 31 0D	Keypad Lock	On		
~XX103 0	7E 30 30 31 30 33 20 30 0D		Off		
~XX192 1	7E 30 30 31 39 32 20 31 0D	12V Trigger	On		
~XX192 0	7E 30 30 31 39 32 20 30 0D		Off		
~XX195 0	7E 30 30 31 39 35 20 30 0D	Test Pattern	None		
~XX195 1	7E 30 30 31 39 35 20 31 0D		Grid		
~XX195 2	7E 30 30 31 39 35 20 32 0D		White		
~XX104 1	7E 30 30 31 30 34 20 31 0D	Background Color	Blue		
~XX104 2	7E 30 30 31 30 34 20 32 0D		Black		
~XX104 3	7E 30 30 31 30 34 20 33 0D		Red		
~XX104 4	7E 30 30 31 30 34 20 34 0D		Green		
~XX104 5	7E 30 30 31 30 34 20 35 0D		White		
~XX325 1	7E 30 30 33 32 35 20 31 0D	Shutter	On		
~XX325 0	7E 30 30 33 32 35 20 30 0D		Off		
~XX105 1	7E 30 30 31 30 35 20 31 0D	Direct Power On	On		
~XX105 0	7E 30 30 31 30 35 20 30 0D		Off		
~XX113 1	7E 30 30 31 31 33 20 31 0D	Signal Power On	On		
~XX113 0	7E 30 30 31 31 33 20 30 0D		Off		
~XX105 n	7E 30 30 31 30 36 20 a 0D	Auto Power Off (min)			n = 0 (a=30) ~ 180 (a=31 38 30)
~XX107 n	7E 30 30 31 30 37 20 a 0D	Sleep Timer (min)			n = 000 (a=30 30 30) ~ 995 (a=39 39 35)
~XX114 1	7E 30 30 31 31 34 20 31 0D	Power Mode (Standby)	Active		
~XX114 0	7E 30 30 31 31 34 20 30 0D		Eco		
~XX108 1	7E 30 30 31 30 38 20 31 0D	Lamp Hour			
~XX109 1	7E 30 30 31 30 39 20 31 0D	Lamp Reminder	On		
~XX109 0	7E 30 30 31 30 39 20 30 0D		Off		
~XX110 1	7E 30 30 31 31 30 20 31 0D	Brightness Mode	Bright		
~XX110 2	7E 30 30 31 31 30 20 32 0D		Eco		
~XX110 3	7E 30 30 31 31 30 20 33 0D		Image AI		
~XX111 1	7E 30 30 31 31 31 20 31 0D	Lamp Reset	Yes		
~XX111 2	7E 30 30 31 31 31 20 32 0D		No		
~XX309 1	7E 30 30 33 30 39 20 31 0D	VGA Out	Auto		
~XX309 2	7E 30 30 33 30 39 20 32 0D		VGA 1		
~XX309 3	7E 30 30 33 30 39 20 33 0D		VGA 2		
~XX112 1	7E 30 30 31 31 32 20 31 0D	Reset	Yes		
~XX112 2	7E 30 30 31 31 32 20 32 0D		No		
~XX112 1 1	7E 30 30 31 31 32 31 20 31 0D	Lamp/Temp./Fan Error Reset			

Appendices

SEND from projector automatically

232 ASCII Code	HEX Code	Function	Projector Return	Description
		System Status	INFOa	a : 0 / 1 / 2 / 3 / 4 / 5 / 6 / 7 / 8 = Standby / Warming up / Cooling Down / Out of Range / Lamp Fail / Thermal Switch Error / Fan Lock / Over Temperature / Lamp Hours Running Out

READ from projector

232 ASCII Code	HEX Code	Function	Projector Return	Description
~X87 1	7E 30 30 38 37 20 31 0D	Network State	Oka	a : 0 / 1 = Disconnected / Connect
~X87 3	7E 30 30 38 37 20 33 0D	IP Address	Okaaa_bbb_ccc_ddd	
~XX121 1	7E 30 30 31 32 31 20 31 0D	Input Source	Oka	a : 0 / 1 / 2 / 3 / 4 / 5 / 6 / 7 / 11 / 12 / 13 / 14 = None / DVI / VGA 1 / VGA 2 / S-Video / Video / BNC / HDMI / Component / Flash Drive / Presenter / USB Display
~XX122 1	7E 30 30 31 32 32 20 31 0D	Software Version	Oka	a : Software Version
~XX123 1	7E 30 30 31 32 33 20 31 0D	Display Mode	Oka	a : 0 / 1 / 2 / 3 / 4 / 5 / 7 / 8 / 9 / 12 = None / Presentation / Bright / Movie / sRGB / User / ISF Day & Blackboard / ISF Night & Class room / 3D / DICOM SIM.
~XX124 1	7E 30 30 31 32 34 20 31 0D	Power State	Oka	a : 0 / 1 = Off / On
~XX125 1	7E 30 30 31 32 35 20 31 0D	Brightness	Oka	
~XX126 1	7E 30 30 31 32 36 20 31 0D	Contrast	Oka	
~XX127 1	7E 30 30 31 32 37 20 31 0D	Aspect Ratio	Oka	a : 1 / 2 / 3 / 5 / 6 / 7 = 4:3 / 16:9-I / 16:9-II(16:10) / LBX / Native / Auto
~XX128 1	7E 30 30 31 32 38 20 31 0D	Color Temperature	Oka	a : 0 / 1 / 2 = Warm / Medium / Cold
~XX129 1	7E 30 30 31 32 39 20 31 0D	Projection Mode	Oka	a : 0 / 1 / 2 / 3 = Front-Desktop / Rear-Desktop / Front-Ceiling / Rear-Ceiling
~XX150 1	7E 30 30 31 35 30 20 31 0D	Information	Okabbbbccddddee	a : 0/1 = Off/On bbb : Lamp Hour cc : source 0 / 1 / 2 / 3 / 4 / 5 / 6 / 7 / 10 / 11 / 12 / 13 = None / DVI / VGA1 / VGA2 / S-Video / Video / BNC / HDMI / Component / Flash Drive / Presenter / USB Display ddd : FW version ee : 0 / 1 / 2 / 3 / 4 / 5 / 7 / 8 / 9 / 10 = None / Presentation / Bright / Movie / sRGB / User / ISF Day & Blackboard / ISF Night & Class room / 3D / DICOM SIM.
~XX151 1	7E 30 30 31 35 31 20 31 0D	Model name	Oka	a : 1 / 2 / 3 / 4 = EX850 / EX855 / EW860 / EW865
~XX152 1	7E 30 30 31 35 32 20 31 0D	RS232 Version	Oka	a : RS232 Version

Ceiling Mount Installation

1. To prevent damage to your projector, please use the Optoma ceiling mount.
2. If you wish to use a third party ceiling mount kit, please ensure the screws used to attached a mount to the projector met the following specifications:
 - ▶ Screw type: M8*4
 - ▶ Recommended screw length: 10mm



❖ Please note that damage resulting from incorrect installation will invalidate the warranty.



Warning:

1. If you buy a ceiling mount from another company, please be sure to use the correct screw size. Screw size will vary depending on the thickness of the mounting plate.
2. Be sure to keep at least 10cm gap between the ceiling and the bottom of the projector.
3. Avoid installing the projector near a heat source.

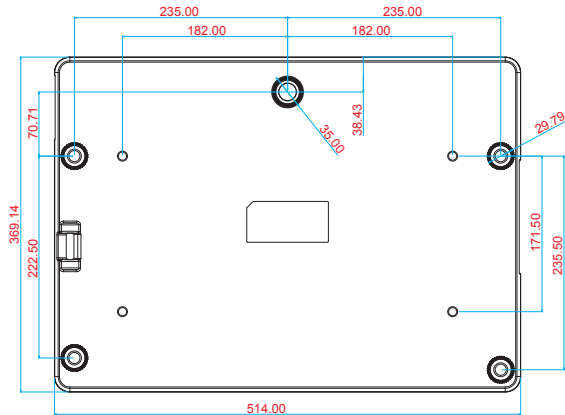



Unit: mm

Optoma Global Offices

For service or support please contact your local office.



USA

3178 Laurelview Ct.
Fremont, CA 94538, USA
www.optomausa.com

 888-289-6786
 510-897-8601
 services@optoma.com



Canada

2420 Meadowpine Blvd., Suite #105
Mississauga, ON, L5N 6S2, Canada
www.optoma.ca

 888-289-6786
 510-897-8601
 services@optoma.com



Latin America

3178 Laurelview Ct.
Fremont, CA 94538, USA
www.optomausa.com

 888-289-6786
 510-897-8601
 services@optoma.com



Europe

42 Caxton Way, The Watford Business Park Watford, Hertfordshire, WD18 8QZ, UK
www.optoma.eu
Service Tel: +44 (0)1923 691865

 +44 (0) 1923 691 800
 +44 (0) 1923 691 888
 service@tsc-europe.com



Benelux BV

Randstad 22-123
1316 BW Almere
The Netherlands
www.optoma.nl

 +31 (0) 36 820 0253
 +31 (0) 36 548 9052



France

Bâtiment E
81-83 avenue Edouard Vaillant
92100 Boulogne Billancourt, France

 +33 1 41 46 12 20
 +33 1 41 46 94 35
 savoptoma@optoma.fr

Spain

C/ José Hierro,36 Of. 1C 28522
Rivas Vaciamadrid,
Spain

 +34 91 499 06 06
 +34 91 670 08 32

Deutschland

Wiesenstrasse 21 W
D40549 Düsseldorf,
Germany

+49 (0) 211 506 6670
+49 (0) 211 506 66799
info@optoma.de

Scandinavia

Lerpeveien 25
3040 Drammen
Norway

+47 32 98 89 90
+47 32 98 89 99
info@optoma.no

PO.BOX 9515
3038 Drammen
Norway

Korea

WOOMI TECH.CO.,LTD.
4F, Minu Bldg. 33-14, Kangnam-Ku,
seoul,135-815, KOREA

+82+2+34430004
+82+2+34430005

Japan

東京都足立区綾瀬3-25-18
株式会社オーエス
コンタクトセンター: 0120-380-495

info@os-worldwide.com
www.os-worldwide.com

Taiwan

5F., No. 108, Minchiuan Rd.
Shindian City,
Taipei Taiwan 231, R.O.C.
www.optoma.com.tw

+886-2-2218-2360
+886-2-2218-2313
services@optoma.com.tw
asia.optoma.com

Hong Kong

Unit A, 27/F Dragon Centre,
79 Wing Hong Street,
Cheung Sha Wan,
Kowloon, Hong Kong

+852-2396-8968
+852-2370-1222
www.optoma.com.hk

China

5F, No. 1205, Kaixuan Rd.,
Changning District
Shanghai, 200052, China

+86-21-62947376
+86-21-62947375
www.optoma.com.cn

Regulation & Safety Notices

This appendix lists the general notices of your projector.

FCC Notice

This device has been tested and found to comply with the limits for a Class A digital device pursuant to Part 15 of the FCC rules. These limits are designed to provide reasonable protection against harmful interference in a residential installation. This device generates, uses and can radiate radio frequency energy and, if not installed and used in accordance with the instructions, may cause harmful interference to radio communications.

However, there is no guarantee that interference will not occur in a particular installation. If this device does cause harmful interference to radio or television reception, which can be determined by turning the device off and on, the user is encouraged to try to correct the interference by one or more of the following measures:

- ❖ Reorient or relocate the receiving antenna.
- ❖ Increase the separation between the device and receiver.
- ❖ Connect the device into an outlet on a circuit different from that to which the receiver is connected.
- ❖ Consult the dealer or an experienced radio/television technician for help.

Notice: Shielded cables

All connections to other computing devices must be made using shielded cables to maintain compliance with FCC regulations.

Caution

Changes or modifications not expressly approved by the manufacturer could void the user's authority, which is granted by the Federal Communications Commission, to operate this projector.

Operation Conditions

This device complies with Part 15 of the FCC Rules. Operation is subject to the following two conditions:

1. This device may not cause harmful interference and
2. This device must accept any interference received, including interference that may cause undesired operation.

Notice: Canadian users

This Class A digital apparatus complies with Canadian ICES-003.

Remarque à l'intention des utilisateurs canadiens

Cet appareil numérique de la classe A est conforme à la norme NMB-003 du Canada.

Declaration of Conformity for EU countries

- EMC Directive 2004/108/EC (including amendments)
- Low Voltage Directive 2006/95/EC
- R & TTE Directive 1999/5/EC (if product has RF function)



Disposal instructions

Do not throw this electronic device into the trash when discarding. To minimize pollution and ensure utmost protection of the global environment, please recycle it.

