



Table of Contents

Table of Contents	1	SETUP.....	38
Usage Notice	2	SETUP Signal (RGB).....	41
Safety Information.....	2	SETUP Security.....	42
Precautions.....	3	SETUP Advanced.....	44
Eye Safety Warnings	5	SETUP Network.....	45
Product Features	5	OPTIONS.....	50
Introduction.....	6	OPTIONS Advanced.....	52
Package Overview.....	6	OPTIONS Lamp Settings.....	53
Product Overview	7	OPTIONS PointBlank	54
Main Unit.....	7	Ruby Introduction.....	56
Control Panel.....	8	How to use Web Control	56
Input/Output Connections.....	9	How to use the Card Reader	63
Remote Control.....	10	How to use the Optoma Presenter	66
Interactive Pen.....	11	Appendices.....	70
Installation	12	Troubleshooting	70
Connecting the Projector	12	Replacing the lamp	76
Removing and Attaching the Cable		Replacing and cleaning the optional	
Cover.....	12	dust filter	78
Connect to Computer/Notebook	13	Compatibility Modes	79
Connect to Video Sources.....	14	Computer Compatibility	79
Powering the projector On / Off	15	Video Compatibility.....	80
Powering On the Projector.....	15	RS232 Commands and Protocol	
Powering Off the Projector.....	16	Function List	81
Warning Indicator.....	16	RS232 Pin Assignments	81
Adjusting the Projected Image.....	17	RS232 Protocol Function List	82
Adjusting the Projector's Height	17	Wall Mount Installation.....	86
Adjusting the Projector's Focus.....	18	Optoma Global Offices	87
Adjusting Projection Image Size	18	Regulation & Safety Notices	89
User Controls	20		
Control Panel & Remote Control	20		
Control Panel.....	20		
Remote Control.....	21		
Interactive Pen.....	22		
On-screen Display Menus	26		
How to operate	26		
Menu Tree.....	27		
IMAGE.....	30		
IMAGE Advanced	32		
DISPLAY.....	34		
DISPLAY 3D	37		

Safety Information

	The lightning flash with arrow head within an equilateral triangle is intended to alert the user to the presence of uninsulated "dangerous voltage" within the product's enclosure that may be of sufficient magnitude to constitute a risk of electric shock to persons.
	The exclamation point within an equilateral triangle is intended to alert the user to the presence of important operating and maintenance (servicing) instructions in the literature accompanying the appliance.

WARNING: TO REDUCE THE RISK OF FIRE OR ELECTRIC SHOCK, DO NOT EXPOSE THIS APPLIANCE TO RAIN OR MOISTURE. DANGEROUS HIGH VOLTAGES ARE PRESENT INSIDE THE ENCLOSURE. DO NOT OPEN THE CABINET. REFER SERVICING TO QUALIFIED PERSONNEL ONLY.

Class B emissions limits

This Class B digital apparatus meets all requirements of the Canadian Interference-Causing Equipment Regulations.

Important Safety Instruction

1. Do not block any ventilation openings. To ensure reliable operation of the projector and to protect from over heating, it is recommended to install the projector in a location that does not block ventilation. As an example, do not place the projector on a crowded coffee table, sofa, bed, etc. Do not put the projector in an enclosure such as a book case or a cabinet that restricts air flow.
2. Do not use the projector near water or moisture. To reduce the risk of fire and/or electric shock, do not expose the projector to rain or moisture.
3. Do not install near heat sources such as radiators, heaters, stoves or any other apparatus such as amplifiers that emits heat.
4. Clean only with dry cloth.
5. Only use attachments/accessories specified by the manufacturer.
6. Do not use the unit if it has been physically damaged or abused.
Physical damage/abuse would be (but not limited to):
 - Unit has been dropped.
 - Power supply cord or plug has been damaged.
 - Liquid has been spilled on to the projector.
 - Projector has been exposed to rain or moisture.
 - Something has fallen in the projector or something is loose inside.Do not attempt to service the unit yourself. Opening or removing covers may expose you to dangerous voltages or other hazards. Please call Optoma before you send the unit for repair.
7. Do not let objects or liquids enter the projector. They may touch dangerous voltage points and short out parts that could result in fire or electric shock.
8. See projector enclosure for safety related markings.
9. The unit should only be repaired by appropriate service personnel.

Precautions



Please follow all warnings, precautions and maintenance as recommended in this user's guide.

- Warning- Do not look into the projector's lens when the lamp is on. The bright light may hurt and damage your eyes.
- Warning- To reduce the risk of fire or electric shock, do not expose this projector to rain or moisture.
- Warning- Please do not open or disassemble the projector as this may cause electric shock.
- Warning- When replacing the lamp, please allow the unit to cool down. Follow instructions as described on pages 76-77.
- Warning- This projector will detect the life of the lamp itself. Please be sure to change the lamp when it shows warning messages.
- Warning- Reset the "Lamp Reset" function from the on-screen display "OPTIONS | Lamp Settings" menu after replacing the lamp module (refer to page 53).
- Warning- When switching the projector off, please ensure the cooling cycle has been completed before disconnecting power. Allow 90 seconds for the projector to cool down.
- Warning- Do not use lens cap when projector is in operation.
- Warning- When the lamp is approaching the end of its lifetime, the message "Lamp Warning: Lamp life exceeded." will show on the screen. Please contact your local reseller or service center to change the lamp as soon as possible.
- Warning- Do not look into or point the laser pointer on your remote control into your or someone's eyes. Laser pointer can cause permanent damage to eyesight.



- ❖ When the lamp reaches the end of its life, the projector will not turn back on until the lamp module has been replaced. To replace the lamp, follow the procedures listed under "Replacing the Lamp" section on pages 76-77.

Usage Notice

Do:

- ❖ Turn off and unplug the power plug from the AC outlet before cleaning the product.
- ❖ Use a soft dry cloth with mild detergent to clean the display housing.
- ❖ Disconnect the power plug from AC outlet if the product is not being used for a long period of time.

Do not:

- ❖ Block the slots and openings on the unit provided for ventilation.
- ❖ Use abrasive cleaners, waxes or solvents to clean the unit.
- ❖ Use under the following conditions:
 - In extremely hot, cold or humid environments.
 - ▶ Ensure that the ambient room temperature is within 5 - 35°C.
 - ▶ Relative Humidity is 5 - 35°C, 80% (Max.), non-condensing.
 - In areas susceptible to excessive dust and dirt.
 - Near any appliance generating a strong magnetic field.
 - In direct sunlight.

Eye Safety Warnings



- Avoid staring/facing directly into the projector beam at all times. Keep your back to the beam as much as possible.
- When projector is used in a classroom, adequately supervise students when they are asked to point out something on the screen.
- In order to minimize the lamp power, use room blinds to reduce ambient light levels.

Product Features



❖ Monitor loop through only support in VGA1-In/SCART/YPbPr.

- XGA (1024x768) Native resolution / WXGA (1280x800) Native resolution
- HD compatible – 1080p supported
- VGA monitor loop through (works on standby mode > 1W)
- BrilliantColor™ Technology
- Security Bar and Kensington Lock
- RS232 control
- Rapid shutdown
- Built-in speakers
- Network support
- USB display (Don't support Mac OS)
- Network display (Don't support Windows 7 64bit)

Introduction

Package Overview

Unpack and inspect the box contents to ensure all parts listed below are in the box. If something is missing, please contact your nearest customer service center.

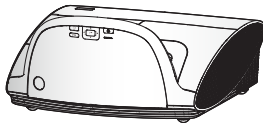

Projector with lens cap

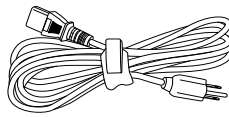

Power Cord 1.8m

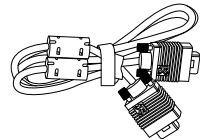

VGA Cable 1.8m

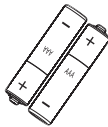

2 × AAA Batteries



IR Remote Control



❖ Due to different applications in each country, some regions may have different accessories.

Documentation :

- User's Manual
- Warranty Card
- Quick Start Card
- WEEE Card
(for EMEA only)

Introduction

Product Overview

Main Unit

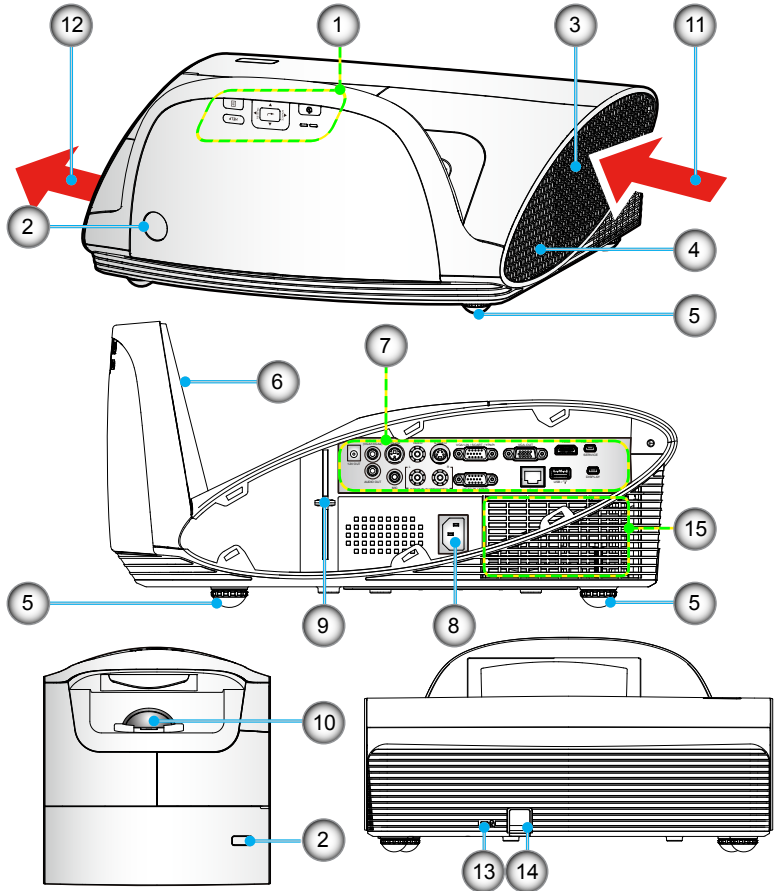

- | | |
|-------------------------------|--|
| 1. Control Panel | 9. Focus Lever |
| 2. IR Receivers | 10. Lens |
| 3. Cable Cover | 11. Ventilation (inlet) |
| 4. Speaker | 12. Ventilation (outlet) |
| 5. Tilt-Adjustment Feet | 13. Kensington™ Lock Port |
| 6. Mirror Cover | 14. Security Bar |
| 7. Input / Output Connections | 15. Compartment for optional dust filter |
| 8. Power Socket | |

Introduction

Control Panel

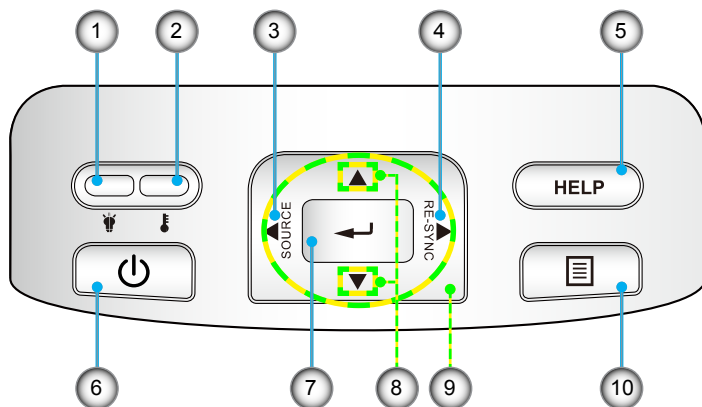

1. Lamp LED
2. Temp LED
3. Source
4. Re-Sync
5. Help
6. Power/Standby button and LED
7. Enter
8. Keystone Correction
9. Four Directional Select Keys
10. Menu

Introduction

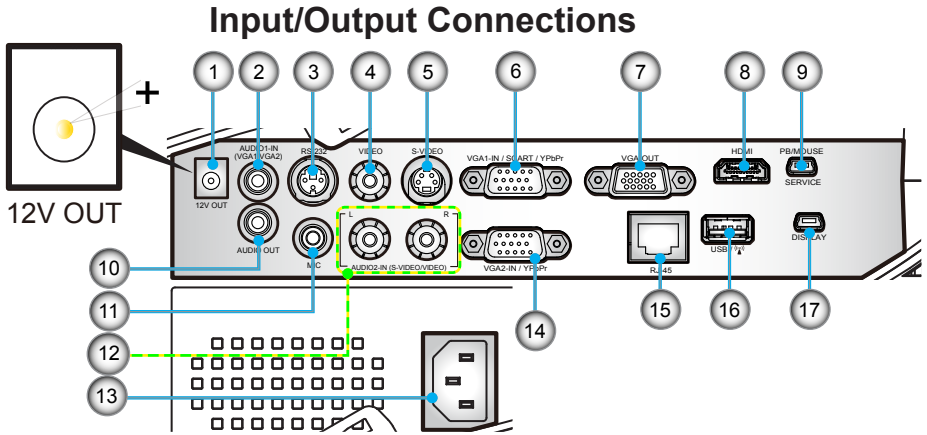

1. 12V Trigger Relay (12V, 250mA)
2. 3.5mm Mini Jack Audio1 Input for VGA1/VGA2
3. 3pin Mini-din RS232
4. Composite Video Input
5. S-Video Input
6. VGA1/SCART/YPbPr Input
7. VGA-Out (monitor loop through)
8. HDMI v1.3 Input
9. 5pin Mini-USB for interactive function and firmware upgrade
10. 3.5mm Audio Output (Variable)
11. 3.5mm Microphone Input
12. Left/Right RCA Audio2 Input
13. Power Socket
14. VGA2/YPbPr Input
15. RJ45
16. USB for Wireless dongle & Thumb drive
17. 5pin Mini-USB for Display

NOTE

- ❖ Monitor loop through only support in VGA1-In/SCART/YPbPr.

Introduction

Remote Control



❖ The interface is subject to model's specifications.

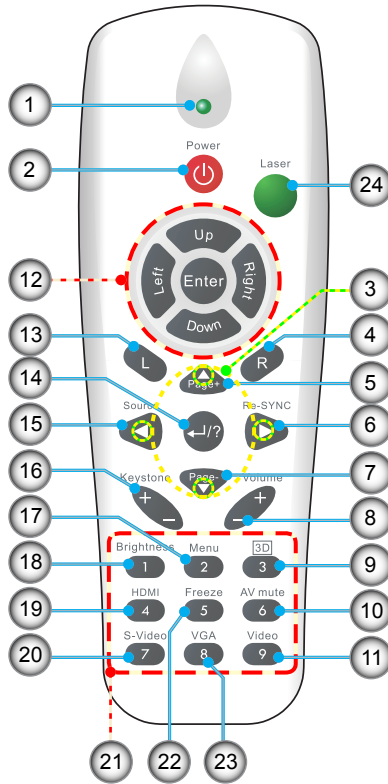

1. LED Indicator
2. Power On/Off
3. Four Directional Select Keys
4. Mouse Right Click
5. Page Up
6. Re-Sync
7. Page Down
8. Volume +/-
9. 3D
10. AV mute
11. Video
12. PC/Mouse control
13. Mouse Left Click
14. Enter/Help
15. Source
16. Keystone +/-
17. Menu
18. Brightness
19. HDMI
20. S-Video
21. Numbered keypad (for password input)
22. Freeze
23. VGA
24. Laser Pointer

Interactive Pen

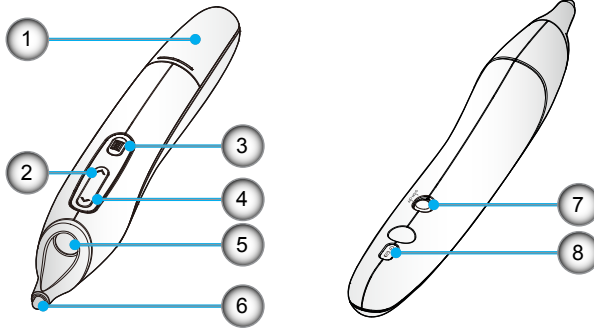

- ❖ The interactive pen is optional accessory.

1. Battery Cover
2. Mouse Right Click
3. Menu
4. Mouse Left Click
5. Lens
6. Nib
7. Power On/Off
8. LED Indicators



- Warning:**
- Danger of explosion if battery is incorrectly replaced.
 - Replace only with the same or equivalent type recommended by the manufacturer.
 - Dispose of used batteries according to your local regulations.
 - Do not mix different types of batteries or new and old batteries.

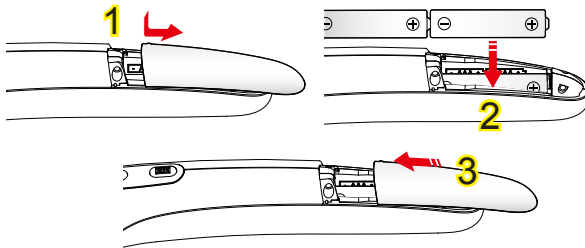

○ Battery Installation:

1. Press firmly and slide the battery cover off. **1**
2. Install new batteries (AAA). Ensure that you have the batteries' polarity (+/-) aligned correctly. **2**
3. Slip the cover back over the batteries until it snaps into place.

Connecting the Projector

Removing and Attaching the Cable Cover

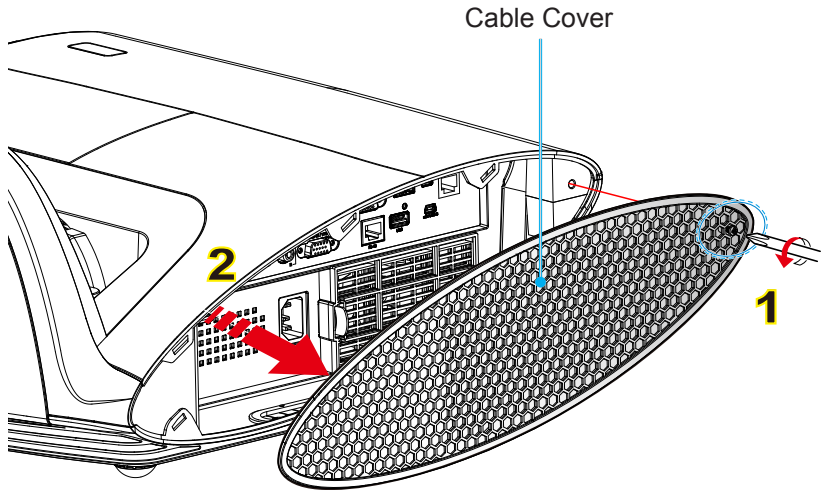

Procedure for Removing and Attaching the Cable Cover:

1. Unscrew the screw on the cable cover. **1**
 2. Lift up and remove the cable cover. **2**
- Install the cable cover by reversing the previous steps.

Installation

Connect to Computer/Notebook

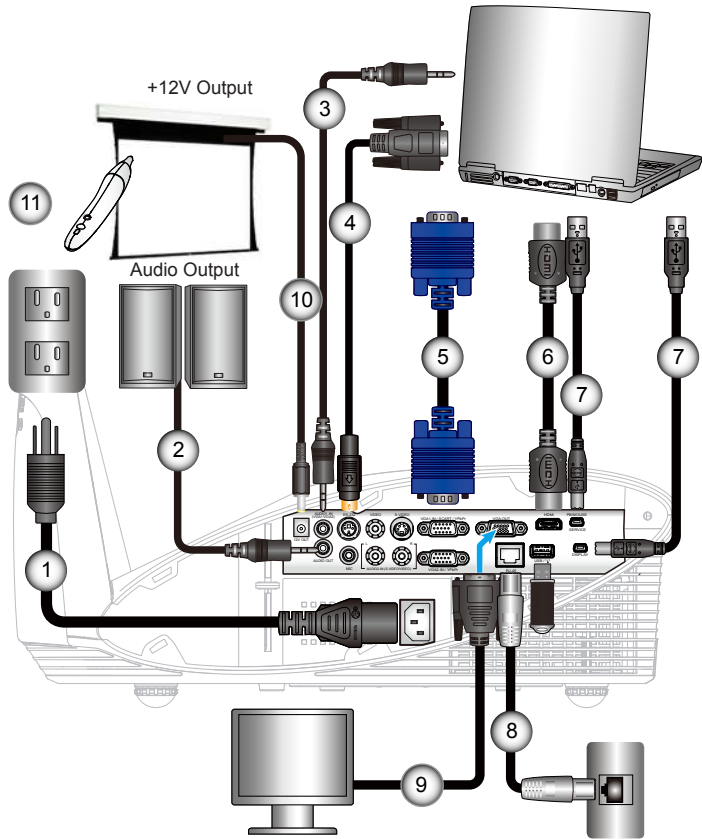

- ❖ Due to the difference in applications for each country, some regions may have different accessories.
- ❖ (*) Optional accessory

- | | |
|---------|---------------------|
| 1..... | Power Cord |
| 2..... | *Audio Output Cable |
| 3..... | *Audio Input Cable |
| 4..... | *RS232 Cable |
| 5..... | VGA Cable |
| 6..... | *HDMI Cable |
| 7..... | *USB Cable |
| 8..... | *Network Cable |
| 9..... | *VGA Output Cable |
| 10..... | *12V DC Plug |
| 11..... | *Interactive Pen |

Installation

Connect to Video Sources

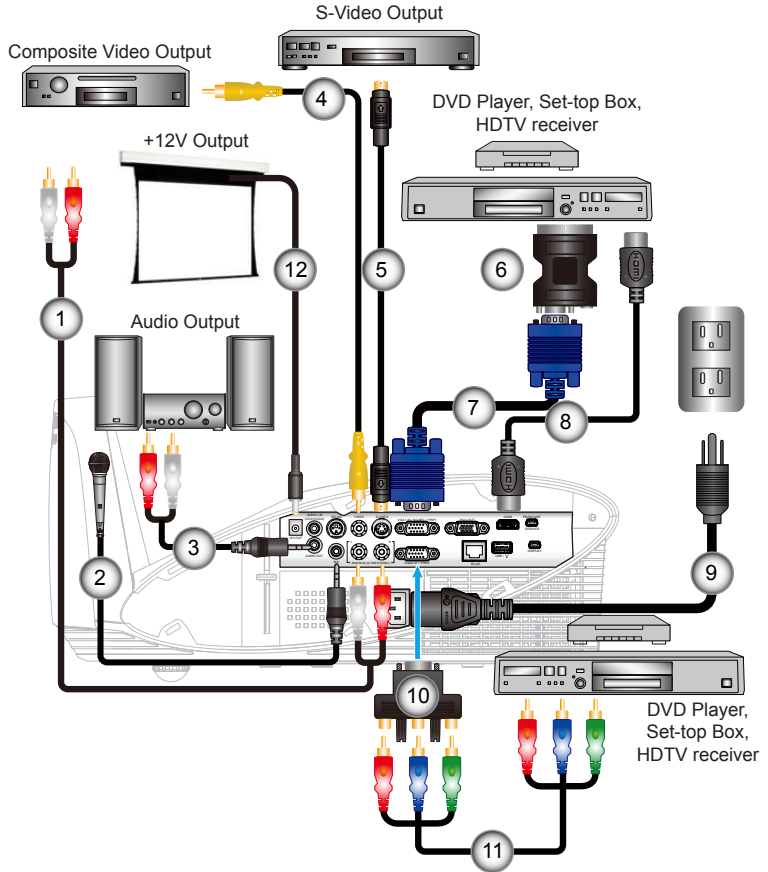

- ❖ Due to the difference in applications for each country, some regions may have different accessories.
- ❖ (*) Optional accessory

1.....	*Audio Cable RCA/RCA
2.....	*Microphone Cable
3.....	*Audio Cable Jack/RCA
4.....	*Composite Video Cable
5.....	*S-Video Cable
6.....	*SCART/VGA Adaptor
7.....	VGA Cable
8.....	*HDMI Cable
9.....	Power Cord
10.....	*15-Pin to 3 RCA Component/HDTV Adaptor
11.....	*3 RCA Component Cable
12.....	*12V DC Plug

Installation

Powering the projector On / Off

Powering On the Projector

1. Securely connect the power cord and signal cable. When connected, the POWER/STANDBY LED will turn Amber.
2. Turn on the lamp by pressing “” button either on the top of the projector or on the remote. The POWER/STANDBY LED will now turn Green.

The startup screen will display in approximately 10 seconds. The first time you use the projector, you will be asked to select the preferred language and power saving mode.

3. Turn on and connect the source that you want to display on the screen (computer, notebook, video player, etc). The projector will detect the source automatically. If not, push menu button and go to “OPTIONS”. Make sure that the “Source Lock” has been set to “Off”.

- ❖ If you connect multiple sources at the same time, press the “SOURCE” button on the control panel or direct source keys on the remote control to switch between inputs.



❖ When Power mode (Standby) is set to Eco (<0.5W), the VGA output, Audio pass-through and RJ45 will be deactivated when the projector is in standby.



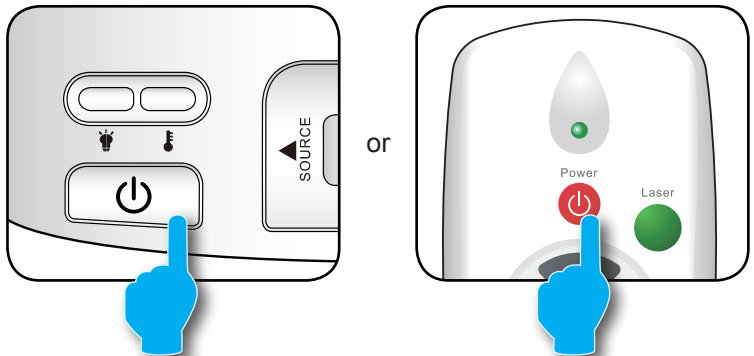

❖ Turn on the projector first and then select the signal sources.

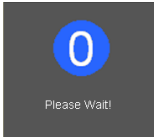
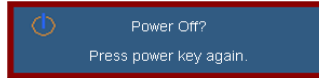

Powering Off the Projector

1. Press the “” button on the remote control or on the control panel to turn off the projector. The following message will be displayed on the screen.



Press the “” button again to confirm otherwise the message will disappear after 15 seconds. When you press the “” button for the second time, the projector will display countdown timer and will shut down.

2. The cooling fans continue to operate for about 10 seconds for cooling cycle and the POWER/STANDBY LED will Flash Green. When the POWER/STANDBY LED lights solid Amber, the projector has entered standby mode.

If you wish to turn the projector back on, you must wait until the projector has completed the cooling cycle and has entered standby mode. Once in standby mode, simply press “” button to restart the projector.

3. Disconnect the power cord from the electrical outlet and the projector.
4. Do not turn on the projector immediately following a power off procedure.

Warning Indicator

When the warning indicators (see below) come on, the projector will automatically shutdown:



❖ Contact the nearest service center if the projector displays these symptoms. See pages 87-88 for more information.

- ❖ “LAMP” LED indicator is lit red and if “POWER/STANDBY” indicator flashes amber.
- ❖ “TEMP” LED indicator is lit red and if “POWER/STANDBY” indicator flashes amber. This indicates the projector has overheated. Under normal conditions, the projector can be switched back on.
- ❖ “TEMP” LED indicator flashes red and if “POWER/STANDBY” indicator flashes amber.

Unplug the power cord from the projector, wait for 30 seconds and try again. If the warning indicator light up again, please contact your nearest service center for assistance.

Adjusting the Projected Image

Adjusting the Projector's Height

The projector is equipped with elevator feet for adjusting the image height.

1. Locate the adjustable foot you wish to modify on the underside of the projector.
2. Rotate the adjustable ring clockwise to raise the projector or counter clockwise to lower it. Repeat with the remaining feet as needed.

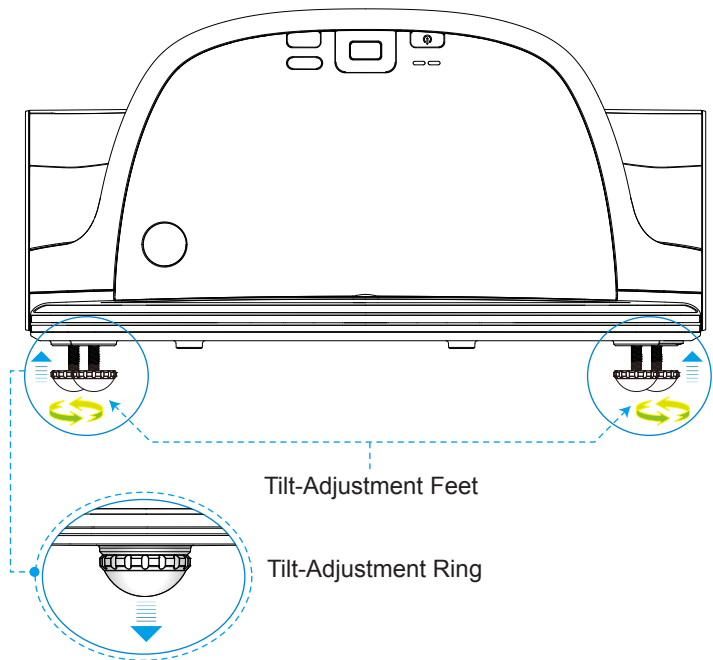

Adjusting the Projector's Focus

To focus the image, rotate the focus ring until the image is clear.

- ▶ XGA series: The projector will focus at distances from 1.58 to 2.17 feet (475 to 662 mm).
- ▶ WXGA series: The projector will focus at distances from 1.58 to 2.17 feet (495 to 661 mm).

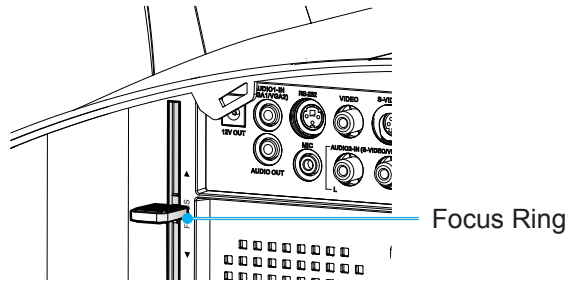

Adjusting Projection Image Size

- ▶ XGA series: Projection Image Size from 63" to 85" (1.60 to 2.16 meters).
- ▶ WXGA series: Projection Image Size from 77" to 100" (1.96 to 2.54 meters).

Installation

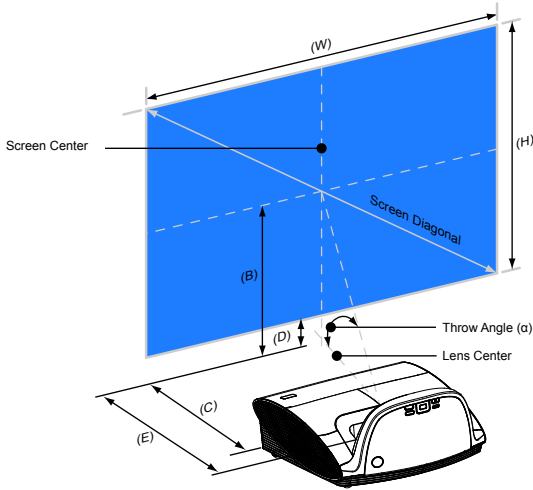

B=>Vertical distance between lens center and screen center

C,E=>Throw distance

D=>Vertical distance between lens center and bottom of screen (top of screen for ceiling mount)

α =>Throw angle

XGA

Screen Size						(B)		(C)		(D)		(E)		(α)
Diagonal		Width (W)		Height (H)										
inch	mm	inch	mm	inch	mm	inch	mm	inch	mm	inch	mm	inch	mm	degree
63	1600	50	1280	38	960	29	749	5	133	11	269	19	475	55.3
65	1651	52	1321	39	991	30	773	6	150	11	277	19	492	55.3
70	1778	56	1422	42	1067	33	832	8	192	12	299	21	534	55.3
75	1905	60	1524	45	1143	35	892	9	235	13	320	23	577	55.3
77	1956	62	1565	46	1173	36	915	10	251	13	329	23	594	55.3
80	2032	64	1626	48	1219	37	951	11	277	13	341	24	619	55.3
85	2159	68	1727	51	1295	40	1010	13	320	14	363	26	662	55.3

WXGA

Screen Size						(B)		(C)		(D)		(E)		(α)
Diagonal		Width (W)		Height (H)										
inch	mm	inch	mm	inch	mm	inch	mm	inch	mm	inch	mm	inch	mm	degree
77	1956	65	1659	41	1037	31	777	6	153	10	259	19	495	55.3
80	2032	68	1723	42	1077	32	808	7	174	11	269	20	516	55.3
85	2159	72	1831	45	1144	34	858	8	214	11	286	22	568	55.3
87.2	2215	74	1878	46	1174	35	880	9	226	12	293	22	569	55.3
90	2286	76	1939	48	1212	36	909	10	246	12	303	23	588	55.3
95	2413	81	2046	50	1279	38	959	11	283	13	320	25	625	55.3
100	2540	85	2154	53	1346	40	1010	13	319	13	337	26	661	55.3



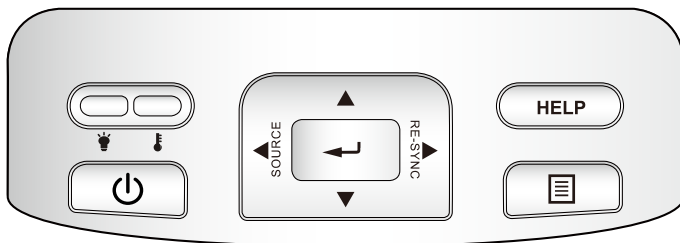

❖ This table is for user's reference only.

Control Panel & Remote Control

Control Panel



Using the Control Panel









Power/ Standby but- ton and LED		Refer to the “Power On/Off the Projector” section on pages 15-16. Indicate the projector’s status.
RE-SYNC		Automatically synchronize the projector to the input source.
Enter		Confirm your item selection.
SOURCE		Press “SOURCE” to select an input signal.
Menu		Press “Menu” to launch the on-screen display (OSD) menu. To exit OSD, Press “Menu” again.
Four Directional Select Keys		Use ▲ ▼ ◀ ▶ to select items or make adjust-ments to your selection.
Keystone		Use ▲ ▼ to adjust image distortion caused by tilting the projector. (±40 degrees)
HELP		Help Menu (refer to page 23).
Lamp LED		Indicate the projector’s lamp status.
Temp LED		Indicate the projector’s temperature status.

User Controls

Remote Control



Using the Remote Control

Power 	Refer to the “Power On/Off the Projector” section on pages 15-16.
L Button	Mouse left click.
R Button	Mouse right click.
Page +	Use this button to page up.
Page -	Use this button to page down.
Enter  / Help ?	 Confirm your item selection.  Help Menu (refer to page 23).
Source	Press “Source” to select an input signal.
Re-SYNC	Automatically synchronizes the projector to the input source.
Four Directional Select Keys	Use     to select items or make adjustments to your selection.
Keystone +/-	Adjust image distortion caused by tilting the projector.
Volume +/-	Adjust to increase / decrease the volume.
Brightness	Adjust the brightness of the image.
3D	Press the “3D” to turn the 3D OSD menu on/off.
Menu	Press “Menu” to launch the on-screen display (OSD) menu. To exit OSD, press “Menu” again.
HDMI	Press “HDMI” to choose HDMI source.
Freeze	Press “Freeze” to pause the screen image. Press this button again to unlock.

User Controls

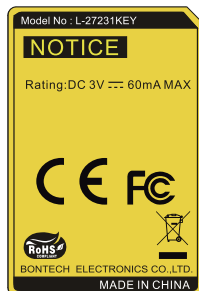

Using the Remote Control

AV mute	Momentarily turns off/on the audio and video.
S-Video	Press “S-Video” to choose S-Video source.
VGA	Press “VGA” to choose VGA sources.
Video	Press “Video” to choose Composite video source.

Interactive Pen

Using the Interactive Pen

ON/OFF	Power On/Off the Interactive Pen.
LED	Indicate the interactive pen’s status.
LED	Indicate the interactive pen’s battery consumption.
Nib	Press the nib to draw or write.
Mouse Left Click	Mouse left click.
Mouse Right Click	Mouse right click.
Menu	Press “Menu” to launch the on-screen display (OSD) menu. To exit OSD, press “Menu” again.

Using the HELP button

The HELP function ensures easy setup and operation.

- ▶ Press the “?” button on the remote control or press the “HELP” button on the control panel to open the Help Menu.

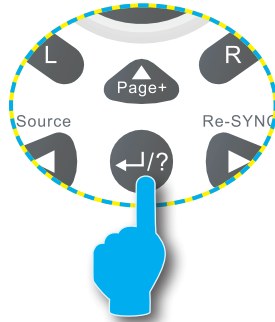

User Controls

- ▶ Help menu button functions only when no input source is detected.



- ❖ Please refer to the “Troubleshooting” section on pages 70-75 for more details.

The screenshot shows a 'HELP' menu with the following content:

HELP

? No Image appears on-screen.

UpDown Select Menu Exit

No Image appears on-screen.

- ▶ Ensure all the cables and power connections are correctly and securely connected as described in the Installation section of User's Manual.
- ▶ Ensure all the pins of connectors are not bent or broken.
- ▶ Ensure that the [AV MUTE] feature is not turned on.

[NEXT]

[Exit]

UpDown Select Menu Exit

No Image appears on-screen.

- ▶ If you are using a Notebook :
 1. First, follow the steps above to adjust resolution of the computer.
 2. Press the toggle output settings. Example : [Fn]+[F4]

Acer ⇨	[Fn]+[F5]	IBM/Lenovo ⇨	[Fn]+[F7]
Asus ⇨	[Fn]+[F8]	HP/Compaq ⇨	[Fn]+[F4]
Dell ⇨	[Fn]+[F8]	NEC ⇨	[Fn]+[F3]
Gateway ⇨	[Fn]+[F4]	Toshiba ⇨	[Fn]+[F5]

Mac Apple :

System Preference ⇨ Display ⇨ Arrangement ⇨ Mirror display

[PREV]

[Exit]

UpDown Select Menu Exit

- ▶ If input source is detected and help button is pressed, the following pages will appear to help diagnose any problems.

The screenshot shows a 'HELP' menu with the following content:

HELP

- ? Image has slanted sides.
- ? Image is too small or too large.
- ? Image is unstable or flickering.
- ? There is no audio heard or the volume is too low.

UpDown Select Menu Exit

User Controls

Image has slanted sides.

- ▶ If possible, reposition the projector so that is centered on the screen and below the bottom of the screen.
- ▶ Press [KEYSTONE + / -] button until the sides are vertical on the remote control.

[KEYSTONE + / -]



[Exit]



UpDown



Select



Menu Exit

Image is too small or too large.

- ▶ Adjust the Zoom Ring on the top of projector.
- ▶ Move the projector closer to or further from the screen.
- ▶ Press [MENU] button on the remote control or projector panel, go to "DISPLAY | Format" and try the different settings.

[DISPLAY | Format]



[Exit]



UpDown



Select



Menu Exit

There is no audio heard or the volume is too low.

- Is the volume setting at the minimum?
 - ▶ Turn up the volume setting.
- Is the cable connected properly to the projector?
 - ▶ Check the physical connection and ensure the cable is connected properly from the source to projector.

[Volume]



[Exit]



UpDown



Select



Menu Exit

Image is unstable or flickering.

- ▶ Use [Phase / Frequency] to correct it.
- ▶ Change the monitor color setting on your computer.

[Phase]

[Frequency]



[Exit]



UpDown



Select



Menu Exit

On-screen Display Menus

The Projector has multilingual On-screen Display menus that allow you to make image adjustments and change a variety of settings.

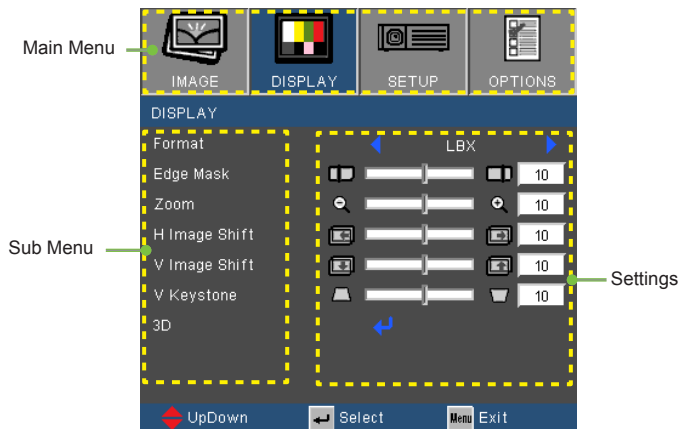

How to operate

1. To open the OSD menu, press “Menu” on the Remote Control or Projector Keypad.
2. When OSD is displayed, use ◀▶ keys to select any item in the main menu. While making a selection on a particular page, press ▼ or “Enter” key to enter sub menu.
3. Use ▲▼ keys to select the desired item and adjust the settings using ◀▶ key.
4. Select the next item to be adjusted in the sub menu and adjust as described above.
5. Press “Enter” to confirm, and the screen will return to the main menu.
6. To exit, press “MENU” again. The OSD menu will close and the projector will automatically save the new settings.



User Controls

Menu Tree

Main Menu	Sub Menu	Settings
Image	Display Mode	Presentation / Bright / Movie / sRGB / Blackboard / Classroom / User / 3D
	Brightness	-50~50
	Contrast	-50~50
	Sharpness	1~15
	^{#1} Color	-50~50
	^{#1} Tint	-50~50
	Advanced	Gamma Film / Video / Graphics / PC
		BrilliantColor™ 0~10
		Color Temp. Warm / Medium / Cold
		Color Settings Red Gain / Green Gain / Blue Gain / Red Bias / Green Bias / Blue Bias / Cyan / Magenta / Yellow / Reset / Exit
		Color Space AUTO / RGB / YUV
		Input Source VGA1 / VGA2 / Video / S-Video / HDMI
		Image AI On / Off
	Exit	
Display	Format	^{#2} 4:3 / 16:9-I / 16:9-II / Native / AUTO
		^{#3} 4:3 / 16:9 or 16:10 / LBX / Native / AUTO
	Edge Mask	0~10
	Zoom	-5~25 (80%~200%)
	H Image Shift	-50~50
	V Image Shift	-50~50
	V Keystone	-40~40
	3D	3D Off / DLP-Link / IR
		^{#4} 3D Sync. Invert On / Off
	Exit	
Setup	Language	English / Deutsch / Français / Italiano / Español / Português / Svenska / Nederlands / Norsk/Dansk / Polski / Suomi / Русский / ελληνικά / Magyar / Čeština / العربية / فارسی / 繁體中文 / 简体中文 / 日本語 / 한국어 / 越南 / Türkçe / Việt / Bahasa Indonesia
	^{#5} Screen Type	16:10 / 16:9
	Projection	
	Menu Location	
	^{#6} Signal	Automatic On / Off
		Phase (VGA) 0~31
		Frequency (VGA) -5~5
		H. Position (VGA) -5~5
		V. Position (VGA) -5~5
		Exit
	Security On / Off	
	Security Timer Month / Day / Hour	
	Change Password	
	Exit	

User Controls

Main Menu	Sub Menu	Settings	
Setup	Projector ID	0~99	
	Mute	On / Off	
	Volume	0~10	
	Audio Input	** Default / Audio1(Phone jack) / Audio2 (RCA R/L)	
	Advanced	Logo	Optima / Neutral / User
		Logo Capture	
		Closed Captioning	Off / CC1 / CC2
	Network	Exit	
		Network State	
		DHCP	
		IP Address	
		Subnet mask	
		Gateway	
		DNS	
		Apply	Yes / No
	Exit		
	Options	Source Lock	On / Off
High Altitude		On / Off	
Information Hide		On / Off	
Keypad Lock		On / Off	
Background Color		Black / Red / Blue / Green / White	
IR Receiver		Front Receiver	On / Off
		Top Receiver	On / Off
Advanced		Direct Power On	On / Off
		Auto Power Off (min.)	0~180
		Sleep Timer (min.)	0~995
		Power Mode (Standby)	Eco. / Active
		Exit	
Lamp Settings		Lamp Hours	
		Lamp Reminder	On / Off
		Brightness Mode	STD / Bright / Image AI
		Lamp Reset	Yes / No
		Exit	
Optional Filter Installed		Yes / No	
Reset Filter Warning		Yes / No	
PointBlank		Interactive	On / Off
		Dual Pen	On / Off
		Pointer Motion	Normal / Draw / Stable
		Click Speed	Fast / Medium / Low
	Set function	Pointer Motion / PowerPoint Annotation / Switch Windows (Alt+Tab) / Esc / Show Desktop (Cmd+D) / Open Window Explorer (Cmd+E) / Double Click / Disable	
	Channel	Automatic / Channel	
	Information		
	Exit		
Reset			

User Controls



- ❖ Please note that the on-screen display (OSD) menus vary according to the signal type selected and the projector model you are using.
- ❖ (#1) "Color" and "Tint" are only supported in Video mode.
- ❖ (#2) For XGA model only.
- ❖ (#3) For WXGA model only. 16:9 or 16:10 depend on "Screen Type" setting.
- ❖ (#4) "3D Sync Invert" is only available when 3D is enabled.
- ❖ (#5) "Signal" is only supported in Analog VGA (RGB) signal.
- ❖ (#6) MIC volume can also be controlled by "Setup → Volume" in OSD.
- ❖ When PoinkBlank is enable, "Display Mode" only support "Presentation", "Bright", "User" and "3D" mode.

IMAGE

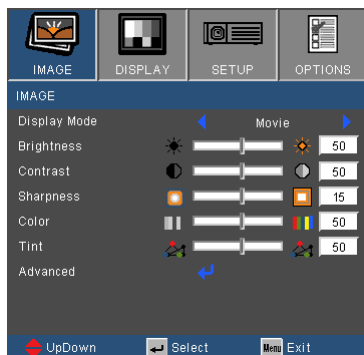

Display Mode

There are many factory presets optimized for various types of images.

- ▶ Presentation: Good color and brightness from PC input.
- ▶ Bright: Maximum brightness from PC input.
- ▶ Movie: For home theater.
- ▶ sRGB: Standardised accurate color.
- ▶ Blackboard: This mode should be selected to achieve optimum color settings when projecting onto a blackboard (green).
- ▶ Classroom: This mode is recommended for projecting in a classroom.
- ▶ User: User's settings.
- ▶ 3D: Recommend setting for 3D mode enabled. Any further adjustments by the user in 3D will be saved in this mode for further use.

Brightness

Adjust the brightness of the image.

- ▶ Press the ◀ to darken image.
- ▶ Press the ▶ to lighten the image.

Contrast

The contrast controls the degree of difference between the lightest and darkest parts of the picture.

- ▶ Press the ◀ to decrease the contrast.
- ▶ Press the ▶ to increase the contrast.



❖ “Color” and “Tint” functions are only supported under Video mode.

Sharpness

Adjust the sharpness of the image.

- ▶ Press the ◀ to decrease the sharpness.
- ▶ Press the ▶ to increase the sharpness.

Color

Adjust a video image from black and white to fully saturated color.

- ▶ Press the ◀ to decrease the amount of saturation in the image.
- ▶ Press the ▶ to increase the amount of saturation in the image.

Tint

Adjust the color balance of red and green.

- ▶ Press the ◀ to increase the amount of green in the image.
- ▶ Press the ▶ to increase the amount of red in the image.

IMAGE | Advanced

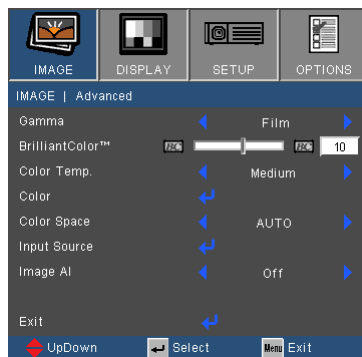

Gamma

This allows you to choose a degamma table that has been fine-tuned to bring out the best image quality for the input.

- ▶ Film: for home theater.
- ▶ Video: for video or TV source.
- ▶ Graphics: for image source.
- ▶ PC: for PC or computer source.

BrilliantColor™

This adjustable item utilizes a new color-processing algorithm and system level enhancements to enable higher brightness while providing true, more vibrant colors in picture. The range is from “0” to “10”. If you prefer a stronger enhanced image, adjust toward the maximum setting. For a smoother, more natural image, adjust toward the minimum setting.

Color Temp

If set to cold temperature, the image looks more blue. (cold image)
If set to warm temperature, the image looks more red.
(warm image)

Color Settings

Press **↵** into the next menu as below and then use **▲** or **▼** to select item.

- ▶ Red Gain/Green Gain/Blue Gain/Red Bias/Green Bias/Blue Bias/Cyan/Magenta/Yellow: Use **◀** or **▶** to select Red, Green, Blue, Cyan, Magenta and Yellow Colors.
- ▶ Reset: Choose “Yes” to return the factory default settings for color adjustments.

User Controls

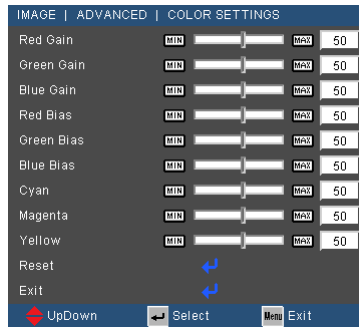

Color Space

Select an appropriate color matrix type from AUTO, RGB or YUV.

Input Source

Use this option to enable / disable input sources. Press  to enter the sub menu and select which sources you require. Press "Enter" to finalize the selection. The projector will not search for inputs that are not selected.

Image AI

Image AI improves the contrast of the picture by optimizing the brightness of the lamp according to the picture content.

- ▶ On: The dynamic image performance manager is active in making sure your greatest pleasure from seeing a movie dynamically with the most dark details revealed, vivid and bright image performed all the way.
- ▶ Off: The dynamic image performance manager is on standby.

DISPLAY

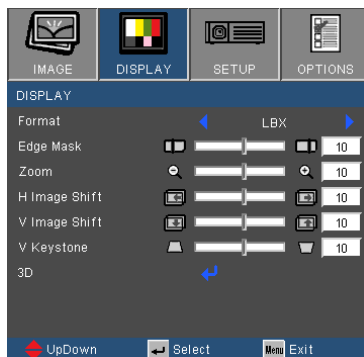

Format

Use this function to choose your desired aspect ratio.

XGA

- ▶ 4:3: This format is for 4×3 input sources.
- ▶ 16:9-I: This format is for 16×9 input sources, like HDTV and DVD enhanced for Wide screen TV. (576i/p)
- ▶ 16:9-II: This format is for 16×9 input sources, like HDTV and DVD enhanced for Wide screen TV. (480i/p)
- ▶ Native: This format displays the original image without any scaling.
- ▶ AUTO: Automatically selects the appropriate display format. When input is 4:3, the image is displayed as 4:3. When input is 16:9 above, the image is displayed as 16:9- I

Aspect ratio (source detected)	Resize image
	XGA model
4:3	1024 x 768 center
16:9-I	1024 x 576 center
16:9-II	854 x 480 center
Native	No resize image, 1:1 mapping and centered. This format shows the original image without scaling.

User Controls

WXGA



❖ 16:9 or 16:10 depend on “Screen Type” setting.

- ▶ 4:3: This format is for 4×3 input sources.
- ▶ 16:9: This format is for 16×9 input sources, like HDTV and DVD enhanced for Wide screen TV.
- ▶ 16:10: This format is for 16×10 input sources, like widescreen laptops.
- ▶ LBX: This format is for non-16x9, letterbox source and for users who use external 16x9 lens to display 2.35:1 aspect ratio using full resolution.
- ▶ Native: This format displays the original image without any scaling.
- ▶ AUTO: Automatically selects the appropriate display format.

16:10 Screen	480i/p	576i/p	1080i/p	720p	PC
4:3	1066 x 800 center				
16:10	1280 x 800 center				
LBX	1280 x 960 center, then get the central 1280 x 800 image to display				
Native	1:1 mapping centered.		1:1 mapping (960 x 540) display 1280 x 800	1280 x 720 center	1:1 mapping centered.

16:9 Screen	480i/p	576i/p	1080i/p	720p	PC
4:3	960 x 720 center				
16:9	1280 x 720 center				
LBX	1280 x 960 center, then get the central 1280 x 720 image to display				
Native	1:1 mapping centered.		1:1 mapping (960 x 540) display 1280 x 720	1280 x 720 center	1:1 mapping centered.

User Controls



- ❖ Each I/O has different setting of “Edge mask”.
- ❖ “Edge mask” and “Zoom” can’t work at same time.

Edge Mask

Edge mask function removes the noise in a video image. Edge mask the image to remove video encoding noise on the edge of video source.

Zoom

- ▶ Press the ◀ to reduce the size of an image.
- ▶ Press the ▶ to magnify an image on the projection screen.

H Image Shift

Shift the projected image position horizontally.

V Image Shift

Shift the projected image position vertically.

V Keystone

Press the ◀ or ▶ to adjust image distortion vertically. If the image looks trapezoidal, this option can help make the image rectangular.

DISPLAY | 3D



- ❖ “IR” options may vary according to model.
- ❖ “3D Sync Invert” is only available when 3D is enabled and this mode 3D is for DLP link glass only.
- ❖ Compatible 3D source, 3D content and active shutter glasses are required for 3D viewing.

3D

- ▶ Off: Select “Off” to turn 3D settings off for 3D images.
- ▶ DLP Link: Select “DLP Link” to use optimized settings for DLP Link 3D images.
- ▶ IR: Select “IR” to use optimized settings for IR-based 3D images.

3D Sync. Invert

- ▶ Press the “On” to invert left and right frame contents.
- ▶ Press the “Off” for default frame contents.

SETUP

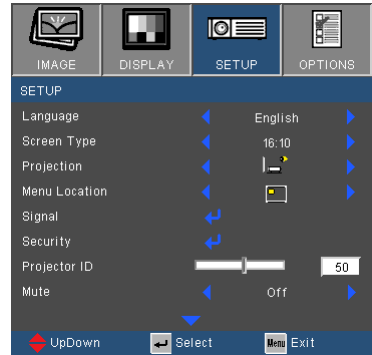

Language

Choose the multilingual OSD menu. Press ◀ or ▶ into the sub menu and then use the ▲ or ▼ key to select your preferred language. Press “Enter” to finalize the selection.



- ❖ “Screen Type” is for WXGA only.

Screen Type

Choose the screen type from 16:10 or 16:9.

Projection



- ❖ Rear-Desktop and Rear-Ceiling are to be used with a translucent screen.

- ▶  Front-Desktop

This is the default selection. The image is projected straight on the screen.

- ▶  Rear-Desktop

When selected, the image will appear reversed.

- ▶  Front-Ceiling

When selected, the image will turn upside down.

- ▶  Rear-Ceiling

When selected, the image will appear reversed in upside down position.

Menu Location

Choose the menu location on the display screen.

Projector ID

ID definition can be set up by menu (range 0~99), and allow user control an individual projector by RS232. Refer to page 81~85 for the complete list of RS232 commands.

Mute

- ▶ Choose the “On” to turn mute on.
- ▶ Choose the “Off” to turn mute off.

SETUP

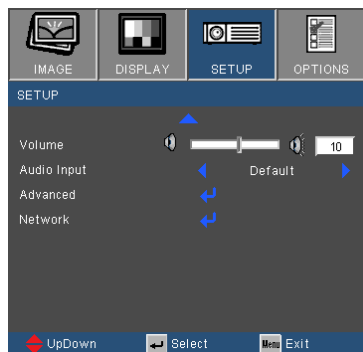

Volume



- ❖ Volume adjustment can also control MIC volume.

- ▶ Press the ◀ to decrease the volume.
- ▶ Press the ▶ to increase the volume.

Audio Input

The default audio settings are on the back panel of the projector. Use this option to reassign any of the Audio Inputs (1 or 2) to the current image source. Each Audio input can be assigned to more than one video source.

- ▶ Audio 1: VGA 1 and VGA 2.
- ▶ Audio 2: S-Video/Video.
- ▶ MIC: (No default video source)

SETUP | Signal (RGB)

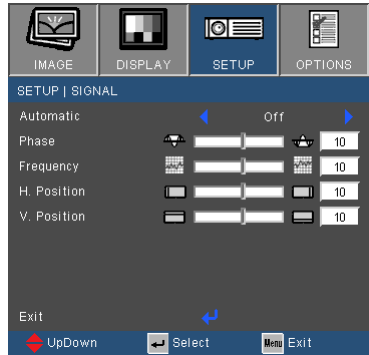

- ❖ “Signal” is only supported in Analog VGA (RGB) signal.

Automatic

Automatically selects the signal. If you use this function, the Phase, frequency items are grayed out, and if Signal is not automatic, the phase, frequency items will appear for user to manually tune and saved in settings after that for next time projector turns off and on again.

Phase

Synchronize the signal timing of the display with the graphic card. If the image appears to be unstable or flickers, use this function to correct it.

Frequency

Change the display data frequency to match the frequency of your computer’s graphic card. Use this function only if the image appears to flicker vertically.

H. Position

- ▶ Press the ◀ to move the image left.
- ▶ Press the ▶ to move the image right.

V. Position

- ▶ Press the ◀ to move the image down.
- ▶ Press the ▶ to move the image up.

SETUP | Security

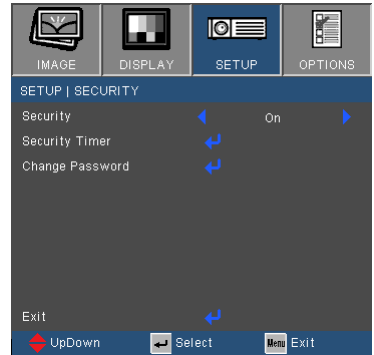

Security

- ▶ On: Choose “On” to use security verification when the turning on the projector.
- ▶ Off: Choose “Off” to be able to switch on the projector without password verification.



- ❖ Password default value is “1234” (first time).

Security Timer

Use this function to set the how long (Month/Day/Hour) the projector can be used. Once this time has elapsed you will be requested to enter your password again.

Change Password

- ▶ First time:
 1. Press “←” to set the password.
 2. The password has to be 4 digits.
 3. Use number button on the remote to enter your new password and then press “←” key to confirm your password.
- ▶ Change Password:
 1. Press “←” to input old password.
 2. Use number button to enter current password and then press “←” to confirm.
 3. Enter new password (4 digits in length) using the number buttons on the remote, then press “←” to confirm.
 4. Enter new password again and press “←” to confirm.

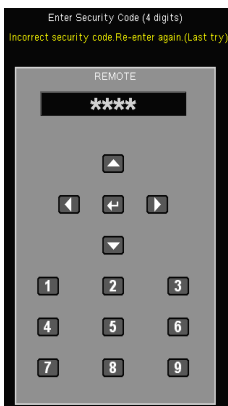



User Controls

- ▶ If the incorrect password is entered 3 times, the projector will automatically shut down.
- ▶ If you have forgotten your password, please contact your local office for support.

SETUP | Advanced

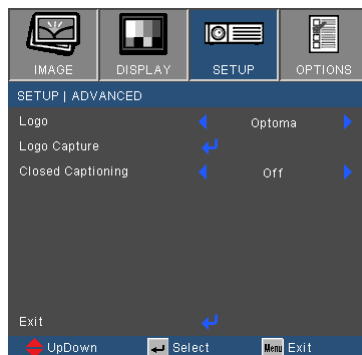

Logo

Use this function to set the desired startup screen. If changes are made they will take effect the next time the projector is powered on.

- ▶ Optoma: The default startup screen.
- ▶ Neutral: Logo is not displayed on startup screen.
- ▶ User: Use stored picture from “Logo Capture” function.



❖ For successful logo capture, please ensure that the on-screen image does not exceed the projector's native resolution. (XGA:1024x768 or WXGA:1280x800).

Logo Capture

Press  to capture an image of the picture currently displayed on screen.

Closed Captioning

Use this function to set the desired startup screen. If changes are made they will take effect the next time the projector is powered on.

- ▶ Off: select “off” to turn off the closed captioning feature.
- ▶ CC1:CC1 language: American English.
- ▶ CC2:CC2 language (depending on the TV channel of the user):Spanish, French, Portuguese, German, Danish.

SETUP | Network

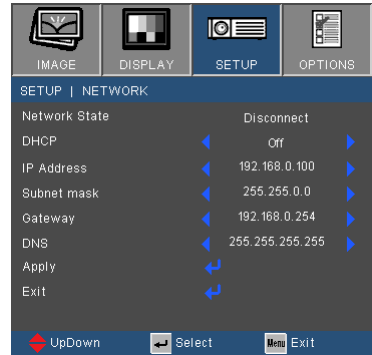

Network State

Display the network connection status.

DHCP

Use this function to select your desired startup screen. If you change the setting from one to another, when you exit the OSD menu, the new setting will take effect on next open.

- ▶ On: Assign an IP address to the projector from an external DHCP server automatically.
- ▶ Off: Assign an IP address manually.

IP Address

Select an IP address.

Subnet Mask

Select subnet mask number.

Gateway

Select the default gateway of the network connected to the projector.

DNS

Select DNS number.

Apply

Press “↵” and then choose “Yes” to apply the selection.

User Controls

How to use web browser to control your projector

1. Turn on DHCP to allow the DHCP server to automatically assign an IP, or manually enter the required network information.

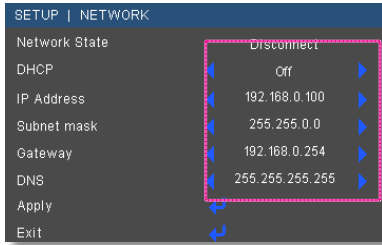

2. Then choose apply and press “←” button to complete the configuration process.
3. Open your web browser and type in from the OSD LAN screen then the web page will display as below:



4. Based on network web-page for the input-string in [tools] tab, the limitation for Input-Length is in the below list (“space” and the other punctuation key included):

Category	Item	Input-Length (characters)
Crestron Control	IP Address	15
	IP ID	2
	Port	5
Projector	Projector Name	10
	Location	9
	Assigned To	9
Network Configuration	DHCP (Enabled)	(N/A)
	IP Address	15
	Subnet Mask	15
	Default Gateway	15
User Password	Enabled	(N/A)
	New Password	15
	Confirm	15
Admin Password	Enabled	(N/A)
	New Password	15
	Confirm	15



❖ When you used the projector IP address, you will can not link to your service server.

User Controls

When making a direct connection from your computer to the projector

Step 1: Find an IP Address (192.168.0.100) from LAN function of projector.



Step 2: Select apply and press “Enter” button to submit function or press “menu” key to exit.

Step 3: To open Network Connections, click **Start**, click **Control Panel**, click **Network and Internet Connections**, and then click **Network Connections**. Click the connection you want to configure, and then, under **Network Tasks** , click **Change settings of this connection**.

Step 4: On the **General** tab, under **This connection uses the following items**, click **Internet Protocol (TCP/IP)**, and then click “Properties.”

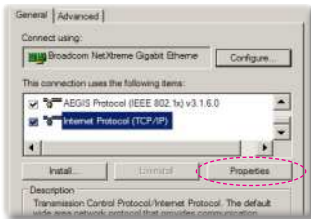

Step 5: Click **Use the following IP address**, and type in as below:
1) IP address: 192.168.0.100
2) Subnet mask: 255.255.255.0
3) Default gateway: 192.168.0.254

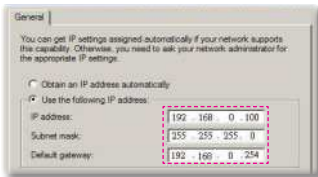

Step 6: To open Internet Options, click IE web browser, click Internet Options, click the **Connections** tab and click “LAN Settings...”

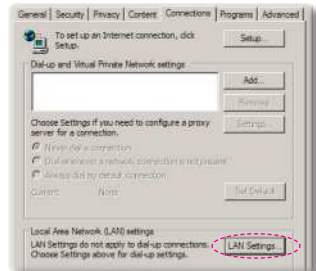

Step 7: The **Local Area Network (LAN) Setting** dialog box appears. In the **Proxy Server** area, cancel the **Use a proxy server for your LAN** check box., then click “OK” button twice.

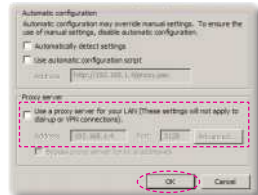

Step 8: Open your IE and type in the IP address of 192.168.0.100 in the URL then press “Enter” key.

Crestron RoomView Control Tool

Crestron RoomView™ provides a central monitoring station for 250+ control systems on a single Ethernet network (more are possible, the number depends on the combination of IP ID and IP address). Crestron RoomView monitors each projector, including projector's online status, system power, lamp life, network setting and hardware faults, plus any custom attribute as defined by the Administrator. The Administrator can add, delete, or edit room information, contact information and events, which are logged automatically by the software for all users. (Operation UI as following image)

1. Main Screen

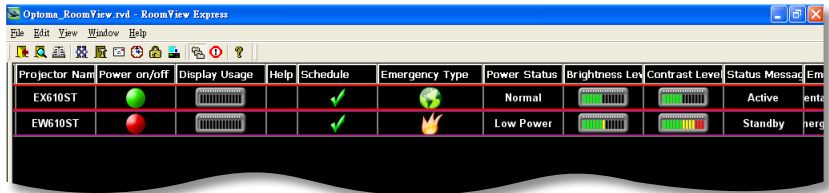

2. Edit Room



❖ Crestron RoomView function support is dependent on models.

Dialog box titled "Edit Room: crestron room" with tabs: General | Groups | Attributes | Assets | Contacts | Events |

Room Information

Name: crestron room Phone:

Location: e-Control Link: Browse...

IP Address: 192.168.0.101 Video Link:

IPID/IP Port: 03 | 41794

DHCP Enabled

External Gateway 0.0.0.0

SSL

Username: Password:

Comment:

Save Room Save As Help

OK Cancel Apply

3. Edit Attribute

Dialog box titled "Edit Attribute: Display Power".

General | Alert | Groups | Contacts

Attribute Properties

Signal Name: Display Power Graphic: Off On

Device: None

Signal Type: Digital

Join Number: 5 Default Max. Value: 1

Options

Apply attribute to all rooms Display on main view

Apply attribute to all contacts Show on context menu Advanced...

Record attribute changes to log

OK Cancel Apply

4. Edit Event

Dialog box titled "Edit Event: Display Off Warning".

General | Rooms

Event Properties

Name: Display Off Warning Enable this event

Type: Digital Repeat event

Join: 5

Schedule

Start Date: 2010/ 9/ 2 Weekdays Weekends

End Date: 2010/ 9/ 2 Monday Saturday

Time: 0:00:00 Tuesday Sunday

Wednesday

Thursday

Friday

OK Cancel Apply

For more information, please visit
<http://www.crestron.com> & www.crestron.com/getroomview.

OPTIONS

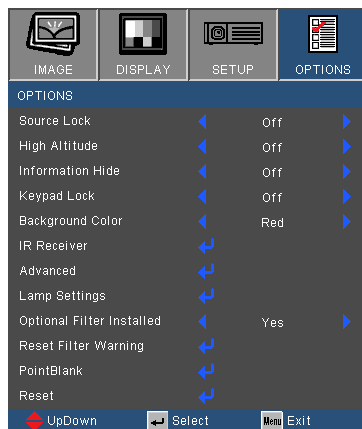

Source Lock

- ▶ On: The projector will only search current input connection.
- ▶ Off: The projector will search for other signals if the current input signal is lost.

High Altitude

When “On” is selected, the fans will spin faster. This feature is useful in high altitude areas where the air is thin.

Information Hide

- ▶ On: Choose “On” to hide the info message.
- ▶ Off: Choose “Off” to show the “searching” message.



❖ To turn off the keypad lock, press and hold “Enter” key on top of the projector for 5 seconds.

Keypad Lock

When the keypad lock function is “On”, the control panel will be locked however, the projector can be operated by the remote control. By selecting “Off”, you will be able to reuse the control panel.

Background Color

Use this feature to display a “Black”, “Red”, “Blue”, “Green” or “White”, screen when no signal is available.

IR Receiver

- ▶ Front Receiver: Choose “On” to start the receiver. Choose “Off” to close the receiver.
- ▶ Top Receiver: Choose “On” to start the receiver. Choose “Off” to close the receiver.

Optional Filter Installed

Select "Yes" to display warning message after 500 hours of use.
Select "No" to turn off warning message.

Reset Filter Warning

Select "Yes" to reset the dust filter hour counter after replacing or cleaning the dust filter.

Reset

Choose "Yes" to return the display parameters on all menus to the factory default settings.

OPTIONS | Advanced

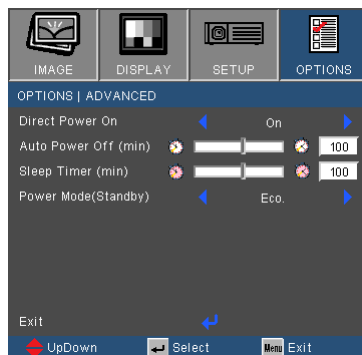

Direct Power On

Choose “On” to activate Direct Power mode. The projector will automatically power on when AC power is supplied, without pressing the “**⏻**” key on the projector control panel or on the remote control.

Auto Power Off (min)

Sets the countdown timer interval. The countdown timer will start, when there is no signal being sent to the projector. The projector will automatically power off when the countdown has finished (in minutes).

Sleep Timer (min)

Sets the countdown timer interval. The countdown timer will start, with or without a signal being sent to the projector. The projector will automatically power off when the countdown has finished (in minutes).

Power Mode (Standby)

- ▶ Eco.: Choose “Eco.” to save power dissipation further < 0.5W.
- ▶ Active: Choose “Active” to return to normal standby and the VGA out port will be enabled.



❖ When Power mode (Standby) is set to Eco (<0.5W), the VGA output, Audio pass-through and RJ45 will be deactivated when the projector is in standby.

OPTIONS | Lamp Settings

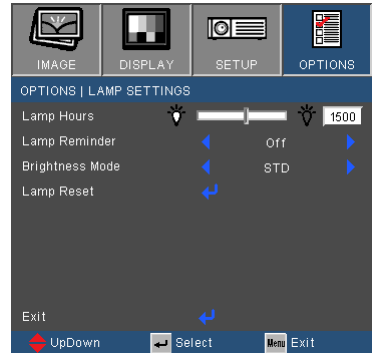

Lamp Hours

Display the projection time.

Lamp Reminder

Choose this function to show or to hide the warning message when the changing lamp message is displayed.

The message will appear 30 hours before suggested replacement of lamp.



❖ When ambient temperature is over 35°C in operating, the projector will switch to STD automatically.

Brightness Mode

- ▶ STD: Choose “STD” to dim the projector lamp which will lower power consumption and extend the lamp life.
- ▶ BRIGHT: Choose “BRIGHT” to increase the brightness.
- ▶ Image AI: Choose “Image AI” to improve the contrast of the picture.

Lamp Reset

Reset the lamp hour counter after replacing the lamp.

OPTIONS | PointBlank

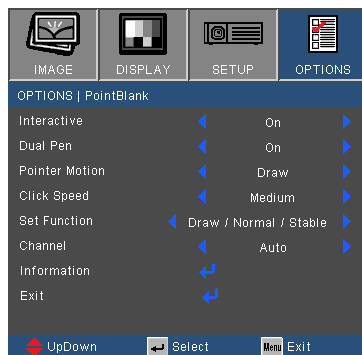

- ❖ Interactivity is supported only in the following input modes: VGA and HDMI from a PC, and Wireless Display, USB Display, and LAN Display
- ❖ Interactive Pen is supported in 3D source of 120Hz DLP-Link.
- ❖ The response time lag of Dual Pen operation is 180ms.

Interactive

Choose “On” to enable Interactive and activate the Interactive menu.

Dual Pen

Choose “On” to enable dual pen simultaneously.

Pointer Motion

Choose this function to select the Pointer Motion mode: “Normal”, “Draw”, and “Stable”.

- ▶ Normal: In this mode, press Mouse Left Click button of the interactive pen can hold the position of the pointer for a moment. This mode is best to use the Interactive Pen like a mouse, i.e., for left click and double click functions.
- ▶ Draw: In this mode, the pointer can move freely for drawing. This mode is best for drawing or writing on the screen
- ▶ Stable: In this mode, press and hold the Mouse Left Click button of the interactive pen to limit the pointer to vertical or horizontal moves. If the Mouse Left Click button is released, the pointer can resume to move freely. This mode is best for drawing vertical or horizontal lines on the screen.

Click Speed

Choose this function to select the mouse pause time. This function is only available in Normal mode. The available options are: “Fast”, “Medium” and “Low”.

Set Function

Choose this function to select the function of the Menu  button on the interactive pen.

- ▶ Pointer Motion: Function as toggling among “Normal”, “Draw”, and “Stable” mode
- ▶ PowerPoint Annotation: Function as annotating in the PowerPoint slide show.
- ▶ Switch Windows (Alt+Tab): Function as toggling among windows, acting as the keyboard shortcut Alt+Tab.
- ▶ Esc: Function as the keyboard Esc button.
- ▶ Show Desktop (Cmd+D): Function as showing desktop, minimizing all windows.
- ▶ Open Windows Explorer (Cmd+E): Choose the function as opening the Windows Explorer.
- ▶ Middle Mouse: Choose the function as the scroll wheel of the mouse.
- ▶ Double Click: Choose the function as double-clicking.
- ▶ Disable: Disable the Function button.

Channel

- ▶ Auto: Channel is selected automatically.
- ▶ Manual: Channel is selected manually. A total of 15 channels are available.

Information

View the information about the interactive pen.

Ruby Introduction

Ruby is a embedded project which can bring the high performance in network projection. Base on network protocol, user can configure the projector remotely. It supports to connect the PC with Projector by USB, Ethernet, and Wireless. This project makes full use of the network capability. It allows the administrator to control all the projectors in one building by one PC. When some emergencies happen, the projector can send out alert information to administrator by email and web page. It can read more than one USB device directly and show all the images in it

This project consists of three software applications which make full use of the network and USB capability

- *Web Control*
- *Card Reader*
- *Optoma Presenter*

How to use Web Control

The Web Control application allows user to configure the projector remotely base on various network protocol. It is convenient for administrator to control the whole projectors in one building by one PC.

1. Start the web browser, and enter the IP address of the projector in URL: <http://IP-address>, the log-in web page is displayed.



User Controls



Alert Setup

This page is to set up the alert notification for kinds of error types by sending mail. Alert type is multi-options.



SMTP Mail Setup

This page is to set up the details of mail sending, ex. mail server IP address, user name, password and mail address of receivers. (Note: Multi-receivers are separated by semicolon.)



Network Setup

This page is to set up network parameters of IP, DHCP Server, and wireless.

User Controls



- **IP Setup:** Click “Obtain an IP address automatically” as auto mode; click “Use the following IP Address” as static mode, IP Address/Subnet Mask/Default Gateway/ DNS Server are required to be filled and then click “Apply” button.
- **DHCP Server Setup:** Enable/Disable, Start IP, End IP, Subnet Mask, Default Gateway, DNS server.
- **Wireless Setup:** Connect with wireless dongle, and then setup WLAN mode, SSID, KEY, Channel etc.

Presenter Setup

Admin password/User password is used to change the password for admin/user in target side.



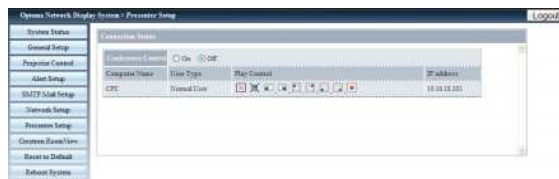

Click “Connection Control” to enter “Connection Status”



- **Conference Control:** Click “On” or “Off” to enable/disable conference control mode.

User Controls

Click the following icons under “Play Control”

- : Click to disconnect host PC.
- : Click to switch session to background.
- : Click to change display region.

Crestron RoomView

This is the control page of Flash UI.

Click “Power” to control power on/off of projector.

Click “Vol-, Mute, Vol+” to control volume.

In the SourceList, it includes all sources that the projector can process.

Click “Menu” to open menu; click “Source” to choose next source; click “Auto” to detect the source automatically; click “Blank” for AV mute function.

“Contrast, Brightness, Color, Sharpness, Zoom, Freeze” can be adjusted in the control panel below.



User Controls

Click “Tools”, the following items are included:

Model: Optoma Logout Tools Info Help

Optoma

Crestron Control

IP Address: 192.168.0.2
IP ID: 5
Port: 41734
Send

Projector

Projector Name: EWS75UT1
Location: Room
Name:
Send

User Password

Enabled
New Password:
Confirm:
Send

Default Language

English (English)
Send

DHCP DHCP Enabled

IP Address: 18.18.18.123
Subnet Mask: 255.255.255.0
Default Gateway: 18.18.18.254
DNS Server: 192.168.30.51
Host Name:
Send

Admin Password

Enabled
New Password:
Confirm:
Send

exit

Language: English (English) Expansion Options

- **Crestron Control:** the basic network information of the control system device.
- **Projector:** the ID of each projector in a building for Administrator to control.
- **User Password:** change user's password.
- **Default Language:** set the default language.
- **DHCP:** enable/disable DHCP and the details of network card.
- **Admin Password:** change administrator's password.

After change each items, click “Send” button to make it effect.

Click “Info” to show information and status of this projector.

Model: Optoma Logout Tools Info Help

Optoma

Projector Information

Projector Name: EWS75UT1
Location: Room
Firmware: C01.2011-03-07
Mac Address: 00:05:41:aa:8b:cc
Resolution: 8 x 8 GHz
Lamp Hours: 0
Assigned To: SE

Projector Status

Power Status: ON
Source: VGA1
Preset Mode: DYNAMIC
Projector Position: Rear Ceiling
Lamp Mode: STD
Error Status:

exit

Language: English (English) Expansion Options

User Controls

Click “Help” to inform administrator to do related protection or operation.

Reset to Default

Click “Apply” to reset system to the default settings.

Click “Flash Upgrade” to upgrade the Firmware from USB disk, which has been inserted in projector.



Reboot System

Click “Reboot” to reboot system.



How to use the Card Reader

The Card Reader application can display packaged images in a USB flash device.

1. Plugging the USB device into USB port of projector, source of Flash Drive is detected, and then USB Flash Devices Detection Screen is displayed. It supports 3 USB devices at the same time.



2. Press “Enter” to enter Thumbnail mode, different photos in different folders can be chosen; press “Menu” to open menu. The following buttons are supported in the user interface:



- *Previous*: Move the selected item left. (Go to previous page when this is the most left item)
- *Next*: Move the selected item right. (Go to next page when this is the most right item.)
- *Display*: Display the selected image or folder.
- *Thumbnail*: Enter the Thumbnail Display Mode.
- *Slide Show*: Enter the Slide Show Mode.
- *Name Order*: Sort files/folders in name order.
- *Extend Order*: Sort files/folders in extended order.
- *SizeOrder*: Sort files/folders in size order.
- *TimeOrder*: Sort files/folders in time order.
- *Projector Menu*: Enter OSD menu.

User Controls

- *File Name On/OFF: Enable/Disable file name display in Thumbnail Display Mode.*

Press Up/Down/Left/Right key to choose different functions and press Enter key to make it effect.

3. In the menu of Thumbnail mode, choose Display function, or choose file and press “Enter” to enter Display mode. The following buttons are supported in the user interface:



- *Display: Enter the Image Display Mode.*
- *Thumbnail: Enter the Thumbnail Display Mode.*
- *Slide Show: Enter the Slide Show Mode.*
- *Actual Size: Display in actual size of the image.*
- *Best Fit: Display the image in best fit to the screen.*
- *EXIF Disp OFF/On: Enable/Disable EXIF information display.*
- *+90/-90 deg: Rotate 90/-90 degree.*

Press Up/Down/Left/Right key to choose different functions and press Enter key to make it effect.

4. Press the SlideShow key to enter the Slide Show Mode. The following buttons are supported in the user interface:



User Controls

- *Stop: Stop Slide Show Mode.*
- *Delay 3/4/5: Slide Show delay in seconds.*
- *Slide Effect: Following modes are supported. (Slide Right/Slide Down/Slide Up/Slide Auto)*
- *Repeat ON/OFF: Enable/Disable Slide Show Repeat Mode.*

Press Up/Down/Left/Right key to choose different functions and press Enter key to make it effect.

When the image can NOT be displayed due to memory limitation or can NOT support image format, the specific image is displayed on the center of the screen.



- ❖ When the image file is large, slide show time will be longer more than the general picture, such as BMP format.

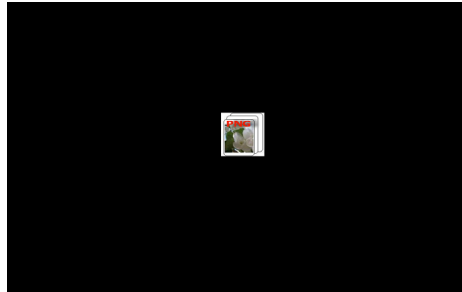

How to use the Optoma Presenter

Optoma Presenter application allows remote desktop from a host PC to be displayed on the network display through Ethernet, USB, or Wireless transports. It can adapt to different network settings (DHCP, fixed IP, and direct link by USB/Ethernet cable).

This software can be downloaded from web page.

Before using this function, a USB cable is needed to connect the Projector and PC Host directly. When the connection is OK, the PC will show a USB device disk. 







Select “Optoma Presenter”, and then run “autorun.exe” to start USB Display. 

1. Press the Autorun icon in the right-down region to pause or play the USB display.



2. After installation in PC, double click the program of Optoma Presenter to enter main window.



- : Connect and search network display.
- : Stop/Start displaying desktop contents to connected network display.
- : Select display region.
- : Configure Optoma Presenter.
- : Manage all connected network displays.
- : Disconnect all connections.

User Controls

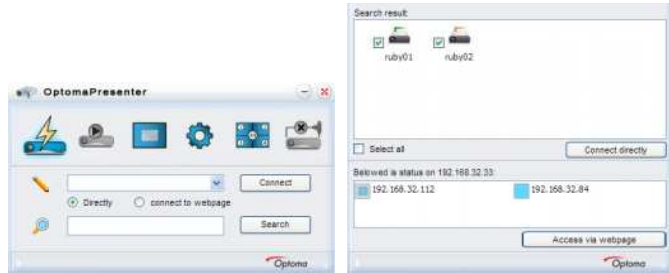

Click the button  to enter Connect and Search Menu.

1. Enter IP address of projector, select the option “Directly”, and then click “Connect” button to enter log-in interface; or Click “Search” button to search the projectors on network and select projectors to connect.

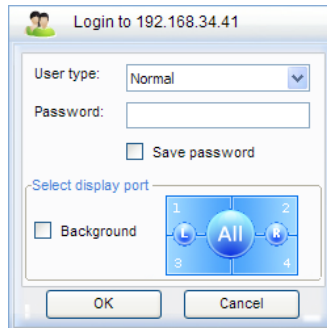

2. Input “User type” and “Password” in log-in interface. Display port can be selected, default is “Full screen”.



3. After log-in, Optoma Presenter will modify PC resolution to Ruby supported resolution, and the buttons of  and  become available.

Click the button  to select the size of projection region, including Full screen, Fixed Size and Alterable mode.

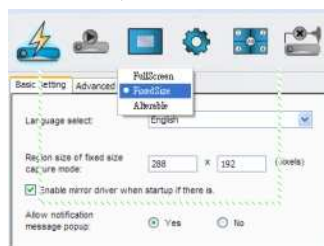

User Controls

- **Fixed size mode:** *FIXED mode allows the user to place a frame on the desktop and only the image enclosed inside the frame is transferred to remote network display. The user can change the width and height of the frame by setting up in page "Parameter Setting"->"Basic Setting" or change the size of frame in ALTERABLE mode and move the frame by dragging the frame with mouse.*
- **Alterable size mode:** *ALTERABLE mode the only region capture is the one enclosed by the frame. The difference with FIXED mode is the frame in ALTERABLE mode can be enlarged or downsized by dragging the eight small black squares scattered on eight edges of the frame.*

Click the button  to enter Setting interface, including Basic Setting and Advanced Setting.

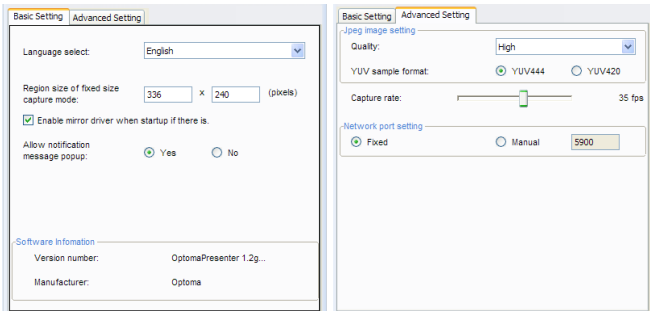









- **Basic Setting:** *Select Language, Region size of fixed size capture mode and allow notification message popup.*
- **Advanced Setting:** *select JPEG image quality, YUV sample format and network port.*

Click the button  to control all the users and all the projectors connected to the same projector.







User Controls

- : For Administrator user login.
- : For Normal user login.
- : Status of the connection for connected
- : Status of the connection for not connected.
- : For the status and display position of local screen on the network display, change it by clicking on it and a dialog box appears.
- : Click this unlock icon, the password can be changed. (Password change to target network display, only a connection with an Administrator user logged in can change the password.)
- : Click this lock icon will result in no response.
- : Disconnect with target network display.
- : Connect the target network display via a webpage front end.

User of Admin type is able to view a menu page with a list of PCs connected to the target network display.



- : For the other PCs.
- : For the current PC.
- : Options of display port in which the highlight one is the current status, click on one of them to change the display port.
- : Disconnect the PC from a network display.

Troubleshooting

If you experience a problem with your projector, please refer to the following information. If a problem persists, please contact your local reseller or service center.

[?] No image appears on-screen

- ▶ Ensure all the cables and power connections are correctly and securely connected as described in the “Installation” section.
- ▶ Ensure all the pins of connectors are not bent or broken.
- ▶ Check if the projection lamp has been securely installed. Please refer to the “Replacing the lamp” section.
- ▶ Make sure you have removed the lens cap and the projector is switched on.
- ▶ Ensure that the “AV mute” feature is not turned on.

[?] Partial, scrolling or incorrectly displayed image

- ▶ Press “Re-SYNC” on the remote.
- ▶ If you are using a PC:

For Windows 95, 98, 2000, XP, Windows 7:

1. Open the “My Computer” icon, the “Control Panel” folder, and then double click on the “Display” icon.
2. Select the “Settings” tab.
3. Verify that your display resolution setting is lower than or equal to UXGA (1600 × 1200).
4. Click on the “Advanced Properties” button.

If the projector is still not projecting the whole image, you will also need to change the monitor display you are using. Refer to the following steps.

5. Verify the resolution setting is lower than or equal to UXGA (1600 × 1200).
6. Select the “Change” button under the “Monitor” tab.

Appendices

7. Click on “Show all devices”. Next, select “Standard monitor types” under the SP box; choose the resolution mode you need under the “Models” box.
 8. Verify that the resolution setting of the monitor display is lower than or equal to UXGA (1600 × 1200).
- ▶ If you are using a Notebook:
1. First, follow the steps above to adjust resolution of the computer.
 2. Press the appropriate keys listed below for your notebook manufacturer to send signal out from notebook to projector.
Example: [Fn]+[F4]

Acer ⇨	[Fn]+[F5]	IBM/Lenovo ⇨	[Fn]+[F7]
Asus ⇨	[Fn]+[F8]	HP/Compaq ⇨	[Fn]+[F4]
Dell ⇨	[Fn]+[F8]	NEC ⇨	[Fn]+[F3]
Gateway ⇨	[Fn]+[F4]	Toshiba ⇨	[Fn]+[F5]

Mac Apple:
System Preference ⇨ Display ⇨ Arrangement ⇨ Mirror display

- ▶ If you experience difficulty changing resolutions or your monitor freezes, restart all equipment including the projector.

[?] The screen of the Notebook or PowerBook computer is not displaying your presentation

- ▶ If you are using a Notebook PC
Some Notebook PCs may deactivate their own screens when a second display device is in use. Each has a different way to be reactivated. Refer to your computer’s manual for detailed information.

[?] Image is unstable or flickering

- ▶ Use “Phase” to correct it. See page 41 for more information.
▶ Change the monitor color setting on your computer.

[?] Image has vertical flickering bar

- ▶ Use “Frequency” to make an adjustment. See page 41 for more information.
▶ Check and re-configure the display mode of your graphic card to make it compatible with the projector.

[?] Image is out of focus

- ▶ Make sure the lens cap is removed.
- ▶ Adjust the Focus Ring on the projector lens.
- ▶ Make sure the projection screen is between the required distance. See page 18.

[?] The image is stretched when displaying 16:9 DVD title

- ▶ When you play anamorphic DVD or 16:9 DVD, the projector will show the best image when the projector display mode is set to 16:9 in the OSD.
- ▶ If you play 4:3 format DVD titles, please change the format to 4:3 in the projector OSD.
- ▶ If the image is still stretched, you will also need to adjust the aspect ratio by referring to the following:
- ▶ Please setup the display format as 16:9 (wide) aspect ratio type on your DVD player.

[?] Image is too small or too large

- ▶ Move the projector closer to or further from the screen.
- ▶ Press “Menu” button on the remote control or projector panel, go to “DISPLAY → Format” and try the different settings.

[?] Image is reversed

- ▶ Select “SETUP → Projection” from the OSD and adjust the projection direction.





[?] The projector stops responding to all controls

- ▶ If possible, turn off the projector, then unplug the power cord and wait at least 60 seconds before reconnecting power.
- ▶ Check that “Keypad Lock” is not activated by trying to control the projector with the remote control.

[?] Lamp burns out or makes a popping sound

- ▶ When the lamp reaches its end of life, it will burn out and may make a loud popping sound. If this happens, the projector will not turn on until the lamp module has been replaced. To replace the lamp, follow the procedures in the “Replacing the Lamp” section on pages 76-77.

[?] LED lighting message

Message			
	POWER/STANDBY LED (Green/Amber)	Temp-LED (Red)	Lamp-LED (Red)
Standby State (Input power cord)	Amber	○	○
Power on (Warming)	Flashing Green	○	○
Lamp lighting	Green	○	○
Power off (Cooling)	Flashing Green	○	○
Error (Over Temp.)	Flashing Amber		○
Error (Fan fail)	Flashing Amber	Flashing	○
Error (Lamp fail)	Flashing Amber	○	



Steady light ⇨ 
 No light ⇨ ○

* POWER/STANDBY LED be ON when OSD appears, be OFF when OSD disappears.

? On Screen Messages

▶ Temperature warning:

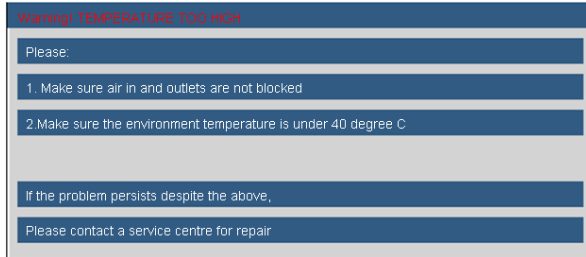

▶ Fan failed:



▶ Lamp warning:

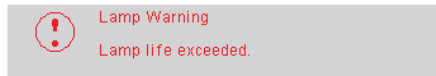

▶ Out of display range:

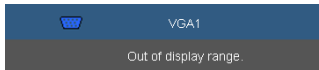

▶ Filter warning:

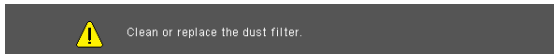

? If the remote control does not work

- ▶ Check the operating angle of the remote control is within $\pm 15^\circ$ both horizontally and vertically of one of the IR receivers on the projector.
- ▶ Make sure there are not any obstructions between the remote control and the projector. Move to within 7 m ($\pm 0^\circ$) of the projector.
- ▶ Make sure the batteries are inserted correctly.
- ▶ Replace batteries if they are exhausted.

- ?** If the Interactive pen does not work
- ▶ Check the input source is PC (VGA, HDMI, Wireless and LAN source)
 - ▶ Check the Interactive function is turned On.
 - ▶ When using Wireless or LAN connection, and the Pen does not work, check if the Wireless/Network function is turned On.
 - ▶ If more than one Pen point toward the screen at the same time, none can function.
 - ▶ Check the Nib, If the Nib is worn out, replace with a new Nib.
 - ▶ Make sure the batteries are inserted correctly.
 - ▶ Replace batteries if they are exhausted.
 - ▶ Make sure there are not any obstructions between the Interactive pen and the projector. Move to within 10m (0°) / 8m (20°) / 5m (45°) of the projector.

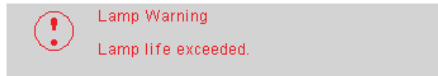

Replacing the lamp

The projector automatically detects the lamp life. When the lamp life is nearing the end of use, you will receive a warning message.

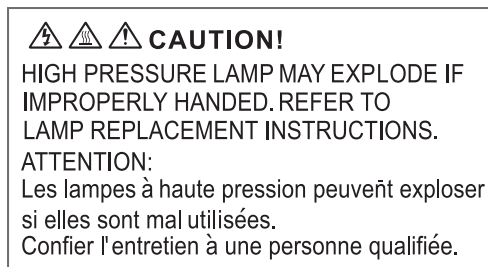

When you see this message, please contact your local reseller or service center to change the lamp as soon as possible. Make sure the projector has been cooled down for at least 30 minutes before changing the lamp.



-  Warning: If ceiling mounted, please use caution when opening the lamp access panel. It is recommended to wear safety glasses if changing the bulb when ceiling mounted. "Caution must be used to prevent any loose parts from falling out of projector."
-  Warning: Lamp compartment may be hot! Allow it to cool down before changing the lamp!
-  Warning: To reduce the risk of personal injury, do not drop the lamp module or touch the lamp bulb. The bulb may shatter and cause injury if it is dropped.

NOTE

- ❖ The screws on the lamp cover and the lamp cannot be removed.
- ❖ The projector cannot be turned on if the lamp cover has not been placed back on the projector.
- ❖ Do not touch the glass area of the lamp. Hand oil can cause the lamp to shatter. Use a dry cloth to clean the lamp module if it was accidentally touched.

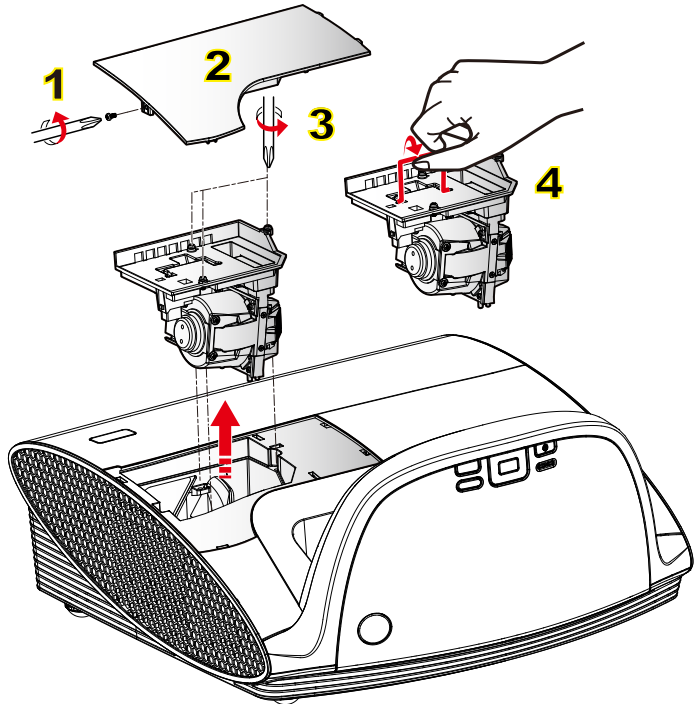

Lamp Replacement Procedure:

1. Switch off the power to the projector by pressing the “**⏻**” button.
 2. Allow the projector to cool down for at least 30 minutes.
 3. Disconnect the power cord.
 4. Unscrew the one screw on the cover. **1**
 5. Lift up and remove the cover. **2**
 6. Unscrew the three screws on the lamp module. **3**
 7. Lift up the lamp handle and remove the lamp module slowly and carefully. **4**
- To replace the lamp module, reverse the previous steps.
8. Turn on the projector and use “Lamp Reset” after the lamp module is replaced.
- Lamp Reset: (i) Press “Menu” → (ii) Select “OPTIONS” → (iii) Select “Lamp Settings” → (iv) Select “Lamp Reset” → (v) Select “Yes”.

Replacing and cleaning the optional dust filter

We recommend cleaning the dust filter after every 500 hours of use, clean it more often if the projector is used in a dusty environment.

NOTE

- ❖ If the dust filter is installed, proper maintenance will prevent overheating and related damage to the projector.



Clean or replace the dust filter.

When you see this message, please find following steps for cleaning procedure:

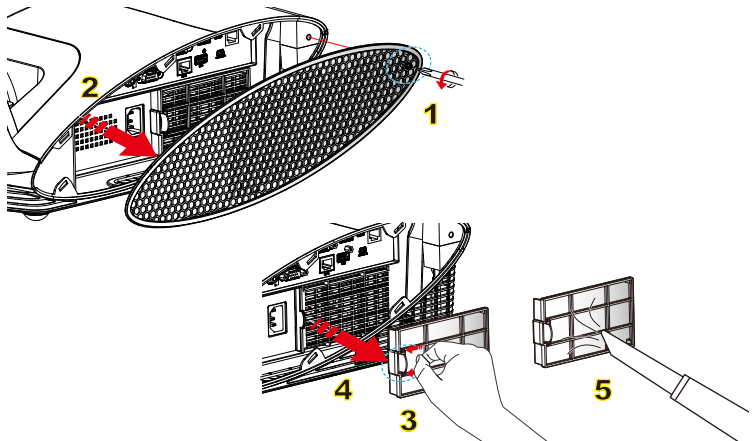

Cleaning the Dust Filter Procedure:

1. Switch off the power to the projector by pressing the “**⏻**” button.
2. Disconnect the power cord.
3. Unscrew the one screw on the cable cover. **1**
4. Lift up and remove the cable cover. **2**
5. Push the latch by the arrow direction. **3**
6. Remove the dust filter slowly and carefully. **4**
7. Clean or replace the dust filter. **5**

To install the dust filter, reverse the previous steps.

8. Turn on the projector and use “Reset Dust Filter” after the dust filter is replaced.

Filter Reset: (i) Press “Menu” → (ii) Select “OPTIONS” → (iii) Select “Reset Dust Filter” → (iv) Select “Yes”.

Compatibility Modes

► Computer Compatibility

Mode	Resolution	V-Sync (Hz)		H-Sync (KHz)	
		Analog	Digital	Analog	Digital
VGA	640 × 350	70	70	31.50	31.50
VGA	640 × 350	85	85	37.90	37.90
VGA	640 × 400	85	85	37.90	37.90
VGA	640 × 480	60	60	31.50	31.50
VGA	640 × 480	67	67	-	-
VGA	640 × 480	72	72	37.90	37.90
VGA	640 × 480	75	75	37.50	37.50
VGA	720 × 400	70	70	31.50	31.50
VGA	720 × 400	85	85	37.90	37.90
SVGA	800 × 600	56	56	35.20	35.20
SVGA	800 × 600	60	60	37.90	37.90
SVGA	800 × 600	72	72	48.10	48.10
SVGA	800 × 600	75	75	46.90	46.90
SVGA	800 × 600	120	120	-	-
	832 × 624	75	75	-	-
XGA	1024 × 768	60	60	48.40	48.40
XGA	1024 × 768	70	70	56.50	56.50
XGA	1024 × 768	75	75	60.00	60.00
XGA	1024 × 768	120	120	-	-
	1152 × 870	75	75	-	-
WXGA	1280 × 800	60	60	49.68	49.64
WSXGA+(*)	1680 × 1050	60	60	65.00	65.00
SXGA	1280 × 1024	60	60	63.98	63.98
UXGA	1600 × 1200	60	60	75.00	75.00
HD	1280 × 720	60	60	45.00	45.00
HD	1280 × 720	120	120	-	-
HD	1920 × 1080	30	30	33.80	33.80



- ❖ For widescreen resolution (WXGA), the compatibility support is dependent on Notebook/PC models.
- ❖ 120Hz input signals may be dependent on graphics cards support.
- ❖ Please note that using resolutions other than native 1024 x 768 (XGA model), 1280 x 800 (WXGA model) may result in some loss of image clarity.
- ❖ For WXGA model only.

Appendices

▶ Computer Compatibility

Mode	Resolution	V-Sync (Hz)	H-Sync (KHz)
MAC LC 13"	640 × 480	66.66	34.98
MAC II 13"	640 × 480	66.68	35.00
MAC 16"	832 × 624	74.55	49.73
MAC 19"	1024 × 768	75	60.24
MAC	1152 × 870	75.06	68.68
MAC G4	640 × 480	60	31.35
i MAC DV	1024 × 768	75	60.00
i MAC DV	1152 × 870	75	68.49

▶ Video Compatibility

NTSC	M (3.58MHz), 4.43 MHz
PAL	B, D, G, H, I, M, N
SECAM	B, D, G, K, K1, L
SDTV	480i/p, 576i/p,
HDTV	720p@50Hz/60Hz, 1080i@50Hz/60Hz, 1080p@24Hz/50Hz/60Hz

RS232 Commands and Protocol Function List

RS232 Pin Assignments

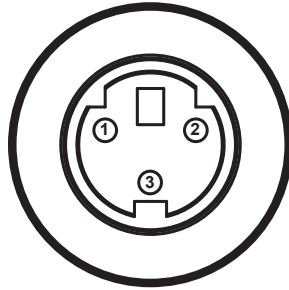

- ❖ RS232 shell is grounded.

Pin no.	Spec. (from projector side)
1	TXD
2	RXD
3	GND

Appendices

RS232 Protocol Function List



1. There is a <CR> after all ASCII commands.

2. 0D is the HEX code for <CR> in ASCII code.

Baud Rate : 9600

Data Bits: 8

Parity: None

Stop Bits: 1

Flow Control : None

UART16550 FIFO: Disable

Projector Return (Pass): P

Projector Return (Fail): F

XX=00-99, projector's ID,

XX=00 is for all projectors

SEND to projector

232 ASCII Code	HEX Code	Function	Description
~XX00 1	7E 30 30 30 30 20 31 0D	Power ON	
~XX00 0	7E 30 30 30 30 20 30 0D	Power OFF	
~XX00 1 ~nnnn	7E 30 30 30 30 20 31 20 a 0D	Power ON with Password	~nnnn = ~0000 (a=7E 30 30 30 30) - ~9999(a=7E 39 39 39 39)
~XX01 1	7E 30 30 30 31 20 31 0D	Resync	
~XX02 1	7E 30 30 30 32 20 31 0D	AV Mute	On
~XX02 0	7E 30 30 30 32 20 30 0D		Off
~XX03 1	7E 30 30 30 33 20 31 0D	Mute	On
~XX03 0	7E 30 30 30 33 20 30 0D		Off
~XX04 1	7E 30 30 30 34 20 31 0D	Freeze	
~XX04 0	7E 30 30 30 34 20 30 0D	Unfreeze	
~XX05 1	7E 30 30 30 35 20 31 0D	Zoom Plus	
~XX06 1	7E 30 30 30 36 20 31 0D	Zoom Minus	
~XX07 1	7E 30 30 30 37 20 31 0D	Up (Pan under zoom)	
~XX08 1	7E 30 30 30 38 20 31 0D	Down (Pan under zoom)	
~XX09 1	7E 30 30 30 39 20 31 0D	Left (Pan under zoom)	
~XX10 1	7E 30 30 31 30 20 31 0D	Right (Pan under zoom)	
~XX12 1	7E 30 30 31 32 20 31 0D	Direct Source Command	HDMI
~XX12 5	7E 30 30 31 32 20 35 0D		VGA 1
~XX12 6	7E 30 30 31 32 20 36 0D		VGA 2
~XX12 9	7E 30 30 31 32 20 39 0D		S-Video
~XX12 10	7E 30 30 31 32 20 31 30 0D		Video
~XX12 11	7E 30 30 31 32 20 31 31 0D		Flash Drive
~XX12 12	7E 30 30 31 32 20 31 32 0D		Presenter
~XX12 13	7E 30 30 31 32 20 31 33 0D		USB Display
~XX20 1	7E 30 30 32 30 20 31 0D	Display Mode	Presentation
~XX20 2	7E 30 30 32 30 20 32 0D		Bright
~XX20 3	7E 30 30 32 30 20 33 0D		Movie
~XX20 4	7E 30 30 32 30 20 34 0D		sRGB
~XX20 5	7E 30 30 32 30 20 35 0D		User
~XX20 7	7E 30 30 32 30 20 37 0D		Blackboard
~XX20 8	7E 30 30 32 30 20 38 0D		Classroom
~XX20 9	7E 30 30 32 30 20 39 0D		3D
~XX21 n	7E 30 30 32 31 20 a 0D	Brightness	n = 0 (a=30) ~ 100 (a=31 30 30)
~XX22 n	7E 30 30 32 32 20 a 0D	Contrast	n = 0 (a=30) ~ 100 (a=31 30 30)
~XX23 n	7E 30 30 32 33 20 a 0D	Sharpness	n = 0 (a=30) ~ 31 (a=33 31)
~XX24 n	7E 30 30 32 34 20 a 0D	Color	Red Gain n = -50 (a=2D 35 30) ~ 50 (a=35 30)
~XX25 n	7E 30 30 32 35 20 a 0D		Green Gain n = -50 (a=2D 35 30) ~ 50 (a=35 30)
~XX26 n	7E 30 30 32 36 20 a 0D		Blue Gain n = -50 (a=2D 35 30) ~ 50 (a=35 30)
~XX27 n	7E 30 30 32 37 20 a 0D		Red Bias n = -50 (a=2D 35 30) ~ 50 (a=35 30)
~XX28 n	7E 30 30 32 38 20 a 0D		Green Bias n = -50 (a=2D 35 30) ~ 50 (a=35 30)
~XX29 n	7E 30 30 32 39 20 a 0D		Blue Bias n = -50 (a=2D 35 30) ~ 50 (a=35 30)
~XX30 n	7E 30 30 33 30 20 a 0D		Cyan n = -50 (a=2D 35 30) ~ 50 (a=35 30)
~XX31 n	7E 30 30 33 31 20 a 0D		Yellow n = -50 (a=2D 35 30) ~ 50 (a=35 30)
~XX32 n	7E 30 30 33 32 20 a 0D		Magenta n = -50 (a=2D 35 30) ~ 50 (a=35 30)
~XX33 1	7E 30 30 33 33 20 31 0D		Reset
~XX34 n	7E 30 30 33 34 20 a 0D	BrilliantColor™	n = 0 (a=30) ~ 10 (a=31 30)
~XX35 1	7E 30 30 33 35 20 31 0D	Degamma	Film
~XX35 2	7E 30 30 33 35 20 32 0D		Video
~XX35 3	7E 30 30 33 35 20 33 0D		Graphics
~XX35 4	7E 30 30 33 35 20 34 0D		PC
~XX36 1	7E 30 30 33 36 20 31 0D	Color Temp.	Warm
~XX36 2	7E 30 30 33 36 20 32 0D		Medium
~XX36 3	7E 30 30 33 36 20 33 0D		Cold
~XX37 1	7E 30 30 33 37 20 31 0D	Color Space	* HDMI w/o Color Space item
~XX37 2	7E 30 30 33 37 20 32 0D		Auto
~XX37 3	7E 30 30 33 37 20 33 0D		RGB
~XX37 4	7E 30 30 33 37 20 34 0D		YUV
~XX39 5	7E 30 30 33 39 20 35 0D	Input Source	VGA1
~XX39 6	7E 30 30 33 39 20 35 0D		VGA2
~XX39 9	7E 30 30 33 39 20 39 0D		S-Video
~XX39 10	7E 30 30 33 39 20 31 30 0D		Video
~XX39 1	7E 30 30 33 39 20 31 0D		HDMI

Appendices

~XX39 11	7E 30 30 33 39 20 31 31 0D		Flash Drive	
~XX39 12	7E 30 30 33 39 20 31 32 0D		Presenter(LAN+Wireless)	
~XX39 13	7E 30 30 33 39 20 31 33 0D		USB Display	
~XX44 n	7E 30 30 34 34 20 a 0D	Tint		n = 0 (a=30) ~ 100 (a=31 30 30)
~XX45 n	7E 30 30 34 35 20 a 0D	Color (Saturation)		n = 0 (a=30) ~ 100 (a=31 30 30)
(EW675UT/UTi only)				
~XX60 1	7E 30 30 36 30 20 31 0D	Format	4:3	
~XX60 2	7E 30 30 36 30 20 32 0D		16:9/16:10	
~XX60 5	7E 30 30 36 30 20 35 0D		LBX	
~XX60 6	7E 30 30 36 30 20 36 0D		Native	
~XX60 7	7E 30 30 36 30 20 37 0D		AUTO	
(EX665UT/UTi only)				
~XX60 1	7E 30 30 36 30 20 31 0D	Format	4:3	
~XX60 2	7E 30 30 36 30 20 32 0D		16:9-I	
~XX60 3	7E 30 30 36 30 20 35 0D		16:9-II	
~XX60 6	7E 30 30 36 30 20 36 0D		Native	
~XX60 7	7E 30 30 36 30 20 37 0D		AUTO	
~XX61 n	7E 30 30 36 31 20 a 0D	Edge Mask		n = 0 (a=50) ~ 10(a=31 30)
~XX62 n	7E 30 30 36 32 20 a 0D	Zoom		n = -5 (a=2D 35) ~ 25 (a=32 35)
~XX63 n	7E 30 30 36 33 20 a 0D	H Image Shift		n = -50 (a=2D 35 30) ~ +50 (a=35 30)
~XX64 n	7E 30 30 36 34 20 a 0D	V Image Shift		n = -50 (a=2D 35 30) ~ +50 (a=35 30)
~XX66 n	7E 30 30 36 36 20 a 0D	V Keystone		n = -40 (a=2D 34 30) ~ 40 (a=34 30)
~XX230 1	7E 30 30 32 33 30 20 31 0D	3D Mode	On	
~XX230 0	7E 30 30 32 33 30 20 30 0D	3D Mode	Off	
~XX231 1	7E 30 30 32 33 31 20 31 0D	3D Sync Invert	On	
~XX231 0	7E 30 30 32 33 31 20 30 0D	3D Sync Invert	Off	
~XX70 1	7E 30 30 37 30 20 31 0D	Language	English	
~XX70 2	7E 30 30 37 30 20 32 0D		German	
~XX70 3	7E 30 30 37 30 20 33 0D		French	
~XX70 4	7E 30 30 37 30 20 34 0D		Italian	
~XX70 5	7E 30 30 37 30 20 35 0D		Spanish	
~XX70 6	7E 30 30 37 30 20 36 0D		Portuguese	
~XX70 7	7E 30 30 37 30 20 37 0D		Polish	
~XX70 8	7E 30 30 37 30 20 38 0D		Dutch	
~XX70 9	7E 30 30 37 30 20 39 0D		Swedish	
~XX70 10	7E 30 30 37 30 20 31 30 0D		Norwegian/Danish	
~XX70 11	7E 30 30 37 30 20 31 31 0D		Finnish	
~XX70 12	7E 30 30 37 30 20 31 32 0D		Greek	
~XX70 13	7E 30 30 37 30 20 31 33 0D		Traditional Chinese	
~XX70 14	7E 30 30 37 30 20 31 34 0D		Simplified Chinese	
~XX70 15	7E 30 30 37 30 20 31 35 0D		Japanese	
~XX70 16	7E 30 30 37 30 20 31 36 0D		Korean	
~XX70 17	7E 30 30 37 30 20 31 37 0D		Russian	
~XX70 18	7E 30 30 37 30 20 31 38 0D		Hungarian	
~XX70 19	7E 30 30 37 30 20 31 39 0D		Czechoslovak	
~XX70 20	7E 30 30 37 30 20 32 30 0D		Arabic	
~XX70 21	7E 30 30 37 30 20 32 31 0D		Thai	
~XX70 22	7E 30 30 37 30 20 32 32 0D		Turkish	
~XX70 23	7E 30 30 37 30 20 32 33 0D		Farst	
~XX70 25	7E 30 30 37 30 20 32 35 0D		Vietnamese	
~XX70 26	7E 30 30 37 30 20 32 36 0D		Romanian	
~XX70 27	7E 30 30 37 30 20 32 37 0D		Indonesia	
~XX71 1	7E 30 30 37 31 20 31 0D	Projection	Front-Desktop	
~XX71 2	7E 30 30 37 31 20 32 0D		Rear-Desktop	
~XX71 3	7E 30 30 37 31 20 33 0D		Front-Ceiling	
~XX71 4	7E 30 30 37 31 20 34 0D		Rear-Ceiling	
~XX72 1	7E 30 30 37 32 20 31 0D	Menu Location	Top Left	
~XX72 2	7E 30 30 37 32 20 32 0D		Top Right	
~XX72 3	7E 30 30 37 32 20 33 0D		Centre	
~XX72 4	7E 30 30 37 32 20 34 0D		Bottom Left	
~XX72 5	7E 30 30 37 32 20 35 0D		Bottom Right	
(EW675UT/UTi only)				
~XX90 1	7E 30 30 39 31 20 31 0D	Screen Type	16:10	
~XX90 0	7E 30 30 39 31 20 30 0D		16:9	
~XX91 1	7E 30 30 39 31 20 31 0D	Signal	Automatic	On
~XX91 0	7E 30 30 39 31 20 30 0D		Automatic	Off
~XX73 n	7E 30 30 37 33 20 a 0D		Frequency	n = -5 (a=2D 35) ~ 5 (a=35) By signal
~XX74 n	7E 30 30 37 34 20 a 0D		Phase	n = 0 (a=30) ~ 31 (a=33 31) By signal
~XX75 n	7E 30 30 37 35 20 a 0D		H. Position	n = -5 (a=2D 35) ~ 5 (a=35) By timing
~XX76 n	7E 30 30 37 36 20 a 0D		V. Position	n = -5 (a=2D 35) ~ 5 (a=35) By timing
~XX77 n	7E 30 30 37 37 20 aabbcc 0D	Security	Security Timer	Month/Day/Hour n = mm/dd/hh mm = 00 (aa=30 30) ~ 12 (aa=31 32) dd = 00 (bb=30 30) ~ 30 (bb=33 30) hh = 00 (cc=30 30) ~ 24 (cc=32 34)
~XX78 1	7E 30 30 37 38 20 31 0D		Security	On
~XX78 0	7E 30 30 37 38 20 32 0D			Off (0/2 for backward compatible)
~XX79 n	7E 30 30 37 39 20 a 0D	Projector ID		n = 00 (a=30 30) ~ 99 (a=39 39)
~XX80 1	7E 30 30 38 20 31 0D	Mute	On	
~XX80 0	7E 30 30 38 20 30 0D		Off	

Appendices

~XX81 n	7E 30 30 38 31 20 a 0D	Volume	Optoma	n = 0 (a=30) ~ 20 (a=32 30)
~XX82 1	7E 30 30 38 32 20 31 0D	Logo	User	
~XX82 2	7E 30 30 38 32 20 32 0D			
~XX83 1	7E 30 30 38 33 20 31 0D	Logo Capture		
~XX88 0	7E 30 30 38 38 20 30 0D	Closed Captioning	Off	
~XX88 1	7E 30 30 38 38 20 31 0D		cc1	
~XX88 2	7E 30 30 38 38 20 32 0D		cc2	
~XX100 1	7E 30 30 31 30 30 20 31 0D	Source Lock	On	
~XX100 0	7E 30 30 31 30 30 20 30 0D		Off	
~XX100 3	7E 30 30 31 30 30 20 33 0D	Next Source		
~XX101 1	7E 30 30 31 30 31 20 31 0D	High Altitude	On	
~XX101 0	7E 30 30 31 30 31 20 30 0D		Off	
~XX102 1	7E 30 30 31 30 32 20 31 0D	Information Hide	On	
~XX102 0	7E 30 30 31 30 32 20 30 0D		Off	
~XX103 1	7E 30 30 31 30 33 20 31 0D	Keypad Lock	On	
~XX103 0	7E 30 30 31 30 33 20 30 0D		Off	
~XX104 1	7E 30 30 31 30 34 20 31 0D	Background Color	Blue	
~XX104 2	7E 30 30 31 30 34 20 32 0D		Black	
~XX104 3	7E 30 30 31 30 34 20 33 0D		Red	
~XX104 4	7E 30 30 31 30 34 20 34 0D		Green	
~XX104 5	7E 30 30 31 30 34 20 35 0D		White	
~XX105 1	7E 30 30 31 30 35 20 31 0D	Advanced	Direct Power On	On
~XX105 0	7E 30 30 31 30 35 20 30 0D			Off
~XX106 n	7E 30 30 31 30 36 20 a 0D		Auto Power Off (min)	n = 0 (a=30) ~ 180 (a=31 38 30), step=1
~XX107 n	7E 30 30 31 30 37 20 a 0D		Sleep Timer (min)	n = 0 (a=30) ~ 995 (a=39 39 35), step=5
~XX114 1	7E 30 30 31 31 34 20 31 0D		Power Mode(Standby)	Eco (<=1W)
~XX114 0	7E 30 30 31 31 34 20 30 0D			Active
~XX109 1	7E 30 30 31 30 39 20 31 0D		Lamp Reminder	On
~XX109 0	7E 30 30 31 30 39 20 30 0D			Off
~XX110 0	7E 30 30 31 31 30 20 31 0D		Brightness Mode	STD
~XX110 1	7E 30 30 31 31 30 20 30 0D			Bright
~XX110 2	7E 30 30 31 31 30 20 30 0D			ImageAI
~XX111 1	7E 30 30 31 31 31 20 31 0D		Lamp Reset	Yes
~XX111 0	7E 30 30 31 31 31 20 30 0D			No
~XX112 1	7E 30 30 31 31 32 20 31 0D	Reset		Yes
~XX120 0	7E 30 30 31 32 30 20 30 0D	PointBlank	Interactive	Off
~XX120 1	7E 30 30 31 32 30 20 31 0D			On
~XX121 0	7E 30 30 31 32 31 20 30 0D		Dual Pen	Off
~XX121 0	7E 30 30 31 32 31 20 31 0D			On
~XX122 0	7E 30 30 31 32 32 20 30 0D		Pointer Motion	Draw
~XX122 1	7E 30 30 31 32 32 20 31 0D			Normal
~XX122 2	7E 30 30 31 32 32 20 32 0D			Stable
~XX123 0	7E 30 30 31 32 33 20 30 0D		Click Speed	Fast
~XX123 1	7E 30 30 31 32 33 20 31 0D			Medium
~XX123 2	7E 30 30 31 32 33 20 32 0D			Slow
~XX124 0	7E 30 30 31 32 34 20 30 0D		Set Function	Pointer Motion
~XX124 1	7E 30 30 31 32 34 20 31 0D			PowerPoint Annotation
~XX124 2	7E 30 30 31 32 34 20 32 0D			Switch Window
~XX124 3	7E 30 30 31 32 34 20 33 0D			Esc
~XX124 4	7E 30 30 31 32 34 20 34 0D			Show Desktop
~XX124 5	7E 30 30 31 32 34 20 35 0D			Open Windows Explorer
~XX124 6	7E 30 30 31 32 34 20 36 0D			Middle Click
~XX124 7	7E 30 30 31 32 34 20 37 0D			Double Click
~XX124 8	7E 30 30 31 32 34 20 38 0D			Disable
~XX125 n	7E 30 30 31 32 35 20 a 0D		Channel	n=0 (a:0x30), Auto n=1-30 (a:0x31 ~ 0x33 0x30), Channel number
~XX126 1	7E 30 30 31 32 36 20 31 0D		Information	
~XX127 1	7E 30 30 31 32 37 20 31 0D	Reset Dust Filter		
~XX128 0	7E 30 30 31 32 38 20 30 0D	IR Receiver	Top Receiver	Off
~XX128 1	7E 30 30 31 32 38 20 31 0D			On
~XX129 0	7E 30 30 31 32 39 20 30 0D		Front Receiver	Off
~XX129 1	7E 30 30 31 32 39 20 31 0D			On
~XX130 0	7E 30 30 31 33 30 20 30 0D	Audio Input	Default	
~XX130 1	7E 30 30 31 33 30 20 31 0D		AUDIO1	
~XX130 2	7E 30 30 31 33 32 20 32 0D		AUDIO2	
~XX210 n	7E 30 30 32 30 20 n 0D	Display message on the OSD		n: 1-30 characters

SEND as Remote Control Key

~XX140 1	7E 30 30 31 34 30 20 31 0D	Power
~XX140 3	7E 30 30 31 34 30 20 33 0D	Mouse Up
~XX140 4	7E 30 30 31 34 30 20 34 0D	Mouse Left
~XX140 5	7E 30 30 31 34 30 20 35 0D	Mouse Enter
~XX140 6	7E 30 30 31 34 30 20 36 0D	Mouse Right
~XX140 7	7E 30 30 31 34 30 20 37 0D	Mouse Down
~XX140 8	7E 30 30 31 34 30 20 38 0D	Mouse Left Click
~XX140 9	7E 30 30 31 34 30 20 39 0D	Mouse Right Click
~XX140 10	7E 30 30 31 34 30 20 31 30 0D	Up/Page +
~XX140 11	7E 30 30 31 34 30 20 31 31 0D	Left/Source
~XX140 12	7E 30 30 31 34 30 20 31 32 0D	Enter (for projection MENU)
~XX140 13	7E 30 30 31 34 30 20 31 33 0D	Right/Re-SYNC
~XX140 14	7E 30 30 31 34 30 20 31 34 0D	Down/Page -

Appendices

~XX140 15	7E 30 30 31 34 30 20 31 35 0D	Keystone +
~XX140 16	7E 30 30 31 34 30 20 31 36 0D	Keystone -
~XX140 17	7E 30 30 31 34 30 20 31 37 0D	Volume -
~XX140 18	7E 30 30 31 34 30 20 31 38 0D	Volume +
~XX140 19	7E 30 30 31 34 30 20 31 39 0D	Brightness (1)
~XX140 20	7E 30 30 31 34 30 20 32 30 0D	Menu (2)
~XX140 21	7E 30 30 31 34 30 20 32 31 0D	3D(3)
~XX140 22	7E 30 30 31 34 30 20 32 32 0D	HDMI (4)
~XX140 23	7E 30 30 31 34 30 20 32 33 0D	Freeze (5)
~XX140 24	7E 30 30 31 34 30 20 32 34 0D	AV Mute (6)
~XX140 25	7E 30 30 31 34 30 20 32 35 0D	S-Video (7)
~XX140 26	7E 30 30 31 34 30 20 32 36 0D	VGA (8)
~XX140 27	7E 30 30 31 34 30 20 32 37 0D	Video (9)

SEND from projector automatically

232 ASCII Code	HEX Code	Function	Projector Return	Description
		System status	INFO n	n : 0/1/2/3/4/6/7/8 = Standby/Warming/Cooling/Out of Range/Lamp fail/Fan Lock/Over Temperature/Lamp Hours Running Out

READ from projector

232 ASCII Code	HEX Code	Function	Projector Return	Description
~XX121 1	7E 30 30 31 32 31 20 31 0D	Input Source	OKn	n : 0/1/2/3/4/5/6/7/8 = None / VGA1 / VGA2 / S-Video / Video / HDMI / Flash Drive/Presenter/USB Display
~XX122 1	7E 30 30 31 32 32 20 31 0D	Software Version	OKdddd	dddd: FW version
~XX123 1	7E 30 30 31 32 33 20 31 0D	Display Mode	OKn	n : 0/1/2/3/4/5/6/7/8 = None/Presentation/Bright/Movie/sRGB/User/Blackboard/Classroom/3D
~XX124 1	7E 30 30 31 32 34 20 31 0D	Power State	OKn	n : 0/1 = Off/On
~XX125 1	7E 30 30 31 32 35 20 31 0D	Brightness	OKn	
~XX126 1	7E 30 30 31 32 36 20 31 0D	Contrast	OKn	
~XX127 1	7E 30 30 31 32 37 20 31 0D	Aspect Ratio	OKn	(EW675UT/UTi) n: 0/1/2/3/4 = 4:3 / 16:9 or 16:10 * / LBX / Native / AUTO (EX665UT/UTi) n: 0/1/2/3/4 = 4:3 / 16:9-I / 16:9-II / Native / AUTO * 16:9 or 16:10 depend on Screen Type setting
~XX128 1	7E 30 30 31 32 38 20 31 0D	Color Temperature	OKn	n : 0/1/2 = Warm/Medium/Cold
~XX129 1	7E 30 30 31 32 39 20 31 0D	Projection Mode	OKn	n : 0/1/2/3 = Front-Desktop/Rear-Desktop/Front-Ceiling/Rear-Ceiling
~XX150 1	7E 30 30 31 35 30 20 31 0D	Information	OKabbbccddde	a : 0/1 = Off/On bbbb: LampHour cc: source 00/01/02/03/04/05/06/07/08 = None/VGA1 / VGA2/S-Video/Video/HDMI/Flash Drive/Presenter/USB Display dddd: FW version e : Display mode 0/1/2/3/4/5/6/7/8 None/Presentation/Bright/Movie/sRGB/User/Blackboard/Classroom/3D
~XX151 1	7E 30 30 31 35 31 20 31 0D	Model name	OKn	n: 17/18/19=EX665UT(UTi) / EW675UT(UTi) / EX565UT
~XX108 1	7E 30 30 31 30 38 20 31 0D	Lamp Hours	OKbbbb	bbbb: LampHour
~XX108 2	7E 30 30 31 30 38 20 31 0D	Cumulative Lamp Hours	OKbbbb	bbbb: (5 digits) Total Lamp Hours

Wall Mount Installation

1. To prevent damage to your projector, please use the Optoma ceiling mount.
2. If you wish to use a third party ceiling mount kit, please ensure the screws used to attach a mount to the projector meet the following specifications:

- ▶ Screw type: M4*4
- ▶ Maximum screw length: 11mm
- ▶ Minimum screw length: 8mm



❖ Please note that damage resulting from incorrect installation will void the warranty.



⚠ Warning:

1. If you buy a ceiling mount from another company, please be sure to use the correct screw size. Screw size will vary depending on the thickness of the mounting plate.
2. Be sure to keep at least 10 cm gap between the ceiling and the bottom of the projector.
3. Avoid installing the projector near a heat source.

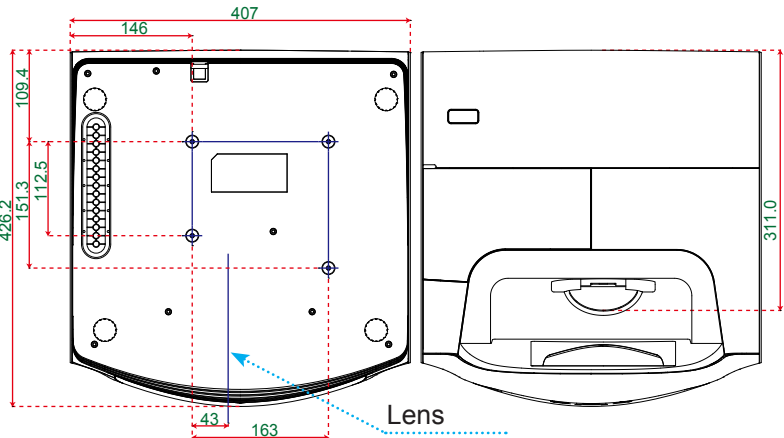
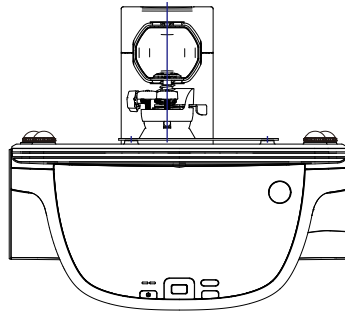

Unit: mm

Optoma Global Offices

For service or support please contact your local office.

USA

3178 Laurelview Ct.
Fremont, CA 94538, USA
www.optomausa.com

 888-289-6786
 510-897-8601
 services@optoma.com

Canada

2420 Meadowpine Blvd., Suite #105
Mississauga, ON, L5N 6S2, Canada
www.optoma.ca

 888-289-6786
 510-897-8601
 services@optoma.com



Europe

42 Caxton Way, The Watford Business Park
Watford, Hertfordshire,
WD18 8QZ, UK
www.optoma.eu
Service Tel : +44 (0)1923 691865

 +44 (0) 1923 691 800
 +44 (0) 1923 691 888
 service@tsc-europe.com



France

Bâtiment E
81-83 avenue Edouard Vaillant
92100 Boulogne Billancourt, France

 +33 1 41 46 12 20
 +33 1 41 46 94 35
 savoptoma@optoma.fr



Spain

C/ José Hierro, 36 Of. 1C
28522 Rivas VaciaMadrid,
Spain

 +34 91 499 06 06
 +34 91 670 08 32



Deutschland

Wiesenstrasse 21 W
D40549 Düsseldorf,
Germany

 +49 (0) 211 506 6670
 +49 (0) 211 506 66799
 info@optoma.de

Scandinavia

Lerpeveien 25
3040 Drammen
Norway



 +47 32 98 89 90
 +47 32 98 89 99
 info@optoma.no

PO.BOX 9515
3038 Drammen
Norway

Appendices



Benelux BV

Randstad 22-123
1316 BW Almere
The Netherlands

 +31 (0) 36 820 0253
 +31 (0) 36 548 9052
www.optoma.nl



Latin America

3178 Laurelview Ct.
Fremont, CA 94538, USA
www.optomausa.com

 888-289-6786
 510-897-8601
 services@optoma.com

Korea

WOOMI TECH.CO.,LTD.
4F,Minu Bldg.33-14, Kangnam-Ku,
seoul,135-815, KOREA

 +82+2+34430004
 +82+2+34430005



Japan

東京都足立区綾瀬3-25-18
株式会社オーエスエム
サポートセンター:0120-46-5040

 info@osscreen.com
www.os-worldwide.com



Taiwan

5F., No. 108, Minchiuan Rd.
Shindian City,
Taipei Taiwan 231, R.O.C.
www.optoma.com.tw

 +886-2-2218-2360
 +886-2-2218-2313
 services@optoma.com.tw
asia.optoma.com



Hong Kong

Unit A, 27/F Dragon Centre,
79 Wing Hong Street,
Cheung Sha Wan,
Kowloon, Hong Kong

 +852-2396-8968
 +852-2370-1222
www.optoma.com.hk

China

5F, No. 1205, Kaixuan Rd.,
Changning District
Shanghai, 200052, China

 +86-21-62947376
 +86-21-62947375
www.optoma.com.cn

Regulation & Safety Notices

This appendix lists the general notices of your projector.

FCC notice

This device has been tested and found to comply with the limits for a Class B digital device pursuant to Part 15 of the FCC rules. These limits are designed to provide reasonable protection against harmful interference in a residential installation. This device generates, uses and can radiate radio frequency energy and, if not installed and used in accordance with the instructions, may cause harmful interference to radio communications.

However, there is no guarantee that interference will not occur in a particular installation. If this device does cause harmful interference to radio or television reception, which can be determined by turning the device off and on, the user is encouraged to try to correct the interference by one or more of the following measures:

- Reorient or relocate the receiving antenna.
- Increase the separation between the device and receiver.
- Connect the device into an outlet on a circuit different from that to which the receiver is connected.
- Consult the dealer or an experienced radio/television technician for help.

Notice: Shielded cables

All connections to other computing devices must be made using shielded cables to maintain compliance with FCC regulations.

Caution

Changes or modifications not expressly approved by the manufacturer could void the user's authority, which is granted by the Federal Communications Commission, to operate this projector.

Appendices

Operation conditions

This device complies with Part 15 of the FCC Rules. Operation is subject to the following two conditions:

1. This device may not cause harmful interference and
2. This device must accept any interference received, including interference that may cause undesired operation.

Notice: Canadian users

This Class B digital apparatus complies with Canadian ICES-003.

Remarque à l'intention des utilisateurs canadiens

Cet appareil numérique de la classe B est conforme à la norme NMB-003 du Canada.

Declaration of Conformity for EU countries

- EMC Directive 2004/108/EC (including amendments)
- Low Voltage Directive 2006/95/EC
- R & TTE Directive 1999/5/EC (if product has RF function)

Disposal instructions



Do not throw this electronic device into the trash when discarding. To minimize pollution and ensure utmost protection of the global environment, please recycle it.