

# Table of Contents

Table of Contents .....	1	SETUP   Advanced .....	40
Usage Notice .....	2	SETUP   Network .....	41
Safety Information .....	2	OPTIONS .....	46
Precautions .....	3	OPTIONS   Advanced .....	47
Eye Safety Warnings .....	5	OPTIONS   Lamp Settings .....	48
Product Features .....	5	Network Application System	
Introduction .....	6	Introduction .....	49
Package Overview .....	6	How to use Web Administration .....	49
Product Overview .....	7	How to use Multi-media Card Reader	
Main Unit .....	7	Application .....	56
Control Panel .....	8	How to use the Optoma Presenter	
Input/Output Connections .....	9	System .....	59
Remote Control .....	10	Appendices .....	64
Installation .....	11	Troubleshooting .....	64
Connecting the Projector .....	11	Replacing the lamp .....	69
Connect to Computer/Notebook .....	11	Compatibility Modes .....	71
Connect to Video Sources .....	12	Computer Compatibility .....	71
Powering the projector On / Off .....	13	Video Compatibility .....	73
Powering On the Projector .....	13	RS232 Commands and Protocol	
Powering Off the Projector .....	14	Function List .....	74
Warning Indicator .....	14	RS232 Pin Assignments .....	74
Adjusting the Projected Image .....	15	RS232 Protocol Function List .....	75
Adjusting the Projector's Height .....	15	Wall Mount Installation .....	79
Adjusting the Projector's Zoom /		Optoma Global Offices .....	80
Focus .....	16	Regulation & Safety Notices .....	82
Adjusting Projection Image Size .....	16		
User Controls .....	18		
Control Panel & Remote Control .....	18		
Control Panel .....	18		
Remote Control .....	19		
On-screen Display Menus .....	24		
How to operate .....	24		
Menu Tree .....	25		
IMAGE .....	27		
IMAGE   Advanced .....	29		
DISPLAY .....	31		
DISPLAY   3D .....	34		
SETUP .....	35		
SETUP   Signal (RGB) .....	37		
SETUP   Security .....	38		

## Safety Information

	The lightning flash with arrow head within an equilateral triangle is intended to alert the user to the presence of uninsulated "dangerous voltage" within the product's enclosure that may be of sufficient magnitude to constitute a risk of electric shock to persons.
	The exclamation point within an equilateral triangle is intended to alert the user to the presence of important operating and maintenance (servicing) instructions in the literature accompanying the appliance.

**WARNING:** TO REDUCE THE RISK OF FIRE OR ELECTRIC SHOCK, DO NOT EXPOSE THIS APPLIANCE TO RAIN OR MOISTURE. DANGEROUS HIGH VOLTAGES ARE PRESENT INSIDE THE ENCLOSURE. DO NOT OPEN THE CABINET. REFER SERVICING TO QUALIFIED PERSONNEL ONLY.

### **Class B emissions limits**

This Class B digital apparatus meets all requirements of the Canadian Interference-Causing Equipment Regulations.

### **Important Safety Instruction**

1. Do not block any ventilation openings. To ensure reliable operation of the projector and to protect from over heating, it is recommended to install the projector in a location that does not block ventilation. As an example, do not place the projector on a crowded coffee table, sofa, bed, etc. Do not put the projector in an enclosure such as a book case or a cabinet that restricts air flow.
2. Do not use the projector near water or moisture. To reduce the risk of fire and/or electric shock, do not expose the projector to rain or moisture.
3. Do not install near heat sources such as radiators, heaters, stoves or any other apparatus such as amplifiers that emits heat.
4. Clean only with dry cloth.
5. Only use attachments/accessories specified by the manufacturer.
6. Do not use the unit if it has been physically damaged or abused.  
Physical damage/abuse would be (but not limited to):
  - Unit has been dropped.
  - Power supply cord or plug has been damaged.
  - Liquid has been spilled on to the projector.
  - Projector has been exposed to rain or moisture.
  - Something has fallen in the projector or something is loose inside.Do not attempt to service the unit yourself. Opening or removing covers may expose you to dangerous voltages or other hazards. Please call Optoma before you send the unit for repair.
7. Do not let objects or liquids enter the projector. They may touch dangerous voltage points and short out parts that could result in fire or electric shock.
8. See projector enclosure for safety related markings.
9. The unit should only be repaired by appropriate service personnel.

## Precautions



*Please follow all warnings, precautions and maintenance as recommended in this user's guide.*

- Warning- Do not look into the projector's lens when the lamp is on. The bright light may hurt and damage your eyes.
- Warning- To reduce the risk of fire or electric shock, do not expose this projector to rain or moisture.
- Warning- Please do not open or disassemble the projector as this may cause electric shock.
- Warning- When replacing the lamp, please allow the unit to cool down. Follow instructions as described on pages 69-70.
- Warning- This projector will detect the life of the lamp itself. Please be sure to change the lamp when it shows warning messages.
- Warning- Reset the "Lamp Reset" function from the on-screen display "OPTIONS | Lamp Settings" menu after replacing the lamp module (refer to page 48).
- Warning- When switching the projector off, please ensure the cooling cycle has been completed before disconnecting power. Allow 90 seconds for the projector to cool down.
- Warning- Do not use lens cap when projector is in operation.
- Warning- When the lamp is approaching the end of its lifetime, the message "Lamp Warning: Lamp life exceeded." will show on the screen. Please contact your local reseller or service center to change the lamp as soon as possible.
- Warning- Do not look into or point the laser pointer on your remote control into your or someone's eyes. Laser pointer can cause permanent damage to eyesight.



- ❖ When the lamp reaches the end of its life, the projector will not turn back on until the lamp module has been replaced. To replace the lamp, follow the procedures listed under "Replacing the Lamp" section on pages 69-70.

# Usage Notice

## **Do:**

- ❖ Turn off and unplug the power plug from the AC outlet before cleaning the product.
- ❖ Use a soft dry cloth with mild detergent to clean the display housing.
- ❖ Disconnect the power plug from AC outlet if the product is not being used for a long period of time.

## **Do not:**

- ❖ Block the slots and openings on the unit provided for ventilation.
- ❖ Use abrasive cleaners, waxes or solvents to clean the unit.
- ❖ Use under the following conditions:
  - In extremely hot, cold or humid environments.
    - ▶ Ensure that the ambient room temperature is within 5 - 40°C.
    - ▶ Relative Humidity is 5 - 40°C, 80% (Max.), non-condensing.
  - In areas susceptible to excessive dust and dirt.
  - Near any appliance generating a strong magnetic field.
  - In direct sunlight.

## Eye Safety Warnings



- Avoid staring/facing directly into the projector beam at all times. Keep your back to the beam as much as possible.
- When projector is used in a classroom, adequately supervise students when they are asked to point out something on the screen.
- In order to minimize the lamp power, use room blinds to reduce ambient light levels.

## Product Features



❖ Monitor loop through only supported in VGA1-In/YPbPr.

- SVGA (800x600) Native resolution / XGA (1024x768) Native resolution / WXGA (1280x800) Native resolution
- HD compatible – 720p and 1080p supported
- VGA monitor loop through (works on standby mode > 0.5W)
- BrilliantColor™ Technology
- Security Bar and Kensington Lock
- RS232 control
- Rapid shutdown
- Built-in speakers
- Quick Resume and Eco+ mode
- Network support
- USB display
- Network display
- USB Reader

# Introduction

## Package Overview

*Unpack and inspect the box contents to ensure all parts listed below are in the box. If something is missing, please contact your nearest customer service center.*

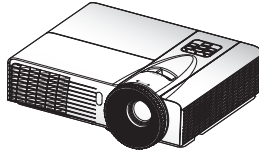

Projector

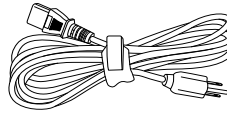

Power Cord

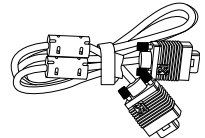

VGA Cable

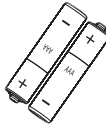

2 × AAA Batteries



IR Remote Control



❖ Due to different applications in each country, some regions may have different accessories.

### Documentation :

- User's Manual
- Warranty Card
- Quick Start Card
- WEEE Card  
(for EMEA only)

## Product Overview

### Main Unit

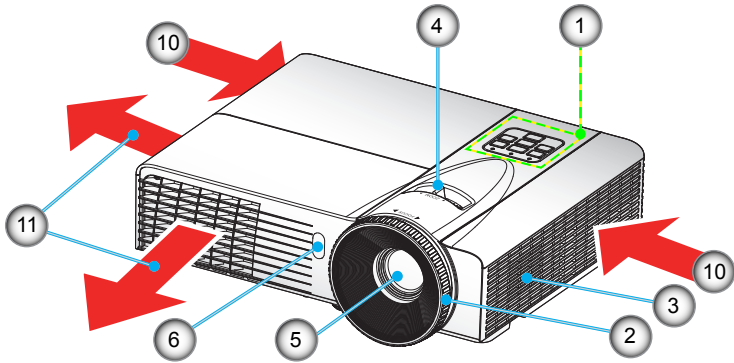

- ❖ The interface is subject to model's specifications.
- ❖ Do not block projector in/out air vents.

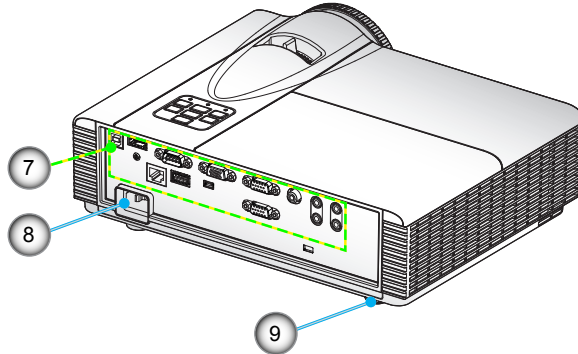

- |                  |                               |
|------------------|-------------------------------|
| 1. Control Panel | 7. Input / Output Connections |
| 2. Focus Ring    | 8. Power Socket               |
| 3. Speaker       | 9. Tilt-Adjustment Feet       |
| 4. Zoom Ring     | 10. Ventilation (inlet)       |
| 5. Lens          | 11. Ventilation (outlet)      |
| 6. IR Receiver   |                               |

# Introduction

## Control Panel

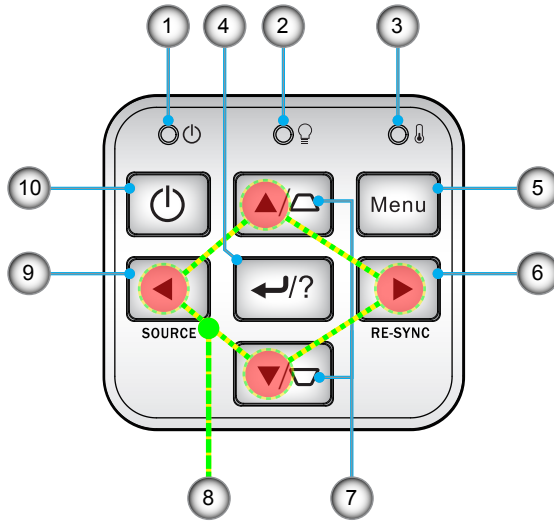

1. Power LED
2. Lamp LED
3. Temp LED
4. Enter / Help
5. Menu
6. Re-Sync
7. Keystone Correction
8. Four Directional Select Keys
9. Source
10. Power/Standby button



## Input/Output Connections

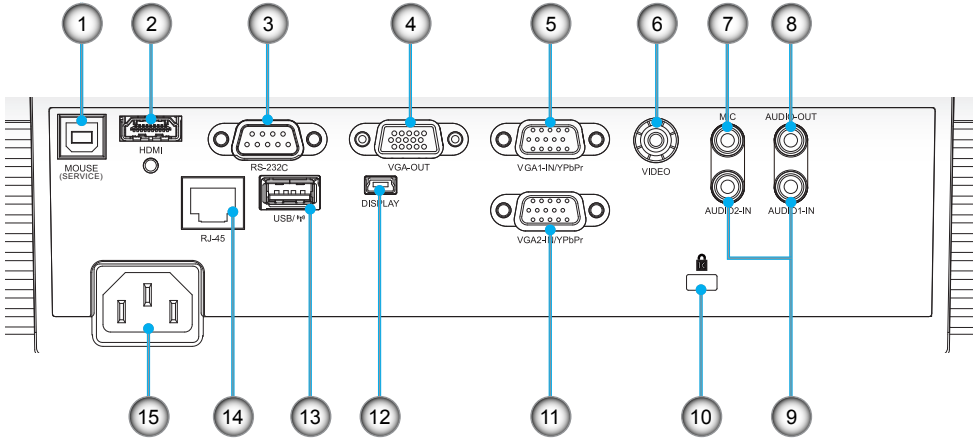

- ❖ The interface is subject to model's specifications.
- ❖ Mini WiFi USB dongle, USB thumb drive, keyboard/mouse, camera, etc are optional accessories.

1. USB Connector (Connect to PC for Remote Mouse function)
2. HDMI Connector
3. RS-232C Connector (9-pin DIN Type)
4. VGA-Out Connector (Monitor Loop-through Output)
5. VGA1-In/YPbPr Connector (PC Analog Signal/Component Video Input/HDTV/YPbPr)
6. Composite Video Input Connector
7. 3.5mm Microphone Input
8. Audio Output Connector (3.5mm Mini Jack)
9. Audio Input connector (3.5mm mini jack)
10. Kensington™ Lock Port
11. VGA2-In/YPbPr Connector (PC Analog Signal/Component Video Input/HDTV/YPbPr)
12. 5pin Mini-USB for Display
13. USB for Mini WiFi Dongle & Thumb drive & Keyboard Mouse.
14. RJ45
15. Power Socket

# Introduction

## Remote Control



❖ The interface is subject to model's specifications.

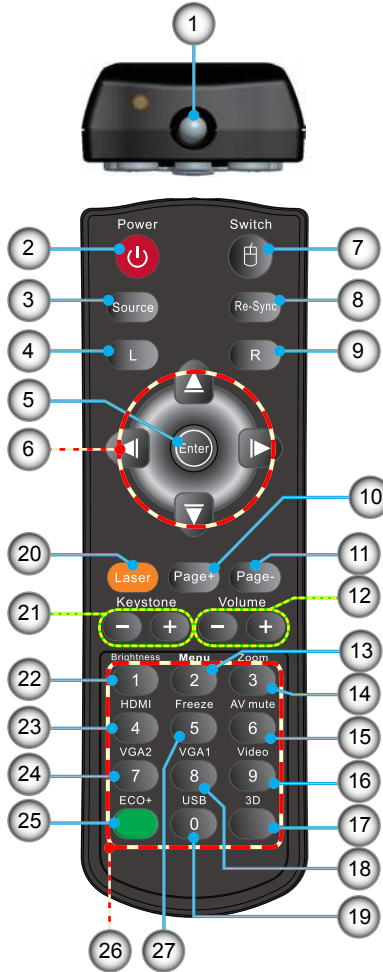

1. LED Indicator
2. Power On/Off
3. Source
4. Mouse Left Click
5. Enter
6. Four Directional Select Keys / Mouse control
7. Switch (turn on/off mouse function)
8. Re-Sync
9. Mouse Right Click
10. Page Up
11. Page Down
12. Volume +/-
13. Menu
14. Zoom
15. AV mute
16. Video
17. 3D
18. VGA1
19. USB
20. Laser Pointer
21. Keystone +/-
22. Brightness
23. HDMI
24. VGA2
25. Eco+
26. Numbered keypad (for password input)
27. Freeze

# Installation

## Connecting the Projector Connect to Computer/Notebook



❖ The interface is subject to model's specifications.



❖ Due to the difference in applications for each country, some regions may have different accessories.

❖ (\*) Optional accessory

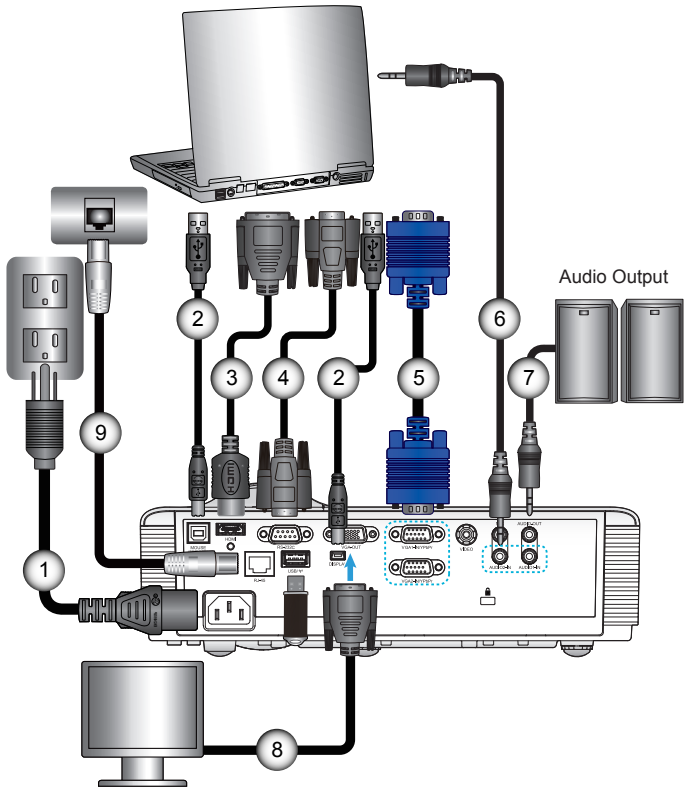

- |        |                     |
|--------|---------------------|
| 1..... | Power Cord          |
| 2..... | *USB Cable          |
| 3..... | *DVI/HDMI Cable     |
| 4..... | *RS232 Cable        |
| 5..... | VGA Cable           |
| 6..... | *Audio Input Cable  |
| 7..... | *Audio Output Cable |
| 8..... | *VGA Output Cable   |
| 9..... | *Network Cable      |

# Installation

## Connect to Video Sources

DVD Player, Set-top Box,  
HDTV receiver

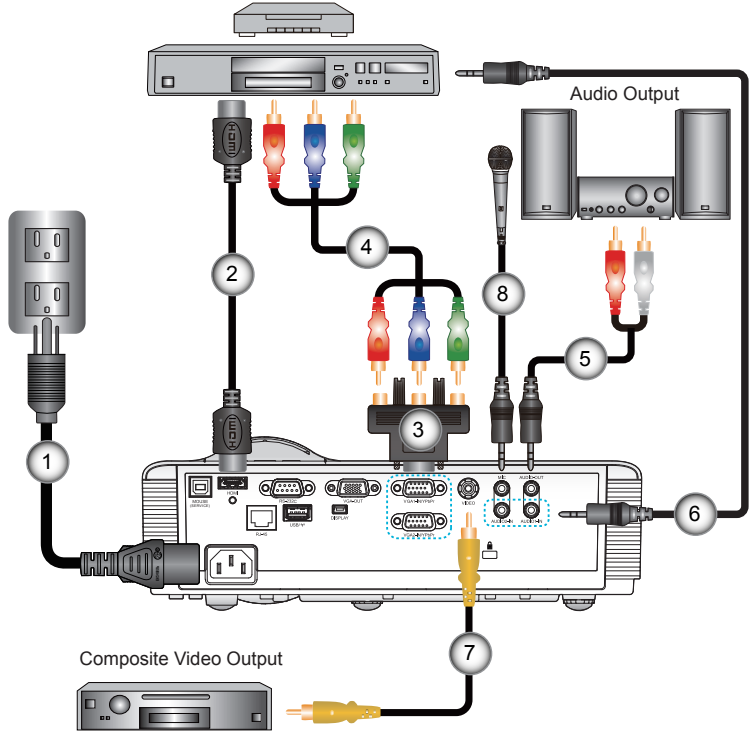

NOTE

- ❖ The interface is subject to model's specifications.

NOTE

- ❖ Due to the difference in applications for each country, some regions may have different accessories.
- ❖ (\*) Optional accessory

- |        |   |
|--------|---|
| 1..... | Power Cord                              |
| 2..... | *HDMI Cable                             |
| 3..... | *15-Pin to 3 RCA Component/HDTV Adaptor |
| 4..... | *3 RCA Component Cable                  |
| 5..... | *Audio Cable Jack/RCA                   |
| 6..... | *Audio Cable Jack/Jack                  |
| 7..... | *Composite Video Cable                  |
| 8..... | *Microphone Cable                       |

# Installation

## Powering the projector On / Off

### Powering On the Projector

1. Remove the lens cap. ❶
2. Securely connect the power cord and signal cable. When connected, the POWER/STANDBY LED will turn Amber.
3. Turn on the lamp by pressing “” button either on the top of the projector or on the remote. The POWER/STANDBY LED will now turn Green. ❷

The startup screen will display in approximately 10 seconds. The first time you use the projector, you will be asked to select the preferred language and power saving mode.

4. Turn on and connect the source that you want to display on the screen (computer, notebook, video player, etc). The projector will detect the source automatically. If not, push menu button and go to “OPTIONS”. Make sure that the “Source Lock” has been set to “Off”.
- ❖ If you connect multiple sources at the same time, press the “SOURCE” button on the control panel or direct source keys on the remote control to switch between inputs.



❖ When Power mode (Standby) is set to Eco (<0.5W), the VGA output and Audio pass-through will be deactivated when the projector is in standby.



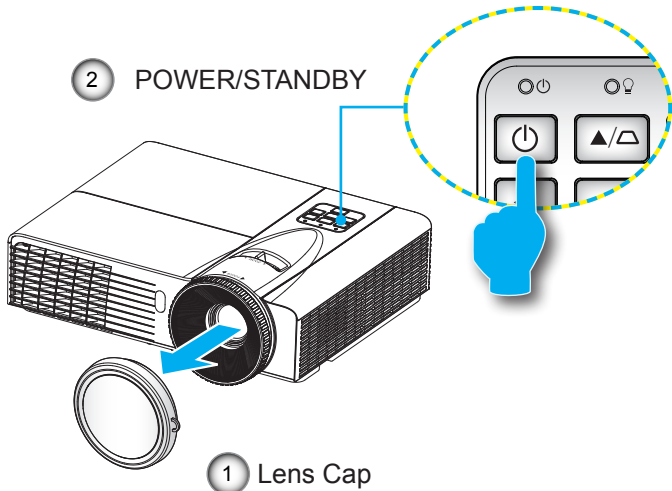

❖ Turn on the projector first and then select the signal sources.

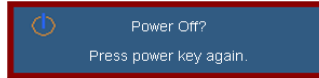

## Powering Off the Projector

1. Press the “” button on the remote control or on the control panel to turn off the projector. The following message will be displayed on the screen.



Press the “” button again to confirm otherwise the message will disappear after 15 seconds. When you press the “” button for the second time, the fans will speed up to cool down the projector and will shut down in 10 seconds. During this time, the led will flash green.

2. The cooling fans continue to operate for about 10 seconds for cooling cycle and the POWER/STANDBY LED will Flash Green. When the POWER/STANDBY LED lights solid Amber, the projector has entered standby mode.

If you wish to turn the projector back on, you must wait until the projector has completed the cooling cycle and has entered standby mode. Once in standby mode, simply press “” button to restart the projector.

3. Only disconnect the power cord when the projector is in standby mode (solid amber led).

## Warning Indicator

When the warning indicators (see below) come on, the projector will automatically shutdown:



- ❖ Contact the nearest service center if the projector displays these symptoms. See pages 80-81 for more information.
- ❖ “LAMP” LED indicator is lit red and if “POWER/STANDBY” indicator flashes amber.
- ❖ “TEMP” LED indicator is lit red and if “POWER/STANDBY” indicator flashes amber. This indicates the projector has overheated. Under normal conditions, the projector can be switched back on.
- ❖ “TEMP” LED indicator flashes red and if “POWER/STANDBY” indicator flashes amber.

Unplug the power cord from the projector, wait for 30 seconds and try again. If the warning indicator light up again, please contact your nearest service center for assistance.

## Adjusting the Projected Image

### Adjusting the Projector's Height

*The projector is equipped with elevator feet for adjusting the image height.*

1. Locate the adjustable foot you wish to modify on the underside of the projector.
2. Rotate the adjustable ring clockwise to raise the projector or counter clockwise to lower it. Repeat with the remaining feet as needed.

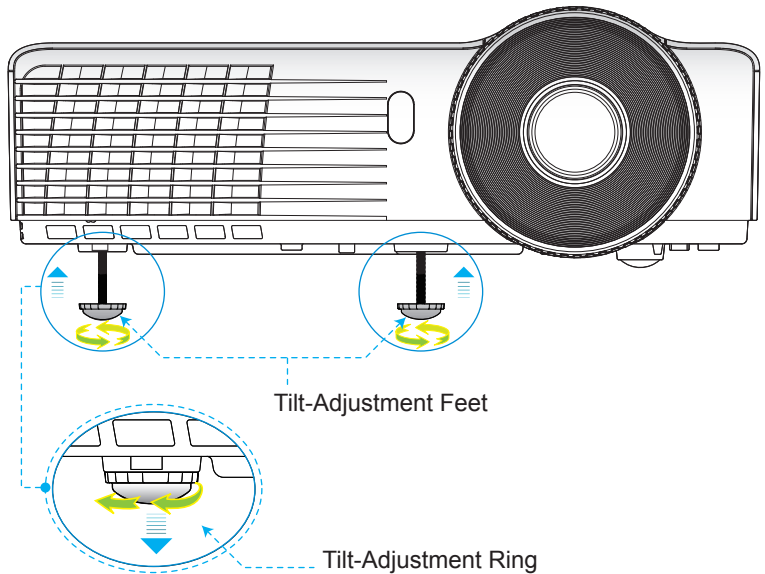

# Installation

## Adjusting the Projector's Zoom / Focus

You may turn the zoom ring to zoom in or out. To focus the image, rotate the focus ring until the image is clear.

- ▶ SVGA/XGA/WXGA series: The projector will focus at distances from 3.94 to 32.8 feet (1.2 to 10.0 meters).

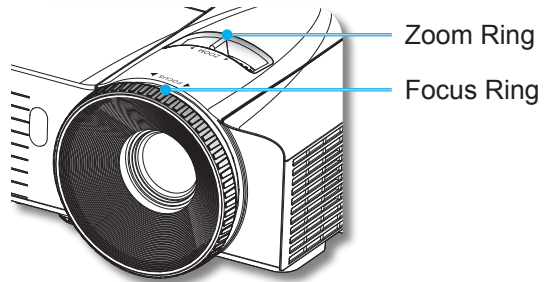

## Adjusting Projection Image Size

- ▶ SVGA/XGA series: Projection Image Size from 30" to 307.0" (0.7 to 7.8 meters).
- ▶ WXGA series: Projection Image Size from 36.3" to 362" (0.9 to 9.2 meters).

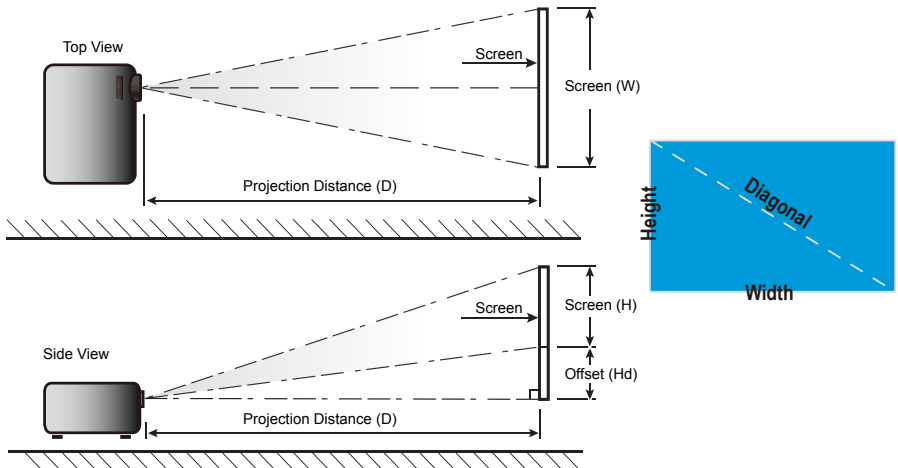



# Installation

## SVGA/XGA

Diagonal length (inch) size of 4:3 Screen	Screen Size W x H				Projection Distance (D)				Offset (Hd)	
	(m)		(inch)		(m)		(feet)			
	Width	Height	Width	Height	wide	tele	wide	tele	(m)	(inch)
30.00	0.61	0.46	24.00	18.00	0.98	1.17	3.20	3.84	0.07	2.70
40.00	0.81	0.61	32.00	24.00	1.30	1.56	4.27	5.12	0.09	3.60
60.00	1.22	0.91	48.00	36.00	1.95	2.34	6.40	7.68	0.14	5.40
70.00	1.42	1.07	56.00	42.00	2.28	2.73	7.47	8.96	0.16	6.30
80.00	1.63	1.22	64.00	48.00	2.60	3.12	8.53	10.24	0.18	7.20
90.00	1.83	1.37	72.00	54.00	2.93	3.51	9.60	11.52	0.21	8.10
100.00	2.03	1.52	80.00	60.00	3.25	3.90	10.67	12.80	0.23	9.00
120.00	2.44	1.83	96.00	72.00	3.90	4.68	12.80	15.36	0.27	10.80
150.00	3.05	2.29	120.00	90.00	4.88	5.85	16.00	19.20	0.34	13.50
180.00	3.66	2.74	144.00	108.00	5.85	7.02	19.20	23.04	0.41	16.20
250.00	5.08	3.81	200.00	150.00	8.13	9.75	26.67	32.00	0.57	22.50
307.00	6.24	4.68	245.60	184.20	9.98	11.98	32.75	39.30	0.70	27.63

❖ This table is for user's reference only.

## WXGA

Diagonal length (inch) size of 16:10 Screen	Screen Size W x H				Projection Distance (D)				Offset (Hd)	
	(m)		(inch)		(m)		(feet)			
	Width	Height	Width	Height	wide	tele	wide	tele	(m)	(inch)
36.30	0.78	0.49	30.78	19.24	1.00	1.20	3.28	3.94	0.06	2.39
40.00	0.86	0.54	33.92	21.20	1.10	1.32	3.62	4.34	0.07	2.63
60.00	1.29	0.81	50.88	31.80	1.65	1.99	5.43	6.51	0.10	3.94
70.00	1.51	0.94	59.36	37.10	1.93	2.32	6.33	7.6	0.12	4.60
80.00	1.72	1.08	67.84	42.40	2.21	2.65	7.24	8.68	0.13	5.26
90.00	1.94	1.21	76.32	47.70	2.48	2.98	8.14	9.77	0.15	5.91
100.00	2.15	1.35	84.80	53.00	2.76	3.31	9.05	10.85	0.17	6.57
120.00	2.58	1.62	101.76	63.60	3.31	3.97	10.85	13.03	0.20	7.89
150.00	3.23	2.02	127.20	79.50	4.14	4.96	13.57	16.28	0.25	9.86
180.00	3.88	2.42	152.64	95.40	4.96	5.96	16.28	19.54	0.30	11.83
250.00	5.38	3.37	212.00	132.50	6.89	8.27	22.61	27.14	0.42	16.43
300.00	6.46	4.04	254.40	159.00	8.27	9.93	27.14	32.56	0.50	19.72
362.00	7.80	4.87	306.98	191.86	9.98	11.98	32.74	39.29	0.60	23.79

❖ This table is for user's reference only.

## Control Panel & Remote Control

### Control Panel



#### Using the Control Panel

POWER		Refer to the “Power On/Off the Projector” section on pages 13-14.
RE-SYNC		Automatically synchronize the projector to the input source.
Enter / Help		Confirm your item selection. Help Menu (only available when OSD menu is not shown).
SOURCE		Press “SOURCE” to select an input signal.
Menu		Press “Menu” to launch the on-screen display (OSD) menu. To exit OSD, Press “Menu” again.
Four Directional Select Keys		Use     to select items or make adjustments to your selection.
Keystone		Use  to adjust image distortion caused by tilting the projector. (±40 degrees)
Lamp LED		Indicate the projector’s lamp status.
Temp LED		Indicate the projector’s temperature status.
POWER/ STANDBY LED		Indicate the projector’s status.

# User Controls

## Remote Control

### Using the Remote Control



Power		Refer to the “Power On/Off the Projector” section on pages 13-14.
L Button		Mouse left click.
R Button		Mouse right click.
Page +		Use this button to page up.
Page -		Use this button to page down.
Enter		Confirm your item selection.
Source		Press “Source” to select an input signal.
Re-SYNC		Automatically synchronizes the projector to the input source.
Four Directional Select Keys		Use ▲ ▼ ◀ ▶ to select items or make adjustments to your selection.
PC/Mouse Control		Use ▲ ▼ ◀ ▶ for emulation of USB mouse via USB when you press “Switch” button.
Keystone +/-		Adjust image distortion caused by tilting the projector.
Volume +/-		Adjust to increase / decrease the volume.
Brightness		Adjust the brightness of the image.
3D		Press the “3D” to turn the 3D OSD menu on/off.
Menu		Press “Menu” to launch the on-screen display (OSD) menu. To exit OSD, press “Menu” again.
HDMI		Press “HDMI” to choose HDMI source.

# User Controls



## Using the Remote Control

Freeze	Press “Freeze” to pause the screen image. Press this button again to unlock.
AV mute	Momentarily turns off/on the audio and video.
VGA1	Press “VGA1” to choose VGA1-In/YPbPr sources.
VGA2	Press “VGA2” to choose VGA2-In/YPbPr sources.
Video	Press “Video” to choose Composite video source.
USB	Display the USB device.
Switch	USB mouse switch. Turns mouse function on/off. Press twice to turn on the mouse function. For the mouse function to work, USB cable must be connected between the projector and computer.
Zoom	Zoom in on an image. Press ◀▶ buttons to alter zoom.
Eco+	When Eco+ mode is activated, the brightness level of the content is automatically detected to significantly reduced lamp power consumption (up to 30%) during periods of inactivity.



- ❖ AV mute: Save up to 70% of the lamp power when AV mute is applied.

## Using the HELP button

The HELP function ensures easy setup and operation.

- ▶ Press the “←/?” button on the control panel to open the Help Menu.

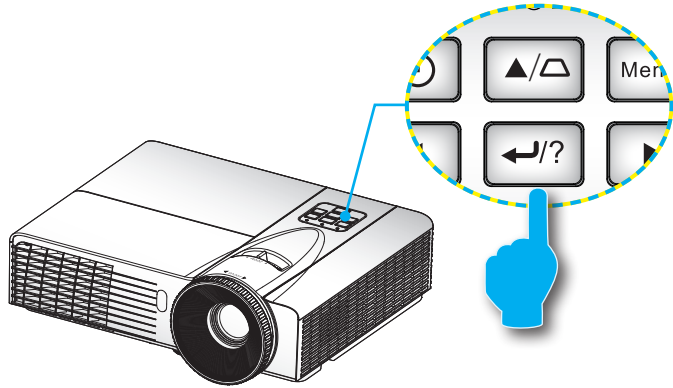

# User Controls

- ▶ Help menu button functions only when no input source is detected.



- ❖ Please refer to the “Troubleshooting” section on pages 64-68 for more details.

The screenshot shows a 'HELP' menu with the following content:

HELP

? No Image appears on-screen.

UpDown Select Menu Exit

No Image appears on-screen.

- ▶ Ensure all the cables and power connections are correctly and securely connected as described in the Installation section of User's Manual.
- ▶ Ensure all the pins of connectors are not bent or broken.
- ▶ Ensure that the [AV MUTE] feature is not turned on.

[NEXT]

[Exit]

UpDown Select Menu Exit

No Image appears on-screen.

- ▶ If you are using a Notebook :
  1. First, follow the steps above to adjust resolution of the computer.
  2. Press the toggle output settings. Example : [Fn]+[F4]

Acer ⇨	[Fn]+[F5]	IBM/Lenovo ⇨	[Fn]+[F7]
Asus ⇨	[Fn]+[F8]	HP/Compaq ⇨	[Fn]+[F4]
Dell ⇨	[Fn]+[F8]	NEC ⇨	[Fn]+[F3]
Gateway ⇨	[Fn]+[F4]	Toshiba ⇨	[Fn]+[F5]

Mac Apple :

System Preference ⇨ Display ⇨ Arrangement ⇨ Mirror display

[PREV]

[Exit]

UpDown Select Menu Exit

- ▶ If input source is detected and help button is pressed, the following pages will appear to help diagnose any problems.

The screenshot shows a 'HELP' menu with the following content:

HELP

- ? Image has slanted sides.
- ? Image is too small or too large.
- ? Image is unstable or flickering.
- ? There is no audio heard or the volume is too low.

UpDown Select Menu Exit

# User Controls

Image has slanted sides.

- ▶ If possible, reposition the projector so that is centered on the screen and below the bottom of the screen.
- ▶ Press [KEYSTONE + / -] button until the sides are vertical on the remote control.

[KEYSTONE + / -]





Image is too small or too large.

- ▶ Adjust the Zoom Ring on the top of projector.
- ▶ Move the projector closer to or further from the screen.
- ▶ Press [MENU] button on the remote control or projector panel, go to "DISPLAY | Format" and try the different settings.

[DISPLAY | Format]



There is no audio heard or the volume is too low.

-  Is the volume setting at the minimum?
  - ▶ Turn up the volume setting.
-  Is the cable connected properly to the projector?
  - ▶ Check the physical connection and ensure the cable is connected properly from the source to projector.

[Volume]



Image is unstable or flickering.

- ▶ Use [Phase / Frequency] to correct it.
- ▶ Change the monitor color setting on your computer.

[Phase]

[Frequency]



## On-screen Display Menus

The Projector has multilingual On-screen Display menus that allow you to make image adjustments and change a variety of settings.

### How to operate

1. To open the OSD menu, press “Menu” on the Remote Control or Projector Keypad.
2. When OSD is displayed, use ◀▶ keys to select any item in the main menu. While making a selection on a particular page, press ▼ or “Enter” key to enter sub menu.
3. Use ▲▼ keys to select the desired item and adjust the settings using ◀▶ key.
4. Select the next item to be adjusted in the sub menu and adjust as described above.
5. Press “Enter” to confirm, and the screen will return to the main menu.
6. To exit, press “MENU” again. The OSD menu will close and the projector will automatically save the new settings.

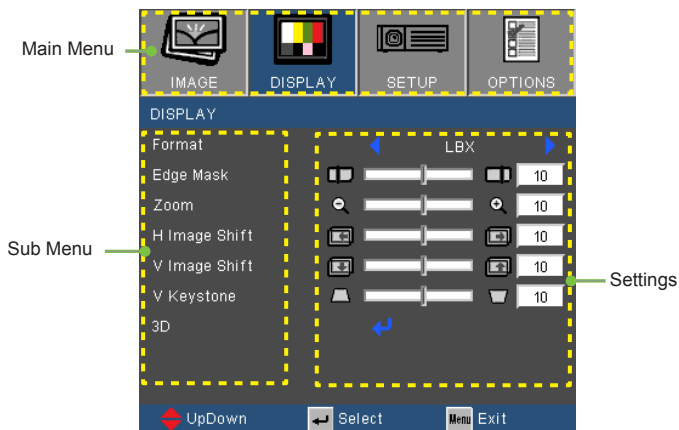



# User Controls

## Menu Tree

Main Menu	Sub Menu	Settings	
<b>Image</b>	Display Mode	Presentation / Bright / Movie / sRGB / Blackboard / Classroom / User / 3D	
	Brightness	-50~50	
	Contrast	-50~50	
	Sharpness	1~15	
	*1 Color	-50~50	
	*1 Tint	-50~50	
	Advanced	Gamma	Film / Video / Graphics / Standard
		BrilliantColor™	0~10
		Color Temp.	Warm / Medium / Cold
		Color Settings	Red Gain / Green Gain / Blue Gain / Red Bias / Green Bias / Blue Bias / Cyan / Magenta / Yellow / Reset / Exit
		Color Space	AUTO / RGB / YUV *6 AUTO / RGB (0-255) / RGB (16-235) / YUV
		Input Source	VGA1 / VGA2 / Video / HDMI / Flash Drive / Network Display / USB Display / Exit
		Exit	
	<b>Display</b>	Format	*3 4:3 / 16:9 or 16:10 / LBX / Native / AUTO *2 4:3 / 16:9-1 / 16:9-II / Native / AUTO
Edge Mask		0~10	
Zoom		-5~25 (80%~200%)	
H Image Shift		-50~50	
V Image Shift		-50~50	
V Keystone		-40~40	
Auto Keystone		On / Off	
3D		3D Mode	Off / DLP-Link / IR
		*4 3D Sync. Invert	On / Off
		Exit	
<b>Setup</b>	Language	English / Deutsch / Français / Italiano / Español / Português / Svenska / Nederlands / Norsk/Dansk / Polski / Suomi / Русский / ελληνικό / Magyar / Čeština / العربية / فارسی / 繁體中文 / 简体中文 / 日本語 / 한국어 / ไทย / Türkçe / Việt / Bahasa Indonesia / Română	
	Projection		
	Menu Location		
	*5 Screen Type	16:10 / 16:9	
	*5 Signal	Automatic	On / Off
		Phase (VGA)	0~31
		Frequency (VGA)	-5~5
		H. Position (VGA)	-5~5
		V. Position (VGA)	-5~5
		Exit	
Security	Security	On / Off	
	Security Timer	Month / Day / Hour	
	Change Password		
	Exit		

# User Controls

Main Menu	Sub Menu	Settings		
<b>Setup</b>	Projector ID	0~99		
	Mute	On / Off		
	Volume	Audio	0~10	
		Mic	0~10	
		Exit		
	Audio Input	Default / Audio1 / Audio2		
	Advanced	Logo	Default / Neutral / User	
		Logo Capture		
		Closed Captioning	Off / CC1 / CC2	
		Exit		
	Network	Network State		
		DHCP		
		IP Address		
		Subnet mask		
		Gateway		
		DNS		
		Apply	Yes / No	
		Exit		
		<b>Options</b>	Source Lock	On / Off
			High Altitude	On / Off
Information Hide	On / Off			
Keypad Lock	On / Off			
Test Pattern	None / Grid / White Pattern			
Background Color	Black / Red / Blue / Green / White			
Advanced	Direct Power On		On / Off	
	Auto Power Off (min.)		0~180	
	Sleep Timer (min.)		0~995	
	Quick Resume		On / Off	
	Power Mode (Standby)		Active / Eco	
	Exit			
Lamp Settings	Lamp Hours			
	Lamp Reminder		On / Off	
	Brightness Mode		Bright / Eco / Eco+	
	Lamp Reset		Yes / No	
	Exit			
Reset				



- ❖ Please note that the on-screen display (OSD) menus vary according to the signal type selected and the projector model you are using.
- ❖ (#1) "Color" and "Tint" are only supported in Video mode.
- ❖ (#2) For XGA model only.
- ❖ (#3) For WXGA model only. 16:9 or 16:10 depend on "Screen Type" setting.
- ❖ (#4) "3D Sync Invert" is only available when 3D is enabled.
- ❖ (#5) "Signal" is only supported in Analog VGA (RGB) signal.
- ❖ (#6) For HDMI source device only.

## IMAGE

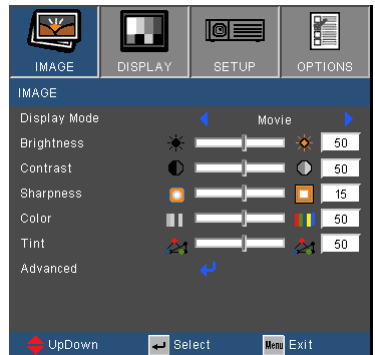

### Display Mode

There are many factory presets optimized for various types of images.

- ▶ Presentation: Good color and brightness from PC input.
- ▶ Bright: Maximum brightness from PC input.
- ▶ Movie: For home theater.
- ▶ sRGB: Standardised accurate color.
- ▶ Blackboard: This mode should be selected to achieve optimum color settings when projecting onto a blackboard (green).
- ▶ Classroom: This mode is recommended for projecting in a classroom.
- ▶ User: User's settings.
- ▶ 3D: Recommend setting for 3D mode enabled. Any further adjustments by the user in 3D will be saved in this mode for further use.

### Brightness

Adjust the brightness of the image.

- ▶ Press the ◀ to darken image.
- ▶ Press the ▶ to lighten the image.

### Contrast

The contrast controls the degree of difference between the lightest and darkest parts of the picture.

- ▶ Press the ◀ to decrease the contrast.
- ▶ Press the ▶ to increase the contrast.

# User Controls



- ❖ “Color” and “Tint” functions are only supported under Video mode.

## Sharpness

Adjust the sharpness of the image.

- ▶ Press the ◀ to decrease the sharpness.
- ▶ Press the ▶ to increase the sharpness.

## Color

Adjust a video image from black and white to fully saturated color.

- ▶ Press the ◀ to decrease the amount of saturation in the image.
- ▶ Press the ▶ to increase the amount of saturation in the image.

## Tint

Adjust the color balance of red and green.

- ▶ Press the ◀ to increase the amount of green in the image.
- ▶ Press the ▶ to increase the amount of red in the image.

## IMAGE | Advanced

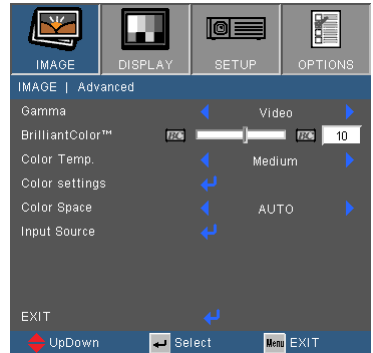

### Gamma

This allows you to choose a degamma table that has been fine-tuned to bring out the best image quality for the input.

- ▶ Film: for home theater.
- ▶ Video: for video or TV source.
- ▶ Graphics: for image source.
- ▶ Standard: for PC or computer source.

### BrilliantColor™

This adjustable item utilizes a new color-processing algorithm and system level enhancements to enable higher brightness while providing true, more vibrant colors in picture. The range is from “0” to “10”. If you prefer a stronger enhanced image, adjust toward the maximum setting. For a smoother, more natural image, adjust toward the minimum setting.

### Color Temp

If set to cold temperature, the image looks more blue. (cold image)  
If set to warm temperature, the image looks more red.

(warm image)

### Color Settings

Press **↵** into the next menu as below and then use **▲** or **▼** to select item.

- ▶ Red Gain/Green Gain/Blue Gain/Red Bias/Green Bias/Blue Bias/Cyan/Magenta/Yellow: Use **◀** or **▶** to select Red, Green, Blue, Cyan, Magenta and Yellow Colors.
- ▶ Reset: Choose “Yes” to return the factory default settings for color adjustments.

# User Controls

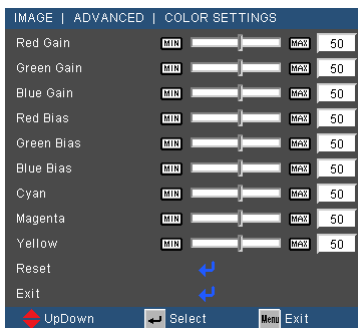

❖ (\*) For HDMI only.

## Color Space

Select an appropriate color matrix type from AUTO, RGB, RGB(0-255)<sup>(\*)</sup>, RGB(16-235)<sup>(\*)</sup> or YUV.

## Input Source

Use this option to enable / disable input sources. Press  to enter the sub menu and select which sources you require. Press “Enter” to finalize the selection. The projector will not search for inputs that are not selected.

## DISPLAY

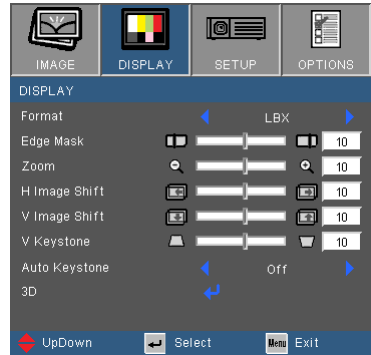

### Format

Use this function to choose your desired aspect ratio.

#### SVGA/XGA

- ▶ 4:3: This format is for 4×3 input sources.
- ▶ 16:9-I: This format is for 16×9 input sources, like HDTV and DVD enhanced for Wide screen TV. (576i/p)
- ▶ 16:9-II: This format is for 16×9 input sources, like HDTV and DVD enhanced for Wide screen TV. (480i/p)
- ▶ Native: This format displays the original image without any scaling.
- ▶ AUTO: Automatically selects the appropriate display format. When input is 4:3, the image is displayed as 4:3. When input is 16:9 above, the image is displayed as 16:9- I

Aspect ratio (source detected)	Resize image	
	SVGA model	XGA model
4:3	800 x 600 center	1024 x 768 center
16:9-I	800 x 450 center	1024 x 576 center
16:9-II	800 x 480 center	854 x 480 center
Native	No resize image, 1:1 mapping and centered. This format shows the original image without scaling.	

# User Controls



❖ 16:9 or 16:10 depend on “Screen Type” setting.

## WXGA

- ▶ 4:3: This format is for 4×3 input sources.
- ▶ 16:9: This format is for 16×9 input sources, like HDTV and DVD enhanced for Wide screen TV.
- ▶ 16:10: This format is for 16×10 input sources, like widescreen laptops.
- ▶ LBX: This format is for non-16x9, letterbox source and for users who use external 16x9 lens to display 2.35:1 aspect ratio using full resolution.
- ▶ Native: This format displays the original image without any scaling.
- ▶ AUTO: Automatically selects the appropriate display format.

16:10 Screen	480i/p	576i/p	1080i/p	720p	PC
4:3	1066 x 800 center				
16:10	1280 x 800 center				
LBX	1280 x 960 center, then get the central 1280 x 800 image to display				
Native	1:1 mapping centered.		1:1 mapping (960 x 540) display 1280 x 800	1280 x 720 center	1:1 mapping centered.

16:9 Screen	480i/p	576i/p	1080i/p	720p	PC
4:3	960 x 720 center				
16:9	1280 x 720 center				
LBX	1280 x 960 center, then get the central 1280 x 720 image to display				
Native	1:1 mapping centered.		1:1 mapping (960 x 540) display 1280 x 720	1280 x 720 center	1:1 mapping centered.





- ❖ Each I/O has different setting of “Edge mask”.
- ❖ “Edge mask” and “Zoom” can’t work at same time.

## Edge Mask

Edge mask function removes the noise in a video image. Edge mask the image to remove video encoding noise on the edge of video source.

## Zoom

- ▶ Press the ◀ to reduce the size of an image.
- ▶ Press the ▶ to magnify an image on the projection screen.

## H Image Shift

Shift the projected image position horizontally.

## V Image Shift

Shift the projected image position vertically.

## V Keystone

Press the ◀ or ▶ to adjust image distortion vertically. If the image looks trapezoidal, this option can help make the image rectangular.

## Auto Keystone

Automatically adjusts vertical image distortion.

## DISPLAY | 3D

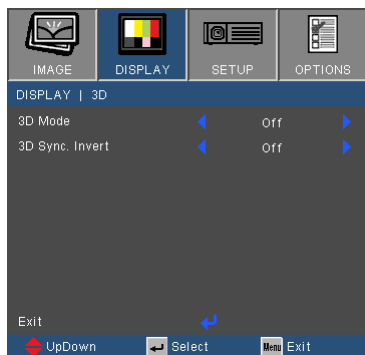

- ❖ “IR” options may vary according to model.
- ❖ “3D Sync Invert” is only available when 3D is enabled and this mode 3D is for DLP link glass only.
- ❖ Compatible 3D source, 3D content and active shutter glasses are required for 3D viewing.

### 3D Mode

- ▶ Off: Select “Off” to turn 3D settings off for 3D images.
- ▶ DLP Link: Select “DLP Link” to use optimized settings for DLP Link 3D images.
- ▶ IR: Select “IR” to use optimized settings for IR-based 3D images.

### 3D Sync. Invert

- ▶ Press the “On” to invert left and right frame contents.
- ▶ Press the “Off” for default frame contents.

## SETUP

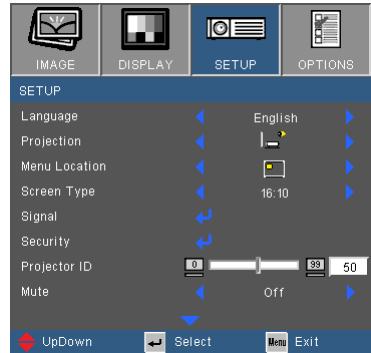

- ❖ “SETUP” options may vary according to model.

### Language





Choose the multilingual OSD menu. Press ◀ or ▶ into the sub menu and then use the ▲ or ▼ key to select your preferred language. Press “Enter” to finalize the selection.



### Projection



- ❖ Rear-Desktop and Rear-Ceiling are to be used with a translucent screen.

- ▶  **Front-Desktop**  
This is the default selection. The image is projected straight on the screen.
- ▶  **Front-Ceiling**  
When selected, the image will turn upside down.
- ▶  **Rear-Desktop**  
When selected, the image will appear reversed.
- ▶  **Rear-Ceiling**  
When selected, the image will appear reversed in upside down position.

# User Controls

## Menu Location

Choose the menu location on the display screen.

## Screen Type

Choose the screen type from 16:10 or 16:9.



- ❖ “Screen Type” is for WXGA only.

## Projector ID

ID definition can be set up by menu (range 0-99), and allow user control an individual projector by RS232. Refer to pages 74-78 for the complete list of RS232 commands.

## Mute

- ▶ Choose the “On” to turn mute on.
- ▶ Choose the “Off” to turn mute off.

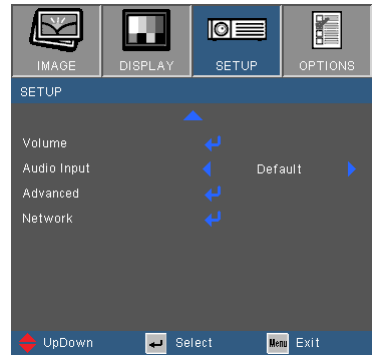

## Volume

Adjust the volume from “Audio”, “MIC” connector.

- ▶ Press the ◀ to decrease the volume.
- ▶ Press the ▶ to increase the volume.

## Audio Input

The default audio settings are on the back panel of the projector. Use this option to reassign any of the Audio Inputs (1 or 2) to the current image source. Each Audio input can be assigned to more than one video source.

- ▶ Audio 1: VGA 1 and VGA 2.
- ▶ Audio 2: Video.

## SETUP | Signal (RGB)

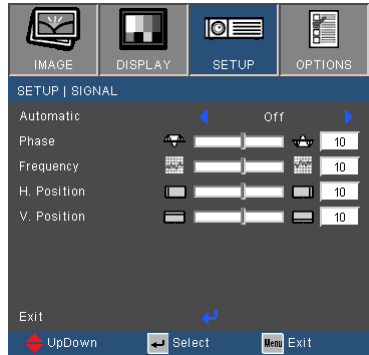

- ❖ “Signal” is only supported in Analog VGA (RGB) signal.

### Automatic

Automatically selects the signal. If you use this function, the Phase, frequency items are grayed out, and if Signal is not automatic, the phase, frequency items will appear for user to manually tune and saved in settings after that for next time projector turns off and on again.

### Phase

Synchronize the signal timing of the display with the graphic card. If the image appears to be unstable or flickers, use this function to correct it.

### Frequency

Change the display data frequency to match the frequency of your computer’s graphic card. Use this function only if the image appears to flicker vertically.

### H. Position

- ▶ Press the ◀ to move the image left.
- ▶ Press the ▶ to move the image right.

### V. Position

- ▶ Press the ◀ to move the image down.
- ▶ Press the ▶ to move the image up.

## SETUP | Security

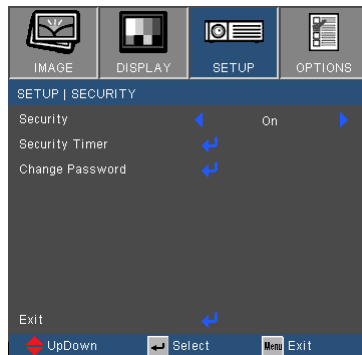

### Security

- ▶ On: Choose “On” to use security verification when the turning on the projector.
- ▶ Off: Choose “Off” to be able to switch on the projector without password verification.



❖ Password default value is “1234” (first time).

### Security Timer

Use this function to set the how long (Month/Day/Hour) the projector can be used. Once this time has elapsed you will be requested to enter your password again.

### Change Password

- ▶ First time:
  1. Press “←” to set the password.
  2. The password has to be 4 digits.
  3. Use number button on the remote to enter your new password and then press “←” key to confirm your password.
- ▶ Change Password:
  1. Press “←” to input old password.
  2. Use number button to enter current password and then press “←” to confirm.
  3. Enter new password (4 digits in length) using the number buttons on the remote, then press “←” to confirm.
  4. Enter new password again and press “←” to confirm.

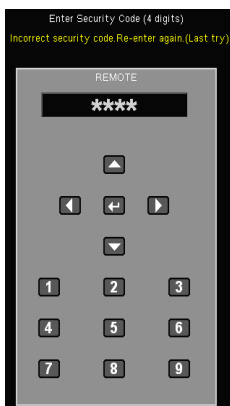



# *User Controls*

- ▶ If the incorrect password is entered 3 times, the projector will automatically shut down.
- ▶ If you have forgotten your password, please contact your local office for support.

## SETUP | Advanced

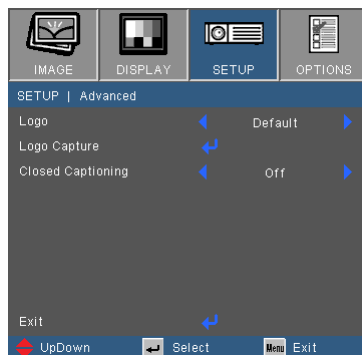

### Logo

Use this function to set the desired startup screen. If changes are made they will take effect the next time the projector is powered on.

- ▶ Default: The default startup screen.
- ▶ Neutral: Logo is not displayed on startup screen.
- ▶ User: Use stored picture from “Logo Capture” function.



❖ For successful logo capture, please ensure that the on-screen image does not exceed the projector's native resolution. (XGA:1024x768 or WXGA:1280x800).

### Logo Capture

Press  to capture an image of the picture currently displayed on screen.

### Closed Captioning

Use this function to set the desired startup screen. If changes are made they will take effect the next time the projector is powered on.

- ▶ Off: select “off” to turn off the closed captioning feature.
- ▶ CC1:CC1 language: American English.
- ▶ CC2:CC2 language (depending on the TV channel of the user):Spanish, French, Portuguese, German, Danish.



## SETUP | Network

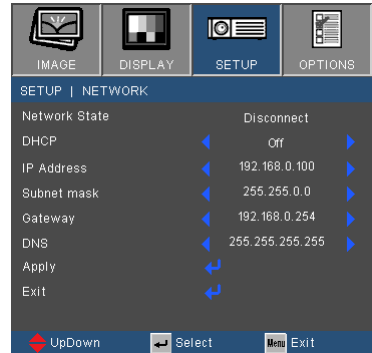

### Network State

Display the network connection status.

### DHCP

Use this function to select your desired startup screen. If you change the setting from one to another, when you exit the OSD menu, the new setting will take effect on next open.

- ▶ On: Assign an IP address to the projector from an external DHCP server automatically.
- ▶ Off: Assign an IP address manually.

### IP Address

Select an IP address.

### Subnet Mask

Select subnet mask number.

### Gateway

Select the default gateway of the network connected to the projector.

### DNS

Select DNS number.

### Apply

Press “←” and then choose “Yes” to apply the selection.

# User Controls

## How to use web browser to control your projector

1. Turn on DHCP to allow the DHCP server to automatically assign an ip address or keep DHCP off to manually enter the network information

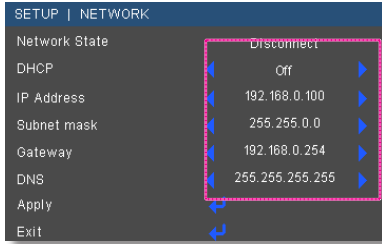

2. Then choose apply and press “↵” button to complete the configuration process.
3. Open your web browser and type in the projector’s ip address to access the Crestron control page.



4. Please see below for keyboard character keys space limitation.

Category	Item	Input-Length (characters)
Crestron Control	IP Address	15
	IP ID	2
	Port	5
Projector	Projector Name	20
	Location	9
	Assigned To	9
Network Configuration	DHCP (Enabled)	(N/A)
	IP Address	15
	Subnet Mask	15
	Default Gateway	15
	DNS Server	15
User Password	Enabled	(N/A)
	New Password	15
	Confirm	15
Admin Password	Enabled	(N/A)
	New Password	15
	Confirm	15

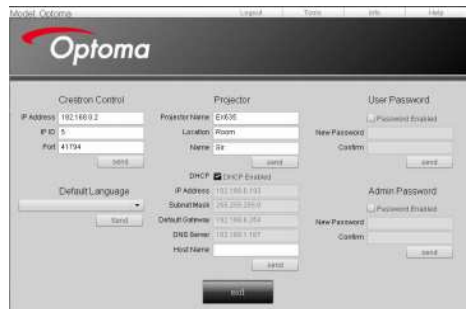

# User Controls

**Below is an example on how to do a quick network setup**

Step 1: Assign an ip address of 192.168.0.100 and subnet mask of 255.255.255.0.



Step 2: Select apply and press enter to save the changes and then exit the menu.

Step 3: To open Network Connections, click **Start**, click **Control Panel**, click **Network and Internet Connections**, and then click **Network Connections**. Click the connection you want to configure, and then, under **Network Tasks** , click **Change settings of this connection**.

Step 4: On the **General** tab, under **This connection uses the following items**, click **Internet Protocol (TCP/IP)**, and then click "Properties."

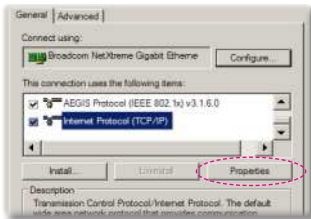

Step 5: Click **Use the following IP address**, and type in as below:

- 1) IP address: 192.168.0.101
- 2) Subnet mask: 255.255.255.0
- 3) Default gateway: 192.168.0.254

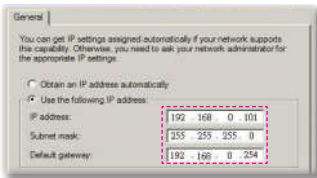

Step 6: To open Internet Options, click IE web browser, click Internet Options, click the **Connections** tab and click "LAN Settings..."

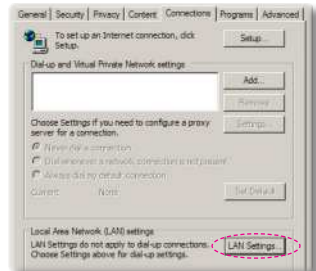

Step 7: The **Local Area Network (LAN) Setting** dialog box appears, in the **Proxy Server** area, cancel the **Use a proxy server for your LAN** check box., then click "OK" button twice.

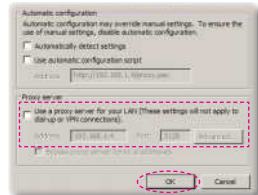

Step 8: Connect a cat5 cross-over network cable between the projector and the computer.

Step 9: Open your IE and type in the IP address of 192.168.0.100 in the URL then press "Enter" key.

## Crestron RoomView Control Tool

Crestron RoomView™ provides a central monitoring station for 250+ control systems on a single Ethernet network (more are possible, the number depends on the combination of IP ID and IP address). Crestron RoomView monitors each projector, including projector's online status, system power, lamp life, network setting and hardware faults, plus any custom attribute as defined by the Administrator. The Administrator can add, delete, or edit room information, contact information and events, which are logged automatically by the software for all users. (Operation UI as following image)

### 1. Main Screen

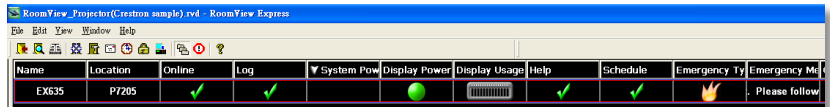

### 2. Edit Room



❖ Crestron RoomView function support is dependent on models.

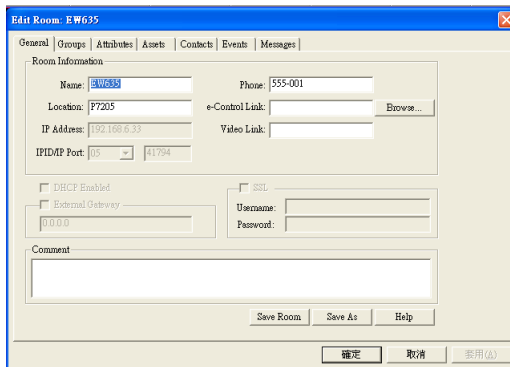

# User Controls

## 3. Edit Attribute

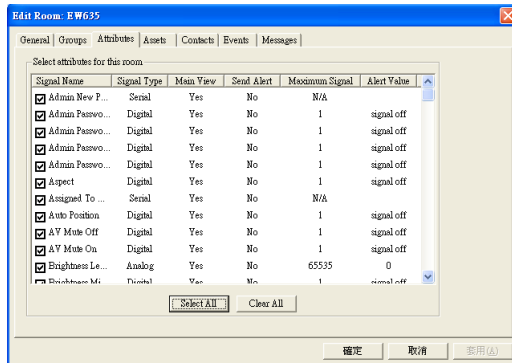

## 4. Edit Event

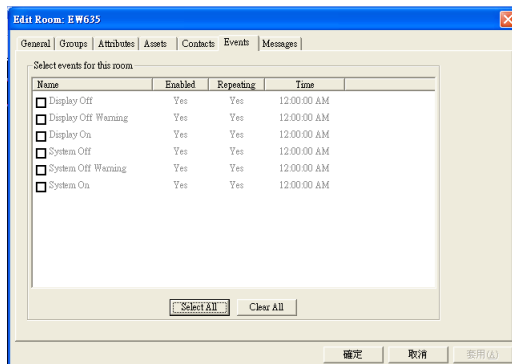

**For more information, please visit**  
**<http://www.crestron.com> & [www.crestron.com/getroomview](http://www.crestron.com/getroomview).**

## OPTIONS

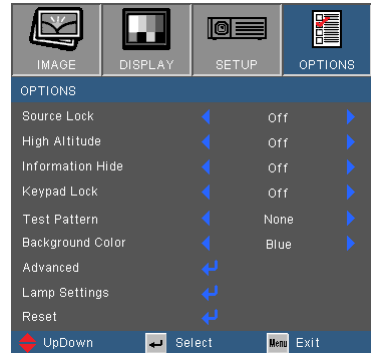

### Source Lock

- ▶ On: The projector will only search current input connection.
- ▶ Off: The projector will search for other signals if the current input signal is lost.

### High Altitude

When “On” is selected, the fans will spin faster. This feature is useful in high altitude areas where the air is thin.

### Information Hide

- ▶ On: Choose “On” to hide the info message.
- ▶ Off: Choose “Off” to show the “searching” message.



❖ To turn off the keypad lock, press and hold “Enter” key on top of the projector for 5 seconds.

### Keypad Lock

When the keypad lock function is “On”, the control panel will be locked however, the projector can be operated by the remote control. By selecting “Off”, you will be able to reuse the control panel.

### Test Pattern

Display a test pattern. There are Grid, White pattern and None.

### Background Color

Use this feature to display a “Black”, “Red”, “Blue”, “Green” or “White”, screen when no signal is available.

### Reset

Choose “Yes” to return the display parameters on all menus to the factory default settings.

## OPTIONS | Advanced

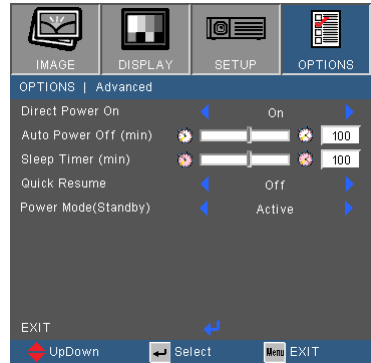

### Direct Power On

Choose “On” to activate Direct Power mode. The projector will automatically power on when AC power is supplied, without pressing the “**⏻**” key on the projector control panel or on the remote control.

### Auto Power Off (min)

Sets the countdown timer interval. The countdown timer will start, when there is no signal being sent to the projector. The projector will automatically power off when the countdown has finished (in minutes).

### Sleep Timer (min)

Sets the countdown timer interval. The countdown timer will start, with or without a signal being sent to the projector. The projector will automatically power off when the countdown has finished (in minutes).

### Quick Resume

- ▶ On: If the projector is accidentally turned off, this feature allows the projector to be instantly powered on again, if selected within a period of 100 seconds.
- ▶ Off: The fan will start cooling the system immediately when user turns off the projector.

### Power Mode (Standby)

- ▶ Eco.: Choose “Eco.” to save power dissipation further < 0.5W.
- ▶ Active: Choose “Active” to return to normal standby and the VGA out port will be enabled.



❖ When Power mode (Standby) is set to Eco (<0.5W), the VGA output and Audio pass-through will be deactivated when the projector is in standby.

## OPTIONS | Lamp Settings

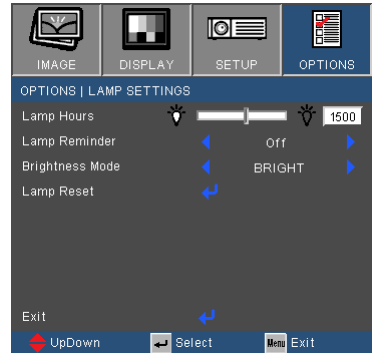

### Lamp Hours

Display the projection time.

### Lamp Reminder

Choose this function to show or to hide the warning message when the changing lamp message is displayed.

The message will appear 30 hours before suggested replacement of lamp.



❖ When ambient temperature is over 40°C in operating, the projector will switch to Eco automatically.

### Brightness Mode

- ▶ BRIGHT: Choose “BRIGHT” to increase the brightness.
- ▶ Eco.: Choose “Eco.” to dim the projector lamp which will lower power consumption and extend the lamp life.
- ▶ Eco+: When Eco+ mode is activated, the brightness level of the content is automatically detected to significantly reduced lamp power consumption (up to 30%) during periods of inactivity.

### Lamp Reset

Reset the lamp hour counter after replacing the lamp.



## Network Application System Introduction

*Network Application System includes the Network Display System, Web Administration System and Multi-media Card Reader Application which can bring the high performance in network projection. Base on network protocol, user can configure the projector remotely. It supports to connect the PC with Projector by USB, Ethernet, and Wireless. This project makes full use of the network capability. It allows the administrator to control all the projectors in one building by one PC. When some emergencies happen, the projector can send out alert information to administrator by email and web page. It can read more than one USB device directly and show all the images in it*

*This project consists of three software applications which make full use of the network and USB capability*

- *Web Administration*
- *Card Reader*
- *Optoma Presenter*

## How to use Web Administration

The Web Administration application allows user to configure the projector remotely via widely used TCP/IP protocol from anywhere in the building.

1. Start the web browser, and enter the IP address of the projector in URL: http://IP-address, the log-in web page is displayed.



# User Controls

- There are 3 options in this page.
  - Click "Download", it displays the interface to download the software of "Network Display".
  - Click "Crestron", to enter the control page of Flash UI.
  - Click "Admin", the log-in page shows up.



- Enter the password and click [Login] button, and then main page is displayed. The default password is "admin" when target system is brand new. The maximum password is 8 characters with any characters except "space".

## System Status

This selection allows you to see current network and firmware status of the projector.



## General Setup

Admin password can be changed here.



## Projector Control

This selection gives you access to most of the settings available in the projector and the current configuration without having to be in the same room.



## Alert Setup

- **Alert Type:** This selection allows the admin to receive alerts when the projector is at fault.
- **SMTP setting and Email setting:** This page is to set up the details of mail sending, ex. mail server IP address, user name, password and mail address of receivers. (Note: Multi-receivers are separated by semicolon.)



## Network Setup

This page is for setting up and configuring the wireless usb dongle.

# User Controls

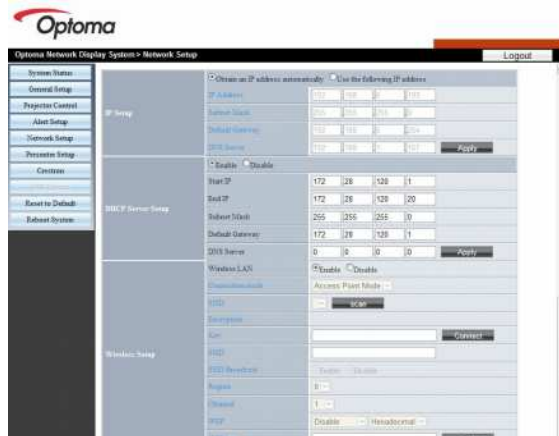

- **IP Setup:** Click “Obtain an IP address automatically” as auto mode; click “Use the following IP Address” as static mode, IP Address/Subnet Mask/Default Gateway/ DNS Server are required to be filled and then click “Apply” button.
- **DHCP Server Setup:** Enable/Disable, Start IP, End IP, Subnet Mask, Default Gateway, DNS server.
- **Wireless Setup:** This allows you to setup the projector as an access point or as a client that can be integrated to an existing network.

## Presenter Setup

Admin password/User password is used to change the password for admin/user in target side.





Click “Connection Control” to enter “Connection Status”

# User Controls



- **Conference Control:** Click “On” or “Off” to enable/disable conference control mode.

Click the following icons under “Play Control”

- : Click to disconnect host PC.
- : Click to switch session to background.
- : Click to change display region.

## Crestron RoomView

This is the control page of Flash UI.

Click “Power” to control power on/off of projector.

Click “Vol-, Mute, Vol+” to control volume.

In the SourceList, it includes all sources that the projector can process.

Click “Menu” to open menu; click “Source” to choose next source; click “Auto” to detect the source automatically; click “Blank” for AV mute function.

“Contrast, Brightness, Color, Sharpness, Zoom, Freeze” can be adjusted in the control panel below.

# User Controls



Click “Tools”, the following items are included:

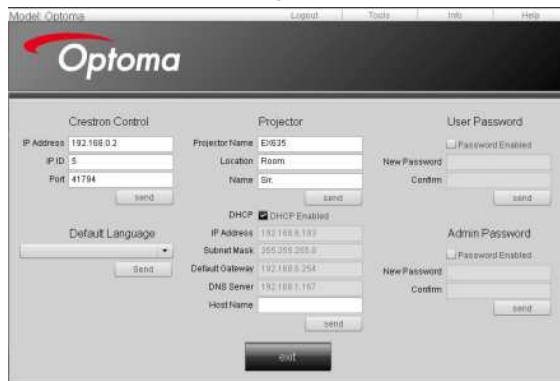

- *Crestron Control*: the basic network information of the control system device.
  - *Projector*: the ID of each projector in a building for Administrator to control.
  - *User Password*: change user's password.
  - *Default Language*: set the default language.
  - *DHCP*: enable/disable DHCP and the details of network card.
  - *Admin Password*: change administrator's password.
- After change each items, click “Send” button to make it effect.

Click “Info” to show information and status of this projector.

# User Controls

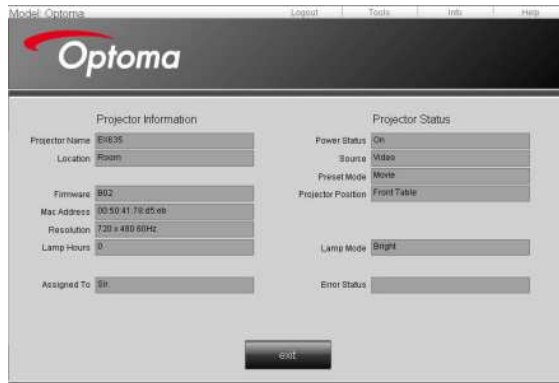

Click “Help” to inform administrator to do related protection or operation.

## Reset to Default

Click “Apply” to reset system to the default settings.

Click “Flash Upgrade” to upgrade the Firmware from USB disk, which has been inserted in projector.



## Reboot System

Click “Reboot” to reboot system.



## How to use Multi-media Card Reader Application

The Card Reader application can display packaged images in a USB flash device.

1. Plugging the USB device into USB port of projector, source of Flash Drive is detected, and then USB Flash Devices Detection Screen is displayed. It supports 3 USB devices at the same time.







2. Press “Enter” to enter Thumbnail mode, different photos in different folders can be chosen; If only one USB is plug-in, it will show thumbnail list directly. The following buttons are supported in the user interface:



❖ If the file name is too long to show, it will show “...” on the last character beyond the limited length and cut out the spare string.



- : Go to the top level of the selected USB.
- : Go to previous level of folder.
- : Setup function.
- : Select another USB



# User Controls

Press “Left” to back to the rightist at the same line; press “Right” to jump to next page; press “Up” to jump to previous page; press “Down” to jump to next page; press “Enter” into a picture, it will display picture auto fit to the screen by retaining original size ratio.

## 2-1. Setup Menu

When you highlight on  and press “Enter” button, enter into Setup menu. The following buttons are supported in the user interface:



- *Thumbnail Order: Enter the Thumbnail Display Mode.*
- *Slideshow: Enter the Slide Show Mode.*
  - *Timer: Use this function to set the slideshow interval.*
  - *Effect: Show the effect of Slideshow.*
  - *Repeat ON/OFF: Enable/Disable Slide Show Repeat Mode.*
- : *Go back to thumbnail file browsing.*

Press Up/Down/Left/Right key to choose different functions and press Enter key to make it effect.

## 2-2. Slideshow

When you press “Enter” into a picture, it will display picture auto fit to the screen by retaining original size ratio. The following buttons are supported in the user interface:

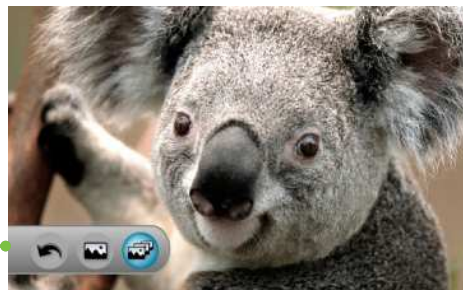



Slideshow Controls

# User Controls



❖ When the image file is large, slide show time will be longer more than the general picture, such as BMP format. The max size of image file is as below:

- JPG: 10000 x 10000;
- TIF, BMP, GIF and PNG: 1280 x 800







- : *Slideshow On.*
  - ▶ *Right /Left key: Show the next/previous photo and keep slideshow.*
  - ▶ *Enter key: Show the controls bar.*
  - ▶ *Menu key: Show the projector menu.*
- : *Slideshow off.*
  - ▶ *Up /Down key: Rotate +90/-90 degree.*
  - ▶ *Right /Left key: Show the next/previous photo.*
  - ▶ *Enter key: Show the controls bar.*
  - ▶ *Menu key: Show the projector menu.*
- : *Go back to thumbnail file browsing.*

Press Left/Right key to choose different functions and press Enter key to make it effect.

## 2-3. PDF

When you press “Enter” into a PDF file, it will display PDF document as full mode. The following buttons are supported in the user interface:



- ▶ : *Back to Thumbnail file browsing.*
- ▶ : *Hidden setting bar.*
- ▶ : *Fit/Full switch.*
- ▶ : *Set page to previous 5 pages.*
- ▶ : *Set page to next 5 pages.*
- ▶ : *Directly jump to page that set in the previous column.*
- ▶ : *Current/Total pages.*

When the image cannot be displayed due to memory limitation or cannot support image format, the specific image is displayed on the center of the screen.

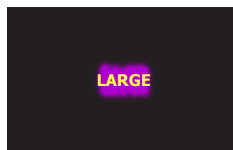

## How to use the Optoma Presenter System

Optoma Presenter application allows a pc host to present from USB and via network connection (wired or wireless).



- ❖ This projector is only compatible with Optoma's Mini WiFi USB Dongle. Please contact Optoma Service for details.
- ❖ Mini WiFi USB dongle is optional accessory.
- ❖ USB Display and Network Display support Window XP, Vista, Win7, Win7 (32/64bit), Mac OS 10.5, Mac OS 10.6.
- ❖ Keyboard mouse function only supports Network Display source.
- ❖ User must be administrator login.
- ❖ Keyboard mouse function works at full screen or Left up screen or left screen.
- ❖ Keyboard mouse function will not work when logged out or in lock, sleep, hibernate or standby modes.

### 1-1. Using Optoma Presenter via USB or Ethernet cable

Connect the usb cable to the projector. A USB device will be seen in “my computer”.

- Select “Optoma Presenter”, and then run “autorun.exe” to start USB display. 
- Press the Autorun icon in the right-down region to pause or play the USB display.

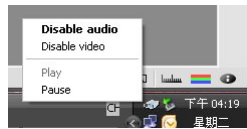

### 1-2. Using Optoma Presenter via mini Wifi USB dongle

1-2-1. Insert mini Wifi USB dongle into projector's USB port.

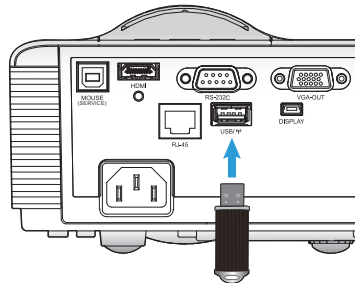

Mini WiFi USB Dongle  
(Optional Accessory)

# User Controls

## 1-2-2. Power on projector.



❖ Default SSID for wireless is Network Display.

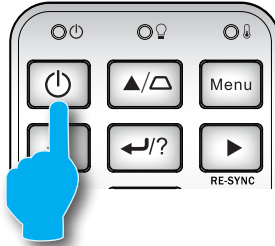

## 1-2-3. Connect to Mini WiFi USB Dongle SSID “Network Display” from your PC device.

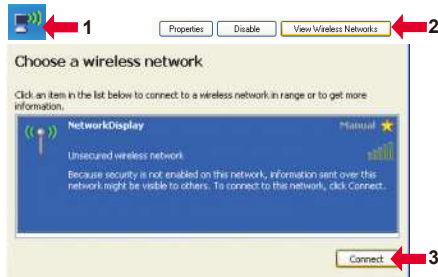

## 1-2-4. Download and Install Optoma Presenter Software.

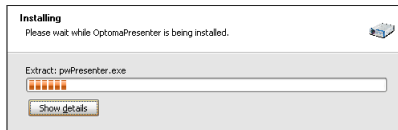

2. After installation in PC, double click the program of Optoma Presenter to enter main window.



- : Connect and search network display.
- : Select display region.
- : Manage all connected network displays.
- : Configure Optoma Presenter.

# User Controls

- 2-1. Click the button  to enter Connect and Search Menu.
- 2-1-1. Enter IP address of projector, select the option “Directly”, and then click “Connect” button to enter log-in interface; or Click “Search” button to search the projectors on network and select projectors to connect.



- 2-1-2. Input “User type” and “Password” in log-in interface.

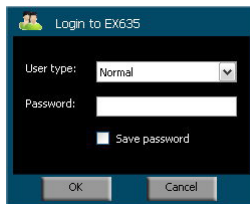

- 2-1-3. After log-in, Optoma Presenter will modify PC resolution to Network Application supported resolution.

- 2-2. Click the button  to select the size of projection region, including Full screen and Alterable mode.



- *Alterable size mode: The frame in ALTERABLE mode can be en-*

# User Controls

larged or downsized by dragging the eight small black squares scattered on eight edges of the frame.









- ❖ Audio transfer is supported in one on one connection between pc and computer. When audio out is enabled, video image quality setting will be greyed out.
- ❖ To get the higher image quality, please set quality to high, and set audio out to “No”.

- 2-3. Click the button  to select the language, Audio out and display the software information.



- 2-4. Click the button  to control all the users and all the projectors connected to the same projector.







- : Display range.
- : Click to unlock and change the network display password. Only the Administrator has rights to make the changes.
- : When normal user login, click this lock icon will result in no response.
- : Disconnect with target network display.
- : Connect the target network display via a webpage front end.
- : Turns on the audio.
- : Turns off the audio.

User of Admin type is able to view a menu page with a list of PCs connected to the target network display.



❖ The quality of the image via network connection depends upon total bandwidth available in the network.



-  : For the other PCs.
-  : For the current PC.
-  : Options of display port in which the highlight one is the current status, click on one of them to change the display port.
-  : Disconnect the PC from a network display.

## Troubleshooting

*If you experience a problem with your projector, please refer to the following information. If a problem persists, please contact your local reseller or service center.*

### **[?]** No image appears on-screen

- ▶ Ensure all the cables and power connections are correctly and securely connected as described in the “Installation” section.
- ▶ Ensure all the pins of connectors are not bent or broken.
- ▶ Check if the projection lamp has been securely installed. Please refer to the “Replacing the lamp” section.
- ▶ Make sure you have removed the lens cap and the projector is switched on.
- ▶ Ensure that the “AV mute” feature is not turned on.

### **[?]** Partial, scrolling or incorrectly displayed image

- ▶ Press “Re-SYNC” on the remote.
- ▶ If you are using a PC:

For Windows 95, 98, 2000, XP, Windows 7:

1. Open the “My Computer” icon, the “Control Panel” folder, and then double click on the “Display” icon.
2. Select the “Settings” tab.
3. Verify that your display resolution setting is lower than or equal to UXGA (1600 × 1200).
4. Click on the “Advanced Properties” button.

If the projector is still not projecting the whole image, you will also need to change the monitor display you are using. Refer to the following steps.

5. Verify the resolution setting is lower than or equal to UXGA (1600 × 1200).
6. Select the “Change” button under the “Monitor” tab.



# Appendices

7. Click on “Show all devices”. Next, select “Standard monitor types” under the SP box; choose the resolution mode you need under the “Models” box.
  8. Verify that the resolution setting of the monitor display is lower than or equal to UXGA (1600 × 1200).
- ▶ If you are using a Notebook:
1. First, follow the steps above to adjust resolution of the computer.
  2. Press the appropriate keys listed below for your notebook manufacturer to send signal out from notebook to projector.  
Example: [Fn]+[F4]

Acer ⇨	[Fn]+[F5]	IBM/Lenovo ⇨	[Fn]+[F7]
Asus ⇨	[Fn]+[F8]	HP/Compaq ⇨	[Fn]+[F4]
Dell ⇨	[Fn]+[F8]	NEC ⇨	[Fn]+[F3]
Gateway ⇨	[Fn]+[F4]	Toshiba ⇨	[Fn]+[F5]

Mac Apple:  
System Preference ⇨ Display ⇨ Arrangement ⇨ Mirror display

- ▶ If you experience difficulty changing resolutions or your monitor freezes, restart all equipment including the projector.

**[?]** The screen of the Notebook or PowerBook computer is not displaying your presentation

- ▶ If you are using a Notebook PC  
Some Notebook PCs may deactivate their own screens when a second display device is in use. Each has a different way to be reactivated. Refer to your computer’s manual for detailed information.

**[?]** Image is unstable or flickering

- ▶ Use “Phase” to correct it. See page 37 for more information.  
▶ Change the monitor color setting on your computer.

**[?]** Image has vertical flickering bar

- ▶ Use “Frequency” to make an adjustment. See page 37 for more information.  
▶ Check and re-configure the display mode of your graphic card to make it compatible with the projector.

## **[?]** Image is out of focus

- ▶ Make sure the lens cap is removed.
- ▶ Adjust the Focus Ring on the projector lens.
- ▶ Make sure the projection screen is between the required distance. See page 17.



## **[?]** The image is stretched when displaying 16:9 DVD title

- ▶ When you play anamorphic DVD or 16:9 DVD, the projector will show the best image when the projector display mode is set to 16:9 in the OSD.
- ▶ If you play 4:3 format DVD titles, please change the format to 4:3 in the projector OSD.
- ▶ If the image is still stretched, you will also need to adjust the aspect ratio by referring to the following:
- ▶ Please setup the display format as 16:9 (wide) aspect ratio type on your DVD player.

## **[?]** Image is too small or too large

- ▶ Move the projector closer to or further from the screen.
- ▶ Press “Menu” button on the remote control or projector panel, go to “DISPLAY → Format” and try the different settings.

## **[?]** Image has slanted sides

- ▶ If possible, reposition the projector so that it is horizontally centered on the screen and below the bottom of the screen.
- ▶ Press “Keystone +/-” button on the remote control or press “ / ” on the projector panel, until the sides are vertical.

## **[?]** Image is reversed

- ▶ Select “SETUP → Projection” from the OSD and adjust the projection direction.





## **[?]** The projector stops responding to all controls

- ▶ If possible, turn off the projector, then unplug the power cord and wait at least 60 seconds before reconnecting power.
- ▶ Check that “Keypad Lock” is not activated by trying to control the projector with the remote control.

## **[?]** Lamp burns out or makes a popping sound

- ▶ When the lamp reaches its end of life, it will burn out and may make a loud popping sound. If this happens, the projector will not turn on until the lamp module has been replaced. To replace the lamp, follow the procedures in the “Replacing the Lamp” section on pages 69-70.

## **[?]** LED lighting message

Message	 POWER/STANDBY LED (Green/Amber)	 Temp-LED (Red)	 Lamp-LED (Red)
	Standby State (Input power cord)	Amber	○
Power on (Warming)	Flashing Green	○	○
Lamp lighting	Green	○	○
Power off (Cooling)	Flashing Green	○	○
Quick Resume(100 secs)	Flashing Green	○	○
Error (Over Temp.)	Flashing Amber		○
Error (Fan fail)	Flashing Amber	Flashing	○
Error (Lamp fail)	Flashing Amber	○	



Steady light ⇨   
 No light ⇨ ○

\* POWER/STANDBY LED be ON when OSD appears, be OFF when OSD disappears.

## **?** On Screen Messages

### ▶ Temperature warning:

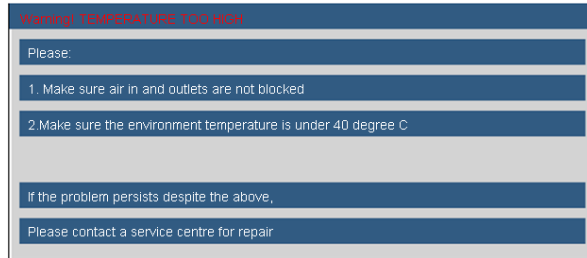

### ▶ Fan failed:



### ▶ Lamp warning:

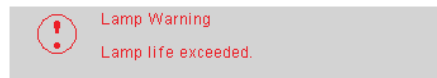

### ▶ Out of display range:

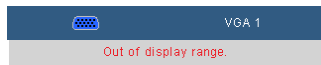

## **?** If the remote control does not work

- ▶ Check the operating angle of the remote control is within  $\pm 15^\circ$  both horizontally and vertically of one of the IR receivers on the projector.
- ▶ Make sure there are not any obstructions between the remote control and the projector. Move to within 7 m ( $\pm 0^\circ$ ) of the projector.
- ▶ Make sure the batteries are inserted correctly.
- ▶ Replace batteries if they are exhausted.

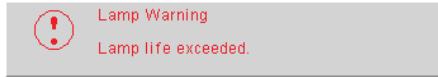

## Replacing the lamp

The projector automatically detects the lamp life. When the lamp life is nearing the end of use, you will receive a warning message.

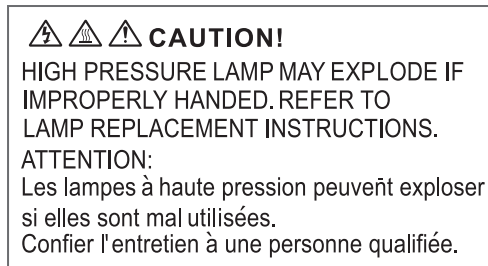

When you see this message, please contact your local reseller or service center to change the lamp as soon as possible. Make sure the projector has been cooled down for at least 30 minutes before changing the lamp.



-  Warning: If ceiling mounted, please use caution when opening the lamp access panel. It is recommended to wear safety glasses if changing the bulb when ceiling mounted. "Caution must be used to prevent any loose parts from falling out of projector."
-  Warning: Lamp compartment may be hot! Allow it to cool down before changing the lamp!
-  Warning: To reduce the risk of personal injury, do not drop the lamp module or touch the lamp bulb. The bulb may shatter and cause injury if it is dropped.

# Appendices

## NOTE

- ❖ The screws on the lamp cover and the lamp cannot be removed.
- ❖ The projector cannot be turned on if the lamp cover has not been placed back on the projector.
- ❖ Do not touch the glass area of the lamp. Hand oil can cause the lamp to shatter. Use a dry cloth to clean the lamp module if it was accidentally touched.

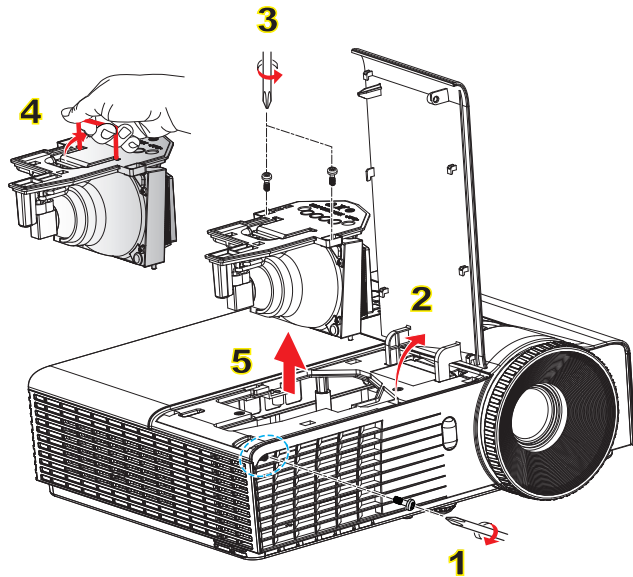

## Lamp Replacement Procedure:

1. Switch off the power to the projector by pressing the “**⏻**” button.
2. Allow the projector to cool down for at least 30 minutes.
3. Disconnect the power cord.
4. Unscrew the one screw on the cover. **1**
5. Lift up the cover. **2**
6. Unscrew the two screws on the lamp module. **3**
7. Lift up the lamp handle **4** and remove the lamp module slowly and carefully. **5**

To replace the lamp module, reverse the previous steps.

8. Turn on the projector and use “Lamp Reset” after the lamp module is replaced.

Lamp Reset: (i) Press “Menu” → (ii) Select “OPTIONS” → (iii) Select “Lamp Settings” → (iv) Select “Lamp Reset” → (v) Select “Yes”.

## Compatibility Modes

### ► Computer Compatibility

Mode	Resolution	Anglog/Digital		SVGA/ XGA	WXGA
		H-Sync (KHz)	V-Sync (Hz)		
VGA	640 × 350	31.50	70	V	V
VGA	640 × 350	37.90	85	V	V
VGA	720 × 350	31.50	70	V	
VGA	640 × 400	31.50	70	V	
VGA	640 × 400	37.90	85	V	V
VGA	720 × 400	31.50	70	V	V
VGA	720 × 400	37.90	85	V	V
	720 × 576	-	50	V	
	720 × 576	-	60	V	
VGA	640 × 480	31.50	60	V	V
VGA	640 × 480	-	67	V	V
VGA	640 × 480	37.90	72	V	V
VGA	640 × 480	37.50	75	V	V
VGA	640 × 480	43.30	85	V	
SVGA	800 × 600	35.20	56	V	V
SVGA	800 × 600	37.90	60	V	V
SVGA	800 × 600	46.90	75	V	V
SVGA	800 × 600	48.10	72	V	V
SVGA	800 × 600	-	80	V	
SVGA	800 × 600	53.70	85	V	
SVGA	800 × 600	-	120		V
	832 × 624	-	72	V	
	832 × 624	-	75	V	V
XGA	1024 × 576	-	50	V	
XGA	1024 × 576	-	60	V	
XGA	1024 × 768	48.40	60	V	V
XGA	1024 × 768	56.50	70	V	V
XGA	1024 × 768	57.70	72	V	



- ❖ For widescreen resolution (WXGA), the compatibility support is dependent on Notebook/PC models.
- ❖ 120Hz input signals may be dependent on graphics cards support.
- ❖ Please note that using resolutions other than native 800 x 1024 (SVGA), 1024 x 768 (XGA model), 1280 x 800 (WXGA model) may result in some loss of image clarity.

# Appendices

Mode	Resolution	Anglog/Digital		SVGA/ XGA	WXGA
		H-Sync (KHz)	V-Sync (Hz)		
XGA	1024 × 768	60.00	75	V	V
XGA	1024 × 768	68.70	85	V	
XGA	1024 × 768	-	120		V
	1152 × 864	-	60	V	
	1152 × 864	-	70	V	
	1152 × 864	-	75	V	
	1152 × 864	-	85	V	
	1152 × 870	-	75	V	V
HD720	1280 × 720	-	50	V	
HD720	1280 × 720	-	60	V	
HD720	1280 × 720	-	75	V	
HD720	1280 × 720	-	85	V	
HD720	1280 × 720	-	120		V
WXGA	1280 × 768	47.40	60	V	
WXGA	1280 × 768	-	70	V	
WXGA	1280 × 768	-	75	V	
WXGA	1280 × 768	-	85	V	
WXGA-800	1280 × 800	-	60	V	V
SXGA	1280 × 1024	64.00	60	V	V
SXGA	1280 × 1024	80.00	75	V	
SXGA	1280 × 1024	91.10	85	V	
	1366 × 768	60	-		V
	1400 × 900	60	55.935		V
SXGA+	1400 × 1050	-	60	V	V
	1680 × 1050	60	-		V
UXGA	1600 × 1200	75.00	60	V	V
HDTV	1920 × 1080	33.80	30	V	V
HDTV	1920 × 1080	28.10	25	V	
HDTV	1920 × 1080i	-	50/60	V	V
HDTV	1920 × 1080p	-	24/25/30/50/60	V	V
HDTV	1280 × 720	45.00	60	V	V
HDTV	1280 × 720p	-	50/60	V	V



# Appendices

Mode	Resolution	Anglog/Digital		SVGA/ XGA	WXGA
		H-Sync (KHz)	V-Sync (Hz)		
SDTV	720 × 576	31.30	50	V	
SDTV	720 × 576i	-	50	V	V
SDTV	720 × 576p	-	50	V	V
SDTV	720 × 480	31.50	60	V	
SDTV	720 × 480i	-	60	V	V
SDTV	720 × 480p	-	60	V	V

## ▶ Computer Compatibility

Mode	Resolution	V-Sync (Hz)	H-Sync (KHz)
MAC LC 13"	640 × 480	66.66	34.98
MAC II 13"	640 × 480	66.68	35.00
MAC 16"	832 × 624	74.55	49.73
MAC 19"	1024 × 768	75	60.24
MAC	1152 × 870	75.06	68.68
MAC G4	640 × 480	60	31.35
i MAC DV	1024 × 768	75	60.00
i MAC DV	1152 × 870	75	68.49

## ▶ Video Compatibility

NTSC	M/J, 3.58MHz, 4.43 MHz
PAL	B, D, G, H, I, M, N (4.43 MHz)
SECAM	B, D, G, K, K1, L (4.25/4.4 MHz)
SDTV	480i/p, 576i/p,
HDTV	720p@50Hz/60Hz, 1080i@50Hz/60Hz, 1080p@50Hz/60Hz

## RS232 Commands and Protocol Function List

### RS232 Pin Assignments



- ❖ RS232 shell is grounded.

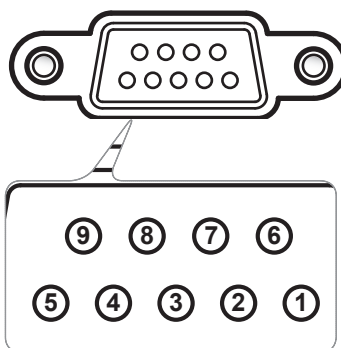

Pin no.	Spec. (from projector side)
1	N/A
2	RXD
3	TXD
4	N/A
5	GND
6	N/A
7	N/A
8	N/A
9	N/A

# Appendices

## RS232 Protocol Function List



1. There is a <CR> after all ASCII commands.
2. 0D is the HEX code for <CR> in ASCII code.

Baud Rate : 9600

Data Bits: 8

Parity: None

Stop Bits: 1

Flow Control : None

UART16550 FIFO: Disable

Projector Return (Pass): P

Projector Return (Fail): F

XX=00-99, projector's ID,

XX=00 is for all projectors

Note : the -XX must be set as -00 when use on telnet command no matter what ID projector has. eg: telnet with -0004 1 can execute Freeze function but -3804 1 can't.

### SEND to projector (telnet supported)

32 ASCII Code	HEX Code	Function	Description
-XX00 1	7E 30 30 30 20 31 0D	Power ON	
-XX00 0	7E 30 30 30 20 30 0D	Power OFF	(0/2 for backward compatible)
-XX00 1 -nnnn	7E 30 30 30 20 31 20 a 0D	Power ON with Password	-nnnn = -0000 (a=7E 30 30 30 30) -9999 (a=7E 39 39 39 39)
-XX01 1	7E 30 30 30 31 20 31 0D	Resync	
-XX02 1	7E 30 30 30 32 20 31 0D	AV Mute	On
-XX02 0	7E 30 30 30 32 20 30 0D		Off (0/2 for backward compatible)
-XX03 1	7E 30 30 30 33 20 31 0D	Mute	On
-XX03 0	7E 30 30 30 33 20 30 0D		Off (0/2 for backward compatible)
-XX04 1	7E 30 30 30 34 20 31 0D	Freeze	
-XX04 0	7E 30 30 30 34 20 30 0D	Unfreeze	(0/2 for backward compatible)
-XX05 1	7E 30 30 30 35 20 31 0D	Zoom Plus	
-XX06 1	7E 30 30 30 36 20 31 0D	Zoom Minus	
-XX12 1	7E 30 30 31 32 20 31 0D	Direct Source Commands	HDMI (for EW635)
-XX12 5	7E 30 30 31 32 20 35 0D		VGA1
-XX12 6	7E 30 30 31 32 20 36 0D		VGA 2
-XX12 8	7E 30 30 31 32 20 38 0D		VGA1 Component
-XX12 10	7E 30 30 31 32 20 31 30 0D		Video
-XX12 13	7E 30 30 31 32 20 31 33 0D		VGA 2 Component
-XX12 17	7E 30 30 31 32 20 31 37 0D		Flash drive
-XX12 18	7E 30 30 31 32 20 31 38 0D		Network Display
-XX12 19	7E 30 30 31 32 20 31 39 0D		USB display
-XX20 1	7E 30 30 32 30 20 31 0D	Display Mode	Presentation
-XX20 2	7E 30 30 32 30 20 32 0D		Bright
-XX20 3	7E 30 30 32 30 20 33 0D		Movie
-XX20 4	7E 30 30 32 30 20 34 0D		sRGB
-XX20 5	7E 30 30 32 30 20 35 0D		User
-XX20 7	7E 30 30 32 30 20 37 0D		Blackboard
-XX20 8	7E 30 30 32 30 20 38 0D		Classroom
-XX20 9	7E 30 30 32 30 20 39 0D		3D
-XX21 n	7E 30 30 32 31 20 a 0D	Brightness	n = -50 (a=2D 35 30) ~ 50 (a=35 30)
-XX22 n	7E 30 30 32 32 20 a 0D	Contrast	n = -50 (a=2D 35 30) ~ 50 (a=35 30)
-XX23 n	7E 30 30 32 33 20 a 0D	Sharpness	n = 1 (a=31) ~ 15 (a=31 35)
-XX24 n	7E 30 30 32 34 20 a 0D	Color Settings	Red Gain n = -50 (a=2D 35 30) ~ 50 (a=35 30)
-XX25 n	7E 30 30 32 35 20 a 0D		Green Gain n = -50 (a=2D 35 30) ~ 50 (a=35 30)
-XX26 n	7E 30 30 32 36 20 a 0D		Blue Gain n = -50 (a=2D 35 30) ~ 50 (a=35 30)
-XX27 n	7E 30 30 32 37 20 a 0D		Red Bias n = -50 (a=2D 35 30) ~ 50 (a=35 30)
-XX28 n	7E 30 30 32 38 20 a 0D		Green Bias n = -50 (a=2D 35 30) ~ 50 (a=35 30)
-XX29 n	7E 30 30 32 39 20 a 0D		Blue Bias n = -50 (a=2D 35 30) ~ 50 (a=35 30)
-XX30 n	7E 30 30 33 30 20 a 0D		Cyan n = -50 (a=2D 35 30) ~ 50 (a=35 30)
-XX31 n	7E 30 30 33 31 20 a 0D		Yellow n = -50 (a=2D 35 30) ~ 50 (a=35 30)
-XX32 n	7E 30 30 33 32 20 a 0D		Magenta n = -50 (a=2D 35 30) ~ 50 (a=35 30)
-XX33 1	7E 30 30 33 33 20 31 0D		Reset
-XX34 n	7E 30 30 33 34 20 a 0D	BrilliantColor™	n = 0 (a=30) ~ 10 (a=31 30)
-XX35 1	7E 30 30 33 35 20 31 0D	Degamma	Film
-XX35 2	7E 30 30 33 35 20 32 0D		Video
-XX35 3	7E 30 30 33 35 20 33 0D		Graphics
-XX35 4	7E 30 30 33 35 20 34 0D		Standard
-XX36 1	7E 30 30 33 36 20 31 0D	Color Temp.	Warm
-XX36 2	7E 30 30 33 36 20 32 0D		Medium
-XX36 3	7E 30 30 33 36 20 33 0D		Cold
-XX37 1	7E 30 30 33 37 20 31 0D	Color Space	Auto
-XX37 2	7E 30 30 33 37 20 32 0D		RGB RGB(0-255)
-XX37 3	7E 30 30 33 37 20 33 0D		YUV
-XX37 4	7E 30 30 33 37 20 34 0D		RGB(16 - 235)

# Appendices

~XX45 n	7E 30 30 34 34 20 a 0D	Color (Saturation)	n = -50 (a=2D 35 30) ~ 50 (a=35 30)	
~XX44 n	7E 30 30 34 35 20 a 0D	Tint	n = -50 (a=2D 35 30) ~ 50 (a=35 30)	
~XX60 1	7E 30 30 36 30 20 31 0D	Format	4:3	
~XX60 2	7E 30 30 36 30 20 32 0D		16:9-1	
~XX60 3	7E 30 30 36 30 20 33 0D		16:9-ll/16:10(EW635)	
~XX60 5	7E 30 30 36 30 20 35 0D		LBX	
~XX60 6	7E 30 30 36 30 20 36 0D		Native	
~XX60 7	7E 30 30 36 30 20 37 0D		Auto	
~XX61 n	7E 30 30 36 31 20 a 0D		Edge mask	n = 0 (a=30) ~ 10 (a=31 30)
~XX62 n	7E 30 30 36 32 20 a 0D	Zoom	n = -5 (a=2D 35) ~ 25 (a=32 35)	
~XX63 n	7E 30 30 36 33 20 a 0D	H Image Shift	n = -50 (a=2D 35 30) ~ 50 (a=35 30)	
~XX64 n	7E 30 30 36 34 20 a 0D	V Image Shift	n = -50 (a=2D 35 30) ~ 50 (a=35 30)	
~XX66 n	7E 30 30 36 36 20 a 0D	V Keystone	n = -40 (a=2D 34 30) ~ 40 (a=34 30)	
~XX69 1	7E 30 30 36 39 20 31 0D	Auto Keystone	On	
~XX69 0	7E 30 30 36 39 20 30 0D	Auto Keystone	Off	
~XX230 3	7E 30 30 32 33 30 20 31 0D	3D Mode	IR	
~XX230 1	7E 30 30 32 33 30 20 31 0D	3D Mode	DLP-Link	
~XX230 0	7E 30 30 32 33 30 20 30 0D	3D Mode	Off (0/2 for backward compatible)	
~XX231 1	7E 30 30 32 33 31 20 31 0D	3D Sync Invert	On	
~XX231 0	7E 30 30 32 33 31 20 30 0D	3D Sync Invert	Off (0/2 for backward compatible)	
~XX70 1	7E 30 30 37 30 20 31 0D	Language	English	
~XX70 2	7E 30 30 37 30 20 32 0D		German	
~XX70 3	7E 30 30 37 30 20 33 0D		French	
~XX70 4	7E 30 30 37 30 20 34 0D		Italian	
~XX70 5	7E 30 30 37 30 20 35 0D		Spanish	
~XX70 6	7E 30 30 37 30 20 36 0D		Portuguese	
~XX70 7	7E 30 30 37 30 20 37 0D		Polish	
~XX70 8	7E 30 30 37 30 20 38 0D		Dutch	
~XX70 9	7E 30 30 37 30 20 39 0D		Swedish	
~XX70 10	7E 30 30 37 30 20 31 30 0D		Norwegian/Danish	
~XX70 11	7E 30 30 37 30 20 31 31 0D		Finnish	
~XX70 12	7E 30 30 37 30 20 31 32 0D		Greek	
~XX70 13	7E 30 30 37 30 20 31 33 0D		Traditional Chinese	
~XX70 14	7E 30 30 37 30 20 31 34 0D		Simplified Chinese	
~XX70 15	7E 30 30 37 30 20 31 35 0D		Japanese	
~XX70 16	7E 30 30 37 30 20 31 36 0D		Korean	
~XX70 17	7E 30 30 37 30 20 31 37 0D		Russian	
~XX70 18	7E 30 30 37 30 20 31 38 0D		Hungarian	
~XX70 19	7E 30 30 37 30 20 31 39 0D		Czechoslovak	
~XX70 20	7E 30 30 37 30 20 32 30 0D		Arabic	
~XX70 21	7E 30 30 37 30 20 32 31 0D		Thai	
~XX70 22	7E 30 30 37 30 20 32 32 0D		Turkish	
~XX70 23	7E 30 30 37 30 20 32 33 0D		Farsi	
~XX70 25	7E 30 30 37 30 20 32 35 0D		Vietnamese	
~XX70 26	7E 30 30 37 30 20 32 36 0D		Indonesia	
~XX70 27	7E 30 30 37 30 20 32 37 0D		Romanian	
~XX71 1	7E 30 30 37 31 20 31 0D		Projection	Front-Desktop
~XX71 2	7E 30 30 37 31 20 32 0D			Rear-Desktop
~XX71 3	7E 30 30 37 31 20 33 0D			Front-Ceiling
~XX71 4	7E 30 30 37 31 20 34 0D			Rear-Ceiling
~XX72 1	7E 30 30 37 32 20 31 0D			Menu Location
~XX72 2	7E 30 30 37 32 20 32 0D		Top Right	
~XX72 3	7E 30 30 37 32 20 33 0D		Centre	
~XX72 4	7E 30 30 37 32 20 34 0D	Bottom Left		
~XX72 5	7E 30 30 37 32 20 35 0D	Bottom Right		
(EW635 only)				
~XX90 1	7E 30 30 39 31 20 31 0D	Screen Type	16:10	
~XX90 0	7E 30 30 39 31 20 30 0D		16:9	
~XX73 n	7E 30 30 37 33 20 a 0D	Signal	Frequency	
~XX91 n	7E 30 30 39 31 20 a 0D		Automatic	
~XX74 n	7E 30 30 37 34 20 a 0D		Phase	
~XX75 n	7E 30 30 37 35 20 a 0D		H. Position	
~XX76 n	7E 30 30 37 36 20 a 0D		V. Position	
~XX77 n	7E 30 30 37 37 20 aabbcc 0D		Security Timer	n = -5 (a=2D 35) ~ 5 (a=35) By signal n = 0 disable; n = 1 enable n = 0 (a=30) ~ 31 (a=33 31) By signal n = -5 (a=2D 35) ~ 5 (a=35) By timing n = -5 (a=2D 35) ~ 5 (a=35) By timing mm= 00 (aa=30 30) ~ 12 (aa=31 32) dd = 00 (bb=30 30) ~ 30 (bb=33 30) hh= 00 (cc=30 30) ~ 24 (cc=32 34)
~XX78 1	7E 30 30 37 38 20 31 0D		Security Settings	Enable
~XX78 0 ~nmm	7E 30 30 37 38 20 32 20 a 0D	Disable (0/2 for backward compatible) ~nmm = -0000 (a=7E 30 30 30 30) ~9999 (a=7E 39 39 39 39)		
~XX79 n	7E 30 30 37 39 20 a 0D	Projector ID	n = 00 (a=30 30) ~ 99 (a=39 39)	

# Appendices

~XX80 1	7E 30 30 38 30 20 31 0D	Mute	On
~XX80 0	7E 30 30 38 30 20 30 0D		Off (0/2 for backward compatible)
~XX81 n	7E 30 30 38 31 20 a 0D	Volume (Audio)	n = 0 (a=30) ~ 10 (a=31 30)
~XX93 n	7E 30 30 39 33 20 a 0D	Volume (Mic)	n = 0 (a=30) ~ 10 (a=31 30)
~XX89 0	7E 30 30 38 39 20 30 0D	Audio Input	Default
~XX89 1	7E 30 30 38 39 20 31 0D		Audio1
~XX89 3	7E 30 30 38 39 20 33 0D		Audio2
~XX82 1	7E 30 30 38 32 20 31 0D	Logo	Default
~XX82 2	7E 30 30 38 32 20 32 0D		User
~XX82 3	7E 30 30 38 32 20 33 0D		Neutral
~XX83 1	7E 30 30 38 33 20 31 0D	Logo Capture	
~XX88 0	7E 30 30 38 38 20 30 0D	Closed Captioning	Off
~XX88 1	7E 30 30 38 38 20 31 0D		cc1
~XX88 2	7E 30 30 38 38 20 32 0D		cc2
~XX100 1	7E 30 30 31 30 30 20 31 0D	Source Lock	On
~XX100 0	7E 30 30 31 30 30 20 30 0D		Off (0/2 for backward compatible)
~XX100 3	7E 30 30 31 30 30 20 33 0D	Next Source	
~XX101 1	7E 30 30 31 30 31 20 31 0D	High Altitude	On
~XX101 0	7E 30 30 31 30 31 20 30 0D		Off (0/2 for backward compatible)
~XX102 1	7E 30 30 31 30 32 20 31 0D	Information Hide	On
~XX102 0	7E 30 30 31 30 32 20 30 0D		Off (0/2 for backward compatible)
~XX103 1	7E 30 30 31 30 33 20 31 0D	Keypad Lock	On
~XX103 0	7E 30 30 31 30 33 20 30 0D		Off (0/2 for backward compatible)
~XX195 0	7E 30 30 31 39 35 20 30 0D	Test Pattern	None
~XX195 1	7E 30 30 31 39 35 20 31 0D		Grid
~XX195 2	7E 30 30 31 39 35 20 32 0D		White Pattern
~XX104 1	7E 30 30 31 30 34 20 31 0D	Background Color	Blue
~XX104 2	7E 30 30 31 30 34 20 32 0D		Black
~XX104 3	7E 30 30 31 30 34 20 33 0D		Red
~XX104 4	7E 30 30 31 30 34 20 34 0D		Green
~XX104 5	7E 30 30 31 30 34 20 35 0D		White
~XX105 1	7E 30 30 31 30 35 20 31 0D	Advanced	Direct Power On
~XX105 0	7E 30 30 31 30 35 20 30 0D		On
~XX106 n	7E 30 30 31 30 36 20 a 0D		Off (0/2 for backward compatible)
~XX107 n	7E 30 30 31 30 37 20 a 0D		Auto Power Off (min) n = 0 (a=30) ~ 180 (a=31 38 30)
~XX115 1	7E 30 30 31 31 35 20 31 0D		Sleep Timer (min) n = 0 (a=30) ~ 995 (a=39 39 39)
~XX115 0	7E 30 30 31 31 35 20 30 0D		Quick Resume
~XX114 1	7E 30 30 31 31 34 20 31 0D		On
~XX114 0	7E 30 30 31 31 34 20 30 0D		Off (0/2 for backward compatible)
~XX109 1	7E 30 30 31 30 39 20 31 0D		Power Mode(Standby) Eco.(≤0.5W)
~XX109 0	7E 30 30 31 30 39 20 30 0D		Active (0/2 for backward compatible)
~XX110 1	7E 30 30 31 31 30 20 31 0D		Lamp Reminder
~XX110 2	7E 30 30 31 31 30 20 32 0D		On
~XX110 3	7E 30 30 31 31 30 20 33 0D		Off (0/2 for backward compatible)
~XX111 1	7E 30 30 31 31 31 20 31 0D		Brightness Mode
~XX111 0	7E 30 30 31 31 31 20 30 0D		Bright
~XX112 1	7E 30 30 31 31 32 20 31 0D	Reset	Eco
~XX99 1	7E 30 30 39 39 20 31 0D	RS232 Alert Reset	Eco+
~XX210 n	7E 30 30 32 30 30 20 n 0D	Display message on the OSD	Yes
			Reset System Alert
			n: 1-30 characters
<b>SEND to emulate Remote</b>			
~XX140 10	7E 30 30 31 34 30 20 31 30 0D		Up
~XX140 11	7E 30 30 31 34 30 20 31 31 0D		Left
~XX140 12	7E 30 30 31 34 30 20 31 32 0D		Enter (for projection MENU)
~XX140 13	7E 30 30 31 34 30 20 31 33 0D		Right
~XX140 14	7E 30 30 31 34 30 20 31 34 0D		Down
~XX140 15	7E 30 30 31 34 30 20 31 35 0D		Keystone +
~XX140 16	7E 30 30 31 34 30 20 31 36 0D		Keystone -
~XX140 17	7E 30 30 31 34 30 20 31 37 0D		Volume -
~XX140 18	7E 30 30 31 34 30 20 31 38 0D		Volume +
~XX140 19	7E 30 30 31 34 30 20 31 39 0D		Brightness
~XX140 20	7E 30 30 31 34 30 20 32 30 0D		Menu
~XX140 21	7E 30 30 31 34 30 20 32 31 0D		Zoom

# Appendices

## SEND from projector automatically

232 ASCII Code	HEX Code	Function	Projector Return	Description
		System status	INFO	n : 0/1/2/3/4/6/7/8 = Standby/Warming/Cooling/Out of Range/ Lamp fail/Fan Lock/Over Temperature/ Lamp Hours Running Out/Cover Open

## READ from projector (telnet supported)

232 ASCII Code	HEX Code	Function	Projector Return	Description
~XX121 1	7E 30 30 31 32 31 20 31 0D	Input Source	OKn	n : 0/1/2/3/4/5/6/7 = None/VGA1/VGA2/Video/HDMI/ Flash drive/Network display/USB display
~XX122 1	7E 30 30 31 32 32 20 31 0D	Software Version	OKdddd	dddd: FW version
~XX123 1	7E 30 30 31 32 33 20 31 0D	Display Mode	OKn	n : 0/1/2/3/4/5/7/8/9 = None/Presentation/Bright/Movie/sRGB/User/ Blackboard/Classroom/3D
~XX124 1	7E 30 30 31 32 34 20 31 0D	Power State	OKn	n : 0/1 = Off/On
~XX125 1	7E 30 30 31 32 35 20 31 0D	Brightness	OKn	
~XX126 1	7E 30 30 31 32 36 20 31 0D	Contrast	OKn	
~XX127 1	7E 30 30 31 32 37 20 31 0D	Aspect Ratio	OKn	(EW635) n : 0/1/2/3/4 = 4:3/16:9 or 16:10 */LBX/Native/AUTO (EX635) n : 0/1/2/3/4 = 4:3/16:9-I/16:9-II/ Native/AUTO * 16:9 or 16:10 depend on Screen Type setting
~XX128 1	7E 30 30 31 32 38 20 31 0D	Color Temperature	OKn	n : 0/1/2 = Warm/Medium/Cold
~XX129 1	7E 30 30 31 32 39 20 31 0D	Projection Mode	OKn	n : 0/1/2/3 = Front-Desktop/Rear-Desktop/Front-Ceiling/ Rear-Ceiling
~XX150 1	7E 30 30 31 35 30 20 31 0D	Information	OKabbbccddde	a : 0/1 = Off/On bbbb: LampHour cc: source 00/01/02/03/04/05/06/07 = None/VGA1/VGA2/Video/ HDMI/Flash Drive/Network display/USB display dddd: FW version e : Display mode 0/1/2/3/4/5/7/8/9 None/Presentation/Bright/Movie/sRGB/User/ Blackboard/Classroom/3D
~XX151 1	7E 30 30 31 35 31 20 31 0D	Model name	OKn	n:1/2=EX635/EW635
~XX108 1	7E 30 30 31 30 38 20 31 0D	Lamp Hours	OKbbbb	bbbb: LampHour
~XX108 2	7E 30 30 31 30 38 20 31 0D	Cumulative Lamp Hours	OKbbbb	bbbb: (5 digits) Total Lamp Hours

## Wall Mount Installation

1. To prevent damage to your projector, please use the Optoma ceiling mount.
2. If you wish to use a third party ceiling mount kit, please ensure the screws used to attach a mount to the projector meet the following specifications:

- ▶ Screw type: M4\*3
- ▶ Maximum screw length: 11mm
- ▶ Minimum screw length: 8mm



❖ Please note that damage resulting from incorrect installation will void the warranty.



### ⚠ Warning:

1. If you buy a ceiling mount from another company, please be sure to use the correct screw size. Screw size will vary depending on the thickness of the mounting plate.
2. Be sure to keep at least 10 cm gap between the ceiling and the bottom of the projector.
3. Avoid installing the projector near a heat source.

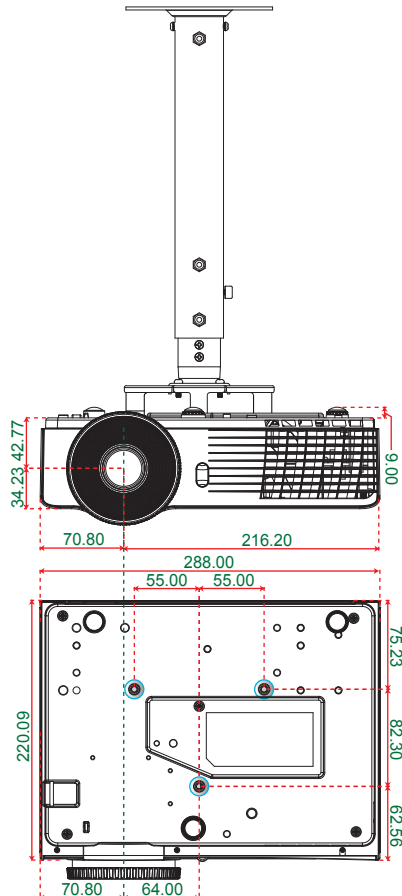

Unit: mm



Lens

## Optoma Global Offices

*For service or support please contact your local office.*



### USA

3178 Laurelview Ct.  
Fremont, CA 94538, USA  
www.optomausa.com

 888-289-6786  
 510-897-8601  
 [services@optoma.com](mailto:services@optoma.com)

### Canada

2420 Meadowpine Blvd., Suite #105  
Mississauga, ON, L5N 6S2, Canada  
www.optoma.ca

 888-289-6786  
 510-897-8601  
 [services@optoma.com](mailto:services@optoma.com)



### Europe

42 Caxton Way, The Watford Business Park  
Watford, Hertfordshire,  
WD18 8QZ, UK  
www.optoma.eu  
Service Tel : +44 (0)1923 691865

 +44 (0) 1923 691 800  
 +44 (0) 1923 691 888  
 [service@tsc-europe.com](mailto:service@tsc-europe.com)



### France

Bâtiment E  
81-83 avenue Edouard Vaillant  
92100 Boulogne Billancourt, France

 +33 1 41 46 12 20  
 +33 1 41 46 94 35  
 [savoptoma@optoma.fr](mailto:savoptoma@optoma.fr)



### Spain

C/ José Hierro, 36 Of. 1C  
28522 Rivas VaciaMadrid,  
Spain

 +34 91 499 06 06  
 +34 91 670 08 32



### Deutschland

Wiesenstrasse 21 W  
D40549 Düsseldorf,  
Germany

 +49 (0) 211 506 6670  
 +49 (0) 211 506 66799  
 [info@optoma.de](mailto:info@optoma.de)

### Scandinavia

Lerpeveien 25  
3040 Drammen  
Norway



 +47 32 98 89 90  
 +47 32 98 89 99  
 [info@optoma.no](mailto:info@optoma.no)

PO.BOX 9515  
3038 Drammen  
Norway





## Benelux BV

Randstad 22-123  
1316 BW Almere  
The Netherlands

 +31 (0) 36 820 0253  
 +31 (0) 36 548 9052  
[www.optoma.nl](http://www.optoma.nl)



## Latin America

3178 Laurelview Ct.  
Fremont, CA 94538, USA  
[www.optomausa.com](http://www.optomausa.com)

 888-289-6786  
 510-897-8601  
 [services@optoma.com](mailto:services@optoma.com)

## Korea

WOOMI TECH.CO.,LTD.  
4F,Minu Bldg.33-14, Kangnam-Ku,  
seoul,135-815, KOREA

 +82+2+34430004  
 +82+2+34430005



## Japan

東京都足立区綾瀬3-25-18  
株式会社オーエス  
コンタクトセンター:0120-380-495

 [info@os-worldwide.com](mailto:info@os-worldwide.com)  
[www.os-worldwide.com](http://www.os-worldwide.com)



## Taiwan

5F., No. 108, Minchiuan Rd.  
Shindian City,  
Taipei Taiwan 231, R.O.C.  
[www.optoma.com.tw](http://www.optoma.com.tw)

 +886-2-2218-2360  
 +886-2-2218-2313  
 [services@optoma.com.tw](mailto:services@optoma.com.tw)  
[asia.optoma.com](http://asia.optoma.com)



## Hong Kong

Unit A, 27/F Dragon Centre,  
79 Wing Hong Street,  
Cheung Sha Wan,  
Kowloon, Hong Kong

 +852-2396-8968  
 +852-2370-1222  
[www.optoma.com.hk](http://www.optoma.com.hk)

## China

5F, No. 1205, Kaixuan Rd.,  
Changning District  
Shanghai, 200052, China

 +86-21-62947376  
 +86-21-62947375  
[www.optoma.com.cn](http://www.optoma.com.cn)

## Regulation & Safety Notices

*This appendix lists the general notices of your projector.*

### **FCC notice**

This device has been tested and found to comply with the limits for a Class B digital device pursuant to Part 15 of the FCC rules. These limits are designed to provide reasonable protection against harmful interference in a residential installation. This device generates, uses and can radiate radio frequency energy and, if not installed and used in accordance with the instructions, may cause harmful interference to radio communications.

However, there is no guarantee that interference will not occur in a particular installation. If this device does cause harmful interference to radio or television reception, which can be determined by turning the device off and on, the user is encouraged to try to correct the interference by one or more of the following measures:

- Reorient or relocate the receiving antenna.
- Increase the separation between the device and receiver.
- Connect the device into an outlet on a circuit different from that to which the receiver is connected.
- Consult the dealer or an experienced radio/television technician for help.

### **Notice: Shielded cables**

All connections to other computing devices must be made using shielded cables to maintain compliance with FCC regulations.

### **Caution**

Changes or modifications not expressly approved by the manufacturer could void the user's authority, which is granted by the Federal Communications Commission, to operate this projector.

## **Operation conditions**

This device complies with Part 15 of the FCC Rules. Operation is subject to the following two conditions:

1. This device may not cause harmful interference and
2. This device must accept any interference received, including interference that may cause undesired operation.

## **Notice: Canadian users**

This Class B digital apparatus complies with Canadian ICES-003.

## **Remarque à l'intention des utilisateurs canadiens**

Cet appareil numérique de la classe B est conforme à la norme NMB-003 du Canada.

## **Declaration of Conformity for EU countries**

- EMC Directive 2004/108/EC (including amendments)
- Low Voltage Directive 2006/95/EC
- R & TTE Directive 1999/5/EC (if product has RF function)

### **Disposal instructions**



**Do not throw this electronic device into the trash when discarding. To minimize pollution and ensure utmost protection of the global environment, please recycle it.**