

Table of Contents

Table of Contents	1	SETUP Advanced	40
Usage Notice	2	OPTIONS	41
Safety Information	2	OPTIONS Advanced	42
Precautions	3	OPTIONS Lamp Settings	43
Eye Safety Warnings	5	Appendices	44
Product Features	5	Troubleshooting	44
Introduction	6	Replacing the lamp	49
Package Overview	6	Compatibility Modes	51
Product Overview	7	Computer Compatibility	51
Main Unit	7	Video Compatibility	53
Control Panel	8	RS232 Commands and Protocol	
Input/Output Connections	9	Function List	54
Remote Control	10	RS232 Pin Assignments	54
Installation	11	RS232 Protocol Function List	55
Connecting the Projector	11	Wall Mount Installation	59
Connect to Computer/Notebook	11	Optoma Global Offices	60
Connect to Video Sources	12	Regulation & Safety Notices	62
Powering the projector On / Off	13		
Powering On the Projector	13		
Powering Off the Projector	14		
Warning Indicator	14		
Adjusting the Projected Image	15		
Adjusting the Projector's Height	15		
Adjusting the Projector's Zoom /			
Focus	16		
Adjusting Projection Image Size	16		
User Controls	18		
Control Panel & Remote Control	18		
Control Panel	18		
Remote Control	19		
On-screen Display Menus	24		
How to operate	24		
Menu Tree	25		
IMAGE	27		
IMAGE Advanced	29		
DISPLAY	31		
DISPLAY 3D	34		
SETUP	35		
SETUP Signal (RGB)	37		
SETUP Security	38		

Safety Information

	The lightning flash with arrow head within an equilateral triangle is intended to alert the user to the presence of uninsulated "dangerous voltage" within the product's enclosure that may be of sufficient magnitude to constitute a risk of electric shock to persons.
	The exclamation point within an equilateral triangle is intended to alert the user to the presence of important operating and maintenance (servicing) instructions in the literature accompanying the appliance.

WARNING: TO REDUCE THE RISK OF FIRE OR ELECTRIC SHOCK, DO NOT EXPOSE THIS APPLIANCE TO RAIN OR MOISTURE. DANGEROUS HIGH VOLTAGES ARE PRESENT INSIDE THE ENCLOSURE. DO NOT OPEN THE CABINET. REFER SERVICING TO QUALIFIED PERSONNEL ONLY.

Class B emissions limits

This Class B digital apparatus meets all requirements of the Canadian Interference-Causing Equipment Regulations.

Important Safety Instruction

1. Do not block any ventilation openings. To ensure reliable operation of the projector and to protect from over heating, it is recommended to install the projector in a location that does not block ventilation. As an example, do not place the projector on a crowded coffee table, sofa, bed, etc. Do not put the projector in an enclosure such as a book case or a cabinet that restricts air flow.
2. Do not use the projector near water or moisture. To reduce the risk of fire and/or electric shock, do not expose the projector to rain or moisture.
3. Do not install near heat sources such as radiators, heaters, stoves or any other apparatus such as amplifiers that emits heat.
4. Clean only with dry cloth.
5. Only use attachments/accessories specified by the manufacturer.
6. Do not use the unit if it has been physically damaged or abused.
Physical damage/abuse would be (but not limited to):
 - Unit has been dropped.
 - Power supply cord or plug has been damaged.
 - Liquid has been spilled on to the projector.
 - Projector has been exposed to rain or moisture.
 - Something has fallen in the projector or something is loose inside.Do not attempt to service the unit yourself. Opening or removing covers may expose you to dangerous voltages or other hazards. Please call Optoma before you send the unit for repair.
7. Do not let objects or liquids enter the projector. They may touch dangerous voltage points and short out parts that could result in fire or electric shock.
8. See projector enclosure for safety related markings.
9. The unit should only be repaired by appropriate service personnel.

Precautions



Please follow all warnings, precautions and maintenance as recommended in this user's guide.

- Warning- Do not look into the projector's lens when the lamp is on. The bright light may hurt and damage your eyes.
- Warning- To reduce the risk of fire or electric shock, do not expose this projector to rain or moisture.
- Warning- Please do not open or disassemble the projector as this may cause electric shock.
- Warning- When replacing the lamp, please allow the unit to cool down. Follow instructions as described on pages 49-50.
- Warning- This projector will detect the life of the lamp itself. Please be sure to change the lamp when it shows warning messages.
- Warning- Reset the "Lamp Reset" function from the on-screen display "OPTIONS | Lamp Settings" menu after replacing the lamp module (refer to page 43).
- Warning- When switching the projector off, please ensure the cooling cycle has been completed before disconnecting power. Allow 90 seconds for the projector to cool down.
- Warning- Do not use lens cap when projector is in operation.
- Warning- When the lamp is approaching the end of its lifetime, the message "Lamp Warning: Lamp life exceeded." will show on the screen. Please contact your local reseller or service center to change the lamp as soon as possible.
- Warning- Do not look into or point the laser pointer on your remote control into your or someone's eyes. Laser pointer can cause permanent damage to eyesight.



- ❖ When the lamp reaches the end of its life, the projector will not turn back on until the lamp module has been replaced. To replace the lamp, follow the procedures listed under "Replacing the Lamp" section on pages 49-50.

Usage Notice

Do:

- ❖ Turn off and unplug the power plug from the AC outlet before cleaning the product.
- ❖ Use a soft dry cloth with mild detergent to clean the display housing.
- ❖ Disconnect the power plug from AC outlet if the product is not being used for a long period of time.

Do not:

- ❖ Block the slots and openings on the unit provided for ventilation.
- ❖ Use abrasive cleaners, waxes or solvents to clean the unit.
- ❖ Use under the following conditions:
 - In extremely hot, cold or humid environments.
 - ▶ Ensure that the ambient room temperature is within 5 - 40°C.
 - ▶ Relative Humidity is 5 - 40°C, 80% (Max.), non-condensing.
 - In areas susceptible to excessive dust and dirt.
 - Near any appliance generating a strong magnetic field.
 - In direct sunlight.

Eye Safety Warnings



- Avoid staring/facing directly into the projector beam at all times. Keep your back to the beam as much as possible.
- When projector is used in a classroom, adequately supervise students when they are asked to point out something on the screen.
- In order to minimize the lamp power, use room blinds to reduce ambient light levels.

Product Features



- ❖ Monitor loop through only supported in VGA1-In/YPbPr.

- SVGA (800x600) Native resolution / XGA (1024x768) Native resolution / WXGA (1280x800) Native resolution
- HD compatible – 720p and 1080p supported
- VGA monitor loop through (works on standby mode > 1W)
- BrilliantColor™ Technology
- Security Bar and Kensington Lock
- RS232 control
- Rapid shutdown
- Built-in speakers
- Quick Resume and Eco+ mode

Introduction

Package Overview

Unpack and inspect the box contents to ensure all parts listed below are in the box. If something is missing, please contact your nearest customer service center.

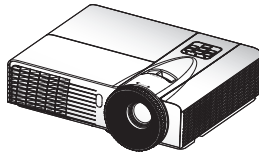

Projector

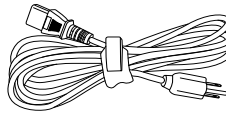

Power Cord

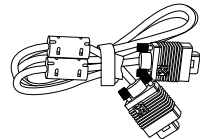

VGA Cable



2 × AAA Batteries



IR Remote Control



❖ Due to different applications in each country, some regions may have different accessories.

Documentation :

- User's Manual
- Warranty Card
- Quick Start Card
- WEEE Card
(for EMEA only)
- STOP Card
(for US Only)

Product Overview

Main Unit

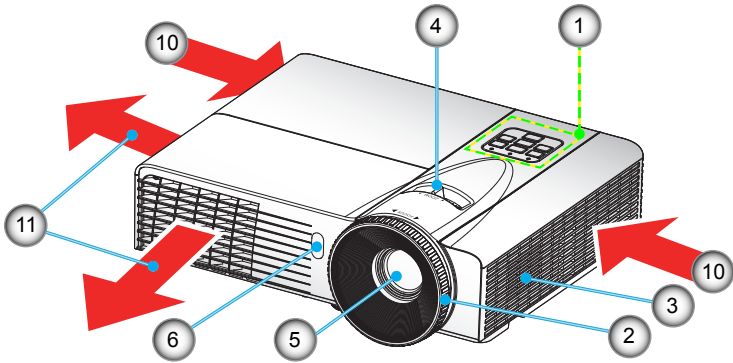

❖ The interface is subject to model's specifications.

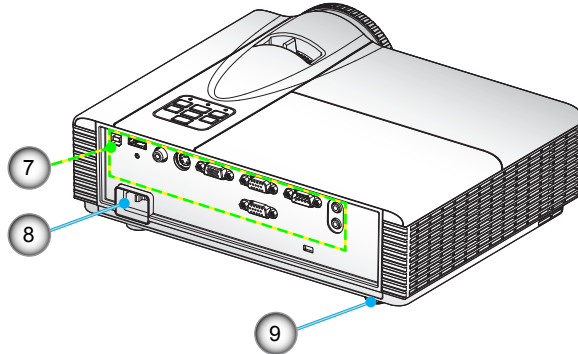

- | | |
|------------------|-------------------------------|
| 1. Control Panel | 7. Input / Output Connections |
| 2. Focus Ring | 8. Power Socket |
| 3. Speaker | 9. Tilt-Adjustment Feet |
| 4. Zoom Ring | 10. Ventilation (inlet) |
| 5. Lens | 11. Ventilation (outlet) |
| 6. IR Receiver | |

Introduction

Control Panel

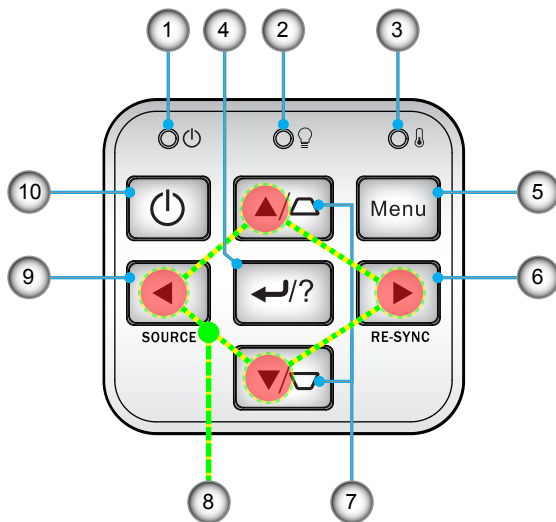

1. Power LED
2. Lamp LED
3. Temp LED
4. Enter / Help
5. Menu
6. Re-Sync
7. Keystone Correction
8. Four Directional Select Keys
9. Source
10. Power/Standby button

Input/Output Connections

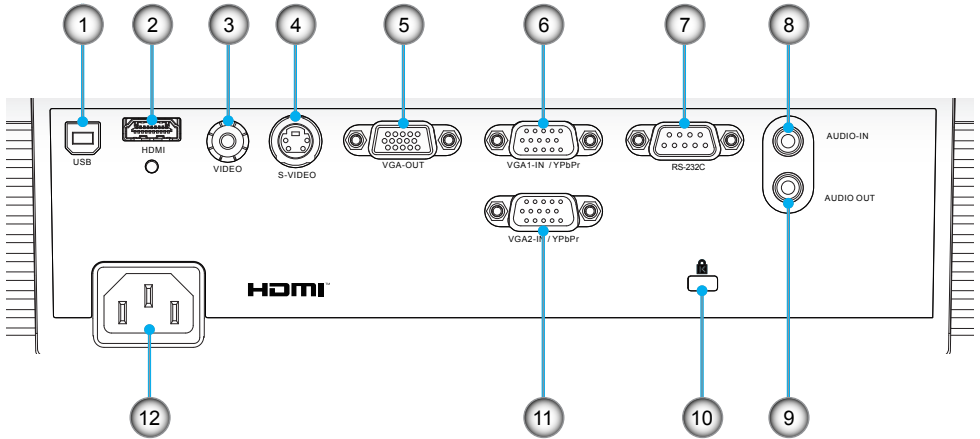

1. USB Connector (Connect to PC for Remote Mouse function)
2. HDMI Connector
3. Composite Video Input Connector
4. S-Video Input Connector
5. VGA-Out Connector (Monitor Loop-through Output)
6. VGA1-In/YPbPr Connector (PC Analog Signal/Component Video Input/HDTV/YPbPr)
7. RS-232 Connector (9-pin DIN Type)
8. Audio Input connector (3.5mm mini jack)
9. Audio Output Connector (3.5mm Mini Jack)
10. Kensington™ Lock Port
11. VGA2-In/YPbPr Connector (PC Analog Signal/Component Video Input/HDTV/YPbPr)
12. Power Socket



❖ The interface is subject to model's specifications.



❖ Monitor loop through only supported in VGA1-In/YPbPr.

Introduction

Remote Control



❖ The interface is subject to model's specifications.

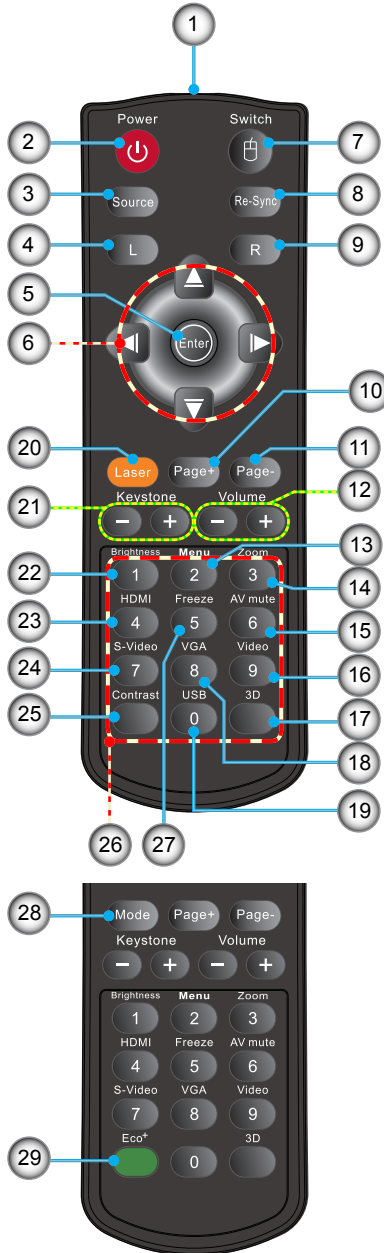

1. LED Indicator
2. Power On/Off
3. Source
4. Mouse Left Click
5. Enter
6. Four Directional Select Keys / Mouse control
7. Switch
8. Re-Sync
9. Mouse Right Click
10. Page Up
11. Page Down
12. Volume +/-
13. Menu
14. Zoom
15. AV mute
16. Video
17. 3D
18. VGA
19. USB
20. Laser Pointer
21. Keystone +/-
22. Brightness
23. HDMI
24. S-Video
25. Contrast
26. Numbered keypad (for password input)
27. Freeze
28. Mode
29. Eco⁺

Installation

Connecting the Projector Connect to Computer/Notebook



❖ The interface is subject to model's specifications.



❖ Due to the difference in applications for each country, some regions may have different accessories.

❖ (*) Optional accessory

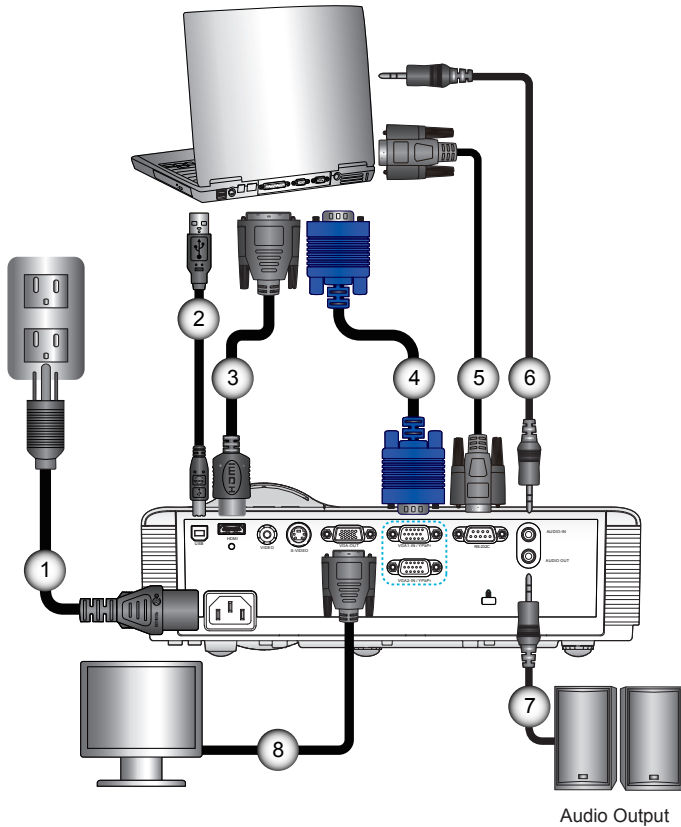

1.....	Power Cord
2.....	*USB Cable
3.....	*DVI/HDMI Cable
4.....	VGA Cable
5.....	*RS232 Cable
6.....	*Audio Input Cable
7.....	*Audio Output Cable
8.....	*VGA Output Cable

Installation

Connect to Video Sources

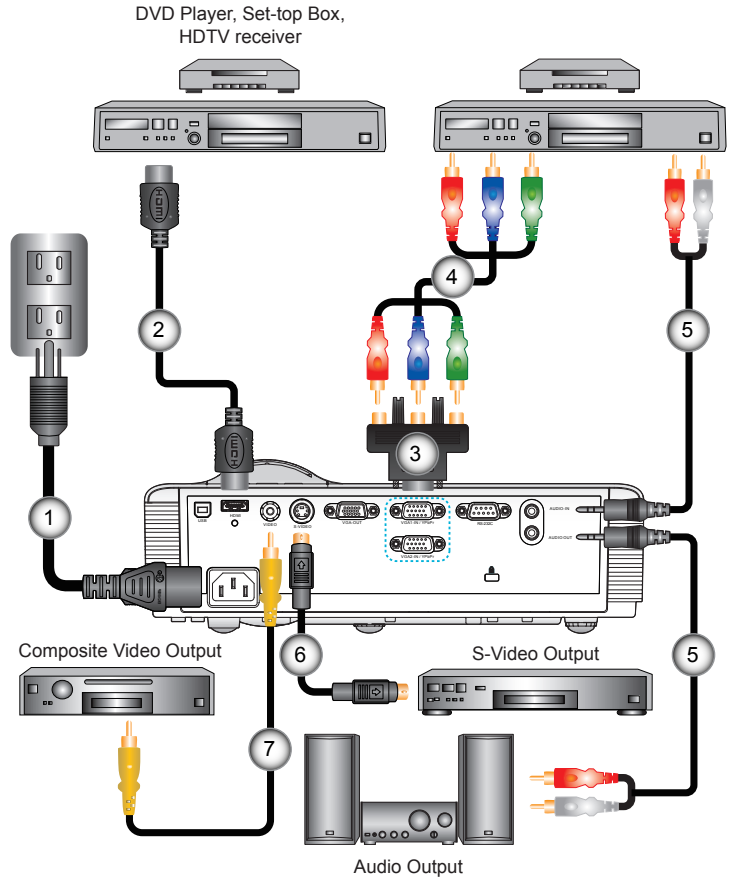

❖ The interface is subject to model's specifications.



❖ Due to the difference in applications for each country, some regions may have different accessories.

❖ (*) Optional accessory

- | | |
|--------|---|
| 1..... | Power Cord |
| 2..... | *HDMI Cable |
| 3..... | *15-Pin to 3 RCA Component/HDTV Adaptor |
| 4..... | *3 RCA Component Cable |
| 5..... | *Audio Cable Jack/RCA |
| 6..... | *S-Video Cable |
| 7..... | *Composite Video Cable |

Installation

Powering the projector On / Off

Powering On the Projector

1. Remove the lens cap. (optional) ❶
2. Securely connect the power cord and signal cable. When connected, the POWER/STANDBY LED will turn Amber.
3. Turn on the lamp by pressing “” button either on the top of the projector or on the remote. The POWER/STANDBY LED will now turn Green. ❷

The startup screen will display in approximately 10 seconds. The first time you use the projector, you will be asked to select the preferred language and power saving mode.

4. Turn on and connect the source that you want to display on the screen (computer, notebook, video player, etc). The projector will detect the source automatically. If not, push menu button and go to “OPTIONS”. Make sure that the “Source Lock” has been set to “Off”.
- ❖ If you connect multiple sources at the same time, press the “SOURCE” button on the control panel or direct source keys on the remote control to switch between inputs.



❖ When Power mode (Standby) is set to Eco (<0.5W), the VGA output and Audio pass-through will be deactivated when the projector is in standby.



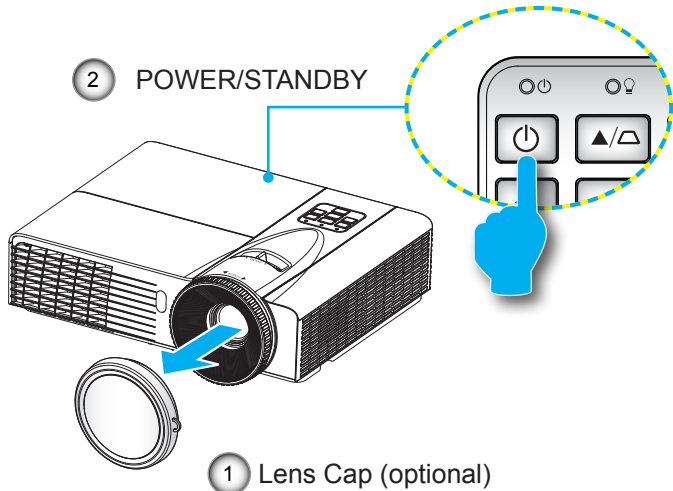

❖ Turn on the projector first and then select the signal sources.

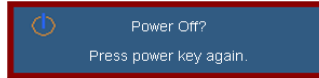

Powering Off the Projector

1. Press the “” button on the remote control or on the control panel to turn off the projector. The following message will be displayed on the screen.



Press the “” button again to confirm otherwise the message will disappear after 15 seconds. When you press the “” button for the second time, the fan will start cooling the system and will shut down.

2. The cooling fans continue to operate for about 10 seconds for cooling cycle and the POWER/STANDBY LED will Flash Green. When the POWER/STANDBY LED lights solid Amber, the projector has entered standby mode.

If you wish to turn the projector back on, you must wait until the projector has completed the cooling cycle and has entered standby mode. Once in standby mode, simply press “” button to restart the projector.

3. Disconnect the power cord from the electrical outlet and the projector.
4. Do not turn on the projector immediately following a power off procedure.

Warning Indicator

When the warning indicators (see below) come on, the projector will automatically shutdown:



- ❖ Contact the nearest service center if the projector displays these symptoms. See pages 60-61 for more information.
- ❖ “LAMP” LED indicator is lit red and if “POWER/STANDBY” indicator flashes amber.
- ❖ “TEMP” LED indicator is lit red and if “POWER/STANDBY” indicator flashes amber. This indicates the projector has overheated. Under normal conditions, the projector can be switched back on.
- ❖ “TEMP” LED indicator flashes red and if “POWER/STANDBY” indicator flashes amber.

Unplug the power cord from the projector, wait for 30 seconds and try again. If the warning indicator light up again, please contact your nearest service center for assistance.

Adjusting the Projected Image

Adjusting the Projector's Height

The projector is equipped with elevator feet for adjusting the image height.

1. Locate the adjustable foot you wish to modify on the underside of the projector.
2. Rotate the adjustable ring clockwise to raise the projector or counter clockwise to lower it. Repeat with the remaining feet as needed.

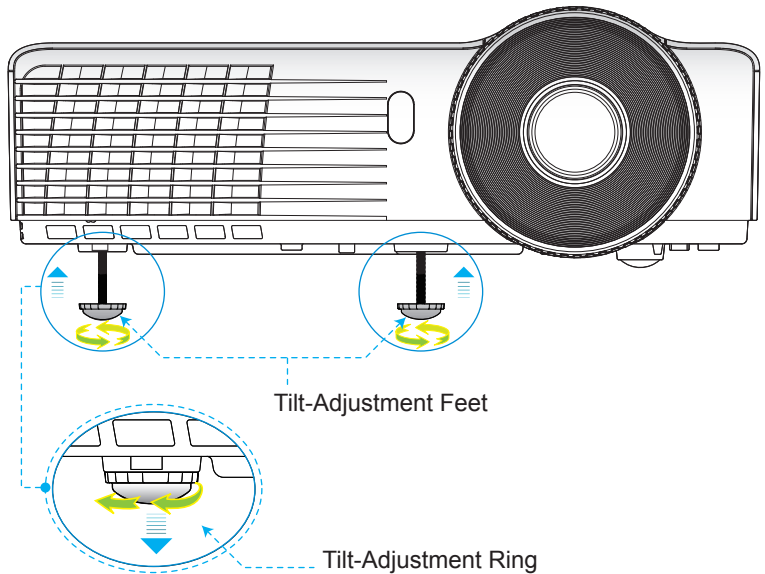

Adjusting the Projector's Zoom / Focus

You may turn the zoom ring to zoom in or out. To focus the image, rotate the focus ring until the image is clear.

- ▶ SVGA/XGA series: The projector will focus at distances from 3.28 to 39.4 feet (1.0 to 12.0 meters).
- ▶ WXGA series: The projector will focus at distances from 3.28 to 39.4 feet (1.0 to 12.0 meters).

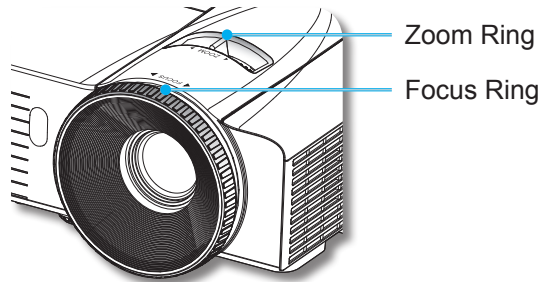

Adjusting Projection Image Size

- ▶ SVGA/XGA series: Projection Image Size from 22.9" to 300.0" (0.6 to 7.6 meters).
- ▶ WXGA series: Projection Image Size from 27.2" to 301.0" (0.7 to 7.6 meters).

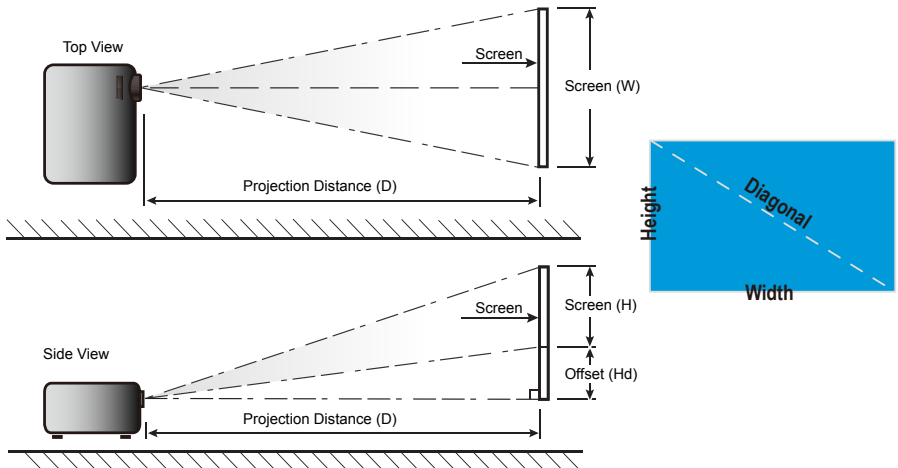

Installation

SVGA/XGA

Diagonal length (inch) size of 4:3 Screen	Screen Size W x H				Projection Distance (D)				Offset (Hd)	
	(m)		(inch)		(m)		(feet)		(m)	(feet)
	Width	Height	Width	Height	wide	tele	wide	tele		
30.00	0.61	0.46	24.00	18.00	1.19	1.31	3.90	4.30	0.07	0.22
40.00	0.81	0.61	32.00	24.00	1.58	1.75	5.20	5.73	0.09	0.30
60.00	1.22	0.91	48.00	36.00	2.38	2.62	7.80	8.60	0.14	0.45
70.00	1.42	1.07	56.00	42.00	2.77	3.06	9.10	10.03	0.16	0.52
80.00	1.63	1.22	64.00	48.00	3.17	3.50	10.40	11.46	0.18	0.60
90.00	1.83	1.37	72.00	54.00	3.57	3.93	11.70	12.90	0.21	0.67
100.00	2.03	1.52	80.00	60.00	3.96	4.37	13.00	14.33	0.23	0.75
120.00	2.44	1.83	96.00	72.00	4.75	5.24	15.60	17.20	0.27	0.90
150.00	3.05	2.29	120.00	90.00	5.94	6.55	19.50	21.49	0.34	1.12
180.00	3.66	2.74	144.00	108.00	7.13	7.86	23.39	25.79	0.41	1.35
250.00	5.08	3.81	200.00	150.00	9.91	10.92	32.49	35.82	0.57	1.87
300.00	6.10	4.57	240.00	180.00	11.89	13.11	38.99	42.99	0.69	2.25

❖ This table is for user's reference only.

WXGA

Diagonal length (inch) size of 16:10 Screen	Screen Size W x H				Projection Distance (D)				Offset (Hd)	
	(m)		(inch)		(m)		(feet)		(m)	(feet)
	Width	Height	Width	Height	wide	tele	wide	tele		
30.00	0.65	0.40	25.44	15.90	1.00	1.10	3.29	3.60	0.05	0.16
40.00	0.86	0.54	33.92	21.20	1.34	1.46	4.38	4.80	0.07	0.22
60.00	1.29	0.81	50.88	31.80	2.00	2.20	6.57	7.21	0.10	0.33
70.00	1.51	0.94	59.36	37.10	2.34	2.56	7.67	8.41	0.12	0.38
80.00	1.72	1.08	67.84	42.40	2.67	2.93	8.76	9.61	0.13	0.44
90.00	1.94	1.21	76.32	47.70	3.00	3.30	9.86	10.81	0.15	0.49
100.00	2.15	1.35	84.80	53.00	3.34	3.66	10.95	12.01	0.17	0.55
120.00	2.58	1.62	101.76	63.60	4.01	4.39	13.14	14.41	0.20	0.66
150.00	3.23	2.02	127.20	79.50	5.01	5.49	16.43	18.02	0.25	0.82
180.00	3.88	2.42	152.64	95.40	6.01	6.59	19.71	21.62	0.30	0.99
250.00	5.38	3.37	212.00	132.50	8.35	9.15	27.38	30.03	0.42	1.37
300.00	6.46	4.04	254.40	159.00	10.02	10.98	32.85	36.03	0.50	1.64

❖ This table is for user's reference only.

Control Panel & Remote Control

Control Panel



Using the Control Panel









POWER		Refer to the “Power On/Off the Projector” section on pages 13-14.
RE-SYNC		Automatically synchronize the projector to the input source.
Enter / Help		Confirm your item selection. ? Help Menu (only available when OSD menu is not shown).
SOURCE		Press “SOURCE” to select an input signal.
Menu		Press “Menu” to launch the on-screen display (OSD) menu. To exit OSD, Press “Menu” again.
Four Directional Select Keys		Use to select items or make adjustments to your selection.
Keystone		Use to adjust image distortion caused by tilting the projector. (±40 degrees)
Lamp LED		Indicate the projector’s lamp status.
Temp LED		Indicate the projector’s temperature status.
POWER/ STANDBY LED		Indicate the projector’s status.

User Controls

Remote Control

Using the Remote Control



Power 	Refer to the “Power On/Off the Projector” section on pages 13-14.
L Button	Mouse left click.
R Button	Mouse right click.
Page +	Use this button to page up.
Page -	Use this button to page down.
Enter	Confirm your item selection.
Source	Press “Source” to select an input signal.
Re-SYNC	Automatically synchronizes the projector to the input source.
Four Directional Select Keys	Use     to select items or make adjustments to your selection.
PC/Mouse Control	Use     for emulation of USB mouse via USB when you press “Switch” button.
Keystone +/-	Adjust image distortion caused by tilting the projector.
Volume +/-	Adjust to increase / decrease the volume.
Brightness	Adjust the brightness of the image.
3D	Press the “3D” to turn the 3D OSD menu on/off.
Menu	Press “Menu” to launch the on-screen display (OSD) menu. To exit OSD, press “Menu” again.
HDMI	Press “HDMI” to choose HDMI source.

User Controls



Using the Remote Control

Freeze	Press “Freeze” to pause the screen image. Press this button again to unlock.
AV mute	Momentarily turns off/on the audio and video.
S-Video	Press “S-Video” to choose S-Video source.
VGA	Press “VGA” to choose VGA sources.
Video	Press “Video” to choose Composite video source.
Switch	USB mouse switch.
Contrast	Control the degree of difference between the lightest and darkest parts of the picture.
Mode	Select the display mode from Presentation, Bright, Movie, sRGB, Blackboard, Classroom, User and 3D.
Zoom	Zoom in on an image. Press ◀▶ buttons to alter zoom.
Eco+	When Eco+ mode is activated, the brightness level of the content is automatically detected to significantly reduced lamp power consumption (up to 70%) during periods of inactivity.



- ❖ AV mute: Save up to 70% of the lamp power when AV mute is applied.

Using the HELP button

The HELP function ensures easy setup and operation.

- ▶ Press the “?” button on the remote control or press the “HELP” button on the control panel to open the Help Menu.

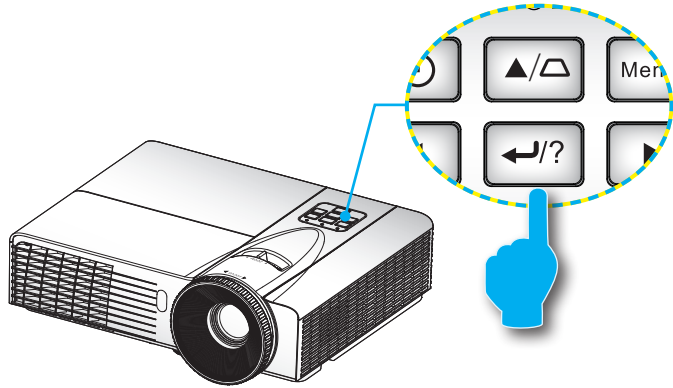

User Controls

- ▶ Help menu button functions only when no input source is detected.



- ❖ Please refer to the “Troubleshooting” section on pages 44-48 for more details.

The screenshot shows a 'HELP' menu with the following content:

HELP

? No Image appears on-screen.

UpDown Select Menu Exit

No Image appears on-screen.

- ▶ Ensure all the cables and power connections are correctly and securely connected as described in the Installation section of User's Manual.
- ▶ Ensure all the pins of connectors are not bent or broken.
- ▶ Ensure that the [AV MUTE] feature is not turned on.

[NEXT]

[Exit]

UpDown Select Menu Exit

No Image appears on-screen.

- ▶ If you are using a Notebook :
 1. First, follow the steps above to adjust resolution of the computer.
 2. Press the toggle output settings. Example : [Fn]+[F4]

Acer ⇨	[Fn]+[F5]	IBM/Lenovo ⇨	[Fn]+[F7]
Asus ⇨	[Fn]+[F8]	HP/Compaq ⇨	[Fn]+[F4]
Dell ⇨	[Fn]+[F8]	NEC ⇨	[Fn]+[F3]
Gateway ⇨	[Fn]+[F4]	Toshiba ⇨	[Fn]+[F5]

Mac Apple :

System Preference ⇨ Display ⇨ Arrangement ⇨ Mirror display

[PREV]

[Exit]

UpDown Select Menu Exit

- ▶ If input source is detected and help button is pressed, the following pages will appear to help diagnose any problems.

The screenshot shows a 'HELP' menu with the following content:

HELP

- ? Image has slanted sides.
- ? Image is too small or too large.
- ? Image is unstable or flickering.
- ? There is no audio heard or the volume is too low.

UpDown Select Menu Exit

User Controls

Image has slanted sides.

- ▶ If possible, reposition the projector so that is centered on the screen and below the bottom of the screen.
- ▶ Press [KEYSTONE + / -] button until the sides are vertical on the remote control.

[KEYSTONE + / -]





Image is too small or too large.

- ▶ Adjust the Zoom Ring on the top of projector.
- ▶ Move the projector closer to or further from the screen.
- ▶ Press [MENU] button on the remote control or projector panel, go to "DISPLAY | Format" and try the different settings.

[DISPLAY | Format]



There is no audio heard or the volume is too low.

-  Is the volume setting at the minimum?
 - ▶ Turn up the volume setting.
-  Is the cable connected properly to the projector?
 - ▶ Check the physical connection and ensure the cable is connected properly from the source to projector.

[Volume]



Image is unstable or flickering.

- ▶ Use [Phase / Frequency] to correct it.
- ▶ Change the monitor color setting on your computer.

[Phase]

[Frequency]



On-screen Display Menus

The Projector has multilingual On-screen Display menus that allow you to make image adjustments and change a variety of settings.

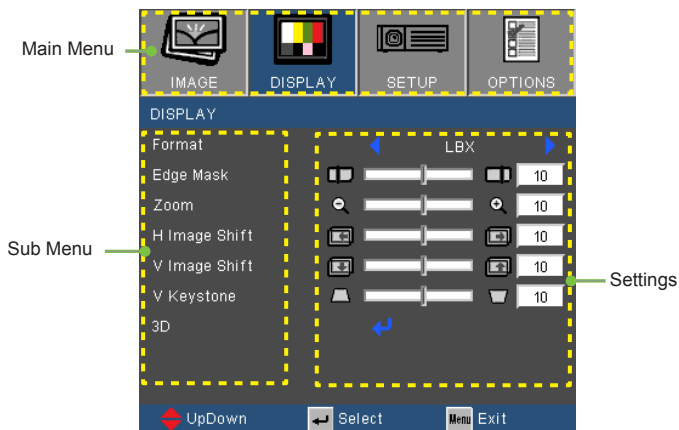

How to operate

1. To open the OSD menu, press “Menu” on the Remote Control or Projector Keypad.
2. When OSD is displayed, use ◀▶ keys to select any item in the main menu. While making a selection on a particular page, press ▼ or “Enter” key to enter sub menu.
3. Use ▲▼ keys to select the desired item and adjust the settings using ◀▶ key.
4. Select the next item to be adjusted in the sub menu and adjust as described above.
5. Press “Enter” to confirm, and the screen will return to the main menu.
6. To exit, press “MENU” again. The OSD menu will close and the projector will automatically save the new settings.



User Controls

Menu Tree

Main Menu	Sub Menu	Settings	
Image	Display Mode	Presentation / Bright / Movie / sRGB / Blackboard / Classroom / User / 3D	
	Brightness	-50~50	
	Contrast	-50~50	
	Sharpness	1~15	
	^{#1} Color	-50~50	
	^{#1} Tint	-50~50	
	Advanced	Gamma Film / Video / Graphics / Standard	
		BrilliantColor™ 0~10	
		Color Temp. Warm / Medium / Cold	
		Color Settings Red Gain / Green Gain / Blue Gain / Red Bias / Green Bias / Blue Bias / Cyan / Magenta / Yellow / Reset / Exit	
		Color Space AUTO / RGB / YUV	
		^{#5} AUTO / RGB (0-255) / RGB (16-235) / YUV	
		Input Source VGA1 / VGA2 / Video / S-Video / HDMI	
	Exit		
Display	Format	^{#3} 4:3 / 16:9 or 16:10 / LBX / Native / AUTO	
		^{#2} 4:3 / 16:9-1 / 16:9-II / Native / AUTO	
	Edge Mask	0~10	
	Zoom	-5~25 (80%~200%)	
	H Image Shift	-50~50	
	V Image Shift	-50~50	
	V Keystone	-40~40	
	3D	3D Mode Off / DLP-Link / IR	
	^{#4} 3D Sync. Invert On / Off		
	Exit		
Setup	Language	English / Deutsch / Français / Italiano / Español / Português / Svenska / Nederlands / Norsk/Dansk / Polski / Suomi / Русский / ελληνικά / Magyar / Čeština / العربية / 繁體中文 / 简体中文 / 日本語 / 한국어 / Türkçe / Việt / Bahasa Indonesia / Română	
	^{#3} Screen Type	16:10 / 16:9	
	Projection		
	Menu Location		
	^{#5} Signal	Automatic	On / Off
		Phase (VGA)	0~31
		Frequency (VGA)	-5~5
		H. Position (VGA)	-5~5
		V. Position (VGA)	-5~5
		Exit	
Security	Security	On / Off	
	Security Timer	Month / Day / Hour	
	Change Password		
	Exit		

User Controls

Main Menu	Sub Menu	Settings	
Setup	Projector ID	0~99	
	Mute	On / Off	
	Volume	0~10	
	Advanced	Logo	Default / Neutral
		Closed Captioning	Off / CC1 / CC2
		Exit	
Options	Source Lock	On / Off	
	High Altitude	On / Off	
	Information Hide	On / Off	
	Keypad Lock	On / Off	
	Test Pattern	None / Grid / White Pattern	
	Background Color	Black / Red / Blue / Green / White	
	Advanced	Direct Power On	On / Off
		Auto Power Off (min.)	0~180
		Sleep Timer (min.)	0~995
		Quick Resume	On / Off
		Power Mode (Standby)	Active / Eco
		Exit	
		Lamp Settings	Lamp Hours
	Lamp Reminder		On / Off
	Brightness Mode		Bright / Eco / Eco+
	Lamp Reset		Yes / No
	Exit		
Reset			



- ❖ Please note that the on-screen display (OSD) menus vary according to the signal type selected and the projector model you are using.
- ❖ (#1) "Color" and "Tint" are only supported in Video mode.
- ❖ (#2) For XGA model only.
- ❖ (#3) For WXGA model only. 16:9 or 16:10 depend on "Screen Type" setting.
- ❖ (#4) "3D Sync Invert" is only available when 3D is enabled.
- ❖ (#5) "Signal" is only supported in Analog VGA (RGB) signal.
- ❖ (#6) For HDMI source device only.

IMAGE

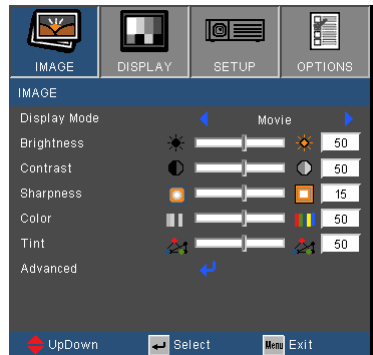

Display Mode

There are many factory presets optimized for various types of images.

- ▶ Presentation: Good color and brightness from PC input.
- ▶ Bright: Maximum brightness from PC input.
- ▶ Movie: For home theater.
- ▶ sRGB: Standardised accurate color.
- ▶ Blackboard: This mode should be selected to achieve optimum color settings when projecting onto a blackboard (green).
- ▶ Classroom: This mode is recommended for projecting in a classroom.
- ▶ User: User's settings.
- ▶ 3D: Recommend setting for 3D mode enabled. Any further adjustments by the user in 3D will be saved in this mode for further use.

Brightness

Adjust the brightness of the image.

- ▶ Press the ◀ to darken image.
- ▶ Press the ▶ to lighten the image.

Contrast

The contrast controls the degree of difference between the lightest and darkest parts of the picture.

- ▶ Press the ◀ to decrease the contrast.
- ▶ Press the ▶ to increase the contrast.

User Controls



❖ “Color” and “Tint” functions are only supported under Video mode.

Sharpness

Adjust the sharpness of the image.

- ▶ Press the ◀ to decrease the sharpness.
- ▶ Press the ▶ to increase the sharpness.

Color

Adjust a video image from black and white to fully saturated color.

- ▶ Press the ◀ to decrease the amount of saturation in the image.
- ▶ Press the ▶ to increase the amount of saturation in the image.

Tint

Adjust the color balance of red and green.

- ▶ Press the ◀ to increase the amount of green in the image.
- ▶ Press the ▶ to increase the amount of red in the image.

IMAGE | Advanced

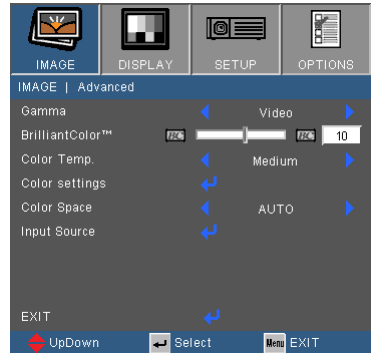

Gamma

This allows you to choose a degamma table that has been fine-tuned to bring out the best image quality for the input.

- ▶ Film: for home theater.
- ▶ Video: for video or TV source.
- ▶ Graphics: for image source.
- ▶ Standard: for PC or computer source.

BrilliantColor™

This adjustable item utilizes a new color-processing algorithm and system level enhancements to enable higher brightness while providing true, more vibrant colors in picture. The range is from “0” to “10”. If you prefer a stronger enhanced image, adjust toward the maximum setting. For a smoother, more natural image, adjust toward the minimum setting.

Color Temp

If set to cold temperature, the image looks more blue. (cold image)
If set to warm temperature, the image looks more red.

(warm image)

Color Settings

Press **↵** into the next menu as below and then use **▲** or **▼** to select item.

- ▶ Red Gain/Green Gain/Blue Gain/Red Bias/Green Bias/Blue Bias/Cyan/Magenta/Yellow: Use **◀** or **▶** to select Red, Green, Blue, Cyan, Magenta and Yellow Colors.
- ▶ Reset: Choose “Yes” to return the factory default settings for color adjustments.

User Controls

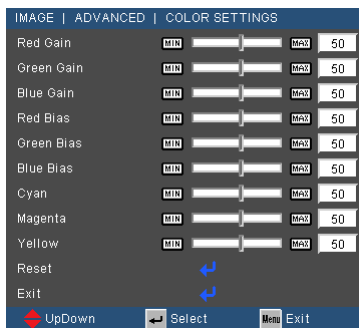

❖ (*) For HDMI only.

Color Space

Select an appropriate color matrix type from AUTO, RGB, RGB(0-255)^(*), RGB(16-235)^(*) or YUV.

Input Source

Use this option to enable / disable input sources. Press  to enter the sub menu and select which sources you require. Press “Enter” to finalize the selection. The projector will not search for inputs that are not selected.

DISPLAY

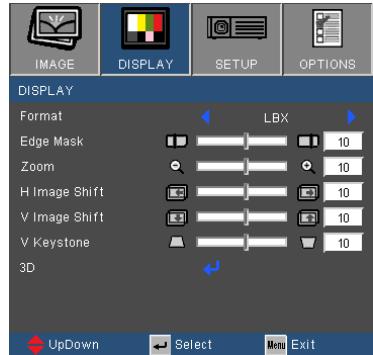

Format

Use this function to choose your desired aspect ratio.

SVGA/XGA

- ▶ 4:3: This format is for 4×3 input sources.
- ▶ 16:9-I: This format is for 16×9 input sources, like HDTV and DVD enhanced for Wide screen TV. (576i/p)
- ▶ 16:9-II: This format is for 16×9 input sources, like HDTV and DVD enhanced for Wide screen TV. (480i/p)
- ▶ Native: This format displays the original image without any scaling.
- ▶ AUTO: Automatically selects the appropriate display format. When input is 4:3, the image is displayed as 4:3. When input is 16:9 above, the image is displayed as 16:9- I

Aspect ratio (source detected)	Resize image	
	SVGA model	XGA model
4:3	800 x 600 center	1024 x 768 center
16:9-I	800 x 450 center	1024 x 576 center
16:9-II	800 x 480 center	854 x 480 center
Native	No resize image, 1:1 mapping and centered. This format shows the original image without scaling.	

User Controls



❖ 16:9 or 16:10 depend on “Screen Type” setting.

WXGA

- ▶ 4:3: This format is for 4×3 input sources.
- ▶ 16:9: This format is for 16×9 input sources, like HDTV and DVD enhanced for Wide screen TV.
- ▶ 16:10: This format is for 16×10 input sources, like widescreen laptops.
- ▶ LBX: This format is for non-16x9, letterbox source and for users who use external 16x9 lens to display 2.35:1 aspect ratio using full resolution.
- ▶ Native: This format displays the original image without any scaling.
- ▶ AUTO: Automatically selects the appropriate display format.

16:10 Screen	480i/p	576i/p	1080i/p	720p	PC
4:3	1066 x 800 center				
16:10	1280 x 800 center				
LBX	1280 x 960 center, then get the central 1280 x 800 image to display				
Native	1:1 mapping centered.	1:1 mapping (960 x 540) display 1280 x 800	1280 x 720 center	1:1 mapping centered.	

16:9 Screen	480i/p	576i/p	1080i/p	720p	PC
4:3	960 x 720 center				
16:9	1280 x 720 center				
LBX	1280 x 960 center, then get the central 1280 x 720 image to display				
Native	1:1 mapping centered.	1:1 mapping (960 x 540) display 1280 x 720	1280 x 720 center	1:1 mapping centered.	



- ❖ Each I/O has different setting of “Edge mask”.
- ❖ “Edge mask” and “Zoom” can’t work at same time.

Edge Mask

Edge mask function removes the noise in a video image. Edge mask the image to remove video encoding noise on the edge of video source.

Zoom

- ▶ Press the ◀ to reduce the size of an image.
- ▶ Press the ▶ to magnify an image on the projection screen.

H Image Shift

Shift the projected image position horizontally.

V Image Shift

Shift the projected image position vertically.

V Keystone

Press the ◀ or ▶ to adjust image distortion vertically. If the image looks trapezoidal, this option can help make the image rectangular.

DISPLAY | 3D

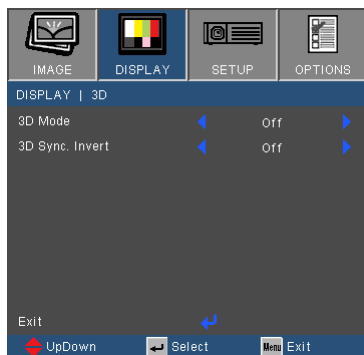

- ❖ “IR” options may vary according to model.
- ❖ “3D Sync Invert” is only available when 3D is enabled and this mode 3D is for DLP link glass only.
- ❖ Compatible 3D source, 3D content and active shutter glasses are required for 3D viewing.

3D Mode

- ▶ Off: Select “Off” to turn 3D settings off for 3D images.
- ▶ DLP Link: Select “DLP Link” to use optimized settings for DLP Link 3D images.
- ▶ IR: Select “IR” to use optimized settings for IR-based 3D images.

3D Sync. Invert

- ▶ Press the “On” to invert left and right frame contents.
- ▶ Press the “Off” for default frame contents.

SETUP

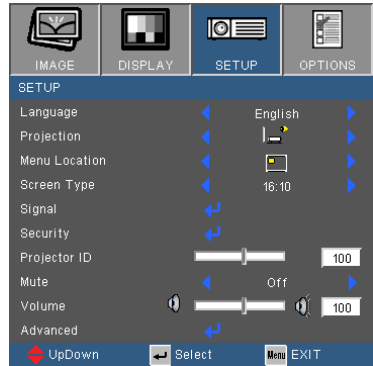

- ❖ “SETUP” options may vary according to model.

Language

Choose the multilingual OSD menu. Press ◀ or ▶ into the sub menu and then use the ▲ or ▼ key to select your preferred language. Press “Enter” to finalize the selection.



Projection

- ▶  Front-Desktop

This is the default selection. The image is projected straight on the screen.

- ▶  Front-Ceiling

When selected, the image will turn upside down.

- ▶  Rear-Desktop

When selected, the image will appear reversed.



- ❖ Rear-Desktop and Rear-Ceiling are to be used with a translucent screen.

User Controls

- ▶  Rear-Ceiling

When selected, the image will appear reversed in upside down position.

Menu Location

Choose the menu location on the display screen.

Screen Type

Choose the screen type from 16:10 or 16:9.

Projector ID

ID definition can be set up by menu (range 0-99), and allow user control an individual projector by RS232. Refer to pages 55-58 for the complete list of RS232 commands.

Mute

- ▶ Choose the "On" to turn mute on.
- ▶ Choose the "Off" to turn mute off.

Volume

- ▶ Press the ◀ to decrease the volume.
- ▶ Press the ▶ to increase the volume.



- ❖ "Screen Type" is for WXGA only.

SETUP | Signal (RGB)

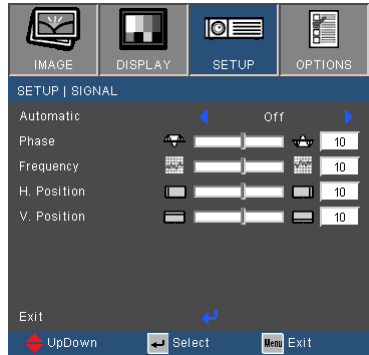

- ❖ “Signal” is only supported in Analog VGA (RGB) signal.

Automatic

Automatically selects the signal. If you use this function, the Phase, frequency items are grayed out, and if Signal is not automatic, the phase, frequency items will appear for user to manually tune and saved in settings after that for next time projector turns off and on again.

Phase

Synchronize the signal timing of the display with the graphic card. If the image appears to be unstable or flickers, use this function to correct it.

Frequency

Change the display data frequency to match the frequency of your computer’s graphic card. Use this function only if the image appears to flicker vertically.

H. Position

- ▶ Press the ◀ to move the image left.
- ▶ Press the ▶ to move the image right.

V. Position

- ▶ Press the ◀ to move the image down.
- ▶ Press the ▶ to move the image up.

SETUP | Security

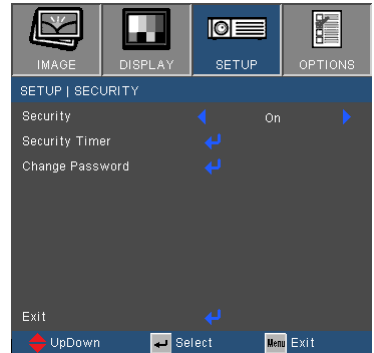

Security

- ▶ On: Choose “On” to use security verification when the turning on the projector.
- ▶ Off: Choose “Off” to be able to switch on the projector without password verification.



- ❖ Password default value is “1234” (first time).

Security Timer

Use this function to set the how long (Month/Day/Hour) the projector can be used. Once this time has elapsed you will be requested to enter your password again.

Change Password

- ▶ First time:
 1. Press “←” to set the password.
 2. The password has to be 4 digits.
 3. Use number button on the remote to enter your new password and then press “←” key to confirm your password.
- ▶ Change Password:
 1. Press “←” to input old password.
 2. Use number button to enter current password and then press “←” to confirm.
 3. Enter new password (4 digits in length) using the number buttons on the remote, then press “←” to confirm.
 4. Enter new password again and press “←” to confirm.

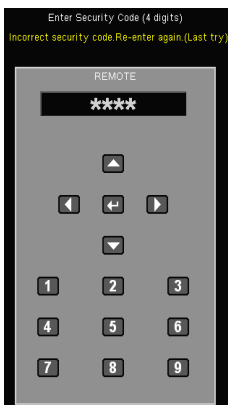



User Controls

- ▶ If the incorrect password is entered 3 times, the projector will automatically shut down.
- ▶ If you have forgotten your password, please contact your local office for support.

SETUP | Advanced

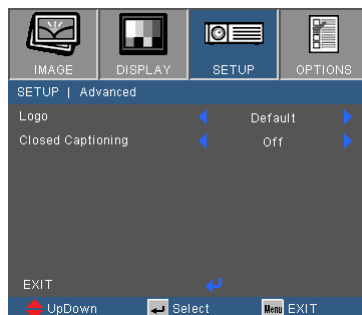

Logo

Use this function to set the desired startup screen. If changes are made they will take effect the next time the projector is powered on.

- ▶ Default: The default startup screen.
- ▶ Neutral: Logo is not displayed on startup screen.

Closed Captioning

Use this function to set the desired startup screen. If changes are made they will take effect the next time the projector is powered on.

- ▶ Off: select “off” to turn off the closed captioning feature.
- ▶ CC1:CC1 language: American English.
- ▶ CC2:CC2 language (depending on the TV channel of the user): Spanish, French, Portuguese, German, Danish.

OPTIONS

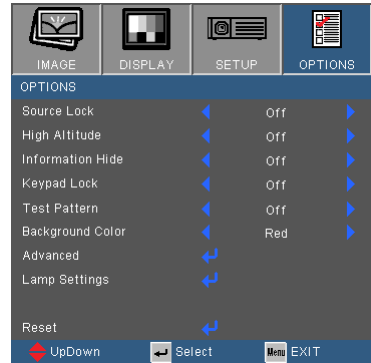

Source Lock

- ▶ On: The projector will only search current input connection.
- ▶ Off: The projector will search for other signals if the current input signal is lost.

High Altitude

When “On” is selected, the fans will spin faster. This feature is useful in high altitude areas where the air is thin.

Information Hide

- ▶ On: Choose “On” to hide the info message.
- ▶ Off: Choose “Off” to show the “searching” message.

Keypad Lock

When the keypad lock function is “On”, the control panel will be locked however, the projector can be operated by the remote control. By selecting “Off”, you will be able to reuse the control panel.

Test Pattern

Display a test pattern. There are Grid, White pattern and None.

Background Color

Use this feature to display a “Black”, “Red”, “Blue”, “Green” or “White”, screen when no signal is available.

Reset

Choose “Yes” to return the display parameters on all menus to the factory default settings.



- ❖ To turn off the keypad lock, press and hold “Enter” key on top of the projector for 5 seconds.

OPTIONS | Advanced

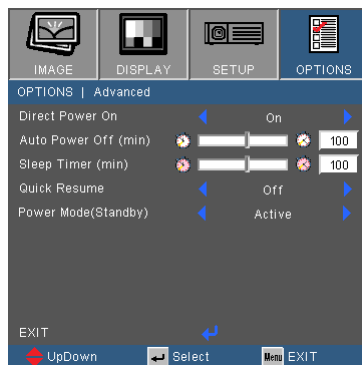

Direct Power On

Choose “On” to activate Direct Power mode. The projector will automatically power on when AC power is supplied, without pressing the “**⏻**” key on the projector control panel or on the remote control.

Auto Power Off (min)

Sets the countdown timer interval. The countdown timer will start, when there is no signal being sent to the projector. The projector will automatically power off when the countdown has finished (in minutes).

Sleep Timer (min)

Sets the countdown timer interval. The countdown timer will start, with or without a signal being sent to the projector. The projector will automatically power off when the countdown has finished (in minutes).

Quick Resume

- ▶ On: If the projector is accidentally turned off, this feature allows the projector to be instantly powered on again, if selected within a period of 100 seconds.
- ▶ Off: The fan will start cooling the system immediately when user turns off the projector.

Power Mode (Standby)

- ▶ Eco.: Choose “Eco.” to save power dissipation further < 0.5W.
- ▶ Active: Choose “Active” to return to normal standby and the VGA out port will be enabled.



❖ When Power mode (Standby) is set to Eco (<0.5W), the VGA output and Audio pass-through will be deactivated when the projector is in standby.

OPTIONS | Lamp Settings

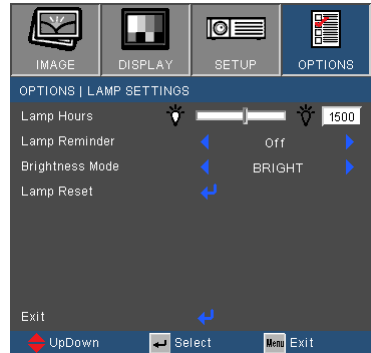

Lamp Hours

Display the projection time.

Lamp Reminder

Choose this function to show or to hide the warning message when the changing lamp message is displayed.

The message will appear 30 hours before suggested replacement of lamp.



❖ When ambient temperature is over 40°C in operating, the projector will switch to Eco automatically.

Brightness Mode

- ▶ BRIGHT: Choose “BRIGHT” to increase the brightness.
- ▶ Eco.: Choose “Eco.” to dim the projector lamp which will lower power consumption and extend the lamp life.
- ▶ Eco+: When Eco+ mode is activated, the brightness level of the content is automatically detected to significantly reduced lamp power consumption (up to 70%) during periods of inactivity.

Lamp Reset

Reset the lamp hour counter after replacing the lamp.

Troubleshooting

If you experience a problem with your projector, please refer to the following information. If a problem persists, please contact your local reseller or service center.

[?] No image appears on-screen

- ▶ Ensure all the cables and power connections are correctly and securely connected as described in the “Installation” section.
- ▶ Ensure all the pins of connectors are not bent or broken.
- ▶ Check if the projection lamp has been securely installed. Please refer to the “Replacing the lamp” section.
- ▶ Make sure you have removed the lens cap and the projector is switched on.
- ▶ Ensure that the “AV mute” feature is not turned on.

[?] Partial, scrolling or incorrectly displayed image

- ▶ Press “Re-SYNC” on the remote.
- ▶ If you are using a PC:

For Windows 95, 98, 2000, XP, Windows 7:

1. Open the “My Computer” icon, the “Control Panel” folder, and then double click on the “Display” icon.
2. Select the “Settings” tab.
3. Verify that your display resolution setting is lower than or equal to UXGA (1600 × 1200).
4. Click on the “Advanced Properties” button.

If the projector is still not projecting the whole image, you will also need to change the monitor display you are using. Refer to the following steps.

5. Verify the resolution setting is lower than or equal to UXGA (1600 × 1200).
6. Select the “Change” button under the “Monitor” tab.

Appendices

7. Click on “Show all devices”. Next, select “Standard monitor types” under the SP box; choose the resolution mode you need under the “Models” box.
 8. Verify that the resolution setting of the monitor display is lower than or equal to UXGA (1600 × 1200).
- ▶ If you are using a Notebook:
1. First, follow the steps above to adjust resolution of the computer.
 2. Press the appropriate keys listed below for your notebook manufacturer to send signal out from notebook to projector.
Example: [Fn]+[F4]

Acer ⇨	[Fn]+[F5]	IBM/Lenovo ⇨	[Fn]+[F7]
Asus ⇨	[Fn]+[F8]	HP/Compaq ⇨	[Fn]+[F4]
Dell ⇨	[Fn]+[F8]	NEC ⇨	[Fn]+[F3]
Gateway ⇨	[Fn]+[F4]	Toshiba ⇨	[Fn]+[F5]

Mac Apple:

System Preference ⇨ Display ⇨ Arrangement ⇨ Mirror display

- ▶ If you experience difficulty changing resolutions or your monitor freezes, restart all equipment including the projector.

[?] The screen of the Notebook or PowerBook computer is not displaying your presentation

▶ If you are using a Notebook PC

Some Notebook PCs may deactivate their own screens when a second display device is in use. Each has a different way to be reactivated. Refer to your computer’s manual for detailed information.

[?] Image is unstable or flickering

- ▶ Use “Phase” to correct it. See page 37 for more information.
▶ Change the monitor color setting on your computer.

[?] Image has vertical flickering bar

- ▶ Use “Frequency” to make an adjustment. See page 37 for more information.
▶ Check and re-configure the display mode of your graphic card to make it compatible with the projector.

? Image is out of focus

- ▶ Make sure the lens cap is removed.
- ▶ Adjust the Focus Ring on the projector lens.
- ▶ Make sure the projection screen is between the required distance. See page 17.



? The image is stretched when displaying 16:9 DVD title

- ▶ When you play anamorphic DVD or 16:9 DVD, the projector will show the best image when the projector display mode is set to 16:9 in the OSD.
- ▶ If you play 4:3 format DVD titles, please change the format to 4:3 in the projector OSD.
- ▶ If the image is still stretched, you will also need to adjust the aspect ratio by referring to the following:
- ▶ Please setup the display format as 16:9 (wide) aspect ratio type on your DVD player.

? Image is too small or too large

- ▶ Move the projector closer to or further from the screen.
- ▶ Press “Menu” button on the remote control or projector panel, go to “DISPLAY → Format” and try the different settings.

? Image has slanted sides

- ▶ If possible, reposition the projector so that it is horizontally centered on the screen and below the bottom of the screen.
- ▶ Press “Keystone +/-” button on the remote control or press “ / ” on the projector panel, until the sides are vertical.

? Image is reversed

- ▶ Select “SETUP → Projection” from the OSD and adjust the projection direction.





[?] The projector stops responding to all controls

- ▶ If possible, turn off the projector, then unplug the power cord and wait at least 60 seconds before reconnecting power.
- ▶ Check that “Keypad Lock” is not activated by trying to control the projector with the remote control.

[?] Lamp burns out or makes a popping sound

- ▶ When the lamp reaches its end of life, it will burn out and may make a loud popping sound. If this happens, the projector will not turn on until the lamp module has been replaced. To replace the lamp, follow the procedures in the “Replacing the Lamp” section on pages 49-50.

[?] LED lighting message

Message			
	POWER/STANDBY LED (Green/Amber)	Temp-LED (Red)	Lamp-LED (Red)
Standby State (Input power cord)	Amber	○	○
Power on (Warming)	Flashing Green	○	○
Lamp lighting	Green	○	○
Power off (Cooling)	Flashing Green	○	○
Quick Resume(100 secs)	Flashing Green	○	○
Error (Over Temp.)	Flashing Amber		○
Error (Fan fail)	Flashing Amber	Flashing	○
Error (Lamp fail)	Flashing Amber	○	

* POWER/STANDBY LED be ON when OSD appears, be OFF when OSD disappears.



Steady light ⇨ 
No light ⇨ ○

? On Screen Messages

▶ Temperature warning:

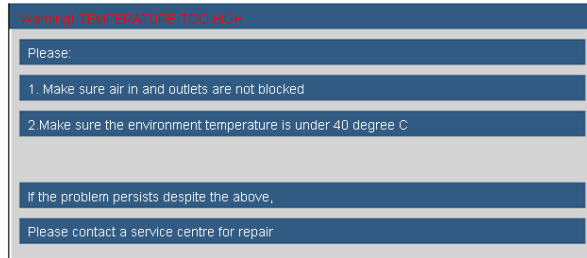

▶ Fan failed:



▶ Lamp warning:

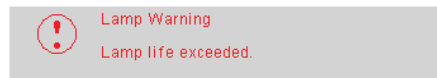

▶ Out of display range:

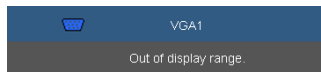

? If the remote control does not work

- ▶ Check the operating angle of the remote control is within $\pm 15^\circ$ both horizontally and vertically of one of the IR receivers on the projector.
- ▶ Make sure there are not any obstructions between the remote control and the projector. Move to within 7 m ($\pm 0^\circ$) of the projector.
- ▶ Make sure the batteries are inserted correctly.
- ▶ Replace batteries if they are exhausted.

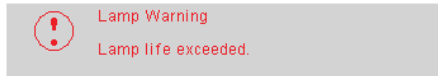

Replacing the lamp

The projector automatically detects the lamp life. When the lamp life is nearing the end of use, you will receive a warning message.

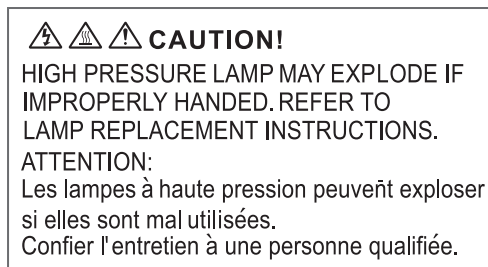

When you see this message, please contact your local reseller or service center to change the lamp as soon as possible. Make sure the projector has been cooled down for at least 30 minutes before changing the lamp.



-  Warning: If ceiling mounted, please use caution when opening the lamp access panel. It is recommended to wear safety glasses if changing the bulb when ceiling mounted. "Caution must be used to prevent any loose parts from falling out of projector."
-  Warning: Lamp compartment may be hot! Allow it to cool down before changing the lamp!
-  Warning: To reduce the risk of personal injury, do not drop the lamp module or touch the lamp bulb. The bulb may shatter and cause injury if it is dropped.

Appendices



- ❖ The screws on the lamp cover and the lamp cannot be removed.
- ❖ The projector cannot be turned on if the lamp cover has not been placed back on the projector.
- ❖ Do not touch the glass area of the lamp. Hand oil can cause the lamp to shatter. Use a dry cloth to clean the lamp module if it was accidentally touched.

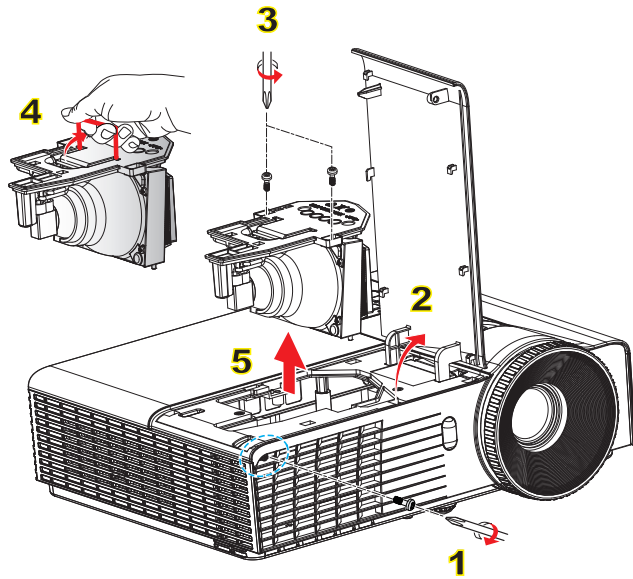

Lamp Replacement Procedure:

1. Switch off the power to the projector by pressing the “” button.
2. Allow the projector to cool down for at least 30 minutes.
3. Disconnect the power cord.
4. Unscrew the one screw on the cover. **1**
5. Lift up and remove the cover. **2**
6. Unscrew the two screws on the lamp module. **3**
7. Lift up the lamp handle **4** and remove the lamp module slowly and carefully. **5**

To replace the lamp module, reverse the previous steps.

8. Turn on the projector and use “Lamp Reset” after the lamp module is replaced.

Lamp Reset: (i) Press “Menu” → (ii) Select “OPTIONS” → (iii) Select “Lamp Settings” → (iv) Select “Lamp Reset” → (v) Select “Yes”.

Compatibility Modes

► Computer Compatibility

Mode	Resolution	Anglog/Digital		SVGA/ XGA	WXGA
		H-Sync (KHz)	V-Sync (Hz)		
VGA	640 × 350	31.50	70	V	V
VGA	640 × 350	37.90	85	V	V
VGA	720 × 350	31.50	70	V	
VGA	640 × 400	31.50	70	V	
VGA	640 × 400	37.90	85	V	V
VGA	720 × 400	31.50	70	V	V
VGA	720 × 400	37.90	85	V	V
	720 × 576	-	50	V	
	720 × 576	-	60	V	
VGA	640 × 480	31.50	60	V	V
VGA	640 × 480	-	67	V	V
VGA	640 × 480	37.90	72	V	V
VGA	640 × 480	37.50	75	V	V
VGA	640 × 480	43.30	85	V	
SVGA	800 × 600	35.20	56	V	V
SVGA	800 × 600	37.90	60	V	V
SVGA	800 × 600	46.90	75	V	V
SVGA	800 × 600	48.10	72	V	V
SVGA	800 × 600	-	80	V	
SVGA	800 × 600	53.70	85	V	
SVGA	800 × 600	-	120		V
	832 × 624	-	72	V	
	832 × 624	-	75	V	V
XGA	1024 × 576	-	50	V	
XGA	1024 × 576	-	60	V	
XGA	1024 × 768	48.40	60	V	V
XGA	1024 × 768	56.50	70	V	V
XGA	1024 × 768	57.70	72	V	



- ❖ For widescreen resolution (WXGA), the compatibility support is dependent on Notebook/PC models.
- ❖ 120Hz input signals may be dependent on graphics cards support.
- ❖ Please note that using resolutions other than native 800 x 1024 (SVGA), 1024 x 768 (XGA model), 1280 x 800 (WXGA model) may result in some loss of image clarity.

Appendices

Mode	Resolution	Anglog/Digital		SVGA/ XGA	WXGA
		H-Sync (KHz)	V-Sync (Hz)		
XGA	1024 × 768	60.00	75	V	V
XGA	1024 × 768	68.70	85	V	
XGA	1024 × 768	-	120		V
	1152 × 864	-	60	V	
	1152 × 864	-	70	V	
	1152 × 864	-	75	V	
	1152 × 864	-	85	V	
	1152 × 870	-	75	V	V
HD720	1280 x 720	-	50	V	
HD720	1280 x 720	-	60	V	
HD720	1280 x 720	-	75	V	
HD720	1280 x 720	-	85	V	
HD720	1280 x 720	-	120		V
WXGA	1280 x 768	47.40	60	V	
WXGA	1280 x 768	-	70	V	
WXGA	1280 x 768	-	75	V	
WXGA	1280 x 768	-	85	V	
WXGA-800	1280 x 800	-	60	V	V
SXGA	1280 x 1024	64.00	60	V	V
SXGA	1280 x 1024	80.00	75	V	
SXGA	1280 x 1024	91.10	85	V	
	1366 x 768	60	-		V
	1400 x 900	60	55.935		V
SXGA+	1400 x 1050	-	60	V	V
	1680 x 1050	60	-		V
UXGA	1600 × 1200	75.00	60	V	V
HDTV	1920 x 1080	33.80	30	V	V
HDTV	1920 × 1080	28.10	25	V	
HDTV	1920 x 1080i	-	50/60	V	V
HDTV	1920 x 1080p	-	24/25/30/50/60	V	V
HDTV	1280 x 720	45.00	60	V	V
HDTV	1280 x 720p	-	50/60	V	V

Appendices

Mode	Resolution	Anglog/Digital		SVGA/ XGA	WXGA
		H-Sync (KHz)	V-Sync (Hz)		
SDTV	720 × 576	31.30	50	V	
SDTV	720 × 576i	-	50	V	V
SDTV	720 × 576p	-	50	V	V
SDTV	720 × 480	31.50	60	V	
SDTV	720 × 480i	-	60	V	V
SDTV	720 × 480p	-	60	V	V

▶ Computer Compatibility

Mode	Resolution	V-Sync (Hz)	H-Sync (KHz)
MAC LC 13"	640 × 480	66.66	34.98
MAC II 13"	640 × 480	66.68	35.00
MAC 16"	832 × 624	74.55	49.73
MAC 19"	1024 × 768	75	60.24
MAC	1152 × 870	75.06	68.68
MAC G4	640 × 480	60	31.35
i MAC DV	1024 × 768	75	60.00
i MAC DV	1152 × 870	75	68.49

▶ Video Compatibility

NTSC	M/J, 3.58MHz, 4.43 MHz
PAL	B, D, G, H, I, M, N (4.43 MHz)
SECAM	B, D, G, K, K1, L (4.25/4.4 MHz)
SDTV	480i/p, 576i/p,
HDTV	720p@50Hz/60Hz, 1080i@50Hz/60Hz, 1080p@50Hz/60Hz

RS232 Commands and Protocol Function List

RS232 Pin Assignments



- ❖ RS232 shell is grounded.

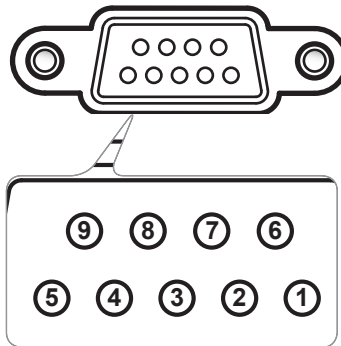

Pin no.	Spec. (from projector side)
1	N/A
2	RXD
3	TXD
4	N/A
5	GND
6	N/A
7	N/A
8	N/A
9	N/A

Appendices

RS232 Protocol Function List



1. There is a <CR> after all ASCII commands.
2. 0D is the HEX code for <CR> in ASCII code.

Baud Rate : 9600

Data Bits: 8

Parity: None

Stop Bits: 1

Flow Control : None

UART16550 FIFO: Disable

Projector Return (Pass): P

Projector Return (Fail): F

XX=00-99, projector's ID,

XX=00 is for all projectors

Note : the -XX must be set as -00 when use on telnet command no matter what ID projector has. eg: telnet with -0004 1 can execute Freeze function but -3804 1 can't.

SEND to projector (telnet supported)

32 ASCII Code	HEX Code	Function	Description
-XX00 1	7E 30 30 30 20 31 0D	Power ON	
-XX00 0	7E 30 30 30 20 30 0D	Power OFF	(0/2 for backward compatible)
-XX00 1 -nnnn	7E 30 30 30 20 31 20 a 0D	Power ON with Password	-nnnn = -0000 (a=7E 30 30 30 30) -9999 (a=7E 39 39 39 39)
-XX01 1	7E 30 30 30 31 20 31 0D	Resync	
-XX02 1	7E 30 30 30 32 20 31 0D	AV Mute	On
-XX02 0	7E 30 30 30 32 20 30 0D		Off (0/2 for backward compatible)
-XX03 1	7E 30 30 30 33 20 31 0D	Mute	On
-XX03 0	7E 30 30 30 33 20 30 0D		Off (0/2 for backward compatible)
-XX04 1	7E 30 30 30 34 20 31 0D	Freeze	
-XX04 0	7E 30 30 30 34 20 30 0D	Unfreeze	(0/2 for backward compatible)
-XX05 1	7E 30 30 30 35 20 31 0D	Zoom Plus	
-XX06 1	7E 30 30 30 36 20 31 0D	Zoom Minus	
-XX12 1	7E 30 30 31 32 20 31 0D	Direct Source Commands	HDMI (for ES556/EX556/EW556)
-XX12 5	7E 30 30 31 32 20 35 0D		VGA1
-XX12 6	7E 30 30 31 32 20 36 0D		VGA 2
-XX12 8	7E 30 30 31 32 20 38 0D		VGA1 Component
-XX12 9	7E 30 30 31 32 20 39 0D		S-Video
-XX12 10	7E 30 30 31 32 20 31 30 0D		Video
-XX12 13	7E 30 30 31 32 20 31 33 0D		VGA 2 Component
-XX20 1	7E 30 30 32 30 20 31 0D	Display Mode	Presentation
-XX20 2	7E 30 30 32 30 20 32 0D		Bright
-XX20 3	7E 30 30 32 30 20 33 0D		Movie
-XX20 4	7E 30 30 32 30 20 34 0D		sRGB
-XX20 5	7E 30 30 32 30 20 35 0D		User
-XX20 7	7E 30 30 32 30 20 37 0D		Blackboard
-XX20 8	7E 30 30 32 30 20 38 0D		Classroom
-XX20 9	7E 30 30 32 30 20 39 0D		3D
-XX21 n	7E 30 30 32 31 20 a 0D	Brightness	n = -50 (a=2D 35 30) - 50 (a=35 30)
-XX22 n	7E 30 30 32 32 20 a 0D	Contrast	n = -50 (a=2D 35 30) - 50 (a=35 30)
-XX23 n	7E 30 30 32 33 20 a 0D	Sharpness	n = 1 (a=31) - 15 (a=31 35)
-XX24 n	7E 30 30 32 34 20 a 0D	Color Settings	Red Gain n = -50 (a=2D 35 30) - 50 (a=35 30)
-XX25 n	7E 30 30 32 35 20 a 0D		Green Gain n = -50 (a=2D 35 30) - 50 (a=35 30)
-XX26 n	7E 30 30 32 36 20 a 0D		Blue Gain n = -50 (a=2D 35 30) - 50 (a=35 30)
-XX27 n	7E 30 30 32 37 20 a 0D		Red Bias n = -50 (a=2D 35 30) - 50 (a=35 30)
-XX28 n	7E 30 30 32 38 20 a 0D		Green Bias n = -50 (a=2D 35 30) - 50 (a=35 30)
-XX29 n	7E 30 30 32 39 20 a 0D		Blue Bias n = -50 (a=2D 35 30) - 50 (a=35 30)
-XX30 n	7E 30 30 33 30 20 a 0D		Cyan n = -50 (a=2D 35 30) - 50 (a=35 30)
-XX31 n	7E 30 30 33 31 20 a 0D		Yellow n = -50 (a=2D 35 30) - 50 (a=35 30)
-XX32 n	7E 30 30 33 32 20 a 0D		Magenta n = -50 (a=2D 35 30) - 50 (a=35 30)
-XX33 1	7E 30 30 33 33 20 31 0D		Reset
-XX34 n	7E 30 30 33 34 20 a 0D	BrilliantColor™	n = 0 (a=30) - 10 (a=31 30)
-XX35 1	7E 30 30 33 35 20 31 0D	Degamma	Film
-XX35 2	7E 30 30 33 35 20 32 0D		Video
-XX35 3	7E 30 30 33 35 20 33 0D		Graphics
-XX35 4	7E 30 30 33 35 20 34 0D		Standard
-XX36 1	7E 30 30 33 36 20 31 0D	Color Temp.	Warm
-XX36 2	7E 30 30 33 36 20 32 0D		Medium
-XX36 3	7E 30 30 33 36 20 33 0D		Cold
-XX37 1	7E 30 30 33 37 20 31 0D	Color Space	Auto
-XX37 2	7E 30 30 33 37 20 32 0D		RGB/ RGB(0-255)
-XX37 3	7E 30 30 33 37 20 33 0D		YUV
-XX37 4	7E 30 30 33 37 20 34 0D		RGB(16 - 235)

Appendices

~XX45 n	7E 30 30 34 34 20 a 0D	Color (Saturation)	n = -50 (a=2D 35 30) ~ 50 (a=35 30)	
~XX44 n	7E 30 30 34 35 20 a 0D	Tint	n = -50 (a=2D 35 30) ~ 50 (a=35 30)	
~XX60 1	7E 30 30 36 30 20 31 0D	Format	4:3	
~XX60 2	7E 30 30 36 30 20 32 0D		16:9-1	
~XX60 3	7E 30 30 36 30 20 33 0D		16:9-ll/16:10(EW556)	
~XX60 5	7E 30 30 36 30 20 35 0D		LBX	
~XX60 6	7E 30 30 36 30 20 36 0D		Native	
~XX60 7	7E 30 30 36 30 20 37 0D		Auto	
~XX61 n	7E 30 30 36 31 20 a 0D		Edge mask	n = 0 (a=30) ~ 10 (a=31 30)
~XX62 n	7E 30 30 36 32 20 a 0D	Zoom	n = -5 (a=2D 35) ~ 25 (a=32 35)	
~XX63 n	7E 30 30 36 33 20 a 0D	H Image Shift	n = -50 (a=2D 35 30) ~ 50 (a=35 30)	
~XX64 n	7E 30 30 36 34 20 a 0D	V Image Shift	n = -50 (a=2D 35 30) ~ 50 (a=35 30)	
~XX66 n	7E 30 30 36 36 20 a 0D	V Keystone	n = -40 (a=2D 34 30) ~ 40 (a=34 30)	
~XX230 3	7E 30 30 32 33 30 20 31 0D	3D Mode	IR	
~XX230 1	7E 30 30 32 33 30 20 31 0D	3D Mode	DLP-Link	
~XX230 0	7E 30 30 32 33 30 20 30 0D	3D Mode	Off (0/2 for backward compatible)	
~XX231 1	7E 30 30 32 33 31 20 31 0D	3D Sync Invert	On	
~XX231 0	7E 30 30 32 33 31 20 30 0D	3D Sync Invert	Off (0/2 for backward compatible)	
~XX70 1	7E 30 30 37 30 20 31 0D	Language	English	
~XX70 2	7E 30 30 37 30 20 32 0D		German	
~XX70 3	7E 30 30 37 30 20 33 0D		French	
~XX70 4	7E 30 30 37 30 20 34 0D		Italian	
~XX70 5	7E 30 30 37 30 20 35 0D		Spanish	
~XX70 6	7E 30 30 37 30 20 36 0D		Portuguese	
~XX70 7	7E 30 30 37 30 20 37 0D		Polish	
~XX70 8	7E 30 30 37 30 20 38 0D		Dutch	
~XX70 9	7E 30 30 37 30 20 39 0D		Swedish	
~XX70 10	7E 30 30 37 30 20 31 30 0D		Norwegian/Danish	
~XX70 11	7E 30 30 37 30 20 31 31 0D		Finnish	
~XX70 12	7E 30 30 37 30 20 31 32 0D		Greek	
~XX70 13	7E 30 30 37 30 20 31 33 0D		Traditional Chinese	
~XX70 14	7E 30 30 37 30 20 31 34 0D		Simplified Chinese	
~XX70 15	7E 30 30 37 30 20 31 35 0D		Japanese	
~XX70 16	7E 30 30 37 30 20 31 36 0D		Korean	
~XX70 17	7E 30 30 37 30 20 31 37 0D		Russian	
~XX70 18	7E 30 30 37 30 20 31 38 0D		Hungarian	
~XX70 19	7E 30 30 37 30 20 31 39 0D		Czechoslovak	
~XX70 20	7E 30 30 37 30 20 32 30 0D		Arabic	
~XX70 21	7E 30 30 37 30 20 32 31 0D		Thai	
~XX70 22	7E 30 30 37 30 20 32 32 0D		Turkish	
~XX70 23	7E 30 30 37 30 20 32 33 0D		Farsi	
~XX70 25	7E 30 30 37 30 20 32 35 0D		Vietnamese	
~XX70 26	7E 30 30 37 30 20 32 36 0D		Indonesia	
~XX70 27	7E 30 30 37 30 20 32 37 0D		Romanian	
~XX71 1	7E 30 30 37 31 20 31 0D		Projection	Front-Desktop
~XX71 2	7E 30 30 37 31 20 32 0D			Rear-Desktop
~XX71 3	7E 30 30 37 31 20 33 0D			Front-Ceiling
~XX71 4	7E 30 30 37 31 20 34 0D			Rear-Ceiling
~XX72 1	7E 30 30 37 32 20 31 0D		Menu Location	Top Left
~XX72 2	7E 30 30 37 32 20 32 0D			Top Right
~XX72 3	7E 30 30 37 32 20 33 0D			Centre
~XX72 4	7E 30 30 37 32 20 34 0D	Bottom Left		
~XX72 5	7E 30 30 37 32 20 35 0D	Bottom Right		
(EW556 only)				
~XX90 1	7E 30 30 39 31 20 31 0D	Screen Type	16:10	
~XX90 0	7E 30 30 39 31 20 30 0D		16:9	
~XX73 n	7E 30 30 37 33 20 a 0D	Signal	Frequency	
~XX91 n	7E 30 30 39 31 20 a 0D		Automatic	
~XX74 n	7E 30 30 37 34 20 a 0D		Phase	
~XX75 n	7E 30 30 37 35 20 a 0D		H. Position	
~XX76 n	7E 30 30 37 36 20 a 0D		V. Position	
~XX77 n	7E 30 30 37 37 20 aabbcc 0D		Security Timer	n = -5 (a=2D 35) ~ 5 (a=35) By signal n = 0 disable; n = 1 enable n = 0 (a=30) ~ 31 (a=33 31) By signal n = -5 (a=2D 35) ~ 5 (a=35) By timing n = -5 (a=2D 35) ~ 5 (a=35) By timing Month/Day/Hour n = mm/dd/hh mm= 00 (aa=30 30) ~ 12 (aa=31 32) dd = 00 (bb=30 30) ~ 30 (bb=33 30) hh= 00 (cc=30 30) ~ 24 (cc=32 34)
~XX78 1	7E 30 30 37 38 20 31 0D		Security Settings	Enable
~XX78 0 ~nnnn	7E 30 30 37 38 20 32 20 a 0D	Disable(0/2 for backward compatible)		
		~nnnn = ~0000 (a=7E 30 30 30 30) ~9999 (a=7E 39 39 39 39)		
~XX79 n	7E 30 30 37 39 20 a 0D	Projector ID	n = 00 (a=30 30) ~ 99 (a=39 39)	

Appendices

(for ES556/EX555/EX556/EW556)

~XX80 1	7E 30 30 38 30 20 31 0D	Mute	On
~XX80 0	7E 30 30 38 30 20 30 0D		Off (0/2 for backward compatible)
~XX81 n	7E 30 30 38 31 20 a 0D	Volume	n = 0 (a=30) ~ 10 (a=31 30)
~XX82 1	7E 30 30 38 32 20 31 0D	Logo	Default
~XX82 3	7E 30 30 38 32 20 33 0D		Neutral
~XX88 0	7E 30 30 38 38 20 30 0D	Closed Captioning	Off
~XX88 1	7E 30 30 38 38 20 31 0D		cc1
~XX88 2	7E 30 30 38 38 20 32 0D		cc2
~XX100 1	7E 30 30 31 30 30 20 31 0D	Source Lock	On
~XX100 0	7E 30 30 31 30 30 20 30 0D		Off (0/2 for backward compatible)
~XX100 3	7E 30 30 31 30 30 20 33 0D	Next Source	On
~XX101 1	7E 30 30 31 30 31 20 31 0D	High Altitude	On
~XX101 0	7E 30 30 31 30 31 20 30 0D		Off (0/2 for backward compatible)
~XX102 1	7E 30 30 31 30 32 20 31 0D	Information Hide	On
~XX102 0	7E 30 30 31 30 32 20 30 0D		Off (0/2 for backward compatible)
~XX103 1	7E 30 30 31 30 33 20 31 0D	Keypad Lock	On
~XX103 0	7E 30 30 31 30 33 20 30 0D		Off (0/2 for backward compatible)
~XX104 1	7E 30 30 31 30 34 20 31 0D	Background Color	Blue
~XX104 2	7E 30 30 31 30 34 20 32 0D		Black
~XX104 3	7E 30 30 31 30 34 20 33 0D		Red
~XX104 4	7E 30 30 31 30 34 20 34 0D		Green
~XX104 5	7E 30 30 31 30 34 20 35 0D		White
~XX105 1	7E 30 30 31 30 35 20 31 0D	Advanced	Direct Power On On
~XX105 0	7E 30 30 31 30 35 20 30 0D		Off (0/2 for backward compatible)
~XX106 n	7E 30 30 31 30 36 20 a 0D		Auto Power Off (min) n = 0 (a=30) ~ 180 (a=31 38 30)
~XX107 n	7E 30 30 31 30 37 20 a 0D		Sleep Timer (min) n = 0 (a=30) ~ 995 (a=39 39 39)
~XX115 1	7E 30 30 31 31 35 20 31 0D		Quick Resume On
~XX115 0	7E 30 30 31 31 35 20 30 0D		Off (0/2 for backward compatible)
~XX114 1	7E 30 30 31 31 34 20 31 0D		Power Mode(Standby) Eco (<=0.5W)
~XX114 0	7E 30 30 31 31 34 20 30 0D		Active (0/2 for backward compatible)
~XX109 1	7E 30 30 31 30 39 20 31 0D		Lamp Reminder On
~XX109 0	7E 30 30 31 30 39 20 30 0D		Off (0/2 for backward compatible)
~XX110 1	7E 30 30 31 31 30 20 31 0D		Brightness Mode Bright
~XX110 2	7E 30 30 31 31 30 20 32 0D		Eco
~XX110 3	7E 30 30 31 31 30 20 33 0D		Eco+
~XX111 1	7E 30 30 31 31 31 20 31 0D		Lamp Reset Yes
~XX111 0	7E 30 30 31 31 31 20 30 0D		No (0/2 for backward compatible)
~XX195 0	7E 30 30 31 39 35 20 30 0D	Test pattern	None
~XX195 1	7E 30 30 31 39 35 20 31 0D		Grid
~XX195 2	7E 30 30 31 39 35 20 32 0D		White Pattern
~XX112 1	7E 30 30 31 31 32 20 31 0D	Reset	Yes
~XX99 1	7E 30 30 39 39 20 31 0D	RS232 Alert Reset	Reset System Alert
~XX210 n	7E 30 30 32 30 20 n 0D	Display message on the OSD	n: 1-30 characters

SEND to emulate Remote

~XX140 10	7E 30 30 31 34 30 20 31 30 0D	Up
~XX140 11	7E 30 30 31 34 30 20 31 31 0D	Left
~XX140 12	7E 30 30 31 34 30 20 31 32 0D	Enter (for projection MENU)
~XX140 13	7E 30 30 31 34 30 20 31 33 0D	Right
~XX140 14	7E 30 30 31 34 30 20 31 34 0D	Down
~XX140 15	7E 30 30 31 34 30 20 31 35 0D	Keystone +
~XX140 16	7E 30 30 31 34 30 20 31 36 0D	Keystone -
~XX140 17	7E 30 30 31 34 30 20 31 37 0D	Volume -
~XX140 18	7E 30 30 31 34 30 20 31 38 0D	Volume +
~XX140 19	7E 30 30 31 34 30 20 31 39 0D	Brightness
~XX140 20	7E 30 30 31 34 30 20 32 30 0D	Menu
~XX140 21	7E 30 30 31 34 30 20 32 31 0D	Zoom

SEND from projector automatically

232 ASCII Code	HEX Code	Function	Projector Return	Description
		System status	INFOn	n : 0/1/2/3/4/6/7/8 = Standby/Warming/Cooling/Out of Range/ Lamp fail/Fan Lock/Over Temperature/ Lamp Hours Running Out/Cover Open

Appendices

READ from projector (telnet supported)

32 ASCII Code	HEX Code	Function	Projector Return	Description
~XX121 1	7E 30 30 31 32 31 20 31 0D	Input Source	OKn	n : 0/1/2/3/4/5 = None/VGA1/VGA2/S-Video/Video/HDMI
~XX122 1	7E 30 30 31 32 32 20 31 0D	Software Version	OKdddd	dddd: FW version
~XX123 1	7E 30 30 31 32 33 20 31 0D	Display Mode	OKn	n : 0/1/2/3/4/5/7/8 = None/Presentation/Bright/Movie/sRGB/User/ Blackboard/Classroom/3D
~XX124 1	7E 30 30 31 32 34 20 31 0D	Power State	OKn	n : 0/1 = Off/On
~XX125 1	7E 30 30 31 32 35 20 31 0D	Brightness	OKn	
~XX126 1	7E 30 30 31 32 36 20 31 0D	Contrast	OKn	
~XX127 1	7E 30 30 31 32 37 20 31 0D	Aspect Ratio	OKn	(EW556) n: 0/1/2/3/4 = 4:3/16:9 or 16:10 */LBX/Native/AUTO (ES555/ES556/EX555/EX556) n: 0/1/2/3/4 = 4:3/16:9-1/16:9-1/ Native/AUTO * 16:9 or 16:10 depend on Screen Type setting
~XX128 1	7E 30 30 31 32 38 20 31 0D	Color Temperature	OKn	n : 0/1/2 = Warm/Medium/Cold
~XX129 1	7E 30 30 31 32 39 20 31 0D	Projection Mode	OKn	n : 0/1/2/3 = Front-Desktop/Rear-Desktop/Front-Ceiling/ Rear-Ceiling
~XX150 1	7E 30 30 31 35 20 31 0D	Information	OKabbbccddde	a : 0/1 = Off/On bbbb: LampHour cc: source 00/01/02/03/04/05= None/VGA1/VGA2/S-Video/ Video/HDMI dddd: FW version e : Display mode 0/1/2/3/4/5/6/7/8 None/Presentation/Bright/Movie/sRGB/User/ Blackboard/Classroom/3D
~XX151 1	7E 30 30 31 35 31 20 31 0D	Model name	OKn	n:1/2/3/4/5 =ES555/ES556/EX555/EX556/EW556
~XX108 1	7E 30 30 31 30 38 20 31 0D	Lamp Hours	OKbbbb	bbbb: LampHour
~XX108 2	7E 30 30 31 30 38 20 31 0D	Cumulative Lamp Hours	OKbbbbbb	bbbbbb: (5 digits) Total Lamp Hours

Wall Mount Installation

1. To prevent damage to your projector, please use the Optoma ceiling mount.
2. If you wish to use a third party ceiling mount kit, please ensure the screws used to attach a mount to the projector meet the following specifications:

- ▶ Screw type: M4*3
- ▶ Maximum screw length: 11mm
- ▶ Minimum screw length: 8mm



❖ Please note that damage resulting from incorrect installation will void the warranty.



⚠ Warning:

1. If you buy a ceiling mount from another company, please be sure to use the correct screw size. Screw size will vary depending on the thickness of the mounting plate.
2. Be sure to keep at least 10 cm gap between the ceiling and the bottom of the projector.
3. Avoid installing the projector near a heat source.

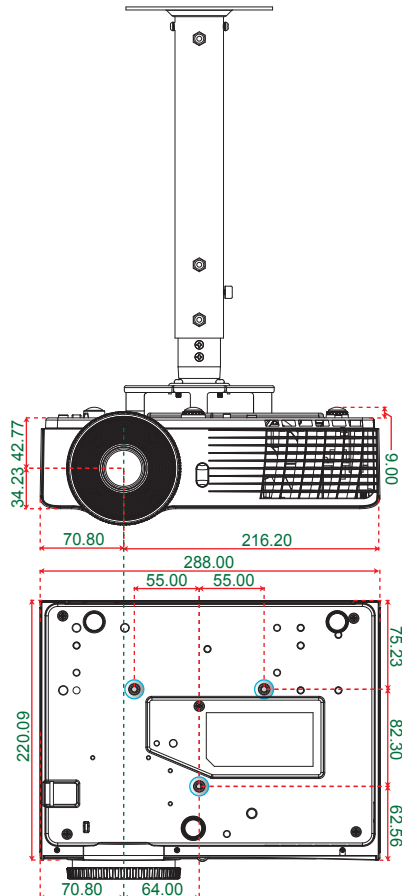

Unit: mm



Lens

Optoma Global Offices

For service or support please contact your local office.



USA

3178 Laurelview Ct.
Fremont, CA 94538, USA
www.optomausa.com

 888-289-6786
 510-897-8601
 services@optoma.com

Canada

2420 Meadowpine Blvd., Suite #105
Mississauga, ON, L5N 6S2, Canada
www.optoma.ca

 888-289-6786
 510-897-8601
 services@optoma.com



Europe

42 Caxton Way, The Watford Business Park
Watford, Hertfordshire,
WD18 8QZ, UK
www.optoma.eu
Service Tel : +44 (0)1923 691865

 +44 (0) 1923 691 800
 +44 (0) 1923 691 888
 service@tsc-europe.com



France

Bâtiment E
81-83 avenue Edouard Vaillant
92100 Boulogne Billancourt, France

 +33 1 41 46 12 20
 +33 1 41 46 94 35
 savoptoma@optoma.fr



Spain

C/ José Hierro, 36 Of. 1C
28522 Rivas VaciaMadrid,
Spain

 +34 91 499 06 06
 +34 91 670 08 32



Deutschland

Wiesenstrasse 21 W
D40549 Düsseldorf,
Germany

 +49 (0) 211 506 6670
 +49 (0) 211 506 66799
 info@optoma.de

Scandinavia



Lerpeveien 25
3040 Drammen
Norway

 +47 32 98 89 90
 +47 32 98 89 99
 info@optoma.no

PO.BOX 9515
3038 Drammen
Norway



Benelux BV

Randstad 22-123
1316 BW Almere
The Netherlands

 +31 (0) 36 820 0253
 +31 (0) 36 548 9052
www.optoma.nl



Latin America

3178 Laurelview Ct.
Fremont, CA 94538, USA
www.optomausa.com

 888-289-6786
 510-897-8601
 services@optoma.com

Korea

WOOMI TECH.CO.,LTD.
4F,Minu Bldg.33-14, Kangnam-Ku,
seoul,135-815, KOREA

 +82+2+34430004
 +82+2+34430005



Japan

東京都足立区綾瀬3-25-18
株式会社オーエス
コンタクトセンター:0120-380-495

 info@os-worldwide.com
www.os-worldwide.com



Taiwan

5F., No. 108, Minchiuan Rd.
Shindian City,
Taipei Taiwan 231, R.O.C.
www.optoma.com.tw

 +886-2-2218-2360
 +886-2-2218-2313
 services@optoma.com.tw
asia.optoma.com



Hong Kong

Unit A, 27/F Dragon Centre,
79 Wing Hong Street,
Cheung Sha Wan,
Kowloon, Hong Kong

 +852-2396-8968
 +852-2370-1222
www.optoma.com.hk

China

5F, No. 1205, Kaixuan Rd.,
Changning District
Shanghai, 200052, China

 +86-21-62947376
 +86-21-62947375
www.optoma.com.cn

Regulation & Safety Notices

This appendix lists the general notices of your projector.

FCC notice

This device has been tested and found to comply with the limits for a Class B digital device pursuant to Part 15 of the FCC rules. These limits are designed to provide reasonable protection against harmful interference in a residential installation. This device generates, uses and can radiate radio frequency energy and, if not installed and used in accordance with the instructions, may cause harmful interference to radio communications.

However, there is no guarantee that interference will not occur in a particular installation. If this device does cause harmful interference to radio or television reception, which can be determined by turning the device off and on, the user is encouraged to try to correct the interference by one or more of the following measures:

- Reorient or relocate the receiving antenna.
- Increase the separation between the device and receiver.
- Connect the device into an outlet on a circuit different from that to which the receiver is connected.
- Consult the dealer or an experienced radio/television technician for help.

Notice: Shielded cables

All connections to other computing devices must be made using shielded cables to maintain compliance with FCC regulations.

Caution

Changes or modifications not expressly approved by the manufacturer could void the user's authority, which is granted by the Federal Communications Commission, to operate this projector.

Operation conditions

This device complies with Part 15 of the FCC Rules. Operation is subject to the following two conditions:

1. This device may not cause harmful interference and
2. This device must accept any interference received, including interference that may cause undesired operation.

Notice: Canadian users

This Class B digital apparatus complies with Canadian ICES-003.

Remarque à l'intention des utilisateurs canadiens

Cet appareil numérique de la classe B est conforme à la norme NMB-003 du Canada.

Declaration of Conformity for EU countries

- EMC Directive 2004/108/EC (including amendments)
- Low Voltage Directive 2006/95/EC
- R & TTE Directive 1999/5/EC (if product has RF function)

Disposal instructions



Do not throw this electronic device into the trash when discarding. To minimize pollution and ensure utmost protection of the global environment, please recycle it.