

Panasonic®

Operating Instructions

LCD Projector **Commercial Use**

Model No. **PT-FW300NTE**
PT-FW300E

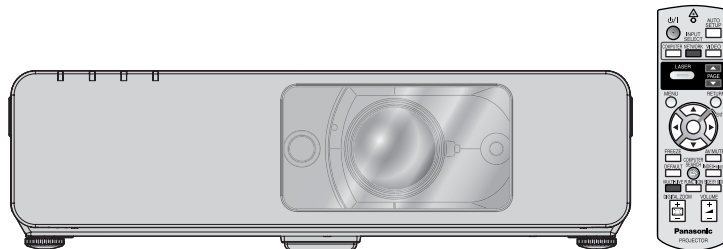

(PT-FW300NTE)

ProSelecta

View :: Compare :: Select - www.ProSelecta.com

TQBJ0284-1

ENGLISH

Important Safety Notice

Dear Panasonic Customer:

This instruction booklet provides all the necessary operating information that you might require. We hope it will help you to get the most out of your new product, and that you will be pleased with your Panasonic LCD projector. The serial number of your product may be found on its bottom. You should note it in the space provided below and retain this booklet in case service is required.

Model number: PT-FW300NTE/PT-FW300E

Serial number:

WARNING: THIS APPARATUS MUST BE EARTHED.

WARNING: To prevent damage which may result in fire or shock hazard, do not expose this appliance to rain or moisture.

Machine Noise Information Ordinance 3. GSGV, January 18, 1991: The sound pressure level at the operator position is equal or less than 70 dB (A) according to ISO 7779.

WARNING:

1. Remove the plug from the mains socket when this unit is not in use for a prolonged period of time.
2. To prevent electric shock, do not remove cover. No user serviceable parts inside. Refer servicing to qualified service personnel.
3. Do not remove the earthing pin on the mains plug. This apparatus is equipped with a three prong earthing-type mains plug. This plug will only fit an earthing-type mains socket. This is a safety feature. If you are unable to insert the plug into the mains socket, contact an electrician. Do not defeat the purpose of the earthing plug.

CAUTION: To assure continued compliance, follow the attached installation instructions, which includes using the provided power cord and shielded interface cables when connecting to computer or peripheral device. If you use serial port to connect PC for external control of projector, you must use optional RS-232C serial interface cable with ferrite core. Any unauthorized changes or modifications to this equipment will void the user's authority to operate.

Pursuant to at the directive 2004/108/EC, article 9(2)
Panasonic Testing Centre
Panasonic Service Europe, a division of Panasonic Marketing Europe GmbH
Winsberggring 15, 22525 Hamburg, F.R. Germany



Information for Users on Collection and Disposal of Old Equipment and used Batteries

These symbols on the products, packaging, and/or accompanying documents mean that used electrical and electronic products and batteries should not be mixed with general household waste.

For proper treatment, recovery and recycling of old products and used batteries, please take them to applicable collection points, in accordance with your national legislation and the Directives 2002/96/EC and 2006/66/EC.

By disposing of these products and batteries correctly, you will help to save valuable resources and prevent any potential negative effects on human health and the environment which could otherwise arise from inappropriate waste handling.



For more information about collection and recycling of old products and batteries, please contact your local municipality, your waste disposal service or the point of sale where you purchased the items.

Penalties may be applicable for incorrect disposal of this waste, in accordance with national legislation.

For business users in the European Union

If you wish to discard electrical and electronic equipment, please contact your dealer or supplier for further information.



Information on Disposal in other Countries outside the European Union

These symbols are only valid in the European Union. If you wish to discard these items, please contact your local authorities or dealer and ask for the correct method of disposal.

Note for the battery symbol (bottom two symbol examples):

This symbol might be used in combination with a chemical symbol. In this case it complies with the requirement set by the Directive for the chemical involved.

Important Safety Notice

Declaration of Conformity



Declaration of Conformity (DoC)

This equipment is in compliance with the essential requirements and other relevant provisions of Directive 1999/5/EC.

Customers can download a copy of the original DoC for this product from our DoC server: <http://www.doc.panasonic.de>

Contact in the EU: Panasonic Services Europe, a Division of Panasonic Marketing Europe GmbH, Panasonic Testing Centre, Winsbergring 15, 22525 Hamburg, F.R.Germany

This product is intended to be used in the following countries.

Austria, Belgium, Bulgaria, Czech, Cyprus, Denmark, Estonia, Finland, France, Germany, Greece, Hungary, Iceland, Ireland, Italy, Latvia, Lithuania, Luxembourg, Malta, Netherlands, Norway, Poland, Portugal, Romania, Slovenia, Slovak, Spain, Sweden, Switzerland & UK



Konformitätserklärung (KE)

Dieses Gerät entspricht den grundlegenden Anforderungen und den weiteren entsprechenden Vorgaben der Richtlinie 1999/5/EU.

Kunden können eine Kopie der Original-KE für dieses Produkt von unserem KE-Server herunterladen: <http://www.doc.panasonic.de>

Kontaktadresse in der EG: Panasonic Services Europe, a Division of Panasonic Marketing Europe GmbH, Panasonic Testing Centre, Winsbergring 15, 22525 Hamburg, F.R.Germany

Dieses Produkt ist für den Einsatz in den folgenden Ländern vorgesehen.

Österreich, Belgien, Bulgarien, Tschechische Republik, Zypern, Dänemark, Estland, Finnland, Frankreich, Deutschland, Griechenland, Ungarn, Island, Irland, Italien, Lettland, Litauen, Luxemburg, Malta, Niederlande, Norwegen, Polen, Portugal, Rumänien, Slowenien, Slowakei, Spanien, Schweden, Schweiz und Großbritannien



Déclaration de Conformité (DC)

Cet appareil est conforme aux exigences essentielles et aux autres dispositions pertinentes de la Directive 1999/5/EC.

Les clients peuvent télécharger une copie de la DC originale pour ce produit à partir de notre serveur DC: <http://www.doc.panasonic.de>

Coordonnées dans l'UE : Panasonic Services Europe, a Division of Panasonic Marketing Europe GmbH, Panasonic Testing Centre, Winsbergring 15, 22525 Hamburg, F.R.Germany

Ce produit est conçu pour l'utilisation dans les pays suivants.

Autriche, Belgique, Bulgarie, République Tchèque, Chypre, Danemark, Estonie, Finlande, France, Allemagne, Grèce, Hongrie, Islande, Irlande, Italie, Lettonie, Lituanie, Luxembourg, Malte, Pays-Bas, Norvège, Pologne, Portugal, Roumanie, Slovaquie, Espagne, Suède, Suisse et Royaume-Uni



Declaración de conformidad (DC)

Este equipo cumple con los requisitos esenciales así como con otras disposiciones de la Directiva 1999/5/CE.

El cliente puede descargar una copia de la DC original de este producto desde nuestro servidor DC: <http://www.doc.panasonic.de>

Contacto en la U.E.: Panasonic Services Europe, a Division of Panasonic Marketing Europe GmbH, Panasonic Testing Centre, Winsbergring 15, 22525 Hamburg, F.R.Germany

Este producto ha sido desarrollado para el uso en los siguientes países.

Austria, Bélgica, Bulgaria, República Checa, Chipre, Dinamarca, Estonia, Finlandia, Francia, Alemania, Grecia, Hungría, Islandia, Irlanda, Italia, Letonia, Lituania, Luxemburgo, Malta, Holanda, Noruega, Polonia, Portugal, Rumania, Eslovenia, Eslovaquia, España, Suecia, Suiza y el Reino Unido



Dichiarazione di conformità (DoC)

Questo apparato è conforme ai requisiti essenziali ed agli altri principi sanciti dalla Direttiva 1999/5/CE.

I clienti possono scaricare la copia del DoC originale per questo prodotto dal nostro server DoC: <http://www.doc.panasonic.de>

Contatto nella EU: Panasonic Services Europe, a Division of Panasonic Marketing Europe GmbH, Panasonic Testing Centre, Winsbergring 15, 22525 Hamburg, F.R.Germany

I prodotti sono stati prodotti per l'uso nei seguenti paesi.

Austria, Belgio, Bulgaria, Repubblica Ceca, Cipro, Danimarca, Estonia, Finlandia, Francia, Germania, Grecia, Irlanda, Islanda, Italia, Lettonia, Lituania, Lussemburgo, Malta, Olanda, Norvegia, Polonia, Portogallo, Romania, Regno Unito, Slovenia, Slovacchia, Spagna, Svezia, Svizzera, Ungheria

България

Това устройство отговаря на съществените изисквания и останалите приложими разпоредби на Директива 1999/5/ЕО.

Česky

Toto zařízení je v souladu se základními požadavky a ostatními odpovídajícími ustanoveními Směrnice 1999/5/EC.

Dansk

Dette udstyr er i overensstemmelse med de væsentlige krav og andre relevante bestemmelser i Direktiv 1999/5/EF.

Eesti

See seade vastab direktiivi 1999/5/EÜ olulistele nõuetele ja teistele asjakohastele sätetele.

Ελληνική

Αυτός ο εξοπλισμός είναι σε συμμόρφωση με τις ουσιώδεις απαιτήσεις και άλλες σχετικές διατάξεις της Οδηγίας 1999/5/ΕΚ.

Íslenska

Þetta tæki er samkvæmt grunnkröfum og öðrum viðeigandi ákvæðum Tilskipunar 1999/5/EC.

Latviski

Šī iekārta atbilst Direktīvas 1999/5/EK būtiskajām prasībām un citiem ar to saistītajiem noteikumiem.

Lietuvių

Šis įrenginys tenkina 1999/5/EB Direktyvos esminius reikalavimus ir kitas šios direktyvos nuostatas.

Nederlands

Dit apparaat voldoet aan de essentiële eisen en andere van toepassing zijnde bepalingen van de Richtlijn 1999/5/EC.

Malti

Dan I-apparat huwa konformi mal-ħtiġiet essenzjali u I-provedimenti I-oħra rilevanti tad-Direttiva 1999/5/EC.

Magyar

Ez a készülék teljesíti az alapvető követelményeket és más 1999/5/EK irányelvben meghatározott vonatkozó rendelkezéseket.

Norsk

Dette utstyret er i samsvar med de grunnleggende krav og andre relevante bestemmelser i EU-direktiv 1999/5/EF.

Polski

Urządzenie jest zgodne z ogólnymi wymaganiami oraz szczególnymi warunkami określonymi Dyrektywą UE: 1999/5/EC.

Português

Este equipamento está em conformidade com os requisitos essenciais e outras provisões relevantes da Directiva 1999/5/EC.

România

Acest echipament este conform cu cerințele de bază și celelalte prevederi relevante ale Directivei 1999/5/CE.

Slovensko

Ta naprava je skladna z bistvenimi zahtevami in ostalimi relevantnimi pogoji Direktive 1999/5/EC.

Slovensky

Toto zariadenie je v zhode so základnými požiadavkami a inými príslušnými nariadeniami direktív: 1999/5/EC.

Suomi

Tämä laite täyttää direktiivin 1999/5/EY olennaiset vaatimukset ja on siinä asetettujen muiden laitetta koskevien määräysten mukainen.

Svenska

Denna utrustning är i överensstämmelse med de väsentliga kraven och andra relevanta bestämmelser i Direktiv 1999/5/EC.

Contents

Quick steps

1. Set up your projector
See “Setting up” on page 17.



2. Connect with other devices
See “Connections” on page 21.



3. Prepare the Remote control
See “Remote control” on page 16.



4. Start projecting
See “Switching the projector on/off” on page 23.



5. Adjust the image
See “Menu Navigation” on page 32.

- When you start the projection for the first time, the minimum required setting screen for projection will be displayed. See “Minimum required setting screen” on page 13.

Important Information

Important Safety Notice	2
Declaration of Conformity	4
Precautions with regard to safety	8
WARNINGS	8
CAUTIONS	9
Cautions when transporting	10
Cautions when installing	10
Cautions on use	11
Security	11
Accessories	12

Preparation

Read this first	13
Minimum required setting screen	13
About Your Projector	14
Projector body	14
Remote control	16

Getting Started

Setting up	17
Screen size and throw distance	17
Projection method	18
Front leg adjusters and throwing angle	18
Lens shift and positioning	19
Connections	21
Before connection to the projector	21
Connecting example: Computers	21
Connecting example: AV equipment	22

Basic Operation

Switching the projector on/off	23
Mains lead	23
Power indicator	24
Switching on the projector	25
Switching off the projector	25
Projecting an image	26
Selecting the input signal	26
Positioning the image	26
Remote control operation	27
Operating range	27
Setting up the image position automatically	27
Switching the input signal	28
Enlarging the centred area	28
Capturing an image	29
Stopping the projection	29
Resetting to the factory default settings	29
Projecting an image in INDEX-WINDOW mode	29
Using an assigned function	30
Projecting 2 different source image at a time	30
Using the laser pointer	31
Controlling the volume of the speaker	31

Settings	
Menu Navigation	32
Main menu and Sub-menu	32
Navigating through the menu	34
PICTURE menu	35
PICTURE MODE	35
CONTRAST	35
BRIGHTNESS	35
COLOR	35
TINT	35
SHARPNESS	35
WHITE BALANCE RED	35
WHITE BALANCE GREEN	35
WHITE BALANCE BLUE	35
COLOR TEMPERATURE	36
DAYLIGHT VIEW	36
DIGITAL CINEMA REALITY	36
NOISE REDUCTION	36
TV-SYSTEM	36
RGB/YPbPr	36
POSITION menu	37
KEystone	37
SHIFT	37
SHIFT V	37
DOT CLOCK	37
CLOCK PHASE	37
OVER SCAN	37
ASPECT	38
FRAME LOCK	39
DISPLAY OPTION menu	40
ON-SCREEN DISPLAY	40
DVI-D IN	40
SCREEN SETTING	40
STARTUP LOGO	41
AUTO SETUP	41
SIGNAL SEARCH	41
BACK COLOR	41
WIDE MODE	41
SXGA MODE	41
OTHER FUNCTIONS	42
PROJECTOR SETUP menu	43
STATUS	43
COMPUTER2 SELECT	43
NO SIGNAL SHUT-OFF	43
INITIAL START UP	43
INSTALLATION	44
HIGH ALTITUDE MODE	44
EMULATE	44
FUNCTION BUTTON	44
AUDIO SETTING	44
TEST PATTERN	45
INITIALIZE ALL	45
FILTER COUNTER RESET	45
SECURITY menu	46
PASSWORD	46
PASSWORD CHANGE	46
TEXT DISPLAY	46
TEXT CHANGE	46
MENU LOCK	47
MENU LOCK PASSWORD	47
CONTROL DEVICE SETUP	47
NETWORK menu	48
Items in NETWORK menu	48

Maintenance	
TEMP, LAMP and FILTER Indicators	49
Managing the indicated problems	49
Care and Replacement	50
Cleaning the projector	50
Replacing the Lamp unit	50
Replacing the Auto Cleaning Filter (ACF)	51
Troubleshooting	53
Appendix	
Technical Information	54
List of compatible signals	54
Serial terminal	55
Computer connection guidance	56
REMOTE terminal	57
DVI-D IN terminal	58
Ceiling mount bracket safeguards	58
Screen size and throw distance for 16:9 aspect ratio	59
Screen size and throw distance for 4:3 aspect ratio	59
Specifications	60
Dimensions	62
Trademark acknowledgements	62
Index	63

Precautions with regard to safety

WARNINGS

If you notice smoke, strange smells or noise coming from the projector, disconnect the mains plug from the mains socket.

- Do not continue to use the projector in such cases, otherwise fire or electric shocks could result.
- Check that no more smoke is coming out, and then contact an Authorised Service Centre for repairs.
- Do not attempt to repair the projector yourself, as this can be dangerous.

Do not install this projector in a place which is not strong enough to take the full weight of the projector.

- If the installation location is not strong enough, it may fall down or tip over, and severe injury or damage could result.

Installation work (such as ceiling suspension) should only be carried out by a qualified technician.

- If installation is not carried out correctly, there is the danger that injury or electric shocks may occur.
- Do not use other than an authorised ceiling mount bracket.

If foreign objects or water get inside the projector, or if the projector is dropped or the cabinet is broken, disconnect the mains plug from the mains socket.

- Continued use of the projector in this condition may result in fire or electric shocks.
- Contact an Authorised Service Centre for repairs.

The mains socket shall be installed near the equipment and shall be easily accessible.

- Unplug the mains plug from the mains socket immediately when problem occurred.

Do not overload the mains socket.

- If the power supply is overloaded (for example, by using too many adapters), overheating may occur and fire may result.

Never attempt to modify or disassemble the projector.

- High voltages can cause fire or electric shocks.
- For any inspection, adjustment and repair work, please contact an Authorised Service Centre.

Clean the mains plug regularly to prevent it from becoming covered in dust.

- If dust builds up on the mains plug, the resulting humidity can damage the insulation, which could result in fire. Pull the mains plug out from the mains socket and wipe it with a dry cloth.
- If not using the projector for an extended period of time, pull the mains plug out from the mains socket.

Do not handle the mains plug with wet hands.

- Failure to observe this may result in electric shocks.

Insert the mains plug securely into the mains socket.

- Do not use other than the provided mains lead.
- If the plug is not inserted correctly, electric shocks or overheating could result.
- Do not use plugs which are damaged or mains sockets which are coming loose from the wall.

Do not place the projector on top of surfaces which are unstable.

- If the projector is placed on top of a surface which is sloped or unstable, it may fall down or tip over, and injury or damage could result.

Do not place the projector into water or let it become wet.

- Failure to observe this may result in fire or electric shocks.

Do not do anything that might damage the mains lead or the mains plug.

- Do not damage the mains lead, make any modifications to it, place it near any hot objects, bend it excessively, twist it, pull it, place heavy objects on top of it or wrap it into a bundle.
- If the mains lead is used while damaged, electric shocks, short-circuits or fire may result.
- Ask an Authorised Service Centre to carry out any repairs to the mains lead that might be necessary.

Do not place the projector on soft materials such as carpets or sponge mats.

- Doing so may cause the projector to overheat, which can cause burns, fire or damage to the projector.

Do not place liquid containers on top of the projector.

- If water spills onto the projector or gets inside it, fire or electric shocks could result.
- If any water gets inside the projector, contact an Authorised Service Centre.

Do not insert any foreign objects into the projector.

- Do not insert any metal objects or flammable objects into the projector or drop them onto the projector, as doing so can result in fire or electric shocks.

Do not allow the + and - terminals of the batteries to come into contact with metallic objects such as necklaces or hairpins.

- Failure to observe this may cause the batteries to leak, overheat, explode or catch fire.
- Store the batteries in a plastic bag and keep them away from metallic objects.

Precautions with regard to safety

Do not touch the leaked liquid from the batteries.

- If you touch the leaked liquid, it may hurt your skin. Immediately wash away the liquid with water and seek medical advice.
- If you get the leaked liquid in your eye, it may cause blindness or damage. Never rub your eye, and immediately wash away the liquid with water and seek medical advice.

During a thunderstorm, do not touch the projector or the cable.

- Electric shocks can result.

Do not use the projector in a bath or shower.

- Fire or electric shocks can result.

Do not place your skin into the light beam while the projector is being used.

- Strong light is emitted from the projector's lens. If you place directly into this light, it can hurt or damage your skin.

Do not look into the lens while the projector is being used.

- Strong light is emitted from the projector's lens. If you look directly into this light, it can hurt and damage your eyes.
- Be especially careful not to let young children look into the lens. In addition, turn off the power and disconnect the mains plug when you are away from the projector.

Do not place your hands or other objects close to the air outlet port.

- Heated air comes out of the air outlet port. Do not place your hands or face, or objects which cannot withstand heat close to this port [allow at least 50 cm (20") of space], otherwise burns or damage could result.

Replacement of the lamp is recommended to be carried out by a qualified technician.

- The lamp has high internal pressure. If improperly handled, explosion might result.
- The lamp can easily become damaged if struck against hard objects or dropped, and injury or malfunctions may result.

When replacing the lamp, allow it to cool for at least one hour before handling it.

- The lamp cover gets very hot, and touching it can cause burns.

Before replacing the lamp, be sure to disconnect the mains plug from the mains socket.

- Electric shocks or explosions can result if this is not done.

Do not allow infants or pets to touch the remote control unit.

- Keep the remote control unit out of the reach of infants and pets after using it.

CAUTIONS

Do not cover the air inlet port or the air outlet port.

- Doing so may cause the projector to overheat, which can cause fire or damage to the projector.
- Do not place the projector in narrow, badly ventilated places such as closets or bookshelves.
- Do not place the projector on cloth or papers, as these materials could be drawn into the air inlet port.

Do not set up the projector in humid or dusty places or in places where the projector may come into contact with oily smoke or steam.

- Using the projector under such conditions may result in fire, electric shocks or plastic deterioration. The plastic deterioration may cause the falling down of the projector which is mounted on the ceiling.

Do not set up the projector in a high temperature environment, such as near a heater or in direct sunlight.

- Failure to observe this may result in fire, malfunction or plastic deterioration.

Do not set up the projector outdoors.

- The projector is designed for indoor use only.

When disconnecting the mains lead, hold the plug, not the lead.

- If the mains lead itself is pulled, the lead will become damaged, and fire, short-circuits or serious electric shocks may result.

Always disconnect all cables before moving the projector.

- Moving the projector with cables still attached can damage the cables, which could cause fire or electric shocks to occur.

Do not place any heavy objects on top of the projector.

- Failure to observe this may cause the projector to become unbalanced and fall, which could result in damage or injury.

Do not short-circuit, heat or disassemble the batteries or place them into water or fire.

- Failure to observe this may cause the batteries to overheat, leak, explode or catch fire, and burns or other injury may result.

Precautions with regard to safety

When inserting the batteries, make sure the polarities (+ and -) are correct.

- If the batteries are inserted incorrectly, they may explode or leak, and fire, injury or contamination of the battery compartment and surrounding area may result.

Use only the specified batteries.

- If incorrect or different kind of batteries are used, they may explode or leak, and fire, injury or contamination of the battery compartment and surrounding area may result.

Do not mix old and new batteries.

- If the batteries are used mixing old and new, they may explode or leak, and fire, injury or contamination of the battery compartment and surrounding area may result.

Remove the used batteries from the remote control promptly.

- If you leave used batteries in the remote control for an extended period of time, it may cause liquid leaking, abnormal internal temperature rising or explosion.

If not using the projector for an extended period of time, disconnect the mains plug from the mains socket and remove the batteries from the remote control.

- If dust builds up on the mains plug, the resulting humidity may damage the insulation, which could result in fire.
- Keeping or leaving the remote control with batteries inside may cause insulation deterioration, electrical leakage or explosion which could result in fire.

We are constantly making efforts to preserve and maintain a clean environment. Please take non repairable units back to your dealer or a recycling company.

Do not put your weight on this projector.

- You could fall or the projector could break, and injury may result.
- Be especially careful not to let young children stand or sit on the projector.

Disconnect the mains plug from the mains socket as a safety precaution before carrying out any cleaning.

- Electric shocks can result if this is not done.

If the lamp has broken, ventilate the room immediately. Do not touch or bring your face close to the broken pieces.

- Failure to observe this may cause the user to absorb the gas which was released when the lamp broke and which contains nearly the same amount of mercury as fluorescent lamps, and the broken pieces may cause injury.
- If you believe that you have absorbed the gas or that the gas has got into your eyes or mouth, seek medical advice immediately.
- Ask your dealer about the replacement of the lamp unit and check the inside of the projector.

Ask an Authorised Service Centre to clean inside the projector at least once a year.

- If dust is left to build up inside the projector without being cleaned out, it can result in fire or problems with operation.
- It is a good idea to clean the inside of the projector before the season for humid weather arrives. Ask your nearest Authorised Service Centre to clean the projector when required. Please discuss with the Authorised Service Centre regarding cleaning costs.

Do not use chemical treated wipes when cleaning.

- Using chemical treated wipes may result in plastic distortion or deterioration.

Cautions when transporting

Do not subject the projector to excessive vibration or shocks.

- The projector lens need to be handled with care.
- Cover the lens with the lens cover when transporting the projector.

When transporting the projector, hold the body at the bottom securely.

- Do not hold the adjuster legs or the top cover to move the projector, as this may damage the projector.

Cautions when installing

Avoid setting up in places which are subject to vibration or shocks.

- The internal parts can be damaged, which may cause malfunctions or accidents.

Avoid setting up in places which are subject to sudden temperature changes, such as near an air conditioner or lighting equipment.

- The life of the lamp may be shortened or the projector may be turned off. See "TEMP indicator" on page 49.

Precautions with regard to safety

Do not set up the projector near high-voltage power lines or near motors.

- The projector may be subject to electromagnetic interference.

If installing the projector to the ceiling, ask a qualified technician to carry out all installation work.

- You will need to purchase the separate installation kit (Model No. ET-PKF100H, ET-PKF100S). Furthermore, all installation work should only be carried out by a qualified technician.
- See "Ceiling mount bracket safeguards" on page 58 for the safety cable installation.

If using this projector at high elevations 1 400 - 2 700 m (4 593 - 8 858 ft) sea level, set the HIGH ALTITUDE MODE to ON. See "HIGH ALTITUDE MODE" on page 44.

- Failure to observe this may result in malfunctions or the life of the lamp or the other components may be shortened.

Cautions on use

In order to get the best picture quality

- Draw curtains or blinds over any windows and turn off any lights near the screen to prevent outside light or light from indoor lamps from shining onto the screen.

Do not touch the surfaces of the lens or the front glass with your bare hands.

- If the surface of the lens becomes dirty from fingerprints or anything else, this will be magnified and projected onto the screen. Moreover, when not using the projector, close the front panel cover.

Liquid crystal panel

- Do not project the same image for long periods of time, as this may remain as an afterimage on the liquid crystal panel. Display the white screen test pattern for more than an hour to remove it. See "TEST PATTERN" on page 45.
- The liquid crystal panel of the projector is built with very high precision technology to provide fine picture details. Occasionally, a few stuck pixels may appear on the screen as fixed points of blue, green or red. It is recommended to switch off the projector once and try after 1 hour later again. Please note that this does not affect the performance of your LCD.

The projector has a high pressure mercury lamp and that is characterised as follows.

- The brightness of the lamp depends on the duration of use.
- The lamp may explode or shorten the lamp life by shocks or chipping damage.
- The lamp may explode only occasionally after using the projector.
- The lamp may explode if using the projector after the instructed lamp replacement timing.
- When the lamp exploded, it emits internal smoke-like gas.
- The lamp life is depends on individual lamp characteristics, usage condition and the installation environment. Especially the consecutive use of the projector for more than 10 hours, or the frequent switching on or off may greatly affect on the lamp life.

Optical components

- If you use the projector consecutively 6 hours every day, the optical components may need to be replaced in less than 1 year.

Security

Take the safety measures for use of the projector that should cover the following envisioned incidents.

- The leakage of your personal registered information.
- Dishonest operation by an untrusted third party.
- Locking out or prevent anyone else from using the projector by an untrusted third party.

Security instruction

- The connecting network must be secured by firewall or others.
- Change your password regularly.
- Do not use password too simple to guess.
- The Authorised Service Centre will never ask you for the password.
- Do not share your password with anyone else.
- Password the projector and restrict access to authorized users only.

Precautions with regard to safety

Accessories

Make sure the following accessories are provided with your projector.

Remote control for PT-FW300NTE (x1)
N2QAYB000305

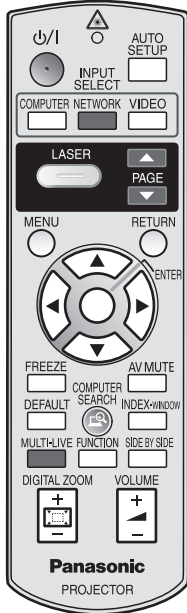

Remote control for PT-FW300E (x1)
N2QAYB000367

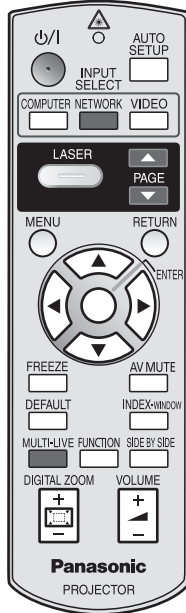

AA batteries for remote control (x2)

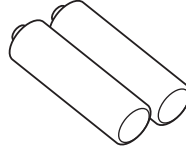

Mains lead (x1)
K2CM3DH00016

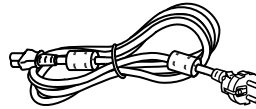

Power cord secure lock (x1)
TTRA0183

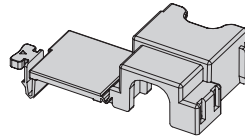

Safety cable TTRA0141
Attachment screw (x1)
Safety cable (x1)

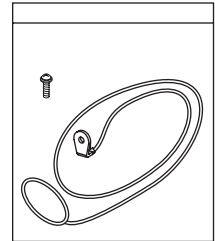

CD-ROM (x1)
TQBH9012

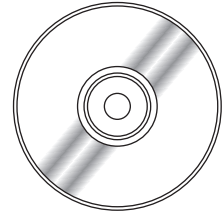

* The protectors for enclosed products, such as a plug cover or foam cartons, must be treated properly.

* Contact to an Authorised Service Centre for lost accessories.

Read this first

Minimum required setting screen

When you start the projection for the first time, the minimum required setting screen for projection will be displayed.

INITIAL SETTING

1. Select the required language setting by pressing ◀ ▶, then press the **ENTER** button.

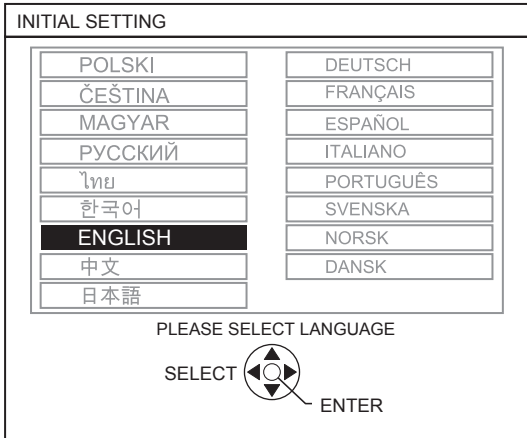

2. Select the minimum required settings to start the projection.
 - Press the **RETURN** button to return to the language setting menu.
 - Press ▲ ▼ to move through the menu items.
 - Press ◀ ▶ to select the required setting.
 - Press the **ENTER** button to complete the setting and start the projection.

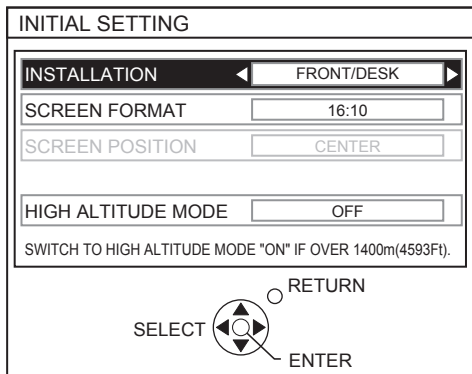

NOTE:

- Once you finish the minimum requirement setting, it will not be displayed again unless the projector is initialised. See "INITIALIZE ALL" on page 45.
- You can change the each setting from the main menu. See "Menu Navigation" on page 32.

INSTALLATION

Select the required installation method.

FRONT/DESK	Setting on a desk/floor and projecting from front
FRONT/CEILING	Mounting on the ceiling and projecting from front
REAR/DESK	Setting on a desk/floor and projecting from rear
REAR/CEILING	Mounting on the ceiling and projecting from rear

SCREEN FORMAT

Select the required screen format by pressing ◀ ▶.

- **16:10** When project on a 16:10 or 4:3 screen.
- **16:9** When project on a 16:9 screen.

SCREEN POSITION

When **SCREEN FORMAT** menu is set to **16:9**, you can select the menu display position by pressing ◀ ▶.

- **LOW** Displays the menu in the lower part of the screen.
- **CENTER** Displays the menu in the middle of the screen.
- **HIGH** Displays the menu in the upper part of the screen.

HIGH ALTITUDE MODE

If you use the projector at high elevation, the **HIGH ALTITUDE MODE** setting need to be **ON** to set the fan speed high.

- **OFF** The fan speed is low.
- **ON** The fan speed is high.

NOTE:

- At 1 400 - 2700 m (4 593 - 8 858 ft) above sea level, the setting must be **ON**.
- The loudness of fan noise depends on the **HIGH ALTITUDE MODE** setting.

About Your Projector

Projector body

Top and front view

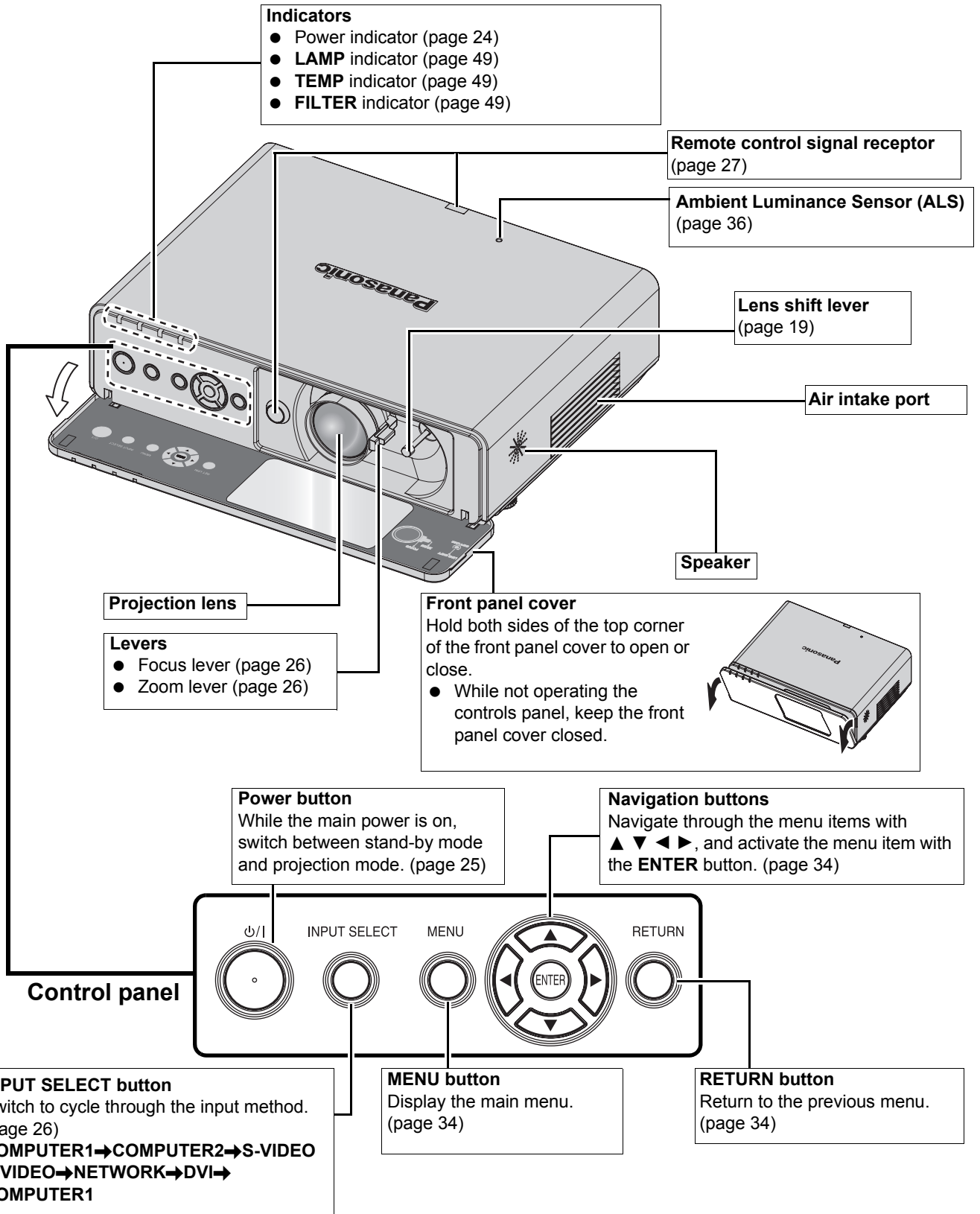

NOTE:

- Do not cover the ventilation openings or place anything within 50 cm (20") of them as this may cause damage or injury.
- While the projector is not in use, keep the front panel cover closed to protect the lens.

Back and bottom view

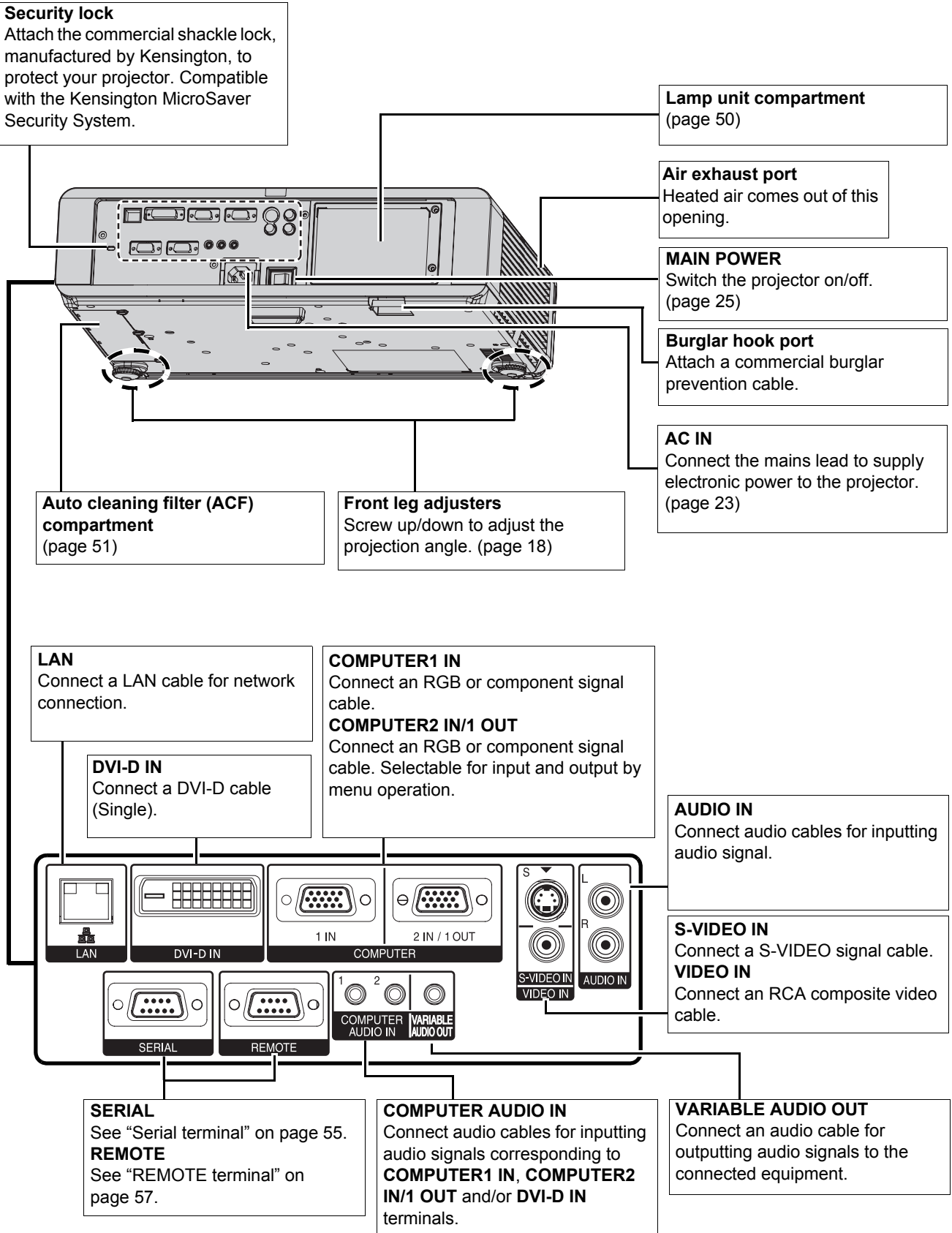







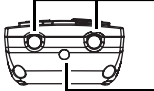

NOTE:

- Do not cover the ventilation openings or place anything within 50 cm (20") of them as this may cause damage or injury.
- When a cable is connected to the **VARIABLE AUDIO OUT**, the built-in speaker will be disabled.

About Your Projector







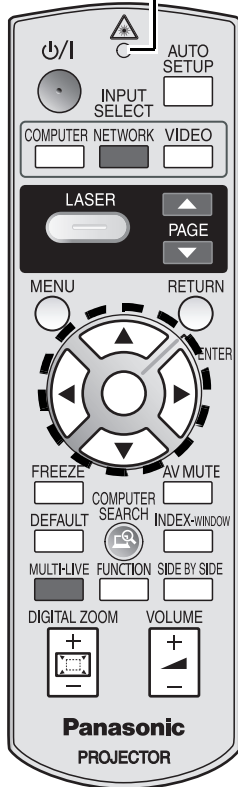

Remote control





<p>Attaching a hand strap You can attach a favourite strap on to the remote control.</p> 	<p>Top view</p>  <p>Remote control signal emitters (page 27)</p> <p>Laser pointer beam emitter (page 31)</p>	<p>Remote control indicator Pressing any button except the LASER button, the remote control indicator will flash. Pressing the LASER button, it will lit.</p>
---	--	--

Power button While the MAIN POWER is on, switch between standby mode and projection mode. (page 23)	
Project a laser pointer. (page 31)	
Display the main menu. (page 34)	
Navigate through the menus with ▲▼◀▶ , and activate the menu item with the ENTER button. (page 34)	
Capture the projected image as a frozen picture. (page 29)	
Reset some of the settings to the factory default settings. (page 29)	
Assign the frequently use functions from the options for shortcut. (page 29)	
Control to change the scale by means of digital zoom. (page 28)	



(Shown as PT-FW300NTE)

	Automatically adjust the setting of SHIFT, DOT CLOCK, CLOCK PHASE and SIGNAL SEARCH for the projected image of COMPUTER/DVI signal. (page 27)
	Switch the required input signal button to select.
	
	Return to the previous menu. (page 34)
	Turn off the projection temporarily. (page 29)
	Display the frozen image while the display of subsequent images continues. (page 29)
	Display 2 different source images at a time. (page 29)
	Control to adjust the volume of the speaker. (page 31)

			
---	---	---	---

These buttons are for network control. See the contents of the provided CD-ROM for instructions. The **COMPUTER SEARCH** button is for PT-FW300NTE only.

Battery compartment

1. Press the tab and lift up the cover.
2. Insert the batteries according to the polarity diagram indicated inside.

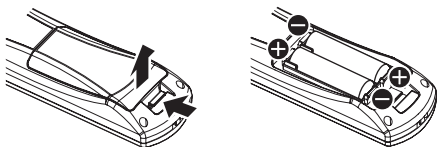

NOTE:

- Do not drop the remote control.
- Avoid contact with liquids or moisture.
- Use manganese batteries or alkaline batteries with the remote control.
- Do not attempt to modify or disassemble the remote control. Contact an Authorised Service Centre for repairs.
- Do not keep pressing the remote control buttons as this may shorten battery life.
- Do not point the laser in other people's eyes or stare into beam.
- See "Remote control operation" on page 27.

Setting up

Screen size and throw distance

You can adjust the projection size with 2.0x zoom lens. Calculate and define the throw distance as follows.

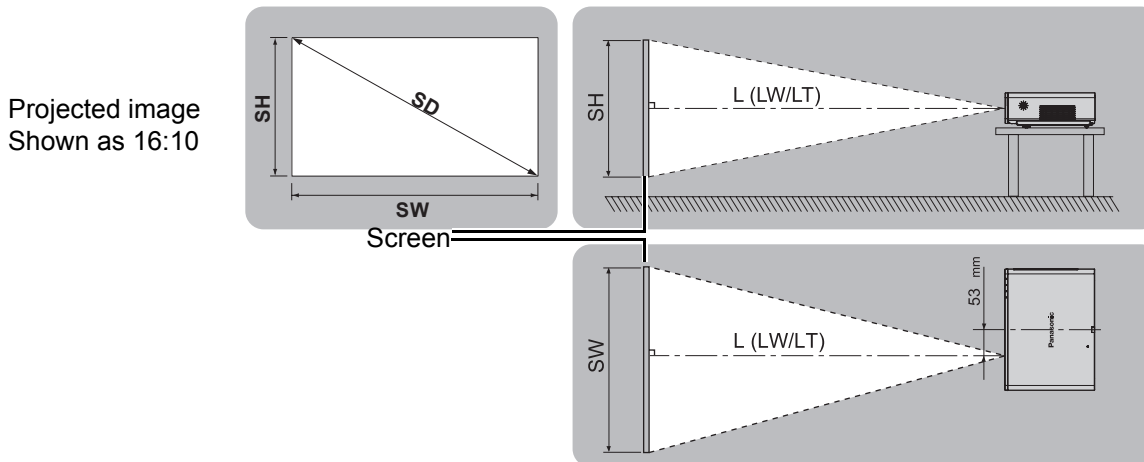

All measurements and the calculation results below are approximate and may differ slightly from the actual measurements.

Projection size (16 : 10)			Throw distance (L)	
Screen Diagonal (SD)	Screen height (SH)	Screen width (SW)	Minimum distance (LW)	Maximum distance (LT)
(0.84 m) 33"	0.44 m (1'5")	0.71 m (2'3")		1.8 m (5'10")
(1.02 m) 40"	0.54 m (1'9")	0.86 m (2'9")	1.1 m (3'7")	2.3 m (7'6")
(1.27 m) 50"	0.67 m (2'2")	1.08 m (3'6")	1.4 m (4'7")	2.8 m (9'2")
(1.52 m) 60"	0.81 m (2'7")	1.29 m (4'2")	1.7 m (5'6")	3.4 m (11'1")
(1.78 m) 70"	0.94 m (3'1")	1.51 m (4'11")	2.0 m (6'6")	4.0 m (13'1")
(2.03 m) 80"	1.08 m (3'6")	1.72 m (5'7")	2.3 m (7'6")	4.6 m (15'1")
(2.29 m) 90"	1.21 m (3'11")	1.94 m (6'4")	2.6 m (8'6")	5.1 m (16'8")
(2.54 m) 100"	1.35 m (4'5")	2.15 m (7')	2.9 m (9'6")	5.7 m (18'8")
(3.05 m) 120"	1.62 m (5'3")	2.58 m (8'5")	3.4 m (11'1")	6.9 m (22'7")
(3.81 m) 150"	2.02 m (6'7")	3.23 m (10'7")	4.3 m (14'1")	8.6 m (28'2")
(5.08 m) 200"	2.69 m (8'9")	4.31 m (14'1")	5.7 m (18'8")	11.5 m (37'8")
(6.35 m) 250"	3.37 m (11')	5.38 m (17'7")	7.2 m (23'7")	14.3 m (46'10")
(7.62 m) 300"	4.04 m (13'3")	6.46 m (21'2")	8.6 m (28'2")	17.2 m (56'5")

Calculation methods

$$SW (m) = SD (") \times 0.0215$$

$$SH (m) = SD (") \times 0.0135$$

$$LW (m) = 0.0289 \times SD (") - 0.046$$

$$LT (m) = 0.0576 \times SD (") - 0.061$$

NOTE:

- See page 59 for the screen size and throw distance of 4:3/16:9.
- Do not use the projector at a raised or a horizontally tilted position as it may cause malfunction of the projector.
- Make sure the projector lens surface is parallel with the screen. You can tilt the projector body approximately $\pm 30^\circ$ vertically. Overtilting may result in shortening the component's life.
- For the best quality of the projection image, install a screen where sun light or room light does not shine directly onto the screen. Close window shades or curtains to block the lights.

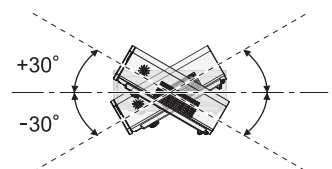

Setting up

Projection method

You can use the projector with any of the following 4 projection methods. To set the desired method in the projector, See "INSTALLATION" on page 44.

■ Setting on a desk/floor and projecting from front

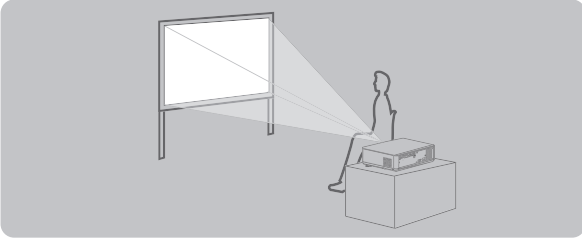

INSTALLATION: FRONT/DESK

■ Setting on a desk/floor and projecting from rear

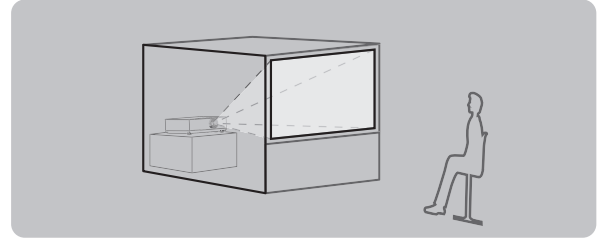

INSTALLATION: REAR/DESK

■ Mounting on the ceiling and projecting from front

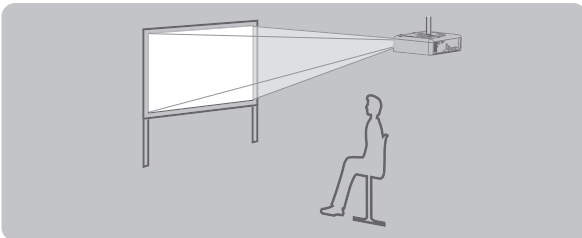

INSTALLATION: FRONT/CEILING

■ Mounting on the ceiling and projecting from rear

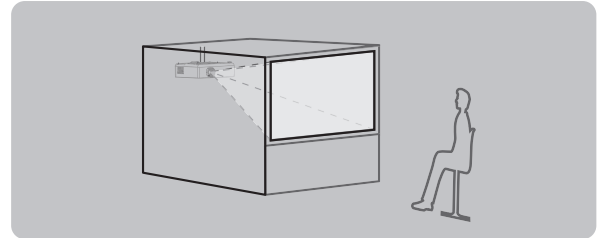

INSTALLATION: REAR/CEILING

NOTE:

- A translucent screen is required for rear projection.
- When mounting the projector on the ceiling, the optional ceiling mount bracket (ET-PKF100H, ET-PKF100S) is required.
- See "Ceiling mount bracket safeguards" on page 58.

Front leg adjusters and throwing angle

You can screw up/down the front leg adjusters to control the angle of the projector for adjusting the throwing angle. See "Positioning the image" on page 26.

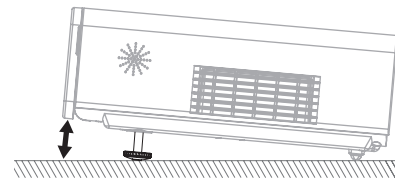
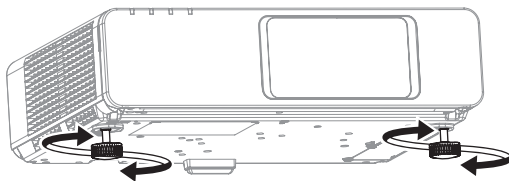

NOTE:

- Heated air comes out of the air exhaust port. Do not touch the air exhaust port directly.
- If keystone distortion occurs, see "KEYSTONE" on page 37.
- Screw up the adjuster legs, and an audible click will be heard as the limit.

Lens shift and positioning

If the projector is not positioned right in front of the centre of the screen, you can adjust the projected image position by moving the lens shift lever within the shift range of the lens.

Adjusting the lens shift lever

1. Open the front panel cover.
2. Screw the lens shift lever counterclockwise to unlock.
3. Move the lens shift lever to adjust the projected image position.
4. Screw the lens shift lever clockwise to lock.

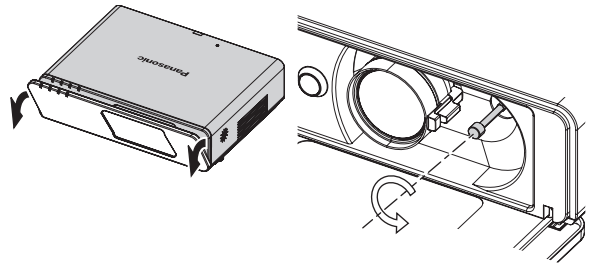

Horizontal shift

You can place the projector where the projector lens is up to 24% horizontally off-centre from the screen and then adjust the image position with the lens shift lever.

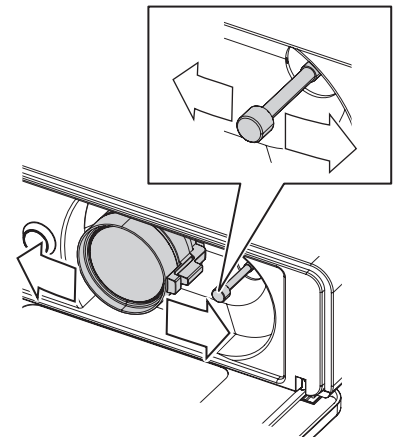
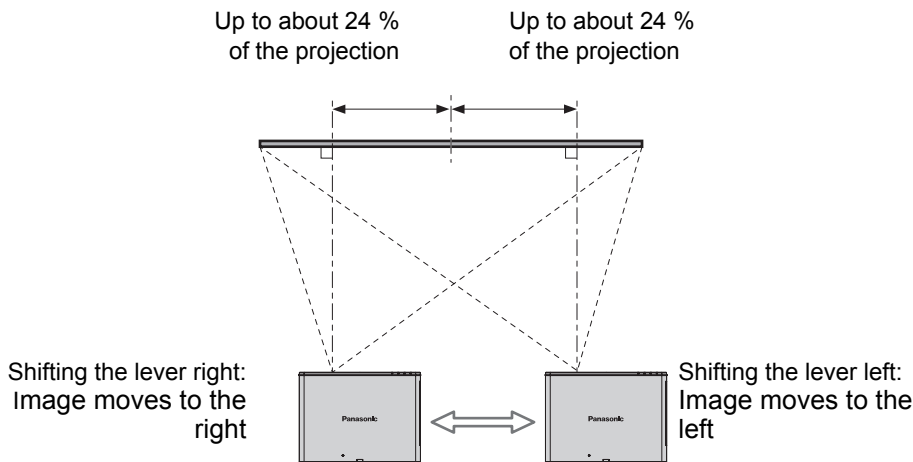

Vertical shift

You can place the projector where the projector lens is up to 50% vertically off-centre from the screen and then adjust the image position with the lens shift lever.

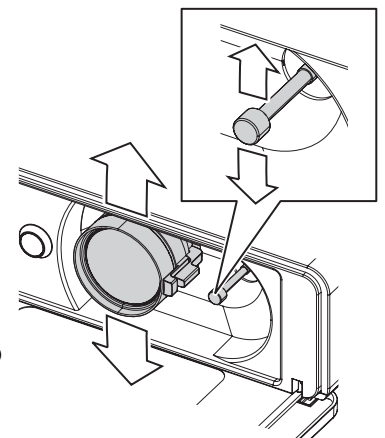
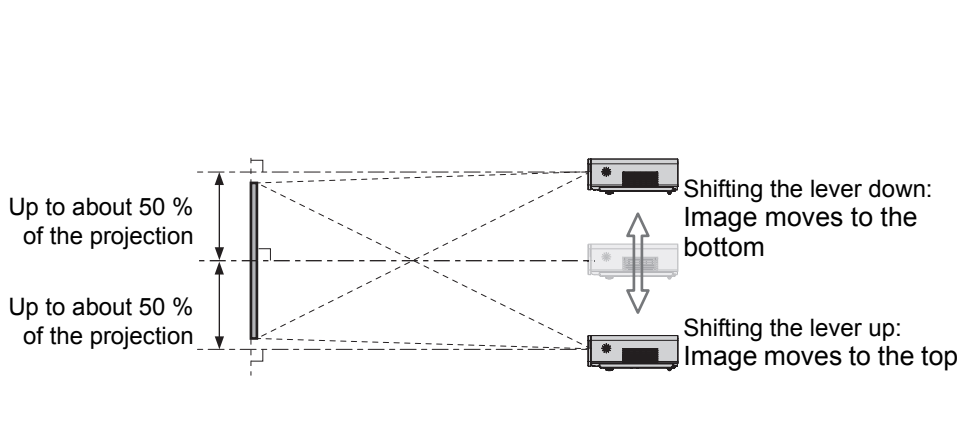

Setting up

Projector location range

You can determine where to locate the screen and the projector by considering the lens shift possibilities. See "Positioning the image" on page 26.

When the screen position is fixed

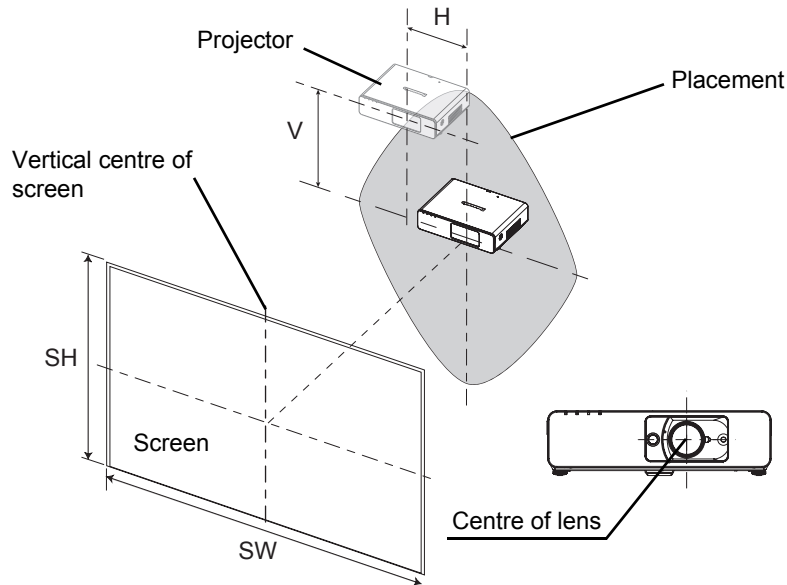

When the projector position is fixed

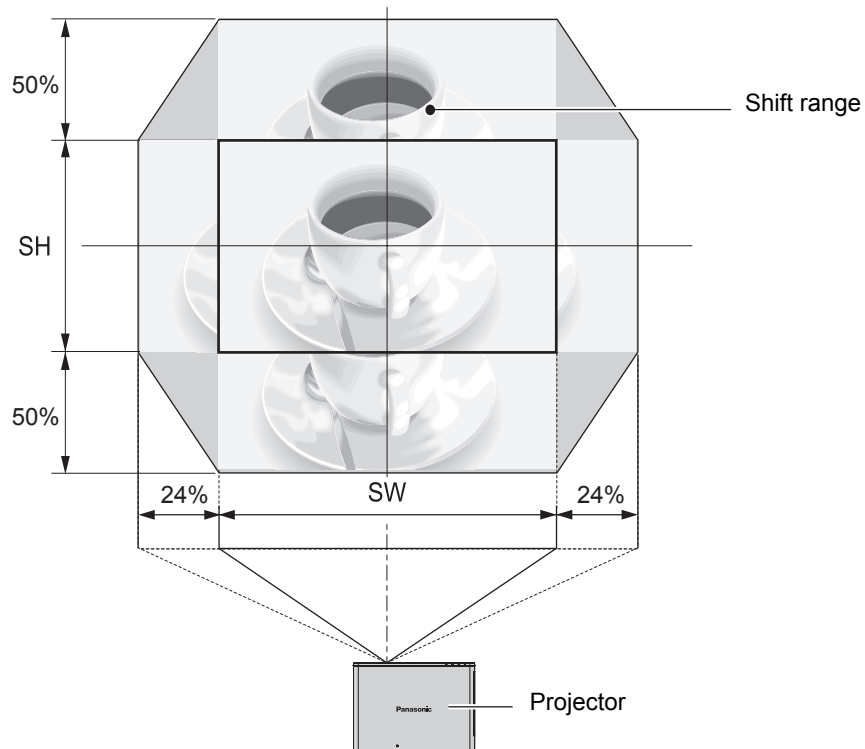

NOTE:

- When the projector is located right in front of the screen and the lens shift lever is centred, you will get the best quality of the projection image.
- When the lens shift lever is at the vertical limit of the shift range, you cannot move the lever to the horizontal limit, likewise when the lens shift lever is at the horizontal limit of the shift range, you cannot move the lever to the vertical limit.
- When the projector is tilted and you adjust **KEYSTONE**, the centre of the screen and the lens need to be realigned.
- Do not attempt to pull the lens shift lever hard while adjusting.

Connections

Before connection to the projector

- Read and follow the operating and connecting instructions of each peripheral device.
- The peripheral devices must be turned off.
- Use cables that match each peripheral device to be connected.
- If the input signal is affected by signal jitter, the projected image may have poor image quality and timebase correction is effective.
- Confirm the type of video signals. See “List of compatible signals” on page 54.

Connecting example: Computers

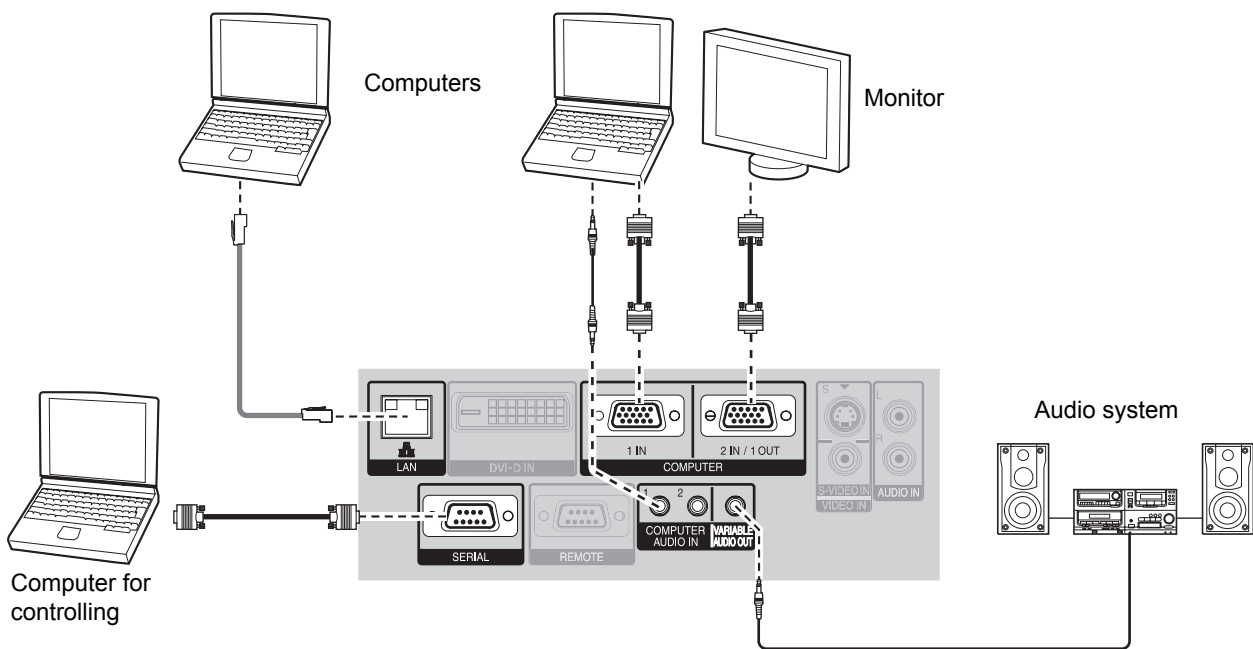

NOTE:

- Use **COMPUTER** terminals to input **YPbPr** signals.
- When connecting to the **COMPUTER** terminals, you can switch the audio input terminal between **COMPUTER AUDIO IN** and **AUDIO IN**. See “AUDIO SETTING” on page 44.
- When **COMPUTER2 SELECT** in the **OPTION** menu is set to **OUTPUT**, do not connect any input signals.
- See CD-ROM contents for the LAN network connection.

LAN terminal

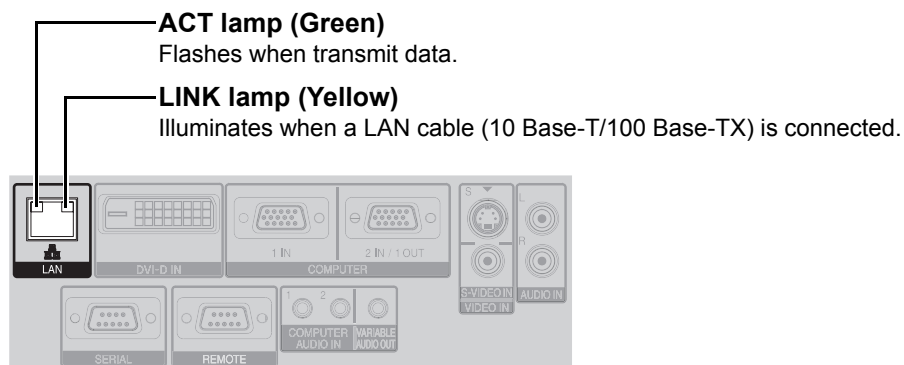

NOTE:

- Do not touch the metal parts of the **LAN** terminal. Failure to observe this may cause malfunction by static electricity.

Connections

Connecting example: AV equipment

Connecting with VIDEO IN/S-VIDEO IN

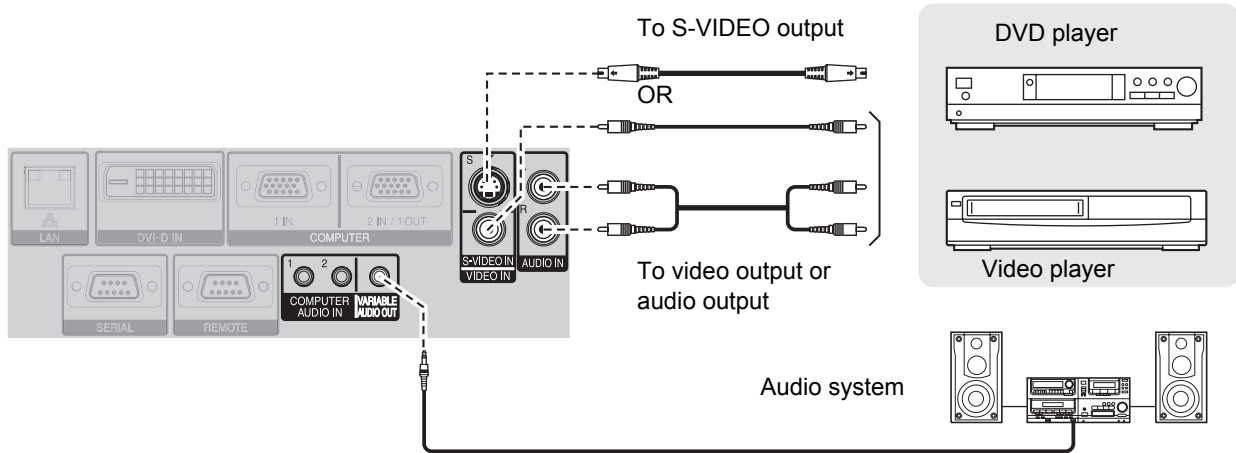

NOTE:

- When you connect more than one AV equipment, switch the audio connection manually.

Connecting with DVI-D IN

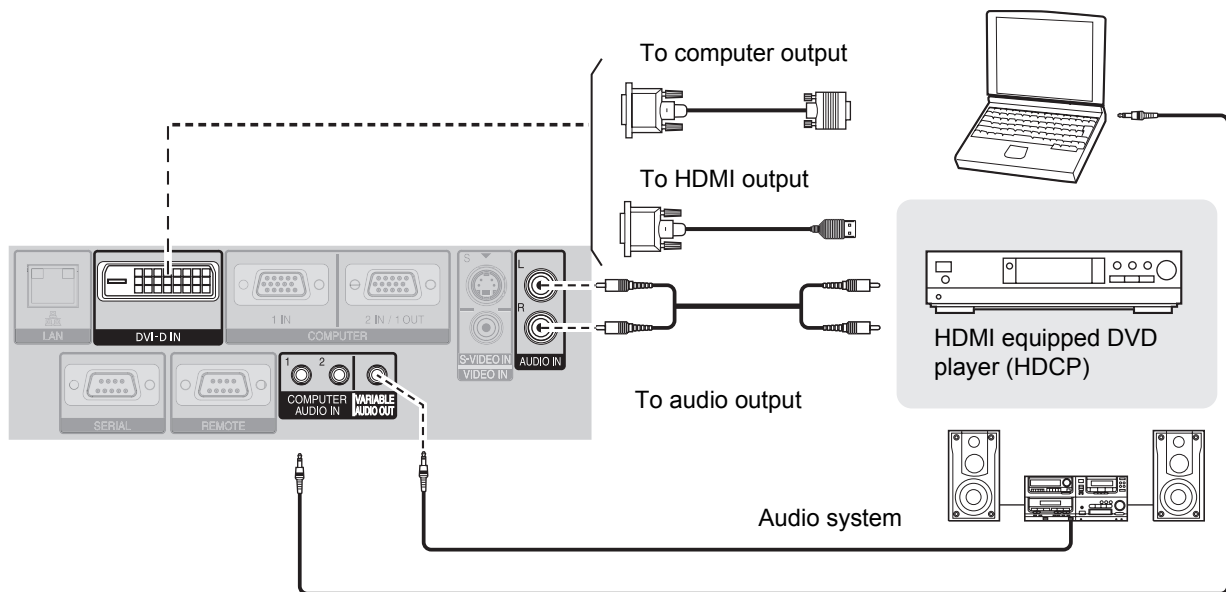

NOTE:

- DVI-D is single link.
- Prepare a HDMI - DVI-D cable for HDMI connection.
- You may need to change the setting of the DVI EDID in DISPLAY OPTION menu with some DVI-D IN connection. See "DVI-D IN" on page 40.
- Malfunction may occur or other problems could be encountered with some kind of HDMI or DVI equipment.
- When connecting to the **DVI-D IN** terminal, you can switch the audio input terminal between **COMPUTER AUDIO IN 2** and **AUDIO IN**. See "AUDIO SETTING" on page 44.

Switching the projector on/off

Mains lead

Connecting

1. Make sure the shape of the mains plug and the **AC IN** terminal on the back of the projector match, then push the plug all the way in.

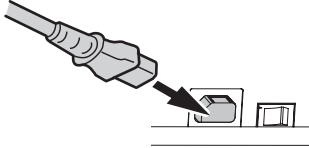

2. Align the side of the power cord secure lock with the side guide rail of the **AC IN** terminal of the projector and slide it in.

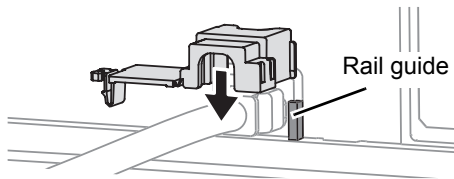

3. Place the latch to the latch catcher and press until it clicks.

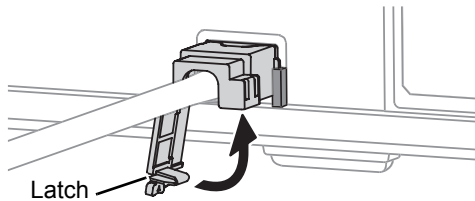

4. Connect the mains lead to a mains socket.

Disconnecting

1. Unplug the mains lead from the mains socket.
2. Depress the latch and slide the cover off.

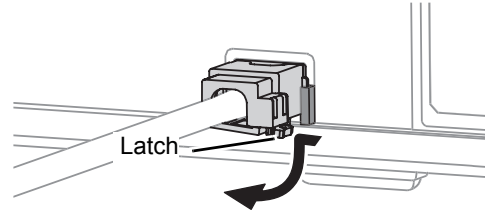

3. Slide the power cord secure lock up along the side guide rail and remove.

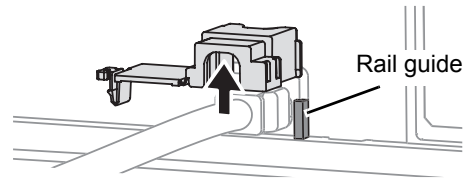

4. Hold the plug and unplug the mains lead from the **AC IN** terminal on the back of the projector.
 - Power indicator lights in orange if the internal cooling fan is still operating by internal power supply.

NOTE:

- Do not use other than the provided mains lead.
- Ensure all the input devices are connected and turned off before connecting the mains lead.
- Do not force the connector as this may damage the projector and/or the mains lead.
- Dirt or dust build-up around plugs may cause fire or electrical hazards.
- Switch off the power to the projector when not in use.
- If the projector is switched on again while the internal cooling fan is still operating by the internal power supply, it may take a while to start the projection.

Direct power on function

You can start the projection with only supplying the electric power. See "INITIAL START UP" on page 43.

Direct power off function

You can switch off the electric power supply any time by unplugging the mains plug from the mains socket or by switching off the main power. The internal lamp cooling fan keeps operating by the internal power supply, and stops automatically when cooled enough.

Switching the projector on/off

Power indicator

The power indicator informs you the status of the power.

- When the **LAMP** or **TEMP** indicator is flashing, you cannot switch on the power. See “TEMP, LAMP and FILTER Indicators” on page 49.

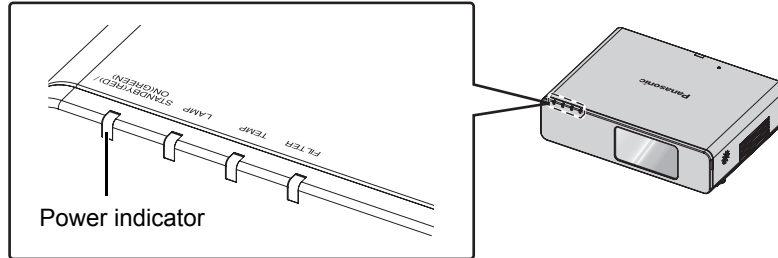

Indicator status		Status
No illumination or flashing		The MAIN POWER is switched off.
RED	Lit	The MAIN POWER is switched on and the projector is in standby mode. When the LAMP or TEMP indicator is flashing, not available to switch on the power.
	Flashing	The power is switched off. (When NETWORK STANDBY in NETWORK menu or IN STANDBY MODE of AUDIO SETTING in PROJECTOR SETUP menu is set to ON). Press the power button to start the projection.
GREEN	Flashing	The power is switched on and the projector is getting ready to project.
	Lit	Projecting.
ORANGE	Lit	The power is switched off and the projector is cooling the lamp. The indicator will light or flash, and start the projection after a short time.
	Flashing	The power is switched on again when cooling the lamp and recovering to projection mode.

NOTE:

- If the projector is switched on again while the internal cooling fan is still operating by the internal power supply, it may take a while to start the projection.
- The electric consumption in standby mode is 4 W.

Switching on the projector

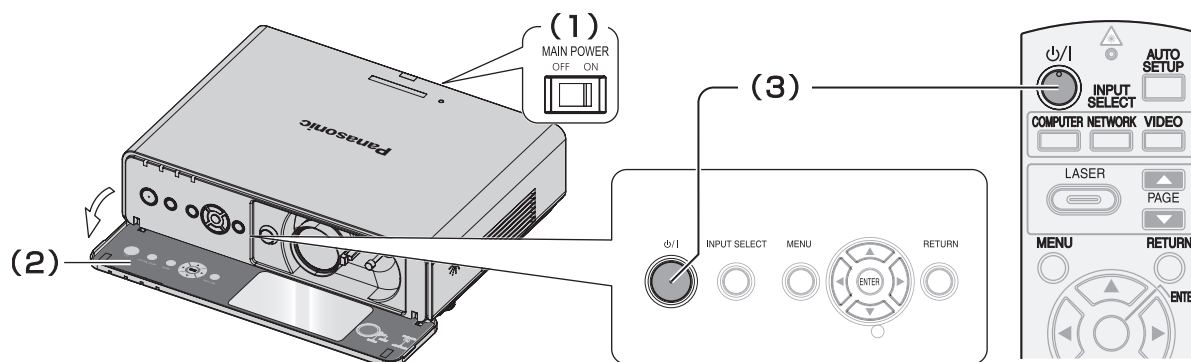

1. Switch the **MAIN POWER** on.
 - The power indicator lights up in red.
2. Open the front panel cover.
 - This is not necessary in remote control operation.
3. Press the power button.
 - The power indicator lights up in green after flashing for a while.
 - The **STARTUP LOGO** will be displayed on the screen. See “STARTUP LOGO” on page 41.

NOTE:

- When starting up the projector, some small rattling or tinkling sound may be heard, or the display may flicker for the characteristics of the lamp. Those are normal and will not affect the performance of the projector.
- When the internal cooling fan is operating, some operational sound may be heard. The loudness of the operational sound depends on the external temperature.
- If you disconnected the mains lead or switched off the **MAIN POWER** while on projecting mode, the projection will start with connecting the mains lead or switching on the **MAIN POWER**. See “INITIAL START UP” on page 43.

Switching off the projector

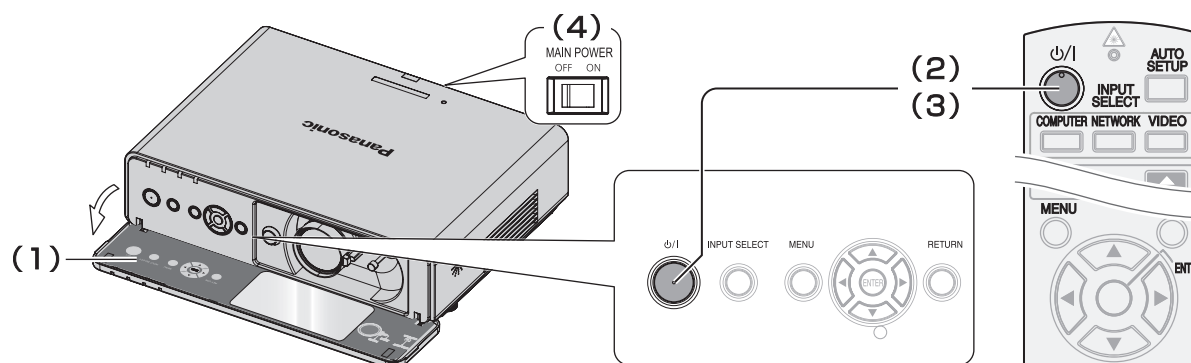

1. Open the front panel cover.
 - This is not necessary in remote control operation.
2. Press the power button.
 - The confirmation screen is displayed. It will disappear and return to the projection after 10 seconds without any operation.
 - To return to the projection, press any button except the power button.
3. Press the power button.
 - The power indicator lights up in orange while cooling the lamp, then illuminates red when is ready to switch off the **MAIN POWER**.
4. Switch off the **MAIN POWER** on the back of the projector.

NOTE:

- You can disconnect the mains lead or switch off the **MAIN POWER** instead of following this procedure. See “INITIAL START UP” on page 43.

Projecting an image

Selecting the input signal

1. Switch on the connected devices.
 - Press the play button of the required device.
2. Press the **INPUT SELECT** buttons to select the required input method if needed. See “Switching the input signal” on page 28.
 - The image will be projected on the screen.

NOTE:

- **SIGNAL SEARCH** is **ON** as default and the signal from the connected devices is detected automatically. See “SIGNAL SEARCH” on page 41.

Positioning the image

1. Open the front panel cover.
2. Adjust the projected image with the lens shift lever. See “Lens shift and positioning” on page 19.

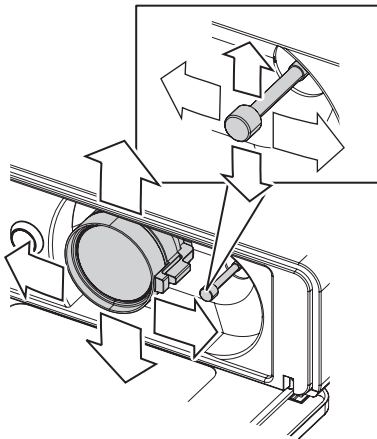

4. Adjust the focus and the projected image size.
 - Turn the focus lever and zoom lever to adjust the image.
 - You can confirm the adjusted effect with the **TEST PATTERN** in **OPTION** menu. See “TEST PATTERN” on page 45.

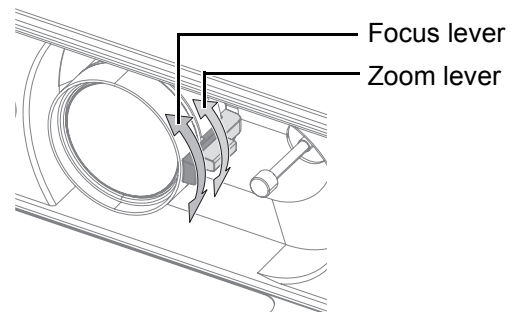

3. Adjust the angle of the projector.
 - Screw down the front leg adjusters and adjust the angle vertically.
 - See “Front leg adjusters and throwing angle” on page 18.

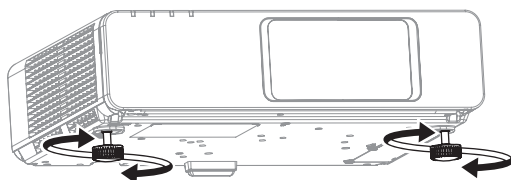

NOTE:

- Do not touch the air exhaust port as this may cause burns or injury.
- If keystone distortion occurs, see “KEYSTONE” on page 37.
- If you adjust the focus, you may need to adjust the size of the image by moving the zoom lever again.

Remote control operation

Operating range

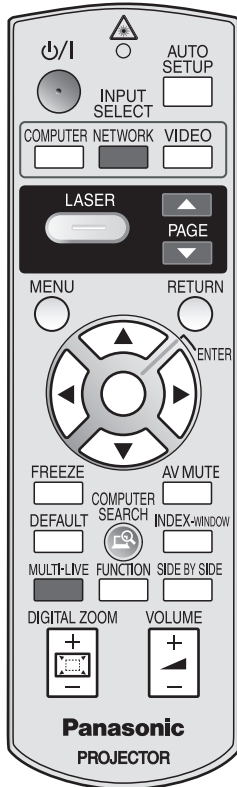

(Shown as PT-FW300NTE)

You can operate the projector with the remote control within the remote range 15 m (49'2"), approximately $\pm 30^\circ$ vertically and horizontally.

● Facing to the projector

Ensure the remote control emitter is facing to the remote control signal receptor on front/back of the projector and press the required buttons to operate.

● Facing to the screen

Ensure the remote control emitter is facing to the screen and press the required buttons to operate the projector. The signal will be reflected off the screen. The operating range may differ due to the screen material. This function may not be effective with a translucent screen.

NOTE:

- Do not let strong light shine onto the signal receptor. The remote control may malfunction under strong light such as fluorescent.
- If there are any obstacles between the remote control and the remote control signal receptor, the remote control may not operate correctly.

Setting up the image position automatically

You can adjust the setting of **SHIFT**, **DOT CLOCK** and **CLOCK PHASE** in the **POSITION COMPUTER** signal image.

- With DVI signal, adjust **SHIFT** setting only.

NOTE:

- If the dot clock frequency is 150 MHz or higher, **AUTO SETUP** is not effective.
- If the projected image is dark or blurred around the edge, **AUTO SETUP** may stop the processing before complete. Project a much clearer or lighter image and press the **AUTO SETUP** button again.
- When there is no signal input and **SIGNAL SEARCH** in **DISPLAY OPTION** menu is **ON**, the auto signal detecting system will start.

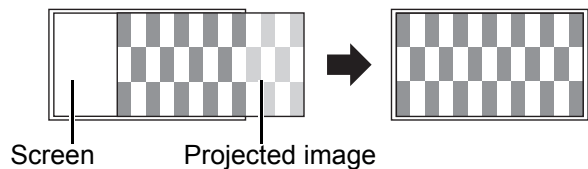

Remote control operation

Switching the input signal



You can switch the input method manually by pressing the **COMPUTER**, **NETWORK** and **VIDEO** buttons. Press the required button several times or **◀ ▶** to cycle through the input methods as follows. The actual projected image will be changed in a while.

- The graphical guidance will be displayed on the upper right of the projected image and you can confirm the selected input method which is highlighted in yellow. See "INPUT GUIDE" on page 40.

NOTE:

- If you select an unplugged input method, the guidance will blink on and off several times.
- See "List of compatible signals" on page 54.
- See "Connections" on page 21.

Pressing the **COMPUTER** button

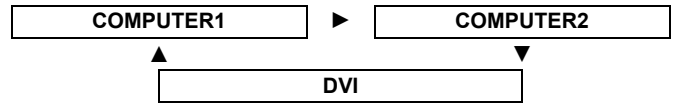

NOTE:

- Only when the **COMPUTER2 SELECT** is set to **INPUT**, the **COMPUTER2** is selectable.

Pressing the **NETWORK** button

- Only for the network connection operation. See CD-ROM contents for more detailed information.

Pressing the **VIDEO** button



Pressing the **INPUT SELECT** button on the projector

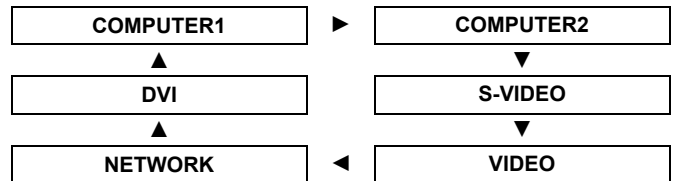

Enlarging the centred area



You can enlarge the projected image down to a centred area for emphasizing within the range of 1x to 2x.

● Enlarging the image

- Press the **DIGITAL ZOOM +/-** button once.
 - The centred area of the image will then be enlarged to 1.5x.



- Adjust the image size by pressing the **DIGITAL ZOOM +/-** button.
 - The image size will be changed in steps of 0.1.



● Shifting the centre point

Press **▲ ▼ ◀ ▶** to shift the centre point.

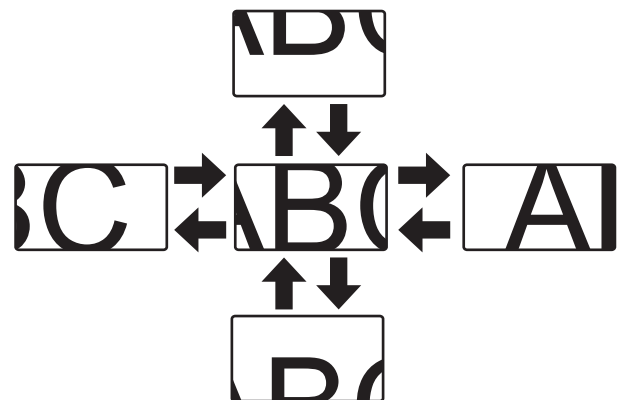

NOTE:

- When the **COMPUTER** signal is projected, the enlargement range will be changed to 1x to 3x. When the **FRAME LOCK** in **POSITION** menu is set to **ON**, the enlargement range is 1x to 2x. See "FRAME LOCK" on page 39.
- When the input signal is changed while the **DIGITAL ZOOM** is activated, the **DIGITAL ZOOM** will be cancelled.
- While **DIGITAL ZOOM** is activated, **FREEZE** is not available.

Capturing an image



Press the **FREEZE** button to capture the image and stop the audio, and you can see it as a still picture while the AV equipment are continuing.

Press the **FREEZE** button again to escape and return to the continuing image.

Stopping the projection



You can stop the projection and audio sound through the projector for saving electrical

power. Press the **AV MUTE** button again to escape.

Resetting to the factory default settings



You can reset most of the customised settings to the factory defaults by pressing the **DEFAULT** button of the remote control. Display the required sub menu or the menu items, and press the **DEFAULT** button again.

- See "Main menu and Sub-menu" on page 32.

NOTE:

- Some menu items are not available to reset by pressing the **DEFAULT** button. Adjust each menu items manually.
- To reset all the settings to the factory defaults, see "INITIAL START UP" on page 43.

Projecting an image in INDEX-WINDOW mode



You can project an image in split 2 windows as an **INDEX-WINDOW**, one is frozen, stored in memory and displayed on the screen's left side, while the display of subsequent images continues on the right.

To escape from the **INDEX-WINDOW**, press the **MENU** or **RETURN** button.

● Changing the image size

Press **▲ ▼** to capture a new image and change the size in 2 ways.

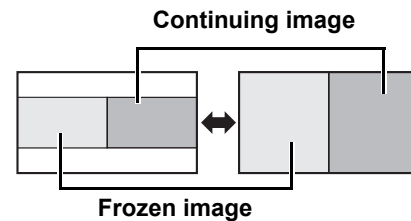
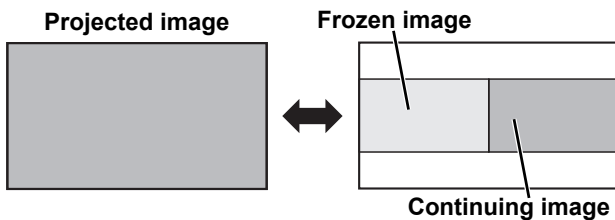

● Switching the position

In default, the frozen image is displayed on the left and the subsequent image is displayed on the right. Press **◀ ▶** to switch the position.

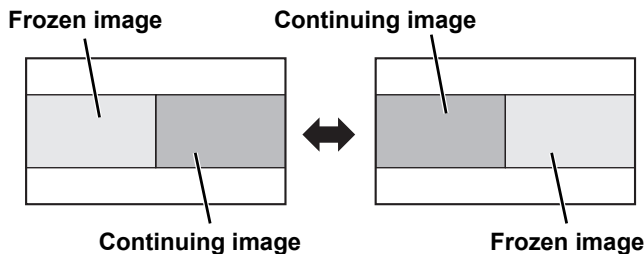

NOTE:

- If you change the window size, the aspect ratio of the image is changed and becomes vertically elongated.
- When vertically enlarged, some signals image with **THROUGH** aspect ratio setting will not be displayed correctly.

● Capturing a new image

While in **INDEX-WINDOW** mode, press the **ENTER** button to capture a new image and the frozen image window will be updated in a while.

NOTE:

- When capturing a quick moving picture, perform several times to get a stabled image.

Remote control operation

Using an assigned function

You can assign a selected function to the **FUNCTION** button. Following functions are assignable.

Options	Functions	Refer
DISABLE	Deactivate the FUNCTION button.	-
ASPECT	Display the ASPECT menu.	38
PICTURE MODE	Display the PICTURE MODE menu.	35
DAYLIGHT VIEW	Display the DAYLIGHT VIEW menu.	36

NOTE:

- See "FUNCTION BUTTON" on page 44.

Projecting 2 different source image at a time

SIDE BY SIDE



You can project the image and another source of image at the same time in double window style. Press any button of **RETURN**, **MENU**, **SIDE BY SIDE** or **INPUT SELECT** buttons to return to the normal projection style.

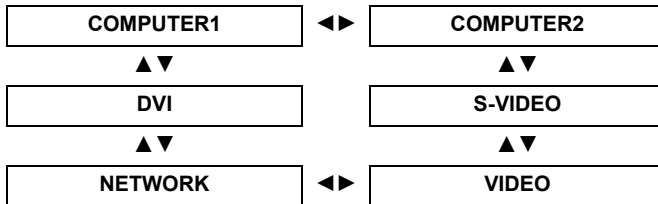

Switching the signal

In default, the first image is displayed on the left and the second image is displayed on the right. You can switch and cycle through the signals of the second image by pressing **▲ ▼**

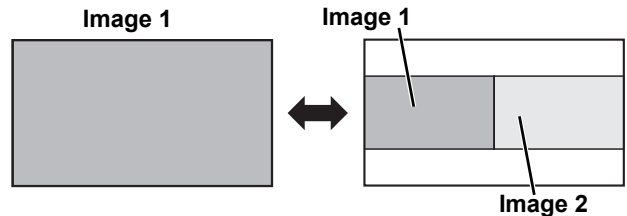

Side by Side function signal combination table

			Image 1								
			COMPUTER1		COMPUTER2		VIDEO IN	S-VIDEO IN	DVI-D		NETWORK connection
			Still	Movie	Still	Movie			Still	Movie	
Image 2	COMPUTER1	Still	N/A	N/A	OK	OK	OK	OK	OK	OK	OK
		Movie	N/A	N/A	OK	N/A	N/A	N/A	OK	N/A	OK
	COMPUTER2	Still	OK	OK	N/A	N/A	OK	OK	OK	OK	OK
		Movie	OK	N/A	N/A	N/A	N/A	N/A	OK	N/A	OK
	VIDEO IN		OK	N/A	OK	N/A	N/A	N/A	OK	N/A	OK
	S-VIDEO IN		OK	N/A	OK	N/A	N/A	N/A	OK	N/A	OK
	DVI-D	Still	OK	OK	OK	OK	OK	OK	N/A	N/A	OK
		Movie	OK	N/A	OK	N/A	N/A	N/A	N/A	N/A	OK
NETWORK connection		OK	OK	OK	OK	OK	OK	OK	OK	N/A	

NOTE:

- **FREEZE** and **VOLUME** controls are available with the first image only.
- While **SIDE BY SIDE** is activated, **DIGITAL ZOOM**, **INDEX-WINDOW** and **AUTO SETUP** are not available.
- While **SIDE BY SIDE** is activated, the main menu will not be displayed.
- The second image will apply to the value of the **PICTURE** settings of the first image except **CONTRAST** and **BRIGHTNESS**.
- **COMPUTER** and **NETWORK** signals will not keep the adjusted aspect ratio.

Using the laser pointer



You can highlight items on the screen with the red laser pointer while projecting the image in presentations or visual demonstrations as an eye-catching pointing device.

Hold down the **LASER** button to go on the laser pointer and release to go off.

- Top view

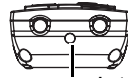

Laser pointer beam emitter

- Deactivating switch

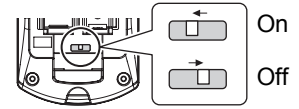

Disable the LASER button

You can disable the **LASER** button for an accidental operation.

1. Open the battery compartment cover of the remote control.
2. Slide the switch tab.
3. Close the battery compartment cover of the remote control.
 - See "Battery compartment" on page 16.

NOTE:

- If you press the disabled **LASER** button, the alert "**LASER POINTER IS DISABLED.**" will be displayed on the screen. While the menu is displaying, the alert will not be displayed.

- Cautions

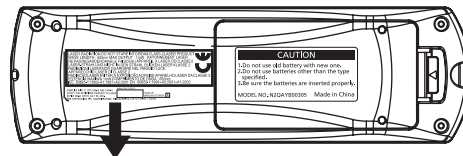

COMPLIES WITH 21 CFR101.10 AND 1042.11 EXCEPT FOR DEVIATIONS PURSUANT TO LASER NOTICE MODEL DATED JULY 26, 2001. SHW CORPORATION, 6-5, 1000SH 6-CHOME, SHINAGAWA-KU, TOKYO 142-8511, JAPAN



(Shown as PT-FW300NTE)

CAUTION: Use of controls of adjustments or performance of procedures other than those specified herein may result in hazardous radiation exposure.

NOTE:

- The laser pointer should never be projected directly into the eyes of a person or animal.
- Do not aim the laser at reflective surfaces.
- Do not allow children to use laser pointer.
- Never look directly into the laser beam.
- The laser pointer is not effective with translucent screens.
- Please read the cautions on the remote control.
- This is a Class 2 laser product.

Controlling the volume of the speaker



You can control the volume of the built-in speakers and output sound. Press "+" side of the **VOLUME** button to increase and "-" to decrease.

NOTE:

- Power consumption can be reduced if the volume level is lowered.

Menu Navigation

Main menu and Sub-menu

The menu options are structured and categorised. You can navigate through the menu with ▲ ▼ ◀ ▶ buttons. See “Menu Navigation” on page 32.

- The underlined items are factory default settings.
- Some default settings vary by the selected input signal.
- Sub-menu items vary according to the selected input signal.
- Some settings are adjustable without any signals.

PICTURE

PICTURE MODE		page 35
NATURAL	STANDARD	
DYNAMIC	BLACKBOARD	
CINEMA		
CONTRAST		page 35
(Default: 0)		
BRIGHTNESS		page 35
(Default: 0)		
COLOR		page 35
(Not available with NETWORK connection)		
(Default: 0)		
TINT		page 35
(Not available with NETWORK connection)		
(Default: 0)		
SHARPNESS		page 35
(Default: 0)		
WHITE BALANCE RED^{*1}		page 35
(Default: 0)		
WHITE BALANCE GREEN^{*1}		page 35
(Default: 0)		
WHITE BALANCE BLUE^{*1}		page 35
(Default: 0)		
COLOR TEMPERATURE		page 36
<u>DEFAULT</u>		
LOW	HIGH	
DAYLIGHT VIEW		page 36
<u>AUTO</u>		
OFF	ON	
DIGITAL CINEMA REALITY		page 36
<u>ON</u>	OFF	
NOISE REDUCTION		page 36
<u>OFF</u>	ON	
TV-SYSTEM		page 36
<u>AUTO</u>		
NTSC	NTSC 4.43	
PAL	PAL-M	
PAL-N	SECAM	
RGB/YPBPR		page 36
<u>AUTO</u>		
RGB	YPBPR	

*1. Available with still image of COMPUTER/DVI signals only

POSITION

KEYSTONE	page 37		
(Default: 0)			
SHIFT	page 37		
(Not available with NETWORK connection)			
H (Default: 0)	V (Default: 0)		
SHIFT V	page 37		
(Available with NETWORK connection only)			
(Default: 0)			
DOT CLOCK	page 37		
(Signals from COMPUTER only)			
(Default: 0)			
CLOCK PHASE	page 37		
(Signals from COMPUTER only)			
(Default: 0)			
OVER SCAN	page 37		
(Not available with NETWORK connection)			
ASPECT	page 38		
AUTO	4:3	16:9	H-FIT
V-FIT	HV-FIT	THROUGH	
FRAME LOCK	page 39		
(Signals from COMPUTER only)			
<u>OFF</u>	ON		

LANGUAGE

DEUTSCH	POLSKI
FRANÇAIS	ČEŠTINA
ESPAÑOL	MAGYAR
ITALIANO	РУССКИЙ
PORTUGUÊS	ไทย
SVENSKA	한국어
NORSK	ENGLISH
DANSK	中文
	日本語

DISPLAY OPTION

ON-SCREEN DISPLAY	page 40
INPUT GUIDE	
<u>DETAILED</u>	SIMPLE
OFF	
OSD DESIGN	
<u>TYPE1</u>	TYPE2
TYPE3	
WARNING MESSAGE	
<u>ON</u>	OFF

DVI-D IN		page 40
DVI EDID		
EDID1	EDID2(PC)	
DVI SIGNAL LEVEL		
0-255:PC	16-235	
SCREEN SETTING		page 40
SCREEN FORMAT		
16:10	16:9	
SCREEN POSITION		
CENTER	LOW	
HIGH		
STARTUP LOGO		page 41
ON	OFF	
USER		
AUTO SETUP		page 41
AUTO	BUTTON	
SIGNAL SEARCH		page 41
ON	OFF	
BACK COLOR		page 41
BLUE	BLACK	
WIDE MODE		page 41
AUTO	OFF	
ON		
SXGA MODE		page 41
SXGA	SXGA+	
OTHER FUNCTIONS		page 42
AUTO SETUP	FREEZE	
AV MUTE	SIDE BY SIDE	
INDEX-WINDOW	DIGITAL ZOOM	

PROJECTOR SETUP

STATUS		page 43	
SIGNAL			
NAME	FREQUENCY		
RUNTIME			
PROJECTOR	LAMP		
REMAINING FILTER			
QUANTITY	APPROX.TIME		
COMPUTER2 SELECT		page 43	
INPUT	OUTPUT		
NO SIGNAL SHUT-OFF		page 43	
DISABLE			
15 MIN.	20 MIN.	25 MIN.	30 MIN.
35 MIN.	40 MIN.	45 MIN.	50 MIN.
55 MIN.	60 MIN.		
INITIAL START UP		page 43	
LAST MEMORY	ON	STANDBY	
INSTALLATION		page 44	
FRONT/DESK	FRONT/CEILING		
REAR/DESK	REAR/CEILING		
HIGH ALTITUDE MODE		page 44	
OFF	ON		
EMULATE		page 44	
DEFAULT	D3500		
D4000	D/W5K series		
L730	L780		
L735	L785		
LB/W80			

FUNCTION BUTTON		page 44
DISABLE	ASPECT	
PICTURE MODE	DAYLIGHT VIEW	
AUDIO SETTING		page 44
VOLUME (Default: 20)		
BALANCE (Default: 0)		
IN STANDBY MODE		
OFF	ON	
● AUDIO IN SELECT		
DVI		
COM.AUDIO IN 2	AUDIO IN	
COMPUTER1		
COM.AUDIO IN 1	AUDIO IN	
COMPUTER2		
COM.AUDIO IN 2	AUDIO IN	
TEST PATTERN		page 45
INITIALIZE ALL		page 45
FILTER COUNTER RESET		page 45

SECURITY

PASSWORD		page 46
OFF	ON	
PASSWORD CHANGE		page 46
TEXT DISPLAY		page 46
OFF	ON	
TEXT CHANGE		page 46
MENU LOCK		page 47
OFF	ON	
MENU LOCK PASSWORD		page 47
CONTROL DEVICE SETUP		page 47
CONTROL PANEL		
ENABLE	DISABLE	
REMOTE CONTROLLER		
ENABLE	DISABLE	

NETWORK

		page 48
WIRED LAN		
WIRELESS LAN (PT-FW300NTE only)		
NAME CHANGE	PASSWORD	
PASSWORD CHANGE		
NETWORK STANDBY		
NETWORK CONTROL		
LIVE MODE CUT IN		
COMPUTER SEARCH		
MULTI-LIVE	STATUS	
INITIALIZE		

See CD-ROM contents for more detailed information.

Menu Navigation

Navigating through the menu

Displaying the Main menu

MENU Press the **MENU** button to display the main menu and the operating guidance.

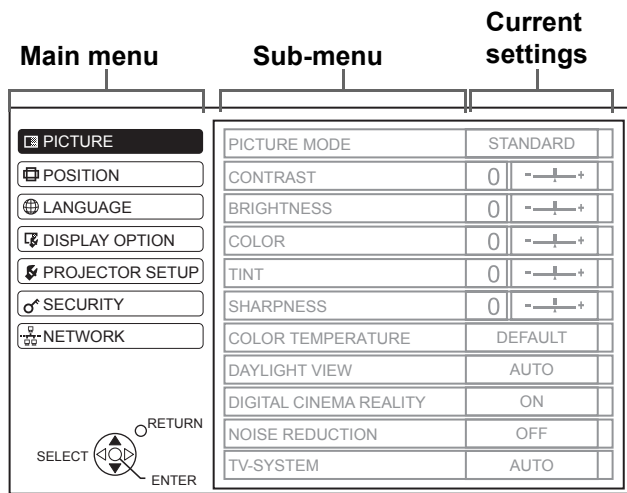

Operating guidance

Contains the required buttons to adjust the settings.

Adjusting with the bar scale items

The triangle mark under the bar indicates factory default setting and the square indicates the current setting.

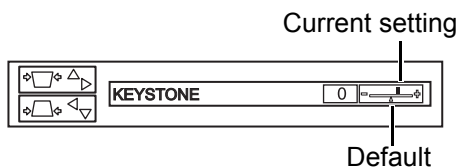

Returning to the previous menu

RETURN Press the **MENU** or **RETURN** button to return to the previous menu. Press repeatedly to escape from the menu mode and return to the projection.



Operating procedure

- Press **▲ ▼** to scroll to the required main menu item and press the **ENTER** button to select.
 - The selected item is highlighted in orange and the sub-menu is displayed on the right.
 - See "Main menu and Sub-menu" on page 32.

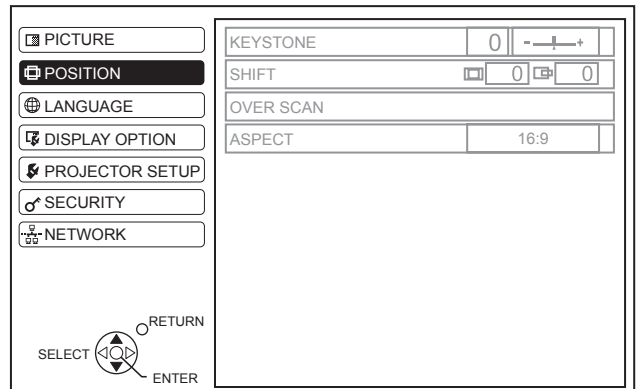

- Press **▲ ▼** to scroll to the required sub-menu item and press **◀ ▶** or the **ENTER** button to adjust.
 - The selected item is called up and the other menu items disappear from the screen. Called up item will be disappear after 5 seconds and return to the menu mode.
 - If there is a lower level, the next level will be displayed.

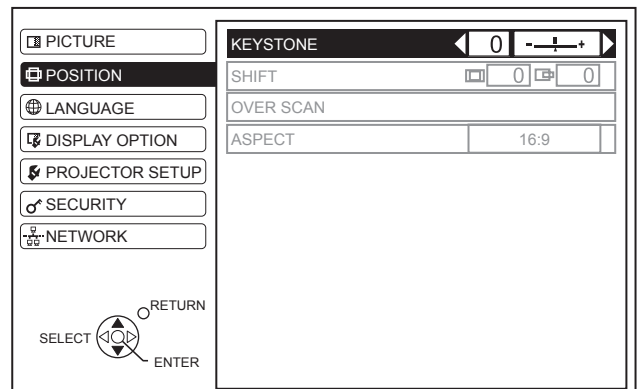

- Press **◀ ▶** to adjust or set the selected item.
 - For items using a bar scale, the current settings are displayed on the left of the bar scale.
 - You can cycle through the options of an item by pressing **◀ ▶**.



- Press the **MENU** or **RETURN** button to return to the previous menu.

NOTE:

- See "Resetting to the factory default settings" on page 29 to reset each menu item.
- See "INITIALIZE ALL" on page 45 to reset all the settings.

PICTURE menu

Remote control

- See "Navigating through the menu" on page 34.
- See "Main menu and Sub-menu" on page 32.

Control panel

PICTURE MODE

Depending on the projection environment, you can use these preset parameter settings to optimise image projection. Press ◀ ▶ to cycle through the options.

STANDARD	Setting for a general image
DYNAMIC	Bright and sharp setting
BLACKBOARD	Setting for when projecting on a blackboard
NATURAL *1	Reproduces the original colour of the image
CINEMA *2	Setting for a cinema type movie

*1. Selectable when still image is displayed.

*2. Selectable when moving image is displayed.

NOTE:

- It may take for a while until the image stabilised in the selected mode.

CONTRAST

You can adjust the contrast of the projected image. Adjust the **BRIGHTNESS** in advance if necessary.



BRIGHTNESS

You can adjust the brightness of the projected image.



COLOR

You can adjust the colour saturation of the projected image. (Available with **VIDEO/S-VIDEO/YPbPr/RGB** movie/**DVI** movie signals only)



TINT

You can adjust the skin tone in the projected image. (Available with **VIDEO/S-VIDEO/YPbPr/RGB** movie/**DVI** movie signals only)



SHARPNESS

You can adjust the sharpness of the projected image.



WHITE BALANCE RED

You can adjust the white balance more properly in red colour temperature by pressing ◀ ▶. (Available with **RGB/DVI** still signals only)

WHITE BALANCE GREEN

You can adjust the white balance more properly in green colour temperature by pressing ◀ ▶. (Available with **RGB/DVI** still signals only)

WHITE BALANCE BLUE

You can adjust the white balance more properly in blue colour temperature by pressing ◀ ▶. (Available with **RGB/DVI** still signals only)

PICTURE menu

COLOR TEMPERATURE

You can adjust the white balance of the projected image.

- **LOW** More bluish
- **DEFAULT** Balanced white
- **HIGH** More reddish

DAYLIGHT VIEW

You can keep the projected image bright and vivid even in well-lit rooms where the ambient light sources cannot be controlled, such as when a door opens or when window coverings fail to block out sunlight.

- **AUTO:** Automatic adjustment
- **ON:** Active
- **OFF:** Deactive

NOTE:

- Do not cover the Ambient Luminance Sensor (ALS) of the projector. See "Ambient Luminance Sensor (ALS)" on page 14.
- **AUTO** is not available when **INSTALLATION** setting in **OPTION** menu is set to **REAR/DESK** or **REAR/CEILING**.

DIGITAL CINEMA REALITY

You can improve the vertical resolution of a 2-2 or 2-3 pulldown movie. Press ◀ ▶ to select the required setting. (Not available with **NETWORK** signals)

- **OFF** Deactive
- **ON** Active

NOTE:

- Available with 480i, 576i, 1 080/60i and 1 080/50i only.

NOISE REDUCTION

You can switch the automatic noise reduction system on/off. Press ◀ ▶ to select the required setting.

- **ON:** Automatic noise reduction
- **OFF:** No noise reduction

NOTE:

- Applying noise reduction may affect image quality.

TV-SYSTEM

When the video signal is changed, the setting switches automatically. You can switch the setting manually to match the video data. Press ◀ ▶ to cycle through the options. (Available with **S-VIDEO/VIDEO** only)

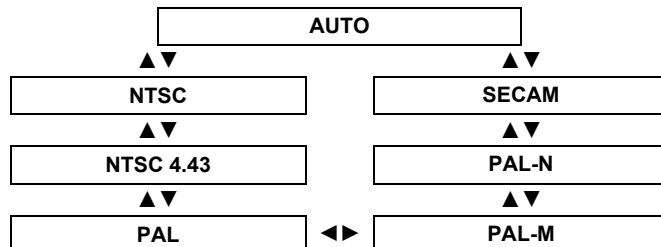

NOTE:

- **AUTO** setting will select from **NTSC/NTSC 4.43/PAL/PAL60/PAL-M/PAL-N/SECAM**.

RGB/YPbPr

The projector will detect the signal from the **COMPUTER** terminals if the signal is **RGB** or **YPbPr**. You can turn off the automatic detecting system and switch between **RGB** and **YPbPr** manually.

- **AUTO:** Automatic detecting system
- **RGB:** Project as **RGB** signal
- **YPbPr:** Project as **YPbPr** signal

NOTE:

- Available with VGA60, 480i, 576i, 480p, 576p, 1 080/60i, 1 080/50i, 720/60p, 720/50p, 1 080/60p, 1 080/50p only.
- When the input signal is not selected correctly with **AUTO** setting, select **RGB** or **YPbPr** manually.

POSITION menu

Remote control

Control panel

- See “Navigating through the menu” on page 34.
- See “Main menu and Sub-menu” on page 32.

KEYSTONE

If the projector is aligned non-perpendicularly to the screen, or if the projection screen has an angled surface, you can correct keystone.

Image	Operation

NOTE:

- You can correct the distortion ± 30 degrees from the plane. For a better quality image, installing the projector with a minimum of distortion is recommended.
- Some distortion may be retained for lens shift adjustment.
- The distortion of the main menu screen is not correctable.
- The result of the keystone correction will affect the aspect ratio and the size of the image.

SHIFT

You can move the projected image for fine adjustment. Press ◀ ▶ to move horizontally and ▲ ▼ vertically. (Not available with **NETWORK** signals)

SHIFT

H

V

SHIFT V

When **H-FIT** setting in **ASPECT** menu is selected, you can move the projected image vertically for fine adjustment by pressing ◀ ▶. (Available with signals from **NETWORK** only)

DOT CLOCK

If you have interference patterns of the projected image, which is sometimes referred to as moire or noise, you can minimize it by pressing ◀ ▶ to adjust the clock frequency. (Available with signals of **RGB/DVI** still only)

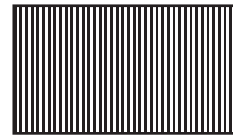

NOTE:

- If the projecting signal's dot clock frequency is higher than 150 MHz, the adjustment may not make a difference.
- **DOT CLOCK** needs to be adjusted before adjusting the **CLOCK PHASE**.

CLOCK PHASE

If you require further adjustment for the same reason as the **DOT CLOCK** adjustment, you can fine adjust the timing of the clock. Press ◀ ▶ to adjust. (Available with signals of **RGB/DVI** still only)

NOTE:

- If the projecting signal's dot clock frequency is higher than 150 MHz, the adjustment may not make a difference.

OVER SCAN

If the 4 edges of an image is partly dropped, you can use this function to adjust and project it properly. (Not available with signals of **NETWORK**)

- ◀ Shrink
- ▶ Enlarge

ASPECT

You can switch the aspect ratio manually when needed. Press ◀ ▶ to cycle through the options.

Aspect ratio options

AUTO

Signals which contains an identifying aspect signal will be detected and automatically project the image in proper ratio. (NTSC and 525i (480i) signals only)

4:3

When a 4:3 or 5:4 signal is detected, the image will be projected without any change, and other signals will be adjusted to 4:3 with preserving original ratio.

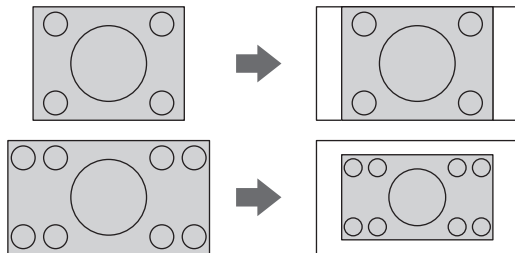

16:9

When a 16:10, 16:9 or 15:9 signal is detected, the image will be projected without any change, and other signals will be adjusted to 16:9.

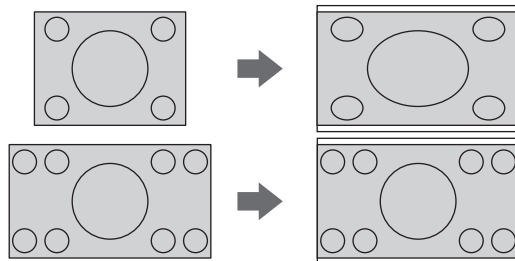

H-FIT

The 4:3/5:4 image will be stretched to the horizontal limit of the **SCREEN FORMAT** setting size with preserving original ratio and the vertical edge will be cropped.

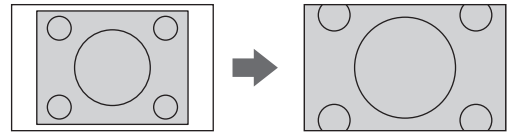

V-FIT

The 16:9 (16:10)/15:9 image will be stretched to the vertical limit of the **SCREEN FORMAT** setting size with preserving original ratio and the horizontal edge will be cropped.

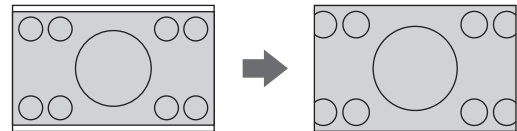

HV-FIT

The image will be stretched to the vertical and horizontal limit of the **SCREEN FORMAT** setting size without preserving original ratio and the vertical and horizontal edge will not be cropped.

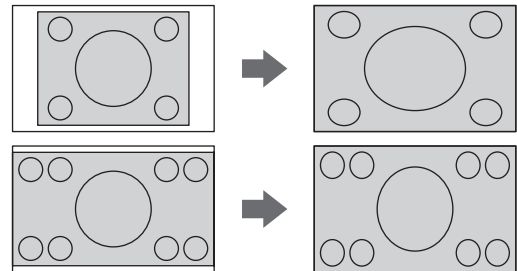

THROUGH

The image will be projected without any size adjustment.

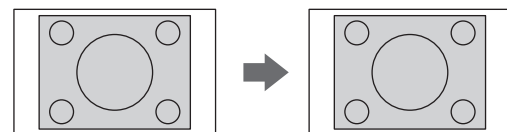

Menu items displaying pattern depends on signals

Signals	SCREEN FORMAT menu setting (See page 40)	
	16:10	16:9
VIDEO/S-VIDEO/YPbPr	4:3 ◀▶ 16:9 ◀▶ H-FIT ◀▶ HV-FIT ◀▶ THROUGH	4:3 ◀▶ H-FIT ◀▶ HV-FIT ◀▶ THROUGH
NTSC	AUTO ◀▶ 4:3 ◀▶ 16:9 ◀▶ H-FIT ◀▶ HV-FIT ◀▶ THROUGH	AUTO ◀▶ 4:3 ◀▶ H-FIT ◀▶ HV-FIT ◀▶ THROUGH
1 080/50i, 1 080/60i, 720/50p, 720/60p, 1 080/60p, 1 080/50p	16:9 ◀▶ V-FIT ◀▶ HV-FIT ◀▶ 4:3	Not available
COMPUTER	4:3 ◀▶ 16:9 ◀▶ H-FIT ◀▶ HV-FIT ◀▶ THROUGH	4:3 ◀▶ H-FIT ◀▶ HV-FIT
COMPUTER WXGA768, WIDE720, 1 080/60p, 1 080/50p	16:9 ◀▶ V-FIT ◀▶ HV-FIT ◀▶ 4:3	4:3 ◀▶ HV-FIT
WIDE signals except WXGA768, WIDE720, 1 080/60p, 1 080/50p	16:9 ◀▶ 4:3	4:3 ◀▶ HV-FIT

NOTE:

- If you project an image with an unmatched aspect ratio, the image may distort or some portions may be cropped. Select an aspect ratio which preserves the intention of the image creator.
- The order of **ASPECT** types is defined not only by the input method but also by the input signals. See “List of compatible signals” on page 54.
- If you project a copyrighted image enlarged or distorted by using **ASPECT** function in commercial use in a public place, such as a restaurant or hotel, you might infringe on the copyright of the creator which is protected by copyright law.
- Selectable aspect ratio options vary according to input signals.

FRAME LOCK

If the projected image is degraded, you can activate **FRAME LOCK** for synchronisation. Press ◀▶ to select the required option. (Available with **RGB/DVI** signals only)

- **OFF** Deactive
- **ON** Active

DISPLAY OPTION menu

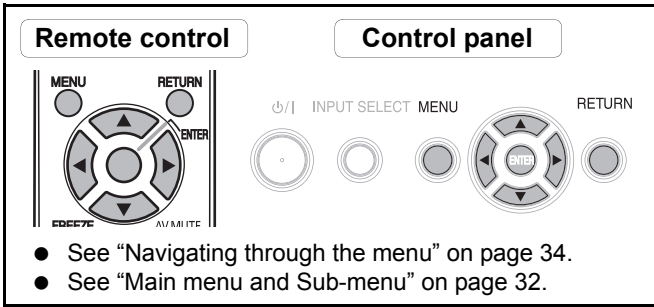

ON-SCREEN DISPLAY

INPUT GUIDE

When you change the input method, the guidance appears in the upper right corner of the screen. The following display methods are available. Press ◀ ▶ to cycle through the options.

Options	Function
DETAILED	Display the input method by graphic. The INPUT GUIDE will go out after 3 seconds without any operation. If you select any COMPUTER or DVI terminal which has no signal, the computer connection guidance will be displayed. See “Computer connection guidance” on page 56.
SIMPLE	Display the input method by text. The INPUT GUIDE will go out after 3 seconds without any operation.
OFF	Turn off the guidance.

OSD DESIGN

You can change the background colour of the menu. Press ◀ ▶ to select the required option.

TYPE1	Semi transparent black
TYPE2	Solid blue
TYPE3	Semi transparent dark blue

WARNING MESSAGE

You can let display only the minimum warning messages and hide others.

- **ON** All of the warning messages will be displayed.
- **OFF** Only the minimum warning messages will be displayed.

NOTE:

- When the **WARNING MESSAGE** is set to **OFF**, use the projector with utmost care due to the most of warning messages will not be displayed.

DVI-D IN

NOTE:

- The **DVI-D IN** setting for the best quality depends on the output equipment. Refer the instructions of the connected equipment.
- **DVI** signal is very sensitive, and malfunction may occur or other problems could be encountered with some **DVI** equipment.

DVI EDID

You can switch the EDID setting and signal level for variable **DVI** signals.

- **EDID1** 480p, 576p, 1 080/60i, 1 080/50i, 720/60p, 720/50p, 1 080/60p, 1 080/50p
- **EDID2(PC)** VGA60, SVGA60, XGA60, XGA70, XGA75, WXGA768/60, SXGA60, SXGA60+, WXGA800/60

DVI SIGNAL LEVEL

- **0-255:PC** (PC scale) For connecting to a computer via **DVI-D IN** terminal.
- **16-235** (TV scale) For connecting to AV equipment via **DVI-D IN** terminal, such as DVI - HDMI connection.

SCREEN SETTING

SCREEN FORMAT

Select the required screen format by pressing ◀ ▶.

- **16:10** When project on a 16:10 or 4:3 screen.
- **16:9** When project on a 16:9 screen.

SCREEN POSITION

You can change the displaying position of the menu. When **SCREEN FORMAT** is set to **16:10**, you can change the displaying position of the menu. Press ◀ ▶ to select the required option.

- **LOW** Displays the menu in the lower part of the screen.
- **CENTER** Displays the menu in the middle of the screen.
- **HIGH** Displays the menu in the upper part of the screen.

STARTUP LOGO

You can switch the logo on/off that is displayed when starting up the projector. Press ◀ ▶ to select the required option. **STARTUP LOGO** will be displayed for 30 seconds.

- **ON** Active
- **OFF** Deactive
- **USER** Display the original text

● Editing the original text

If you select **USER**, you can display the 2 lines of original text up to 40 characters in 1 line instead of the logo.

1. Select **USER** and press **ENTER**.
2. Select the required line to enter or edit the original text, and press the **ENTER** button.
3. Enter the characters and repeat until finish the line.
 - Use ▲ ▼ ◀ ▶ to specify the location of the required character, and press the **ENTER** button.
 - Move the cursor to **ALL DELETE** and press the **ENTER** button to delete all the entered text line.
 - Press the **DEFAULT** button to delete the last entered character or indicated with the cursor in the text line.
 - To insert a character in the entered text line, move the cursor to the text box to select the required place and press ▼ to select a character.
4. Select **OK** and press the **ENTER** button to set the entered text in a box.
 - Press ▼ and edit the **TEXT2** if you need to, and repeat the step 3.

AUTO SETUP

You can turn off the **AUTO SETUP** button function for when the **COMPUTER** signal is detected.

- **AUTO** When the projector detects a **COMPUTER** or **DVI** signal, adjust the projected image position automatically for **SHIFT**, **SIGNAL SEARCH**, **DOT CLOCK** and **CLOCK PHASE**.
- **BUTTON** Only when the **AUTO SETUP** button is pressed, the projected image position will be adjusted for **DOT CLOCK** and **CLOCK PHASE**. See "Remote control" on page 16.

NOTE:

- Usually the recommended setting is **AUTO**.

SIGNAL SEARCH

You can turn off the auto signal detecting system.

- **ON** Detect the input signal from the terminals and project the image.
- **OFF** Deactive

NOTE:

- **SIGNAL SEARCH** is not available when any input signal is projecting.
- Usually the recommended setting is **ON**.

BACK COLOR

You can choose a **BLUE** or **BLACK** screen for when the projector is idle. Press ◀ ▶ to select the required option.

WIDE MODE

When projecting **WIDE** signals, switch to **ON** to display the image in well adjusted size.

- **AUTO** Automatic detective system
- **OFF** For 4:3 signals
- **ON** For **WIDE** signals (16:9, 16:10 and 15:9)

SXGA MODE

You can switch the projection mode between **SXGA+** and **SXGA** for **SXGA** signals. Press ◀ ▶ to select the required option.

- **SXGA** Smaller setting
- **SXGA+** Larger setting

DISPLAY OPTION menu

OTHER FUNCTIONS

From menu operation, you can apply to the functions, which are only for the remote control.

Menu items	Refer
AUTO SETUP	See page 27.
FREEZE	See page 29.
AV MUTE	See page 29.
SIDE BY SIDE	See page 30.
INDEX-WINDOW	See page 29.
DIGITAL ZOOM	You can enlarge the projected image. Press ◀ ▶ to adjust the size, and press the ENTER button. Press the RETURN button to return to the normal projection.

PROJECTOR SETUP menu

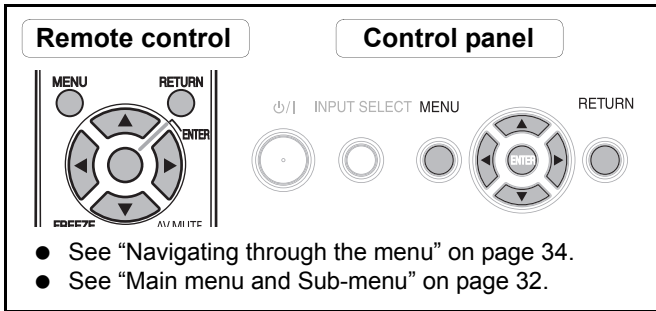

STATUS

You can see the status of the projector about the following items.

Items	Description
● SIGNAL	
NAME	Projecting signal name
FREQUENCY	Projecting signal frequency
● RUNTIME	
PROJECTOR	Duration of projector used time
LAMP	Duration of lamp used time
● REMAINING FILTER	
QUANTITY	Quantity of filter remaining
APPROX.TIME	Approximately time of filter remaining

NOTE:

- **QUANTITY** and **APPROX.TIME** of **REMAINING FILTER** is not the accurate but the calculated and predicted result based on the filter rolling pace. Incorrect remaining time could be displayed briefly; such as suddenly shortened or stays same for a while.
- Replacement of the Auto Cleaning Filter (ACF) needs to be prepared when the **QUANTITY** and **APPROX.TIME** of **REMAINING FILTER** becomes few.

COMPUTER2 SELECT

You can switch the function of the **COMPUTER2 IN/1 OUT** terminal.

- **INPUT** **COMPUTER2 IN**
- **OUTPUT** **COMPUTER1 OUT**

NO SIGNAL SHUT-OFF

You can set the timer to switch off the power of the projector after a certain period of time automatically when no signal is detected. Press ◀ ▶ to select the required period from 15 to 60 minutes at intervals of 5 minutes.

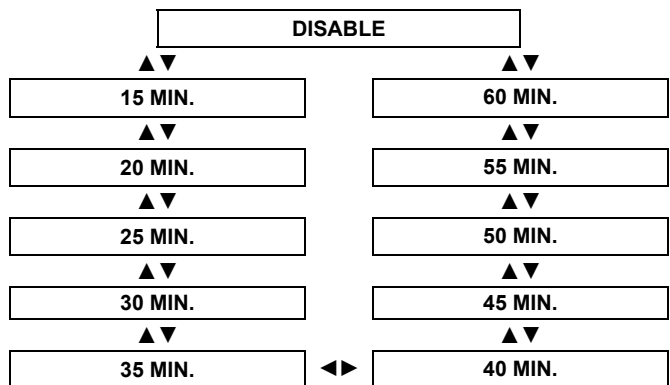

INITIAL START UP

You can select how the projector start when the mains lead is connected.

Options	Description
LAST MEMORY	Start as the same mode as the last switched off.
STANDBY	Always start in standby mode.
ON	Always start in projecting mode.

PROJECTOR SETUP menu

INSTALLATION

When installing the projector, select the projection method according to the projector position. Press ◀ ▶ to cycle through the options. See "Projection method" on page 18.

FRONT/DESK	Setting on a desk/floor and projecting from front
FRONT/CEILING	Mounting on the ceiling and projecting from front
REAR/DESK	Setting on a desk/floor and projecting from rear
REAR/CEILING	Mounting on the ceiling and projecting from rear

HIGH ALTITUDE MODE

If you use the projector at high elevation, the **HIGH ALTITUDE MODE** setting needs to be **ON** to set the fan speed high. Press ◀ ▶ to select the required option.

- **OFF** The fan speed is low.
- **ON** The fan speed is high.

NOTE:

- At 1 400 m (4 593 ft) above sea level, the setting must be **ON**.
- The loudness of fan noise depends on the **HIGH ALTITUDE MODE** setting.

EMULATE

You can switch to the Panasonic past model's control commands for COMPUTER connection.

DEFAULT	F100, FW100, F200, F300, FW300 models
D3500	D3500 models
D4000	D4000 models
D/W5K series	D5500, DW5000, D5600, DW5100, D5700 models
L730	L520, L720 models
L780	L750, L780 models
L735	L735 models
L785	L785 models
LB/W80	LB75, LB80, LW80 models

FUNCTION BUTTON

You can assign a certain menu function to the **FUNCTION** button as shortcut. Press ◀ ▶ to select the required menu option, and the **ENTER** button.

Options	Functions	Refer
DISABLE	Deactivate the FUNCTION button.	-
ASPECT	Display the ASPECT menu.	38
PICTURE MODE	Display the PICTURE MODE menu.	35
DAYLIGHT VIEW	Display the DAYLIGHT VIEW menu.	36

NOTE:

- Without any operation for 5 seconds, the displayed menu will be disappeared.

AUDIO SETTING

VOLUME

You can adjust the volume of the built-in monaural speaker and **VARIABLE AUDIO OUT** terminal.

- ◀ Decrease
- ▶ Increase

BALANCE

You can adjust to hear the sound played equally through both right and left from **VARIABLE AUDIO OUT**, or shift the balance so more sound plays through the left or right side.

- ◀ More sound plays through the left side
- ▶ More sound plays through the right side

IN STANDBY MODE

You can switch on/off the sound output in standby mode.

- **OFF** No sound in standby mode.
- **ON** Output audio in standby mode.

AUDIO IN SELECT

You can switch the audio output method for **COMPUTER1 IN**, **COMPUTER2 IN** and **DVI-D IN** terminals.

DVI

- **COM.AUDIO IN 2** Output audio that is input to the **COMPUTER AUDIO 2**.
- **AUDIO IN** Output audio that is input to the **AUDIO IN**.

COMPUTER1

- **COM.AUDIO IN 1** Output audio that is input to the **COMPUTER AUDIO 1**.
- **AUDIO IN** Output audio that is input to the **AUDIO IN**.

● COMPUTER2

● COM.AUDIO IN 2

Output audio that is input to the **COMPUTER AUDIO 2**.

● AUDIO IN

Output audio that is input to the **AUDIO IN**.

TEST PATTERN

You can use the 7 different test patterns to adjust the focus of the image. See "Lens shift and positioning" on page 19.

1. Press the **ENTER** button to display the test pattern 1.
2. Press ◀ ▶ to select the required test pattern.
3. Adjust the focus with the focus lever.
4. Press the **MENU** or **RETURN** button to return to the previous menu, or press repeatedly to escape from the menu mode.

NOTE:

- When the projector and/or the screen is tilted, adjust the focus at the centre of the image. The upper and lower edge might be out of focus.
- When the image is distorted in keystone, adjust the **KEYSTONE** in **POSITION** menu.

INITIALIZE ALL

You can reset all of the customised settings to the factory defaults except **NETWORK**, **RUNTIME** and **REMAINING FILTER** of **STATUS** in **PROJECTOR SETUP** menu.

1. Press the **ENTER** button.
2. Select **OK** by pressing ◀, then press the **ENTER** button.
3. Turn off the power by pressing the power button.
4. Switch off the **MAIN POWER** button to reset the projector.
5. Switch on the **MAIN POWER** button.
6. Press the power button.
7. The minimum required setting screen will be displayed.
 - See "Minimum required setting screen" on page 13.

NOTE:

- The security system is deactivated by default and when initialised.
- When the projector is initialised, it will be reset to the factory default password operation.

FILTER COUNTER RESET

After you replaced the Auto Cleaning Filter (ACF), **REMAINING FILTER** of **STATUS** in **PROJECTOR SETUP** need to be reset to "0".

1. Press the **ENTER** button for more than 3 seconds.
 - The confirmation screen will be displayed.
2. Select **OK** by pressing ◀, then press the **ENTER** button.
3. Display the **STATUS** and confirm the figure.

SECURITY menu

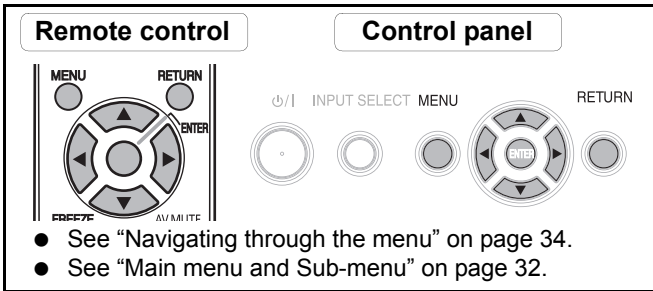

Entering the SECURITY menu

Every time when you apply to the **SECURITY** menu, you will be asked to perform the password operation.

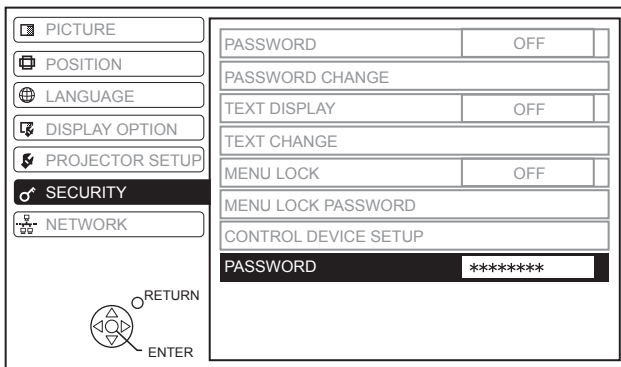

When you apply to the **SECURITY** menu before you change the password to your original, perform to input the following factory default password operation.

- Press ▲▶▼◀▲▶▼◀ and the **ENTER** button.

After you change the password

When you apply to the **SECURITY** menu after you change the password to your original in the **PASSWORD CHANGE** menu, input the original password operation.

NOTE:

- The factory default password is valid until you change the password in **PASSWORD CHANGE** menu.
- The entered password operations will appear as asterisks in the box.

PASSWORD

You can activate the security system and the password operation will be asked to perform when the projecting mode started. Unless you perform the correct password operation, all of the button controls will be disabled except the power button.

- **OFF** Deactive
- **ON** Active

NOTE:

- When you activated the security system, make sure to change the password to your original for safety.
- The factory default password is valid until you change the password in **PASSWORD CHANGE** menu.

PASSWORD CHANGE

You can change the password operation to your original.

1. Press a series of button operation up to 8 as a password by using ▲▼◀▶.
2. Press the **ENTER** button.
3. Press the exact same series of button operation you entered in the **NEW** password box for confirmation.
 - If a series of button operation is incorrect, you will be asked to perform again.
4. Press the **ENTER** button.

NOTE:

- The entered password operations will appear as asterisks in the box.

TEXT DISPLAY

You can set your original text, such as company name or URL information, to display regularly at the bottom of the projected image while projecting.

- **OFF** Deactive
- **ON** Active

TEXT CHANGE

You can enter your original text up to 22 characters for **TEXT DISPLAY**.

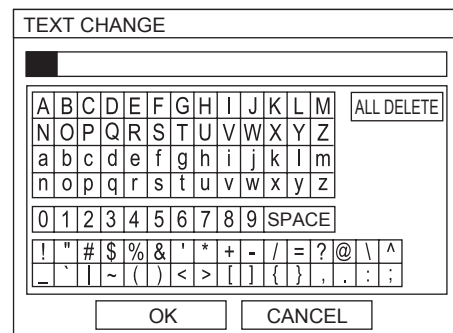

1. Enter your original text.
 - Use ▲▼◀▶ to specify the location of the required character.
 - Move the cursor to **ALL DELETE** and press the **ENTER** button to delete all the entered text line.
 - Press the **DEFAULT** button to delete the last entered character or indicated with the cursor in the text line.
 - To insert a character in the entered text line, move the cursor to the text box to select the required place and press ▼ then perform step 2.
2. Press the **ENTER** button.
 - The selected character will be displayed in the **TEXT CHANGE** box.
3. Repeat until finish your original text.
4. Select **OK** and press the **ENTER** button to set the entered text.
 - Select **CANCEL** or press the **MENU/RETURN** buttons to return to the previous menu.

MENU LOCK

You can lock the **MENU** button function and the password will be asked to display the menu every time.

- **OFF** Deactivate the **MENU LOCK** system.
- **ON** Activate the **MENU LOCK** system.

NOTE:

- The factory default password is “AAAA”.
- The factory default password is valid until you change the password in **MENU LOCK PASSWORD** menu.
- When the projector is initialised, the **MENU LOCK** will be deactivated.

MENU LOCK PASSWORD

You can change the password for **MENU LOCK** system to your original.

1. Press the **ENTER** button.
2. Enter the original password.
 - Use **▲ ▼ ◀ ▶** to specify the location of the required character, and press the **ENTER** button.

MENU LOCK PASSWORD

█

A	B	C	D	E	F	G	H	I	J	K	L	M	ALL DELETE		
N	O	P	Q	R	S	T	U	V	W	X	Y	Z			
a	b	c	d	e	f	g	h	i	j	k	l	m			
n	o	p	q	r	s	t	u	v	w	x	y	z			
0	1	2	3	4	5	6	7	8	9	SPACE					
!	"	#	\$	%	&	'	*	+	-	/	=	?@	\	^	
_	`		~	()	<	>	[]	{	}	,	.	:	;

OK CANCEL

3. Repeat step 2 until you finish the text line.
 - You can enter up to 16 characters.
 - Move the cursor to **ALL DELETE** and press the **ENTER** button to delete all the entered text line.
 - Press the **DEFAULT** button to delete the last entered character or indicated with the cursor in the text line.
 - To insert a character in the entered text line, move the cursor to the text box to select the required place and press **▼** then perform step 2.
4. Select **OK** and press the **ENTER** button to set the password.

CONTROL DEVICE SETUP

NOTE:

- If you disable both of the control panel and remote control buttons, you cannot return to the standby mode. Use this function with utmost care.
- If you press a disabled button, you will be asked to perform the security password operation. The password screen will disappear after 10 seconds without any operation.

CONTROL PANEL

You can disable the control panel buttons on the projector body. Press **◀** or **▶** to switch the option.

- **ENABLE** Enable the control panel buttons.
- **DISABLE** Disable the control panel buttons. The confirmation screen will be displayed. Select **OK** by pressing the **◀**, and the **ENTER** button.

NOTE:

- You can enable the disabled control panel buttons by performing the control panel button operation. While pressing the **ENTER** button, press the **MENU** button for 2 seconds.

REMOTE CONTROLLER

You can disable the remote control buttons. Press **◀** or **▶** to switch the option.

- **ENABLE** Enable the remote control buttons.
- **DISABLE** Disable the remote control buttons. The confirmation screen will be displayed. Select **OK** by pressing the **◀**, and the **ENTER** button.

NETWORK menu

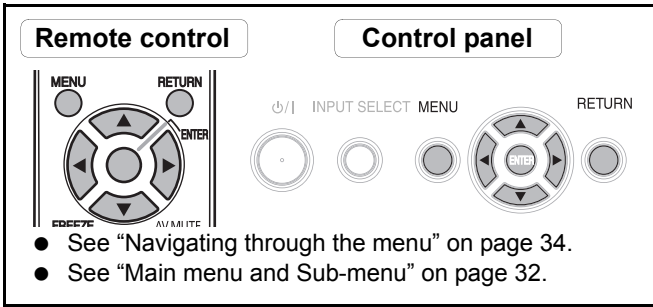

NOTE:

- See more detailed instructions in the contents of the **CD-ROM** which is provided with the projector.

Items in NETWORK menu

In **NETWORK** menu, the following items are available.

- **WIRED LAN**
- **WIRELESS LAN** (PT-FW300NTE only)
- **NAME CHANGE**
- **PASSWORD**
- **PASSWORD CHANGE**
- **NETWORK STANDBY**
- **NETWORK CONTROL**
- **LIVE MODE CUT IN**
- **COMPUTER SEARCH**
- **MULTI-LIVE**
- **STATUS**
- **INITIALIZE**

NOTE:

- When you activated the security system in **SECURITY** menu, you need to perform the security password operation to initialise via network.

TEMP, LAMP and FILTER Indicators

Managing the indicated problems

If a problem should occur with the projector, the **TEMP**, **LAMP** and/or **FILTER** indicators will inform you. Manage the indicated problems as follow.

1. Confirm the status of all indicators and projector, and switch off the projector in proper way.
2. Find out the cause of the problem by status of the **TEMP**, **LAMP** and/or **FILTER** indicators.
3. Follow the instruction for each indication below and solve the problem.
4. Turn on the projector in the correct way and confirm the indicator is not indicating a problem any longer.

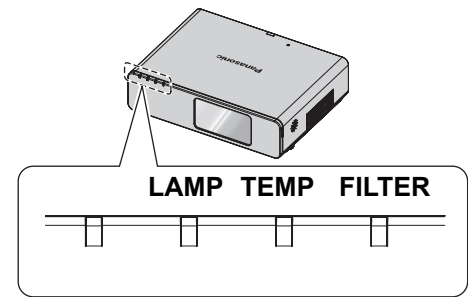

NOTE:

- If no problem is found or the problem remains, do not turn on the projector. Instead contact an Authorised Service Centre.

LAMP indicator

Indicator	● Illuminating red	● Flashing red		
Problem	RUNTIME of STATUS in the PROJECTOR SETUP menu has reached 5 000 hours.	LAMP circuit failure, abnormal function or lamp unit is damaged.		
Cause	Lamp unit will run out soon and needs to be replaced.	The MAIN POWER is switched on again before the lamp unit is cooled enough.	Lamp circuit failure, abnormal function.	Lamp unit is damaged.
Remedy	See "Replacing the Lamp unit" on page 50.	Let the lamp unit cool down and turn on the MAIN POWER after 90 seconds.	Contact an Authorised Service Centre.	See "Replacing the Lamp unit" on page 50.

TEMP indicator

Indicator	● Illuminating red while projecting and the alert will be displayed. ● Flashing red and power is turned off		
Problem	The temperature inside and/or outside the projector is abnormally high.		
Cause	The ventilation openings are covered.	The room temperature is too high.	The projector is located at high elevations (above 1 400 - 2 700 m).
Remedy	Remove the object(s) from the ventilation openings or clear around the projector.	Reinstall the projector in temperature controlled place. See page 60.	Turn on the projector* ¹ and set the HIGH ALTITUDE MODE to ON . See page 44.

*1. The projector will perform only 2 minutes with OFF setting at high elevation.

FILTER indicator

When the **FILTER** indicator is flashing green, the Auto Cleaning Filter (ACF) is normally rolling up.

Indicator	● Illuminating red	● Flashing red	● Flashing orange	● Illuminating orange
Problem	REMAINING FILTER has turned red. See page 43.	Detect no ACF or abnormal ACF.	The ACF cannot operate properly.	REMAINING FILTER has turned yellow. See page 43.
Cause	ACF has been run out.	ACF is not attached or the attached ACF is dysfunctional.	Foreign object is blocking the ACF operation.	ACF is running out.
Remedy	See "Replacing the Auto Cleaning Filter (ACF)" on page 51.	Attach the ACF or replace to new ACF.	Remove the foreign object or contact an Authorised Service Centre.	Prepare the ACF for replacement.

Care and Replacement

Cleaning the projector

Before cleaning the projector

- Switch off the **MAIN POWER** and disconnect the mains plug from the mains socket.
- Unplug all the cables from the projector.

Cleaning the outer surface of the projector

Wipe off dirt and dust gently with a soft cloth.

- If it is difficult to remove the dirt, soak a cloth with water, wring the cloth well and then wipe the projector. Dry off the projector with dry cloth.
- If you use a chemical treated wipe, follow the instructions supplied with it.

Cleaning the lens and front glass surface

Wipe off dirt and dust gently with a lint-free cloth.

- Make sure no dirt or dust remains on the surface of the lens. It will be enlarged and projected onto a screen.

Replacing the Lamp unit

Before replacing the Lamp unit



- Switch off the **MAIN POWER** and disconnect the mains plug from the mains socket.
- Wait for more than 1 hour and make sure the lamp unit and the surroundings are cooled enough.
- Prepare a Phillips-head screwdriver.
- Contact an Authorised Service Centre to purchase a replacement lamp unit (ET-LAF100).
- When the projector is mounted on the ceiling, do not work directly under the projector or put your face closer to the projector.

NOTE:

- Prior to replacing the lamp unit, allow it to cool down to prevent the risk of burns, damage and other hazards.
- Do not attempt replacement with an unauthorised lamp unit.

When to replace the lamp unit

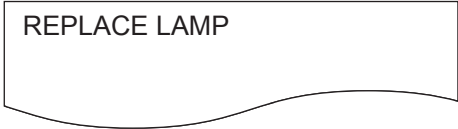
The lamp unit is consumable and the brightness decreases by duration of usage. The **LAMP** indicator will inform you of the replacement timing at 5 000 hours, and at 6 000 hours, the projector will be turned off. Those figures are rough guidance and might be shortened by the usage conditions, characteristics of the lamp unit, environmental conditions, and so on. You can check the duration of usage time using **RUNTIME** of **STATUS** in the **PROJECTOR SETUP** menu.

Indication	On screen	LAMP indicator
		
Over 5 000 hours	"REPLACE LAMP" is displayed on the upper left of the screen for 10 minutes.	Illuminates red.
Over 6 000 hours	"REPLACE LAMP" is displayed on the upper left of the screen, and it will stay until you respond. To clear the screen, press any button.	

NOTE:

- The guide times, 5 000 and 6 000 hours, are rough estimates based on certain conditions and are not a guaranteed time.
- For more information about the lamp unit, such as guaranteed time, see the instructions which is provided with the lamp unit.

Replacement procedure

Removing and replacing the lamp unit

1. Use a Phillips-head screwdriver to loosen the 2 lamp unit cover fixing screws on the back of the projector until the screws turn freely, and remove the lamp unit cover.

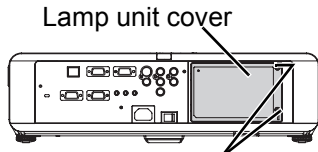

Lamp unit cover fixing screws

2. Use a Phillips-head screwdriver to loosen the 2 lamp unit fixing screws.
3. Hold the handles of the lamp unit and release the lamp unit lock.
4. Pull the used lamp unit gently from the projector.

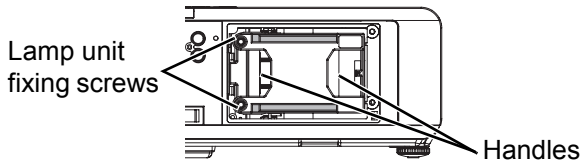

5. Replace the new lamp unit in correct direction.
 - **RUNTIME** of **STATUS** in the **PROJECTOR SETUP** menu will be reset to "0" automatically.

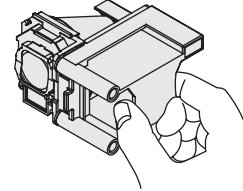

6. Press in the lamp unit until it clicks and make sure the unit is installed securely.
7. Tighten the 2 lamp unit fixing screws securely with a Phillips-head screwdriver.

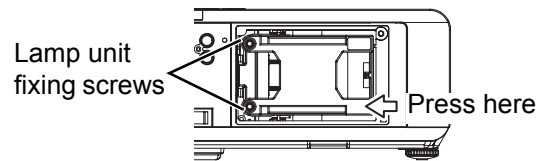

8. Attach the lamp unit cover and tighten the 2 lamp unit cover fixing screws securely with a Phillips-head screwdriver.

Replacing the Auto Cleaning Filter (ACF)

Before replacing the ACF

- Wait until the cooling fan stops and the power indicator turn to red.
- Disconnect the mains lead from the mains socket.
- Prepare a Phillips-head screwdriver.
- Contact an Authorised Service Centre to purchase a replacement ACF (ET-ACF100).

When to replace the ACF

ACF is consumable product and effects on ventilation. The **FILTER** indicator will inform you of the replacement timing. You can check the remaining amount of the ACF in **REMAINING FILTER** of **STATUS** in **PROJECTOR SETUP** menu.

NOTE:

- See "WARNING MESSAGE" on page 40.
- See "REMAINING FILTER" on page 43.
- See "FILTER indicator" on page 49.
- The ACF operational sound may be heard.
- While the ACF is operating, the **FILTER** indicator will flash in green.
- When the **FILTER** indicator illuminate in orange, the remaining time of the ACF is less than 200 hours. This is rough estimated time and it depends on environment of usage. Contact an Authorised Service Centre to purchase a replacement ACF.
- If you use the projector at 1 400 m (4 593 ft) above sea level, it may cause malfunction of the ACF.
- If you keep using the projector after the **FILTER** indicator illuminating in red, the indicator will start to flash in red for 10 minutes and the projector will be switched off.

Care and Replacement

Replacement procedure

1. Turn the projector upside down and place it gently on a soft cloth.
2. Use a Phillips-head screwdriver to loosen 3 ACF cover fixing screws until the screws turn freely and remove the ACF cover.

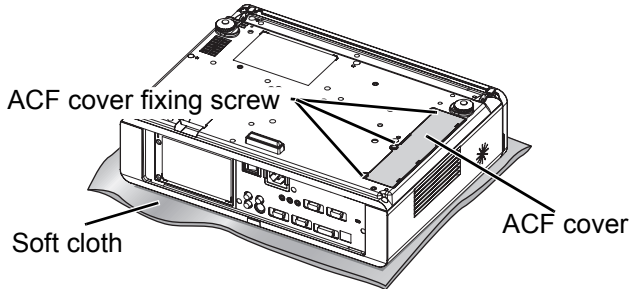

3. Release the lock by pushing in the lock clamp to inside, and slide out the ACF unit from the projector slowly.
4. Insert the new ACF unit into the compartment in correct direction and slightly push down until it clicks. Tighten an ACF fixing screw securely with a Phillips-head screwdriver.
5. Attach the ACF cover and tighten the ACF cover fixing screws securely with a Phillips-head screwdriver.

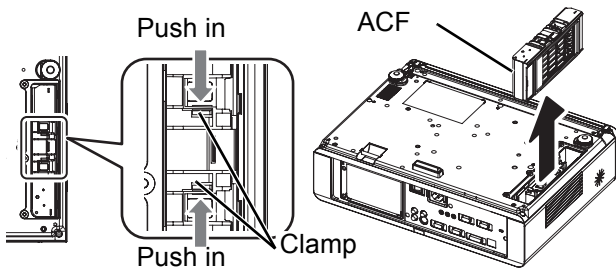

Resetting the REMAINING FILTER

1. Turn on the projector and display the **FILTER COUNTER RESET** in **PROJECTOR SETUP**.
2. Press the **ENTER** button for more than 3 seconds.
 - The confirmation screen will be displayed.
3. Select **OK** by pressing **◀**, then press the **ENTER** button.
4. Display the **STATUS** and confirm the figure.

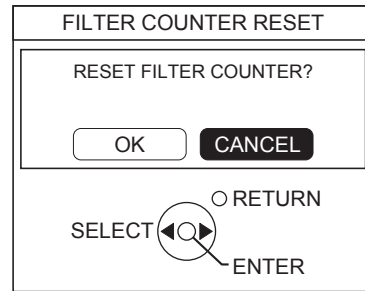

NOTE:

- If the ACF and/or ACF cover are attached incorrectly, the projector may not be turned on.
- Do not switch the power on while the ACF cover removed.
- When you replace the ACF unit, clean the compartment and/or the air exhaust port if you need to.
- The replacement timing of the ACF is 36 000 hours of use at maximum and it depends on environment of usage.

Troubleshooting

Should any problem persist, contact your dealer.

Problem	Cause	Reference page
Power does not turn on.	● The mains lead may not be connected.	23
	● The MAIN POWER switch is turned off.	25
	● No electric supply is at the mains socket.	23
	● TEMP indicator is lit or flashes.	49
	● LAMP indicator is lit or flashes.	49
	● The lamp unit cover has not been securely installed.	51
	● The circuit breakers have tripped.	-
No picture appears.	● The video signal input source may not be connected to a terminal properly.	22
	● The input selection setting may not be correct.	28
	● The BRIGHTNESS adjustment setting may be at the minimum setting.	35
	● The AV MUTE function may be in use.	29
The picture is fuzzy.	● The lens focus may not have been set correctly.	26
	● The projector may not be at the correct distance from the screen.	17
	● The lens may be dirty.	11
	● The projector may be tilted too much.	19
The colour is pale or greyish.	● COLOR or TINT adjustment may be incorrect.	35
	● The input source which is connected to the projector may not be adjusted correctly.	32
No sound can be heard from the internal speaker.	● The audio signal source may not be connected properly.	21
	● A cable may be connected to the VARIABLE AUDIO OUT terminal.	15
	● The volume adjustment may be at the lowest possible setting.	31
The control buttons of the projector do not operate.	● CONTROL PANEL of CONTROL DEVICE SETUP in SECURITY menu is disabled. If you have a loss of the remote control while the CONTROL PANEL is disabled, press and hold the MENU button for 2 seconds with pressing the ENTER button.	47
The remote control does not operate.	● REMOTE CONTROLLER of CONTROL DEVICE SETUP in SECURITY menu is disabled.	47
	● The batteries may be weak.	-
	● The batteries may not have been inserted correctly.	16
	● The remote control signal receptor on the projector may be obstructed.	27
	● The remote control unit may be out of the operation range.	27
The picture does not display correctly.	● The signal format (TV-SYSTEM) may not have been set correctly.	36
	● There may be a problem with the VCR or other signal source.	-
	● A signal which is not compatible with the projector is being input.	54
Picture from a computer does not appear.	● The cable may be longer than the optional cable.	-
	● The external video output from a laptop computer may not be correct. (You may be able to change the external output settings by pressing the [Fn] + [F3] or [Fn] + [F10] keys simultaneously. The actual method varies depending on the type of computer; refer to the documentation provided with your computer for further details.)	56
	● COMPUTER2 SELECT setting in PROJECTOR SETUP menu is not correct.	43
Picture from a computer DVI-D graphic board does not appear.	● The graphic board driver of the computer needs to be updated to the latest version.	-
	● DVI-D IN setting in DISPLAY OPTION menu may be incorrect setting.	40
	● The computer may need to be restarted after switching DVI-D IN setting in DISPLAY OPTION menu of the projector correctly.	-

Technical Information

List of compatible signals

Mode	Display resolution (dots) ^{*1}	Scanning frequency		Dot clock frequency (MHz)	Picture quality ^{*2}	PnP			Format ^{*3}
		H (kHz)	V (Hz)			RGB2	DVI-D EIDI1	DVI-D EIDI2	
NTSC/NTSC 4.43/ PAL-M/PAL60	720 x 480i	15.7	59.9	-	A				V/S
PAL/PAL-N/SECAM	720 x 576i	15.6	50.0	-	A				
525i (480i)	720 x 480i	15.7	59.9	13.5	A				C/Y
625i (576i)	720 x 576i	15.6	50.0	13.5	A				
525p (480p)	720 x 483	31.5	59.9	27.0	A		●		
625p (576p)	720 x 576	31.3	50.0	27.0	A		●		
1 125 (1 080)/60i	1 920 x 1 080i	33.8	60.0	74.3	A		●		
1 125 (1 080)/50i	1 920 x 1 080i	28.1	50.0	74.3	A		●		
1 125 (1 080)/60p	1 920 x 1 080	66.6	59.9	138.5	A				D/C/Y
1 125 (1 080)/50p	1 920 x 1 080	55.6	49.9	141.5	A				
1 125 (1 080)/60p	1 920 x 1 080p	67.5	60.0	148.5	A		●		
1 125 (1 080)/50p	1 920 x 1 080p	56.3	50.0	148.5	A		●		
750 (720)/60p	1 280 x 720	45.0	60.0	74.3	AA		●		
750 (720)/50p	1 280 x 720	37.5	50.0	74.3	AA		●		
VESA	640 x 400	31.5	70.1	25.2	A				C
	640 x 400	37.9	85.1	31.5	A				
VGA	640 x 480	31.5	59.9	25.2	A	●		●	D/C
	640 x 480	35.0	66.7	30.2	A	●			
	640 x 480	37.9	72.8	31.5	A	●			
	640 x 480	37.5	75.0	31.5	A	●			C
	640 x 480	43.3	85.0	36.0	A				
SVGA	800 x 600	35.2	56.3	36.0	A	●			
	800 x 600	37.9	60.3	40.0	A	●		●	D/C
	800 x 600	48.1	72.2	50.0	A	●			
	800 x 600	46.9	75.0	49.5	A	●			C
MAC	832 x 624	53.7	85.1	56.3	A				
XGA	832 x 624	49.7	74.6	57.3	A	●			
	1 024 x 768	39.6	50.1	51.9	A				
	1 024 x 768	48.4	60.0	65.0	A	●		●	D/C
	1 024 x 768	56.5	70.1	75.0	A	●		●	
	1 024 x 768	60.0	75.0	78.8	A	●		●	
MXGA	1 024 x 768	68.7	85.0	94.5	A				
	1 152 x 864	64.0	71.2	94.2	A	●			
	1 152 x 864	67.5	74.9	108.0	A				
MAC	1 152 x 864	76.7	85.0	121.5	A				C
	1 152 x 870	68.7	75.1	100.0	A	●			
MSXGA	1 280 x 960	60.0	60.0	108.0	A	●			
SXGA	1 280 x 1 024	64.0	60.0	108.0	A			●	D/C
	1 280 x 1 024	80.0	75.0	135.0	A	●			
	1 280 x 1 024	91.1	85.0	157.5	B				C
SXGA60+	1 400 x 1 050	64.0	60.0	108.0	A				
	1 400 x 1 050	65.1	59.9	122.4	A	●		●	D/C
UXGA	1 600 x 1 200	75.0	60.0	162.0	B	●			
WIDE750 (720)	1 280 x 720	44.8	59.9	74.5	AA	●			C
	1 280 x 720	37.1	49.8	60.5	AA				
WXGA768 ^{*4}	1 280 x 768	39.6	49.9	65.3	AA				
	1 280 x 768	47.8	59.9	79.5	AA	●		●	D/C
WXGA800 ^{*4}	1 280 x 800	41.3	50.0	68.0	AA				
	1 280 x 800	49.1	60.2	69.1	AA				C
	1 280 x 800	49.7	59.8	83.5	AA	●		●	D/C
WXGA+	1 440 x 900	55.9	59.9	106.5	A	●			
WSXGA+	1 680 x 1 050	65.3	60.0	146.3	A	●			C
WUXGA	1 920 x 1 200	74.6	59.9	154.0	B				

*1. The "i" appearing after the resolution indicates an interlaced signal.

*2. The following symbols are used to indicate picture quality.

AA Maximum picture quality can be obtained.

A Signals are converted by the image processing circuit before picture is projected.

B Some loss of data occurs to make projection easier.

*3. The following symbols are used to indicate the format.

V = VIDEO, S = S-VIDEO, D = DVI, C = COMPUTER, Y = YPBPR

*4. The best signal for 16:10 is WXGA800, 16:9 is WXGA768.

Serial terminal

The serial connector which is on the connector panel of the projector conforms to the RS-232C interface specification, so that the projector can be controlled by a personal computer which is connected to this connector.

Connection

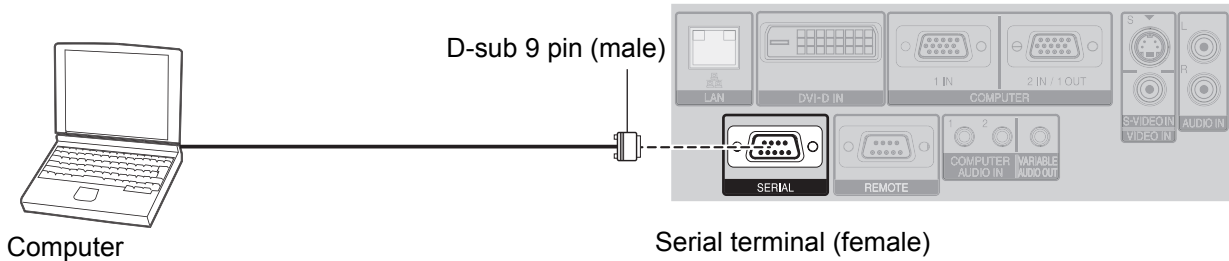

Pin assignments and signal names

	Pin No.	Signal name	Contents
	①		NC
	②	TXD	Transmitted data
	③	RXD	Received data
	④		NC
	⑤	GND	Earth
	⑥		NC
	⑦	RTS	Connected internally
	⑧	CTS	
	⑨		NC

Communication settings

Signal level	RS-232C	Character length	8 bits
Sync. method	Asynchronous	Stop bit	1 bit
Baud rate	9 600 bps	X parameter	None
Parity	None	S parameter	None

Basic format

STX	Command	:	Parameter	ETX
Start byte (02h)	3 bytes	1 byte	1 byte - 4 bytes	End (03h)

The data streaming from the computer will start with STX, and proceed to Command, Parameter and end with ETX. You can add the required parameter.

- The projector can not receive any command for 10 seconds after the lamp is switched on. Wait 10 seconds before sending the command.
- If sending multiple commands, check that a response has been received from the projector for one command before sending the next command.
- When a command which does not require parameters to be sent, the colon (:) is not required.
- If an incorrect command is sent from the personal computer, the ER401 command will be sent from the projector to the personal computer.

Technical Information

Cable specifications

(When connected to a personal computer)

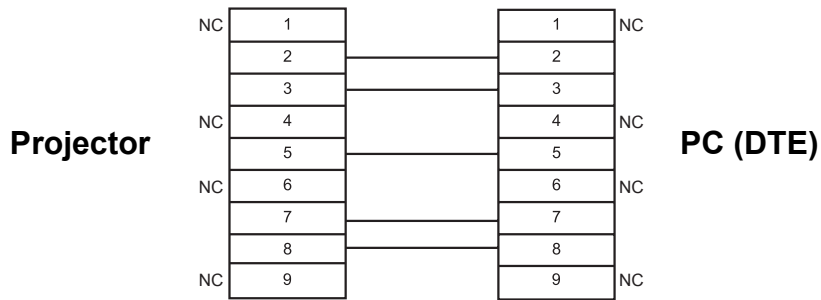

Control commands

Command	Control contents	Remarks
PON	Power ON	In standby mode, all commands other than the PON command are ignored. ● The PON command is ignored during lamp ON control.
POF	Power OFF	If a PON command is received while the cooling fan is operating after the lamp has switched off, the lamp is not turned back on again straight away in order to protect the lamp.
AVL	Volume	Parameter 000 - 063 (Adjustment value 0 - 63)
IIS	INPUT	Parameter: VID = VIDEO RG1 = COMPUTER1 DVI = DVI SVD = S-VIDEO RG2 = COMPUTER2 NWP = NETWORK
Q\$\$	Lamp condition query	Call back 0 = Standby 1 = Lamp ON control active 2 = Lamp ON 3 = Lamp OFF control active
OSH	AV MUTE	Turning off the projection and sound temporarily. Send the command to switch between ON and OFF. Do not send the command consecutively.

Computer connection guidance

You can switch the signals which to output from the **COMPUTER1 OUT** terminal by pressing the computer key command. The key commands are depend on the manufactures. If you select the computer terminals which has no signals while the **INPUT GUIDE** is set to **DETAILED**, the computer connection guidance will be displayed.

Manufacturer	Key command	Manufacturer	Key command	Manufacturer	Key command
Panasonic NEC	Fn + F3	TOSHIBA SHARP HP	Fn + F5	IBM SONY	Fn + F7
				Apple	F7
FUJITSU	Fn + F10	EPSON DELL	Fn + F8	Others	Fn +

NOTE:

- The computer connection guidance will disappear after 5 minutes.
- Please refer the instructions which provided with the computers for more detailed information.

REMOTE terminal

You can remotely operate the projector from the outside the remote control range by connecting to the **REMOTE** terminal.

Pin assignments and signal names

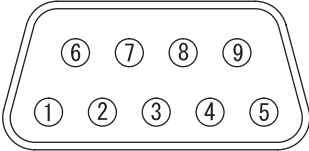
	Pin No.	Signal name	Contents
	①	GND	Ground
	②	POWER	POWER ON
	③	INPUT SEL3	Select input signal 3
	④		NC
	⑤	INPUT SEL1	Select input signal 1
	⑥	INPUT SEL2	Select input signal 2
	⑦		Connect internally
	⑧		
	⑨	ENABLE	Control by external contact

LAMP switching

Pin No.	Settings	
② - ①	Short	Open
Operation	On	Off

Switching input signals

Pin No.	Settings					
③ - ①	Open	Open	Open	Short	Short	Open
⑤ - ①	Open	Short	Open	Open	Short	Short
⑥ - ①	Open	Open	Short	Open	Open	Short
Input signal	COMPUTER1	COMPUTER2	DVI	VIDEO	S-VIDEO	NETWORK

NOTE:

- When pin ① and pin ⑨ are short-circuited, the buttons on the projector's control panel, power and **INPUT SELECT** buttons on the remote control cannot be used. In addition, the RS-232C commands and network functions that correspond to these functions cannot be used either.
- While pin ⑨ is "Open", do not short-circuit pin ①, ②, ③, ⑤ and ⑥. The projector would reject all the signals from the remote control.

DVI-D IN terminal

Pin assignments and signal names

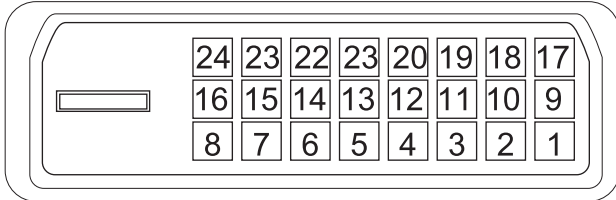

Pin No.	Signal name	Pin No.	Signal name
1	TMDS Data 2-	13	
2	TMDS Data 2+	14	+5V
3	TMDS Data 2/4 shield	15	GND
4		16	Hot Plug Detect
5		17	TMDS Data 0-
6	DDC clock	18	TMDS Data 0+
7	DDC data	19	TMDS Data 0/5 shield
8		20	
9	TMDS Data 1-	21	
10	TMDS Data 1+	22	TMDS clock shield
11	TMDS Data 1/3 shield	23	TMDS clock+
12		24	TMDS clock-

Ceiling mount bracket safeguards

The projector and the ceiling mount bracket are designed sufficiently safety though, make sure the safety cable provided with the projector is installed and attached to the bottom of the projector when mounting on the ceiling for safety and security.

NOTE:

- Even if it is guarantee period, the manufacturer is not responsible for any hazard or damage caused by using a ceiling mount bracket which is not purchased from an authorised distributors, or environmental conditions.
- Make sure to use a torque driver and do not use an electrical screwdriver or an impact screwdriver.
- Installation work of the ceiling mount bracket should only be carried by a qualified technician.
- Remove an unused ceiling mount bracket promptly.

Installing the safety cable

1. Install the ceiling mount bracket according to the installation instructions.
2. Loop the security cable around the ceiling mount bracket with less slack.
 - Lace the cable of the end with a latch through the loop on the other end of the cable.
3. Attach the latch on to the bottom of the projector with a provided screw.
 - Torque: 1.25 ± 0.2 N·m

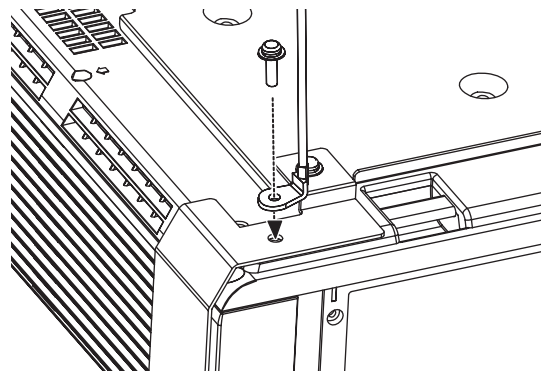
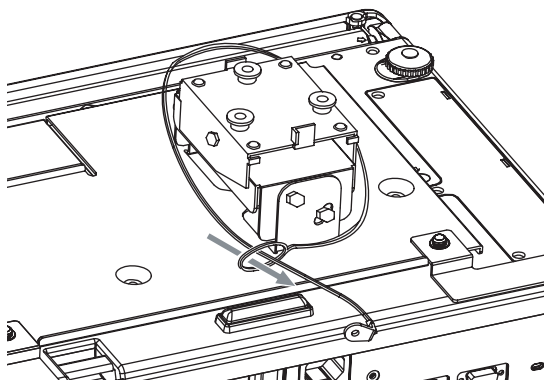

* Indicated sample above is ET-PKF100S.

Screen size and throw distance for 16:9 aspect ratio

All measurements and the calculation results below are approximate and may differ slightly from the actual measurements.

Projection size (16 : 9)			Throw distance (L)	
Screen diagonal (SD)	Screen height (SH)	Screen width (SW)	Minimum distance (LW)	Maximum distance (LT)
33" (0.84 m)	0.41 m (1'4")	0.73 m (2'4")		1.9 m (6'2")
40" (1.02 m)	0.50 m (1'7")	0.89 m (2'11")	1.2 m (3'11")	2.3 m (7'6")
50" (1.27 m)	0.62 m (2')	1.11 m (3'7")	1.5 m (4'11")	2.9 m (9'6")
60" (1.52 m)	0.75 m (2'5")	1.33 m (4'4")	1.7 m (5'6")	3.5 m (11'5")
70" (1.78 m)	0.87 m (2'10")	1.55 m (5'1")	2.0 m (6'6")	4.1 m (13'5")
80" (2.03 m)	1.00 m (3'3")	1.77 m (5'9")	2.3 m (7'6")	4.7 m (15'5")
90" (2.29 m)	1.12 m (3'8")	1.99 m (6'6")	2.6 m (8'6")	5.3 m (17'4")
100" (2.54 m)	1.25 m (4'1")	2.21 m (7'3")	2.9 m (9'6")	5.9 m (19'4")
120" (3.05 m)	1.49 m (4'10")	2.66 m (8'8")	3.5 m (11'5")	7.1 m (23'3")
150" (3.81 m)	1.87 m (6'1")	3.32 m (10'10")	4.4 m (14'5")	8.8 m (28'10")
200" (5.08 m)	2.49 m (8'2")	4.43 m (14'6")	5.9 m (19'4")	11.8 m (38'8")
250" (6.35 m)	3.11 m (10'2")	5.53 m (18'1")	7.4 m (24'3")	14.7 m (48'2")
300" (7.62 m)	3.74 m (12'3")	6.64 m (21'9")	8.9 m (29'2")	17.7 m (58')

Calculation methods

$$SW (m) = SD (") \times 0.0221$$

$$SH (m) = SD (") \times 0.0125$$

$$LW (m) = 0.0297 \times SD (") - 0.045$$

$$LT (m) = 0.0592 \times SD (") - 0.061$$

Screen size and throw distance for 4:3 aspect ratio

All measurements and the calculation results below are approximate and may differ slightly from the actual measurements.

Projection size (4 : 3)			Throw distance (L)	
Screen diagonal (SD)	Screen height (SH)	Screen width (SW)	Minimum distance (LW)	Maximum distance (LT)
33" (0.84 m)	0.50 m (1'7")	0.67 m (2'2")		2.1 m (6'10")
40" (1.02 m)	0.61 m (2')	0.81 m (2'7")	1.3 m (4'3")	2.6 m (8'6")
50" (1.27 m)	0.76 m (2'5")	1.02 m (3'4")	1.6 m (5'2")	3.2 m (10'5")
60" (1.52 m)	0.91 m (2'11")	1.22 m (4')	1.9 m (6'2")	3.9 m (12'9")
70" (1.78 m)	1.07 m (3'06")	1.42 m (4'7")	2.3 m (7'6")	4.5 m (14'9")
80" (2.03 m)	1.22 m (4')	1.63 m (5'4")	2.6 m (8'6")	5.2 m (17')
90" (2.29 m)	1.37 m (4'5")	1.83 m (6')	2.9 m (9'6")	5.8 m (19')
100" (2.54 m)	1.52 m (4'11")	2.03 m (6'7")	3.2 m (10'5")	6.5 m (21'3")
120" (3.05 m)	1.83 m (6')	2.44 m (8')	3.9 m (12'9")	7.8 m (25'7")
150" (3.81 m)	2.29 m (7'6")	3.05 m (10')	4.9 m (16')	9.8 m (32'1")
200" (5.08 m)	3.05 m (10')	4.06 m (13'3")	6.5 m (21'3")	13.0 m (42'7")
250" (6.35 m)	3.81 m (12'6")	5.08 m (16'8")	8.2 m (26'10")	16.3 m (53'5")
300" (7.62 m)	4.57 m (14'11")	6.10 m (20')	9.8 m (32'1")	19.5 m (63'11")

Calculation methods

$$SW (m) = SD (") \times 0.0203$$

$$SH (m) = SD (") \times 0.0152$$

$$LW (m) = 0.0339 \times SD (") - 0.052$$

$$LT (m) = 0.0653 \times SD (") - 0.052$$

Technical Information

Specifications

Power supply		AC 100 - 240 V 50 Hz/60 Hz
Power consumption		350 W During standby (when fan is stopped): Approx. 4 W* ¹
Amps		4.1 A - 1.5 A
LCD panel	Panel size (diagonal)	0.74 type
	Aspect ratio	16 : 10
	Display method	3 transparent LCD panels (RGB)
	Drive method	Active matrix method
	Pixels	1 024 000 (1 280 x 800) x 3 panels
Lens		Manual zoom (2x)/Manual focus F 1.7 - 2.6, f 21.6 mm - 43.0 mm
Lamp		UHM lamp (250 W)
Luminosity ^{*2}		3 300 lm
Operating environment		Temperature 0 °C - 40 °C (32 °F - 104 °F) When the HIGH ALTITUDE MODE (page 44) is set to ON: 0 °C - 35 °C (32 °F - 95 °F) Humidity 20% - 80% (no condensation)
Scanning frequency ^{*3} (for RGB signal)	Horizontal scanning frequency	15 kHz - 91 kHz
	Vertical scanning frequency	50 Hz - 85 Hz
	Dot clock frequency	Less than 150 MHz
COMPONENT (YPbPr) signals		525i (480i), 525p (480p), 625i (576i), 625p (576p), 750 (720)/60p, 750 (720)/50p, 1 125 (1 080)/60i, 1 125 (1 080)/50i, 1 125 (1 080)/60p, 1 125 (1 080)/50p
Colour system		7 (NTSC/NTSC 4.43/PAL/PAL-M/PAL-N/PAL60/SECAM)
Projection size		33" - 300" (838.2 mm - 7 620 mm)
Throw distance		1.1 m - 19.5 m (3'7" - 64'0")
Screen aspect ratio		16 : 10
Installation		FRONT/DESK, FRONT/CEILING, REAR/DESK, REAR/CEILING (Menu selection method)
Speaker		1 piece (Monaural) 4 cm (Round)
Max. useable volume output		5.0 W

*1. When NETWORK STANDBY in NETWORK menu is ON: Approx. 25 W

When IN STANDBY MODE of AUDIO SETTING in PROJECTOR SETUP menu is ON: Approx. 35 W

The maximum power consumption during standby: Approx. 35 W.

*2. Measurement, measuring conditions and method of notation all comply with ISO21118 international standards.

*3. See "List of compatible signals" on page 54 for available signals.

Terminals	S-VIDEO IN	Single - line, Mini DIN 4p Y: 1.0 V [p-p], C: 0.286 V [p-p], 75 Ω	
	VIDEO IN	Single - line, RCA pin jack 1.0 V [p-p], 75Ω	
	COMPUTER1 IN	Single - line, D - sub HD 15-pin (female) R.G.B. 0.7 V [p-p], 75 Ω HD, VD/SYNC TTL high impedance, automatic positive/negative polarity compatible	
	COMPUTER2 IN/ 1 OUT	Single - line, D - sub HD 15-pin (female) Selectable for input and output by menu operation. R.G.B. 0.7 V [p-p], 75 Ω HD, VD/SYNC TTL high impedance, automatic positive/negative polarity compatible	
	DVI-D IN	Single - line, DVI-D 24-pin (Single link) DVI 1.0 compatible HDCP compatible	
	AUDIO IN	Single - line, 0.5V [rms], RCA pin jack x 2 (L - R)	
	COMPUTER AUDIO IN	Dual - line, 0.5V [rms], M3 jack (Stereo MINI)	
	VARIABLE AUDIO OUT	Single - line, 0.5V [rms], M3 jack (Stereo MINI) Monitor output/stereo compatible 0 V [rms] - 2.0 V [rms] (variable)	
	SERIAL	D-sub 9-pin RS-232C compatible	
	REMOTE	D-sub 9-pin For external control	
	LAN (RJ-45)	Single - line, For network connection 10 Base-T/100Base-TX	
Wireless LAN (PT-FW300NTE only)	Compatible	IEEE802.11b/IEEE802.11g (Wireless LAN standard protocol)	
	Wireless channel	IEEE802.11b/IEEE802.11g: 1 - 13 channels	
	Distance	30 m (98'5") Depends on the usage environment	
Cabinet	Moulded plastic (PC+ABS)		
Dimensions	Width	432 mm (17")	
	Height	128.5 mm (5 - 1/32")	
	Length	323 mm (12 - 11/16")	
Weight	Approx. 6.2 kg (13.7 lbs.)* ¹		
Certifications	EN60950-1, EN55022, EN61000-3-2, EN61000-3-3, EN55024		
Remote control	Power supply	3 V DC (AA battery x 2)	
	Operating range	Approx. 15 m (49'2") (when operated directly in front of signal receptor)	
	Weight	117 g (4.2 ozs.) (including batteries)	
	Dimensions	Width	48 mm (1 - 7/8")
Length		163 mm (6 - 13/32")	
Height		24.5 mm (-15/16") (not including surface projection parts)	
Options	Ceiling bracket	ET-PKF100H/ET-PKF100S	

*1. Average value. Each product has an individual variable in weight.

Technical Information

Dimensions

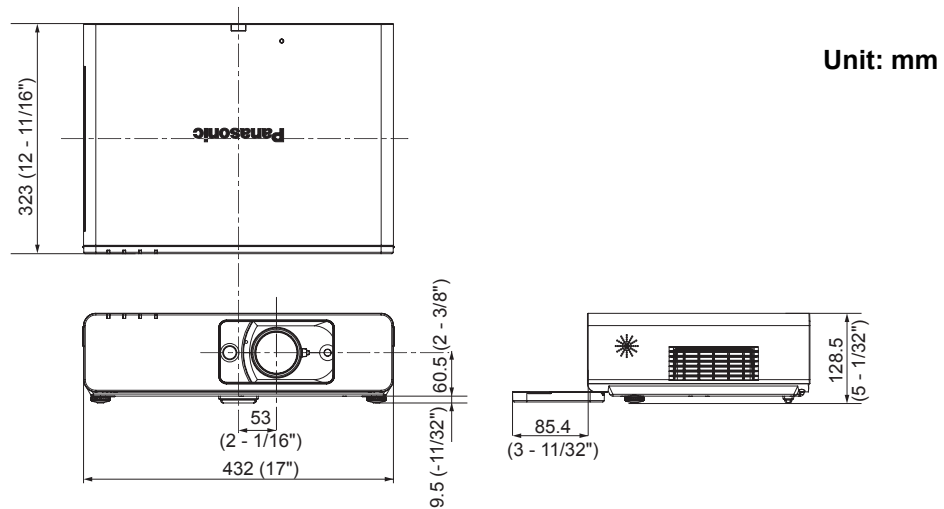

Trademark acknowledgements

- VGA and XGA are trademarks of International Business Machines Corporation.
- S-VGA is a registered trademark of the Video Electronics Standards Association.
- HDMI, the HDMI logo and High-Definition Multimedia Interface are trademarks or registered trademarks of HDMI Licensing LLC.
- The font used in the on-screen displays is a Ricoh bitmap font, which is manufactured and sold by Ricoh Company, Ltd.

All other trademarks are the property of the various trademark owners.

Index

A			
AC IN	15	DVI-D IN	15, 40
Accessories	12	Pin assignments	58
Air exhaust port	15	E	
Air intake port	14	EMULATE	44
Ambient Luminance Sensor (ALS)	14	ENTER	
ASPECT	38	Control panel button	14
AUDIO IN	15	Remote control button	16
AUDIO SETTING	44	F	
Auto Cleaning Filter (ACF)		FILTER COUNTER RESET	45
Compartment	15	Focus lever	14, 26
FILTER indicator	14	FRAME LOCK	39
FILTER indicator status	49	FREEZE	
Replacing	51	Remote control button	16
AUTO SETUP		Remote control function	29
Menu	41	Front leg adjusters	15, 18, 26
Remote control button	16	Front panel cover	14
Remote control function	27	FUNCTION	
AV MUTE	42	Remote control button	16
Remote control button	16	Remote control function	30
Remote control function	29	FUNCTION BUTTON	44
B		H	
BACK COLOR	41	Hand strap	16
BALANCE	44	HIGH ALTITUDE MODE	44
Battery compartment	16	I	
BRIGHTNESS	35	INDEX-WINDOW	
C		Remote control button	16
Calculation methods		Remote control function	29
16:10	17	INITIAL STARTUP	43
16:9	59	INITIALIZE ALL	45
4:3	59	INPUT SELECT	
CD-ROM	12	Control panel button	14
CINEMA	35	Function	26, 28
Cleaning	50	INSTALLATION	
CLOCK PHASE	37	Menu	44
COLOR	35	Projection method	18
COLOR TEMPERATURE	36	K	
COMPUTER		KEYSTONE	37
Connection guidance	56	L	
Remote control button	16	LAMP	
Remote control function	28	Indicator	14
COMPUTER AUDIO IN	15	Indicator status	49
COMPUTER1 IN	15	Lamp unit compartment	15
COMPUTER2 IN/1 OUT	15	Replacing	50
COMPUTER2 SELECT	43	LAN	15
Connections	21	LASER	
CONTRAST	35	Remote control button	16
CONTROL DEVICE SETUP	47	Remote control function	31
D		Lens shift lever	14, 19, 26
DAYLIGHT VIEW	36	Lever	
DEFAULT		Focus lever	14
Remote control button	16	Lens shift lever	14
Remote control function	29	Zoom lever	14
DIGITAL CINEMA REALITY	36	M	
DIGITAL ZOOM		Mains lead	
Remote control button	16	Accessories	12
Remote control function	28	Connecting	23
Dimensions	62	MENU	
Direct power off	23	Control panel button	14
Direct power on	23	Navigation	34
DISPLAY OPTION menu	40	Remote control button	16
DOT CLOCK	37	Structure	32
DOUBLE-WINDOW	30	MENU LOCK	47
DVI EDID	40		
DVI SIGNAL LEVEL	40		

Index

MENU LOCK PASSWORD	47	SERIAL	15
N		Basic format	55
Navigation buttons		Cable specifications	56
Control panel button	14	Communication settings	55
Navigating	34	Connection	55
Remote control button	16	Control commands	56
NETWORK		Pin assignments	55
Remote control button	16	SHARPNESS	35
Remote control function	28	SHIFT	37
NO SIGNAL SHUT-OFF	43	SHIFT V	37
NOISE REDUCTION	36	SIDE BY SIDE	
O		Remote control button	16
ON-SCREEN DISPLAY	40	Remote control function	30
OTHER FUNCTIONS	42	SIGNAL	43
P		SIGNAL SEARCH	41
PASSWORD	46	Speaker	14
PASSWORD CHANGE	46	Specifications	60
PICTURE menu	35	STARTUP LOGO	41
PICTURE MODE	35	STATUS	43
POSITION menu	37	S-VIDEO IN	15
Power		SXGA MODE	41
Control panel button	14	T	
Indicator	14	TEMP	
Indicator status	24	Indicator	14
Remote control button	16	Indicator status	49
Power cord secure lock		TEST PATTERN	45
Accessories	12	TEXT CHANGE	46
Attaching	23	TEXT DISPLAY	46
Projection lens	14	Throw distance	
PROJECTOR SETUP menu	43	16:10	17
R		16:9	59
REMAINING FILTER	43	4:3	59
REMOTE	15	Throwing angle	18
LAMP switching	57	TINT	35
Pin assignments	57	Troubleshooting	53
Switching input signals	57	TV-SYSTEM	36
Remote control		V	
Accessories	12	VARIABLE AUDIO OUT	15
Indicator	16	VIDEO	
Signal emitter	16	Remote control button	16
Signal receptor	14	Remote control function	28
RETURN		VIDEO IN	15
Control panel button	14	VOLUME	
Remote control button	16	Controlling	44
RGB/YPbPr	36	Remote control button	16
RUNTIME	43	Remote control function	31
S		W	
Safety cable		WHITE BALANCE BLUE	35
Accessories	12	WHITE BALANCE GREEN	35
Safeguards	58	WHITE BALANCE RED	35
SCREEN FORMAT	40	WIDE MODE	41
SCREEN POSITION	40	Z	
SCREEN SETTING	40	Zoom lever	14, 26
Screen size			
16:10	17		
16:9	59		
4:3	59		
Security lock	15		
SECURITY menu	46		

Panasonic Corporation

Web Site : <http://panasonic.net/avc/projector/>
© Panasonic Corporation 2008

Printed in Japan
S0908-1118B