



Table of contents

Table of contents	1	OPTIONS	36
Usage Notice	2	OPTIONS <i>Advanced</i>	37
Safety Information.....	2	OPTIONS <i>Lamp Settings</i>	38
Precautions.....	3	Appendices.....	39
Eye Safety Warnings	5	Troubleshooting	39
Product Features	5	Image Problems.....	39
Introduction.....	6	Other Problems.....	40
Package Overview.....	6	Projector Status Indication.....	41
Product Overview	7	Remote Control Problems	42
Main Unit.....	7	Replacing the lamp.....	43
Control Panel.....	8	Compatibility Modes	45
Input / Output Connections.....	9	Computer Compatibility	45
Remote Control.....	10	Video Compatibility	46
Installation	11	RS232 Commands	47
Connecting the Projector	11	RS232 Pin Assignments	47
Connect to Computer/Notebook	11	RS232 Protocol Function List	48
Connect to Video Sources.....	12	Ceiling Mount Installation.....	51
Powering the projector On/Off	13	Optoma Global Offices	52
Powering On the Projector.....	13	Regulation & Safety notices.....	54
Powering Off the Projector.....	14		
Warning Indicator.....	14		
Adjusting the Projected Image.....	15		
Adjusting the Projector's Height	15		
Adjusting the Projector's Zoom /			
Focus.....	15		
Adjusting Projection Image Size.....	16		
User Controls	17		
Control Panel & Remote Control	17		
Control Panel.....	17		
Remote Control.....	18		
On-screen Display Menus	20		
How to operate	20		
Menu Tree.....	21		
IMAGE	23		
IMAGE <i>Advanced</i>	25		
DISPLAY.....	28		
DISPLAY <i>3D</i>	31		
SETUP.....	32		
SETUP <i>Signal -RGB Source</i>	34		
SETUP <i>Signal -Video Source</i>	35		

Safety Information

	The lightning flash with arrow head within an equilateral triangle is intended to alert the user to the presence of uninsulated "dangerous voltage" within the product's enclosure that may be of sufficient magnitude to constitute a risk of electric shock to persons.
	The exclamation point within an equilateral triangle is intended to alert the user to the presence of important operating and maintenance (servicing) instructions in the literature accompanying the appliance.

WARNING: TO REDUCE THE RISK OF FIRE OR ELECTRIC SHOCK, DO NOT EXPOSE THIS APPLIANCE TO RAIN OR MOISTURE. DANGEROUS HIGH VOLTAGES ARE PRESENT INSIDE THE ENCLOSURE. DO NOT OPEN THE CABINET. REFER SERVICING TO QUALIFIED PERSONNEL ONLY.

Class B emissions limits

This Class B digital apparatus meets all requirements of the Canadian Interference-Causing Equipment Regulations.

Important Safety Instruction

1. Do not block any ventilation openings. To ensure reliable operation of the projector and to protect from over heating, it is recommended to install the projector in a location that does not block ventilation. As an example, do not place the projector on a crowded coffee table, sofa, bed, etc. Do not put the projector in an enclosure such as a book case or a cabinet that restricts air flow.
2. Do not use the projector near water or moisture. To reduce the risk of fire and/or electric shock, do not expose the projector to rain or moisture.
3. Do not install near heat sources such as radiators, heaters, stoves or any other apparatus such as amplifiers that emits heat.
4. Clean only with dry cloth.
5. Only use attachments/accessories specified by the manufacturer.
6. Do not use the unit if it has been physically damaged or abused.
Physical damage/abuse would be (but not limited to):
 - Unit has been dropped.
 - Power supply cord or plug has been damaged.
 - Liquid has been spilled on to the projector.
 - Projector has been exposed to rain or moisture.
 - Something has fallen in the projector or something is loose inside.Do not attempt to service the unit yourself. Opening or removing covers may expose you to dangerous voltages or other hazards. Please call Optoma before you send the unit for repair.
7. Do not let objects or liquids enter the projector. They may touch dangerous voltage points and short out parts that could result in fire or electric shock.
8. See projector enclosure for safety related markings.
9. The unit should only be repaired by appropriate service personnel.

Precautions



Please follow all warnings, precautions and maintenance as recommended in this user's guide.

- Warning- Do not look into the projector's lens when the lamp is on. The bright light may hurt your eyes.
- Warning- To reduce the risk of fire or electric shock, do not expose this projector to rain or moisture.
- Warning- Please do not open or disassemble the projector as this may cause electric shock.
- Warning- When replacing the lamp, please allow the unit to cool down. Follow instructions as described on pages 43-44.
- Warning- This projector will detect the life of the lamp itself. Please be sure to change the lamp when it shows warning messages.
- Warning- Reset the "Lamp Reset" function from the on-screen display "OPTIONS | Lamp Settings" menu after replacing the lamp module (refer to page 38).
- Warning- When switching the projector off, please ensure the cooling cycle has been completed before disconnecting power. Allow 90 seconds for the projector to cool down.
- Warning- Do not use lens cap when projector is in operation.
- Warning- When the lamp is approaching the end of its lifetime, the message "Lamp Warning: Lamp life exceeded." will show on the screen. Please contact your local reseller or service center to change the lamp as soon as possible.

Note

- ❖ When the lamp reaches the end of its life, the projector will not turn back on until the lamp module has been replaced. To replace the lamp, follow the procedures listed under "Replacing the Lamp" section on pages 43-44.

Usage Notice

Do:

- ❖ Turn off and unplug the power plug from the AC outlet before cleaning the product.
- ❖ Use a soft dry cloth with mild detergent to clean the display housing.
- ❖ Disconnect the power plug from AC outlet if the product is not being used for a long period of time.

Do not:

- ❖ Block the slots and openings on the unit provided for ventilation.
- ❖ Use abrasive cleaners, waxes or solvents to clean the unit.
- ❖ Use under the following conditions:
 - In extremely hot, cold or humid environments.
 - ▶ Ensure that the ambient room temperature is within 5 - 35°C.
 - ▶ Relative Humidity is 5 - 35°C, 80% (Max.), non-condensing.
 - In areas susceptible to excessive dust and dirt.
 - Near any appliance generating a strong magnetic field.
 - In direct sunlight.

Eye Safety Warnings



- Avoid staring/facing directly into the projector beam at all times. Keep your back to the beam as much as possible.
- When projector is used in a classroom, adequately supervise students when they are asked to point out something on the screen.
- In order to minimize the lamp power, use room blinds to reduce ambient light levels.

Product Features

- WXGA (1280 x 720) Native resolution
- One built-in speaker with 2 watt amplifier
- HDTV compatible (720P, 1080i/p)
- BrilliantColor™ Technology
- Security Bar and Kensington Lock
- RS232 control
- Rapid shutdown
- “3D Ready” – support for 120Hz

Package Overview

Unpack and inspect the box contents to ensure all parts listed below are in the box. If something is missing, please contact your nearest customer service center.

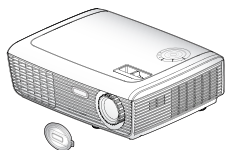

Projector with lens cap

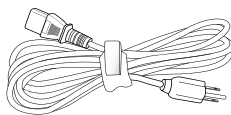

Power Cord 1.8m

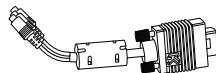

VGA to Component Cable



IR Remote Control

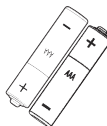

2 × AAA Batteries



Carrying case
(Option)

Note

- ❖ Due to different applications in each country, some regions may have different accessories.

Documentation :

- User's Manual
- Warranty Card
- Quick Start Card
- WEEE Card
(for EMEA only)

Product Overview Main Unit

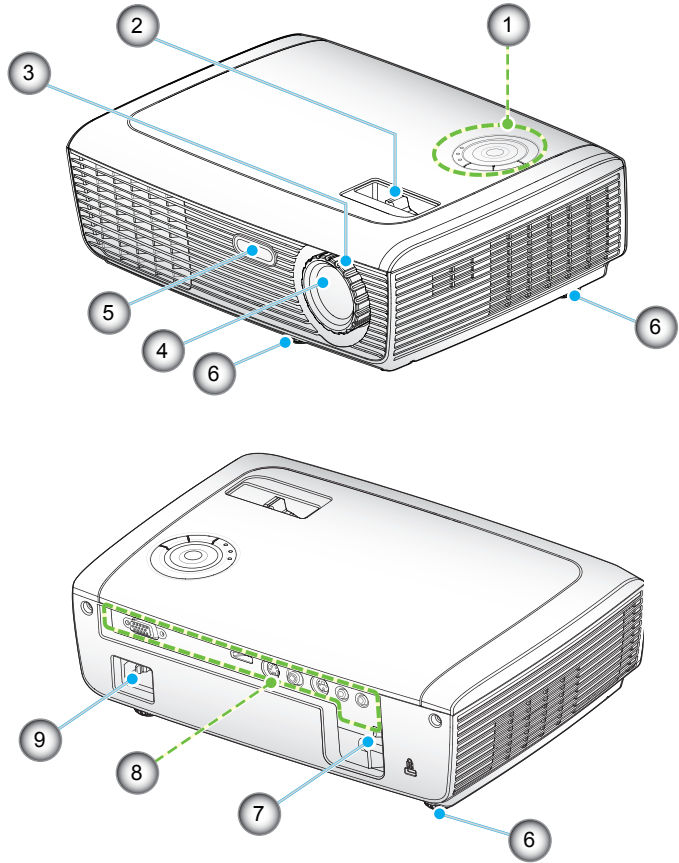

- | | |
|------------------|-------------------------------|
| 1. Control Panel | 6. Tilt-Adjustment Feet |
| 2. Zoom Ring | 7. Security Bar |
| 3. Focus Ring | 8. Input / Output Connections |
| 4. Zoom Lens | 9. Power Socket |
| 5. IR Receiver | |

Control Panel

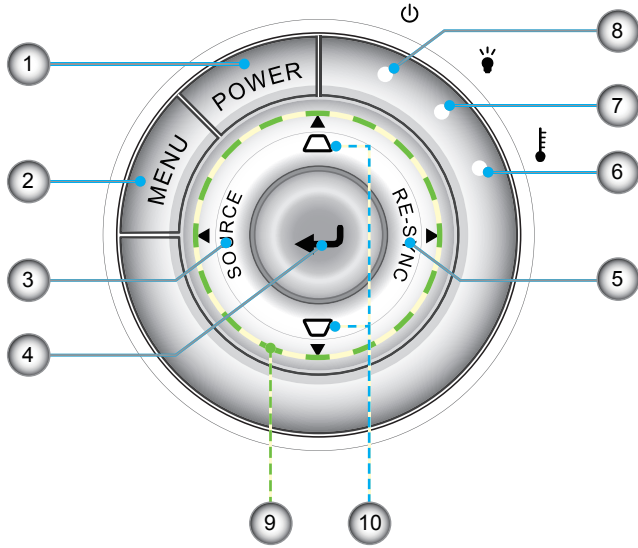

1. Power/Standby
2. Menu
3. Source
4. Enter
5. Re-Sync
6. Temp LED
7. Lamp Fail LED
8. Power LED
9. Four Directional Select Keys
10. Keystone Correction

Input / Output Connections

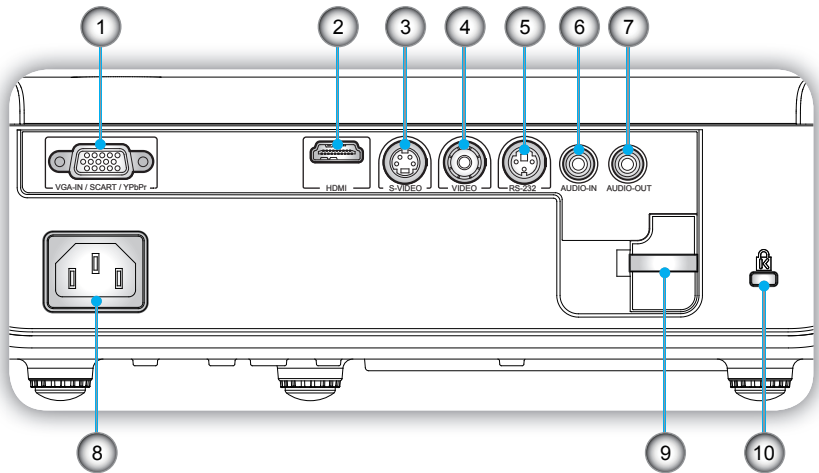

1. VGA-In/SCART/YPbPr Connector
(PC Analog Signal/Component Video Input/HDTV/SCART/
YPbPr)
2. HDMI Connector
3. S-Video Input Connector
4. Composite Video Input Connector
5. RS-232 Connector (3-pin)
6. Audio Input Connector (3.5mm Mini Jack)
7. Audio Output Connector (3.5mm Mini Jack)
8. Power Socket
9. Security Bar
10. Kensington™ Lock Port

Remote Control

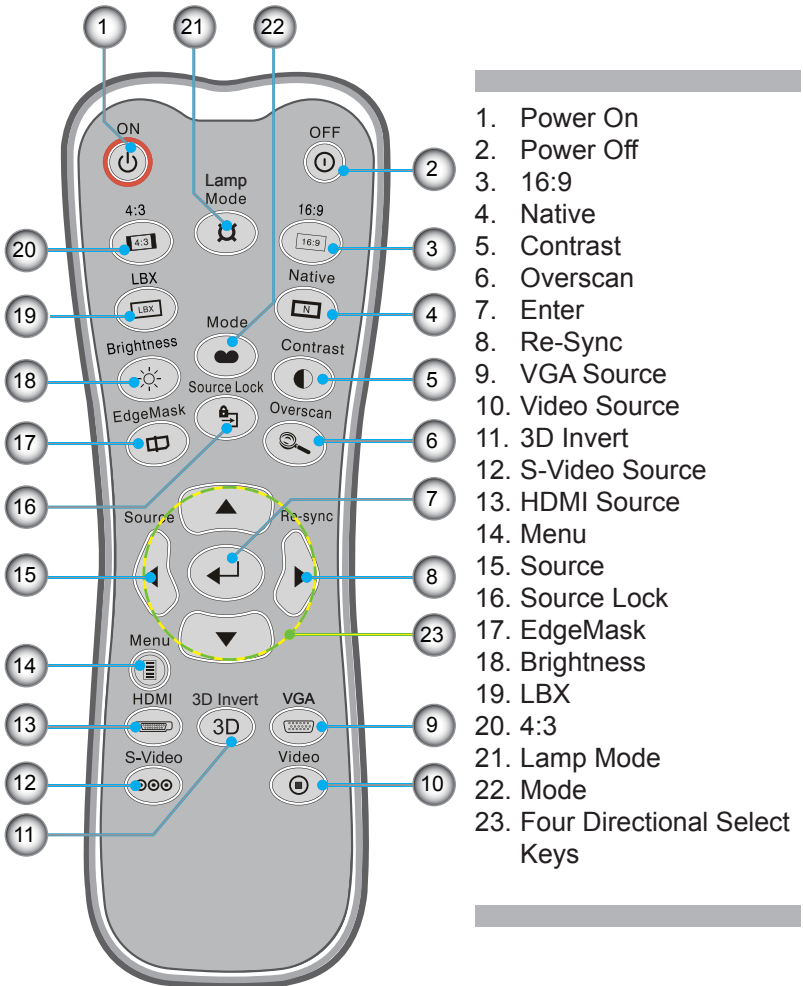

Connecting the Projector Connect to Computer/Notebook

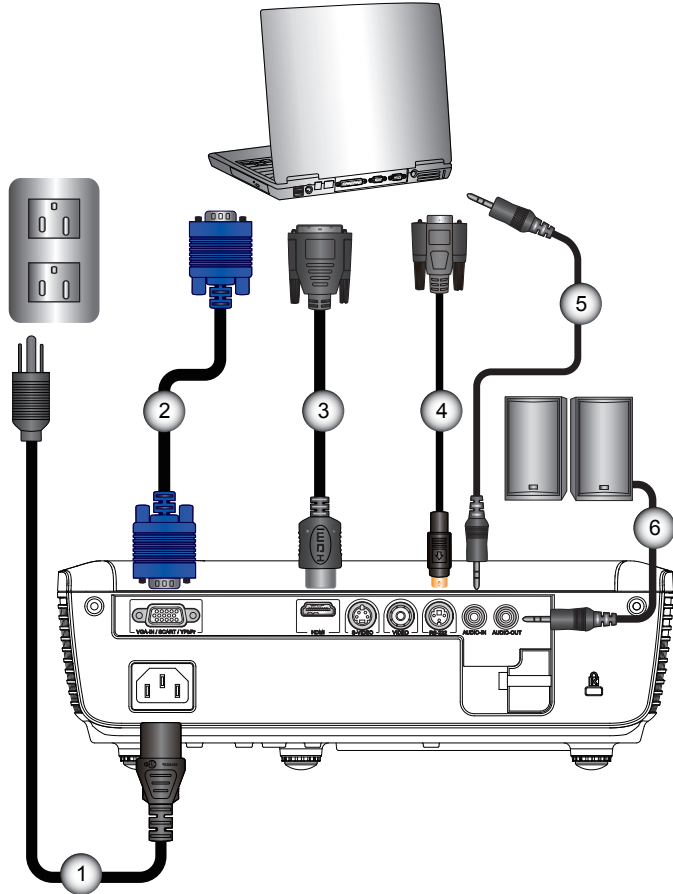

Note

- ❖ Due to the difference in applications for each country, some regions may have different accessories.
- ❖ (*) Optional accessory

- | | |
|--------|---------------------|
| 1..... | Power Cord |
| 2..... | *VGA Cable |
| 3..... | *DVI/HDMI Cable |
| 4..... | *RS232 Cable |
| 5..... | *Audio Input Cable |
| 6..... | *Audio Output Cable |

Installation

Connect to Video Sources

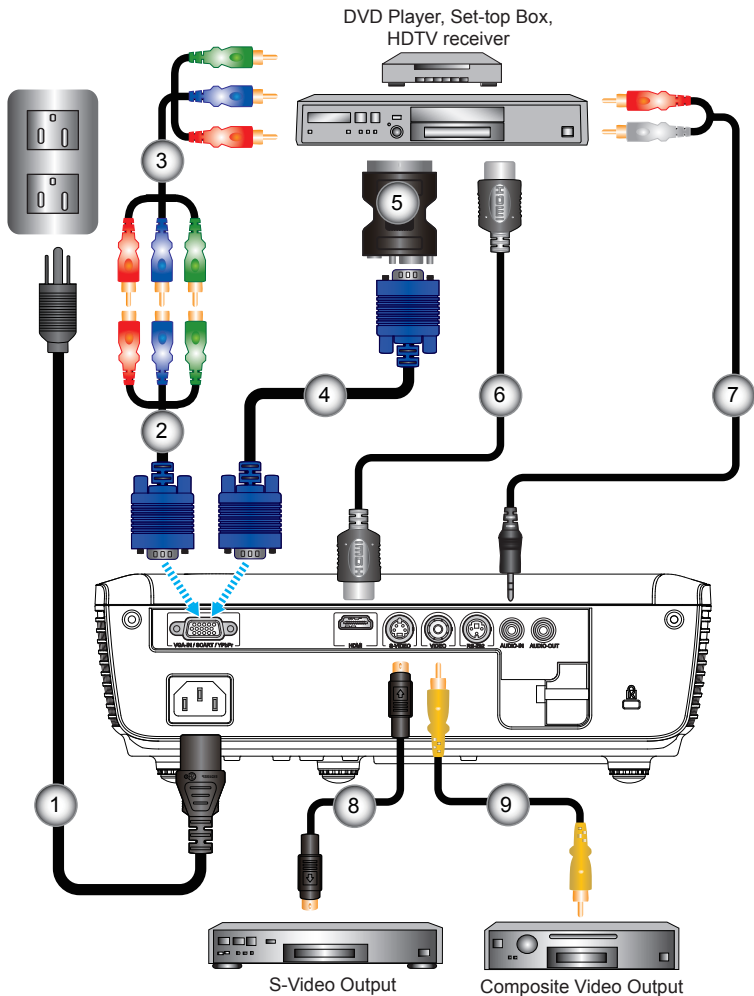

Note

- ❖ Due to the difference in applications for each country, some regions may have different accessories.
- ❖ (*) Optional accessory

1.....	Power Cord
2.....	*VGA to component Cable
3.....	*3 RCA Component Cable
4.....	*VGA Cable
5.....	*SCART/VGA Adaptor
6.....	*HDMI Cable
7.....	*Audio Cable Jack/RCA
8.....	*S-Video Cable
9.....	*Composite Video Cable

Powering the projector On/Off

Powering On the Projector

1. Remove the lens cap. ❶
2. Securely connect the power cord and signal cable. When connected, the Power LED will turn red.
3. Turn on the lamp by pressing “POWER” button either on the top of the projector or on the remote. The Power LED will now turn Green. ❷

The startup screen will display in approximately 10 seconds. The first time you use the projector, you can select your preferred language after the startup screen displays.

4. Turn on and connect the source that you want to display on the screen (computer, notebook, video player, etc). The projector will detect the source automatically. If not, push menu button and go to “OPTIONS”. Make sure that the “Source Lock” has been set to “Off”.
- ❖ If you connect multiple sources at the same time, press the “SOURCE” button on the control panel or direct source keys on the remote control to switch between inputs.

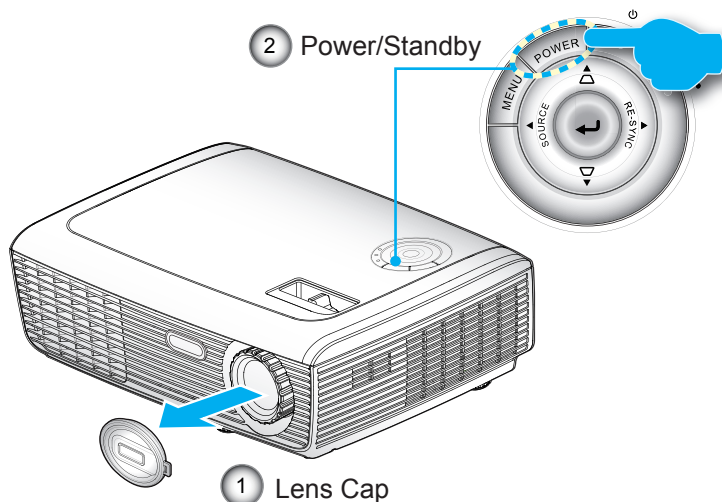

Note

- ❖ Turn on the projector first and then select the signal sources.

Powering Off the Projector

1. Press the “POWER” button to turn off the projector lamp. The following message will be displayed on the screen.

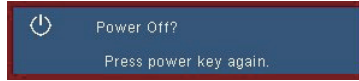

Press the “POWER” button again to confirm, otherwise the message will disappear after 15 seconds.

When you press the “POWER” button a second time, the system will show the countdown timer on the screen.

2. The cooling fans continue to operate for about 10 seconds for cooling cycle. When the Power LED turns Red, the projector has entered standby mode.

If you wish to turn the projector back on, you must wait until the projector has completed the cooling cycle and has entered standby mode. Once in standby mode, simply press “POWER” button to restart the projector.

3. Disconnect the power cord from the electrical outlet and the projector.
4. Do not turn on the projector immediately following a power off procedure.

Warning Indicator

Note

- ❖ Contact the nearest service center if the projector displays these symptoms. See pages 52-53 for more information.

- ❖ When the “LAMP” indicator lights red (“POWER” indicator flashes red), the projector will automatically shut down. Please call your nearest service center for assistance.
- ❖ When the “TEMP” indicator lights red (“POWER” indicator flashes red), it indicates the projector has overheated. The projector will shut down automatically. Under normal conditions, the projector can be switched on again after it has cooled down.
- ❖ When the “TEMP” indicator flashes red (“POWER” indicator flashes red), it indicates the fan has failed.

Adjusting the Projected Image

Adjusting the Projector's Height

The projector is equipped with elevator feet for adjusting the image height.

1. Locate the adjustable foot you wish to modify on the underside of the projector.
2. Rotate the adjustable ring counter clockwise to raise the projector or clockwise to lower it. Repeat with the remaining feet as needed.

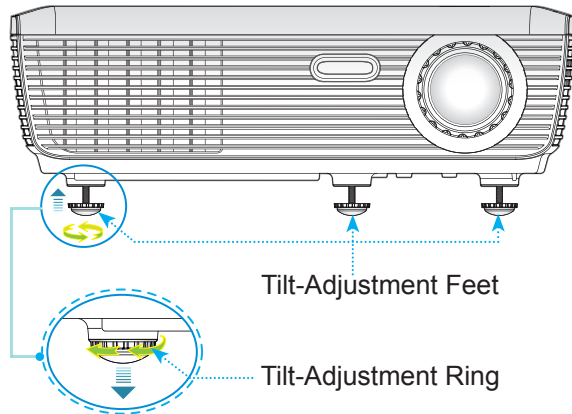

Adjusting the Projector's Zoom / Focus

You may turn the zoom ring to zoom in or out. To focus the image, rotate the focus ring until the image is clear. The projector will focus at distances from 3.28 to 34.44 feet (1.0 to 10.5 meters).

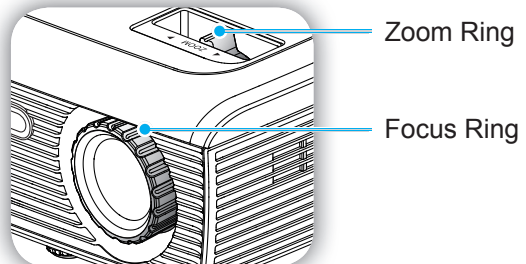

Adjusting Projection Image Size

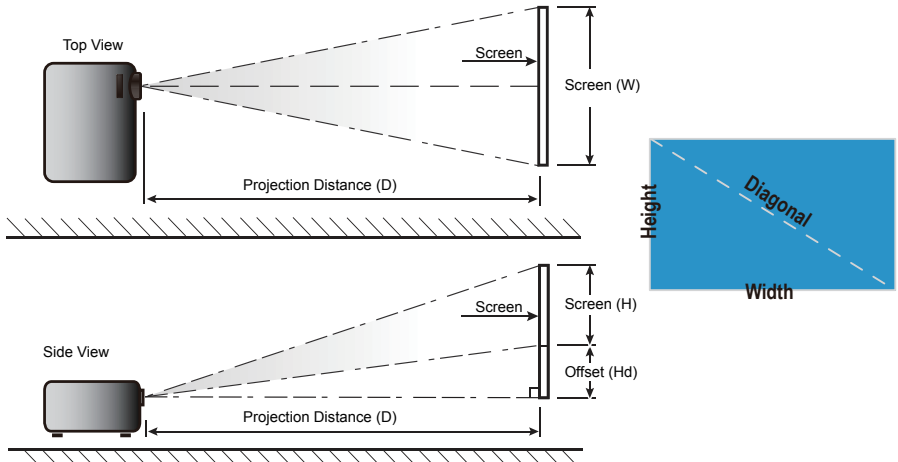

Diagonal length (inch) size of 16:9 Screen	Screen Size W x H				Projection Distance (D)				Offset (Hd)	
	(m)		(feet)		(m)		(feet)			
	Width	Height	Width	Height	wide	tele	wide	tele	(m)	(feet)
26.57	0.59	0.33	1.94	1.08	-	1.0	-	3.28	0.04	0.13
30.00	0.66	0.37	2.16	1.21	1.0	1.1	3.28	3.61	0.05	0.15
40.00	0.89	0.50	2.92	1.64	1.4	1.5	4.59	4.92	0.06	0.20
60.00	1.33	0.75	4.36	2.46	2.1	2.3	6.89	7.54	0.09	0.31
70.00	1.55	0.87	5.08	2.85	2.4	2.6	7.87	8.53	0.11	0.35
80.00	1.77	1.00	5.81	3.28	2.7	3.0	8.86	9.84	0.12	0.41
90.00	1.99	1.12	6.53	3.67	3.1	3.4	10.17	11.15	0.14	0.46
100.00	2.21	1.25	7.25	4.10	3.4	3.8	11.15	12.46	0.16	0.51
120.00	2.66	1.49	8.72	4.89	4.1	4.5	13.45	14.76	0.18	0.61
150.00	3.32	1.87	10.89	6.13	5.1	5.6	16.73	18.37	0.23	0.76
180.00	3.98	2.24	13.05	7.35	6.2	6.8	20.34	22.30	0.28	0.91
250.00	5.53	3.11	18.14	10.20	8.6	9.4	28.21	30.83	0.39	1.26
300.00	6.64	3.74	21.78	12.27	10.3	11.3	33.78	37.06	0.46	1.52
306.00	6.77	3.81	22.21	12.50	10.5	-	34.44	-	0.47	1.55

❖ This graph is for user's reference only.







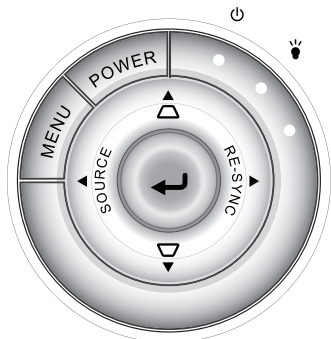



Control Panel & Remote Control

There are two ways for you to control the functions:
Control Panel and Remote Control.

Control Panel



Using the Control Panel

POWER	Refer to the “Power On/Off the Projector” section on pages 13-14.
MENU	Press “MENU” to launch the on-screen display (OSD) menu. To exit OSD, Press “MENU” again.
	Confirm your item selection.
RE-SYNC	Automatically synchronize the projector to the input source.
SOURCE	Press “SOURCE” to select an input signal.
Four Directional Select Keys	Use     to select items or make adjustments to your selection.
Keystone	Use   to adjust image distortion caused by tilting the projector. (± 40 degrees)
 Lamp LED	Indicates the projector’s lamp status.
 Temp LED	Indicates the projector’s temperature status.
 Power LED	Indicates the projector’s status.

User Controls

Remote Control



Using the Remote Control

Power On		Refer to the “Power On” section on page 13.
Power Off		Refer to the “Power On/Off the Projector” section on page 14.
Lamp Mode		Increase the brightness of the image. (refer to page 40)
Mode		Select the display mode from Cinema, Bright, Photo, Reference and User.
4:3		Scale the image at a 4:3 aspect ratio.
16:9		Scale the image at a 16:9 aspect ratio.
LBX		Enable the viewing of the letterboxed non-anamorphically enhanced movie at full screen width. Part of the original image will be lost if the image aspect ratio is less than 2.35:1.
Native		The input source will be displayed without scaling.
Brightness		Adjust the brightness of the image.
Contrast		Control the degree of difference between the lightest and darkest parts of the picture.
EdgeMask		Mask off a few pixels on each edge of the image to be displayed. Use this function to adjust if image source happens to have noise near any edge of the display image.
Source Lock		Select auto detection all connector ports or lock current connector port.
Overscan		Mask off a few pixels on each edge of the image to be displayed. Use the function to adjust if image source happens to have noise near any edge of the display image.

User Controls



Using the Remote Control

Enter		Confirm your item selection.
Source		Press "Source" to select an input signal.
Re-sync		Automatically synchronizes the projector to the input source.
Menu		Display or exit the on-screen display menus for projector.
HDMI		Press "HDMI" to choose source from HDMI connector.
VGA		Press "VGA" to choose source from VGA/SCART/YPbPr connector.
S-Video		Press "S-Video" to choose S-Video source.
Video		Press "Video" to choose Composite video source.
3D Invert	3D	Press the "3D Invert" to turn the 3D Sync. Invert OSD menu on/off.
Four Directional Select Keys		Use ▲ ▼ ◀ ▶ to select items or make adjustments to your selection.

On-screen Display Menus

The Projector has multilingual On-screen Display menus that allow you to make image adjustments and change a variety of settings. The projector will automatically detect the source.

How to operate

1. To open the OSD menu, press “MENU” on the Remote Control or Projector Keypad.
2. When OSD is displayed, use ◀▶ keys to select any item in the main menu. While making a selection on a particular page, press ▼ or “Enter” key to enter sub menu.
3. Use ▲ ▼ keys to select the desired item and adjust the settings by ◀▶ key.
4. Select the next item to be adjusted in the sub menu and adjust as described above.
5. Press “Enter” to confirm, and the screen will return to the main menu.
6. To exit, press “MENU” again. The OSD menu will close and the projector will automatically save the new settings.

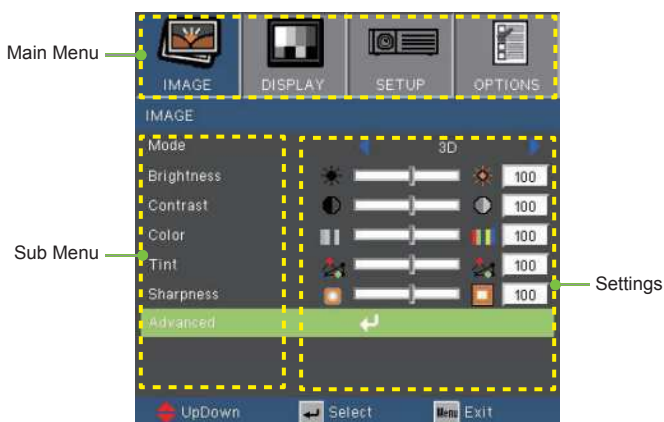

Menu Tree

Main Menu	Sub Menu	Settings	
IMAGE	Mode	Cinema / Bright / Photo / Reference / User	
	Contrast	0~100	
	Brightness	0~100	
	#1 Color	0~100	
	#1 Tint	0~100	
	Sharpness	0-31	
	Advanced	BrilliantColor™ 0-10	
		Degamma Film / Video / Graphics / Standard	
		Image AI On / Off	
		Color Temp. Warm / Medium / Cold	
		RGB Gain/Bias Red Gain / Green Gain / Blue Gain / Red Bias / Green Bias / Blue Bias / Reset / Exit	
		Color Space AUTO / RGB / YCbCr	
		Input Source HDMI / VGA / Video / S-Video	
	Exit		
DISPLAY	Format	4:3 / 16:9 / LBX / Native / AUTO	
	Overscan	0~5	
	EdgeMask	0~10	
	V Image Shift	-50 ~ +50	
	V Keystone	-40 ~ +40	
	SuperWide	Off / On / Auto	
	3D	3D Mode Off / DLP-Link / IR	
		#2 3D Sync. Invert On / Off	
	Exit		
SETUP	Language	English / Deutsch / Français / Italiano / Español / Português / Svenska / Nederlands / Norsk/Dansk / Polski / Русский / Suomi / ελληνικά / Magyar / Čeština / عربي / 繁體中文 / 简体中文 / 日本語 / 한국어 / Türkçe / Farsi	
	Projection	Front / Front-Ceiling / Rear / Rear-Ceiling (ICONS)	
	Menu Location	Top-Left / Top-Right / Center / Bottom-Left / Bottom-Right (ICONS)	
	#3 Signal	Automatic	Enable / Disable
		Phase (VGA)	0~31
		Frequency (VGA)	-5~5
		H. Position (VGA)	-5~5
		V. Position (VGA)	-5~5
		Saturation (Video)	0~100
		Hue (Video)	0~100
		IRE (Video)	0 / 7.5
		Exit	
	Projector ID	0~99	
Mute	On / Off		
Volume	0~10		

User Controls

Main Menu	Sub Menu	Settings	
OPTIONS	Source Lock	On / Off	
	High Altitude	On / Off	
	Information Hide	On / Off	
	Background Color	Black / Red / Blue / Green / White	
	Test Pattern	None / Grid / White Pattern	
	Advanced	Auto Power Off (min.)	0-180
		Sleep Timer (min.)	0-995
		Exit	
	Lamp Settings	Lamp Hours	
		Lamp Reminder	On / Off
		Brightness Mode	STD/Bright
		Lamp Reset	Yes/No
		Exit	
	Reset		



- ❖ Please note that the on-screen display (OSD) menus vary according to the signal type selected and the projector model you are using.
- ❖ (#1) "Color" and "Tint" are only supported in Video mode.
- ❖ (#2) "3D Sync Invert" is only available when 3D is enabled and this mode 3D is for DLP link glass only.
- ❖ (#3) "Signal" is only supported in Analog VGA (RGB) signal.

IMAGE



Display Mode

There are many factory presets optimized for various types of images.

- ▶ Cinema: For home theater.
- ▶ Bright: Maximum brightness input.
- ▶ Photo: Optimized for displaying photographic images.
- ▶ Reference: This mode is intended to reproduce, as close as possible, the image the way the movie director intended. Color, color temperature, brightness, contrast and gamma settings are all configured to standard reference levels.
- ▶ User: User's settings.
- ▶ 3D: The initial default setting of this mode is DLP-Link. Any further adjustments by the user in 3D will be saved in this mode for further use.

Contrast

The contrast controls the degree of difference between the lightest and darkest parts of the picture. Adjusting the contrast changes the amount of black and white in the image.

- ▶ Press the ◀ to decrease the contrast.
- ▶ Press the ▶ to increase the contrast.

Brightness

Adjust the brightness of the image.

- ▶ Press the ◀ to darken image.
- ▶ Press the ▶ to lighten the image.

User Controls

Color

Adjust a video image from black and white to fully saturated color.

- ▶ Press the ◀ to decrease the color saturation in the image.
- ▶ Press the ▶ to increase the color saturation in the image.

Tint

Adjust the color balance of red and green.

- ▶ Press the ◀ to increase the amount of green in the image.
- ▶ Press the ▶ to increase the amount of red in the image.

Sharpness

Adjust the sharpness of the image.

- ▶ Press the ◀ to decrease the sharpness.
- ▶ Press the ▶ to increase the sharpness.

Note

- ❖ “Color” and “Tint” functions are only supported under Video mode.

IMAGE | Advanced



BrilliantColor™

This adjustable item utilizes a new color-processing algorithm and system level enhancements to enable higher brightness while providing true, more vibrant colors in picture. The range is from “0” to “10”. If you prefer a stronger enhanced image, adjust toward the maximum setting. For a smoother, more natural image, adjust toward the minimum setting.

Degamma

This allows you to choose a degamma table that has been fine-tuned to bring out the best image quality for the input.

- ▶ Film: for home theater.
- ▶ Video: for video or TV source.
- ▶ Graphics: for image source.
- ▶ PC: for PC or computer source.

Image AI

Image AI improves the contrast of the picture by optimizing the brightness of the lamp according to the picture content.

- ▶ On: The dynamic image performance manager is active in making sure your greatest pleasure from seeing a movie dynamically with the most dark details revealed, vivid and bright image performed all the way.
- ▶ Off: The dynamic image performance manager is on standby.

User Controls

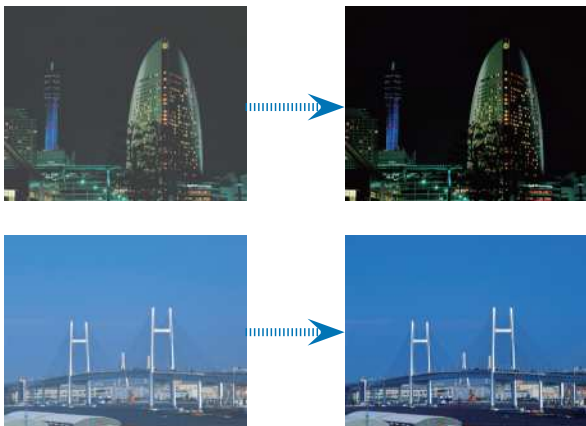





Color Temp

If set to cold temperature, the image looks more blue. (cold image)
If set to warm temperature, the image looks more red.

(warm image)

RGB Gain/Bias

Press  into the next menu as below and then use  or  to select item.

- ▶ Red Gain / Green Gain / Blue Gain / Red Bias / Green Bias / Blue Bias: Use  or  to select Red, Green, or Blue for brightness (Gain) and contrast (Bias).
- ▶ Reset: Choose “Yes” to return the factory default settings for color adjustments.



Color Space

Select an appropriate color matrix type from AUTO, RGB or YUV.

Input Source

Use this option to enable / disable input sources. Press **↵** to enter the sub menu and select which sources you require. Press "Enter" to finalize the selection. The projector will not search for inputs that are not selected.



DISPLAY



Format

Use this function to choose your desired aspect ratio.

- ▶ 4:3: This format is for 4×3 input sources.
- ▶ 16:9: This format is for 16×9 input sources, like HDTV and DVD enhanced for Wide screen TV.
- ▶ LBX: This format is for non-16x9, letterbox source and for users who use external 16x9 lens to display 2.35:1 aspect ratio using full resolution.
- ▶ Native: This format displays the original image without any scaling.
- ▶ AUTO: Automatically selects the appropriate display format.

Aspect ratio (source detected)	Resize image
4:3	960 x 720 center
16:9	1280 x 720 center
LBX	1280 x 720 center

Detail informations about LBX mode :

1. Some Letter-Box DVDs are not enhanced for 16x9 TVs. In this situation, the image will not look right when displayed in 16:9 mode.
In this situation, please try to using the 4:3 mode to view the DVD.
If the content is not 4:3, there will be black bars around the

image in 16:9 display. For this type of content, you can use LBX mode to fill the image on the 16:9 display.

2. If you use an external anamorphic lens, this LBX mode also allows you to watch a 2.35:1 content (include Anamorphic DVD and HDTV film source) that support anamorphic wide is enhanced for 16x9 Display in a wide 2.35:1 image.

In this case, there are no black bars. Lamp power and vertical resolution are fully utilized.

Note

- ❖ Each I/O has different setting of "Overscan".
- ❖ "Overscan" and "Edge Mask" can't work at same time.

Overscan

Overscan function removes the noise in a video image. Overscan the image to remove video encoding noise on the edge of video source.

Edge Mask

- ▶ Press the ◀ to reduce the size of an image.
- ▶ Press the ▶ to magnify an image on the projection screen.

V Image Shift

Shift the projected image position vertically.

V Keystone

Press the ◀ or ▶ to adjust image distortion vertically and makes a rectangular image.

SuperWide

SuperWide is a feature that uses a special 2.0:1 aspect ratio screen enabling both 16:9 and 2.35:1 aspect ratio movies to be shown without black bars at the top and bottom of the screen

Note

- ❖ "SuperWide" is "Off" as default.

- ▶ Off: Your desired aspect ratio can be selected - 4:3, 16:9, LBX and Native.
- ▶ On: Only formats 4:3 and 16:9 can be selected.
- ▶ Auto: To solve the differences of the film formats, the option can keep the format in the same ratio.

User Controls.

How to use “SuperWide”

1. Obtain a 2.0:1 aspect ratio screen
2. Switch SuperWide ON
3. Align the projector image correctly on the screen
4. Enjoy movies without black bars

DISPLAY | 3D

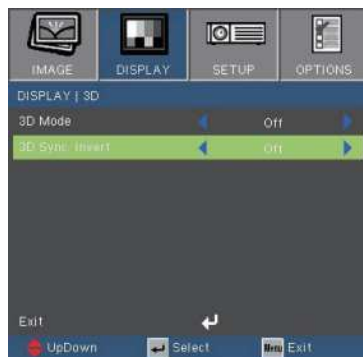

Note

- ❖ “IR” options may vary according to model.
- ❖ “3D Sync Invert” is only available when 3D is enabled and this mode 3D is for DLP link glass only.

3D Mode

- ▶ Off: Select “Off” to turn 3D settings off for 3D images.
- ▶ DLP Link: Select “DLP Link” to use optimized settings for DLP Link 3D images.
- ▶ IR: Select “IR” to use optimized settings for IR-based 3D images.

3D Sync. Invert

- ▶ Press the “On” to invert left and right frame contents.
- ▶ Press the “Off” for default frame contents.

SETUP



Language

Choose the multilingual OSD menu. Press ◀ or ▶ into the sub menu and then use the ▲ or ▼ key to select your preferred language. Press “Enter” to finalize the selection.



Projection

- ▶  Front-Desktop

This is the default selection. The image is projected straight on the screen.

- ▶  Rear-Desktop

When selected, the image will appear reversed.

- ▶  Front-Ceiling

When selected, the image will turn upside down.

Note

- ❖ Rear-Desktop and Rear-Ceiling are to be used with a translucent screen.

- ▶  Rear-Ceiling

When selected, the image will appear reversed in upside down position.

Menu Location

Choose the menu location on the display screen.

Projector ID

ID definition can be set up by menu (range 0~99), and allow user control an individual projector by RS232. Refer to page 48 for the complete list of RS232 commands.

Mute

- ▶ Choose the “On” to turn mute on.
- ▶ Choose the “Off” to turn mute off.

Volume

- ▶ Press the ◀ to decrease the volume.
- ▶ Press the ▶ to increase the volume.

SETUP | Signal -RGB Source



Note

- ❖ “Signal” is only supported in Analog VGA (RGB) signal.

Automatic

Automatically selects the signal. If you use this function, the Phase, frequency items are grayed out, and if Signal is not automatic, the phase, frequency items will appear for user to manually tune and saved in settings after that for next time projector turns off and on again.

Phase

Synchronize the signal timing of the display with the graphic card. If the image appears to be unstable or flickers, use this function to correct it.

Frequency

Change the display data frequency to match the frequency of your computer's graphic card. Use this function only if the image appears to flicker vertically.

H. Position

- ▶ Press the ◀ to move the image left.
- ▶ Press the ▶ to move the image right.

V. Position

- ▶ Press the ◀ to move the image down.
- ▶ Press the ▶ to move the image up.

SETUP | Signal -Video Source



Note

- ❖ “Signal” is not supported when the source is HDMI or DVI-D.
- ❖ “IRE” is only supported on NTSC signal.

Automatic

Automatically selects the signal. If you use this function, the Phase, frequency items are grayed out, and if Signal is not automatic, the phase, frequency items will appear for user to manually tune and saved in settings after that for next time projector turns off and on again.

Saturation

Adjust a video image from black and white to fully saturated color.

- ▶ Press the ◀ to decrease the color saturation in the image.
- ▶ Press the ▶ to increase the color saturation in the image.

Hue

Adjust the color balance of red and green.

- ▶ Press the ◀ to increase the amount of green in the image.
- ▶ Press the ▶ to increase the amount of red in the image.

IRE

Adjust measurement of composite video signals.

OPTIONS



Source Lock

- ▶ On: The projector will only search current input connection.
- ▶ Off: The projector will search for other signals if the current input signal is lost.

High Altitude

When “On” is selected, the fans will spin faster. This feature is useful in high altitude areas where the air is thin.

Information Hide

- ▶ On: Choose “On” to hide the info message.
- ▶ Off: Choose “Off” to show the “searching” message.

Background Color

Use this feature to display a “Black”, “Red”, “Blue”, “Green” or “White”, screen when no signal is available.

Test Pattern

Display a test pattern. There are Grid, White pattern and None.

Reset

Choose “Yes” to return the display parameters on all menus to the factory default settings.

OPTIONS | Advanced



Auto Power Off (min)

Sets the countdown timer interval. The countdown timer will start, when there is no signal being sent to the projector. The projector will automatically power off when the countdown has finished (in minutes).

Sleep Timer (min)

Sets the countdown timer interval. The countdown timer will start, with or without a signal being sent to the projector. The projector will automatically power off when the countdown has finished (in minutes).

OPTIONS | Lamp Settings



Lamp Hours

Display the projection time.

Lamp Reminder

Choose this function to show or to hide the warning message when the changing lamp message is displayed.

The message will appear 30 hours before suggested replacement of lamp.

Brightness Mode

- ▶ STD: Choose "STD" to dim the projector lamp which will lower power consumption and extend the lamp life.
- ▶ BRIGHT: Choose "BRIGHT" to increase the brightness.

Lamp Reset

Reset the lamp hour counter after replacing the lamp.

Troubleshooting

If you experience a problem with your projector, please refer to the following information. If a problem persists, please contact your local reseller or service center.

Image Problems

[?] No image appears on-screen

- ▶ Ensure all the cables and power connections are correctly and securely connected as described in the “Installation” section.
- ▶ Ensure all the pins of connectors are not bent or broken.
- ▶ Check if the projection lamp has been securely installed. Please refer to the “Replacing the lamp” section.
- ▶ Make sure you have removed the lens cap and the projector is switched on.
- ▶ Ensure that the “AV mute” feature is not turned on.

[?] Image is out of focus

- ▶ Make sure the lens cap is removed.
- ▶ Adjust the Focus Ring on the projector lens.
- ▶ Make sure the projection screen is between the required distance 3.28 to 34.44 feet (1.0 to 10.5 meters) from the projector. See page 15~16.

[?] The image is stretched when displaying 16:9 DVD title

- ▶ When you play anamorphic DVD or 16:9 DVD, the projector will show the best image in 16:9 format on projector side.
- ▶ If you play the LBX format DVD title, please change the format as LBX in projector OSD.
- ▶ If you play 4:3 format DVD titles, please change the format to 4:3 in the projector OSD.
- ▶ If the image is still stretched, you will also need to adjust the aspect ratio by referring to the following:

- ▶ Please setup the display format as 16:9 (wide) aspect ratio type on your DVD player.

[?] Image is too small or too large

- ▶ Adjust the Zoom Ring on the top of the projector.
- ▶ Move the projector closer to or further from the screen.
- ▶ Press “MENU” button on the remote control or projector panel, go to “DISPLAY → Format” and try the different settings.

[?] Image has slanted sides

- ▶ If possible, reposition the projector so that it is horizontally centered on the screen and below the bottom of the screen.

[?] Image is reversed

- ▶ Select “SETUP → Projection” from the OSD and adjust the projection direction.

Other Problems

[?] The projector stops responding to all controls

- ▶ If possible, turn off the projector, then unplug the power cord and wait at least 60 seconds before reconnecting power.

[?] Lamp burns out or makes a popping sound

- ▶ When the lamp reaches its end of life, it will burn out and may make a loud popping sound. If this happens, the projector will not turn on until the lamp module has been replaced. To replace the lamp, follow the procedures in the “Replacing the Lamp” section on pages 43-44.

Projector Status Indication

? LED lighting message

Message	Power LED	Temp-LED	Lamp-LED
	(Green/Red)	(Red)	(Red)
Standby State (Input power cord)	Red	○	○
Power on (Warming)	Flashing Green	○	○
Lamp lighting	Green	○	○
Power off (Cooling)	Flashing Green	○	○
Error (Over Temp.)	Flashing Red	☀	○
Error (Fan fail)	Flashing Red	Flashing	○
Error (Lamp fail)	Flashing Red	○	☀

Note

Steady light ⇨ ☀

No light ⇨ ○

? On Screen Messages

► Temperature warning:



- ▶ Fan failed:

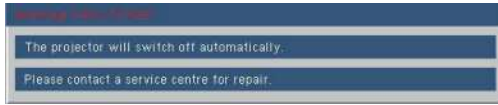

- ▶ Lamp warning:



Remote Control Problems

[?] If the remote control does not work

- ▶ Check the operating angle of the remote control is within $\pm 15^\circ$ both horizontally and vertically of one of the IR receivers on the projector.
- ▶ Make sure there are not any obstructions between the remote control and the projector. Move to within 7 m ($\pm 0^\circ$) of the projector.
- ▶ Make sure the batteries are inserted correctly.
- ▶ Replace batteries if they are exhausted.

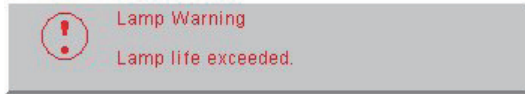

Replacing the lamp

The projector automatically detects the lamp life. When the lamp life is nearing the end of use, you will receive a warning message.



When you see this message, please contact your local reseller or service center to change the lamp as soon as possible. Make sure the projector has been cooled down for at least 30 minutes before changing the lamp.



-  **Warning:** If ceiling mounted, please use caution when opening the lamp access panel. It is recommended to wear safety glasses if changing the bulb when ceiling mounted. “Caution must be used to prevent any loose parts from falling out of projector.”
-  **Warning:** Lamp compartment may be hot! Allow it to cool down before changing the lamp!
-  **Warning:** To reduce the risk of personal injury, do not drop the lamp module or touch the lamp bulb. The bulb may shatter and cause injury if it is dropped.

Note

- ❖ The screws on the lamp cover and the lamp cannot be removed.
- ❖ The projector cannot be turned on if the lamp cover has not been placed back on the projector.
- ❖ Do not touch the glass area of the lamp. Hand oil can cause the lamp to shatter. Use a dry cloth to clean the lamp module if it was accidentally touched.

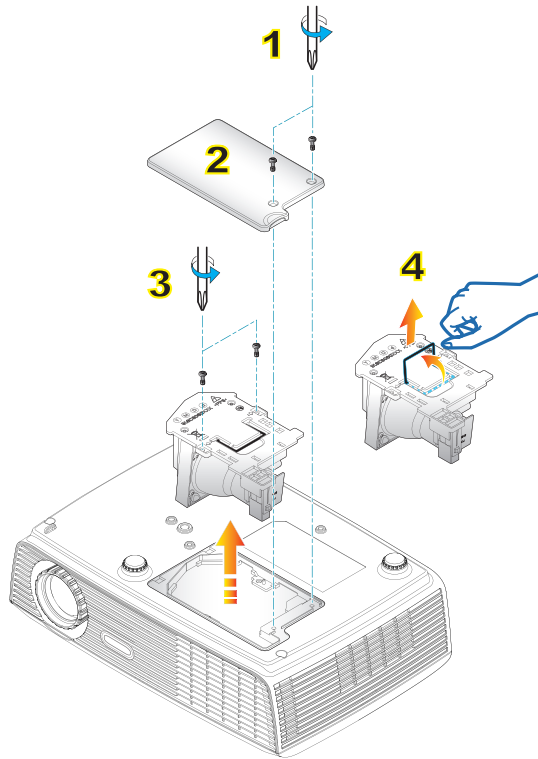

Lamp Replacement Procedure:

1. Switch off the power to the projector by pressing the "POWER" button.
 2. Allow the projector to cool down for at least 30 minutes.
 3. Disconnect the power cord.
 4. Unscrew the two screws on the cover. **1**
 5. Lift up and remove the cover. **2**
 6. Unscrew the two screws on the lamp module. **3**
 7. Lift up the lamp handle and remove the lamp module slowly and carefully. **4**
- To replace the lamp module, reverse the previous steps.
8. Turn on the projector and use "Lamp Reset" after the lamp module is replaced.
- Lamp Reset: (i) Press "MENU" → (ii) Select "OPTIONS" → (iii) Select "Lamp Settings" → (iv) Select "Lamp Reset" → (v) Select "Yes".

Compatibility Modes

► Computer Compatibility

Mode	Resolution	V-Sync (Hz)		H-Sync (KHz)	
		Anglog	Digital	Anglog	Digital
VGA	640 × 350	70	70	31.50	31.50
	640 × 350	85	85	37.90	37.90
	640 × 400	85	85	37.90	37.90
	640 × 480	60	60	31.50	31.50
	640 × 480	72	72	37.90	37.90
	640 × 480	75	75	37.50	37.50
	640 × 480	85	85	43.30	43.30
	720 × 400	70	70	31.50	31.50
	720 × 400	85	85	37.90	37.90
SVGA	800 × 600	56	56	35.20	35.20
	800 × 600	60	60	37.90	37.90
	800 × 600	72	72	48.10	48.10
	800 × 600	75	75	46.90	46.90
	800 × 600	85	85	53.70	53.70
	800 × 600	120	120	---	---
XGA	1024 × 768	60	60	48.40	48.40
	1024 × 768	70	70	56.50	56.50
	1024 × 768	75	75	60.00	60.00
	1024 × 768	85	85	68.70	68.70
	1024 × 768	120	120	---	---
	1280 × 720	60	60	44.70	44.70
	1280 × 720	120	120	---	---
	1280 × 768	60	60	47.80	47.80
SXGA	1280 × 800	---	60	---	49.64
	1152 × 864	60	60	53.50	53.50
	1152 × 864	70	70	63.80	63.80
	1152 × 864	75	75	67.50	67.50
	1152 × 864	85	85	77.10	77.10
	1280 × 1024	60	60	63.98	63.98
	1280 × 1024	75	75	79.98	79.98
	1280 × 1024	85	85	91.10	91.10
	1280 × 960	60	---	60.00	---
	WXGA	1280 × 800	60	---	49.68
SXGA+	1400 × 1050	60	60	63.98	63.98
	1680 × 1050	60	60	64.70	64.70
	UXGA	1600 × 1200	60	60	75.00

Note

- ❖ For widescreen resolution (WXGA), the compatibility support is dependent on Notebook/PC models.
- ❖ 120Hz input signals may be dependent on graphics cards support.

▶ Computer Compatibility

Mode	Resolution	V-Sync (Hz)		H-Sync (KHz)	
		Anglog	Digital	Anglog	Digital
MAC LC 13"	640 × 480	66.66	---	34.98	---
MAC II 13"	640 × 480	66.68	---	35.00	---
MAC 16"	832 × 624	75	75	49.73	49.73
MAC 19"	1024 × 768	75	---	60.24	---
MAC	1152 × 870	75	---	68.68	---
MAC G4	640 × 480	60	---	31.35	---
i MAC DV	1024 × 768	75	---	60.00	---
i MAC DV	1152 × 870	75	75	68.49	68.49
i MAC DV	1280 × 960	75	---	75.00	---

▶ Video Compatibility

NTSC	M (3.58MHz), 4.43 MHz, 480i/p @60Hz
PAL	B, D, G, H, I, M, N, 576i/p @50Hz
SECAM	B, D, G, K, K1, L
SDTV/HDTV	480i/p, 576i/p, 720p@50Hz/60Hz, 1080i/p@50Hz/60Hz

RS232 Commands

RS232 Pin Assignments

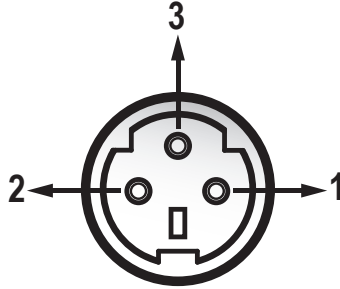

Pin no.	Name	I/O (From Projector Side)
1	TXD	OUT
2	RXD	IN
3	GND	GND

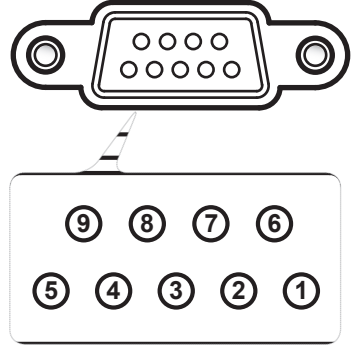

Pin no.	Spec.
1	N/A
2	RXD
3	TXD
4	N/A
5	GND
6	N/A
7	N/A
8	N/A
9	N/A

RS232 Protocol Function List



1. There is a <CR> after all ASCII commands.
2. 0D is the HEX code for <CR> in ASCII code.

Baud Rate : 9600
 Data Bits: 8
 Parity: None
 Stop Bits: 1
 Flow Control : None
 UART16550 FIFO: Disable
 Projector Return (Pass): P
 Projector Return (Fail): F

XX=00-99, projector's ID,
 XX=00 is for all projectors

SEND to projector

232 ASCII Code	HEX Code	Function	Projector Return	Description
~XX00 1 ~XX00 0	7E 30 30 30 30 20 31 0D	Power ON 7E 30 30 30 30 20 30 0D	Power OFF (0/2 for backward compatible)	
~XX01 1 ~XX02 1 ~XX02 0 ~XX03 1 ~XX03 0 ~XX04 1 ~XX04 0 ~XX12 1 ~XX12 5 ~XX12 9 ~XX12 10	7E 30 30 30 31 20 31 0D 7E 30 30 30 32 20 31 0D 7E 30 30 30 32 20 30 0D 7E 30 30 30 33 20 31 0D 7E 30 30 30 33 20 30 0D 7E 30 30 30 34 20 31 0D 7E 30 30 30 34 20 30 0D 7E 30 30 31 32 20 31 0D 7E 30 30 31 32 20 35 0D 7E 30 30 31 32 20 39 0D 7E 30 30 31 32 20 31 30 0D	Resync AV Mute Mute Freeze Unfreeze Direct Source Commands	On Off (0/2 for backward compatible) On Off (0/2 for backward compatible) (0/2 for backward compatible) HDMI VGA S-Video Video	
~XX20 2 ~XX20 11 ~XX20 5 ~XX20 3 ~XX20 4 ~XX20 9	7E 30 30 32 30 20 32 0D 7E 30 30 32 30 20 31 31 0D 7E 30 30 32 30 20 35 0D 7E 30 30 32 30 20 33 0D 7E 30 30 32 30 20 34 0D 7E 30 30 32 30 20 39 0D	Display Mode	Bright Cinema User Photo Reference 3D	
~XX21 n ~XX22 n ~XX23 n	7E 30 30 32 31 20 a 0D 7E 30 30 32 32 20 a 0D 7E 30 30 32 33 20 a 0D	Brightness Contrast Sharpness		n = 0 (a=30) ~ 100 (a=31 30 30) n = 0 (a=30) ~ 100 (a=31 30 30) n = 0 (a=30) ~ 31 (a=33 31)
~XX24 n ~XX25 n ~XX26 n ~XX27 n ~XX28 n ~XX29 n ~XX33 1	7E 30 30 32 34 20 a 0D 7E 30 30 32 35 20 a 0D 7E 30 30 32 36 20 a 0D 7E 30 30 32 37 20 a 0D 7E 30 30 32 38 20 a 0D 7E 30 30 32 39 20 a 0D 7E 30 30 33 33 20 31 0D	Color Settings	Red Gain Green Gain Blue Gain Red Bias Green Bias Blue Bias Reset	n = -50 (a=2D 35 30) ~ 50 (a=35 30) n = -50 (a=2D 35 30) ~ 50 (a=35 30) n = -50 (a=2D 35 30) ~ 50 (a=35 30) n = -50 (a=2D 35 30) ~ 50 (a=35 30) n = -50 (a=2D 35 30) ~ 50 (a=35 30) n = -50 (a=2D 35 30) ~ 50 (a=35 30)
~XX34 n ~XX35 1 ~XX35 2 ~XX35 3	7E 30 30 33 34 20 a 0D 7E 30 30 33 35 20 31 0D 7E 30 30 33 35 20 32 0D 7E 30 30 33 35 20 33 0D	BrilliantColor™ Degamma	Film Video Graphics	n = 0 (a=30) ~ 10 (a=31 30)
~XX36 1 ~XX36 2 ~XX36 3	7E 30 30 33 36 20 31 0D 7E 30 30 33 36 20 32 0D 7E 30 30 33 36 20 33 0D	Color Temp.	Warm Medium Cold	
~XX39 1 ~XX39 5 ~XX39 9 ~XX39 10	7E 30 30 33 39 20 31 0D 7E 30 30 33 39 20 35 0D 7E 30 30 33 39 20 39 0D 7E 30 30 33 39 20 31 30 0D	Input source Enable/Disable	HDMI VGA S-VIDEO VIDEO	
~XX44 n ~XX45 n	7E 30 30 34 34 20 a 0D 7E 30 30 34 35 20 a 0D	Color (Saturation) Tint		n = 0 (a=30) ~ 100 (a=31 30 30)
~XX60 1 ~XX60 2 ~XX60 5 ~XX60 6 ~XX60 7	7E 30 30 36 30 20 31 0D 7E 30 30 36 30 20 32 0D 7E 30 30 36 30 20 35 0D 7E 30 30 36 30 20 36 0D 7E 30 30 36 30 20 37 0D	Format	4:3 16:9 LBX Native Auto	
~XX61 n ~XX62 n ~XX64 n ~XX66 n	7E 30 30 36 31 20 a 0D 7E 30 30 36 32 20 a 0D 7E 30 30 36 34 20 a 0D 7E 30 30 36 36 20 a 0D	EdgeMask OverScan V Image Shift V Keystone		n = 0 (a=30) ~ 10 (a=33) n = -10 (a=2D 31, 30) ~ +40 (a=34 30) n = -50 (a=2D 35 30) ~ +50 (a=35 30) n = -40 (a=2D 34 30) ~ 40 (a=34 30)

Appendices

232 ASCII Code	HEX Code	Function	Projector Return	Description
~XX230 3	7E 30 30 32 33 30 20 31 0D	3D Mode	Nvidia 3D Vision	
~XX230 1	7E 30 30 32 33 30 20 31 0D	3D Mode	DLP-Link	
~XX230 0	7E 30 30 32 33 30 20 30 0D	3D Mode	Off	
~XX231 1	7E 30 30 32 33 31 20 31 0D	3D Sync Invert	On	
~XX231 0	7E 30 30 32 33 31 20 30 0D	3D Sync Invert	Off	
~XX70 1	7E 30 30 37 30 20 31 0D	Language	English	
~XX70 2	7E 30 30 37 30 20 32 0D		German	
~XX70 3	7E 30 30 37 30 20 33 0D		French	
~XX70 4	7E 30 30 37 30 20 34 0D		Italian	
~XX70 5	7E 30 30 37 30 20 35 0D		Spanish	
~XX70 6	7E 30 30 37 30 20 36 0D		Portuguese	
~XX70 7	7E 30 30 37 30 20 37 0D		Polish	
~XX70 8	7E 30 30 37 30 20 38 0D		Dutch	
~XX70 9	7E 30 30 37 30 20 39 0D		Swedish	
~XX70 10	7E 30 30 37 30 20 31 30 0D		Norwegian/Danish	
~XX70 12	7E 30 30 37 30 20 31 32 0D		Greek	
~XX70 13	7E 30 30 37 30 20 31 33 0D		Traditional Chinese	
~XX70 14	7E 30 30 37 30 20 31 34 0D		Simplified Chinese	
~XX70 15	7E 30 30 37 30 20 31 35 0D		Japanese	
~XX70 16	7E 30 30 37 30 20 31 36 0D		Korean	
~XX70 17	7E 30 30 37 30 20 31 37 0D		Russian	
~XX70 18	7E 30 30 37 30 20 31 38 0D		Hungarian	
~XX70 19	7E 30 30 37 30 20 31 39 0D		Czechoslovak	
~XX70 20	7E 30 30 37 30 20 32 30 0D		Arabic	
~XX70 21	7E 30 30 37 30 20 32 31 0D		Thai	
~XX70 22	7E 30 30 37 30 20 32 32 0D		Turkish	
~XX70 23	7E 30 30 37 30 20 32 33 0D		Norwegian	
~XX70 24	7E 30 30 37 30 20 32 34 0D		Farsi	
~XX71 1	7E 30 30 37 31 20 31 0D	Projection	Front-Desktop	
~XX71 2	7E 30 30 37 31 20 32 0D		Rear-Desktop	
~XX71 3	7E 30 30 37 31 20 33 0D		Front-Ceiling	
~XX71 4	7E 30 30 37 31 20 34 0D		Rear-Ceiling	
~XX72 1	7E 30 30 37 32 20 31 0D	Menu Location	Top Left	
~XX72 2	7E 30 30 37 32 20 32 0D		Top Right	
~XX72 3	7E 30 30 37 32 20 33 0D		Centre	
~XX72 4	7E 30 30 37 32 20 34 0D		Bottom Left	
~XX72 5	7E 30 30 37 32 20 35 0D		Bottom Right	
~XX91 n	7E 30 30 39 31 20 a 0D	Signal	Automatic	n=0 disable; n=1 enable
~XX73 n	7E 30 30 37 33 20 a 0D		Frequency	n = -5 (a=2D 35) ~ 5 (a=35) By signal
~XX74 n	7E 30 30 37 34 20 a 0D		Phase	n = 0 (a=30) ~ 31 (a=33 31) By signal
~XX75 n	7E 30 30 37 35 20 a 0D		H. Position	n = -5 (a=2D 35) ~ 5 (a=35) By timing
~XX76 n	7E 30 30 37 36 20 a 0D		V. Position	n = -5 (a=2D 35) ~ 5 (a=35) By timing
~XX77 n	7E 30 30 37 37 20 aabccc 0D	Security	Security Timer	Month/Day/Hour n = mm/dd/hh mm = 00 (aa=30 30) ~ 12 (aa=31 32) dd = 00 (bb=30 30) ~ 30 (bb=33 30) hh = 00 (cc=30 30) ~ 24 (cc=32 34)
~XX78 1	7E 30 30 37 38 20 31 0D		Security Settings	Enable
~XX78 2	7E 30 30 37 38 20 32 0D			Disable
~XX79 n	7E 30 30 37 39 20 a 0D	Projector ID		n = 00 (a=30 30) ~ 99 (a=39 39)
~XX80 1	7E 30 30 38 30 20 31 0D	Mute	On	
~XX80 0	7E 30 30 38 30 20 30 0D		Off (0/2 for backward compatible)	
~XX81 n	7E 30 30 38 31 20 a 0D	Volume		n = 0 (a=30) ~ 10 (a=31 30)
~XX100 1	7E 30 30 31 30 20 31 0D	Source Lock	On	
~XX100 0	7E 30 30 31 30 20 30 0D		Off (0/2 for backward compatible)	
~XX100 3	7E 30 30 31 30 30 20 33 0D	Next Source		
~XX101 1	7E 30 30 31 30 31 20 31 0D	High Altitude	On	
~XX101 0	7E 30 30 31 30 31 20 30 0D		Off (0/2 for backward compatible)	
~XX102 1	7E 30 30 31 30 32 20 31 0D	Information Hide	On	
~XX102 0	7E 30 30 31 30 32 20 30 0D		Off (0/2 for backward compatible)	
~XX104 1	7E 30 30 31 30 34 20 31 0D	Background Color	Blue	
~XX104 2	7E 30 30 31 30 34 20 32 0D		Black	
~XX104 3	7E 30 30 31 30 34 20 33 0D		Red	
~XX104 4	7E 30 30 31 30 34 20 34 0D		Green	
~XX104 5	7E 30 30 31 30 34 20 35 0D		White	
~XX106 n	7E 30 30 31 30 36 20 a 0D		Auto Power Off (min)	n = 0 (a=30) ~ 180 (a=31 38 30) step:5
~XX107 n	7E 30 30 31 30 37 20 a 0D		Sleep Timer (min)	n = 0 (a=30) ~ 995 (a=39 39 35) step:5
~XX109 1	7E 30 30 31 30 39 20 31 0D		Lamp Reminder	On
~XX109 0	7E 30 30 31 30 39 20 30 0D			Off (0/2 for backward compatible)
~XX110 1	7E 30 30 31 31 30 20 31 0D		Brightness Mode	Bright
~XX110 0	7E 30 30 31 31 30 20 30 0D			STD (0/2 for backward compatible)
~XX111 1	7E 30 30 31 31 31 20 31 0D		Lamp Reset	Yes
~XX111 0	7E 30 30 31 31 31 20 30 0D			No (0/2 for backward compatible)
~XX112 1	7E 30 30 31 31 32 20 31 0D	Reset		Yes

Appendices

232 ASCII Code	HEX Code	Function	Projector Return	Description
--XX99 1	7E 30 30 39 39 20 31 0D	RS232 Alert Reset	Reset System Alert	
--XX210 n	7E 30 30 32 30 30 20 n 0D	Display message on the OSD		n: 1-30 characters
--XX230 2	7E 30 30 32 33 30 20 32 0D	3D Mode	Nvidia 3D Vision	
--XX230 1	7E 30 30 32 33 30 20 31 0D	3D Mode	DLP-Link	
--XX230 0	7E 30 30 32 33 30 20 30 0D	3D Mode	Off	
--XX231 1	7E 30 30 32 33 31 20 31 0D	3D Sync Invert	On	
--XX231 0	7E 30 30 32 33 31 20 30 0D	3D Sync Invert	Off	

SEND to emulate Remote

--XX140 1	7E 30 30 31 34 30 20 31 0D		Power	
--XX140 10	7E 30 30 31 34 30 20 31 30 0D		Up/Page +	
--XX140 11	7E 30 30 31 34 30 20 31 31 0D		Left/Source	
--XX140 12	7E 30 30 31 34 30 20 31 32 0D		Enter (for projection MENU)	
--XX140 13	7E 30 30 31 34 30 20 31 33 0D		Right/Re-SYNC	
--XX140 14	7E 30 30 31 34 30 20 31 34 0D		Down/Page -	
--XX140 19	7E 30 30 31 34 30 20 31 39 0D		Brightness (1)	
--XX140 20	7E 30 30 31 34 30 20 32 30 0D		Menu (2)	
--XX140 22	7E 30 30 31 34 30 20 32 32 0D		HDMI (4)	
--XX140 25	7E 30 30 31 34 30 20 32 35 0D		S-Video (7)	
--XX140 26	7E 30 30 31 34 30 20 32 36 0D		VGA1/2 toggle (8)	
--XX140 27	7E 30 30 31 34 30 20 32 37 0D		Video (9)	
--XX140 28	7E 30 30 31 34 30 20 32 38 0D		4:3	
--XX140 29	7E 30 30 31 34 30 20 32 39 0D		16:9	
--XX140 30	7E 30 30 31 34 30 20 33 30 0D		LBX	
--XX140 31	7E 30 30 31 34 30 20 33 31 0D		Native	
--XX140 32	7E 30 30 31 34 30 20 33 32 0D		Lamp Mode	
--XX140 33	7E 30 30 31 34 30 20 33 33 0D		Mode	
--XX140 34	7E 30 30 31 34 30 20 33 34 0D		Contrast	
--XX140 35	7E 30 30 31 34 30 20 33 35 0D		EdgeMask	
--XX140 36	7E 30 30 31 34 30 20 33 36 0D		Source Lock	
--XX140 37	7E 30 30 31 34 30 20 33 37 0D		Overscan	

SEND from projector automatically

232 ASCII Code	HEX Code	Function	Projector Return	Description
when Standby/Warming/Cooling/Out of Range/Lamp fail/ Fan Lock/Over Temperature/Lamp Hours Running Out/Cover Open			INFOn	n : 0/1/2/3/4/6/7/8/9 = Standby/Warming/Cooling/Out of Range/Lamp fail/ Fan Lock/Over Temperature/Lamp Hours Running Out/Cover Open

READ from projector

232 ASCII Code	HEX Code	Function	Projector Return	Description
--XX121 1	7E 30 30 31 32 31 20 31 0D	Input Source Commands	OKn	n : 0/1/2/3/4 = None/VGA/SVideo/Video/HDMI
--XX122 1	7E 30 30 31 32 32 20 31 0D	Software Version	OKddd	ddd: FW version
--XX123 1	7E 30 30 31 32 33 20 31 0D	Display Mode	OKn	n : 0/1/2/3/4/5/6/7/8/9/10 = None/Presentation/Bright/Game/Blackboard/ Classroom/Cinema/User/3D/Photo/Reference
--XX124 1	7E 30 30 31 32 34 20 31 0D	Power State	OKn	n : 0/1 = Off/On
--XX125 1	7E 30 30 31 32 35 20 31 0D	Brightness	OKn	
--XX126 1	7E 30 30 31 32 36 20 31 0D	Contrast	OKn	
--XX127 1	7E 30 30 31 32 37 20 31 0D	Aspect Ratio	OKn	n : 0/1/2/3/4/5 = 4:3/16:10/LBX/Native/AUTO/16:9
--XX128 1	7E 30 30 31 32 38 20 31 0D	Color Temperature	OKn	n : 0/1/2 = Warm/Medium/Cold
--XX129 1	7E 30 30 31 32 39 20 31 0D	Projection Mode	OKn	n : 0/1/2/3 = Front-Desktop/ Rear-Desktop/ Front-Ceiling/Rear-Ceiling
--XX150 1	7E 30 30 31 35 30 20 31 0D	Information	OKabbbccdddde	a : 0/1 = Off/On bbb: LampHour cc: source 00/01/02/03/04 = None/VGA/S-Video/Video/HDMI ddd: FW version e : Display mode 0/1/2/3/4/5/6/7/8/9/10 None/Presentation/Bright/Game/Blackboard/ Classroom/Cinema/User/3D/Photo/Reference n:4=HD67 bbb: LampHour bbbb: (5 digits) Total Lamp Hours
--XX151 1	7E 30 30 31 35 31 20 31 0D	Model name	OKn	
--XX108 1	7E 30 30 31 30 38 20 31 0D	Lamp Hours	OKbbbb	
--XX108 2	7E 30 30 31 30 38 20 31 0D	Cumulative Lamp Hours	OKbbbb	

Ceiling Mount Installation

1. To prevent damage to your projector, please use the Optoma ceiling mount.
2. If you wish to use a third party ceiling mount kit, please ensure the screws used to attach a mount to the projector meet the following specifications:
 - ▶ Screw type: M3*3
 - ▶ Maximum screw length: 10mm
 - ▶ Minimum screw length: 7.5mm

Note

- ❖ Please note that damage resulting from incorrect installation will invalidate the warranty.

Note

- ⚠ Warning:
 1. If you buy a ceiling mount from another company, please be sure to use the correct screw size. Screw size will vary depending on the thickness of the mounting plate.
 2. Be sure to keep at least 10 cm gap between the ceiling and the bottom of the projector.
 3. Avoid installing the projector near a heat source.

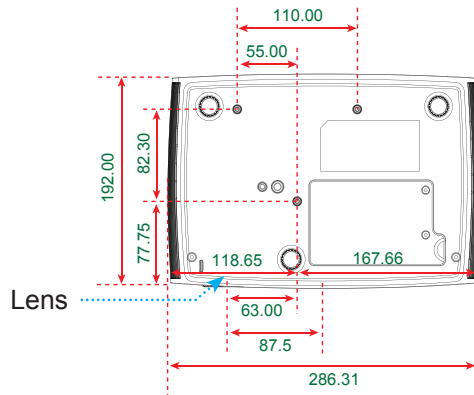
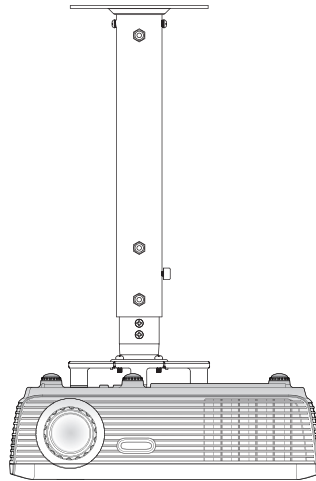

Unit: mm

Optoma Global Offices

For service or support please contact your local office.



USA

715 Sycamore Drive
Milpitas, CA 95035, USA
www.optomausa.com

 +408-383-3700
 +408-383-3702
 services@optoma.com

Canada

5630 Kennedy Road, Mississauga,
ON, L4Z 2A9, Canada
www.optoma.ca

 905-361-2582
 905-361-2581
 canadacsragent@optoma.com



Europe

42 Caxton Way, The Watford Business Park
Watford, Hertfordshire,
WD18 8QZ, UK
www.optoma.eu
Service Tel : +44 (0)1923 691865

 +44 (0) 1923 691 800
 +44 (0) 1923 691 888
 service@tsc-europe.com



France

Bâtiment E
81-83 avenue Edouard Vaillant
92100 Boulogne Billancourt, France

 +33 1 41 46 12 20
 +33 1 41 46 94 35
 savoptoma@optoma.fr



Spain

C/ José Hierro,36 Of. 1C
28529 Rivas VaciaMadrid,
Spain

 +34 91 499 06 06
 +34 91 670 08 32



Deutschland

Werftstrasse 25
D40549 Düsseldorf,
Germany

 +49 (0) 211 506 6670
 +49 (0) 211 506 66799
 info@optoma.de



Scandinavia

Grev Wedels Plass 2
3015 Drammen
Norway

 +47 32 26 89 90
 +47 32 83 78 98
 info@optoma.no



Latin America

715 Sycamore Drive
Milpitas, CA 95035, USA
www.optoma.com.br

 408-383-3700
 408-383-3702
www.optoma.com.mx

Korea

WOOMI TECH.CO.,LTD.
4F,Minu Bldg,33-14, Kangnam-Ku,
seoul,135-815, KOREA

 +82+2+34430004
 +82+2+34430005

Japan



3-25-18

:0120-46-5040

 info@osscreen.com
www.os-worldwide.com



Taiwan

5F., No. 108, Minchiuan Rd.
Shindian City,
Taipei Taiwan 231, R.O.C.
www.optoma.com.tw

 +886-2-2218-2360
 +886-2-2218-2313
 services@optoma.com.tw
asia.optoma.com



Hong Kong

Unit A, 27/F Dragon Centre,
79 Wing Hong Street,
Cheung Sha Wan,
Kowloon, Hong Kong

 +852-2396-8968
 +852-2370-1222
www.optoma.com.hk

China

5F, No. 1205, Kaixuan Rd.,
Changning District
Shanghai, 200052, China

 +86-21-62947376
 +86-21-62947375
www.optoma.com.cn

Regulation & Safety notices

This appendix lists the general notices of your projector.

FCC notice

This device has been tested and found to comply with the limits for a Class B digital device pursuant to Part 15 of the FCC rules. These limits are designed to provide reasonable protection against harmful interference in a residential installation. This device generates, uses and can radiate radio frequency energy and, if not installed and used in accordance with the instructions, may cause harmful interference to radio communications.

However, there is no guarantee that interference will not occur in a particular installation. If this device does cause harmful interference to radio or television reception, which can be determined by turning the device off and on, the user is encouraged to try to correct the interference by one or more of the following measures:

- Reorient or relocate the receiving antenna.
- Increase the separation between the device and receiver.
- Connect the device into an outlet on a circuit different from that to which the receiver is connected.
- Consult the dealer or an experienced radio/television technician for help.

Notice: Shielded cables

All connections to other computing devices must be made using shielded cables to maintain compliance with FCC regulations.

Caution

Changes or modifications not expressly approved by the manufacturer could void the user's authority, which is granted by the Federal Communications Commission, to operate this projector.

Operation conditions

This device complies with Part 15 of the FCC Rules. Operation is subject to the following two conditions:

1. This device may not cause harmful interference and
2. This device must accept any interference received, including interference that may cause undesired operation.

Notice: Canadian users

This Class B digital apparatus complies with Canadian ICES-003.

Remarque à l'intention des utilisateurs canadiens

Cet appareil numérique de la classe B est conforme à la norme NMB-003 du Canada.

Declaration of Conformity for EU countries

- EMC Directive 2004/108/EC (including amendments)
- Low Voltage Directive 2006/95/EC
- R & TTE Directive 1999/5/EC (if product has RF function)

Disposal instructions



Do not throw this electronic device into the trash when discarding. To minimize pollution and ensure utmost protection of the global environment, please recycle it.