



DLP® Projector

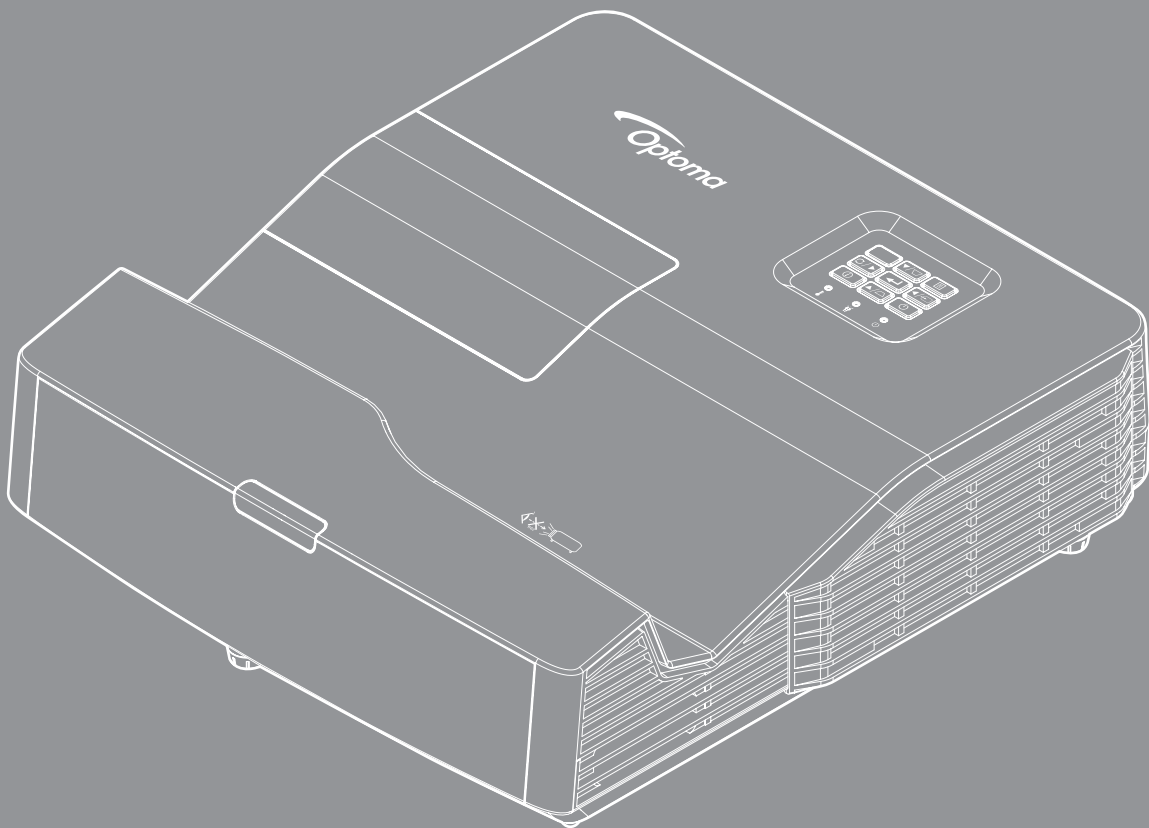

TABLE OF CONTENTS

SAFETY	4
<i>Important Safety Instruction.....</i>	<i>4</i>
<i>3D Safety Information.....</i>	<i>5</i>
<i>Copyright.....</i>	<i>6</i>
<i>Disclaimer.....</i>	<i>6</i>
<i>Trademark Recognition</i>	<i>6</i>
<i>FCC</i>	<i>7</i>
<i>Declaration of Conformity for EU countries</i>	<i>7</i>
<i>WEEE.....</i>	<i>7</i>
INTRODUCTION	8
<i>Package Overview.....</i>	<i>8</i>
<i>Standard accessories.....</i>	<i>8</i>
<i>Optional accessories.....</i>	<i>8</i>
<i>Product Overview</i>	<i>9</i>
<i>Connections.....</i>	<i>10</i>
<i>Keypad</i>	<i>11</i>
<i>Remote control.....</i>	<i>12</i>
SETUP AND INSTALLATION.....	13
<i>Installing the projector</i>	<i>13</i>
<i>Connecting sources to the projector.....</i>	<i>15</i>
<i>Adjusting the projector image.....</i>	<i>16</i>
<i>Remote setup</i>	<i>17</i>
USING THE PROJECTOR	19
<i>Powering on / off the projector.....</i>	<i>19</i>
<i>Selecting an input source</i>	<i>20</i>
<i>Menu navigation and features</i>	<i>21</i>
<i>OSD Menu tree.....</i>	<i>22</i>
<i>Display image settings menu.....</i>	<i>31</i>
<i>Display 3D menu</i>	<i>33</i>
<i>Display aspect ratio menu</i>	<i>33</i>
<i>Display edge mask menu</i>	<i>37</i>
<i>Display zoom menu.....</i>	<i>37</i>
<i>Display image shift menu</i>	<i>37</i>
<i>Display geometric correction menu</i>	<i>38</i>
<i>Audio mute menu</i>	<i>38</i>
<i>Audio volume menu.....</i>	<i>38</i>
<i>Audio out (standby) menu</i>	<i>38</i>
<i>Setup projection menu.....</i>	<i>39</i>
<i>Setup screen type menu.....</i>	<i>39</i>
<i>Setup lamp settings menu.....</i>	<i>39</i>

<i>Setup filter settings menu</i>	39
<i>Setup power settings menu</i>	39
<i>Setup security menu</i>	40
<i>Setup HDMI link settings menu</i>	41
<i>Setup test pattern menu</i>	41
<i>Setup remote settings menu</i>	41
<i>Setup projector ID menu</i>	41
<i>Setup options menu</i>	41
<i>Setup reset all menu</i>	42
<i>Network LAN menu</i>	43
<i>Network control menu</i>	44
<i>Setup network control settings menu</i>	45
<i>Info menu</i>	50
<i>USB Reader</i>	51
<i>USB Display</i>	55
<i>Network Display</i>	56



MAINTENANCE..... 59

<i>Replacing the lamp</i>	59
<i>Installing and cleaning the dust filter</i>	61

ADDITIONAL INFORMATION..... 62

<i>Compatible resolutions</i>	62
<i>Image size and projection distance</i>	64
<i>Projector dimensions and wall mount installation</i>	66
<i>IR remote codes</i>	67
<i>Troubleshooting</i>	69
<i>Warning indicators</i>	70
<i>Specifications</i>	73
<i>Optoma global offices</i>	74

SAFETY

	The lightning flash with arrow head within an equilateral triangle is intended to alert the user to the presence of uninsulated "dangerous voltage" within the product's enclosure that may be of sufficient magnitude to constitute a risk of electric shock to persons.
	The exclamation point within an equilateral triangle is intended to alert the user to the presence of important operating and maintenance (servicing) instructions in the literature accompanying the appliance.

Please follow all warnings, precautions and maintenance as recommended in this user's guide.

Important Safety Instruction

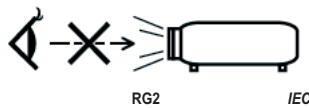

- Do not stare into the beam, RG2.
As with any bright source, do not stare into the direct beam, RG2 IEC 62471-5:2015.
- Do not block any ventilation openings. To ensure reliable operation of the projector and to protect from over heating, it is recommended to install the projector in a location that does not block ventilation. As an example, do not place the projector on a crowded coffee table, sofa, bed, etc. Do not put the projector in an enclosure such as a book case or a cabinet that restricts air flow.
- To reduce the risk of fire and/or electric shock, do not expose the projector to rain or moisture. Do not install near heat sources such as radiators, heaters, stoves or any other apparatus such as amplifiers that emits heat.
- Do not let objects or liquids enter the projector. They may touch dangerous voltage points and short out parts that could result in fire or electric shock.
- Do not use under the following conditions:
 - In extremely hot, cold or humid environments.
 - (i) Ensure that the ambient room temperature is within 5°C ~ 40°C
 - (ii) Relative humidity is 10% ~ 85%
 - In areas susceptible to excessive dust and dirt.
 - Near any appliance generating a strong magnetic field.
 - In direct sunlight.
- Do not use the projector in places where flammable gases or explosives gases may be present in the atmosphere. The lamp inside the projector becomes very hot during operation and the gases may ignite and result in a fire.
- Do not use the unit if it has been physically damaged or abused. Physical damage/abuse would be (but not limited to):
 - Unit has been dropped.
 - Power supply cord or plug has been damaged.
 - Liquid has been spilled on to the projector.
 - Projector has been exposed to rain or moisture.
 - Something has fallen in the projector or something is loose inside.
- Do not place the projector on an unstable surface. The projector may fall over resulting in injury or the projector may become damaged.
- Do not block the light coming out of the projector lens when in operation. The light will heat the object and cause melt, cause burns, or start a fire.

- Please do not open or disassemble the projector as this may cause electric shock.
- Do not attempt to service the unit yourself. Opening or removing covers may expose you to dangerous voltages or other hazards. Please call Optoma before you send the unit for repair.
- See projector enclosure for safety related markings.
- The unit should only be repaired by appropriate service personnel.
- Only use attachments/accessories specified by the manufacturer.
- Do not look into straight into the projector lens during operation. The bright light may harm your eyes.
- When replacing the lamp, please allow the unit to cool down. Follow instructions as described on pages 59-60.
- This projector will detect the life of the lamp itself. Please be sure to change the lamp when it shows warning messages.
- Reset the "Lamp Reset" function from the on-screen display "Setup > Lamp Settings" menu after replacing the lamp module.
- When switching the projector off, please ensure the cooling cycle has been completed before disconnecting power. Allow 90 seconds for the projector to cool down.
- When the lamp is approaching to the end of its life time, the message "Lamp life exceeded." will show on the screen. Please contact your local reseller or service center to change the lamp as soon as possible.
- Turn off and unplug the power plug from the AC outlet before cleaning the product.
- Use a soft dry cloth with mild detergent to clean the display housing. Do not use abrasive cleaners, waxes or solvents to clean the unit.
- Disconnect the power plug from AC outlet if the product is not being used for a long period of time.

Note: *When the lamp reaches the end of its life, the projector will not turn back on until the lamp module has been replaced. To replace the lamp, follow the procedures listed under "Replacing the Lamp" section on pages 59-60.*

- *Do not setup the projector in places where it might be subjected to vibration or shock.*
- *Do not touch the lens with bare hands*
- *Remove battery/batteries from remote control before storage. If the battery/batteries are left in the remote for long periods, they may leak.*
- *Do not use or store the projector in places where smoke from oil or cigarettes may be present, as it can adversely affect the quality of the projector performance.*
- *Please follow the correct projector orientation installation as non standard installation may affect the projector performance.*
- *Use a power strip and or surge protector. As power outages and brown-outs can KILL devices.*

3D Safety Information

Please follow all warnings and precautions as recommended before you or your child use the 3D function.

Warning

Children and teenagers may be more susceptible to health issues associated with viewing in 3D and should be closely supervised when viewing these images.

Photosensitive Seizure Warning and Other Health Risks

- Some viewers may experience an epileptic seizure or stroke when exposed to certain flashing images or lights contained in certain Projector pictures or video games. If you suffer from, or have a family history of epilepsy or strokes, please consult with a medical specialist before using the 3D function.
- Even those without a personal or family history of epilepsy or stroke may have an undiagnosed condition that can cause photosensitive epileptic seizures.
- Pregnant women, the elderly, sufferers of serious medical conditions, those who are sleep deprived or under the influence of alcohol should avoid utilizing the unit's 3D functionality.

- If you experience any of the following symptoms, stop viewing 3D pictures immediately and consult a medical specialist: (1) altered vision; (2) light-headedness; (3) dizziness; (4) involuntary movements such as eye or muscle twitching; (5) confusion; (6) nausea; (7) loss of awareness; (8) convulsions; (9) cramps; and/ or (10) disorientation. Children and teenagers may be more likely than adults to experience these symptoms. Parents should monitor their children and ask whether they are experiencing these symptoms.
- Watching 3D projection may also cause motion sickness, perceptual after effects, disorientation, eye strain and decreased postural stability. It is recommended that users take frequent breaks to lessen the potential of these effects. If your eyes show signs of fatigue or dryness or if you have any of the above symptoms, immediately discontinue use of this device and do not resume using it for at least thirty minutes after the symptoms have subsided.
- Watching 3D projection while sitting too close to the screen for an extended period of time may damage your eyesight. The ideal viewing distance should be at least three times the screen height. It is recommended that the viewer's eyes are level with the screen.
- Watching 3D projection while wearing 3D glasses for an extended period of time may cause a headache or fatigue. If you experience a headache, fatigue or dizziness, stop viewing the 3D projection and rest.
- Do not use the 3D glasses for any other purpose than for watching 3D projection.
- Wearing the 3D glasses for any other purpose (as general spectacles, sunglasses, protective goggles, etc.) may be physically harmful to you and may weaken your eyesight.
- Viewing in 3D projection may cause disorientation for some viewers. Accordingly, DO NOT place your 3D PROJECTOR near open stairwells, cables, balconies, or other objects that can be tripped over, run into, knocked down, broken or fallen over.

Copyright

This publication, including all photographs, illustrations and software, is protected under international copyright laws, with all rights reserved. Neither this manual, nor any of the material contained herein, may be reproduced without written consent of the author.

© Copyright 2018

Disclaimer

The information in this document is subject to change without notice. The manufacturer makes no representations or warranties with respect to the contents hereof and specifically disclaims any implied warranties of merchantability or fitness for any particular purpose. The manufacturer reserves the right to revise this publication and to make changes from time to time in the content hereof without obligation of the manufacturer to notify any person of such revision or changes.

Trademark Recognition

Kensington is a U.S. registered trademark of ACCO Brand Corporation with issued registrations and pending applications in other countries throughout the world.

HDMI, the HDMI Logo, and High-Definition USB Reader Interface are trademarks or registered trademarks of HDMI Licensing LLC in the United States and other countries.

DLP®, DLP Link and the DLP logo are registered trademarks of Texas Instruments and BrilliantColor™ is a trademark of Texas Instruments.

All other product names used in this manual are the properties of their respective owners and are Acknowledged.

MHL, Mobile High-Definition Link and the MHL Logo are trademarks or registered trademarks of MHL Licensing, LLC.

FCC

This device has been tested and found to comply with the limits for a Class B digital device pursuant to Part 15 of the FCC rules. These limits are designed to provide reasonable protection against harmful interference in a residential installation. This device generates, uses and can radiate radio frequency energy and, if not installed and used in accordance with the instructions, may cause harmful interference to radio communications.

However, there is no guarantee that interference will not occur in a particular installation. If this device does cause harmful interference to radio or television reception, which can be determined by turning the device off and on is encouraged to try to correct the interference by one or more of the following measures:

- Reorient or relocate the receiving antenna.
- Increase the separation between the device and receiver.
- Connect the device into an outlet on a circuit different from that to which the receiver is connected.
- Consult the dealer or an experienced radio/television technician for help.

Notice: Shielded cables

All connections to other computing devices must be made using shielded cables to maintain compliance with FCC regulations.

Caution

Changes or modifications not expressly approved by the manufacturer could void the user's authority, which is granted by the Federal Communications Commission, to operate this projector.

Operation Conditions

This device complies with Part 15 of the FCC Rules. Operation is subject to the following two conditions:

1. This device may not cause harmful interference and
2. This device must accept any interference received, including interference that may cause undesired operation.

Notice: Canadian users

This Class B digital apparatus complies with Canadian ICES-003.

Remarque à l'intention des utilisateurs canadiens

Cet appareil numérique de la classe B est conforme à la norme NMB-003 du Canada.

Declaration of Conformity for EU countries

- EMC Directive 2014/30/EU (including amendments)
- Low Voltage Directive 2014/35/EU
- RED 2014/53/EU (if product has RF function)
- RoHS Directive 2011/65/EU (if product has RF function)

WEEE



Disposal instructions

Do not throw this electronic device into the trash when discarding. To minimize pollution and ensure utmost protection of the global environment, please recycle it.

INTRODUCTION

Package Overview

Carefully unpack and verify that you have the items listed below under standard accessories. Some of the items under optional accessories may not be available depending on the model, specification and your region of purchase. Please check with your place of purchase. Some accessories may vary from region to region.

The warranty card is only supplied in some specific regions. Please consult your dealer for detailed information.

Standard accessories

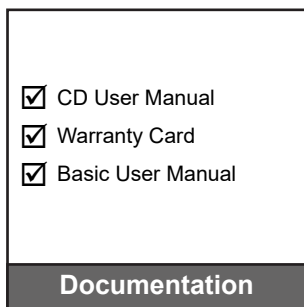
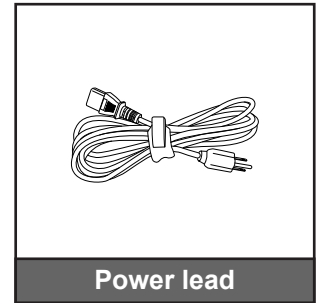
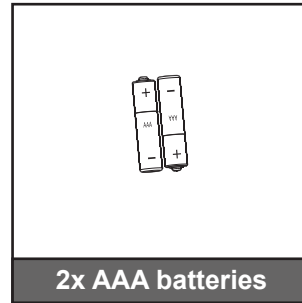
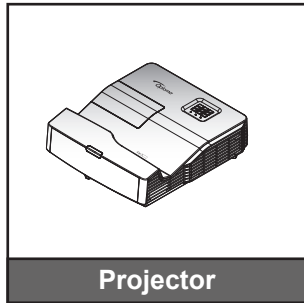

Note:

- The remote control is shipped with the batteries.
- *(1) For European User Manual please visit www.optomaeurope.com.
- *(2) For European warranty information please visit www.optomaeurope.com.
- *(3) The actual remote control may vary depending on the region.

Optional accessories

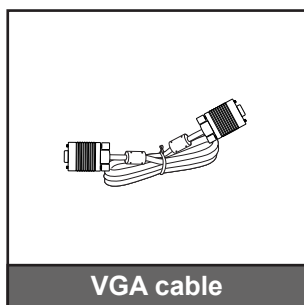

Note: Optional accessories vary depending on model, specification and region.

INTRODUCTION

Product Overview

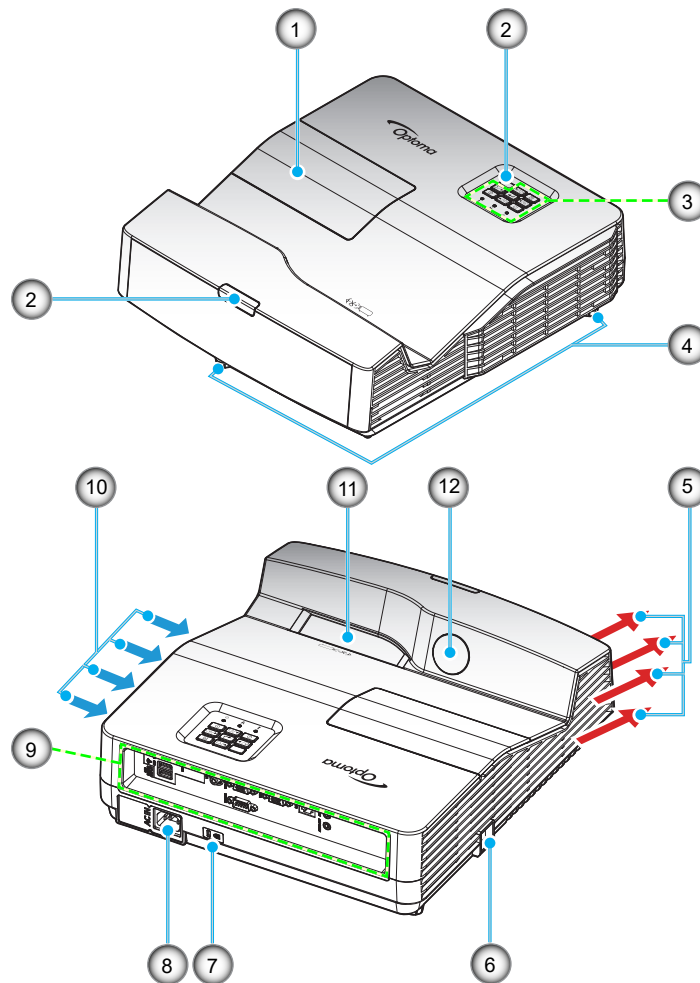

Note: Do not block projector inlet or outlet air vents.

(*) Optional accessory varies depending on model, specification, and region.

No	Item	No	Item
1.	Lamp Cover	7.	Kensington™ Lock Port
2.	IR Receiver	8.	Power Socket
3.	Keypad	9.	Input / Output
4.	Tilt-Adjustment Feet	10.	Ventilation (inlet)
5.	Ventilation (outlet)	11.	Lens
6.	Security Bar	12.	IR Camera (Only for interactive version)

INTRODUCTION

Connections

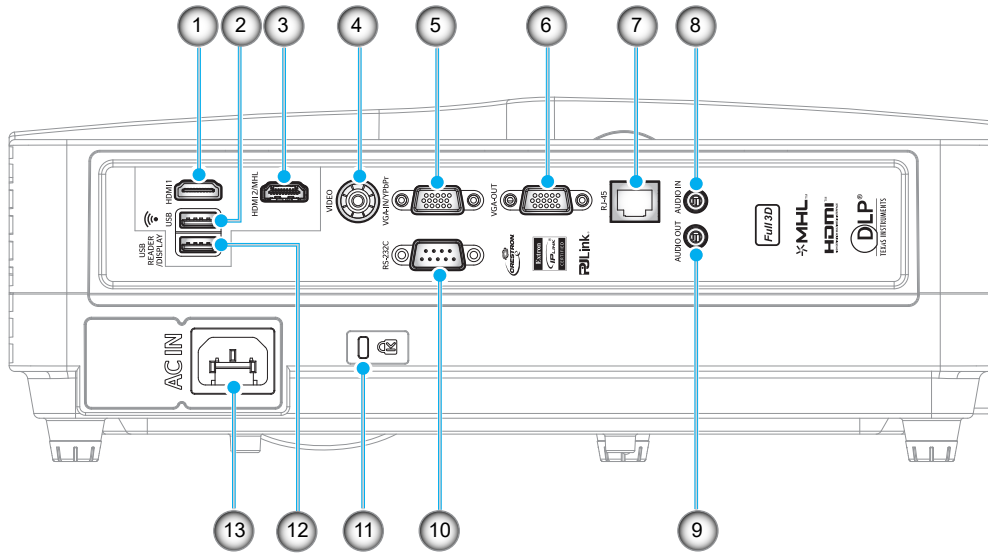

No	Item	No	Item
1.	HDMI 1 Connector	8.	AUDIO IN Connector
2.	USB Connector* for WiFi (dongle)	9.	AUDIO OUT Connector
3.	HDMI 2/MHL Connector	10.	RS-232C Connector
4.	VIDEO Connector	11.	Kensington™ Lock Port
5.	VGA-IN/YPbPr Connector	12.	USB READER/DISPLAY/FW UPGRADE/MOUSE/POWER Connector*
6.	VGA-OUT Connector	13.	Power Socket
7.	RJ-45 Connector		

Note:

- **Supports 5V/1A power output only if MHL source is not detected. If MHL source is detected, the 5V/1A power output is disabled automatically.*
- **Use the USB Connector for WiFi (dongle) and the USB READER/DISPLAY/FW UPGRADE/MOUSE/POWER connector as follows:*
 - *Network Display: (a) Plug in the WiFi USB dongle; (b) Use the HDcastPro APP on your mobile phone.*
 - *USB Display for iOS and Android devices.*
 - *USB Reader: Display pictures and documents from the USB disk directly.*

INTRODUCTION

Keypad

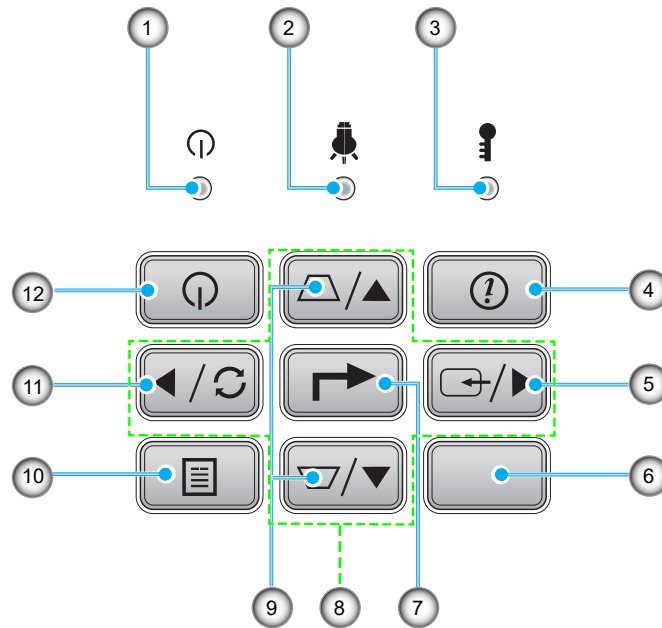

No	Item	No	Item
1.	On/Standby LED	7.	Enter
2.	Lamp LED	8.	Four Directional Select Keys
3.	Temp LED	9.	Keystone Correction
4.	Info	10.	Menu
5.	Source	11.	Re-Sync
6.	IR Receiver	12.	Power

INTRODUCTION

Remote control

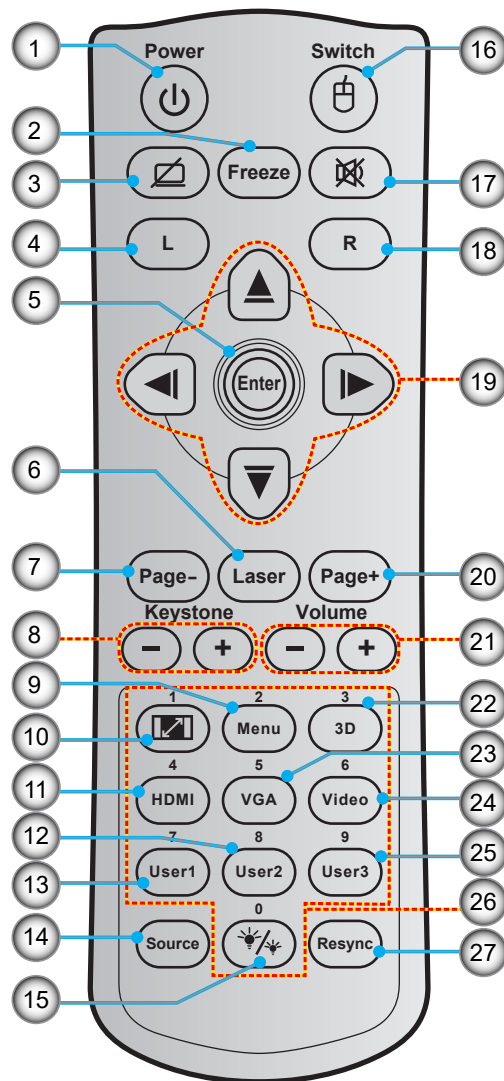

No	Item	No	Item
1.	Power On / Off	15.	Brightness Mode
2.	Freeze	16.	Mouse On / Off
3.	Display Blank / Audio Mute	17.	Mute
4.	Mouse Left Click	18.	Mouse Right Click
5.	Enter	19.	Four Directional Select Keys
6.	Laser	20.	Page +
7.	Page -	21.	Volume - / +
8.	Keystone - / +	22.	3D Menu On / Off
9.	Menu	23.	VGA
10.	Aspect Ratio	24.	Video
11.	HDMI	25.	User 3
12.	User 2	26.	Numeric Keypad (0-9)
13.	User 1	27.	Resync
14.	Source		

Note: Some keys may have no function for models that do not support these features.

SETUP AND INSTALLATION

Installing the projector

Your projector is designed to be installed in one of four possible positions.

Your room layout or personal preference will dictate which installation location you select. Take into consideration the size and position of your screen, the location of a suitable power outlet, as well as the location and distance between the projector and the rest of your equipment.

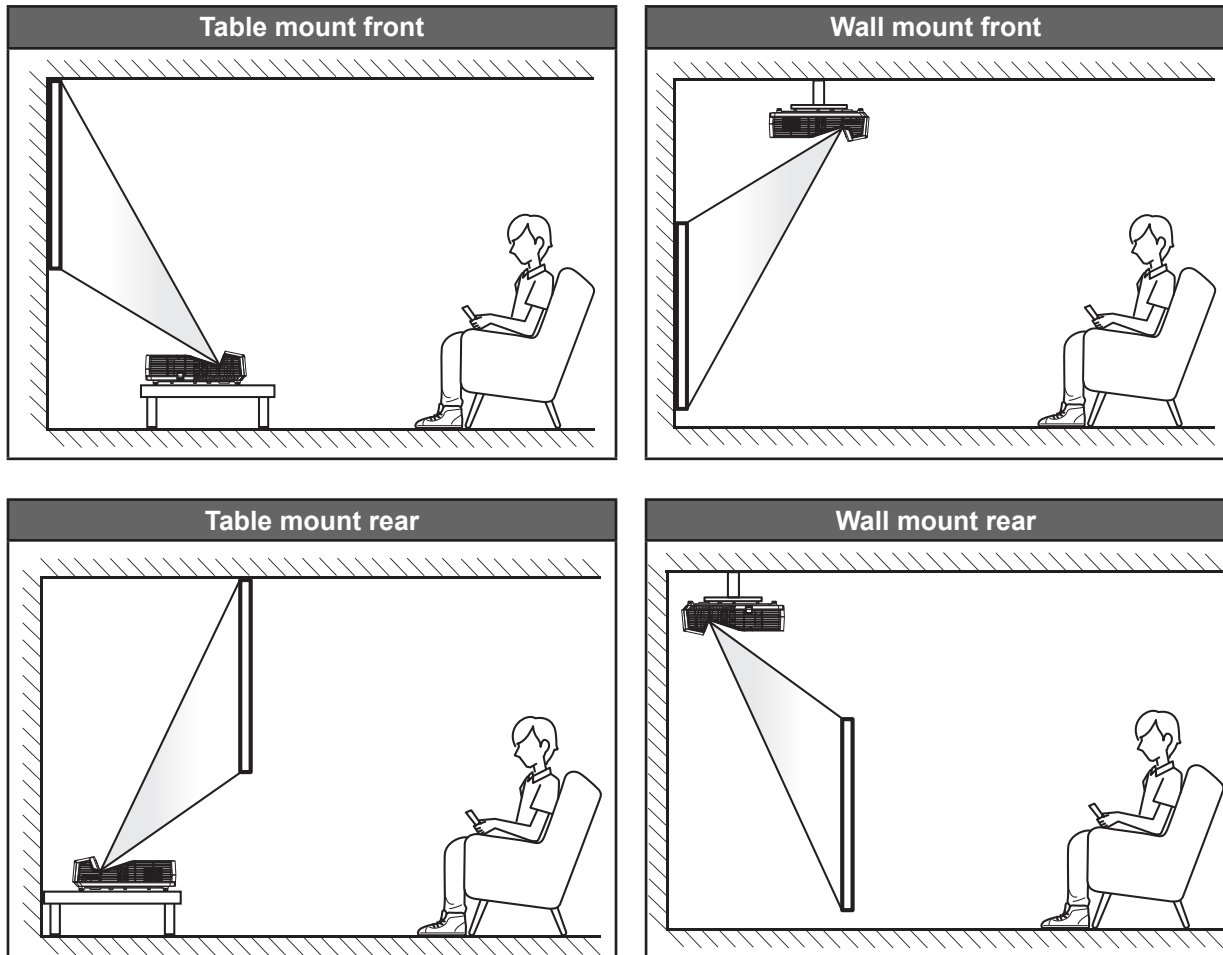

Projector should be placed flat on a surface and 90 degrees / perpendicular to the screen.

- How to determine projector location for a given screen size, please refer to distance table on pages 64-65.
- How to determine screen size for a given distance, please refer to distance table on pages 64-65.

Note: *The further away the projector is placed from the screen the projected image size increases and vertical offset also increases proportionally.*

IMPORTANT!

Do not operate the projector in any orientation other than table top or wall mount. The projector should be horizontal and not tilted either forwards/backwards or left/right. Any other orientation will invalidate the warranty and may shorten the lifetime of the projector lamp or the projector itself. For non standard installation advise please contact Optoma.

SETUP AND INSTALLATION

Projector installation notice

- Place the projector in a horizontal position.
The tilt angle of the projector should not exceed 15 degrees, nor should the projector be installed in any way other than the desktop and wall mount, otherwise lamp life could decrease dramatically, and may lead to other **unpredictable damages**.

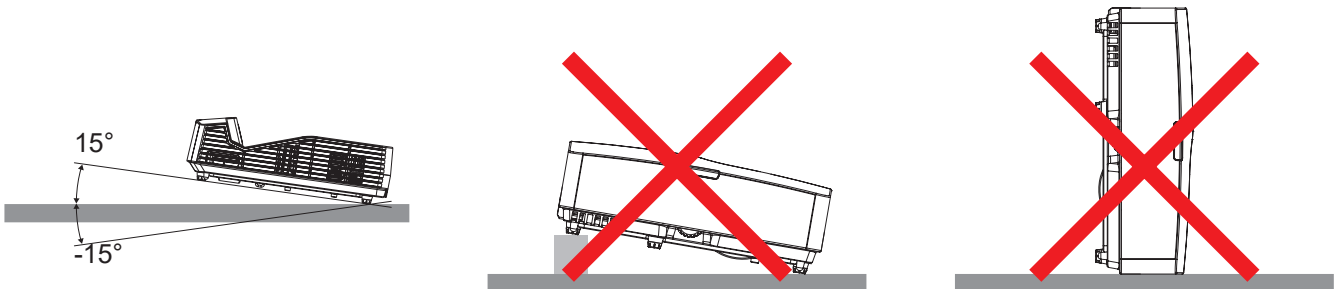

- Allow at least 20 cm clearance around the exhaust vent.

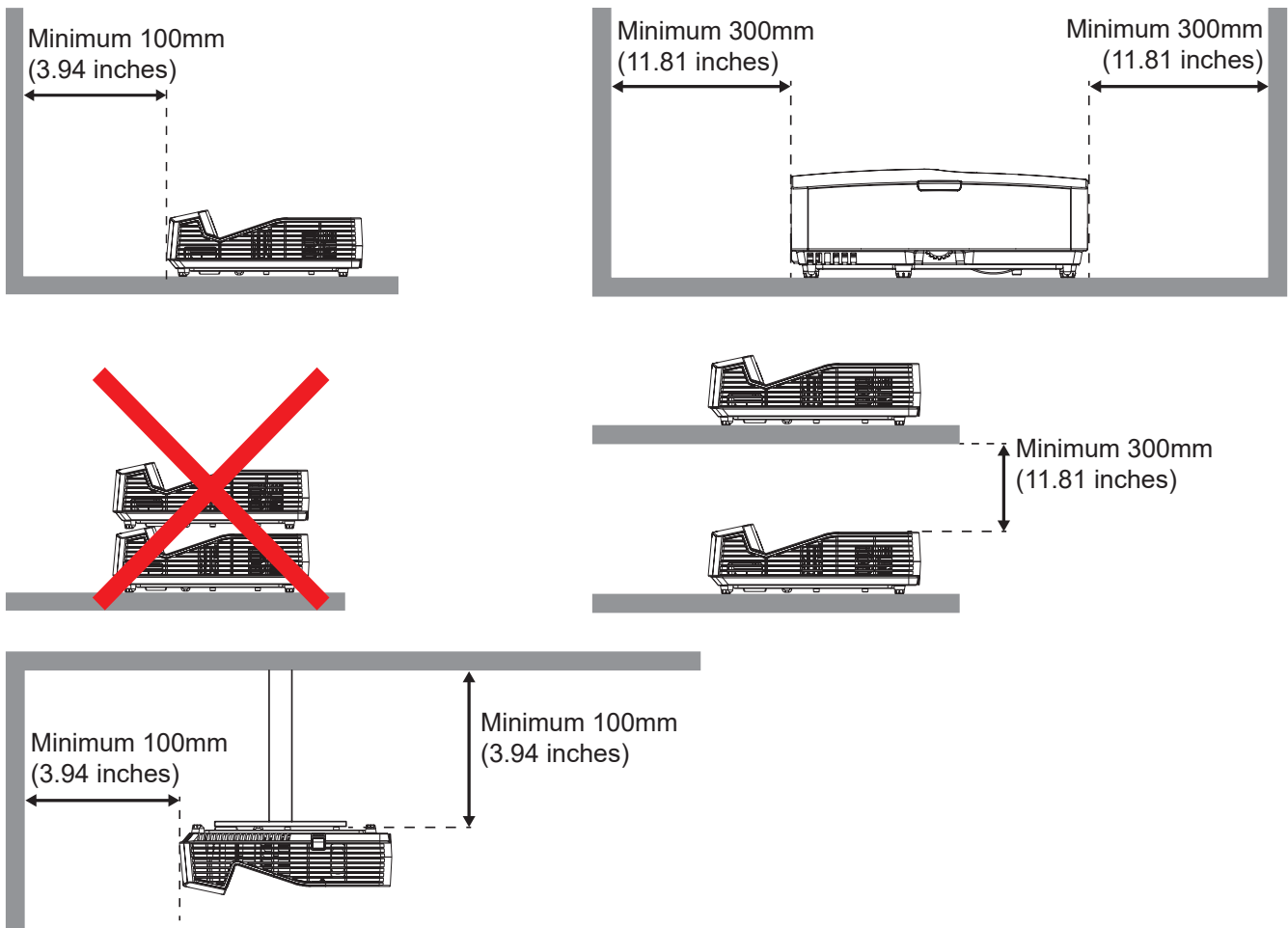

- Ensure that the intake vents do not recycle hot air from the exhaust vent.
- When operating the projector in an enclosed space, ensure that the surrounding air temperature within the enclosure does not exceed operation temperature while the projector is running, and the air intake and exhaust vents are unobstructed.
- All enclosures should pass a certified thermal evaluation to ensure that the projector does not recycle exhaust air, as this may cause the device to shutdown even if the enclosure temperature is within the acceptable operation temperature range.

SETUP AND INSTALLATION

Connecting sources to the projector

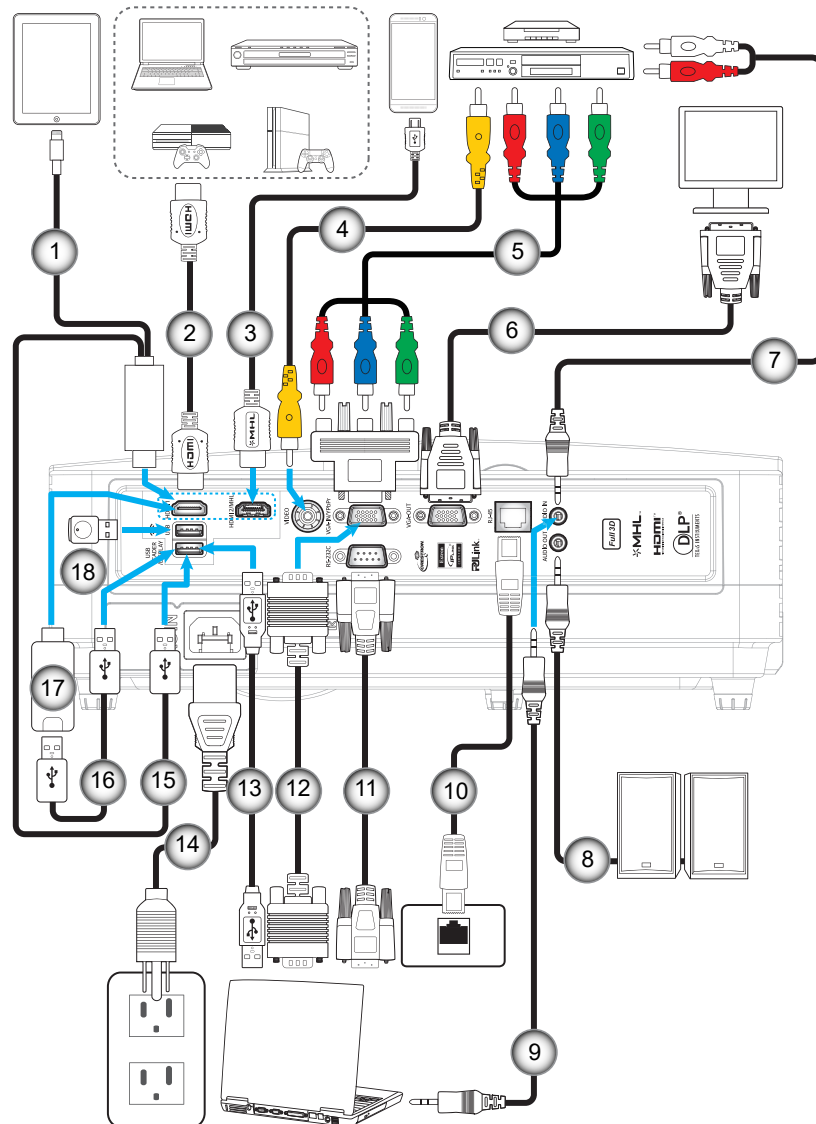

No	Item	No	Item
1.	Lightning to HDMI Cable/Adapter	10.	RJ-45 Cable
2.	HDMI Cable	11.	RS-232C Cable
3.	HDMI / MHL Cable	12.	VGA In Cable
4.	Video Cable	13.	USB Cable (mouse control)
5.	RCA Component Cable	14.	Power Cord
6.	VGA Out Cable	15.	USB to HDMI Cable/Adapter
7.	Audio In Cable	16.	USB Power Supply (5V/1A)
8.	Audio Out Cable	17.	HDMI Dongle
9.	Audio In Cable	18.	WiFi Dongle

SETUP AND INSTALLATION

Adjusting the projector image

Image height

The projector is equipped with elevator feet for adjusting the image height.

1. Locate the adjustable foot you wish to adjust on the underside of the projector.
2. Rotate the adjustable foot clockwise or counterclockwise to raise or lower the projector.

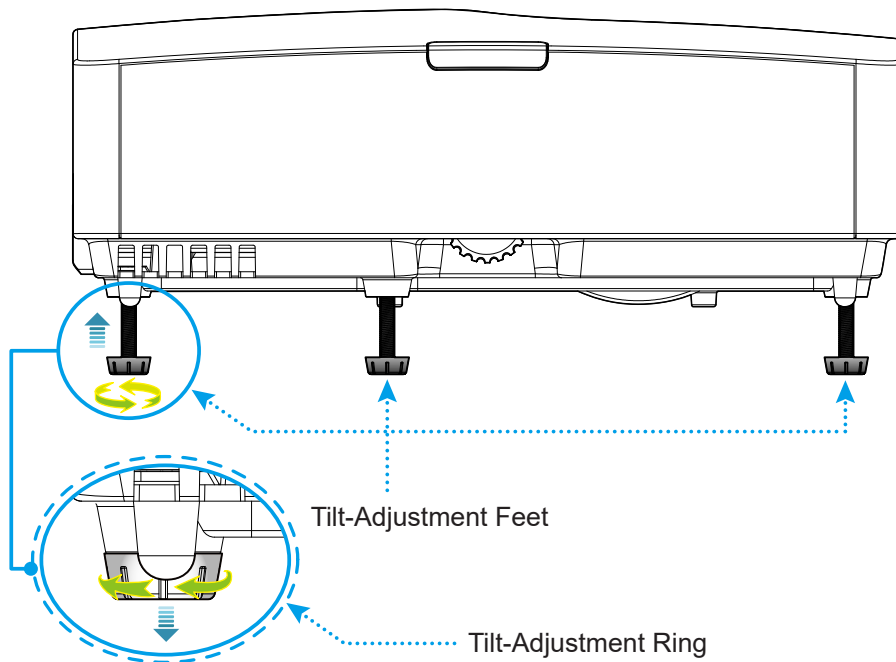

Zoom and focus

- The zoom is fixed and cannot be adjusted manually.
- To adjust the focus, turn the focus ring clockwise or counterclockwise until the image is sharp and legible.

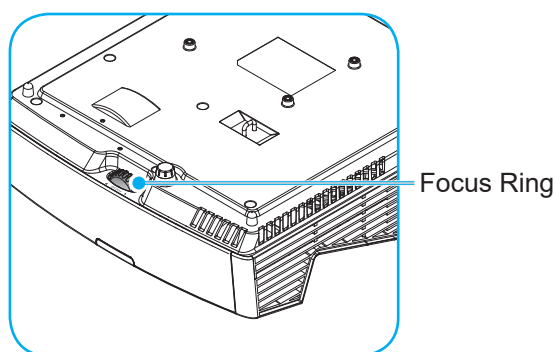

Note: The projector will focus at the following distances:

- XGA: 0.472m~0.675m
- WXGA: 0.485m~0.656m
- 1080P: 0.446m~0.558m

SETUP AND INSTALLATION

Remote setup

Installing / replacing the batteries

Two AAA size batteries are supplied for the remote control.

1. Remove the battery cover on the back of the remote control.
2. Insert AAA batteries in the battery compartment as illustrated.
3. Replace back cover on remote control.

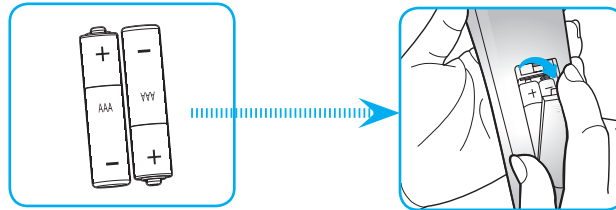

Note: Replace only with the same or equivalent type batteries.

CAUTION

Improper use of batteries can result in chemical leakage or explosion. Be sure to follow the instructions below.

- Do not mix batteries of different types. Different types of batteries have different characteristics.
- Do not mix old and new batteries. Mixing old and new batteries can shorten the life of new batteries or cause chemical leakage in old batteries.
- Remove batteries as soon as they are depleted. Chemicals that leak from batteries that come in contact with skin can cause a rash. If you find any chemical leakage, wipe thoroughly with a cloth.
- The batteries supplied with this product may have a shorter life expectancy due to storage conditions.
- If you will not be using the remote control for an extended period of time, remove the batteries.
- When you dispose of the batteries, you must obey the law in the relative area or country.

Effective range

Infra-Red (IR) remote control sensor is located on the top side and on the front side of the projector. Ensure to hold the remote control at an angle within $\pm 15^\circ$ to the projector's top IR remote control sensor and $\pm 45^\circ$ to the projector's front IR remote control sensor to function correctly. The distance between the remote control and the sensors should not be longer than 7 meters (23 feet).

- Make sure that there are no obstacles between the remote control and the IR sensor on the projector that might obstruct the infra-red beam.
- Make sure the IR transmitter of the remote control is not being shined by sunlight or fluorescent lamps directly.
- Please keep the remote controller away from fluorescent lamps for over 2 meters or the remote controller might become malfunction.
- If the remote control is closed to Inverter-Type fluorescent lamps, it might become ineffective from time to time.
- If the remote control and the projector are within a very short distance, the remote control might become ineffective.
- When you aim at the screen, the effective distance is less than 5 m from the remote control to the screen and reflecting the IR beams back to the projector. However, the effective range might change according to screens.

SETUP AND INSTALLATION

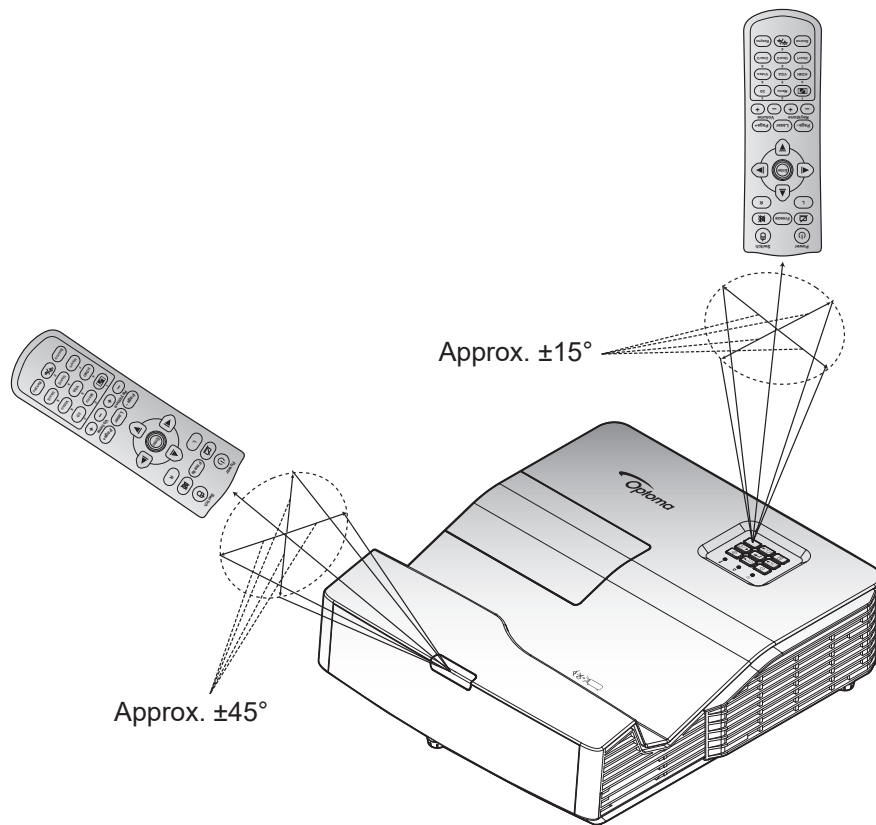

USING THE PROJECTOR

Powering on / off the projector

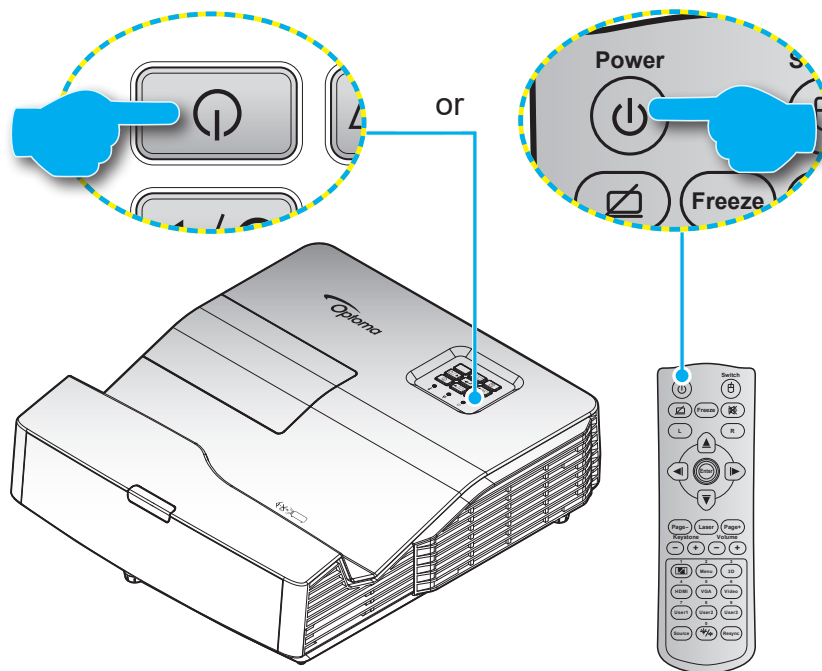

Powering on

1. Securely connect the power lead and signal/source cable. When connected, the On/Standby LED will turn red.
2. Turn on the projector by pressing the "⏻" either on the projector keypad or the remote control.
3. A start up screen will display in approximately 10 seconds and the On/Standby LED will be flashing blue.

Note: The first time the projector is turned on, you will be prompted to select the preferred language, projection orientation, and other settings.

Powering off

1. Turn off the projector by pressing the "⏻" either on the projector keypad or the remote control.
2. The following message will be displayed:

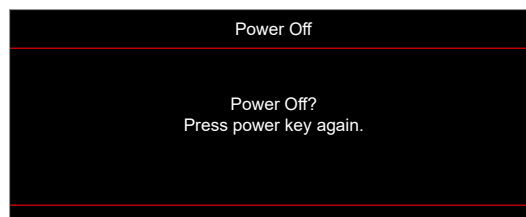

3. Press the "⏻" again to confirm, otherwise the message will disappear after 10 seconds. When you press the "⏻" button for the second time, the projector will shut down.
4. The cooling fans will continue to operate for about 10 seconds for the cooling cycle and the On/Standby LED will flash blue. When the On/Standby LED turns solid red, this indicates the projector has entered standby mode. If you wish to turn the projector back on, you must wait until the cooling cycle has finished and the projector has entered standby mode. When the projector is in standby mode, simply press the "⏻" button again to turn on the projector.
5. Disconnect the power lead from the electrical outlet and the projector.

Note: It is not recommended that the projector is turned on immediately, right after a power off procedure.

USING THE PROJECTOR

Selecting an input source



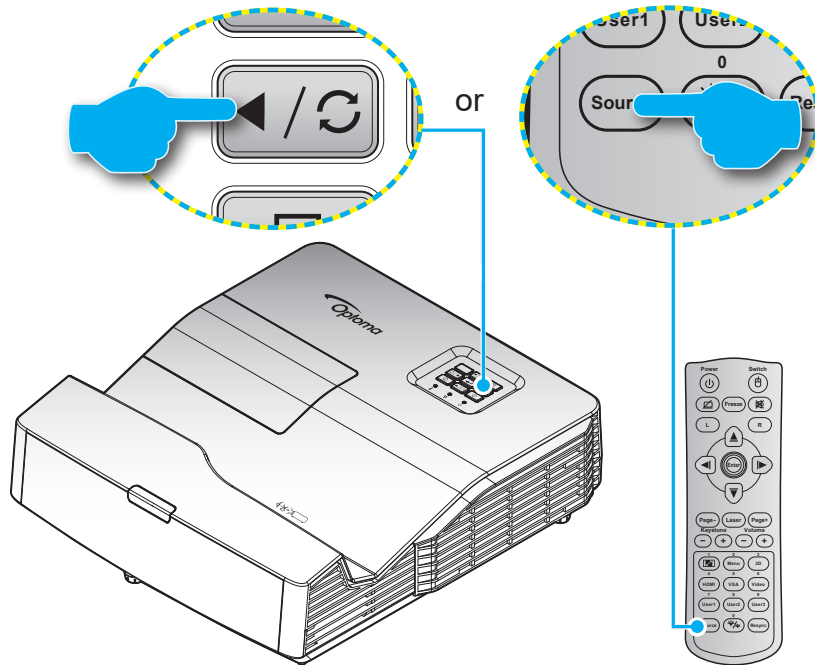











Turn on the connected source that you want to display on the screen, such as computer, notebook, video player, etc. The projector will automatically detect the source. If multiple sources are connected, push the source button on the projector keypad or the remote control to select the desired input.



USING THE PROJECTOR

Menu navigation and features

The projector has multilingual on-screen display menus that allow you to make image adjustments and change a variety of settings. The projector will automatically detect the source.

1. To open the OSD menu, press  on the remote control or the projector keyboard.
2. When OSD is displayed, use   keys to select any item in the main menu. While making a selection on a particular page, press  or  key to enter sub menu.
3. Use   keys to select the desired item in the sub menu and then press  or  key to view further settings. Adjust the settings by using   keys.
4. Select the next item to be adjusted in the sub menu and adjust as described above.
5. Press the  or  to confirm, and the screen will return to the main menu.
6. To exit, press the  or  again. The OSD menu will close and the projector will automatically save the new settings.

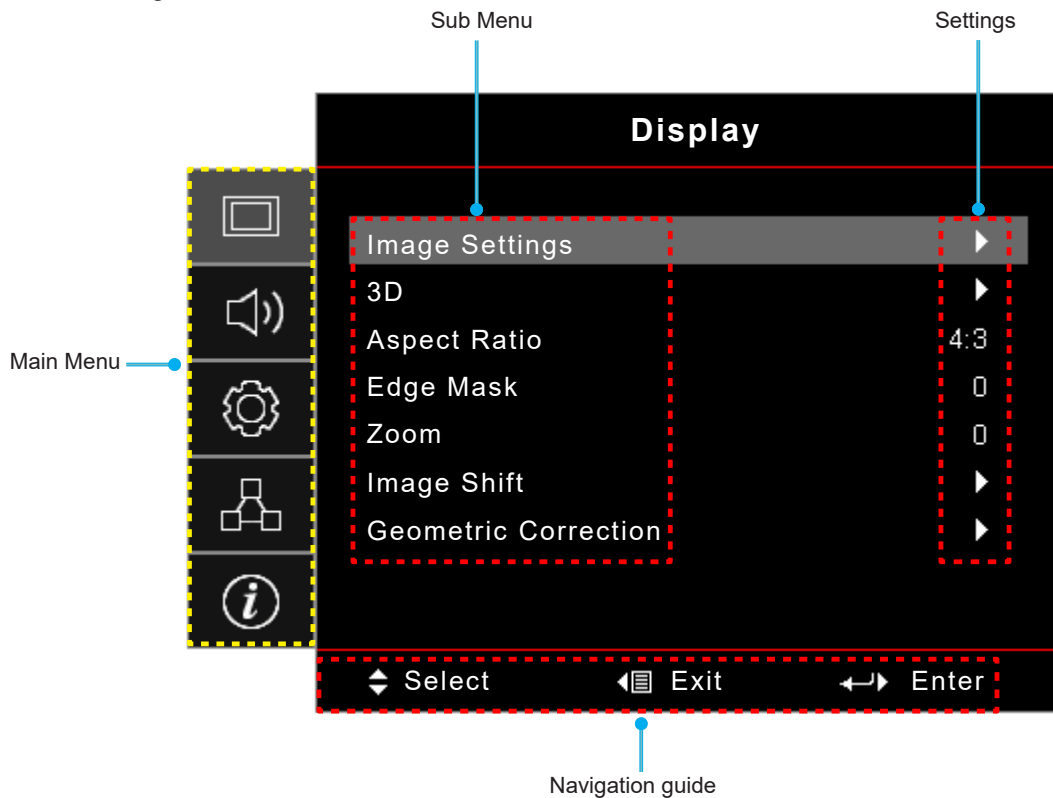

USING THE PROJECTOR









OSD Menu tree

Main Menu	Sub Menu	Sub Menu 2	Sub Menu 3	Sub Menu 4	Values		
Display	Image Settings	Display Mode [Data]			Presentation		
					Bright		
					Cinema		
					Game		
					sRGB		
					DICOM SIM.		
					User		
				3D			
			Wall Color [Data]			Off [Default]	
						BlackBoard	
						Light Yellow	
						Light Green	
						Light Blue	
						Pink	
					Gray		
			Brightness			-50~50	
			Contrast			-50~50	
			Sharpness			1~15	
			Color			-50~50	
			Tint			-50~50	
			Gamma	Film			
				Video			
				Graphics			
				Standard(2.2)			
				1.8			
				2.0			
				2.4			
			Color Settings	BrilliantColor™			1~10
				Color Temperature [Data model]			Warm
							Medium
			Color Settings	Color Matching	Color		Cool
							R [Default]
							G
							B
							C
							Y
		M					
		W					
		Saturation				-50~50 [Default:0]	
		Hue				-50~50 [Default:0]	
		Gain		-50~50 [Default:0]			

USING THE PROJECTOR

Main Menu	Sub Menu	Sub Menu 2	Sub Menu 3	Sub Menu 4	Values	
Display	Image Settings	Color Settings	Color Matching	Reset	Cancel [Default] Yes	
				Exit		
				RGB Gain/Bias	Red Gain	-50~50
			Green Gain		-50~50	
			Blue Gain		-50~50	
			Red Bias		-50~50	
			Green Bias		-50~50	
			Blue Bias		-50~50	
			Reset		Cancel [Default] Yes	
			Exit			
			Color Space [Not HDMI Input]		Auto [Default] RGB YUV	
				Color Space [HDMI Input]	Auto [Default] RGB(0~255) RGB(16~235) YUV	
					White Level	0~31 (depends on signal)
			Black Level		-5~5 (depends on signal)	
			IRE		0 7.5	
				Signal	Automatic	Off On [Default]
						Frequency
			Phase		0~63 [Default: 0]	
			H. Position		-5~5 [Default: 0]	
			V. Position		-5~5 [Default: 0]	
			Exit			
		Brightness Mode [Lamp Base - Data]		Bright [Default] Eco Dynamic Eco+		
			Reset			

USING THE PROJECTOR

Main Menu	Sub Menu	Sub Menu 2	Sub Menu 3	Sub Menu 4	Values	
Display	3D	3D Mode			Off	
					DLP-LINK [Default]	
					IR	
		3D->2D				3D [Default]
						L
						R
		3D Format				Auto [Default]
						SBS
						Top and Bottom
						Frame Sequential
		3D sync invert				On
						Off [Default]
	Aspect Ratio					4:3
						16:9
						16:10 [WXGA WUXGA models]
						LBX [except SVGA XGA models]
						Native
						Auto
	Edge Mask					0~10 [Default: 0]
	Zoom					-5~25 [Default: 0]
	Image shift	H: 0; V: -100				[Default:0]
		H: -100; V: 0				
		H: 100; V: 0				
		H: 0; V: 100				
		H: -100; V: 0				
		H: 0; V: -100				
		H: 100; V: 0				
H: 0; V: 100						
Geometric Correction	Four Corner Adjustment					
	H Keystone				-4~4 [Default:0]	
	V Keystone				-7~7 (for XGA/WXGA) [Default:0] -5~5 (for 1080p) [Default:0]	
	Auto Keystone				Off [Default]	
					On	
	Reset					
Audio	Mute				Off [Default]	
					On	
	Volume					0-10 [Default: 5]
Audio Out (Standby)					Off [Default]	
					On	

USING THE PROJECTOR

Main Menu	Sub Menu	Sub Menu 2	Sub Menu 3	Sub Menu 4	Values		
Setup	Projection				Front 		
					Rear 		
					Ceiling-top  [Default]		
					Rear-top 		
	Screen Type	[WXGA WUXGA models]				16:9	
						16:10 [Default]	
	Lamp Settings	Lamp Reminder				Off	
						On [Default]	
		Lamp Reset				Cancel [Default]	
	Filter Settings	Optional Filter Installed				Yes	
						No [Default]	
		Filter Usage Hours				(Read only)	
		Filter Reminder				Off	
						300hr	
						500hr [Default]	
						800hr	
	Filter Reset				1000hr		
					Cancel [Default]		
	Power Settings	Direct Power On				Yes	
						Off [Default]	
		Signal Power On				On	
						Off [Default]	
		Auto Power Off (min)				0~180 (5 min increments) [Default: 20]	
		Sleep Timer	Sleep Timer (min)				0~990 (30 min increments) [Default: 0]
			Always On				Yes
		Quick Resume					No [Default]
							Off [Default]
		Power Mode (Standby)					On
						Active	
	USB Power (Standby)					Eco [Default]	
						Off [Default]	
	Security	Security				On	
		Security Timer	Month				
			Day				
	Change Password	Hour					

USING THE PROJECTOR

Main Menu	Sub Menu	Sub Menu 2	Sub Menu 3	Sub Menu 4	Values		
Setup	HDMI Link Settings	HDMI Link			Off		
					On		
	Test Pattern					Green Grid	
						Magenta Grid	
						White Grid	
						White	
						Off	
	Remote Settings [Depends on remote]	IR Function				On	
						Off	
		User1					HDMI 2
							Test Pattern
							LAN
							Brightness
							Contrast
							Sleep Timer
							Color Matching
							Color Temp
							Gamma
							Projection
							Lamp Settings
							Zoom
							Freeze
							MHL
		User2					HDMI 2
							Test Pattern
							LAN
							Brightness
							Contrast
							Sleep Timer
							Color Matching
						Color Temp	
						Gamma	
						Projection	
					Lamp Settings		
					Zoom		
				Freeze			
				MHL			

USING THE PROJECTOR

Main Menu	Sub Menu	Sub Menu 2	Sub Menu 3	Sub Menu 4	Values	
Setup	Remote Settings [Depends on remote]	User3			HDMI 2	
					Test Pattern	
					LAN	
					Brightness	
					Contrast	
					Sleep Timer	
					Color Matching	
					Color Temp	
					Gamma	
					Projection	
					Lamp Settings	
					Zoom	
					Freeze	
					MHL	
		Projector ID				00~99
		Options	Language			English [Default]
						Deutsch
						Français
						Italiano
						Español
						Português
						Polski
						Nederlands
						Svenska
						Norsk
						Dansk
						Suomi
						ελληνικά
						繁體中文
						簡體中文
						日本語
						한국어
						Русский
						Magyar
						Čeština
						عربي
					ไทย	
			Türkçe			
			فارسی			
			Tiếng Việt			
			Bahasa Indonesia			
			Română			
			Slovenčina			
	Closed Captioning				CC1	
					CC2	
					Off [Default]	

USING THE PROJECTOR

Main Menu	Sub Menu	Sub Menu 2	Sub Menu 3	Sub Menu 4	Values
Setup	Options	Menu Settings	Menu Location		Top left 
					Top right 
					Center  [Default]
					Bottom left 
					Bottom right 
			Menu Timer		Off
					5sec
					10sec [Default]
			Auto Source		Off [Default]
					On
		Input Source		HDMI1	
				HDMI2/MHL	
				VGA	
				Video	
				Network Display	
				USB Display	
				USB Reader	
		Input Name	HDMI1		Default [Default]
					Custom
			HDMI2/MHL		Default [Default]
					Custom
			VGA		Default [Default]
					Custom
			Video		Default [Default]
					Custom
			Network Display		Default [Default]
					Custom
			USB Display		Default [Default]
					Custom
			USB Reader		Default [Default]
					Custom
		High Altitude		Off [Default]	
				On	
		Display Mode Lock		Off [Default]	
				On	
		Keypad Lock		Off [Default]	
				On	
		Information Hide		Off [Default]	
				On	
		Background Color		None [Default]	
				Blue	
				Red	

USING THE PROJECTOR

Main Menu	Sub Menu	Sub Menu 2	Sub Menu 3	Sub Menu 4	Values
Setup	Options	Background Color			Green
					Grey
					Logo
	Reset	Reset OSD			Cancel [Default]
					Yes
		Reset to Default			Cancel [Default]
				Yes	
Network	LAN	Network Status			(read only)
		MAC Address			(read only)
		DHCP			Off [Default]
					On
		IP Address			192.168.0.100 [Default]
		Subnet Mask			255.255.255.0 [Default]
		Gateway			192.168.0.254 [Default]
		DNS			192.168.0.51 [Default]
	Reset				
	Control	Crestron			Off
					On [Default] Note: Port 41794
		Extron			Off
					On [Default] Note: Port 2023
		PJ Link			Off
					On [Default] Note: Port 4352
		AMX Device Discovery			Off
					On [Default] Note: Port 9131
		Telnet			Off
					On [Default] Note: Port 23
		HTTP			Off
				On [Default] Note: Port 80	

USING THE PROJECTOR

Main Menu	Sub Menu	Sub Menu 2	Sub Menu 3	Sub Menu 4	Values	
Information	Regulatory					
	Serial Number					
	Source					
	Resolution				00x00	
	Refresh Rate				0.00Hz	
	Display Mode					
	Power mode(standby)					
	Lamp Hours	Bright mode				0hr
		Eco mode				0hr
		Dynamic mode				0hr
		Eco+ mode				0hr
		Total hours				
	Network Status					
	IP Address					
	Projector ID				00~99	
	Filter Usage Hours					
	Brightness Mode					
FW Version	System					
	LAN					
	MCU					
	AM					

Note:

- *If the Signal setting is set to "Automatic", the Phase and Frequency items are grayed out. If the Signal setting is set to a specific input source, the Phase and Frequency items will appear for user to manually tune and saved in settings.*
- *The Lamp Reset in OSD will reset both Lamp Hours in OSD and Lamp Hours in service mode. The Projection Hours in service mode will not be reset.*
- *If you make changes to "IR Function", "Projection", or "Keypad Lock" functions, a confirmation message will appear on the screen. Select "Yes" to save the settings.*
- *Each display mode can be adjusted and saved the value.*
- *In 3D timing mode, the Zoom and Edge Mask functions will be disabled to prevent from image break.*

USING THE PROJECTOR

Display menu

Display image settings menu

Display Mode

There are many factory presets optimized for various types of images.

- **Presentation:** This mode is suitable for showing PowerPoint presentations when the projector is connected to the PC.
- **Bright:** Maximum brightness from PC input.
- **Cinema:** Select this mode for home theater.
- **Game:** Select this mode to increase the brightness and response time level for enjoying video games.
- **sRGB:** Standardized accurate color.
- **DICOM SIM.:** This mode can project a monochrome medical image such as an X ray radiography, MRI, etc.
- **User:** Memorize user's settings.
- **3D:** To experience the 3D effect, you need to have 3D glasses. Make sure your PC/portable device has a 120 Hz signal output quad buffered graphics card and a 3D Player installed.

Wall Color (Data mode)

Use this function to obtain an optimized screen image according to the wall color. Select between off, blackboard, light yellow, light green, light blue, pink, and gray.

Brightness

Adjust the brightness of the image.

Contrast

The contrast controls the degree of difference between the lightest and darkest parts of the picture.

Sharpness

Adjust the sharpness of the image.

Color

Adjust a video image from black and white to fully saturated color.

Tint

Adjust the color balance of red and green.

Gamma

Set up gamma curve type. After the initial setup and fine tuning is completed, utilize the Gamma Adjustment steps to optimize your image output.

- **Film:** For home theater.
- **Video:** For video or TV source.
- **Graphics:** For PC / Photo source.
- **Standard(2.2):** For standardized setting.
- **1.8/ 2.0/ 2.4:** For specific PC / Photo source.

USING THE PROJECTOR

Color Settings

Configure the color settings.

- **BrilliantColor™:** This adjustable item utilizes a new color-processing algorithm and enhancements to enable higher brightness while providing true, more vibrant colors in picture.
- **Color Temperature (data-mode only):** Select a color temperature from Warm, Medium, or Cool.
- **Color Matching:** Select the following options:
 - Color: Adjust the red (R), green (G), black (B), cyan (C), yellow (Y), magenta (M), and white (W) level of the image.
 - Saturation: Adjust a video image from black and white to fully saturated color.
 - Hue: Adjust the color balance of red and green.
 - Gain: Adjust the image brightness.
 - Reset: Return the factory default settings for color matching.
 - Exit: Exit the “Color Matching” menu.
- **RGB Gain/Bias:** This settings allows to configure the brightness (gain) and contrast (bias) of an image.
 - Reset: Return the factory default settings for RGB gain/bias.
 - Exit: Exit the “RGB Gain/Bias” menu.
- **Color Space (non-HDMI input only):** Select an appropriate color matrix type from the following: AUTO, RGB, or YUV.
- **Color Space (HDMI input only):** select an appropriate color matrix type from the following: Auto, RGB(0-255), RGB(16-235), and YUV.
- **White Level:** Allow user to adjust White Level when inputting Video signals.
- **Black Level:** Allow user to adjust Black Level when inputting Video signals.
- **IRE:** Allow user to adjust IRE value when inputting Video signals.
Note: IRE is only available with NTSC video format.

Signal

Adjust the signal options.

- **Automatic:** Configure automatically the signal (the frequency and phase items are grayed out). If automatic is disabled, the frequency and phase items will appear for tuning and saving the settings.
- **Frequency:** Change the display data frequency to match the frequency of your computer’s graphic card. Use this function only if the image appears to flicker vertically.
- **Phase:** Synchronize the signal timing of the display with the graphic card. If the image appears to be unstable or flickers, use this function to correct it.
- **H. Position:** Adjust the horizontal positioning of the image.
- **V. Position:** Adjust the vertical positioning of the image.

Brightness Mode (Lamp base data)

Adjust the brightness mode settings for lamp-based projectors.

- **Bright:** Choose “Bright” to increase the brightness.
- **Eco:** Choose “Eco” to dim the projector lamp which will lower power consumption and extend the lamp life.
- **Dynamic:** Choose “Dynamic” to dim the lamp power which will be based on brightness level of the content and adjust lamp power consumption between 100% and 30% dynamically. The lamp life will be extended.

USING THE PROJECTOR

- **Eco+:** When Eco+ mode is activated, the brightness level of the content is automatically detected to significantly reduced lamp power consumption (up to 70%) during periods of inactivity.

Reset

Return the factory default settings for color settings.

Display 3D menu

3D Mode

Use this option to disable the 3D function or select the appropriate the 3D function.

- **Off:** Select “Off” to turn off 3D mode.
- **DLP-LINK:** Select to use optimized settings for DLP 3D Glasses.
- **IR:** Select “IR” to use optimized setting for IR 3D Glasses.

Note: *If the projector received the 2D and 3D source in the same time. You have to turn off the 3D function when you see the double image.*

3D → 2D

Use this option to specify how the 3D content should appear on the screen.

- **3D:** Display 3D signal.
- **L (Left):** Display the left frame of 3D content.
- **R (Right):** Display the right frame of 3D content.

3D Format

Use this option to select the appropriate 3D format content.

- **Auto:** When a 3D identification signal is detected, the 3D format is selected automatically.
- **SBS:** Display 3D signal in “Side-by-Side” format.
- **Top and Bottom:** Display 3D signal in “Top and Bottom” format.
- **Frame Sequential:** Display 3D signal in “Frame Sequential” format.

3D Sync Invert

Use this option to enable/disable the 3D sync invert function.

Display aspect ratio menu

Aspect Ratio

Select the aspect ratio of the displayed image between the following options:

- **4:3:** This format is for 4:3 input sources.
- **16:9:** This format is for 16:9 input sources, like HDTV and DVD enhanced for Wide screen TV.
- **16:10 (for WXGA and WUXGA models only):** This format is for 16:10 input sources, like widescreen laptops.
- **LBX (except SVGA and XGA models):** This format is for non-16x9, letterbox source and if you use external 16x9 lens to display 2.35:1 aspect ratio in full resolution.
- **Native:** This format displays the original image without any scaling.

USING THE PROJECTOR

- **Auto:** Automatically selects the appropriate display format.

Note:

- *Detailed informations about LBX mode:*
 - *Some Letter-Box Format DVDs are not enhanced for 16x9 TVs. In this situation, the image will not look right when displaying image in 16:9 mode. In this situation, please try to use the 4:3 mode to view the DVD. If the content is not 4:3, there will be black bars around the image in 16:9 display. For this type of content, you can use LBX mode to fill the image on the 16:9 display.*
 - *If you use an external anamorphic lens, this LBX mode also allows you to watch a 2.35:1 content (include Anamorphic DVD and HDTV film source) that supports anamorphic wide is enhanced for 16x9 Display in a wide 2.35:1 image. In this case, there are no black bars. Lamp power and vertical resolution are fully utilized.*

XGA scaling table:

Source	480i/p	576i/p	1080i/p	720p
4x3	Scale to 1024x768.			
16x9	Scale to 1024x576.			
Native	No scaling will be made; the image is displayed with the resolution based on input source.			
Auto	-If source is 4:3, the screen type will be scaled to 1024x768. -If source is 16:9, the screen type will be scaled to 1024x576. -If source is 15:9, the screen type will be scaled to 1024x614. -If source is 16:10, the screen type will be scaled to 1024x640.			

XGA auto mapping rule:

Auto	Input resolution		Auto/Scale	
	H-resolution	V-resolution	1024	768
4:3	640	480	1024	768
	800	600	1024	768
	1024	768	1024	768
	1600	1200	1024	768
Wide Laptop	1280	720	1024	576
	1280	768	1024	614
	1280	800	1024	640
SDTV	720	576	1024	576
	720	480	1024	576

USING THE PROJECTOR

HDTV	1280	720	1024	576
	1920	1080	1024	576

WXGA scaling table (screen type 16x10):

Note:

- Supported screen type 16:9 (1280x720), 16:10 (1280x800).
- When screen type is 16:9, the 16x10 format becomes unavailable.
- When screen type is 16:10, the 16x9 format becomes unavailable.
- If you select auto option then the display mode will be also automatically changed.

16 : 10 screen	480i/p	576i/p	1080i/p	720p	PC
4x3	Scale to 1066x800.				
16x10	Scale to 1280x800.				
LBX	Scale to 1280x960, then get the central 1280x800 image to display.				
Native mode	1:1 mapping centered.		1:1 mapping display 1280x800.	1280x720 centered.	1:1 mapping centered.
Auto	-Input source will be fit into 1280x800 display area and be kept its original aspect ratio. -If source is 4:3, the screen type will be scaled to 1066x800. -If source is 16:9, the screen type will be scaled to 1280x720. -If source is 15:9, the screen type will be scaled to 1280x768. -If source is 16:10, the screen type will be scaled to 1280x800.				

WXGA auto mapping rule (screen type 16x10):

Auto	Input resolution		Auto/Scale	
	H-resolution	V-resolution	1280	800
4:3	640	480	1066	800
	800	600	1066	800
	1024	768	1066	800
	1280	1024	1066	800
	1400	1050	1066	800
	1600	1200	1066	800
Wide Laptop	1280	720	1280	720
	1280	768	1280	768
	1280	800	1280	800
SDTV	720	576	1280	720
	720	480	1280	720

USING THE PROJECTOR

HDTV	1280	720	1280	720
	1920	1080	1280	720

WXGA scaling table (screen type 16x9):

16 : 9 screen	480i/p	576i/p	1080i/p	720p	PC
4x3	Scale to 960x720.				
16x9	Scale to 1280x720.				
LBX	Scale to 1280x960, then get the central 1280x720 image to display.				
Native mode	1:1 mapping centered.		1:1 mapping display 1280x720.	1280x720 centered.	1:1 mapping centred.
Auto	-If this format is select, screen type will automatically become 16:9 (1280x720). -If source is 4:3, the screen type will be scaled to 960x720. -If source is 16:9, the screen type will be scaled to 1280x720. -If source is 15:9, the screen type will be scaled to 1200x720. -If source is 16:10, the screen type will be scaled to 1152x720.				

WXGA auto mapping rule (screen type 16x9):

Auto	Input resolution		Auto/Scale	
	H-resolution	V-resolution	1280	720
4:3	640	480	960	720
	800	600	960	720
	1024	768	960	720
	1280	1024	960	720
	1400	1050	960	720
	1600	1200	960	720
Wide Laptop	1280	720	1280	720
	1280	768	1200	720
	1280	800	1152	720
SDTV	720	576	1280	720
	720	480	1280	720

USING THE PROJECTOR

HDTV	1280	720	1280	720
	1920	1080	1280	720

1080P scaling table:

16 : 9 screen	480i/p	576i/p	1080i/p	720p	PC
4x3	Scale to 1440x1080.				
16x9	Scale to 1920x1080.				
LBX	Scale to 1920x1440, then get the central 1920x1080 image to display.				
Native mode	1:1 mapping centered. No scaling will be made; the image is displayed with the resolution based on input source.				
Auto	-If this format is select, screen type will automatically become 16:9 (1920x1080). -If source is 4:3, the screen type will be scaled to 1440x1080. -If source is 16:9, the screen type will be scaled to 1920x1080. -If source is 16:10, the screen type will be scaled to 1920x1200 and cut 1920x1080 area to display.				

1080P auto mapping rule:

Auto	Input resolution		Auto/Scale	
	H-resolution	V-resolution	1920	1080
4:3	640	480	1440	1080
	800	600	1440	1080
	1024	768	1440	1080
	1280	1024	1440	1080
	1400	1050	1440	1080
	1600	1200	1440	1080
Wide Laptop	1280	720	1920	1080
	1280	768	1800	1080
	1280	800	1728	1080
SDTV	720	576	1350	1080
	720	480	1620	1080
HDTV	1280	720	1920	1080
	1920	1080	1920	1080

Display edge mask menu

Edge Mask

Use this function to remove the video encoding noise on the edge of video source.

Display zoom menu

Zoom

Use to reduce or magnify an image on the projection screen.

Display image shift menu

USING THE PROJECTOR

Image Shift

Adjust the projected image position horizontally (H) or vertically (V).

Display geometric correction menu

Four Corner Adjustment

Allow the image to be squeezed to fit an area defined by moving each of the four corners' x and y position.

H Keystone

Adjust image distortion horizontally and make a squarer image. Horizontal keystone is used to correct a keystone image shape in which the left and right borders of the image are unequal in length. This is intended for use with horizontally on-axis applications.

V Keystone

Adjust image distortion vertically and make a squarer image. Vertical keystone is used to correct a keystone image shape in which the top and bottom are slanted to one of the sides. This is intended when for use with vertically on-axis applications.

Auto Keystone

Correct keystone digitally to fit the projected image on the area on which you are projecting.

Note:

- *The image size will reduce slightly when adjusting the horizontal and vertical keystone.*
- *When Auto Keystone is used Four Corner Adjustment is disabled*

Reset

Return the factory default settings for keystone settings.

Audio menu

Audio mute menu

Mute

Use this option to temporarily turn off the sound.

- **On:** Choose the "On" to turn mute on.
- **Off:** Choose the "Off" to turn mute off.

Note: "Mute" function affects both internal and external speaker volume.

Audio volume menu

Volume

Adjust the volume level.

Audio out (standby) menu

Audio Out Standby

Enable or disable audio output when the projector is in standby mode.

USING THE PROJECTOR

Setup menu

Setup projection menu

Projection

Select the preferred projection between front, rear, ceiling-top, and rear-top.

Setup screen type menu

Screen Type (for WXGA and WUXGA models only)

Choose the screen type from 16:9 and 16:10.

Setup lamp settings menu

Lamp Reminder

Choose this function to show or to hide the warning message when the changing lamp message is displayed. The message will appear 30 hours before suggested replacement of lamp.

Lamp Reset

Resets the lamp hour counter after replacing the lamp.

Setup filter settings menu

Optional Filter Installed

Set the warning message setting.

- **Yes:** Display warning message after 500 hours of use.

Note: “Filter Usage Hours / Filter Reminder / Filter Reset” will only appear when “Optional Filter Installed” is “Yes”.

- **No:** Turn off warning message.

Filter Usage Hours

Display the filter time.

Filter Reminder

Choose this function to show or hide the warning message when the changing filter message is displayed. The available options include 300hr, 500hr, 800hr, and 1000hr.

Filter Reset

Reset the dust filter counter after replacing or cleaning the dust filter.

Setup power settings menu

Direct Power On

Choose “On” to activate Direct Power mode. The projector will automatically power on when AC power is supplied, without pressing the “Power” key on the projector keypad or on the remote control.

Signal Power On

Choose “On” to activate Signal Power mode. The projector will automatically power on when a signal is detected, without pressing the “Power” key on the projector Keypad or on the remote control.

Note: If the “Signal Power On” option is turned “On”, the power consumption of the projector in standby mode will be over 3W.

USING THE PROJECTOR

Auto Power Off (min)

Sets the countdown timer interval. The countdown timer will start, when there is no signal being sent to the projector. The projector will automatically power off when the countdown has finished (in minutes).

Sleep Timer (min)

Configure the sleep timer.

- **Sleep Timer (min):** Sets the countdown timer interval. The countdown timer will start, with or without a signal being sent to the projector. The projector will automatically power off when the countdown has finished (in minutes).
Note: *The Sleep Timer is reset every time when the projector is powered off.*
- **Always On:** Check to set the sleep timer always on.

Quick Resume

Set the quick resume setting.

- **On:** If the projector is accidentally turned off, this feature allows the projector to be instantly powered on again, if selected within a period of 100 seconds.
- **Off:** The fan will start cooling the system after 10 seconds when user turns off the projector.

Power Mode (Standby)

Set the power mode for standby state.

- **Active:** Choose "Active" to return to normal standby.
- **Eco:** Choose "Eco." to save power dissipation further < 0.5W.

USB Power (Standby)

Enable or disable USB power function during standby.

Setup security menu

Security

Enable this function to prompt for a password before using the projector.

- **On:** Choose "On" to use security verification when the turning on the projector.
- **Off:** Choose "Off" to be able to switch on the projector without password verification.

Security Timer

Can be select the time (Month/Day/Hour) function to set the number of hours the projector can be used. Once this time has elapsed you will be requested to enter your password again.

Change Password

Use to set or modify the password that is prompted when turning the projector on.

USING THE PROJECTOR

Setup HDMI link settings menu

Note:

- When you connect HDMI CEC-compatible devices to the projector with HDMI cables, you can control them on the same power on or power off status using the HDMI Link control feature in the projector's OSD. This lets one device or multiple devices in a group power on or power off via HDMI Link Feature. In a typical configuration, your DVD player may be connected to the projector through an amplifier or home theater system.

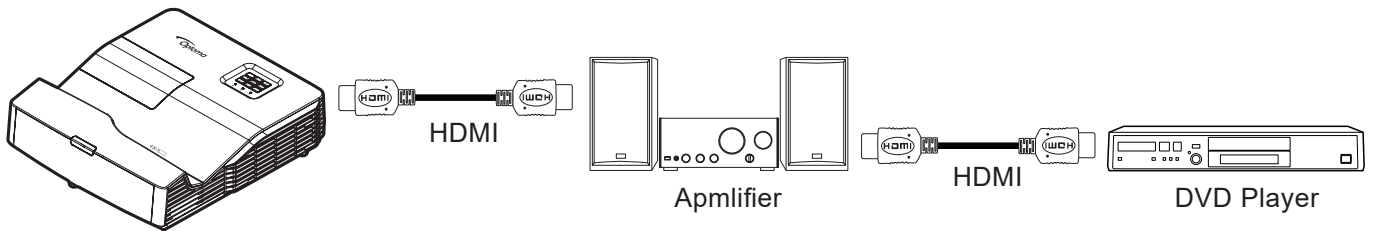

HDMI Link

Enable/Disable the HDMI Link function. Support that power on control from player to projector and power off control from projector to player.

Setup test pattern menu

Test Pattern

Select the test pattern from green grid, magenta grid, white grid, white or disable this function (off).

Setup remote settings menu

IR Function

Set the IR function setting.

- **On:** Choose "On", the projector can be operated by the remote control from front or top IR receiver.
- **Off:** Choose "Off", the projector can't be operated by the remote control from front or top IR receiver. By selecting "Off", you will be able to use the Keypad keys.

User1/ User2/ User3

Assign the default function for User1, User2, or User3 between HDMI 2, test pattern, LAN, brightness, contrast, sleep timer, color matching, color temp, gamma, projection, lamp settings, zoom, freeze, and MHL.

Setup projector ID menu

Projector ID

ID definition can be set up by menu (range 0-99), and allow user control an individual projector by using RS232 command.

Setup options menu

Language

Select the multilingual OSD menu between English, German, French, Italian, Spanish, Portuguese, Polish, Dutch, Swedish, Norwegian/Danish, Finnish, Greek, traditional Chinese, simplified Chinese, Japanese, Korean, Russian, Hungarian, Czechoslovak, Arabic, Thai, Turkish, Farsi, Vietnamese, Indonesian, Romanian, and Slovakian.

USING THE PROJECTOR

Closed Captioning

Closed Captioning is a text version of the program sound or other information displayed on the screen. If the input signal contains closed captions, you can turn on the feature and watch the channels. The available options include “Off”, “CC1”, and “CC2”.

Note: *Closed Captioning will only appear for Composite Signal and without PAL signal*

Menu Settings

Set the menu location on the screen and configure menu timer settings.

- **Menu Location:** Select the menu location on the display screen.
- **Menu Timer:** Set the duration where the OSD menu stays visible on the screen.

Auto Source

If set to “On”, the projector will automatically find the available input source.

Input Source

Select the input source between HDMI1, HDMI2/MHL, VGA, Video, Network Display, USB Display, and USB Reader.

Input Name

Use to rename the input function for easier identification. The available options include HDMI1, HDMI2/MHL, VGA, Video, Network Display, USB Display, and USB Reader.

High Altitude

When “On” is selected, the fans will spin faster. This feature is useful in high altitude areas where the air is thin.

Display Mode Lock

Choose “On” or “Off” to lock or unlock adjusting display mode settings.

Keypad Lock

When the keypad lock function is “On”, the Keypad will be locked. However, the projector can be operated by the remote control. By selecting “Off”, you will be able to reuse the Keypad.

Information Hide

Enable this function to hide the information message.

- **Off:** Choose “On” to hide the info message.
- **On:** Choose “Off” to show the “searching” message.

Background Color

Use this function to display a blue, red, green, grey color, none, or logo screen when no signal is available.

Setup reset all menu

Reset OSD

Return the factory default settings for OSD menu settings.

Reset to Default

Return the factory default settings for all settings.

USING THE PROJECTOR

Network menu

Network LAN menu

Network Status

Display the network connection status (read-only).

MAC Address

Display the MAC address (read-only).

DHCP

Use this option to enable or disable the DHCP function.

- **On:** Projector will obtain an IP address automatically from your network.
- **Off:** To assign IP, subnet mask, gateway, and DNS configuration manually.

Note: *Exiting OSD will automatically apply the entered values.*

IP Address

Display the IP address.

Subnet Mask

Display subnet mask number.

Gateway

Display the default gateway of the network connected to the projector.

DNS

Display the DNS number.

Reset

Reset the network parameters.

How to use web browser to control your projector

1. Turn "On" the DHCP option on projector to allow a DHCP server to automatically assign an IP address.
2. Open the web browser in your PC and type in the projector's IP address ("Network > LAN > IP Address").
3. Enter the user name and password, and click "Login".
The projector's configuration web interface opens.

Note:

- *The default user name and password is "admin".*
- *The steps in this section is based on Windows 7 operating system.*

USING THE PROJECTOR

Making a direct connection from your computer to the projector*

1. Turn “Off” the DHCP option on the projector.
2. Configure the IP address, Subnet Mask, Gateway, and DNS on projector (“Network > LAN”).
3. Open **Network and Sharing Center** page on your PC, and assign the identical network parameters to your PC as set on projector. Click “OK” to save the parameters.

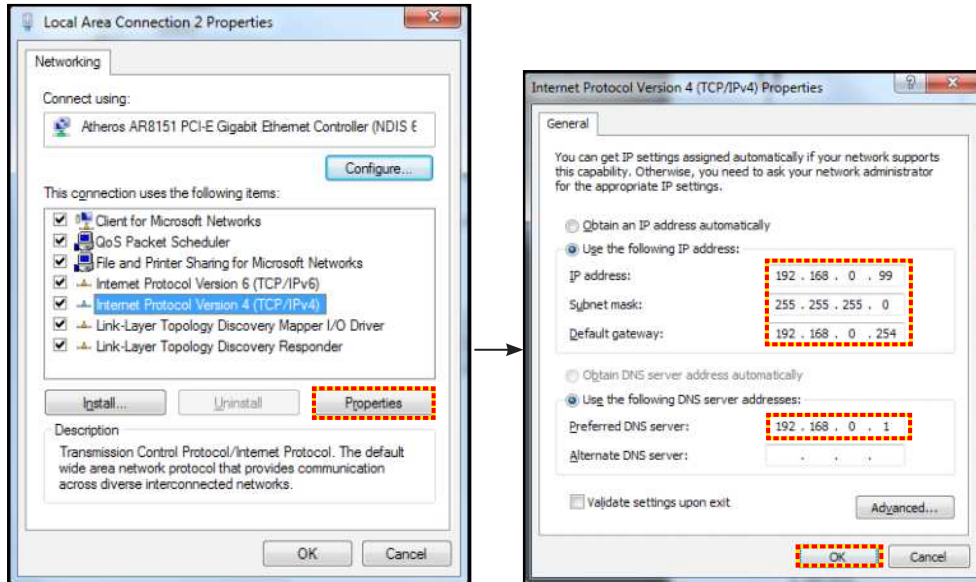

4. Open the web browser on your PC and type in to the URL field the IP address, assigned in step 3. Then press “Enter” key.

Reset

Reset all values for LAN parameters.

Network control menu

Crestron

Use this function to select the network function (port: 41794).

For more information, please visit <http://www.crestron.com> and www.crestron.com/getroomview.

Extron

Use this function to select the network function (port: 2023).

PJ Link

Use this function to select the network function (port: 4352).

AMX Device Discovery

Use this function to select the network function (port: 9131).

Telnet

Use this function to select the network function (port: 23).

HTTP

Use this function to select the network function (port: 80).

USING THE PROJECTOR

Setup network control settings menu

LAN_RJ45 function

For simplicity and ease of operation, the projector provides diverse networking and remote management features. The LAN / RJ45 function of the projector through a network, such as remotely manage: Power On / Off, brightness, and contrast settings. Also, you can view the projector status information, such as: Video- Source, Sound-Mute, etc.

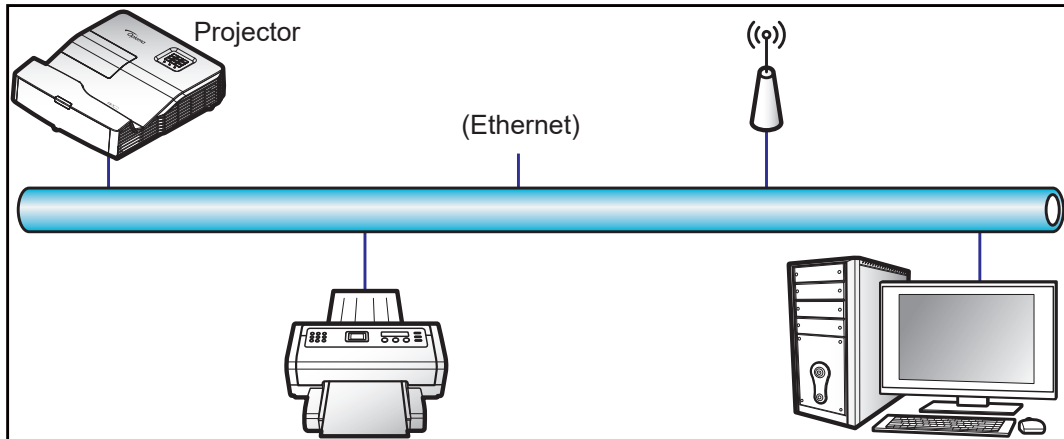

Wired LAN terminal functionalities

This projector can be controlled by using a PC (laptop) or other external device via LAN / RJ45 port and compatible with Crestron / Extron / AMX (Device -Discovery) / PJLink.

- Crestron is a registered trademark of Crestron Electronics, Inc. of the United States.
- Extron is a registered trademark of Extron Electronics, Inc. of the United States.
- AMX is a registered trademark of AMX LLC of the United States.
- PJLink applied for trademark and logo registration in Japan, the United States of America, and other countries by JBMIA.

The projector is supported by the specified commands of the Crestron Electronics controller and related software, for example RoomView®.

<http://www.crestron.com/>

This projector is compliant to support Extron device(s) for reference.

<http://www.extron.com/>

This projector is supported by AMX (Device Discovery).

<http://www.amx.com/>

This projector supports all commands of PJLink Class1 (Version 1.00).

<http://pjlink.jbmia.or.jp/english/>

For more detailed information about the various types of external devices which can be connected to the LAN / RJ45 port and remote control the projector, as well as the supported commands for these external devices, please contact the Support-Service directly.

USING THE PROJECTOR

LAN RJ45

1. Connect an RJ45 cable to RJ45 ports on the projector and the PC (laptop).

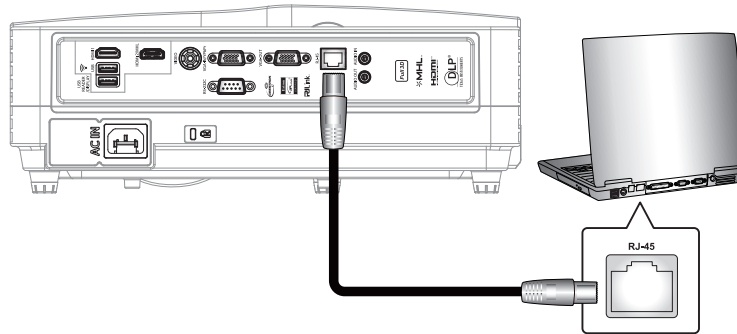

2. On the PC (Laptop), select **Start > Control Panel > Network Connections**.



3. Right-click on the **Local Area Connection**, and select **Property**.

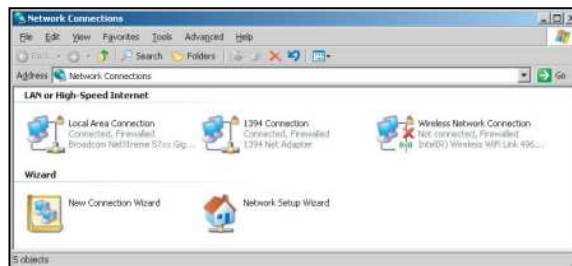

4. In the **Properties** window, select the **General** tab, and select **Internet Protocol (TCP / IP)**.

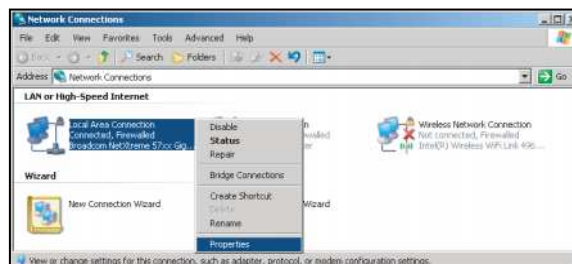

USING THE PROJECTOR

- Click “Properties”.

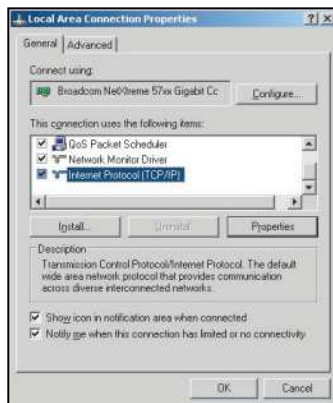

- Type in the IP address and Subnet mask, then press “OK”.



- Press the “Menu” button on the projector.
- Open on projector **Network > LAN**.
- Enter the following connection parameters:
 - DHCP: Off
 - IP Address: 192.168.0.100
 - Subnet Mask: 255.255.255.0
 - Gateway: 192.168.0.254
 - DNS: 192.168.0.1
- Press “Enter” to confirm settings.
- Open a web browser, for example Microsoft Internet Explorer with Adobe Flash Player 9.0 or higher installed.
- In the Address bar, input the projector’s IP address: 192.168.0.100.



- Press “Enter”.

USING THE PROJECTOR

The projector is setup for remote management. The LAN / RJ45 function displays as follows:

Information page

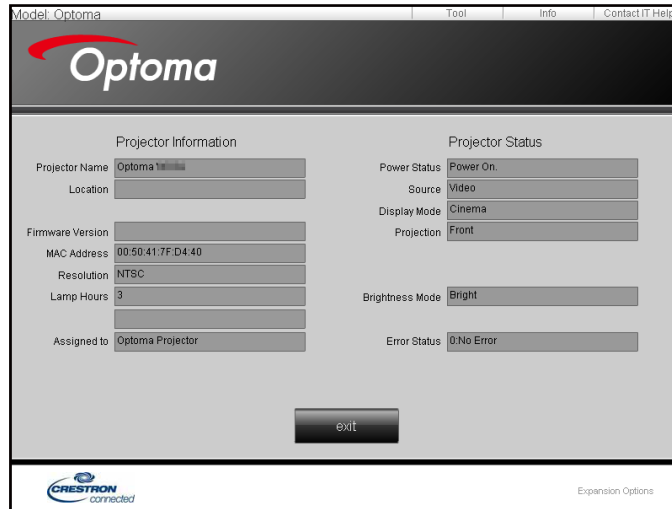

Main page



Tool page

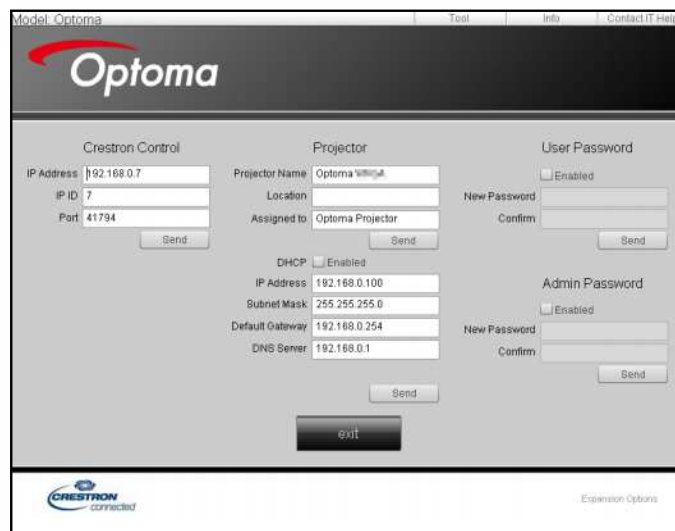

Contact IT helpdesk



USING THE PROJECTOR

RS232 by Telnet Function

There is alternative RS232 command control way, in projector so called “RS232 by TELNET” for LAN / RJ45 interface.

Quick Start-Guide for “RS232 by Telnet”

- Check and get the IP address on OSD of the projector.
- Make sure that the PC / laptop can access the web-page of the projector.
- Make sure that “Windows Firewall” setting is set disabled in case of “TELNET” function filtering out by PC / laptop.



1. Select **Start > All Programs.> Accessories > Command Prompt.**

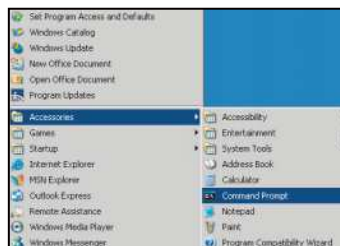

2. Input the command format as follows:
 - telnet ttt.xxx.yyy.zzz 23 (“Enter” key pressed)
 - (ttt.xxx.yyy.zzz: IP-Address of the projector)
3. If Telnet-Connection ready, and user can have RS232 command input, then “Enter” key pressed, the RS232 command will be workable.

Specification for “RS232 by TELNET”:

1. Telnet: TCP.
2. Telnet port: 23 (for more detail, kindly please get contact with the service agent or team).
3. Telnet utility: Windows “TELNET.exe” (console mode).
4. Disconnection for RS232-by-Telnet control normally: Close
5. Windows Telnet utility directly after TELNET connection ready.
 - Limitation 1 for Telnet-Control: there is less than 50 bytes for successive network payload for Telnet-Control application.
 - Limitation 2 for Telnet-Control: there is less than 26 bytes for one complete RS232 command for Telnet-Control.
 - Limitation 3 for Telnet-Control: Minimum delay for next RS232 command must be more than 200 (ms).

USING THE PROJECTOR

Info menu

Info menu

View the projector information as listed below:



- Regulatory
- Serial Number
- Source
- Resolution
- Refresh Rate
- Display Mode
- Power mode(standby)
- Lamp Hours
- Network Status
- IP Address
- Projector ID
- Filter Usage Hours
- Brightness Mode
- FW Version

USING THE PROJECTOR

USB Reader

Note: A USB flash disk must be plugged into the projector if you want to use the USB Reader function.

Follow these steps to playback photo or office files on your projector:

1. Connect one end of the power lead to the projector and the other end to the wall outlet. Then turn on the projector by pressing the “**U**” either on the projector keypad or the remote control. Please refer to “Connecting sources to the projector” on page 15 and “Powering on” on page 19.
2. Plug in a USB flash disk to your projector.
3. Press the  on the projector keypad or the  on the remote control and select **USB Reader**. The USB Reader page opens.

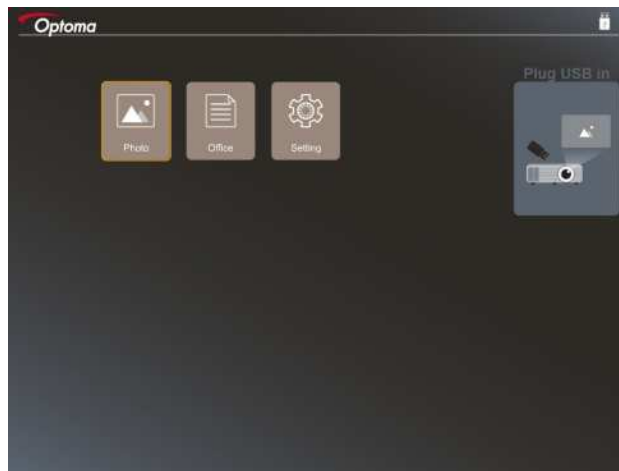







4. Access the USB menu and select the USB Reader files: **Photo** or **Office**. Or select the **Settings** option to change settings for photo or office.

USB support format

Storage	Device type	File system	File & Dir Level
USB	USB Flash	FAT16, FAT32, NTFS, ExFAT	<ul style="list-style-type: none">• Supports up to 999 directories/files• Path name length limit is 100 characters

Note: The supported USB storage size is up to 64GB.

Photo

Press the , , , or  to select a photo and then press the  on the projector keypad or the  on the remote control to access the photo viewer control.

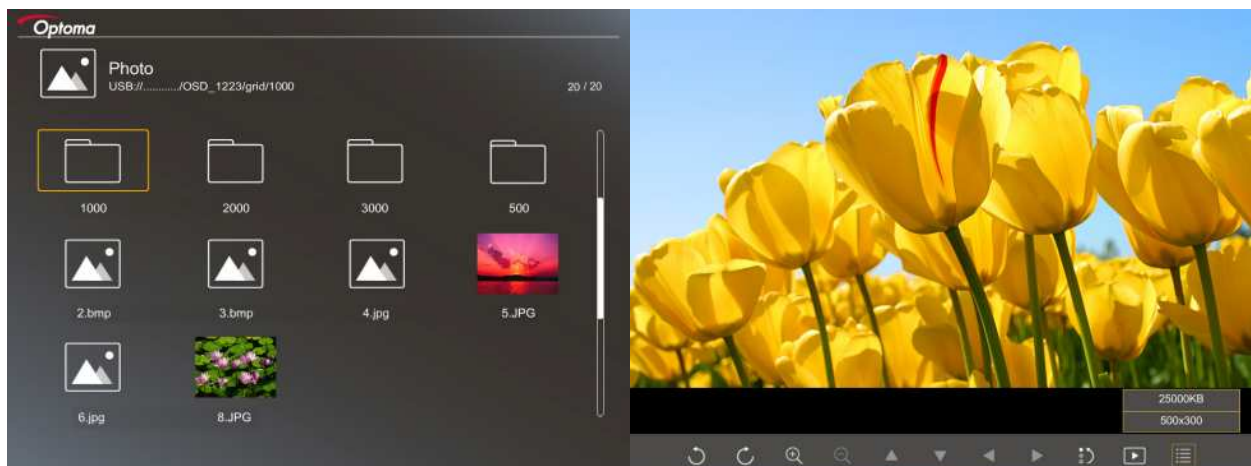

USING THE PROJECTOR

Press the ◀, ▶, ▲, or ▼ to select a control function on the screen and then press the ↵ on the projector keypad or the ⏻ on the remote control to execute the control function.

The control button icons and functions are included in the following table:







Function icon	Function description
	Rotate photo by 90 degrees
	Zoom in or Zoom out
	<ul style="list-style-type: none"> • Pan move when zoomed in • Move to the previous or next page when toolbar disappears (not supported when zoomed in)
	Reset the photo size to the default size (1x)
	View photos in a slideshow
	View photo information
 (on the remote control)	Move to the previous or next page

Photo support format

Image format	Profile	Color space	Size limitation
JPEG	Baseline	YUV400	8000*6000
		YUV420	8000*6000
		YUV422	8000*6000
		YUV440	8000*6000
		YUV444	8000*6000
	Progressive	YUV400	Width <= 8000 and height <= 6000
		YUV420	
		YUV422	
		YUV440	
		YUV444	

- Suggestion: Limit supported size of BMP and JPG progressive file.
- BMP resolution supports up to 1600x1200.
- JPEG progressive resolution support up to 1600x1200.

USING THE PROJECTOR

Office

Press the ◀, ▶, ▲, or ▼ to select a document and then press the ↵ on the projector keypad or the ⏻ on the remote control to access the document viewer control.

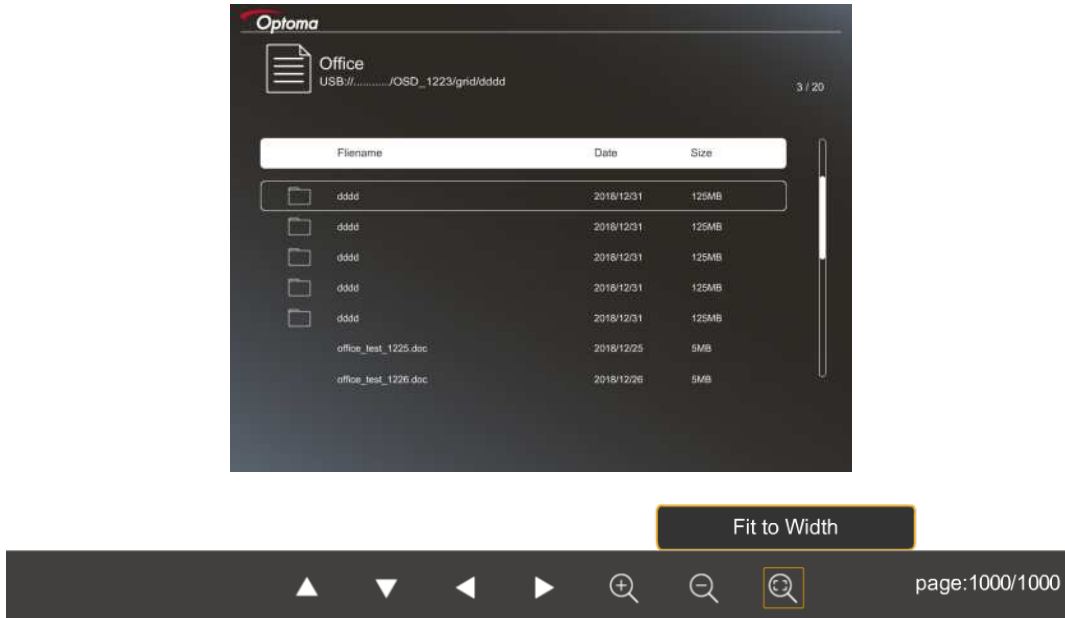

Press the ◀, ▶, ▲, or ▼ to select a control function on the screen and then press the ↵ on the projector keypad or the ⏻ on the remote control to execute the control function.

The control button icons and functions are included in the following table:

Function icon	Function description
	Zoom in or Zoom out Note: <i>The default magnification is set by the system.</i>
	<ul style="list-style-type: none"> • Pan move when zoomed in • Move to the previous or next page when toolbar disappears (not supported when zoomed in)
	Fit to height, Fit to width, or Fit to screen
page: 1000 / 1000	Current page / Total pages
	<ul style="list-style-type: none"> • Move to the previous or next page • Switch the worksheet in Excel

USING THE PROJECTOR

Document support format

File format	Support version	Pages/lines limitation	Size limitation	Comment
Adobe PDF	PDF 1.0	Up to 1000 pages per file	Up to 75 MB	-
	PDF 1.1			
	PDF 1.2			
	PDF 1.3			
	PDF 1.4			
MS Word	British Word 95	Because office viewer does not load all pages of MS Word file at the same time, there are no obvious limitations of page and line	Up to 100 MB	Not support Bold Text in Simple Chinese front
	Word 97, 2000, 2002, 2003			
	Word 2007 (.docx), 2010 (.docx)			
MS Excel	British Excel 5, 95	Row Limit: up to 595	Up to 15 MB	Not support password-protected sheets
	Excel 97, 2000, 2002, 2003	Column Limit: up to 256		
	Excel 2007 (.xlsx), 2010 (.xlsx)	Sheet: up to 100		
	Office XP Excel	Note: Any one of three limitations above can not appear on one excel file simultaneously.		
MS PowerPoint	British PowerPoint 97	Up to 1000 pages per file	Up to 19 MB	No support SlideShow order
	PowerPoint 2000, 2002, 2003			
	PowerPoint 2007 (.pptx)			
	PowerPoint 2010 (.pptx)			
	Office XP PowerPoint			
	PowerPoint presentation- -2003 and earlier(.pps)			
	PowerPoint presentation- -2007 and 2010 (.ppsx)			

Note: Animations in PowerPoint are not supported.

USING THE PROJECTOR

USB Display

Note: The USB Display function requires a tethered connection from the smart device to the projector.

Follow these steps to mirror your smart device's screen to the projector:

1. Connect one end of the power lead to the projector and the other end to the wall outlet. Then turn on the projector by pressing the "⏻" either on the projector keypad or the remote control. Please refer to "Connecting sources to the projector" on page 15 and "Powering on" on page 19.
2. Do any of the following:

For iOS:

- a) Press the  on the projector keypad or the  on the remote control and select **USB Display**. The USB Display page opens.

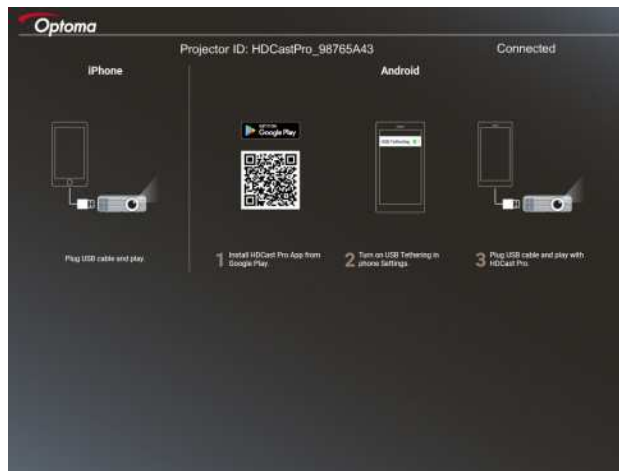

- b) Connect the projector and your smart device with a USB cable. Your smart device's screen will be automatically mirrored to the projector.

For Android:

- a) Download the **HDCast Pro** app from Google Play and install to your smart device.
- b) Tap **Settings > More** and enable **USB Tethering** on your smart device.

Note: The location of the tethering function may vary depending on your smart device.

- c) Connect the projector and your smart device with a USB cable.
- d) Open the **HDCast Pro** app on your smart device and tap on the **HDCast Pro** icon. Your smart device's screen will be mirrored to the projector.





USING THE PROJECTOR

Note:

- Supported operating system is Android version 5.0 or higher and the recommended CPU is Quad Core or higher.
- It is required 3.5mm phone jack or speaker to line out mobile content audio.
- The USB Display does not support apps with DRM (Digital Rights Management).
- Please use the default cable accessory that is shipped with your smart device.
- Those smart devices that support USB type C may not support USB Display function. The USB Display function uses USB 2.0 interface.

Network Display

Follow these steps to mirror your smart device's screen to the projector:

1. Connect one end of the power lead to the projector and the other end to the wall outlet. Then turn on the projector by pressing the "⏻" either on the projector keypad or the remote control. Please refer to "Connecting sources to the projector" on page 15 and "Powering on" on page 19.
2. Press the  on the projector keypad or the  on the remote control and select **Network Display**. The Network Display page opens.

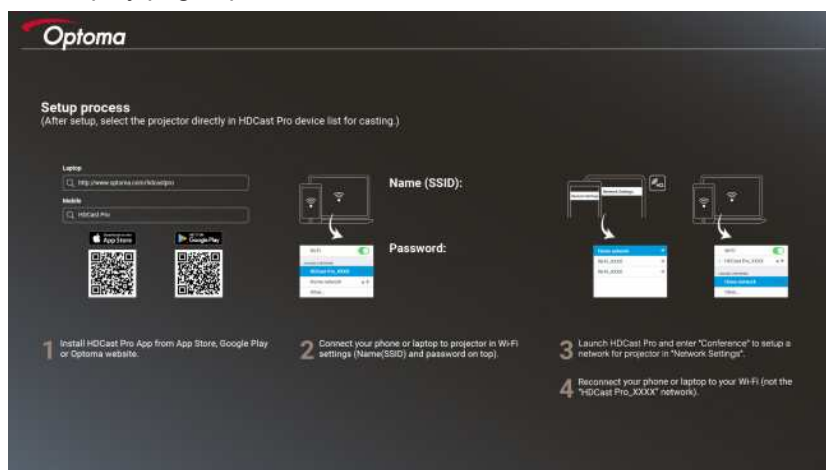

3. Depending on the operating system of your mobile device, open the App Store (iOS) or Google Play (Android) and install the **HDCast Pro** app on your smart device. If you are using a laptop, download the **HDCast Pro** app from www.optoma.com/hdcastpro website.
 4. Plug in a Wi-Fi dongle (optional) to your projector.
 5. Connect your smart device or laptop via Wi-Fi to the projector. An example connection parameters are as follows:
 - SSID of the projector: **HDCastPro_XXX**
 - Wi-Fi password: **XXX**
- Note:** The projector SSID and Wi-Fi password varies depending on the connected Wi-Fi dongle.
6. Open **HDCast Pro** app on your smart device or laptop and configure **Network Settings** in Conference menu to establish a connection to the projector.
 7. Connect your smart device or laptop to your preferred Wi-Fi access point other than **HDCast Pro_XXX**.

USING THE PROJECTOR

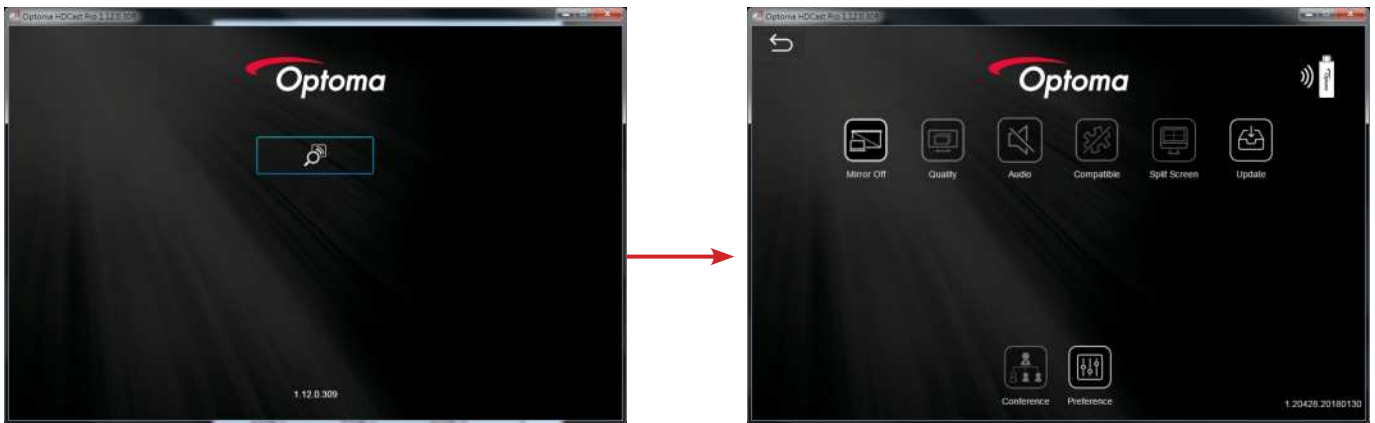

Supported Features

Device	Feature	Limitation
Laptop	Mirroring	Windows 10 Note: <i>Extension mode is not supported.</i>
	Split Screen	
iOS	Photo	Screen Mirroring, AirPlay, and video content are not supported
	Document	
	Camera	
	Split Screen	
Android	Mirroring	Video content is not supported
	Photo	
	Document	
	Camera	
	Split Screen	

System Requirements

Operating System / Item	Requirement
Windows:	
CPU	Dual Core Intel Core i 2.4GHz
Memory	DDR 4GB and above
Graphics card	256MB VRAM or above
Operating system	Windows 7 / 8.0 / 8.1 / 10 or above
Note:	
<ul style="list-style-type: none"> • <i>ATOM and Celeron processors are not supported.</i> • <i>Operating system with starter version is not supported.</i> • <i>Extension mode may not support some laptops with Windows 10 operating system.</i> 	
Mac:	
CPU	Dual Core Intel Core i 1.4GHz or higher Note: <i>PowerPC is not supported.</i>
Graphic card	Intel, nVIDIA, or ATI graphics card with 64MB VRAM or above
Operating system	Mac OS X 10.11 or above
Note: <i>Please ensure the operating system is up to date.</i>	

USING THE PROJECTOR

Operating System / Item	Requirement
iOS:	
iOS	iOS 10 or above
Device	All iPhone™ models after iPhone 5
	All iPad™ models after iPad mini 2
Storage	At least 40MB of free storage space
Android:	
Phone/Pad	Android 5.0 or above with 1GB RAM
Resolution	WVGA ~ 1080p
CPU	Quad Core or above
Storage	At least 40MB of free storage space

MAINTENANCE

Replacing the lamp

The projector automatically detects the lamp life. When the lamp life is nearing the end of use, a warning message will appear on the screen.



When you see this message, please contact your local reseller or service center to change the lamp as soon as possible. Make sure the projector has been cooled down for at least 30 minutes before changing the lamp.



Warning: If wall mounted, please use caution when opening the lamp access panel. It is recommended to wear safety glasses if changing the bulb when wall mounted. Caution must be used to prevent any loose parts from falling out of projector.



Warning: Lamp compartment is hot! Allow it to cool down before changing lamp!



Warning: To reduce the risk of personal injury, do not drop the lamp module or touch the lamp bulb. The bulb may shatter and cause injury if it is dropped.

MAINTENANCE

Replacing the lamp (continued)

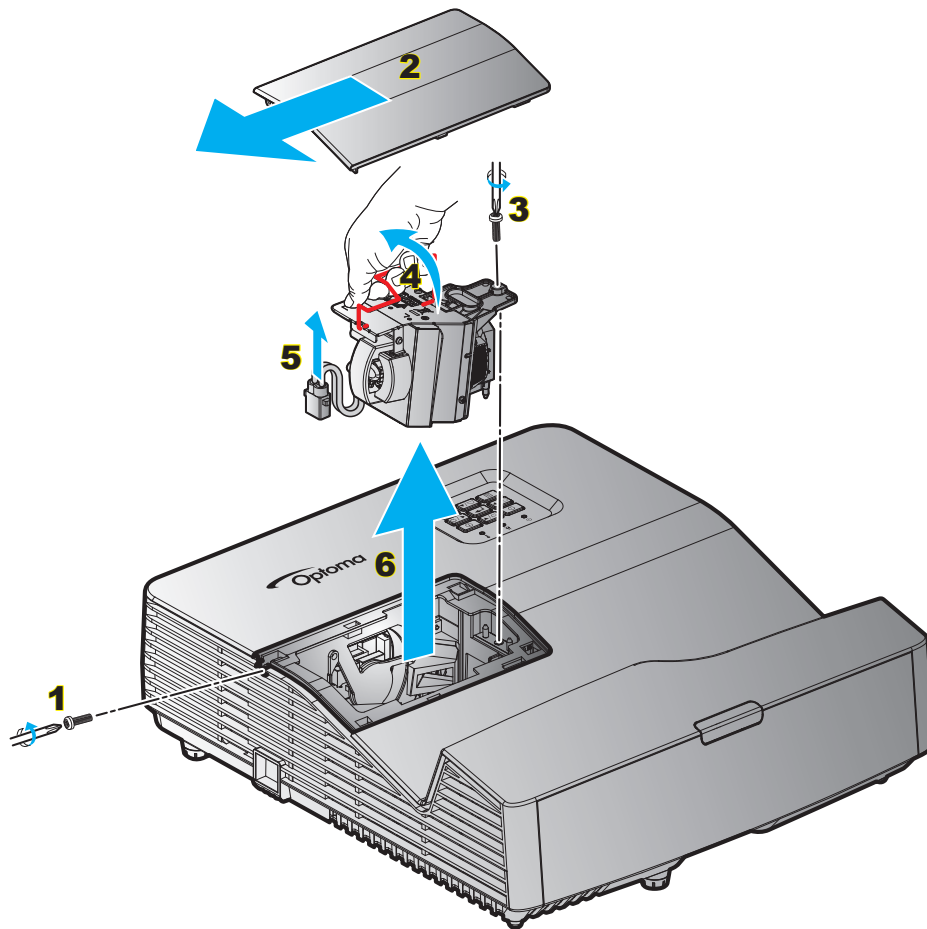

Procedure:

1. Switch off the power to the projector by pressing the "⏻" button on the remote control or the projector keypad.
2. Allow the projector to cool down for at least 30 minutes.
3. Disconnect the power cord.
4. Unscrew the screw on the cover. **1**
5. Remove the cover. **2**
6. Unscrew the screw on the lamp module. **3**
7. Lift up the lamp handle. **4**
8. Remove the lamp cord. **5**
9. Remove the lamp module carefully. **6**
10. To replace the lamp module, reverse the previous steps.
11. Turn on the projector and reset the lamp timer.
12. Lamp Reset: (i) Press "Menu" → (ii) Select "Setup" → (iii) Select "Lamp Settings" → (iv) Select "Lamp Reset" → (v) Select "Yes".

Note:

- *The screw on the lamp cover and the lamp cannot be removed.*
- *The projector cannot be turned on if the lamp cover has not been placed back on the projector.*
- *Do not touch the glass area of the lamp. Hand oil can cause the lamp shatter. Use a dry cloth to clean the lamp module if it was accidentally touched.*

MAINTENANCE

Installing and cleaning the dust filter

Installing the dust filter

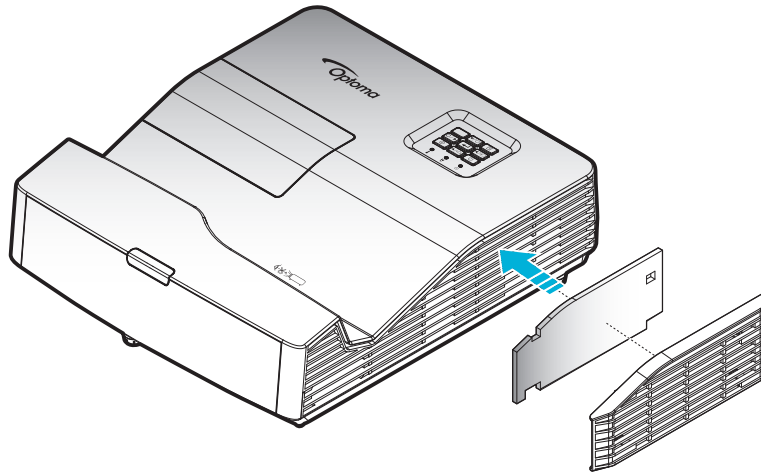

Note: Dust filters are only required/supplied in the selected regions with excessive dust.

Cleaning the dust filter

We recommend you to clean the dust filter every three months. Clean it more often if the projector is used in a dusty environment.

Procedure:

1. Switch off the power to the projector by pressing the "⏻" button on the remote control or the projector keypad.
2. Disconnect the power cord.
3. Remove the dust filter carefully. **1**
4. Clean or replace the dust filter. **2**
5. To install the dust filter, reverse the previous steps.

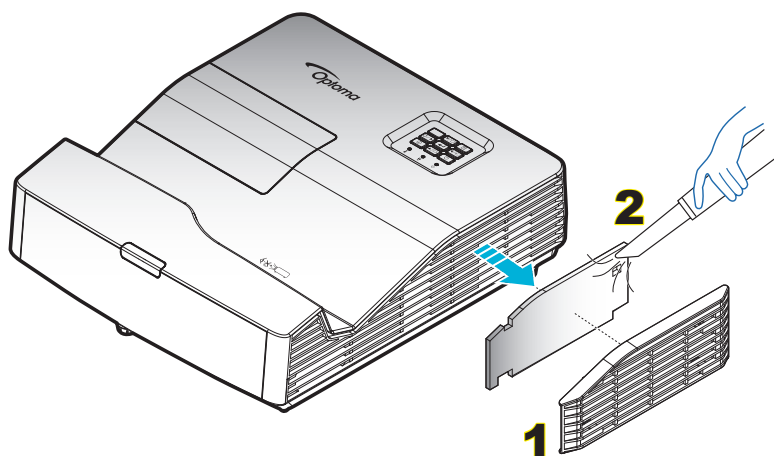

ADDITIONAL INFORMATION

Compatible resolutions

Digital compatibility

B0/Established Timing	B0/Standard Timing	B0/Detail Timing	B1/Video Mode	B1/Detail Timing
720x400 @ 70Hz	XGA/WXGA:	Native timing:	640x480p @ 60Hz	720x480p @ 60Hz
640x480 @ 60Hz	1440x900 @ 60Hz	XGA: 1024x768 @ 60Hz	720x480p @ 60Hz	1280x720p @ 60Hz
640x480 @ 67Hz	1024x768 @ 120Hz	WXGA: 1280x800 @ 60Hz	1280x720p @ 60Hz	1366x768 @ 60Hz
640x480 @ 72Hz	1280x800 @ 60Hz		1920x1080i @ 60Hz	1920x1080i @ 50Hz
640x480 @ 75Hz	1280x1024 @ 60Hz		720(1440)x480i @ 60Hz	1920x1080p @ 60Hz
800x600 @ 56Hz	1680x1050 @ 60Hz		1920x1080p @ 60Hz	
800x600 @ 60Hz	1280x720 @ 60Hz		720x576p @ 50Hz	
800x600 @ 72Hz	1280x720 @ 120Hz		1280x720p @ 50Hz	
800x600 @ 75Hz	1600x1200 @ 60Hz		1920x1080i @ 50Hz	
1024x768 @ 60Hz			720(1440)x576i @ 50Hz	
1024x768 @ 70Hz			1920x1080p @ 50Hz	
1024x768 @ 75Hz			1920x1080p @ 24Hz	
1280x1024 @ 75Hz			1920x1080p @ 30Hz	

Analog compatibility

B0/Established Timing	B0/Standard Timing	B0/Detail Timing	B1/Video Mode	B1/Detail Timing
720x400 @ 70Hz	XGA/WXGA:	Native timing:		1366x768 @ 60Hz
640x480 @ 60Hz	1440x900 @ 60Hz	XGA: 1024x768 @ 60Hz		
640x480 @ 67Hz	1024x768 @ 120Hz	WXGA: 1280x800 @ 60Hz		
640x480 @ 72Hz	1280x800 @ 60Hz			
640x480 @ 75Hz	1280x1024 @ 60Hz			
800x600 @ 56Hz	1680x1050 @ 60Hz			
800x600 @ 60Hz	1280x720 @ 60Hz			
800x600 @ 72Hz	1280x720 @ 120Hz			
800x600 @ 75Hz	1600x1200 @ 60Hz			
1024x768 @ 60Hz				
1024x768 @ 70Hz				
1024x768 @ 75Hz				
1280x1024 @ 75Hz				

ADDITIONAL INFORMATION

True 3D video compatibility

Input resolutions	HDMI 1.4a 3D Input	Input timing		
		1280x720P @ 50Hz	Top - and - Bottom	
		1280x720P @ 60Hz	Top - and - Bottom	
		1280x720P @ 50Hz	Frame packing	
		1280x720P @ 60Hz	Frame packing	
		1920x1080i @ 50 Hz	Side- by-Side (Half)	
		1920x1080i @ 60 Hz	Side- by-Side (Half)	
		1920x1080p @ 24 Hz	Top - and- Bottom	
		1920x1080p @ 24 Hz	Frame packing	
		HDMI 1.3	1920x1080i @ 50Hz	Side-by-Side(Half)
	1920x1080i @ 60Hz			
	1280x720P @ 50Hz			
	1280x720P @ 60Hz			
	480i		HQFS	3D format is Frame sequential

Note:

- If 3D input is 1080p@24hz, the DMD should replay with integral multiple with 3D mode.
- Support NVIDIA 3DTV Play if there is no patent fee from Optoma. 1080i@25hz and 720p@50hz will run in 100 hz; other 3D timing will run in 120hz.
- 1080p@24hz will run in 144Hz.

ADDITIONAL INFORMATION

Image size and projection distance

(XGA)

a	b	c	d	w		H		g		m	P
				(inch)	(m)	(inch)	(m)	(feet)	(m)		
Image Offset from the center of the lens to the top of the vertical image (m)	Distance from center of lens to the bottom of projector (m)	Distance between the wall (projection surface) to the back of projector (m)	Image Diagonal (inch)	Width of Image Size		Height of Image Size		Distance between the wall (projection surface) and center of lens		Distance between the wall (projection surface) and the front of the projector (m)	Distance from top of projector to mounting hole (m)
0.218	0.0592	0.164	70	56.0	1.42	42.0	1.07	1.55	0.47	0.547	0.108
0.230	0.0592	0.191	74	59.2	1.50	44.4	1.13	1.64	0.50	0.574	0.108
0.249	0.0592	0.231	80	64.0	1.63	48.0	1.22	1.77	0.54	0.614	0.108
0.280	0.0592	0.299	90	72.0	1.83	54.0	1.37	1.99	0.61	0.682	0.108
0.311	0.0592	0.366	100	80.0	2.03	60.2	1.52	2.21	0.67	0.749	0.108

(WXGA)

a	b	c	d	w		H		g		m	P
				(inch)	(m)	(inch)	(m)	(feet)	(m)		
Image Offset from the center of the lens to the top of the vertical image (m)	Distance from center of lens to the bottom of projector (m)	Distance between the wall (projection surface) to the back of projector (m)	Image Diagonal (inch)	Width of Image Size		Height of Image Size		Distance between the wall (projection surface) and center of lens		Distance between the wall (projection surface) and the front of the projector (m)	Distance from top of projector to mounting hole (m)
0.201	0.0592	0.177	85	72.1	1.83	45.0	1.14	1.59	0.49	0.560	0.108
0.206	0.0592	0.188	87	73.8	1.87	46.1	1.17	1.63	0.50	0.571	0.108
0.213	0.0592	0.205	90	76.3	1.94	47.7	1.21	1.69	0.51	0.588	0.108
0.237	0.0592	0.262	100	84.8	2.15	53.0	1.35	1.87	0.57	0.645	0.108
0.261	0.0592	0.319	110	93.3	2.37	58.3	1.48	2.06	0.63	0.702	0.108
0.272	0.0592	0.348	115	97.5	2.48	60.9	1.55	2.15	0.66	0.731	0.108

(1080P)

a	b	c	d	w		H		g		m	P
				(inch)	(m)	(inch)	(m)	(feet)	(m)		
Image Offset from the center of the lens to the top of the vertical image (m)	Distance from center of lens to the bottom of projector (m)	Distance between the wall (projection surface) to the back of projector (m)	Image Diagonal (inch)	Width of Image Size		Height of Image Size		Distance between the wall (projection surface) and center of lens		Distance between the wall (projection surface) and the front of the projector (m)	Distance from top of projector to mounting hole (m)
0.187	0.0589	0.138	80	69.7	1.77	39.2	1.00	1.46	0.45	0.521	0.108
0.208	0.0589	0.188	89	77.6	1.97	43.6	1.11	1.63	0.50	0.571	0.108
0.211	0.0589	0.194	90	78.4	1.99	44.1	1.12	1.65	0.50	0.577	0.108
0.234	0.0589	0.249	100	87.2	2.21	49.0	1.25	1.83	0.56	0.632	0.108

ADDITIONAL INFORMATION

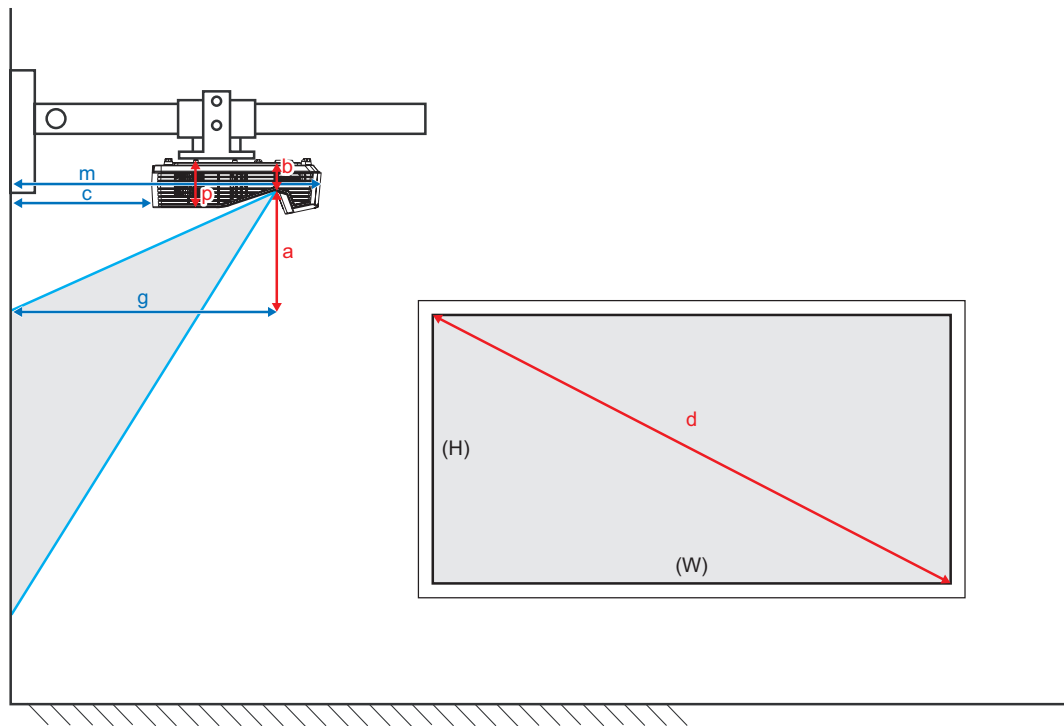

ADDITIONAL INFORMATION

Projector dimensions and wall mount installation

1. To prevent damage to your projector, please use the Optoma wall mount.
2. If you wish to use a third party wall mount kit, please ensure the screws used to attach a mount to the projector meet the following specifications:
 - Screw type: M4*3
 - Minimum screw length: 10mm

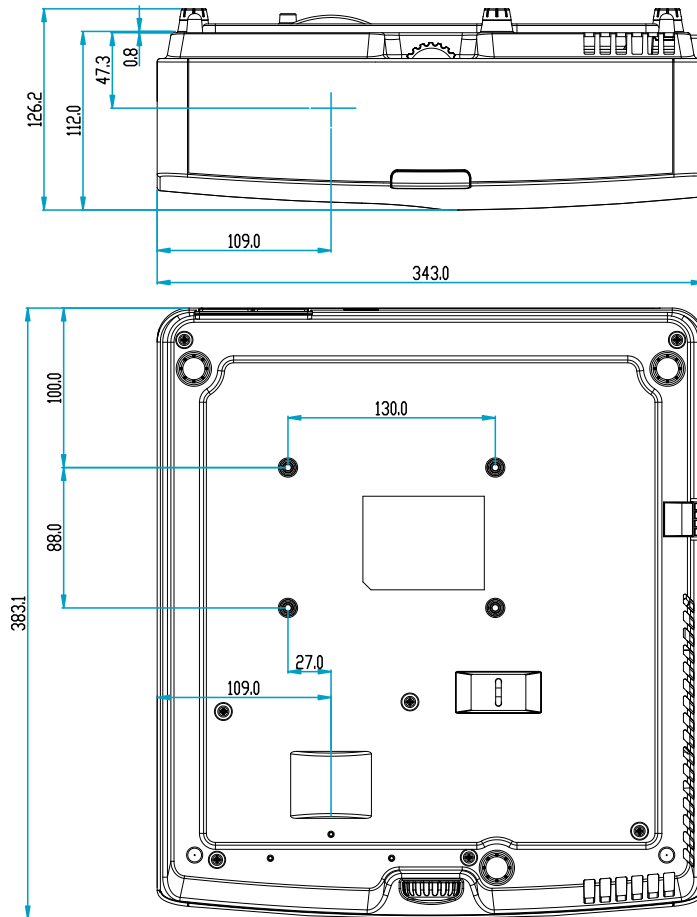

Unit: mm

Note: Please note that damage resulting from incorrect installation will void the warranty.



Warning:

- If you buy a wall mount from another company, please be sure to use the correct screw size. Screw size will vary depending on the thickness of the mounting plate.
- Be sure to keep at least 10 cm gap between the ceiling and the bottom of the projector.
- Avoid installing the projector near a heat source.

ADDITIONAL INFORMATION

IR remote codes

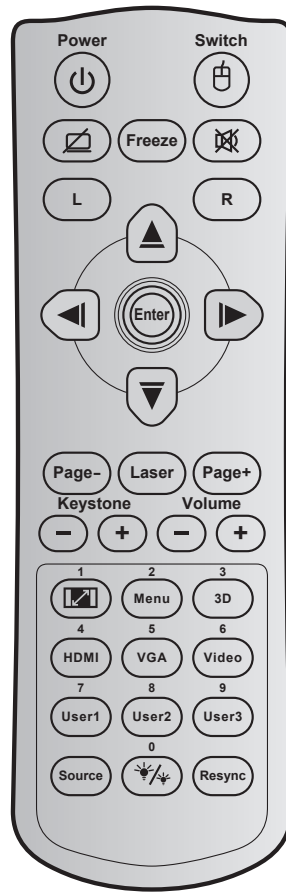

Key	Repeat Format	Address		Data		Printing-key definition	Description	
		Byte 1	Byte 2	Byte 3	Byte 4			
Power		F1	32	CD	81	7E	Power on/off	Press to turn on / off the projector.
Switch		F1	32	CD	3E	C1	Switch	Press to switch the USB mouse on / off.
Display blank / Audio mute		F1	32	CD	8A	75		Press to hide / unhide the screen picture and turn off / on audio.
Freeze		F1	32	CD	8B	74	Freeze	Press to freeze the projector image.
Mute		F1	32	CD	92	6D		Press to momentarily turn off / on the audio.
Mouse left click	L	F1	32	CD	CB	34	L	Use as mouse left click.
Mouse right click	R	F1	32	CD	CC	33	R	Use as mouse right click.
Four directional select keys		F2	32	CD	C6	39	Up arrow	Use to select items or make adjustments to your selection.
		F2	32	CD	C8	37	Left arrow	
		F2	32	CD	C9	36	Right arrow	
		F2	32	CD	C7	38	Down arrow	
Enter		F1	32	CD	C5/CA	3A/35	Enter	Confirm your item selection.
Page -		F2	32	CD	C2	3D	Page-	Press to page down.
Laser		-	-	-	-	-	Laser	Use as laser pointer.
Page +		F2	32	CD	C1	3E	Page+	Press to page up.

ADDITIONAL INFORMATION

Key		Repeat Format	Address		Data		Printing-key definition	Description
			Byte 1	Byte 2	Byte 3	Byte 4		
Keystone		F2	32	CD	85	7A	Keystone+	Press to adjust image distortion caused by tilting the projector.
		F2	32	CD	84	7B	Keystone-	
Volume		F2	32	CD	8C	73	Volume +	Press to adjust to increase / decrease the volume.
		F2	32	CD	8F	70	Volume -	
Aspect ratio / 1		F1	32	CD	98	67	/ 1	<ul style="list-style-type: none"> Press to change aspect ratio of a displayed image. Use as numeric keypad number "1".
Menu / 2		F1	32	CD	88	77	Menu/2	<ul style="list-style-type: none"> Press to display or exit the on-screen display menus for projector. Use as numeric keypad number "2".
3D / 3		F1	32	CD	93	6C	3D/3	<ul style="list-style-type: none"> Press to manually select a 3D mode that matches your 3D content. Use as numeric keypad number "3".
HDMI / 4		F1	32	CD	86	79	HDMI/4	<ul style="list-style-type: none"> Press to choose HDMI source. Use as numeric keypad number "4".
VGA / 5		F1	32	CD	D0	2F	VGA/5	<ul style="list-style-type: none"> Press to choose VGA source. Use as numeric keypad number "5".
Video / 6		F1	32	CD	D1	2E	Video/6	<ul style="list-style-type: none"> Press to choose composite video source. Use as numeric keypad number "6".
User1 / 7; User2 / 8; User3 / 9		F1	32	CD	D2	2D	User 1/7	<ul style="list-style-type: none"> User defined keys. Please see page 41. Use as numeric keypad numbers "7", "8", and "9" accordingly.
		F1	32	CD	D3	2C	User 2/8	
		F1	32	CD	D4	2B	User 3/9	
Source		F1	32	CD	C3	3C	Source	Press to select an input signal.
Brightness mode / 0		F1	32	CD	96	69	/ 0	<ul style="list-style-type: none"> Press to automatically adjust the picture brightness to give an optimum contrast performance. Use as numeric keypad number "0".
Re-sync		F1	32	CD	C4	3B	Re-Sync	Press to automatically synchronize the projector to the input source.

ADDITIONAL INFORMATION

Troubleshooting

If you experience a problem with your projector, please refer to the following information. If a problem persists, please contact your local reseller or service center.

Image problems

- ❓ *No image appears on-screen*
 - Ensure all the cables and power connections are correctly and securely connected as described in the "Installation" section.
 - Ensure the pins of connectors are not crooked or broken.
 - Check if the projection lamp has been securely installed. Please refer to the "Replacing the Lamp" section.

- ❓ *Image is out of focus*
 - Adjust the focus ring on the projector lens.
 - Make sure the projection screen is between the required distance from the projector. (Please refer to pages 64-65).

- ❓ *The image is stretched when displaying 16:9 DVD title*
 - When you play anamorphic DVD or 16:9 DVD, the projector will show the best image in 16: 9 format on projector side.
 - If you play the LBX format DVD title, please change the format as LBX in projector OSD.
 - If you play 4:3 format DVD title, please change the format as 4:3 in projector OSD.
 - Please setup the display format as 16:9 (wide) aspect ratio type on your DVD player.

- ❓ *Image is too small or too large*
 - Move the projector closer to or further from the screen.
 - Press "Menu" on the projector panel, go to "Display >Aspect Ratio". Try the different settings.

- ❓ *Image has slanted sides:*
 - If possible, reposition the projector so that it is centered on the screen and below the bottom of the screen.
 - Use "Display > Geometric Correction > H Keystone or V Keystone" from the OSD to make an adjustment.

- ❓ *Image is reversed*
 - Select "Setup > Projection" from the OSD and adjust the projection direction.

- ❓ *Blurry double image*
 - Press "3D" button and switch to "Off" to avoid normal 2D image is blurry double image.

- ❓ *Two images, side-by-side format*
 - Press "3D" button and switch to "SBS" for input signal is HDMI 1.3 2D 1080i side-by-side.

ADDITIONAL INFORMATION

Image does not display in 3D

- Check if the battery of 3D glasses is drained.
- Check if the 3D glasses is turned on.
- When the input signal is HDMI 1.3 2D (1080i side-by-side half), press "3D" button and switch to "SBS".

Other problems

The projector stops responding to all controls

- If possible, turn off the projector, then unplug the power cord and wait at least 20 seconds before reconnecting power.

Lamp burns out or makes a popping sound

- When the lamp reaches its end of life, it will burn out and may make a loud popping sound. If this happens, the projector will not turn on until the lamp module has been replaced. To replace the lamp, follow the procedures in the "Replacing the Lamp" section on pages 59-60.

Remote control problems

If the remote control does not work

- Check the operating angle of the remote control is pointed within $\pm 15^\circ$ to the IR receiver on the projector.
- Make sure there are not any obstructions between the remote control and the projector. Move to within 7 m (23 ft) of the projector.
- Make sure batteries are inserted correctly.
- Replace batteries if they are exhausted.

Warning indicators





When the warning indicators (see below) light up or flash, the projector will automatically shutdown:

- "LAMP" LED indicator is lit red and if "On/Standby" indicator flashes red.
- "TEMP" LED indicator is lit red and if "On/Standby" indicator flashes red. This indicates the projector has overheated. Under normal conditions, the project can be switched back on.
- "TEMP" LED indicator flashes red and if "On/Standby" indicator flashes red.

Unplug the power cord from the projector, wait for 30 seconds and try again. If the warning indicator light up or flash, please contact your nearest service center for assistance.

ADDITIONAL INFORMATION

LED lightning messages

Message	 Power LED	 Power LED	 Temp-LED	 Lamp-LED
	(Red)	(Blue)	(Red)	(Red)
Standby state (Input power cord)	Steady light			
Power on (Warming)		Flashing (0.5 sec off / 0.5 sec on)		
Power on and Lamp lighting		Steady light		
Power off (Cooling)		Flashing (0.5 sec off / 0.5 sec light). Back to red steady light when cooling fan turns off.		
Quick Resume (100 secs)		Flashing (0.25 sec off / 0.25 sec light)		
Error (Lamp fail)	Flashing			Steady light
Error (Fan failure)	Flashing		Flashing	
Error (Over Temp)	Flashing		Steady light	
Standby State (Burn in mode)		Flashing		
Burnin (Warming)		Flashing		
Burnin (Cooling)		Flashing		

- Power off:

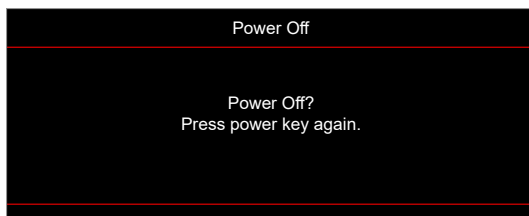

- Lamp warning:



- Temperature warning:

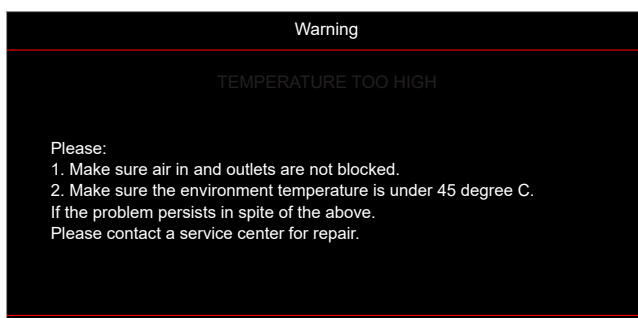

ADDITIONAL INFORMATION

- Fan failed:

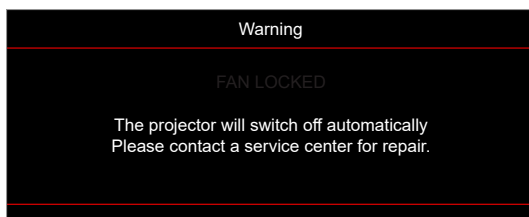

- Out of display range:

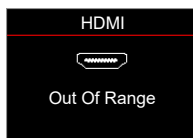

- Power down warning:

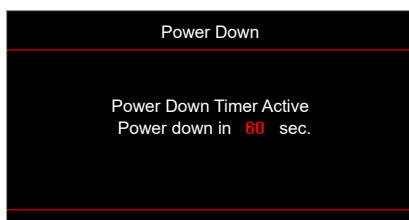

- Security timer alarm:



ADDITIONAL INFORMATION

Specifications

Optical	Description
Maximum resolution	- Video timing up to 1080p - Graphics timing up to 1920x1080 @ 60Hz
Native resolution	XGA/ WXGA/ 1080p
Lens	Manual focus
Image size (diagonal)	- XGA: 70" ~ 100" - WXGA: 85" ~ 115" - 1080P: 80" ~ 100"
Projection distance	- XGA: 0.472m ~ 0.675m - WXGA: 0.485m ~ 0.656m - 1080P: 0.446m ~ 0.558m Note: Projection distance from mirror (m).

Electrical	Description
Inputs	- HDMI 1.4a - HDMI 1.4a + MHL (v2.2) - VGA-IN - Audio 3.5mm
Outputs	- VGA - Audio 3.5mm - USB-A power 5V/1A
Control	- RJ45 - RS232 - USB mouse / service
Color reproduction	1073.4 Million color
Scan rate	- Horizontal scan rate: 15.375~91.146 KHz - Vertical scan rate: 24~ 85 Hz (120Hz for 3D feature projector)
Built-in speaker	Yes, 16W
Power requirement	AC 100-240V~, 50/60Hz
Input current	3.3A

Mechanical	Description
Installation orientation	Front, Rear, Ceiling - top, Rear - top
Dimensions	343 mm (W) x 383 mm (D) x 96.5 mm (H) (without feet)
Weight	3.9 ± 0.5 kg
Environmental conditions	Operating in 5 ~ 40°C , 10% to 85% humidity (non-condensing)

Note: All specifications are subject to change without notice.



ADDITIONAL INFORMATION

Optoma global offices

For service or support, please contact your local office.



USA

47697 Westinghouse Drive,
Fremont, CA 94539, USA
www.optomausa.com

 888-289-6786
 510-897-8601
 services@optoma.com



Canada

47697 Westinghouse Drive,
Fremont, CA 94539, USA
www.optomausa.com

 888-289-6786
 510-897-8601
 services@optoma.com



Latin America

47697 Westinghouse Drive,
Fremont, CA 94539, USA
www.optomausa.com

 888-289-6786
 510-897-8601
 services@optoma.com



Europe

Unit 1, Network 41, Bourne End Mills
Hemel Hempstead, Herts,
HP1 2UJ, United Kingdom
www.optoma.eu
Service Tel : +44 (0)1923 691865

 +44 (0) 1923 691 800
 +44 (0) 1923 691 888
 service@tsc-europe.com



Benelux BV

Randstad 22-123
1316 BW Almere
The Netherlands
www.optoma.nl

 +31 (0) 36 820 0252
 +31 (0) 36 548 9052



France

Bâtiment E
81-83 avenue Edouard Vaillant
92100 Boulogne Billancourt, France

 +33 1 41 46 12 20
 +33 1 41 46 94 35
 savoptoma@optoma.fr



Spain

C/ José Hierro,36 Of. 1C
28522 Rivas VaciaMadrid,
Spain

 +34 91 499 06 06
 +34 91 670 08 32



Deutschland

Wiesenstrasse 21 W
D40549 Düsseldorf,
Germany

 +49 (0) 211 506 6670
 +49 (0) 211 506 66799
 info@optoma.de

Scandinavia



Lerpeveien 25
3040 Drammen
Norway

 +47 32 98 89 90
 +47 32 98 89 99
 info@optoma.no

PO.BOX 9515
3038 Drammen
Norway

Korea

WOOMI TECH.CO.,LTD.
4F, Minu Bldg.33-14, Kangnam-Ku,
Seoul,135-815, KOREA
korea.optoma.com

 +82+2+34430004
 +82+2+34430005



Japan

東京都足立区綾瀬3-25-18
株式会社オーエス
コンタクトセンター:0120-380-495

 info@os-worldwide.com
www.os-worldwide.com



Taiwan

12F., No.213, Sec. 3, Beixin Rd.,
Xindian Dist., New Taipei City 231,
Taiwan, R.O.C.
www.optoma.com.tw

 +886-2-8911-8600
 +886-2-8911-6550
 services@optoma.com.tw
asia.optoma.com



Hong Kong

Unit A, 27/F Dragon Centre,
79 Wing Hong Street,
Cheung Sha Wan,
Kowloon, Hong Kong

 +852-2396-8968
 +852-2370-1222
www.optoma.com.hk

China

5F, No. 1205, Kaixuan Rd.,
Changning District
Shanghai, 200052, China

 +86-21-62947376
 +86-21-62947375
www.optoma.com.cn



P/N:36.7C601G001-A