



Table of Contents

Table of Contents	1	SETUP Audio Settings.....	43
Usage Notice	2	SETUP Security.....	44
Safety Information.....	2	SETUP Advanced	45
Precautions.....	3	OPTIONS.....	46
Eye Safety Warnings	6	OPTIONS Lamp Settings.....	49
Introduction.....	7	OPTIONS HDMI Link Settings.....	50
Package Overview.....	7	OPTIONS Remote Settings.....	52
Product Overview	8	OPTIONS Advanced.....	53
Main Unit.....	8	Appendices.....	54
Keypad.....	9	Troubleshooting	54
Input/Output Connections.....	10	Image Problems.....	54
Remote Control.....	11	Other Problems.....	56
Installation	12	Remote Control Problems	56
Connecting to the Projector	12	LED Lighting Messages.....	57
Connecting a Computer/Notebook	12	On Screen Messages	58
Connecting a Video source.....	13	Replacing the Lamp.....	59
Connect to 3D Video Devices.....	14	Installing and Cleaning the Dust Filter.....	61
Using the 3D glasses.....	16	Compatibility Modes	62
Powering On/Off the Projector.....	17	Ceiling Mount Installation.....	64
Powering On the Projector.....	17	Optoma Global Offices	65
Powering Off the Projector.....	18	Regulation & Safety Notices	67
Warning Indicator.....	19	FCC Notice	67
.....	19	Declaration of Conformity for EU coun- tries.....	68
Adjusting the Projected Image.....	20		
Adjusting the Projector's Height	20		
Adjusting the Projector's Zoom / Focus.....	21		
Adjusting Projection Image Size	21		
User Controls	23		
Keypad & Remote Control.....	23		
Keypad.....	23		
Remote Control.....	24		
On-screen Display Menus	31		
How to operate	31		
Menu Tree.....	32		
IMAGE.....	34		
IMAGE Advanced	36		
DISPLAY.....	38		
DISPLAY 3D	40		
SETUP.....	41		

Safety Information

	The lightning flash with arrow head within an equilateral triangle is intended to alert the user to the presence of uninsulated "dangerous voltage" within the product's enclosure that may be of sufficient magnitude to constitute a risk of electric shock to persons.
	The exclamation point within an equilateral triangle is intended to alert the user to the presence of important operating and maintenance (servicing) instructions in the literature accompanying the appliance.

WARNING: TO REDUCE THE RISK OF FIRE OR ELECTRIC SHOCK, DO NOT EXPOSE THIS APPLIANCE TO RAIN OR MOISTURE. DANGEROUS HIGH VOLTAGES ARE PRESENT INSIDE THE ENCLOSURE. DO NOT OPEN THE CABINET. REFER SERVICING TO QUALIFIED PERSONNEL ONLY.

Class B emissions limits

This Class B digital apparatus meets all requirements of the Canadian Interference-Causing Equipment Regulations.

Important Safety Instruction

1. Do not block any ventilation openings. To ensure reliable operation of the projector and to protect from over heating, it is recommended to install the projector in a location that does not block ventilation. As an example, do not place the projector on a crowded coffee table, sofa, bed, etc. Do not put the projector in an enclosure such as a book case or a cabinet that restricts air flow.
2. Do not use the projector near water or moisture. To reduce the risk of fire and/or electric shock, do not expose the projector to rain or moisture.
3. Do not install near heat sources such as radiators, heaters, stoves or any other apparatus such as amplifiers that emits heat.
4. Clean only with dry cloth.
5. Only use attachments/accessories specified by the manufacturer.
6. Do not use the unit if it has been physically damaged or abused. Physical damage/abuse would be (but not limited to):
 - Unit has been dropped.
 - Power supply cord or plug has been damaged.
 - Liquid has been spilled on to the projector.
 - Projector has been exposed to rain or moisture.
 - Something has fallen in the projector or something is loose inside.Do not attempt to service the unit yourself. Opening or removing covers may expose you to dangerous voltages or other hazards. Please call Optoma before you send the unit for repair.
7. Do not let objects or liquids enter the projector. They may touch dangerous voltage points and short out parts that could result in fire or electric shock.
8. See projector enclosure for safety related markings.
9. The unit should only be repaired by appropriate service personnel.

Precautions



Please follow all warnings, precautions and maintenance as recommended in this user's guide.



❖ When the lamp reaches the end of its life, the projector will not turn back on until the lamp module has been replaced. To replace the lamp, follow the procedures listed under "Replacing the Lamp" section on pages 59-60.

■ ■ Warning-

Do not look into the projector's lens when the lamp is on. The bright light may hurt your eyes.

■ ■ Warning-

To reduce the risk of fire or electric shock, do not expose this projector to rain or moisture.

■ ■ Warning-

Please do not open or disassemble the projector as this may cause electric shock.

■ ■ Warning-

When replacing the lamp, please allow the unit to cool down. Follow instructions as described on pages 59-60.

■ ■ Warning-

This projector will detect the life of the lamp itself. Please be sure to change the lamp when it shows warning messages.

■ ■ Warning-

Reset the "Lamp Reset" function from the on-screen display "Options|Lamp Settings" menu after replacing the lamp module (refer to page 49).

■ ■ Warning-

When switching the projector off, please ensure the cooling cycle has been completed before disconnecting power. Allow 90 seconds for the projector to cool down.

■ ■ Warning-

Do not use lens cap when projector is in operation.

■ ■ Warning-

When the lamp is approaching to the end of its life time, the message "Lamp life exceeded." will show on the screen. Please contact your local reseller or service center to change the lamp as soon as possible.

Usage Notice

Do:

- ❖ Turn off and unplug the power plug from the AC outlet before cleaning the product.
- ❖ Use a soft dry cloth with mild detergent to clean the display housing.
- ❖ Disconnect the power plug from AC outlet if the product is not being used for a long period of time.

Do not:

- ❖ Block the slots and openings on the unit provided for ventilation.
- ❖ Use abrasive cleaners, waxes or solvents to clean the unit.
- ❖ Use under the following conditions:
 - In extremely hot, cold or humid environments.
 - ▶ Ensure that the ambient room temperature is within 5°C ~ 40°C
 - ▶ Relative humidity is 10% ~ 85%
 - In areas susceptible to excessive dust and dirt.
 - Near any appliance generating a strong magnetic field.
 - In direct sunlight.

Viewing 3D projection using the 3D function

IMPORTANT SAFETY INFORMATION. READ THE FOLLOWING WARNINGS BEFORE YOU OR YOUR CHILD USE THE 3D FUNCTION.

Warning

- ❖ Children and teenagers may be more susceptible to health issues associated with viewing in 3D and should be closely supervised when viewing these images.

Photosensitive Seizure Warning and Other Health Risks

- ❖ Some viewers may experience an epileptic seizure or stroke when exposed to certain flashing images or lights contained in certain Projector pictures or video games. If you suffer from, or have a family history of epilepsy or strokes, please consult with a medical specialist before using the 3D function.
- ❖ Even those without a personal or family history of epilepsy or stroke may have an undiagnosed condition that can cause photosensitive epileptic seizures.

Usage Notice

- ❖ Pregnant women, the elderly, sufferers of serious medical conditions, those who are sleep deprived or under the influence of alcohol should avoid utilizing the unit's 3D functionality.
- ❖ If you experience any of the following symptoms, stop viewing 3D pictures immediately and consult a medical specialist: (1) altered vision; (2) light-headedness; (3) dizziness; (4) involuntary movements such as eye or muscle twitching; (5) confusion; (6) nausea; (7) loss of awareness; (8) convulsions; (9) cramps; and/ or (10) disorientation. Children and teenagers may be more likely than adults to experience these symptoms. Parents should monitor their children and ask whether they are experiencing these symptoms.
- ❖ Watching 3D projection may also cause motion sickness, perceptual after effects, disorientation, eye strain and decreased postural stability. It is recommended that users take frequent breaks to lessen the potential of these effects. If your eyes show signs of fatigue or dryness or if you have any of the above symptoms, immediately discontinue use of this device and do not resume using it for at least thirty minutes after the symptoms have subsided.
- ❖ Watching 3D projection while sitting too close to the screen for an extended period of time may damage your eyesight. The ideal viewing distance should be at least three times the screen height. It is recommended that the viewer's eyes are level with the screen.
- ❖ Watching 3D projection while wearing 3D glasses for an extended period of time may cause a headache or fatigue. If you experience a headache, fatigue or dizziness, stop viewing the 3D projection and rest.
- ❖ Do not use the 3D glasses for any other purpose than for watching 3D projection. Wearing the 3D glasses for any other purpose (as general spectacles, sunglasses, protective goggles, etc.) may be physically harmful to you and may weaken your eyesight.
- ❖ Viewing in 3D projection may cause disorientation for some viewers. Accordingly, DO NOT place your 3D PROJECTOR near open stairwells, cables, balconies, or other objects that can be tripped over, run into, knocked down, broken or fallen over.

Eye Safety Warnings



- ■ Avoid staring/facing directly into the projector beam at all times. Keep your back to the beam as much as possible.
- ■ When projector is used in a classroom, adequately supervise students when they are asked to point out something on the screen.
- ■ In order to minimize the lamp power, use room blinds to reduce ambient light levels.

Introduction

Package Overview

Unpack and inspect the box contents to ensure all parts listed below are in the box. If something is missing, please contact Optoma customer service.

Standard Accessories

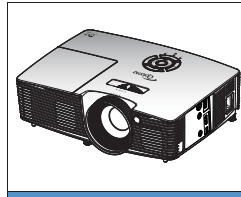

Projector

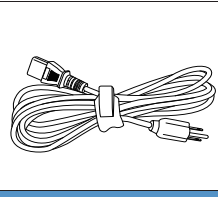

Power Lead

- CD User Manual
- Warranty Card
- Quick Start Card
- WEEE Card (for EMEA only)

Documentation

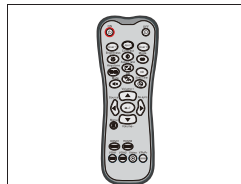

Remote

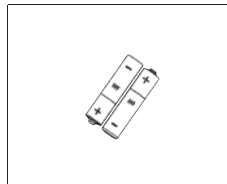

2 × AAA Batteries



❖ Optional accessories vary depending on model, specification and region.

Optional Accessories

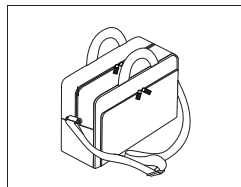

Carry Bag

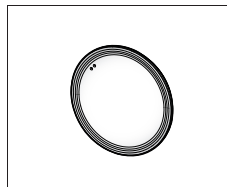

Lens Cap

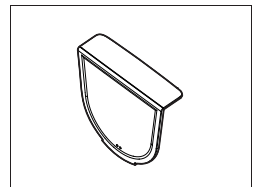

Lens Cap

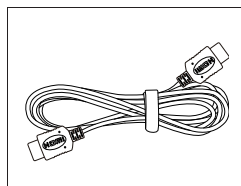

HDMI Cable

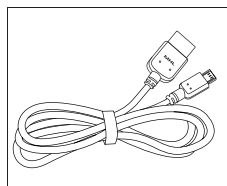

MHL Cable

Introduction

Product Overview

Main Unit

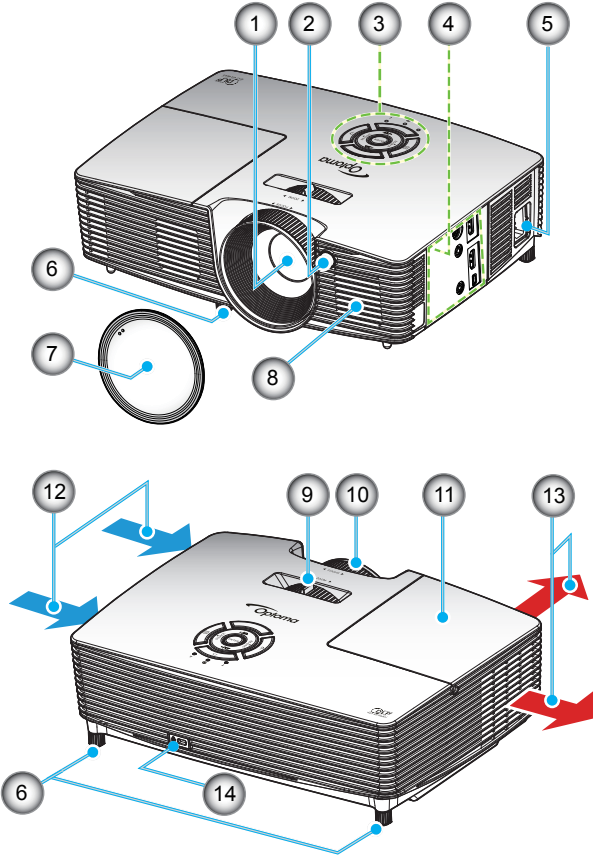

- ❖ Do not block projector in/out air vents.
- ❖ (*) Optional accessory.

- | | |
|-------------------------------|---------------------------|
| 1. Lens | 8. Speaker |
| 2. IR Receiver | 9. Zoom Lever |
| 3. Keypad | 10. Focus Ring |
| 4. Input / Output Connections | 11. Lamp Cover |
| 5. Power Socket | 12. Ventilation (inlet) |
| 6. Tilt-Adjustment Feet | 13. Ventilation (outlet) |
| 7. Lens Cap (*) | 14. Kensington™ Lock Port |

Keypad

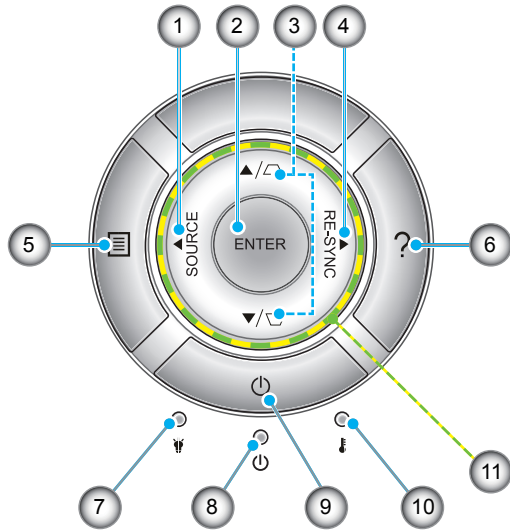

1. Source
2. Enter
3. Keystone Correction
4. Re-Sync
5. Menu
6. Help
7. Lamp LED
8. On/Standby LED
9. Power
10. Temp LED
11. Four Directional Select Keys

Introduction

Input/Output Connections

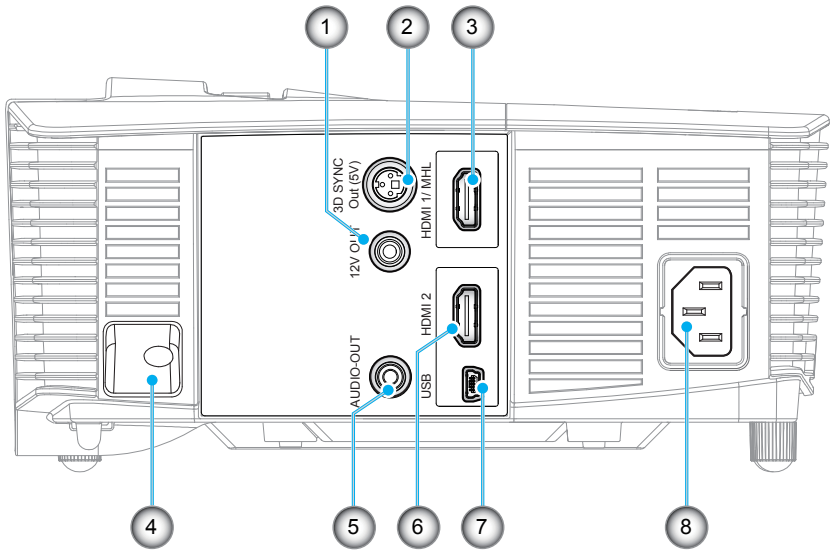

1. 12V Trigger Relay (12V, 250mA, 3.5mm mini jack)
2. 3D Sync Out (5V) connector
3. HDMI 1/ MHL connector
4. Security Bar
5. Audio Out connector (3.5mm mini jack)
6. HDMI 2 connector
7. USB-B mini connector (Firmware upgrade)
8. Power Socket



- ❖ Remote mouse requires special remote.

Remote Control



❖ Some keys may have no function for models which do not support these features.

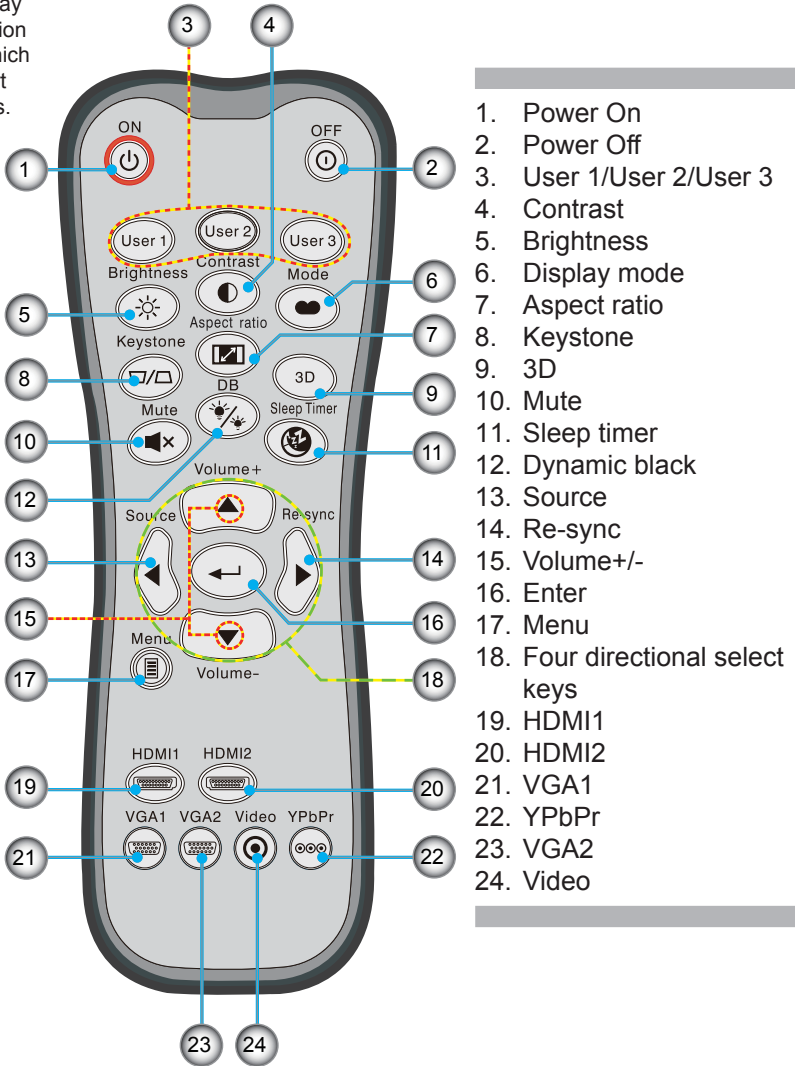

Installation

Connecting to the Projector

Connecting a Computer/Notebook

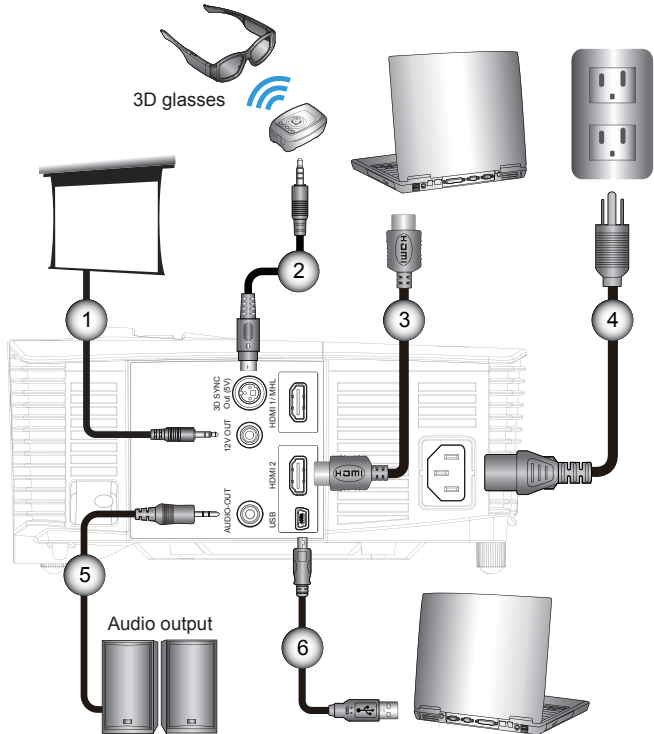

- ❖ Due to the difference in applications for each country, some regions may have different accessories.
- ❖ (*) Optional accessory

- | | |
|--------|-------------------|
| 1..... | *12V DC plug |
| 2..... | *3D emitter cable |
| 3..... | *HDMI cable |
| 4..... | Power cord |
| 5..... | *Audio out cable |
| 6..... | *USB cable |

Installation

Connecting a Video source

DVD player, Blu-ray player, Set-top box,
HDTV receiver, Games console

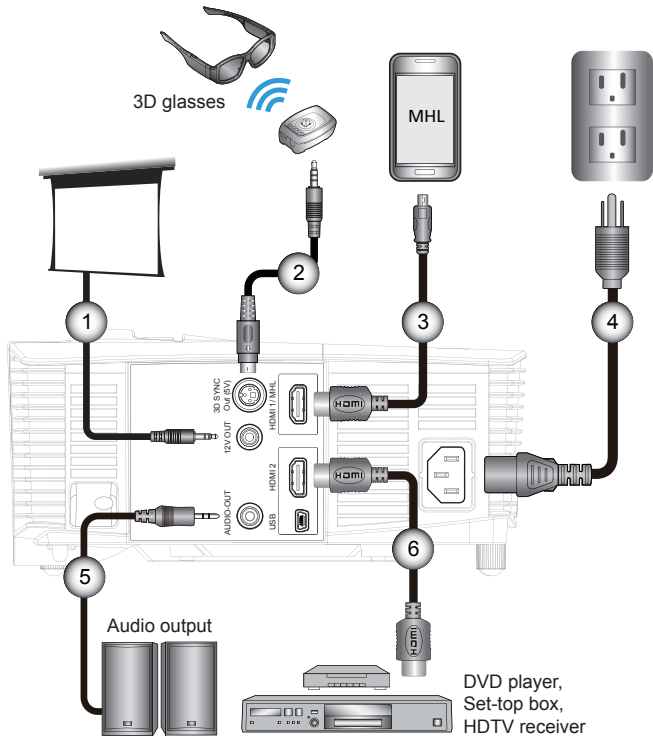

- ❖ Due to the difference in applications for each country, some regions may have different accessories.
- ❖ (*) Optional accessory

1.....	*12V DC plug
2.....	*3D emitter cable
3.....	*MHL cable (MicroUSB to HDMI)
4.....Power cord
5.....	*Audio out cable
6.....	*HDMI cable



- ❖ The 3D video source device must be powered on before the 3D projector.

Connect to 3D Video Devices

Once you have connected your devices together with HDMI cables, as shown in the diagram, you are ready to begin. Power ON your 3D video source and your 3D projector.

PlayStation® 3 Games

- Make sure that you have updated your console to the latest software version.
- Go to the “Settings menu -> Display settings -> Video output -> HDMI”. Select “Automatic” and follow the on-screen instructions.
- Insert your 3D game disc. Alternatively you can download games (and 3D updates) via the PlayStation® network.
- Launch the game. In the in-game menu, select “Play in 3D”.

Blu-ray 3D™ Player

- Make sure that your player can support 3D Blu-ray™ disc and that 3D output is enabled.
- Insert the 3D Blu-ray™ disc into the player, press “Play”.

3D TV (e.g. SKY 3D, DirectTV)

- Contact your TV service provider to enable any 3D channels on your channel package.
- Once enabled, switch to the 3D channel.
- You should see two images side-by-side.
- Switch to the “SBS Mode” of the 3D projector. The option is located in the “Display” section of the projector OSD menu.

3D Device (e.g. 3D DV/DC) with 2D 1080i side by side signal output

- Connect your 3D device and switch to out 3D content with 2D side-by-side output to 3D Projector.
 - You should see two images side-by-side.
- Switch to the “SBS Mode” of the 3D projector. The option is located in the “Display” section of the projector OSD menu.

If watching 3D content from an HDMI 1.4a source (e.g. 3D Blu-ray) your 3D glasses should always be in sync. If watching 3D content from an HDMI 1.3 source (e.g. 3D broadcast using SBS mode) it may be necessary to use the projector’s 3D Sync-Invert option to optimize your 3D experience. The option is located in the “Display ->3D” section of the projector OSD menu.



- ❖ If input video is normal 2D, please press “3D Format” and switch to “Auto”.
- ❖ If “SBS Mode” is active, 2D video content will not display correctly.

Installation

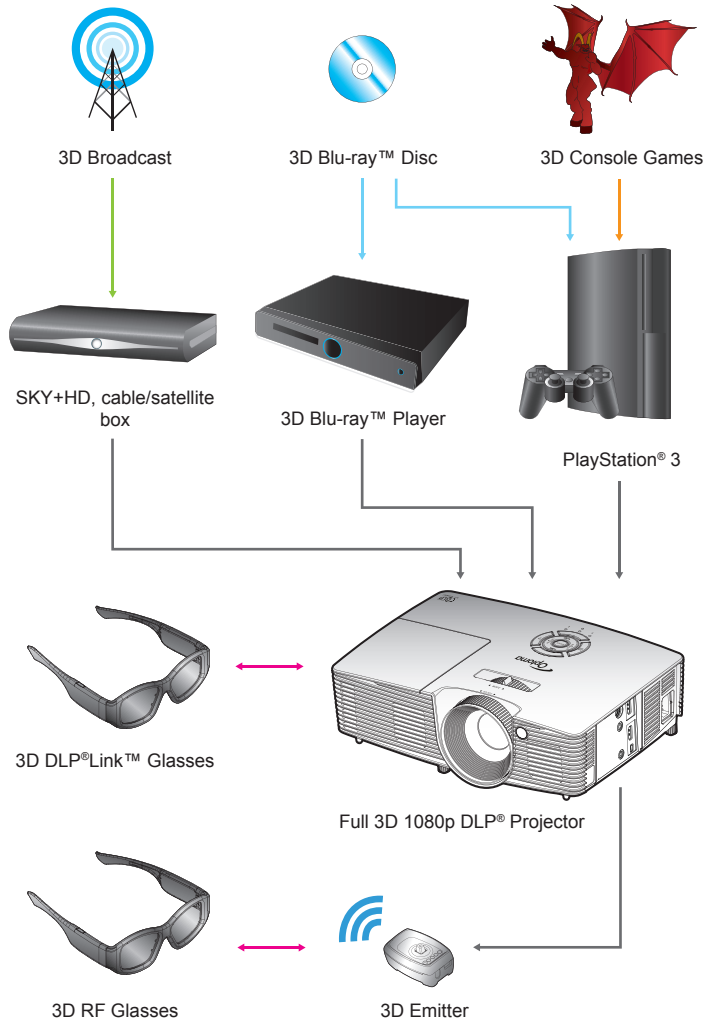



❖ For more detailed information, please refer to 3D glasses user's guide.

Using the 3D glasses

1. To turn ON 3D glasses.
2. Verify that 3D content is being sent to the projector and signal is compatible with projector specifications.
3. Turn on the "3D Mode" (Off/DLP-Link/VESA 3D - depending on which type of glasses you are using) of the 3D projector. The option is located in the "Display" section of the projector OSD menu.
4. Turn on 3D glasses and verify image appears in 3D without eyestrain.
5. If the image does not appear in 3D, please check 3D device set up correctly to send out 3D image or not. Or "SBS Mode" should turn on when input signal is 2D 1080i side-by-side and repeat previous steps 1 ~ 4.
6. It may be necessary to use projector's "3D Sync-Invert" option to optimize your 3D experience. The option is located in the "Display" section of the projector OSD menu.
7. To turn OFF 3D glasses: Press the "Power" button and hold until the LED switches off.
8. For more detailed information, please refer to the 3D glasses user's guide, or manufacturer's Website.

Installation

Powering On/Off the Projector

Powering On the Projector

1. Remove the lens cap. ❶
2. Securely connect the power cord and signal cable. When connected, the On/Standby LED will turn Amber.
3. Turn on the lamp by pressing “⏻” button either on the top of the projector or on the remote. The On/Standby LED will now turn Green. ❷

The startup screen will display in approximately 10 seconds. The first time you use the projector, you will be asked to select the preferred language and power saving mode.

4. Turn on and connect the source that you want to display on the screen (computer, notebook, video player, etc). The projector will detect the source automatically. If not, push menu button and go to “OPTIONS”.
Make sure that the “Source Lock” has been set to “Off”.

- ❖ If you connect multiple sources at the same time, press the “SOURCE” button on the Keypad or direct source keys on the remote control to switch between inputs.



- ❖ Turn on the projector first and then select the signal sources.
- ❖ (*) Optional accessory

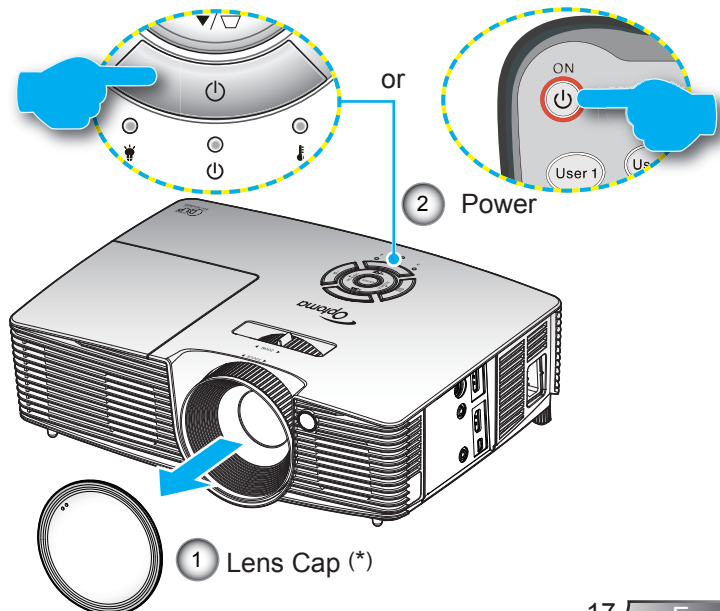

Powering Off the Projector

1. Press the “⏻” button on the remote control or “⏻” on the Keypad to turn off the projector. The following message will be displayed on the screen.

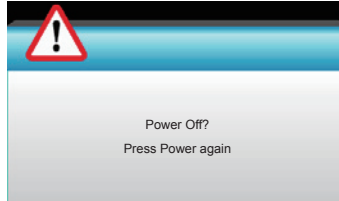

- Press the “⏻” button again to confirm otherwise the message will disappear after 15 seconds. When you press the “⏻” button for the second time, the projector will display countdown timer and will shut down.
2. The cooling fans continue to operate for about 10 seconds for cooling cycle and the On/Standby LED will Flash Green. When the On/Standby LED lights solid Amber, the projector has entered standby mode.
If you wish to turn the projector back on, you must wait until the projector has completed the cooling cycle and has entered standby mode. Once in standby mode, simply press “⏻” button to restart the projector.
 3. Disconnect the power cord from the electrical outlet and the projector.
 4. Do not turn on the projector immediately following a power off procedure.



- ❖ Contact the nearest service center if the projector displays these symptoms. See pages 65-66 for more information.

Warning Indicator

When the warning indicators (see below) come on, the projector will automatically shutdown:

- ❖ “LAMP” LED indicator is lit red and if “On/Standby” indicator flashes amber.
- ❖ “TEMP” LED indicator is lit red and if “On/Standby” indicator flashes amber. This indicates the projector has overheated. Under normal conditions, the projector can be switched back on.
- ❖ “TEMP” LED indicator flashes red and if “On/Standby” indicator flashes amber.

Unplug the power cord from the projector, wait for 30 seconds and try again. If the warning indicator light up again, please contact your nearest service center for assistance.

Adjusting the Projected Image

Adjusting the Projector's Height

The projector is equipped with elevator feet for adjusting the image height.

1. Locate the adjustable foot you wish to modify on the underside of the projector.
2. Rotate the adjustable ring clockwise to raise the projector or counter clockwise to lower it. Repeat with the remaining feet as needed.

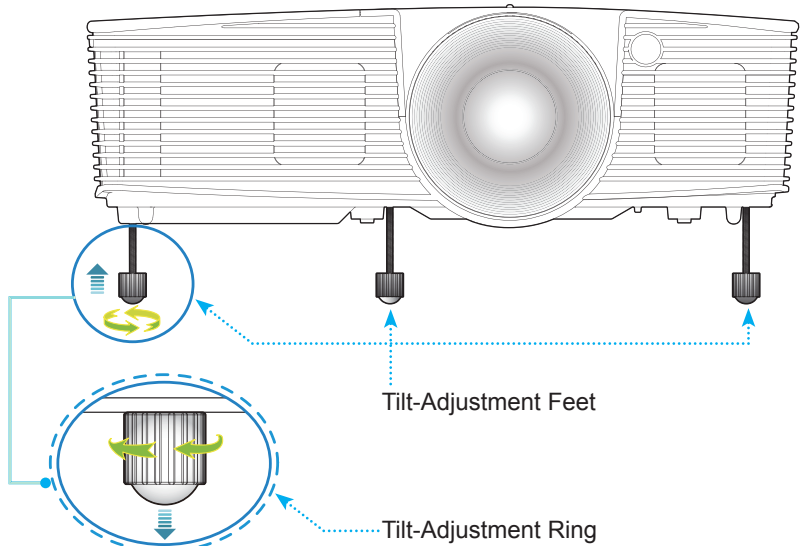

Installation

Adjusting the Projector's Zoom / Focus

You may turn the zoom ring to zoom in or out. To focus the image, rotate the focus ring until the image is clear.

- ▶ Standard throw series: The projector will focus at distances from 3.53 to 33.00 feet (1.08 to 10.06 meters).
- ▶ Short throw series: The projector will focus at distances from 1.09 to 11.13 feet (0.33 to 3.39 meters).

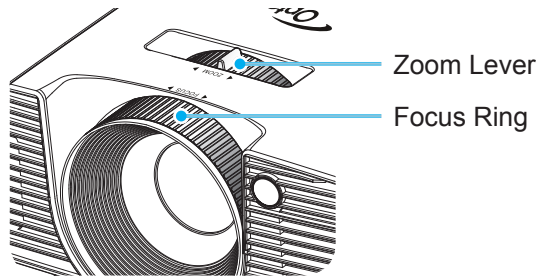

Adjusting Projection Image Size

- ▶ Projection Image Size from 30.0" to 307.0" (0.76 to 7.80 meters).

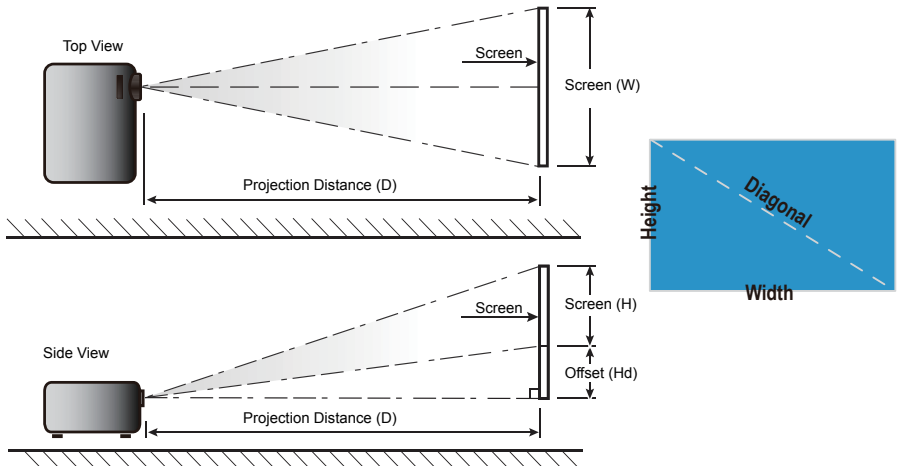

Installation

Standard throw

Diagonal length (inch) size of 16:9 Screen	Screen Size W x H				Projection Distance (D)				Offset (Hd)	
	(m)		(inch)		(m)		(feet)			
	Width	Height	Width	Height	wide	tele	wide	tele	(m)	(inch)
30.0	0.66	0.37	26.15	14.71	0.98	1.08	3.22	3.53	0.06	2.35
40.0	0.89	0.50	34.86	19.61	1.31	1.43	4.30	4.71	0.08	3.14
60.0	1.33	0.75	52.29	29.42	1.97	2.15	6.45	7.06	0.12	4.71
70.0	1.55	0.87	61.01	34.32	2.29	2.51	7.52	8.24	0.14	5.49
80.0	1.77	1.00	69.73	39.22	2.62	2.87	8.60	9.41	0.16	6.28
90.0	1.99	1.12	78.44	44.12	2.95	3.23	9.67	10.59	0.18	7.06
100.0	2.21	1.25	87.16	49.03	3.28	3.59	10.75	11.77	0.20	7.84
120.0	2.66	1.49	104.59	58.83	3.93	4.30	12.90	14.12	0.24	9.41
150.0	3.32	1.87	130.74	73.54	4.91	5.38	16.12	17.65	0.30	11.77
180.0	3.98	2.24	156.88	88.25	5.90	6.46	19.36	21.18	0.36	14.12
250.0	5.53	3.11	217.89	122.57	8.19	8.97	26.87	29.42	0.50	19.61
300.0	6.64	3.74	261.47	147.08	9.83	10.76	32.25	35.30	0.60	23.53
307.0	6.80	3.82	267.57	150.51	10.06	11.01	33.00	36.12	0.61	24.08

❖ This table is for user's reference only.

Short throw

Diagonal length (inch) size of 16:9 Screen	Screen Size W x H				Projection Distance (D)				Offset (Hd)	
	(m)		(inch)		(m)		(feet)			
	Width	Height	Width	Height	wide	tele	wide	tele	(m)	(inch)
30.0	0.66	0.37	26.15	14.71	0.33	0.33	1.09	1.09	0.06	2.35
40.0	0.89	0.50	34.86	19.61	0.44	0.44	1.45	1.45	0.08	3.14
60.0	1.33	0.75	52.29	29.42	0.66	0.66	2.17	2.17	0.12	4.71
70.0	1.55	0.87	61.01	34.32	0.77	0.77	2.54	2.54	0.14	5.49
80.0	1.77	1.00	69.73	39.22	0.88	0.88	2.90	2.90	0.16	6.28
90.0	1.99	1.12	78.44	44.12	0.99	0.99	3.26	3.26	0.18	7.06
100.0	2.21	1.25	87.16	49.03	1.10	1.10	3.62	3.62	0.20	7.84
120.0	2.66	1.49	104.59	58.83	1.33	1.33	4.35	4.35	0.24	9.41
150.0	3.32	1.87	130.74	73.54	1.66	1.66	5.44	5.44	0.30	11.77
180.0	3.98	2.24	156.88	88.25	1.99	1.99	6.52	6.52	0.36	14.12
250.0	5.53	3.11	217.89	122.57	2.76	2.76	9.06	9.06	0.50	19.61
300.0	6.64	3.74	261.47	147.08	3.31	3.31	10.87	10.87	0.60	23.53
307.0	6.80	3.82	267.57	150.51	3.39	3.39	11.13	11.13	0.61	24.08

❖ This table is for user's reference only.

Keypad & Remote Control

Keypad

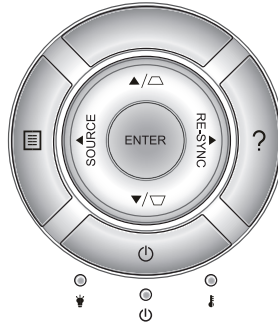

Using the Keypad

POWER		Refer to the “Power On/Off the Projector” section on pages 17-18.
RE-SYNC	RE-SYNC	Automatically synchronize the projector to the input source.
ENTER	ENTER	Confirm your item selection.
SOURCE	SOURCE	Press “SOURCE” to select an input signal.
Menu		Press “Menu” to launch the on-screen display (OSD) menu. To exit OSD, Press “Menu” again.
Help		Help Menu (only available when OSD menu is not shown).
Four Directional Select Keys		Use to select items or make adjustments to your selection.
Keystone		Use to adjust image distortion caused by tilting the projector. (± 40 degrees)
Lamp LED		Indicate the projector’s lamp status.
Temp LED		Indicate the projector’s temperature status.
On/Standby LED		Indicate the projector’s status.

User Controls

Remote Control

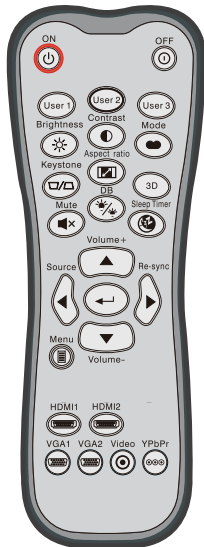

Using the Remote Control

Power On		Turn on the projector.
Power Off		Turn off the projector.
User1/User2/ User3	User 1 User 2 User 3	User defined keys. Please see page 52 to setup.
Brightness		Adjust the brightness of the image.
Contrast		Control the degree of difference between the lightest and darkest parts of the picture.
Mode		Select a display mode for optimised settings for different applications. (refer to page 34)
Keystone		Adjust image distortion caused by tilting the projector.
Aspect ratio		Press to change aspect ratio of a displayed image.
3D	3D	Manually select a 3D mode that matches your 3D content.
Mute		Momentarily turns off / on the audio.
DB (Dynamic Black)		Automatically adjusts the picture brightness to give optimum contrast performance.
Sleep timer		Sets the countdown timer interval.
Volume+ / Volume-		Adjust to increase / decrease the volume.
Source		Press "Source" to select an input signal.
Re-sync		Automatically synchronizes the projector to the input source.

User Controls







Using the Remote Control

Enter		Confirm your item selection.
Menu		Display or exit the on-screen display menus for projector.
HDMI1		Press "HDMI1" to choose source from HDMI 1/ MHL connector.
HDMI2		Press "HDMI2" to choose source from HDMI 2 connector.
VGA1		No function.
VGA2		No function.
Video		No function.
YPbPr		No function.
Four directional select keys		Use ▲ ▼ ◀ ▶ to select items or make adjustments to your selection.

User Controls



MHL (Mobile High-Definition Link) Control

Mode		<p>Press “Mode” button for more than one second to activate the MHL remote control mode.</p>  <p>To exit, press the “Mode” button again.</p>
Select		<p>To select the file.</p>
Menu		<p>Press to launch the root menu.</p>
Four directional select keys		<p>Use up, down, left, right buttons to select items or make adjustments to your selection.</p>

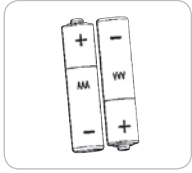

Installing Batteries

Two size AAA batteries are supplied for Remote Control.

Replace only with the same or equivalent type recommended by the manufacturer.



CAUTION

Improper use of batteries can result in chemical leakage or explosion. Be sure to follow the instructions below.

Do not mix batteries of different types. Different types of batteries have different characteristics.

Do not mix old and new batteries. Mixing old and new batteries can shorten the life of new batteries or cause chemical leakage in old batteries.

Remove batteries as soon as they are worn out. Chemicals that leak from batteries that come in contact with skin can cause a rash. If you find any chemical leakage, wipe thoroughly with a cloth.

The batteries supplied with this product may have a shorter life expectancy due to storage conditions.

If you will not be using the remote control unit for an extended period of time, remove batteries from it.

When you dispose of the battery, you must obey the law in the relative area or country.

User Controls

Using the HELP button

The HELP function ensures easy setup and operation.

- ▶ Press the “?” button on the Keypad to open the Help Menu.

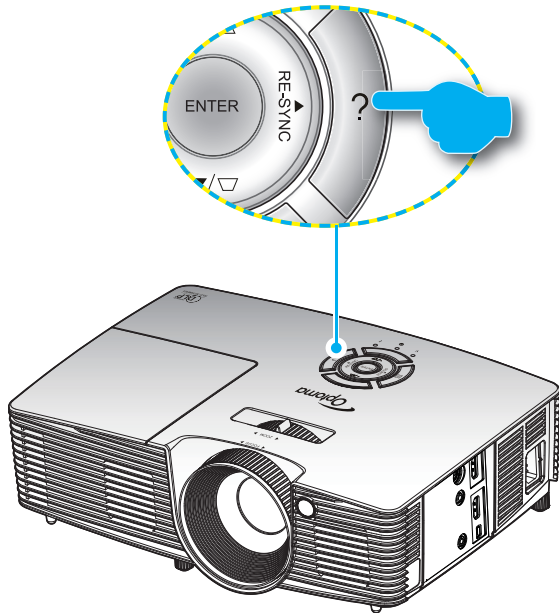

- ▶ Help menu button functions only when no input source is detected.



❖ Please refer to the “Troubleshooting” section on pages 54~56 for more details.

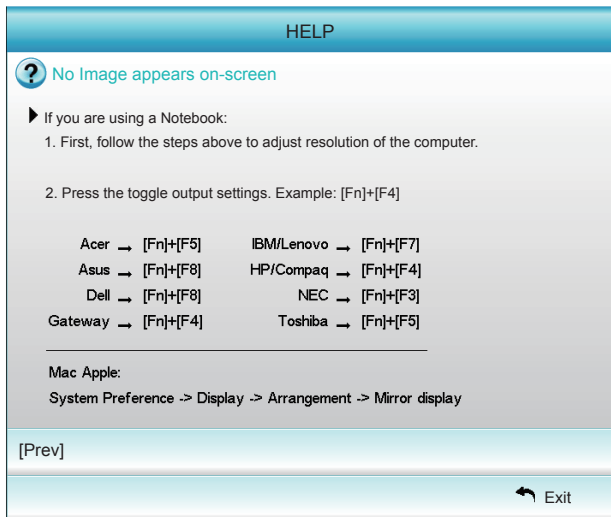
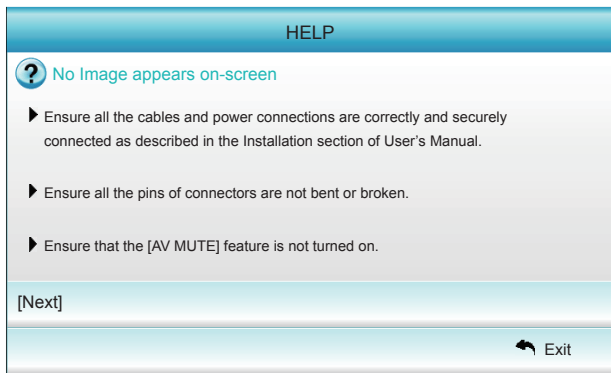
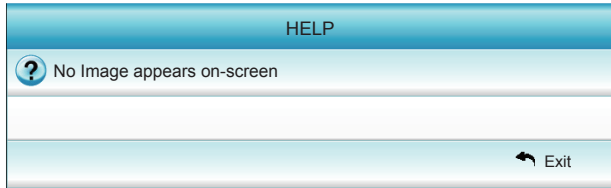

User Controls

- ▶ If input source is detected and help button is pressed, the following pages will appear to help diagnose any problems.

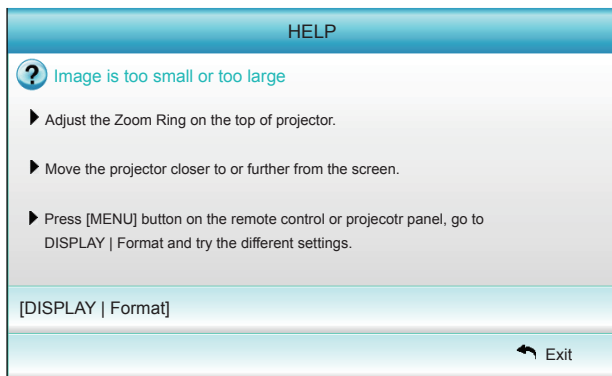
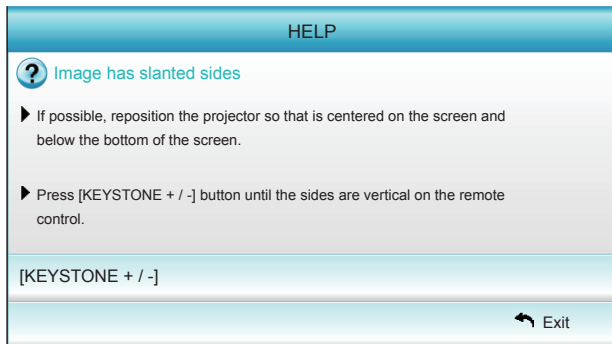
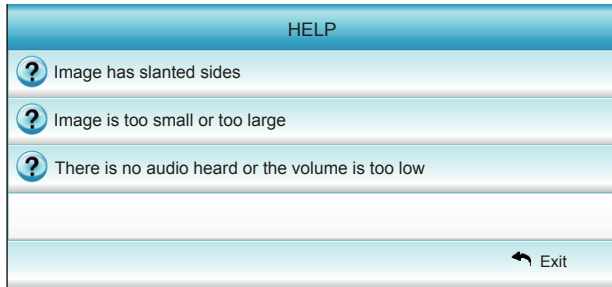

On-screen Display Menus

The Projector has multilingual On-screen Display menus that allow you to make image adjustments and change a variety of settings. The projector will automatically detect the source.

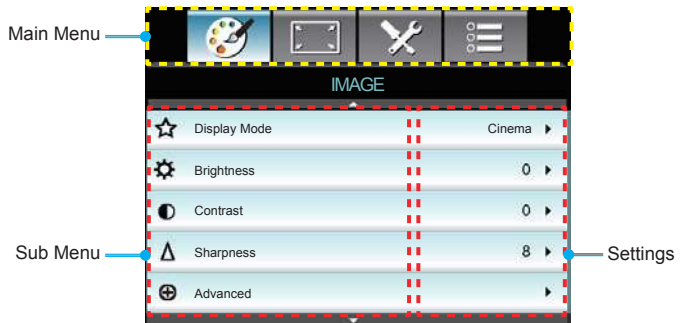

How to operate

1. To open the OSD menu, press “Menu” on the Remote Control or Keypad.
2. When OSD is displayed, use ◀▶ keys to select any item in the main menu. While making a selection on a particular page, press ▼ or “Enter” key to enter sub menu.
3. Use ▲▼ keys to select the desired item in the sub menu and then press ▶ or “Enter” key to view further settings. Adjust the settings by ◀▶ key.
4. Select the next item to be adjusted in the sub menu and adjust as described above.
5. Press “Enter” or “Menu” to confirm, and the screen will return to the main menu.
6. To exit, press “Menu” again. The OSD menu will close and the projector will automatically save the new settings.



User Controls

Menu Tree

Main Menu	Sub Menu	Settings		
Image	Display Mode	Cinema / Reference / Vivid / Bright / 3D / User / ISF Day / ISF Night / Game		
	Brightness	-50~50		
	Contrast	-50~50		
	^{#1} Saturation	-50~50		
	^{#2} Tint	-50~50		
	Sharpness	1~15		
	Advanced	Noise Reduction	0~10	
		Gamma	Film / Video / Graphics / Standard	
		BrilliantColor™	1~10	
		Dynamic Black	Off / On	
		Color Temp.	Warm / Standard / Cool / Cold	
		Color Settings	Red / Green / Blue / Cyan / Magenta / Yellow / White	Hue / Saturation / Gain
			Reset	Red / Green / Blue
			Exit	
			Color Space	Auto / RGB (0-255) / RGB (16-235) / Exit
Reset				
Exit				
Display	Format	4:3 / 16:9 / LBX / Native / Superwide		
	Edge Mask	0~5		
	Zoom	0~10		
	Image Shift	H	-100~100	
		V	-100~100	
	V Keystone	-40~40		
	3D	3D Mode	Off / DLP-Link / VESA 3D	
		3D Format	Auto / SBS / Top and Bottom / Frame Sequential	
		3D → 2D	3D / L / R	
		^{#3} 3D Sync. Invert	On / Off	
Exit				
Setup	Language	English / Deutsch / Français / Italiano / Español / Português / Svenska / Nederlands / Norsk/Dansk / Polski / Suomi / Русский / ελληνικά / Magyar / Čeština / العربية / 繁體中文 / 简体中文 / 日本語 / 한국어 / ไทย / Türkçe / Việt / Bahasa Indonesia / Română		
	Projection			
	Menu Location			
	Audio Settings	Internal Speaker	On / Off	
		Mute	On / Off	
Volume		0~10		
Exit				

User Controls

Main Menu	Sub Menu	Settings	
Setup	Security	Security	On / Off
		Security Timer	Month / Day / Hour
		Change Password	
		Exit	
	Advanced	Logo	Default / Neutral / User
		Logo Capture	
		Exit	
	Exit		
	Options	Input Source	HDMI1/MHL / HDMI2
		Source Lock	On / Off
High Altitude		On / Off	
Information Hide		On / Off	
Keypad Lock		On / Off	
Test Pattern		None / Grid / White Pattern	
IR Function		All / Front / Top / Off	
12V Trigger		Off / On / Auto 3D	
Background Color		Black / Red / Blue / Green / White	
Lamp Settings		Lamp Hours	
		Lamp Reminder	On / Off
		Lamp Mode	Bright / Eco / Dynamic
		Lamp Reset	Yes / No
		Exit	
HDMI Link Settings		HDMI Link	Off / On
		Inclusive of TV	Yes / No
		Power On Link	Mutual / PJ → Device / Device → PJ
		Power Off Link	Off / On
		Exit	
Remote Settings		USER1/USER2/ USER3	Color Settings /ColorTemp/Gamma/ HDMI Link/Test Pattern/AV Mute
	Exit		
	Advanced		
Advanced	Direct Power On	On / Off	
	Auto Power Off (min.)	0~180	
	Sleep Timer (min.)	0~990	
	Power Mode (Standby)	Active / Eco	
	Exit		
Reset	Current	Cancel / Yes	
	All	Cancel / Yes	
Exit			



- ❖ Please note that the on-screen display (OSD) menus vary according to the signal type selected and the projector model you are using.
- ❖ (#1, #2) "Saturation" and "Tint" options are available in HDMI YUV, not in HDMI RGB.
- ❖ (#3) "3D Sync Invert" is only available when 3D is enabled.

IMAGE

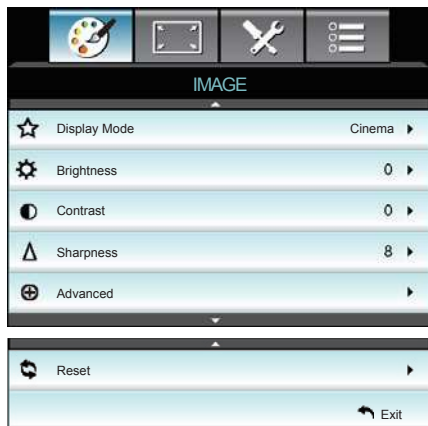

Display Mode

There are many factory presets optimized for various types of images.

- ▶ Cinema: For home theater.
- ▶ Reference: This mode is intended to reproduce, as close as possible, the image the way the movie director intended. Color, color temperature, brightness, contrast and gamma settings are all configured to standard reference levels.
- ▶ Vivid: Optimized to produce strikingly bright colorful images.
- ▶ Bright: Maximum brightness from PC input.
- ▶ 3D: Recommended setting for 3D mode enabled. Any further adjustments by the user in 3D will be saved in this mode for further use.
- ▶ User: User's settings.
- ▶ ISF Day: Optimize the image with the ISF Day mode to be perfectly calibrated and high picture quality.
- ▶ ISF Night: Optimize the image with the ISF Night mode to be perfectly calibrated and high picture quality.
- ▶ Game: For game content.

Brightness

Adjust the brightness of the image.

- ▶ Press the ◀ to darken image.
- ▶ Press the ▶ to lighten the image.



- ❖ "ISF Night" will not be shown when the ISF modes have not been calibrated.

Contrast

The contrast controls the degree of difference between the lightest and darkest parts of the picture.

- ▶ Press the ◀ to decrease the contrast.
- ▶ Press the ▶ to increase the contrast.

Sharpness

Adjust the sharpness of the image.

- ▶ Press the ◀ to decrease the sharpness.
- ▶ Press the ▶ to increase the sharpness.

Reset

Choose “Yes” to return the factory default settings for “IMAGE”.

IMAGE | Advanced

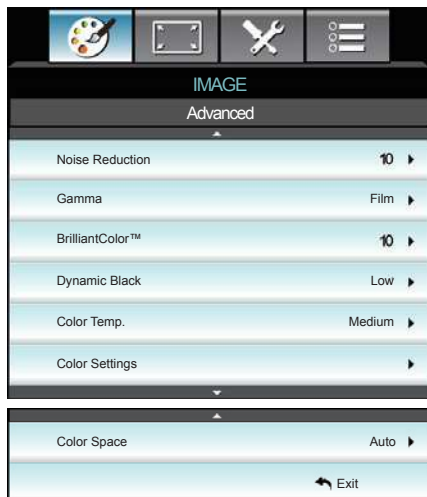

Noise Reduction

The Noise Reduction reduces the amount of visible noise inter-laced signals. The range is from “0” to “10”. (0: Off)

Gamma

This allows you to set up gamma curve type. After the initial setup and fine tuning is completed, utilize the Gamma Adjustment steps to optimize your image output.

- ▶ Film: for home theater.
- ▶ Video: for video or TV source.
- ▶ Graphics: for PC / Photo source.
- ▶ Standard: for standardized setting.

BrilliantColor™

This adjustable item utilizes a new color-processing algorithm and enhancements to enable higher brightness while providing true, more vibrant colors in picture. The range is from “1” to “10”. If you prefer a stronger enhanced image, adjust toward the maximum setting. For a smoother, more natural image, adjust toward the minimum setting.

Dynamic Black

Dynamic Black enables the projector to automatically optimize the the brightness of the display during dark/light movie scenes to be shown in incredible detail.

Color Temp.

Select a color temperature from Warm, Standard, Cool and Cold.

User Controls

Color Settings

Press ► into the next menu and then use ▲ or ▼ or ◀ or ▶ to select item.

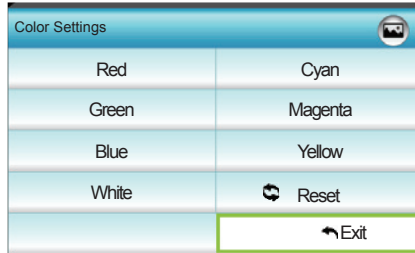

- ▶ Red/Green/Blue/Cyan/Magenta/Yellow: Use ◀ or ▶ to select Hue, Saturation and Gain Colors.

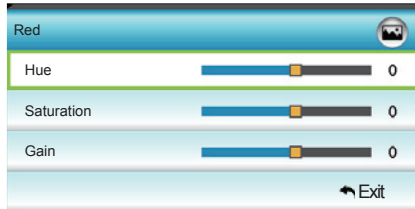

- ▶ White: Use ◀ or ▶ to select Red, Green and Blue Colors.

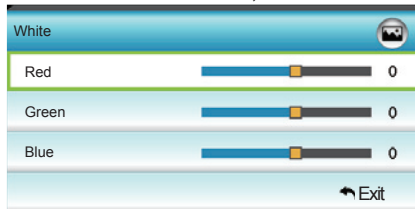

- ▶ Reset: Choose "Reset" to return the factory default settings for color adjustments.

Color Space

Select an appropriate color matrix type from Auto, RGB(0-255), RGB(16-235) or YUV.

DISPLAY



Format

Use this function to choose your desired aspect ratio.

- ▶ 4:3: This format is for 4x3 input sources.
- ▶ 16:9: This format is for 16x9 input sources, like HDTV and DVD enhanced for Widescreen TV.
- ▶ LBX: This format is for non-16x9, letterbox source and for users who use external anamorphic lens to display 2.35:1 aspect ratio using full resolution.
- ▶ Native: This format displays the original image without scaling.
- ▶ Superwide: This mode scales 2.35:1 sources to fill 100% of image height to remove black bars. (the left and right side of image will be cropped).

Detail informations about LBX mode:

1. Some Letter-Box Format DVDs are not enhanced for 16x9 TVs. In this situation, the image will not look right when displayed in 16:9 mode. In this situation, please try to using the 4:3 mode to view the DVD. If the content is not 4:3, there will be black bars around the image in 16:9 display. For this type of content, you can use LBX mode to fill the image on the 16:9 display.
2. If you use an external anamorphic lens, this LBX mode also allows you to watch a 2.35:1 content (include Anamorphic DVD and HDTV film source) that support anamorphic wide is enhanced for 16x9 Display in a wide 2.35:1 image. In this case, there are no black bars. Lamp power and vertical resolution are fully utilized.

User Controls

16:9 Screen	480i/p	576i/p	1080i/p	720p	PC
4:3	1440 x 1080 center				
16:9	1920 x 1080 center				
LBX	1920 x 1440 center, then get the central 1920 x 1080 image to display				
Native	No resize image, 1:1 mapping and centered. This format shows original image without scaling.				
Superwide	Scale to 2534 x 1426 (132% Enlarge), then get the central 1920x1080 image to display.				



- ❖ Each I/O has different setting of "Edge Mask".
- ❖ "Edge Mask" and "Zoom" can't work at same time.

Edge Mask

Edge mask the image to remove video encoding noise on the edge of video source.

Zoom

- ▶ Press the ◀ to reduce the size of an image.
- ▶ Press the ▶ to magnify an image on the projection screen.

Image Shift

Press ▶ into the next menu as below and then use ▲ or ▼ or ◀ or ▶ to select item.

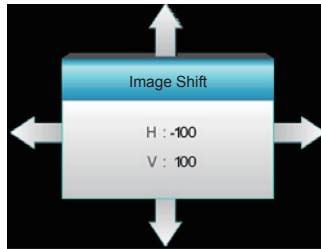

- ▶ H: Press the ◀ ▶ to shift the projected image position horizontally.
- ▶ V: Press the ▲ ▼ to shift the projected image position vertically.

V Keystone

Press the ◀ or ▶ to adjust image distortion vertically and make a squarer image.

DISPLAY | 3D



- ❖ 3D Format is only supported on 3D Timing on page 63.
- ❖ “3D Format” is only supported on non-HDMI 1.4a 3D timing.

3D Mode

- ▶ Off: Select “Off” to turn off 3D mode.
- ▶ DLP-Link: Select “DLP-Link” to use optimized settings for DLP Link 3D Glasses. (refer to page 16).
- ▶ VESA 3D: Select “VESA 3D” to use optimized setting for VESA 3D Glasses. (refer to page 16).

3D Format

- ▶ Auto: When a 3D identification signal is detected, the 3D format is selected automatically.
- ▶ SBS: Display 3D signal in “Side-by-Side” format.
- ▶ Top and Bottom: Display 3D signal in “Top and Bottom” format.
- ▶ Frame Sequential: Display 3D signal in “Frame Sequential” format.

3D -> 2D

- ▶ 3D: Display 3D signal.
- ▶ L (Left): Display the left frame of 3D content.
- ▶ R (Right): Display the right frame of 3D content.

3D Sync. Invert

- ▶ Press the “On” to invert left and right frame contents.
- ▶ Press the “Off” for default frame contents.

User Controls

SETUP



Language

Choose the multilingual OSD menu. Press ► into the sub menu and then use the ▲ or ▼ or ◀ or ▶ key to select your preferred language. Press “Enter” to finalize the selection.

Language			
English	Nederlands	Čeština	Türkçe
Deutsch	Norsk/Dansk	عربي	فارسی
Français	Polski	繁體中文	Vietnamese
Italiano	Русский	简体中文	Romanian
Español	Suomi	日本語	Indonesian
Portugués	ελληνικά	한국어	
Svenska	Magyar	ไทย	Exit

User Controls



- ❖ Rear-Desktop and Rear-Ceiling are to be used with a translucent screen.

Projection



Front-Projection

This is the default selection. The image is projected straight on the screen.



Rear-Desktop

When selected, the image will appear reversed.



Front-Ceiling

When selected, the image will turn upside down.



Rear-Ceiling

When selected, the image will appear reversed in upside down position

Menu Location

Choose the menu location on the display screen.

SETUP | Audio Settings



- ❖ "Mute" function affects both internal and external speaker volume.

Internal Speaker

Choose the "On" or "Off" to turn on or off the internal speaker.

Mute

- ▶ Choose the "On" to turn mute on.
- ▶ Choose the "Off" to turn mute off.

Volume

- ▶ Press the ◀ to decrease the volume.
- ▶ Press the ▶ to increase the volume.

SETUP | Security



Security

- ▶ On: Choose "On" to use security verification when the turning on the projector.
- ▶ Off: Choose "Off" to be able to switch on the projector without password verification.

Security Timer

Can be select the time (Month/Day/Hour) function to set the number of hours the projector can be used. Once this time has elapsed you will be requested to enter your password again.

Change Password



- ❖ Pass-code default value is "1234" (first time).

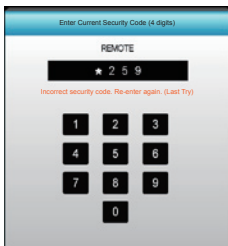

- ▶ First time:
 1. Press "↵" to set the password.
 2. The password has to be 4 digits.
 3. Use number button on the remote to enter your new password and then press "↵" key to confirm your password.
- ▶ Change Password:

(If your remote does not have a number keypad, please use the up/down arrows to change each digit of the password, then press enter to confirm)

 1. Press "↵" to input old password.
 2. Use number button to enter current password and then press "↵" to confirm.
 3. Enter new password (4 digits in length) using the number buttons on the remote, then press "↵" to confirm.
 4. Enter new password again and press "↵" to confirm.
 - ▶ If the incorrect password is entered 3 times, the projector will automatically shut down.
 - ▶ If you have forgotten your password, please contact your local office for support.

SETUP | Advanced



- ❖ For a successful logo capture, ensure that the on-screen image does not exceed the projector native resolution. (1080p: 1920 x 1080).

Logo

Use this function to set the desired startup screen. If changes are made they will take effect the next time the projector is powered on.

- ▶ Default: The default startup screen.
- ▶ Neutral: Logo is not displayed on startup screen.
- ▶ User: Use stored picture from “Logo Capture” function.

Logo Capture

Press ▶ to capture an image of the picture currently displayed on screen.

OPTIONS

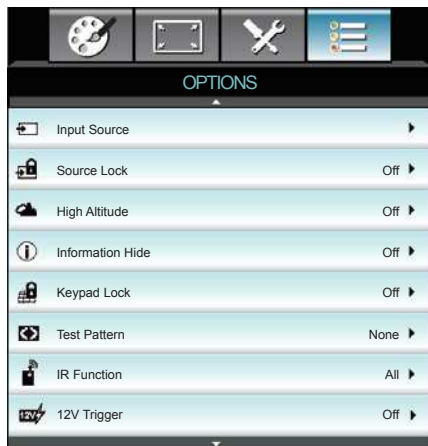

Input Source

Use this option to enable/disable input sources. Press ► to enter the sub menu and select which sources you require. Press “Enter” to finalize the selection. The projector will only search for inputs that are enabled.

Source Lock

- ▶ On: The projector will only search current input connection.
- ▶ Off: The projector will search for other signals if the current input signal is lost.

High Altitude

When “On” is selected, the fans will spin faster. This feature is useful in high altitude areas where the air is thin.

Information Hide

- ▶ On: Choose “On” to hide the info message.
- ▶ Off: Choose “Off” to show the “searching” message.

Keypad Lock

When the keypad lock function is “On”, the Keypad will be locked however, the projector can be operated by the remote control. By selecting “Off”, you will be able to reuse the Keypad.

Test Pattern

Display a test pattern. There are Grid, White Pattern and None.

IR Function



- ❖ “Front” and “Top” can’t be selected under standby mode.



- ❖ 12V Trigger A Relay Connector support 12V, 250mA. 3.5mm Mini Jack.

- ▶ All: Choose “All”, the projector can be operated by the remote control from front or top IR receiver.
- ▶ Front: Choose “Front”, the projector can be operated by the remote control from front IR receiver.
- ▶ Top: Choose “Top”, the projector can be operated by the remote control from top IR receiver.
- ▶ Off: Choose “Off”, the projector can’t be operated by the remote control from front or top IR receiver. By selecting “Off”, you will be able to use the Keypad keys.

12V Trigger

- ▶ Off: Choose “Off” to disable the trigger.
- ▶ On: Choose “On” to enable the trigger.
- ▶ Auto 3D: When “Auto 3D” is enabled, the projector will automatically detect when a 3D image is shown and will activate the trigger on this port.

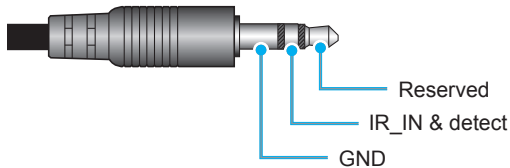

OPTIONS

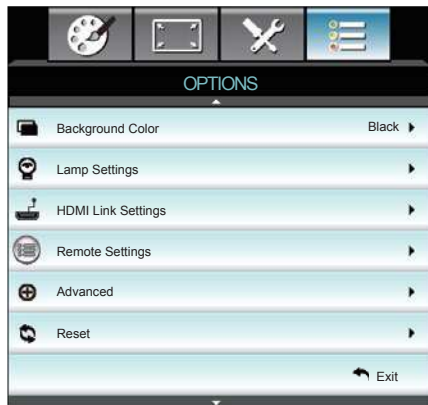

Background Color

Use this feature to display a “Black”, “Red”, “Blue”, “Green” or “White”, screen when no signal is available.

Reset

- ▶ Current: Choose “Yes” to return the display parameters on this menu to the factory default settings.
- ▶ All: Choose “Yes” to return the display parameters on all menus to the factory default settings.

OPTIONS | Lamp Settings



- ❖ When ambient temperature is over 40°C in operating, the projector will switch to Eco automatically.
- ❖ "Lamp Mode" can be independently set for 2D and 3D.

Lamp Hours

Display the projection time.

Lamp Reminder

Choose this function to show or to hide the warning message when the changing lamp message is displayed.

The message will appear 30 hours before suggested replacement of lamp.

Lamp Mode

- ▶ Bright: Choose "Bright" to increase the brightness.
- ▶ Eco.: Choose "Eco." to dim the projector lamp which will lower power consumption and extend the lamp life.
- ▶ Dynamic: Choose "Dynamic" to dim the lamp power which will be based on brightness level of the content and adjust lamp power consumption between 100% and 30% dynamically. The lamp life will be extended.

Lamp Reset

Reset the lamp hour counter after replacing the lamp.

OPTIONS | HDMI Link Settings



OPTIONS	
Advanced	
HDMI Link	Off
Inclusive of TV	No
Power On Link	Mutual
Power Off Link	Off
↶ Exit	



- ❖ When standby mode is <math>< 0.5W</math> HDMI Link feature will not work.

Using HDMI Link

- When you connect HDMI CEC-compatible devices to the projector with HDMI cables, you can control them on same Power On or Power Off status using the HDMI Link control feature on the projector's OSD.
- This lets one device or multiple devices in a group Power On or Power Off via HDMI Link Feature.
- In a typical configuration, your DVD player may be connected to the projector through an amplifier or home theater system.

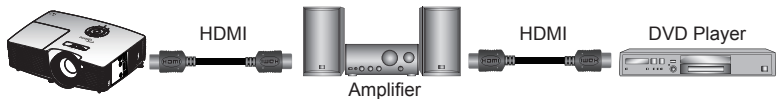

- ❖ Some HDMI Link functions may not operate, depending on the connected product's design and compliance with the HDMI CEC standard.

HDMI Link

Enable/Disable the HDMI Link function. The Inclusive TV, Power on Link, and Power off Link options will only be available if the setting is set to On.

Inclusive of TV

If the setting is set to "Yes", both TV and projector will be automatically turned off at the same time. To prevent both devices to be turned off at the same time, set the setting to "No".

Power On Link

CEC power on command.

- ▶ Mutual: Both projector and CEC device will be turned on simultaneously.
- ▶ PJ -> Device: The CEC device will be turned on only after the projector is switched on.
- ▶ Device -> PJ: The projector will be switched on only after the CEC device is turned on.

Power Off Link

If the setting is set to “On”, both HDMI Link and projector will be automatically turned off at the same time. Set to “Off”, both HDMI Link and projector will be not automatically turned off at the same time.

OPTIONS | Remote Settings



USER 1

The default value is Color Settings.

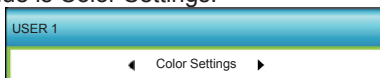

Press ► into the next menu and then use ◀ or ▶ to select “Color Settings”, “ColorTemp”, “Gamma”, “HDMI Link”, “Test Pattern” or “AV Mute” item.

USER 2

The default value is Color Temp.

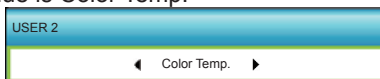

Press ► into the next menu and then use ◀ or ▶ to select “Color Settings”, “ColorTemp”, “Gamma”, “HDMI Link”, “Test Pattern” or “AV Mute” item.

USER 3

The default value is Gamma.

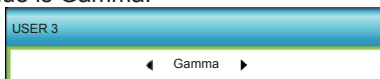

Press ► into the next menu and then use ◀ or ▶ to select “Color Settings”, “ColorTemp”, “Gamma”, “HDMI Link”, “Test Pattern” or “AV Mute” item.

OPTIONS | Advanced



Direct Power On

Choose “On” to activate Direct Power mode. The projector will automatically power on when AC power is supplied, without pressing the “” key on the projector Keypad or on the remote control.

Auto Power Off (min)

Sets the countdown timer interval. The countdown timer will start, when there is no signal being sent to the projector. The projector will automatically power off when the countdown has finished (in minutes).

Sleep Timer (min)

Sets the countdown timer interval. The countdown timer will start, with or without a signal being sent to the projector. The projector will automatically power off when the countdown has finished (in minutes).

Power Mode (Standby)

- ▶ Eco.: Choose “Eco.” to save power dissipation further < 0.5W.
- ▶ Active: Choose “Active” to return to normal standby.



- ❖ The value of sleep timer will be reset to zero after the projector power off.

Troubleshooting

If you experience a problem with your projector, please refer to the following information. If a problem persists, please contact your local reseller or service center.

Image Problems

No image appears on-screen

- ▶ Ensure all the cables and power connections are correctly and securely connected as described in the “Installation” section.
- ▶ Ensure the pins of connectors are not crooked or broken.
- ▶ Check if the projection lamp has been securely installed. Please refer to the “Replacing the Lamp” section.
- ▶ Make sure you have removed the lens cap and the projector is switched on.
- ▶ Ensure that the “AV Mute” feature is not turned on.

Image is out of focus

- ▶ Make sure the Lens cap is removed.
- ▶ Adjust the Focus Ring on the projector lens.
- ▶ Make sure the projection screen is between the required distance from the projector. (refer to pages 21-22)

The image is stretched when displaying 16:9 DVD title

- ▶ When you play anamorphic DVD or 16:9 DVD, the projector will show the best image in 16: 9 format on projector side.
- ▶ If you play the LBX format DVD title, please change the format as LBX in projector OSD.
- ▶ If you play 4:3 format DVD title, please change the format as 4:3 in projector OSD.
- ▶ If the image is still stretched, you will also need to adjust the aspect ratio by referring to the following:
- ▶ Please setup the display format as 16:9 (wide) aspect ratio type on your DVD player.

Image is too small or too large

- ▶ Adjust the zoom lever on the top of the projector.
- ▶ Move the projector closer to or further from the screen.
- ▶ Press “Menu” on the projector panel, go to “Display-->Format”. Try the different settings.

Image has slanted sides:

- ▶ If possible, reposition the projector so that it is centered on the screen and below the bottom of the screen.
- ▶ Use “Display-->V Keystone” from the OSD to make an adjustment.

Image is reversed

- ▶ Select “Setup-->Projection” from the OSD and adjust the projection direction.

Blurry double image

- ▶ Press “3D Format” button and switch to “Off” to avoid normal 2D image is blurry double image.

Two images, side-by-side format

- ▶ Press “3D Format” button and switch to “SBS” for input signal is HDMI 1.3 2D 1080i side-by-side.

Image does not display in 3D

- ▶ Check if the battery of 3D glasses is drained.
- ▶ Check if the 3D glasses is turned on.
- ▶ When the input signal is HDMI 1.3 2D (1080i side-by-side half), press “3D Format” button and switch to “SBS”.

Other Problems



















- ❓ **The projector stops responding to all controls**
 - ▶ If possible, turn off the projector, then unplug the power cord and wait at least 20 seconds before reconnecting power.

- ❓ **Lamp burns out or makes a popping sound**
 - ▶ When the lamp reaches its end of life, it will burn out and may make a loud popping sound. If this happens, the projector will not turn on until the lamp module has been replaced. To replace the lamp, follow the procedures in the “Replacing the Lamp” section.



Remote Control Problems

- ❓ **If the remote control does not work**
 - ▶ Check the operating angle of the remote control is within $\pm 15^\circ$ both horizontally and vertically of one of the IR receivers on the projector.
 - ▶ Make sure there are not any obstructions between the remote control and the projector. Move to within 6 m (20 ft) of the projector.
 - ▶ Make sure batteries are inserted correctly.
 - ▶ Replace batteries if they are exhausted.

LED Lighting Messages

Message	 	 	 
	On/Standby LED (Green/Amber)	Temp-LED (Red)	Lamp-LED (Red)
Standby state (Input power cord)	Amber		
Power on (Warming)	Flashing Green		
Lamp lighting	Green		
Power off (Cooling)	Flashing Green		
Error (Over temp.)	Flashing Amber		
❖ Steady light ⇒  No light ⇒ 	Error (Fan fail)	Flashing Amber	Flashing
	Error (Lamp fail)	Flashing Amber	



❖ Steady light ⇒ 
No light ⇒ 

* On/Standby LED be ON when OSD appears, be OFF when OSD disappears.

On Screen Messages

❖ Power off:

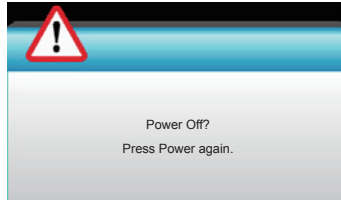

❖ Lamp warning:

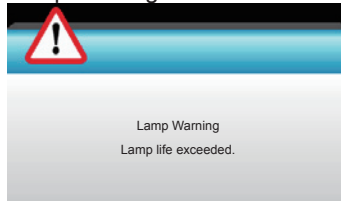

❖ Temperature warning:



❖ Fan failed:

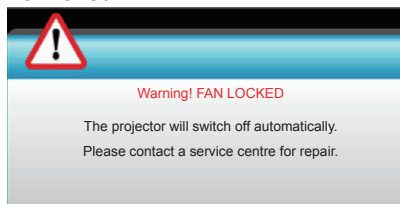

❖ Out of display range:



Replacing the Lamp

The projector automatically detects the lamp life. When the lamp life is nearing the end of use, you will receive a warning message.

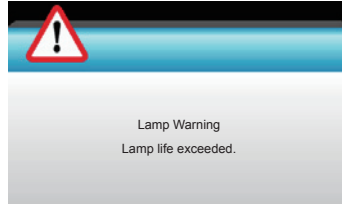

When you see this message, please contact your local reseller or service center to change the lamp as soon as possible. Make sure the projector has been cooled down for at least 30 minutes before changing the lamp.

CAUTION! (Hg)

HIGH TEMPERATURE COOL FOR 30 MINUTES.
HIGH PRESSURE LAMP MAY EXPLODE IF IMPROPERLY HANDED.
REFER TO LAMP REPLACEMENT INSTRUCTIONS. DISCONNECT
POWER BEFORE CHANGING LAMP.

ATTENTION:
A HAUTES TEMPERATURES REFROIDISSEZ PENDANT 30 MINUTES.
Les lampes à haute pression peuvent exploser si elles sont mal utilisées.
Confier l'entretien à une personne qualifiée.
COUPER LE COURANT AVANT DE REMPLACER LES LAMPES.



Warning: If ceiling mounted, please use caution when opening the lamp access panel. It is recommended to wear safety glasses if changing the bulb when ceiling mounted. "Caution must be used to prevent any loose parts from falling out of projector."



Warning: Lamp compartment is hot! Allow it to cool down before changing lamp!



Warning: To reduce the risk of personal injury, do not drop the lamp module or touch the lamp bulb. The bulb may shatter and cause injury if it is dropped.

Appendices



- ❖ The screw on the lamp cover and the lamp cannot be removed.
- ❖ The projector cannot be turned on if the lamp cover has not been placed back on the projector.
- ❖ Do not touch the glass area of the lamp. Hand oil can cause the lamp to shatter. Use a dry cloth to clean the lamp module if it was accidentally touched.

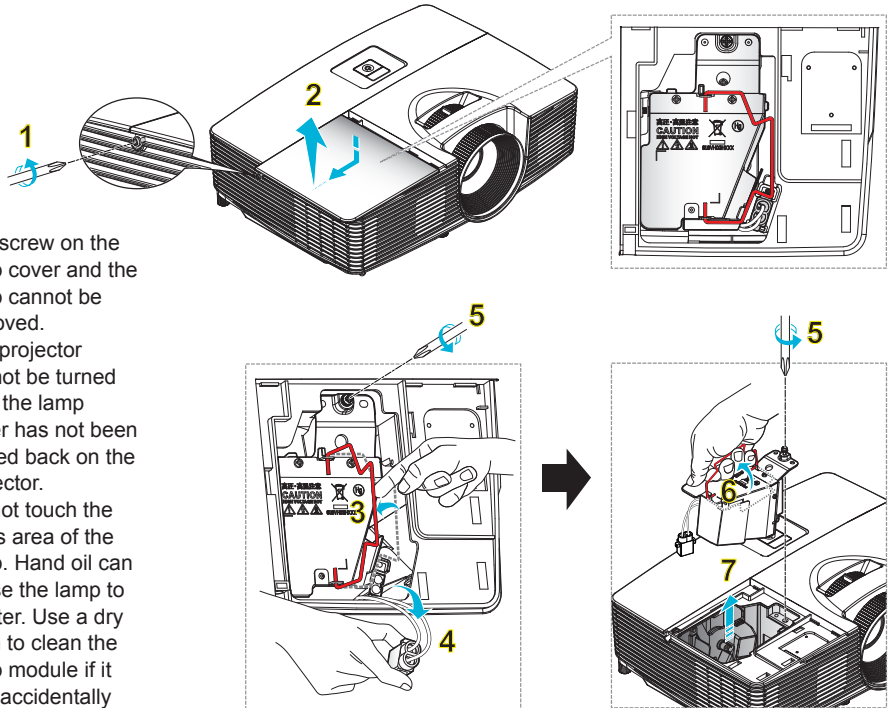

Lamp Replacement Procedure:

1. Switch off the power to the projector by pressing the “⏻” button on the remote control or “⏻” on the Keypad of the projector.
 2. Allow the projector to cool down for at least 30 minutes.
 3. Disconnect the power cord.
 4. Unscrew the one screw on the cover. **1**
 5. Push up and remove the cover. **2**
 6. Lift up the lamp handle. **3**
 7. Press on the both sides then lift up and remove the lamp cord. **4**
 8. Unscrew the one screw on the lamp module. **5**
 9. Lift up the lamp handle **6** and remove the lamp module slowly and carefully. **7**
- To replace the lamp module, reverse the previous steps.
10. Turn on the projector and reset the lamp timer.

Lamp Reset: (i) Press “Menu” → (ii) Select “OPTIONS” → (iii) Select “Lamp Settings” → (iv) Select “Lamp Reset” → (v) Select “Yes”.

Installing and Cleaning the Dust Filter



❖ Dust filters are only required/supplied in selected regions with excessive dust.

Installing the Dust Filter

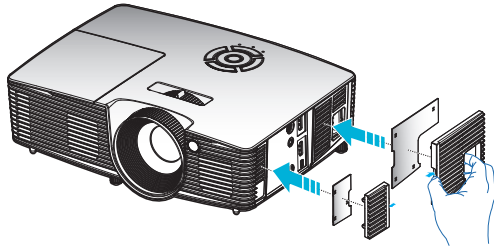

Cleaning the Dust Filter

We recommend cleaning the dust filter every three months; clean it more often if the projector is used in a dusty environment.

Procedure:

1. Switch off the power to the projector by pressing the “ⓘ” button on the remote control or “⏻” on the Keypad of the projector.
2. Disconnect the power cord.
3. Remove the dust filter slowly and carefully.
4. Clean or replace the dust filter.
5. To install the dust filter, reverse the previous steps.

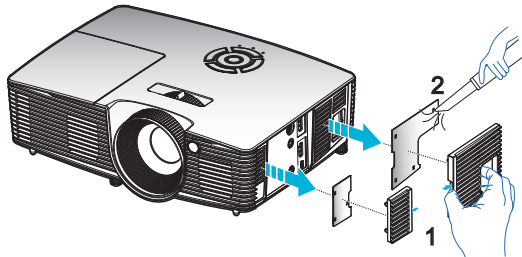

Compatibility Modes

HDMI/DVI-D Compatibility

Digital		
B0/Established timing	B0/Standard timing	B0/Detail timing:
720 x 400 @ 70Hz 640 x 480 @ 60Hz 640 x 480 @ 67Hz 640 x 480 @ 72Hz 640 x 480 @ 75Hz 800 x 600 @ 56Hz 800 x 600 @ 60Hz 800 x 600 @ 72Hz 800 x 600 @ 75Hz 832 x 624 @ 75Hz 1024 x 768 @ 60Hz 1024 x 768 @ 70Hz 1024 x 768 @ 75Hz 1280 x 1024 @ 75Hz 1152 x 870 @ 75Hz	1280 x 720 @ 60Hz 1280 x 800 @ 60Hz 1280 x 1024 @ 60Hz 1400 x 1050 @ 60Hz 1600 x 1200 @ 60Hz 1440 x 900 @ 60Hz 1280 x 720 @ 120Hz 1024 x 768 @ 120Hz	Native timing: XGA: 1024 x 768 @ 60Hz WXGA: 1280 x 800 @ 60Hz 1080P: 1920 x 1080 @ 60Hz
B1/Video mode	B1/Detail timing:	
640 x 480p @ 60Hz 720 x 480p @ 60Hz 1280 x 720p @ 60Hz 1920 x 1080i @ 60Hz 720(1440) x 480i @ 60Hz 1920 x 1080p @ 60Hz 720 x 576p @ 50Hz 1280 x 720p @ 50Hz 1920 x 1080i @ 50Hz 720(1440) x 576i @ 50Hz 1920 x 1080p @ 50Hz 1920 x 1080p @ 24Hz 1920 x 1080p @ 30Hz	720 x 480p @ 60Hz 1280 x 720p @ 60Hz 1366 x 768 @ 60Hz 1920 x 1080i @ 50Hz 1920 x 1080p @ 60Hz	

3D Input Video Compatibility

Input resolution	Input timing		
HDMI 1.4a 3D Input	1280 x 720p @ 50Hz	Top-and-Bottom	
	1280 x 720p @ 60Hz	Top-and-Bottom	
	1280 x 720p @ 50Hz	Frame packing	
	1280 x 720p @ 60Hz	Frame packing	
	1920 x 1080i @ 50 Hz	Side-by-Side (Half)	
	1920 x 1080i @ 60 Hz	Side-by-Side (Half)	
	1920 x 1080p @ 24 Hz	Top-and-Bottom	
	1920 x 1080p @ 24 Hz	Frame packing	
HDMI 1.3 3D Content	1920 x 1080i @ 50Hz	Side-by-Side (Half)	While 3D Format is "SBS"
	1920 x 1080i @ 60Hz		
	1280 x 720p @ 50Hz		
	1280 x 720p @ 60Hz		
	1920 x 1080i @ 50Hz	Top-and-Bottom	While 3D Format is "Top and Bottom"
	1920 x 1080i @ 60Hz		
	1280 x 720p @ 50Hz		
	1280 x 720p @ 60Hz		
480i	HQFS	While 3D Format is "Frame sequential"	

Ceiling Mount Installation

1. To prevent damage to your projector, please use the Optoma ceiling mount.
2. If you wish to use a third party ceiling mount kit, please ensure the screws used to attach a mount to the projector meet the following specifications:

- ▶ Screw type: M4*3
- ▶ Minimum screw length: 10mm



❖ Please note that damage resulting from incorrect installation will void the warranty.



⚠ Warning:

1. If you buy a ceiling mount from another company, please be sure to use the correct screw size. Screw size will vary depending on the thickness of the mounting plate.
2. Be sure to keep at least 10 cm gap between the ceiling and the bottom of the projector.
3. Avoid installing the projector near a heat source.

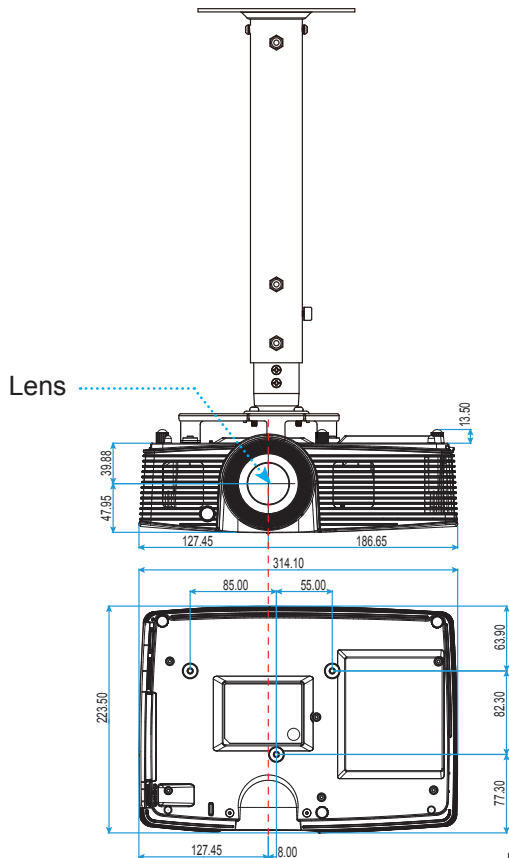



Optoma Global Offices

For service or support please contact your local office.

USA

3178 Laurelview Ct.
Fremont, CA 94538, USA
www.optomausa.com

 888-289-6786
 510-897-8601
 services@optoma.com



Canada

3178 Laurelview Ct.
Fremont, CA 94538, USA
www.optomausa.com

 888-289-6786
 510-897-8601
 services@optoma.com

Latin America

3178 Laurelview Ct.
Fremont, CA 94538, USA
www.optomausa.com

 888-289-6786
 510-897-8601
 services@optoma.com



Europe

42 Caxton Way, The Watford Business Park
Watford, Hertfordshire,
WD18 8QZ, UK
www.optoma.eu
Service Tel : +44 (0)1923 691865

 +44 (0) 1923 691 800
 +44 (0) 1923 691 888
 service@tsc-europe.com

Benelux BV

Randstad 22-123
1316 BW Almere
The Netherlands
www.optoma.nl

 +31 (0) 36 820 0253
 +31 (0) 36 548 9052



France

Bâtiment E
81-83 avenue Edouard Vaillant
92100 Boulogne Billancourt, France
savoptoma@optoma.fr

 +33 1 41 46 12 20
 +33 1 41 46 94 35
 savoptoma@optoma.fr

Spain



C/ José Hierro,36 Of. 1C
28522 Rivas VaciaMadrid,
Spain

 +34 91 499 06 06
 +34 91 670 08 32

Appendices



Deutschland

Wiesenstrasse 21 W
D40549 Düsseldorf,
Germany

 +49 (0) 211 506 6670
 +49 (0) 211 506 66799
 info@optoma.de

Scandinavia



Lerpeveien 25
3040 Drammen
Norway

 +47 32 98 89 90
 +47 32 98 89 99
 info@optoma.no

PO.BOX 9515
3038 Drammen
Norway

Korea

WOOMI TECH.CO.,LTD.
4F,Minu Bldg.33-14, Kangnam-Ku,
seoul,135-815, KOREA

 +82+2+34430004
 +82+2+34430005



Japan

東京都足立区綾瀬3-25-18
株式会社オーエス
コンタクトセンター:0120-380-495

 info@os-worldwide.com
www.os-worldwide.com



Taiwan

12F., No.213, Sec. 3, Beixin Rd.,
Xindian Dist., New Taipei City 231,
Taiwan, R.O.C.
www.optoma.com.tw

 +886-2-8911-8600
 +886-2-8911-6550
 services@optoma.com.tw
asia.optoma.com



Hong Kong

Unit A, 27/F Dragon Centre,
79 Wing Hong Street,
Cheung Sha Wan,
Kowloon, Hong Kong

 +852-2396-8968
 +852-2370-1222
www.optoma.com.hk

China

5F, No. 1205, Kaixuan Rd.,
Changning District
Shanghai, 200052, China

 +86-21-62947376
 +86-21-62947375
www.optoma.com.cn

Regulation & Safety Notices

This appendix lists the general notices of your projector.

FCC Notice

This device has been tested and found to comply with the limits for a Class B digital device pursuant to Part 15 of the FCC rules. These limits are designed to provide reasonable protection against harmful interference in a residential installation. This device generates, uses and can radiate radio frequency energy and, if not installed and used in accordance with the instructions, may cause harmful interference to radio communications.

However, there is no guarantee that interference will not occur in a particular installation. If this device does cause harmful interference to radio or television reception, which can be determined by turning the device off and on, the user is encouraged to try to correct the interference by one or more of the following measures:

- ❖ Reorient or relocate the receiving antenna.
- ❖ Increase the separation between the device and receiver.
- ❖ Connect the device into an outlet on a circuit different from that to which the receiver is connected.
- ❖ Consult the dealer or an experienced radio/television technician for help.

Notice: Shielded cables

All connections to other computing devices must be made using shielded cables to maintain compliance with FCC regulations.

Caution

Changes or modifications not expressly approved by the manufacturer could void the user's authority, which is granted by the Federal Communications Commission, to operate this projector.

Operation Conditions

This device complies with Part 15 of the FCC Rules. Operation is subject to the following two conditions:

1. This device may not cause harmful interference and
2. This device must accept any interference received, including interference that may cause undesired operation.

Notice: Canadian users

This Class B digital apparatus complies with Canadian ICES-003.

Remarque à l'intention des utilisateurs canadiens

Cet appareil numérique de la classe B est conforme à la norme NMB-003 du Canada.

Declaration of Conformity for EU countries

- EMC Directive 2004/108/EC (including amendments)
- Low Voltage Directive 2006/95/EC
- R & TTE Directive 1999/5/EC (if product has RF function)



Disposal instructions

Do not throw this electronic device into the trash when discarding. To minimize pollution and ensure utmost protection of the global environment, please recycle it.

