

User's Guide

Multimedia Projector



EB-L1755U	EB-L1715S
EB-L1750U	EB-L1710S
EB-L1505UH	EB-L1515S
EB-L1500UH	EB-L1510S
EB-L1550U	EB-L1555U

Notations Used in This Guide





- **Safety indications**

The documentation and the projector use graphical symbols to show how to use the projector safely.

The indications and their meaning are as follows. Make sure you understand them properly before reading the guide.

 Warning	This symbol indicates information that, if ignored, could possibly result in personal injury or even death due to incorrect handling.
 Caution	This symbol indicates information that, if ignored, could possibly result in personal injury or physical damage due to incorrect handling.

- **General information indications**

Attention	Indicates procedures which may result in damage or injury if sufficient care is not taken.
	Indicates additional information and points which may be useful to know regarding a topic.
	Indicates a page where detailed information regarding a topic can be found.
	Indicates that an explanation of the underlined word or words in front of this symbol appears in the glossary of terms. See the "Glossary" section of the "Appendix".  "Glossary" p.279
[Name]	Indicates the name of the buttons on the remote control or the control panel. Example: [Esc] button
Menu Name	Indicates Configuration menu items. Example: Select Brightness from Image . Image - Brightness

Make sure you read the following before you use the projector.

☛ [Safety Instructions](#)

Warning and Cautions on Installation

An optional ceiling mount is required when suspending the projector from a ceiling.

☛ "Optional Accessories" [p.240](#)

Warning

- Do not use or install the projector where it may be subject to water or rain, or high humidity, such as outdoors, in a bathroom, or shower room, and so on. Otherwise, it could cause a fire or electric shock.
- A special method of installation is required when suspending the projector from a ceiling (ceiling mount). If installation work is not carried out correctly, the projector could fall down. This may result in injury or accidents. Contact your local dealer or the nearest address provided in the Epson Projector Contact List.
☛ [Epson Projector Contact List](#)
- If you use adhesives on the ceiling mount fixing points to prevent the screws from loosening, or if you use things such as lubricants or oils on the projector, the projector case may crack causing it to fall from its ceiling mount. This could cause an accident or injury to anyone under the ceiling mount.
When installing or adjusting the ceiling mount, do not use adhesives to prevent the screws from loosening and do not use oils or lubricants and so on.
- Do not cover the projector's air intake vent or air exhaust vent. If either of the vents are covered, the internal temperature could rise and cause a fire.
- Do not place flammable objects in front of the lens. If you set the schedule to turn on the projector automatically, any flammable objects placed in front of the lens could cause a fire.
- Do not tie the power cord and other connection cables together. Otherwise, it could cause a fire.
- Only use the specified power-supply voltage. Otherwise, it could cause a fire or electric shock.

Warning

- Be careful when handling the power cord. Otherwise, it could cause a fire or electric shock. Note the following when handling the power cord.
 - Do not plug multiple power cords in a single electric outlet.
 - Do not plug in the power cord if there are any foreign substances, such as dust, stuck to it.
 - Make sure you insert the power cord all the way in.
 - Do not plug in or unplug the power cord with wet hands.
 - Do not pull the cord when unplugging the power cord. Make sure you hold it by the plug.
- Do not use a damaged power cord. Otherwise, it could cause a fire or electric shock. Note the following when handling the power cord.
 - Do not alter the power cord.
 - Do not place any heavy objects on the power cord.
 - Do not bend, twist, or pull the power cord forcibly.
 - Do not layout the power cord near a heating device.

Caution

Do not place the projector on an unstable surface, such as on an unstable table or tilted surface. When projecting vertically, install the projector appropriately to prevent the projector from falling. Otherwise it may cause an injury.

Attention

- Do not install the projector in a location that is subject to vibration or shock.
- Do not install the projector near a high-voltage line or object that generates magnetism. Otherwise the projector may not work correctly.
- Do not use or store the projector in a location that is subject to extreme temperatures. Also, avoid sudden temperature changes.
Make sure you use or store the projector in a place that is within the following operating or storage temperature ranges.
 - Operating temperature range
0 to +50°C (Altitude of 0 to 1,500 m, no condensation)
0 to +45°C (Altitude of 1,501 to 3,048 m, no condensation)
 - Storage temperature range: -10 to +60°C (No condensation)
- When using at an altitude that exceeds 1,500 m, set **High Altitude Mode** to **On**.
 - ☛ **Extended - Operation - High Altitude Mode** p.150
- The projector can be installed at any angle. There is no vertical or horizontal limit to how the projector can be installed.

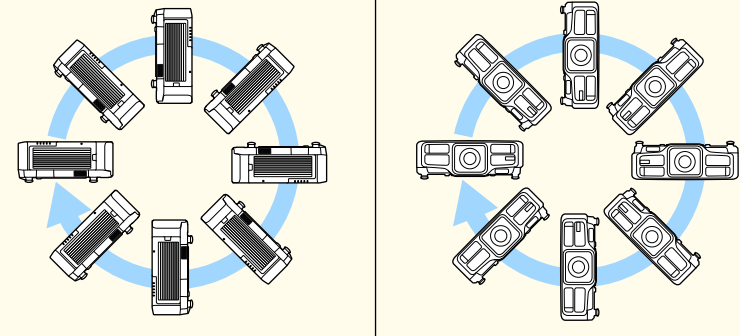

- You may need dedicated installation mounts to tilt and install the projector. Contact a professional and prepare the mount.
- Plan so that the mount does not fall.

Attention

- Make sure you secure the following space around the projector so as not to block the air exhaust vent and the air intake vent.

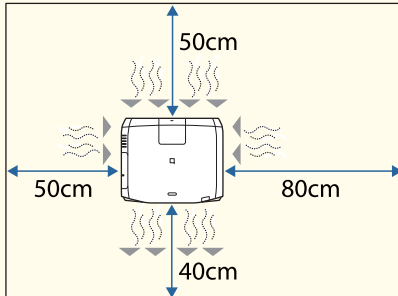

- When setting up multiple projectors, make sure there is a gap of at least 50 cm between the projectors. Also, make sure that the heat from the air exhaust vent does not go into the air intake vent.

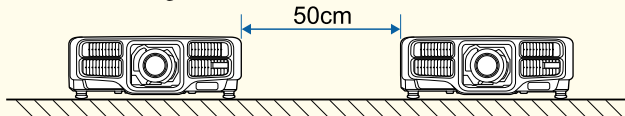

- Do not use two projectors at the same time when stacking two projectors directly on top of each other. Install the projector so that there is no danger that it will fall.

Attention

- Use commercially available M6 screws (up to a depth of 12 mm) to fix the projector's ceiling mount fixing points and the mount at four points.

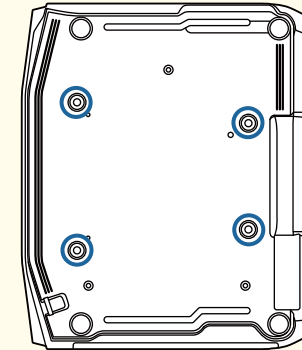

- When installing the projector with the air intake vent facing down, make sure there is a gap of at least 10 cm between the projector and the floor and so on. Make sure there is a space of 50 x 20 cm for the base so that the air intake vent is not blocked.

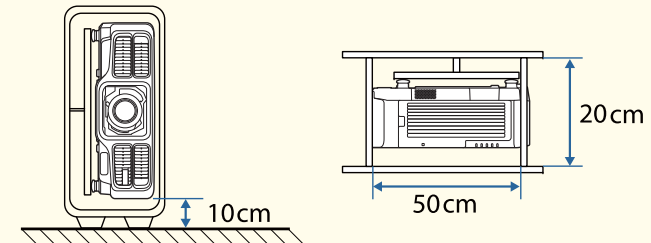

- We recommend setting the focus, zoom, and lens shift at least 20 minutes after you start the projection, because images are not stable right after turning on the projector. Wait for at least 20 minutes.
- When adjusting the image height with the vertical lens shift, adjust by moving the image from the bottom to the top. If it is adjusted from the top to the bottom, the image position may move down slightly after adjusting.

Warning and Cautions on Usage

Warning

- Do not cover the projector's air intake vent or air exhaust vent. If either of the vents is covered, the internal temperature could rise and cause a fire.
- Do not look into the lens while projecting. The powerful light emitted could cause damage to eyesight. Take particular care when there are children present. When turning on the projector at a distance using the remote control, make sure there is no one looking into the lens.
- During projection, do not block the light from the projector with the lens cover (removable) or a book and so on.

If the light from the projector is blocked, the area on which the light shines becomes hot which could cause it to melt, burn, or start a fire. Also, the lens may get hot due to the reflected light which could cause the projector to malfunction. To stop projection, use the A/V Mute function, or turn off the projector.

- Do not open the projector's case. Never disassemble or remodel the projector. There are high-voltage components inside the projector that could cause fire, electric shock, or an accident.
- If an error occurs, disconnect the power cord from the electrical outlet, and contact your local dealer or the nearest address provided in the Epson Projector Contact List. If you continue using the projector as it is, it could cause an electric shock, fire, or even damage to eyesight.

 [Epson Projector Contact List](#)

Caution

Do not place objects that may become warped or otherwise affected by heat near the air exhaust vent and do not put your face or hands near the vent while projection is in progress.

Attention

- Only remove the lens unit when necessary. If dust or dirt enter the projector, projection quality deteriorates and it could cause a malfunction.
- Try not to touch the lens section with your hand or fingers. If fingerprints or oils are left on the surface of the lens, projection quality deteriorates.
- Store the projector with the lens unit installed.
If the projector is stored without the lens unit, dust and dirt may get inside the projector and cause malfunctions or lower the quality of projection.
- When storing, make sure you remove the batteries from the remote control. If the batteries are left in the remote control for an extended period of time, they may leak.



- About the LCD panel
 - The LCD panel may contain pixels that are missing or appear bright all the time. This is not a sign of an error.
 - When a high-powered laser beams through the surface of the projection lens even when it is not being used, it can cause a malfunction in the LCD panel. Attach the lens cover when storing the projector.

- About the light source

The projector uses a laser as the light source. The laser has the following characteristics.

- Depending on the surroundings, the brightness of the light source may decline. The brightness declines a lot when the temperature gets too high.
- The brightness of the light source declines the longer it is used. You can change the relationship between usage time and decline in brightness in **Brightness Settings**.

☛ "Relationship between Brightness Level and usage time" [p.79](#)

- Light Source Calibration

- Whenever the usage time reaches 100 hours, calibration starts automatically for the light source when the projector is turned off. However, this does not start automatically when the projector is used continuously for more than 24 hours, or when direct shutdown is used regularly. Set **Light Source Calibration** in the scheduling function.

☛ "Scheduling Function" [p.116](#)

- When performing light source calibration, the difference between the white balance and the brightness level for the light source is corrected.

Warning and Cautions on the Laser



Warning

- Laser warning labels are attached inside the projector and on the side of the projector.

Inside



Warning

Side

⚠ WARNING



WARNING:
This projector may become RG3 when an interchangeable lens with throw ratio greater than 2.5 is installed.
Refer to the manual for the lens list and hazard distance before operation.
Such combinations of projector and lens are intended for professional use only, and are not intended for consumer use.

AVERTISSEMENT:
Ce projecteur peut devenir de classe RG3 quand une lentille interchangeable avec rapport de projection supérieur à 2,5 est installée.
Reportez-vous au manuel pour la liste de lentilles et la distance de sécurité avant d'utiliser le produit.
Ces combinaisons de projecteur et de lentilles sont destinées à un usage professionnel, et pas destinées à l'usage des consommateurs.

WARNUNG:
Dieser Projektor kann RG3 werden, wenn ein Wechsellobjektiv mit Projektionsverhältnis größer als 2,5 installiert ist.
Eine Liste der Linsen und Sicherheitsabstände entnehmen Sie dem Handbuch vor dem Betrieb.
Solche Kombinationen von Projektor und Linse sind nur für den professionellen Einsatz bestimmt, und sind nicht für normalen Gebrauch vorgesehen.

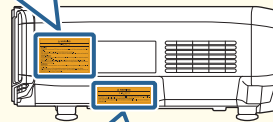

⚠ WARNING



This projector may become RG3 when an interchangeable lens with throw ratio greater than 2.5 is installed.
Refer to the manual for the lens list and hazard distance before operation.
Such combinations of projector and lens are intended for professional use only, and are not intended for consumer use.

⚠ 경고



2.5보다 더큰 투사율을 갖는 교환 할 수 있는 렌즈가 설치될 경우 이 프로젝트는 RG3가 될 수 있습니다.
작동 하기 전에 렌즈 목록 및 위해 거리에 대한 설명서를 참조하십시오.
프로젝터와 렌즈의 조합은 전문적인 사용을 위한 것이며, 소비자 용으로는 사용할 수 없습니다.

⚠ 警語



當安裝投影比例大於 2.5 的可交換式鏡頭, 此投影機可能變成RG3。
操作前請先參閱手冊中的鏡頭清單和危險距離。
此投影機和鏡頭之組合僅供專業使用, 勿作其他用途。

Warning

- Do not open the projector's case. The projector contains a high-powered laser.
- Do not look into the laser beam being emitted from the projection lens while projecting. (Based on the RG2 IEC/EN 62471-5: 2015)
- This projector may become RG3 when an interchangeable lens with throw ratio greater than 2.5 (EB-L1755U/EB-L1750U/EB-L1715S/EB-L1710S) or 3.0 (EB-L1505UH/EB-L1500UH/EB-L1515S/EB-L1510S) is installed. Refer to the manual for the lens list and hazard distance before operation. Such combinations of projector and lens are intended for professional use only, and are not intended for consumer use.

Caution

- This projector is a Class 1 laser product that complies with the IEC/EN60825-1: 2014 international standard for lasers.
- Do not disassemble the projector when disposing of it. Dispose according to your local or national laws and regulations.

Notes on Transporting

There are many glass parts and precision components inside the projector. To prevent damage due to impacts when transporting, handle the projector as follows.



Caution

The projector should not be carried by one person. At least two people are needed to unpack or carry the projector.

Attention

- Moving Nearby
 - Turn off the power to the projector and disconnect all cables.
 - Attach the cover to the lens.
- When Transporting

After checking the points in "Moving Nearby", prepare the following and then pack up the projector.

 - Remove the lens unit if an option lens is installed.
 - If the projector does not have a lens, attach the cover that was on the lens mount when you purchased the projector.
 - Attach the lens if the projector has a built-in lens. Upon purchase, attach the protective pad that is attached around the lens unit.
 - Move the lens position to the home position.
 - ☛ "Adjusting the Position of the Projected Image (Lens Shift)"
[p.34](#)
 - Enclose the projector securely in packaging material to protect it from shock, and place it into a strong container. Be sure to notify the carrier company that it is precision equipment and that it needs to be kept horizontally during transportation.

Notations Used in This Guide 2

Introduction

Part Names and Functions 16

Front/Top	16
Rear	17
Interface	18
Base	19
Control Panel	20
Remote Control	21
Handy remote control operations	24
Replacing the remote control batteries	24
Remote control operating range	25
Connecting a cable to the remote control	26

Preparing the Projector

Installing the Projector 28

Removing and Attaching the Projector Lens Unit	28
Attaching	28
Lens Calibration	29
Removing	30
Installation Settings	30
Changing the direction of the image (projection mode)	30
Screen Settings	31
Adjusting the position of the image on the projected screen	32
Displaying a Test Pattern	32
Adjusting the Position of the Projected Image (Lens Shift)	34
EB-L1755U/EB-L1750U/EB-L1505UH/EB-L1500UH	34
EB-L1715S/EB-L1710S/EB-L1515S/EB-L1510S	36
Adjusting the Image Size	38
Correcting the Focus	39
Correcting Distortion (Image Warping)	39
Registering and Loading Lens Adjustment Values	41

Adjusting the Height of the Projected Image (for Normal Installment)	42
Adjusting the Horizontal Tilt (for Normal Installment)	43
ID Settings	43
Set the projector ID	43
Checking the projector ID	44
Setting the remote control ID	44
Setting the Time	45
Other Settings	46
Settings related to basic operations	46
Settings related to display	47

Connecting Equipment 48

Connecting a Computer	48
Connecting Image Sources	50
Connecting External Equipment	52
Connecting a LAN Cable	53
Connecting an HDBaseT Transmitter	54
Installing the Wireless LAN Unit	55
Attaching the Cable Cover	56
Attaching	56

Basic Usage

Turning On the Projector 59

Home Screen	59
-------------------	----

Turning Off the Projector 61

Projecting Images 62

Automatically Detecting Input Signals and Changing the Projected Image (Source Search)	62
Switching to the Target Image by Remote Control	63
Adjusting the Volume	64

Adjusting Projected Images 65

Correcting Distortion in the Projected Image	65
H/V-Keystone	66
Quick Corner	67



Curved Surface 68

Corner Wall 72

Point Correction 75

Selecting the Projection Quality (Selecting Color Mode) 77

Setting the Brightness 77

 Guide to Estimated Remains 79

 Relationship between Brightness Level and usage time 79

Setting the Amount of Light of the Projected Image 80

Changing the Aspect Ratio of the Projected Image 81

 Changing methods 81

Adjusting the Image 84

 Hue, Saturation, and Brightness adjustment 84

 Gamma adjustment 85

 Frame Interpolation 87

Adjusting Image Resolution (Image Enhancement) 87

 4K Enhancement (EB-L1755U/EB-L1750U/EB-L1505UH/EB-L1500UH only) 88

 Image Preset Mode 89

 Noise Reduction 89

 MPEG Noise Reduction 89

 Super-resolution 90

 Detail Enhancement 90

Projecting 3D Images (EB-L1505UH/EB-L1500UH/EB-L1515S/EB-L1510S only) 91

Useful Functions

Multi-Projection Function 93

 Adjustment Procedure 93

 Adjusting automatically online 93

 Adjusting manually offline 94

 Tiling 94

 Performing tiling automatically 94

 Performing tiling manually 96

 Edge Blending 97

 Black Level 99

 Screen Matching 102

 Operating conditions for auto adjustment functions 102

 Automatically correct the brightness and tint for multiple projectors 103

 Color Matching 104

 Displaying a Scaled Image 105

Projection Functions 107

 Projecting Two Images Simultaneously (Split Screen) 107

 Input Sources for Split Screen Projection 107

 Operating procedures 108

 Restrictions during split screen projection 110

 Hiding the Image and Sound Temporarily (A/V Mute) 110

 Freezing the Image (Freeze) 111

 Enlarging Part of the Image (E-Zoom) 112

 Saving a User's Logo 113

Memory Function 114

 Saving/Loading/Erasing/Resetting the Memory 114

Scheduling Function 116

 Saving an Event 116

 Setting an Event 116

 Checking an Event 117

 Editing an Event 118

Security Functions 120

 Managing Users (Password Protection) 120

 Kinds of Password Protection 120

 Setting Password Protection 120

 Entering the password 121

 Restricting Operation 122

 Control Panel Lock 122

 Lens Lock 123

 Remote control button lock 123

 Anti-Theft Lock 124

 Installing the wire lock 124



Using the Projector on a Network

Wired Network Projection	126
Selecting Wired Network Settings	126
Wireless Network Projection	129
Selecting Wireless Network Settings Manually	129
Selecting Wireless Network Settings in Windows	132
Selecting Wireless Network Settings in OS X	132
Setting Up Wireless Network Security	132
Supported Client and CA Certificates	134
Using a QR Code to Connect a Mobile Device	135
Using a USB Key to Connect a Windows Computer	136
Secure HTTP	137
Importing a Web Server Certificate Using the Menus	137
Supported Web Server Certificates	138

Configuration Menu

Using the Configuration Menu	140
List of Functions	141
Configuration Menu Table	141
Network menu	142
Image Menu	143
Signal Menu	146
Settings Menu	148
Extended Menu	150
Network Menu	155
Notes on operating the Network menu	156
Soft keyboard operations	157
Basic menu	157
Wireless LAN menu	158
Wired LAN menu	162
Notifications menu	162
Others menu	164

Reset menu	164
Info Menu (Display Only)	165
Reset Menu	167

Batch Setup

Setup Using a USB Flash Drive	168
Saving settings to the USB flash drive	168
Reflecting saved settings to other projectors	170
Setup by Connecting the Computer and Projector with a USB Cable	172
Saving settings to a computer	172
Reflecting saved settings to other projectors	173
When Setup Fails	174

Troubleshooting

Using the Help	176
Reading the Indicators	178
Reading the Status Display	184
Explanations of the Display Content	185
Problem Solving	192
Problems Relating to Images	193
No images appear	193
Moving images are not displayed	194
Projection stops automatically	194
The EDID is not set. is displayed	194
Not supported. is displayed	194
No Signal. is displayed	195
Images are fuzzy, out of focus, or distorted	195
Interference or distortion appear in images	196
The image is truncated (large) or small, the aspect is not suitable, or the image has been reversed	196
Image colors are not right	197
Images appear dark	198
Automatic adjustments are not performed correctly	198
Problems when Projection Starts	199

The projector does not turn on 199

Other Problems 200

 No sound can be heard or the sound is faint 200

 The remote control does not work 201

 Nothing appears on the external monitor 202

 I want to change the language for messages and menus 202

 Email is not received even if a problem occurs in the projector 202

 The battery that saves your clock settings is running low, is displayed 203

 The projector did not turn off correctly. An instantaneous voltage drop may have occurred, is displayed 203

 Detailed logs and error message are not displayed 203

About Event ID 204

Maintenance

Cleaning 207

Cleaning the Projector's Surface 207

Cleaning the Lens 207

Cleaning the Air Filter 207

 Cleaning the air filter 207

Replacing Consumables 210

Replacing the Air Filter 210

 Air filter replacement period 210

 How to replace the air filter 210

Image Maintenance 212

Color Calibration 212

Panel Alignment 213

Color Uniformity 215

Appendix

Monitoring and Controlling 218

Epson Projector Management 218

Changing Settings Using a Web Browser (Epson Web Control) 218

 Displaying the Epson Web Control Screen 218

 Basic Control Screen 219

 OSD Control Pad Screen 220

 Lens Control Screen 221

 Status Information Screen 223

 Remote Camera Access screen 223

 Setting a certificate using a Web browser 226

Using the Mail Notification Function to Report Problems 227

 Reading error notification mail 227

Management Using SNMP 228

ESC/VP21 Commands 228

 Command list 228

 Cable layouts 229

About PjLink 230

About Crestron RoomView® 230

 Operating a projector from your computer 231

Art-Net 235

 Channel definitions 235

Optional Accessories and Consumables 240

Optional Accessories 240

Consumables 240

Screen Size and Projection Distance 241

Projection Distance for EB-L1755U/EB-L1750U/EB-L1505UH/EB-L1500UH 241

 ELPLM15/ELPLM09/ELPLS04 241

 ELPLX02 242

 ELPLU03 242

 ELPLU04/ELPLU02 243

 ELPLW05 243

 ELPLW06/ELPLW04 244

 ELPLM10/ELPLM06 245

 ELPLM11/ELPLM07 246

 ELPLL08/ELPLL07 247

 ELPLR04 247

Projection Distance for EB-L1715S/EB-L1710S/EB-L1515S/EB-L1510S 248

 ELPLM15/ELPLM09/ELPLS04 248

 ELPLX02 249

ELPLU03	249
ELPLU04/ELPLU02	250
ELPLW05	251
ELPLW06/ELPLW04	252
ELPLM10/ELPLM06	253
ELPLM11/ELPLM07	253
ELPLL08/ELPLL07	254
ELPLR04	255
Polarizer (ELPPL01) Installation Distance (EB-L1505UH/EB-L1500UH/EB-L1515S/EB-L1510S Only)	256
Adjustment Range for Projected Images	257
H/V-Keystone	257
Curved Surface	257
Corner Wall	261
Supported Monitor Displays	266
EB-L1755U/EB-L1750U/EB-L1505UH/EB-L1500UH	266
SDI	269
EB-L1715S/EB-L1710S/EB-L1515S/EB-L1510S	270
Specifications	273
Projector General Specifications	273
Appearance	278
Glossary	279
General Notes	281
About Notations	281
Trademarks and Copyrights	281
List of Safety Symbols Compliant with IEC60950-1 A2	283
Index	285



Introduction

This chapter explains the names for each part.

The illustrations in this guide show the lens unit attached to the projector.

Front/Top

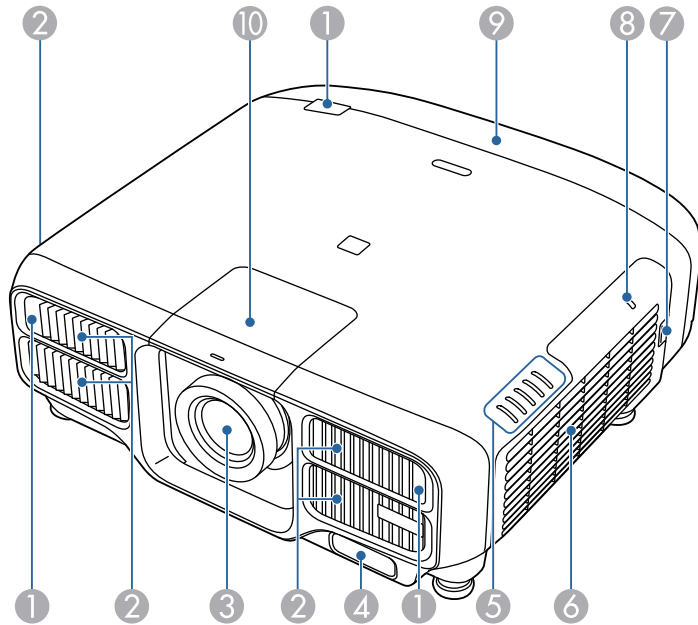

Name	Function
① Remote receiver	Receives signals from the remote control.
② Air intake vent	Takes in air to cool the projector internally.

Name	Function
③ Projection lens	<p>Images are projected through here.</p> <div style="border: 1px solid black; padding: 5px; margin: 5px 0;"> <p>Warning</p> <p>Do not look into the lens while projecting. This could cause damage to eyesight due to the powerful light emitted.</p> </div> <div style="border: 1px solid black; padding: 5px; margin: 5px 0;"> <p>Caution</p> <p>When shifting the lens, do not put your hands near the lens unit. Your fingers may get caught between the lens unit and the projector, and cause an injury.</p> </div>
④ Built-in camera	<p>This camera scans the image when correcting the projected image automatically.</p> <div style="border: 1px solid black; padding: 5px; margin: 5px 0;"> <p>Attention</p> <p>Exposing the camera to bright light may cause a malfunction to occur.</p> </div>
⑤ Status indicators	<p>The color of the indicators and whether they are flashing or lit indicate the status of the projector.</p> <p>☛ "Reading the Indicators" p.178</p>
⑥ Air intake vent (air filter)	<p>Takes in air to cool the projector internally.</p> <p>☛ "Cleaning the Air Filter" p.207</p>
⑦ Air filter cover tab	<p>Use this knob to open the air filter cover.</p> <p>☛ "Replacing the Air Filter" p.210</p>
⑧ Wireless LAN indicator	<p>Indicates the access status to the optional wireless LAN unit.</p> <p>☛ "Optional Accessories" p.240</p>
⑨ Cable cover	<p>Cover for the rear interface cable connection section.</p> <p>☛ "Attaching the Cable Cover" p.56</p>

Name	Function
<p>⑩ Lens replacement cover</p>	<p>Remove when attaching or removing the lens. 🖱️ "Removing and Attaching the Projector Lens Unit" p.28</p> <div style="border: 1px solid black; padding: 5px; margin-top: 10px;"> <p>⚠️ Caution</p> <p>When moving the projector, do not hold the lens replacement cover. The lens replacement cover may be removed and the projector may fall, which could cause an injury.</p> </div>

Rear

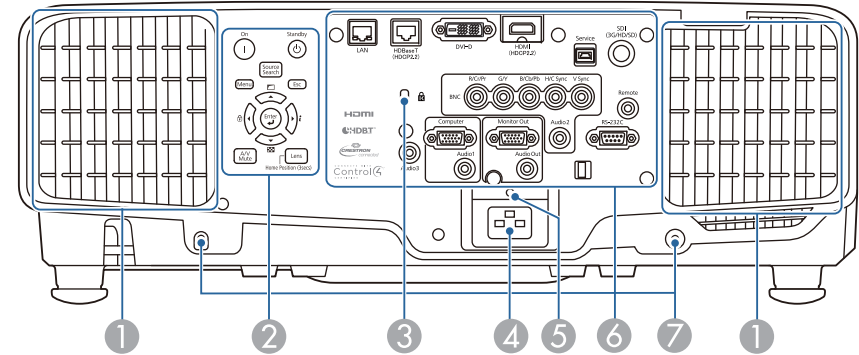

Name	Function
<p>① Air exhaust vent</p>	<p>Exhaust vent for air used to cool the projector internally.</p> <div style="border: 1px solid black; padding: 5px; margin-top: 10px;"> <p>⚠️ Caution</p> <p>While projecting, do not put your face or hands near the air exhaust vent, and do not place objects that may become warped or damaged by heat near the vent. Hot air from the air exhaust vent could cause burns, warping, or accidents to occur.</p> </div>
<p>② Control panel</p>	<p>🖱️ "Control Panel" p.20</p>
<p>③ Security slot</p>	<p>The security slot is compatible with the Microsaver Security System manufactured by Kensington. 🖱️ "Anti-Theft Lock" p.124</p>
<p>④ Power inlet</p>	<p>Connects the power cord to the projector.</p>

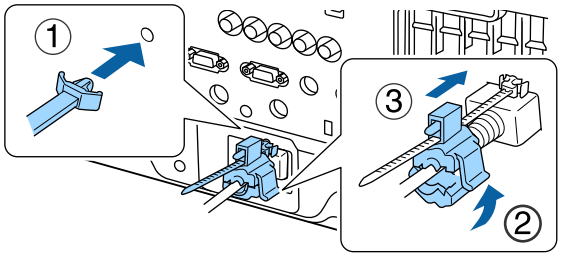
Name	Function
5 Cable holder	<p>Insert the cable clamp for the power cord so that the power cord does not disconnect under its own weight.</p> 
6 Interface	<p>☛ "Interface" p.18</p>
7 Screw holes to fix the cable cover	<p>Screw holes to fix the cable cover in place. ☛ "Attaching the Cable Cover" p.56</p>

Interface

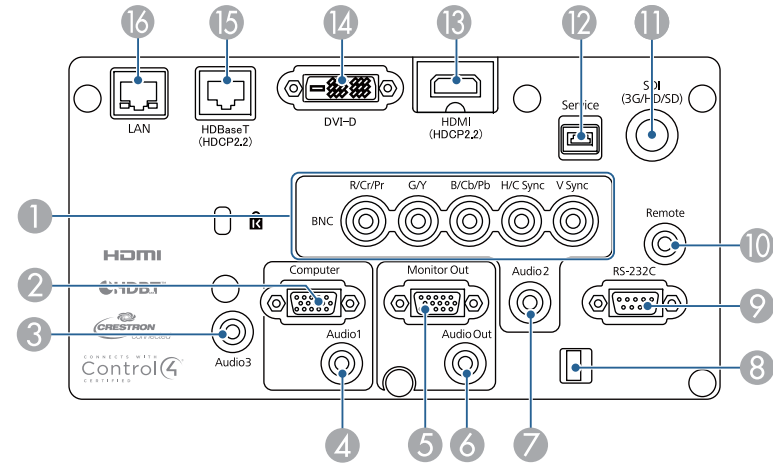

Name	Function
1 BNC port	For analog RGB signals from a computer and component video signals from other video sources.
2 Computer port	For analog RGB signals from a computer and component video signals from other video sources.
3 Audio3 port	Inputs audio from equipment connected to the HDMI port or the DVI-D port.
4 Audio1 port	Inputs audio from equipment connected to the Computer port.
5 Monitor Out port	Outputs to an external monitor the analog signal from the computer connected to the Computer port or the BNC port. You cannot output signals input from other ports or component video signals.
6 Audio Out port	Outputs audio from the currently projected image to an external speaker.
7 Audio2 port	Inputs audio from equipment connected to the BNC port.
8 Cable holder	Run a commercially available cable tie to secure cables.

Name	Function
9 RS-232C port	When controlling the projector from a computer, connect it to the computer with an RS-232C cable. This port is for control use and should not normally be used. ☛ "ESC/VP21 Commands" p.228
10 Remote port	Connects the optional remote control cable set and inputs signals from the remote control. When the remote control cable is plugged into the Remote port, the remote receiver on the projector is disabled. ☛ "Optional Accessories" p.240
11 SDI input port (EB-L1755U/EB-L1750U/EB-L1505UH/EB-L1500UH only)	Inputs SDI signals from video equipment.
12 Service port	This is used for batch settings. This port is for control use and should not normally be used. ☛ "Batch Setup" p.168
13 HDMI port	Inputs video signals from HDMI compatible video equipment and computers.
14 DVI-D port	Inputs the computer DVI-D signals.
15 HDBaseT port	Connects a LAN cable to the optional HDBaseT Transmitter. ☛ "Connecting an HDBaseT Transmitter" p.54 ☛ "Optional Accessories" p.240
16 LAN port	Connects a LAN cable to connect to a network. Supports Art-Net. ☛ "Art-Net" p.235

Base

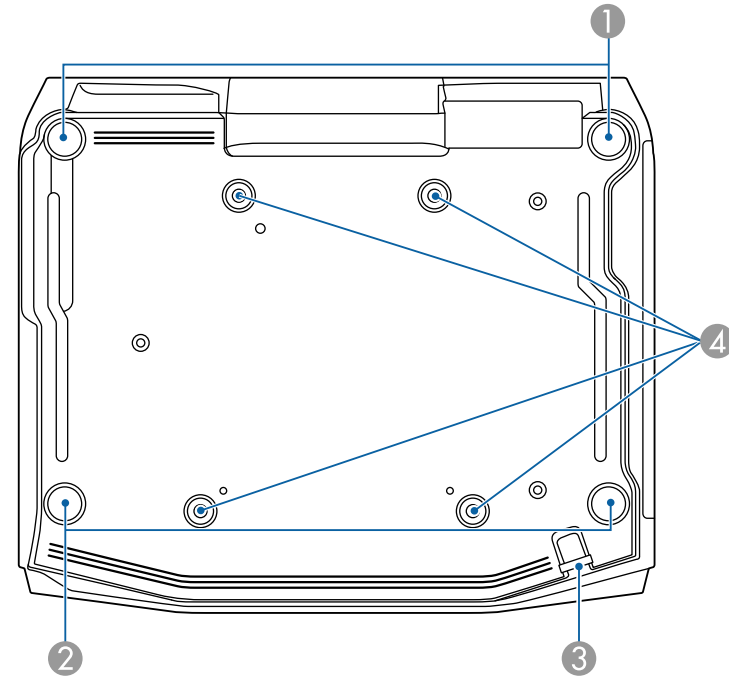

Name	Function
1 Front adjustable feet	When setup on a surface such as a desk, extend and retract the feet to adjust the projector's vertical and horizontal tilt. ☛ "Adjusting the Height of the Projected Image (for Normal Installment)" p.42 ☛ "Adjusting the Horizontal Tilt (for Normal Installment)" p.43
2 Rear feet	When setup on a surface such as a desk, turn to extend and retract to adjust the horizontal tilt. ☛ "Adjusting the Horizontal Tilt (for Normal Installment)" p.43

Name	Function
③ Security cable installation point	Pass a commercially available wire lock through here and lock it in place. ☛ "Installing the wire lock" p.124
④ Ceiling mount fixing points (four points)	Attach the optional ceiling mount here when suspending the projector from a ceiling. ☛ "Installing the Projector" p.28 ☛ "Optional Accessories" p.240

Control Panel

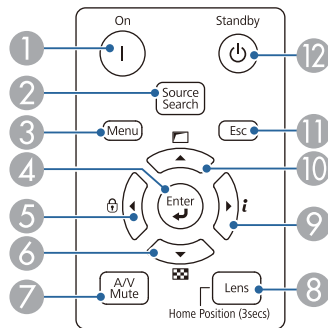







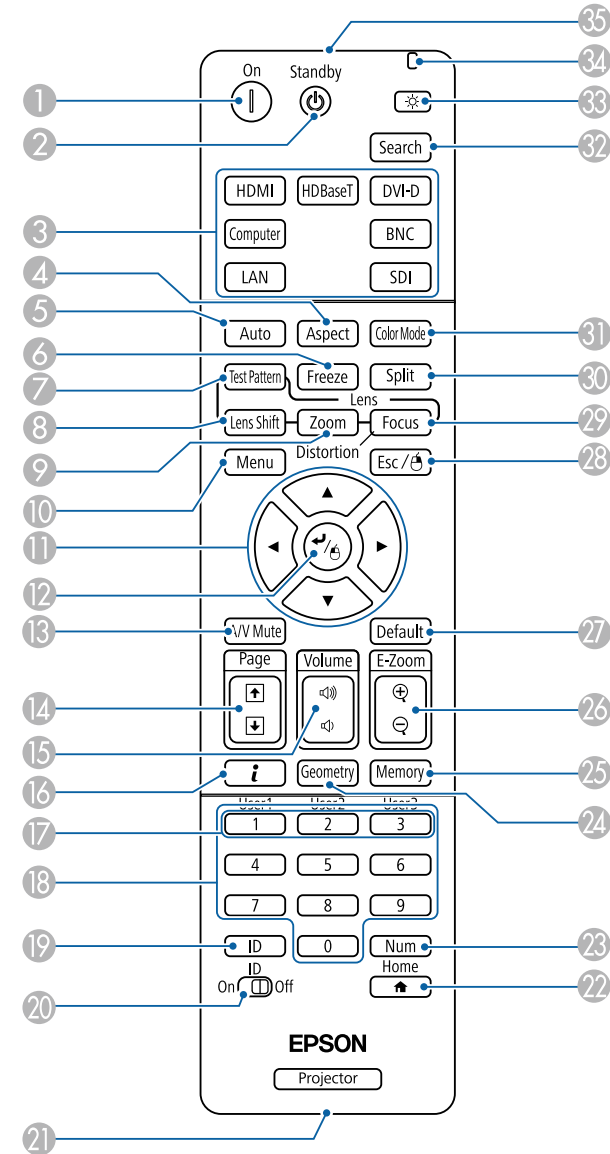

Name	Function
① [①] button	Turns the projector on.
② [Source Search] button	Changes to the next input source that is sending an image. ☛ "Automatically Detecting Input Signals and Changing the Projected Image (Source Search)" p.62
③ [Menu] button	Displays and closes the Configuration menu. ☛ "Using the Configuration Menu" p.140









Name	Function
④ [↵] button	<ul style="list-style-type: none"> When the Configuration menu or the Help screen is displayed, it accepts and enters the current selection and moves to the next level. If pressed while projecting analog RGB signals from the Computer port or the BNC port, you can automatically optimize Tracking, Sync., and Position.
⑤ [◀]/[⏸] buttons	<ul style="list-style-type: none"> Displays the Control Panel Lock screen allowing you to make settings to lock the control panel buttons. ☛ "Restricting Operation" p.122 If pressed when the Configuration menu or the Help screen is displayed, this button selects menu items and setting values. ☛ "Using the Configuration Menu" p.140 ☛ "Using the Help" p.176
⑥ [▼]/[⏏] buttons	<ul style="list-style-type: none"> Displays a test pattern. ☛ "Displaying a Test Pattern" p.32 If pressed when the Configuration menu or the Help screen is displayed, this button selects menu items and setting values. ☛ "Using the Configuration Menu" p.140 ☛ "Using the Help" p.176
⑦ [A/V Mute] button	Turns the video and audio on or off. ☛ "Hiding the Image and Sound Temporarily (A/V Mute)" p.110
⑧ [Lens] button	Displays the adjustment screens for lens shift, zoom, focus, and distortion in that order each time the button is pressed. If pressed for more than three seconds, the lens position moves to the home position.

Name	Function
9 [▶]/[i] buttons	<ul style="list-style-type: none"> Displays the Info menu from the Configuration menu. <ul style="list-style-type: none"> "Info Menu (Display Only)" p.165 If pressed when the Configuration menu or the Help screen is displayed, this button selects menu items and setting values. <ul style="list-style-type: none"> "Using the Configuration Menu" p.140 "Using the Help" p.176
10 [▲]/[□] buttons	<ul style="list-style-type: none"> Performs screen adjustments using the settings in Geometry Correction from the Configuration menu. <ul style="list-style-type: none"> Settings - Geometry Correction p.148 If pressed when the Configuration menu or the Help screen is displayed, this button selects menu items and setting values. <ul style="list-style-type: none"> "Using the Configuration Menu" p.140 "Using the Help" p.176
11 [Esc] button	<ul style="list-style-type: none"> Stops the current function. If pressed when the Configuration menu is displayed, it moves to the previous menu level. <ul style="list-style-type: none"> "Using the Configuration Menu" p.140
12 [⏻] button	Turns the projector off.

Remote Control



Name	Function
① [⏻] button	Turns the projector on.
② [⏻] button	Turns the projector off.
③ Change input buttons	Changes to images from each input port.  "Switching to the Target Image by Remote Control" p.63 The [SDI] button only functions for EB-L1755U/EB-L1750U/EB-L1505UH/EB-L1500UH.
④ [Aspect] button	Each time the button is pressed, the aspect mode changes.  "Changing the Aspect Ratio of the Projected Image" p.81
⑤ [Auto] button	If pressed while projecting analog RGB signals from the Computer port or the BNC port, you can automatically optimize Tracking, Sync., and Position.
⑥ [Freeze] button	Images are paused or unpaused.  "Freezing the Image (Freeze)" p.111
⑦ [Test Pattern] button	Displays a test pattern.  "Displaying a Test Pattern" p.32
⑧ [Lens Shift] button	Press to adjust the lens shift.  "Adjusting the Position of the Projected Image (Lens Shift)" p.34 If pressed for more than three seconds, the lens position moves to the home position.
⑨ [Zoom] button	Press to adjust the zoom.  "Adjusting the Image Size" p.38
⑩ [Menu] button	Displays and closes the Configuration menu.  "Using the Configuration Menu" p.140

Name	Function
⑪ [▲][▼][◀][▶] buttons	<ul style="list-style-type: none"> Press to adjust focus, zoom, distortion, and lens shift. <ul style="list-style-type: none">  "Adjusting the Position of the Projected Image (Lens Shift)" p.34  "Adjusting the Image Size" p.38  "Correcting the Focus" p.39 When the Configuration menu or the Help screen is displayed, pressing these buttons selects menu items and setting values. <ul style="list-style-type: none">  "Using the Configuration Menu" p.140 When using the optional wireless mouse receiver, pressing these buttons moves the pointer.
⑫ [↵] button	<ul style="list-style-type: none"> When the Configuration menu or the Help screen is displayed, it accepts and enters the current selection and moves to the next level. <ul style="list-style-type: none">  "Using the Configuration Menu" p.140 Acts as a mouse's left button when using the optional wireless mouse receiver.
⑬ [A/V Mute] button	Turns the video and audio on or off.  "Hiding the Image and Sound Temporarily (A/V Mute)" p.110
⑭ [Page] buttons [⏪][⏩]	<ul style="list-style-type: none"> Press to change the test pattern while a test pattern is displayed. Moves to the previous or next image file when projecting images from a computer connected via a network. When using the optional wireless mouse receiver, you can change the PowerPoint file page during projection by pressing the page up/page down buttons.
⑮ [Volume] buttons [⏮][⏭]	[⏮] Decreases the volume. [⏭] Increases the volume.  "Adjusting the Volume" p.64
⑯ [i] button	Displays the Info menu from the Configuration menu.  "Info Menu (Display Only)" p.165

Name	Function
17 [User1] button [User2] button [User3] button	Select any frequently used item from the Configuration menu items, and assign it to any of these buttons. By pressing the button, the assigned menu item selection/adjustment screen is displayed, allowing you to make one-touch settings/adjustments. ☛ "Settings Menu" p.148
18 Numeric buttons	<ul style="list-style-type: none"> Enter the Password. ☛ "Setting Password Protection" p.120 Use this button to enter numbers in Network settings from the Configuration menu.
19 [ID] button	Hold down this button and press the numeric buttons to select the ID for the projector you want to operate using the remote control. ☛ "ID Settings" p.43
20 [ID] switch	Use this switch to enable (On)/disable (Off) ID settings for the remote control. ☛ "ID Settings" p.43
21 Remote port	Connects the optional remote control cable set and outputs signals from the remote control. ☛ "Optional Accessories" p.240 When the remote control cable is plugged into this remote port, the remote control light-emitting is disabled.
22 [🏠] button	Displays and closes the Home screen. ☛ "Home Screen" p.59
23 [Num] button	Hold down this button and press the numeric buttons to enter passwords and numbers. ☛ "Setting Password Protection" p.120
24 [Geometry] button	Corrects distortion in the projected image. ☛ "Correcting Distortion in the Projected Image" p.65
25 [Memory] button	Performs operations and makes settings for the memory function. ☛ "Memory Function" p.114

Name	Function
26 [E-Zoom] buttons [⊕][⊖]	Enlarges or reduces the image without changing the projection size. ☛ "Enlarging Part of the Image (E-Zoom)" p.112
27 [Default] button	Enabled when [Default]: Reset is displayed on the configuration menu guide. The settings being adjusted are returned to their default values. ☛ "Using the Configuration Menu" p.140
28 [Esc] button	<ul style="list-style-type: none"> Stops the current function. If pressed when the Configuration menu is displayed, it moves to the previous level. ☛ "Using the Configuration Menu" p.140 Acts as a mouse's right button when using the optional wireless mouse receiver.
29 [Focus] button	Each time the button is pressed, the adjustment screens for focus and distortion are displayed in that order. ☛ "Correcting the Focus" p.39
30 [Split] button	Each time the button is pressed, the image changes between projecting two images simultaneously by splitting the projected screen, or projecting one image as normal. ☛ "Projecting Two Images Simultaneously (Split Screen)" p.107
31 [Color Mode] button	Each time the button is pressed, the Color Mode changes. ☛ "Selecting the Projection Quality (Selecting Color Mode)" p.77
32 [Search] button	Changes to the next input source that is sending an image. ☛ "Automatically Detecting Input Signals and Changing the Projected Image (Source Search)" p.62
33 [☀️] button	Illuminates the buttons on the remote control for approximately 15 seconds. This is useful when using the remote control in the dark.
34 Indicator	A light is emitted when outputting remote control signals.

Name	Function
35 Remote control light-emitting area	Outputs remote control signals.

Handy remote control operations

You can perform the following operations by simply pressing one of the buttons on the remote control.

Operation	Set
Reverse the projected image vertically. (Switch the Projection between Front and Front/Ceiling) ☛ "Changing the direction of the image (projection mode)" p.30	Hold down the [A/V Mute] button for more than five seconds.
Selecting the password security settings. ☛ "Managing Users (Password Protection)" p.120	Hold down the [Freeze] button for more than five seconds. The Password Protection screen is displayed, and you can select various settings.
Locking or unlocking some of the operation of the buttons on the remote control. ☛ "Remote control button lock" p.123	Hold down the [
Initializing the settings for the Remote Receiver in the Configuration menu. (Enables all Remote receivers for this projector.)	Hold down the [Menu] button for more than 15 seconds.

Operation	Set
Displaying frequently used Configuration menu items.	Press the [User1], [User2], or [User3] button. You can set the menu item you want to assign to each button in User Button . ☛ Settings - User Button p.148 The following items can be assigned. Light Source Mode, Multi-Projection, Resolution, Image Processing, On-Screen Display, Display the QR Code, Image Enhancement, Frame Interpolation, Screen Matching, Color Calibration When you press the button for which On-Screen Display is assigned, menus or messages are not displayed on the screen. When the same button is pressed, they are displayed again. If On-Screen Display is enabled, you cannot operate the Configuration menu (except for switching the color mode and input source).

Replacing the remote control batteries

If delays in the responsiveness of the remote control occur or if it does not operate after it has been used for some time, it probably means that the batteries are becoming flat. When this happens, replace them with new batteries. Have two AA size alkaline or manganese batteries ready. You cannot use other batteries except for the AA size alkaline or manganese.

Attention

Make sure you read the following manual before handling the batteries.

☛ [Safety Instructions](#)

- 1** Remove the battery cover.
While pushing the battery compartment cover catch, lift the cover up.

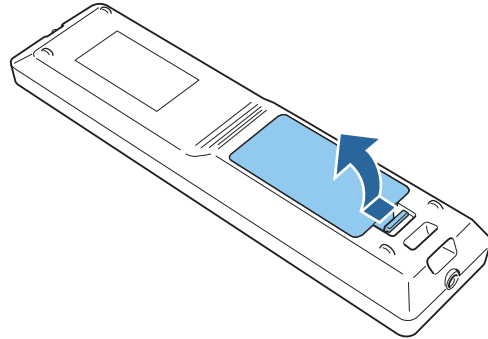

- 2** Replace the old batteries with new batteries.

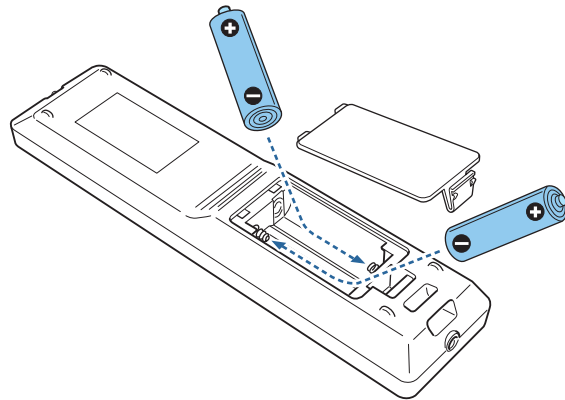

Caution

Check the positions of the (+) and (-) marks inside the battery holder to ensure the batteries are inserted the correct way.

If the batteries are not used correctly, they could explode or leak causing a fire, injury, or damage to the product.

- 3** Replace the battery cover.
Press the battery compartment cover until it clicks into place.

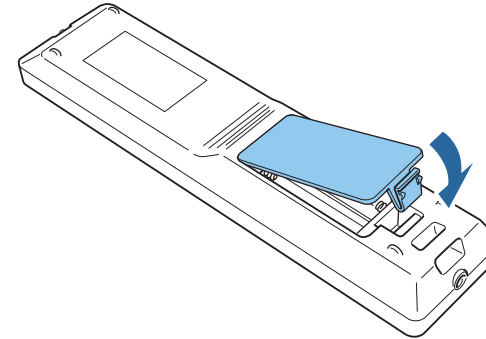

Remote control operating range

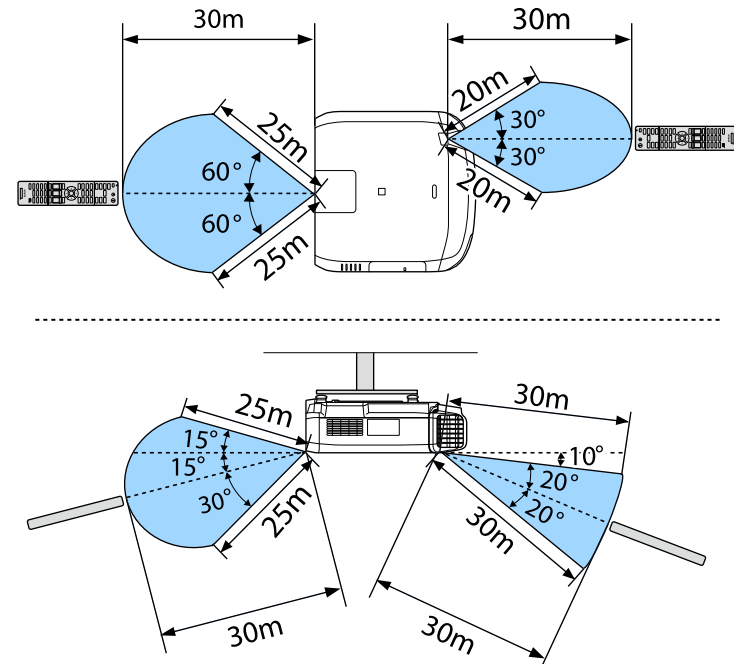



To restrict reception of the operation signals from the remote control, set **Remote Receiver**.

☛ **Settings - Remote Receiver** [p.148](#)

Connecting a cable to the remote control

You can make operations securely with the optional remote control cable set when you use multiple units of this projector in the same place or when there are obstacles around the remote receiver.

☛ "Optional Accessories" [p.240](#)

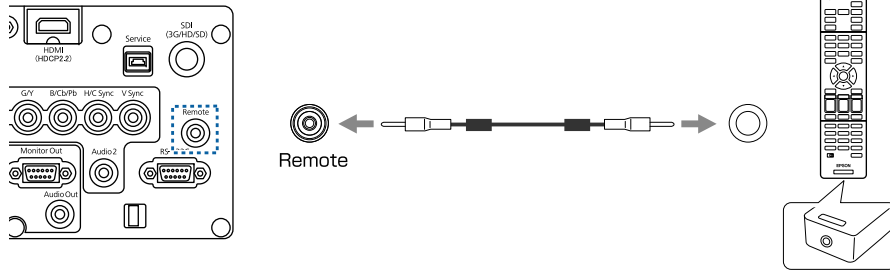

- When the remote control cable is plugged into the Remote port, the remote receiver on the projector is disabled.
 - You can also connect the optional HDBaseT transmitter and remote control with the cable to control the projector.
- ☛ "Connecting an HDBaseT Transmitter" [p.54](#)



Preparing the Projector

This chapter explains how to install the projector and connect projection sources.

Removing and Attaching the Projector Lens Unit

Attaching

Attention

- When attaching the lens unit, remove the power plug from the electrical outlet first.
- Do not attach the lens unit when the projector's lens insertion section is facing up. Dust or dirt could enter the projector.
- Try not to touch the lens section with your hand or fingers. If fingerprints or oils are left on the surface of the lens, projection quality deteriorates.



- The projector supports lens with the following model numbers. ELPLX02, ELPLU03, ELPLU04, ELPLW05, ELPLW06, ELPLM09, ELPLM10, ELPLM11, ELPLM15, ELPLL08, ELPLS04, ELPLU02, ELPLR04, ELPLW04, ELPLM06, ELPLM07, ELPLL07

When using the following lens, set the **Lens Type** in the Configuration menu according to the lens you are using so that distortion correction is performed correctly.

ELPLS04, ELPLU02, ELPLR04, ELPLW04, ELPLM06, ELPLM07, ELPLL07

 **Extended - Operation - Advanced - Lens Type** [p.150](#)

- In a normal installation, the image may be tilted depending on your lens. Adjust the tilt of the image using the front and rear feet.
 "Adjusting the Horizontal Tilt (for Normal Installment)" [p.43](#)
- For information on installing ELPLX02, see the User's Guide supplied with ELPLX02.

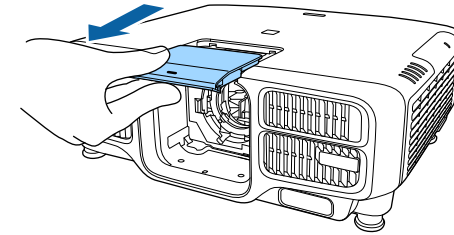

- 2** Hold the lock lever and turn it counterclockwise.

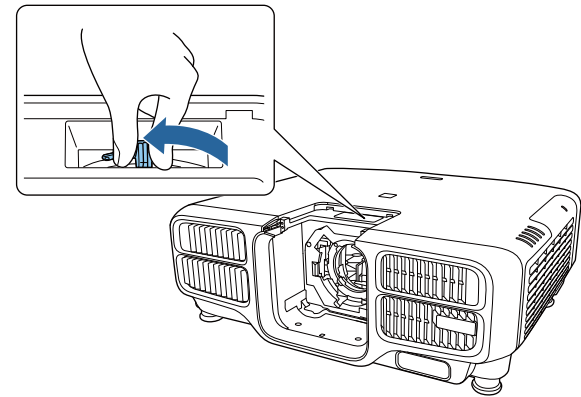

When using the following lens, attach the supplied lens connector cap to protect the port.

ELPLS04, ELPLU02, ELPLR04, ELPLW04, ELPLM06, ELPLM07, ELPLL07

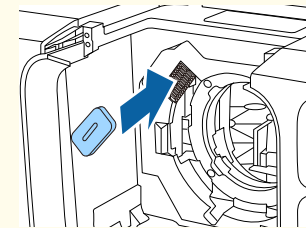

- 1** Pull the lens replacement cover straight out.

- 3** Insert the lens unit straight into the lens insertion section with the white circle on the lens on top.

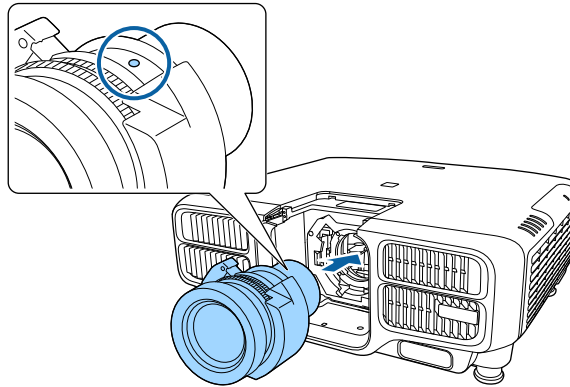

- 4** While holding the lens unit firmly, hold the lock lever and turn it clockwise to lock the lens unit.
Check that the lens cannot be detached.

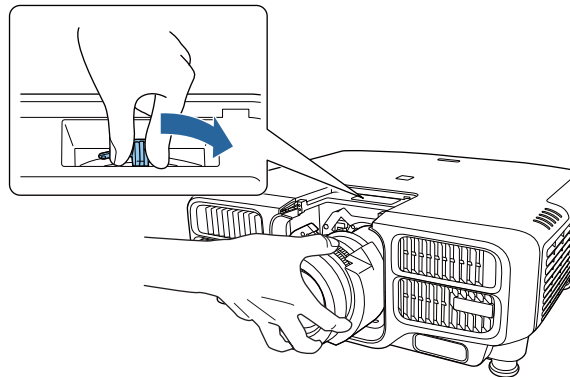

- 5** Attach the lens replacement cover.

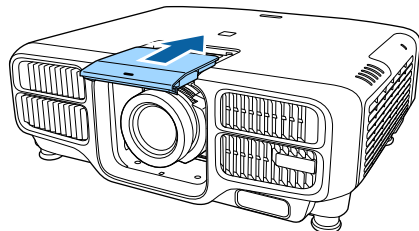

Lens Calibration

After replacing the lens unit, calibrate the lens so that the projector can correctly acquire the lens position and adjustment range.

After attaching a different lens unit from the previous one, a message is displayed when the projector is turned on.

Select **Yes** to calibrate the lens.

Lens calibration takes up to about 100 seconds until it is complete. When it is complete, the lens position returns to the position before the calibration (ELPLX02 returns to the standard position).

Attention

If the message "Lens Calibration failed." is displayed, stop using the projector, remove the power plug from the electrical outlet, and contact your local dealer or the nearest address provided in the Epson Projector Contact List.

☛ [Epson Projector Contact List](#)



- You can perform lens calibration using one of the following methods.
 - Press the [Default] button on the remote control for three seconds or more.
 - Configuration Menu
 - ☛ **Extended - Operation - Lens Calibration** p.150
- If no message is displayed after attaching the lens unit, perform lens calibration from the Configuration menu.
- If you do not calibrate the lens, the following functions may not operate correctly.
Focus, Distortion, Zoom, Lens Shift, Memory (Lens Position)

Removing

Attention

When replacing the lens unit, remove the power plug from the electrical outlet first. If the lens shift has been done, move the lens position to the home position before replacing the lens unit.

☛ "Adjusting the Position of the Projected Image (Lens Shift)" [p.34](#)



The projector uses a laser as the light source. As a safety measure, the light source turns off when the lens is removed. Attach the lens, and then press the [①] button to turn it back on.

- 1 Pull the lens replacement cover straight out.

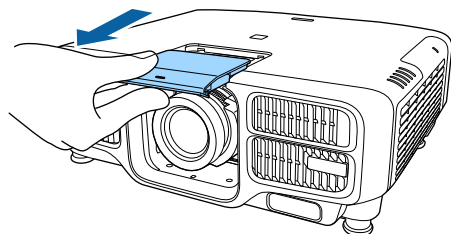

- 2 While holding the lens unit firmly, hold the lock lever and turn it counterclockwise to unlock the lens unit.
Pull the lens unit straight out as it is released.

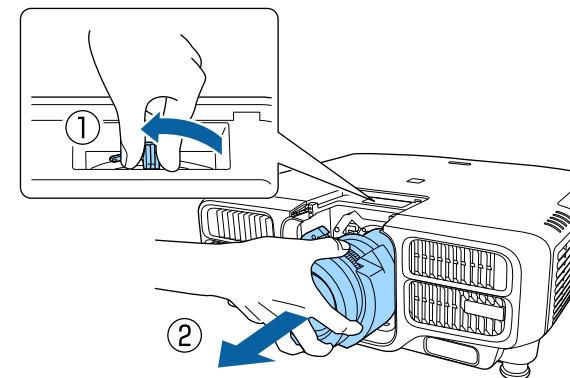

Installation Settings

Changing the direction of the image (projection mode)

You can change the direction of the image using **Projection** mode from the Configuration menu.

☛ **Extended - Projection** [p.150](#)

When Front is the standard, the image directions for each projection mode are as follows.

Front (default)



Rear

Front/Ceiling



Rear/Ceiling



- You can change the setting as follows by pressing down the [A/V Mute] button on the remote control for about five seconds.
Front ↔ Front/Ceiling
Rear ↔ Rear/Ceiling
- To rotate the menu display, set **OSD Rotation** in the Configuration menu.
☛ **Extended - Display - OSD Rotation** p.150
- When suspending the projector from a ceiling, set the **Inv Direction Button** to **On** so that the [▲], [▼], [◀], and [▶] buttons on the control panel operate in the correct direction.
☛ **Extended - Operation - Advanced - Inv Direction Button** p.150

Screen Settings

Set the Screen Type according to the aspect ratio of the screen being used. The area where the image is displayed matches the shape of the screen.



The settings for the **Screen Type** at the time of purchase are as follows:

- WUXGA projector: **16:10**
- SXGA+ projector: **4:3**

- Press the [Menu] button while projecting.
☛ "Using the Configuration Menu" p.140
- Select **Display** from **Extended**.
- Select **Screen Type** from **Screen**.
- Select the screen's aspect ratio.
The shape of the background test pattern changes depending on the setting.

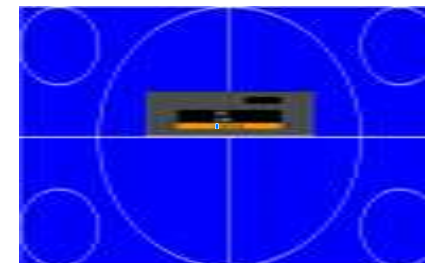

- Press the [Menu] button to finish making settings.



- When you change the Screen Type, adjust the aspect ratio for the projected image as well.
 - ☛ "Changing the Aspect Ratio of the Projected Image" [p.81](#)
- The Message Broadcasting function for Epson Projector Management does not support this function.

Adjusting the position of the image on the projected screen

You can adjust the position of the image if there are margins between the edge of the image and the projected screen frame due to the Screen Type setting.

Example: When the **Screen Type** is set to **4:3** for the WUXGA/WXGA projector

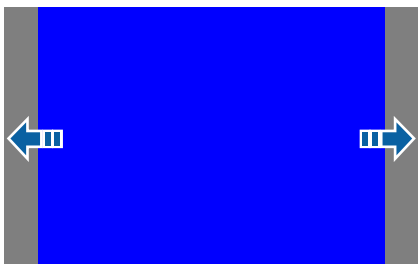

You can move the image to the left and right.

- 1** Press the [Menu] button while projecting.
 - ☛ "Using the Configuration Menu" [p.140](#)
- 2** Select **Display** from **Extended**.
- 3** Select **Screen Position** from **Screen**.

- 4** Use the [▲], [▼], [◀], and [▶] buttons to adjust the position of the image.

You can check the current display position by using the background test pattern.



- 5** Press the [Menu] button to finish making settings.



The **Screen Position** cannot be adjusted in the following situations.

- If you are using a WUXGA projector and the **Screen Type** is set to **16:10**
- If you are using an SXGA+ projector and the **Screen Type** is set to **4:3**

Displaying a Test Pattern

A test pattern can be displayed to adjust the projection status without connecting video equipment.

The shape of a test pattern is according to the setting of **Screen Type**. Set **Screen Type** first.

☛ "Screen Settings" [p.31](#)

- 1** Press the [Test Pattern] button of the remote control or the [⏏] button on the control panel while projecting.

2 Press the [◀][▶] buttons on the remote control or the [↵] button on the control panel to change the test pattern.



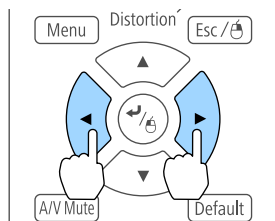

Using the remote control

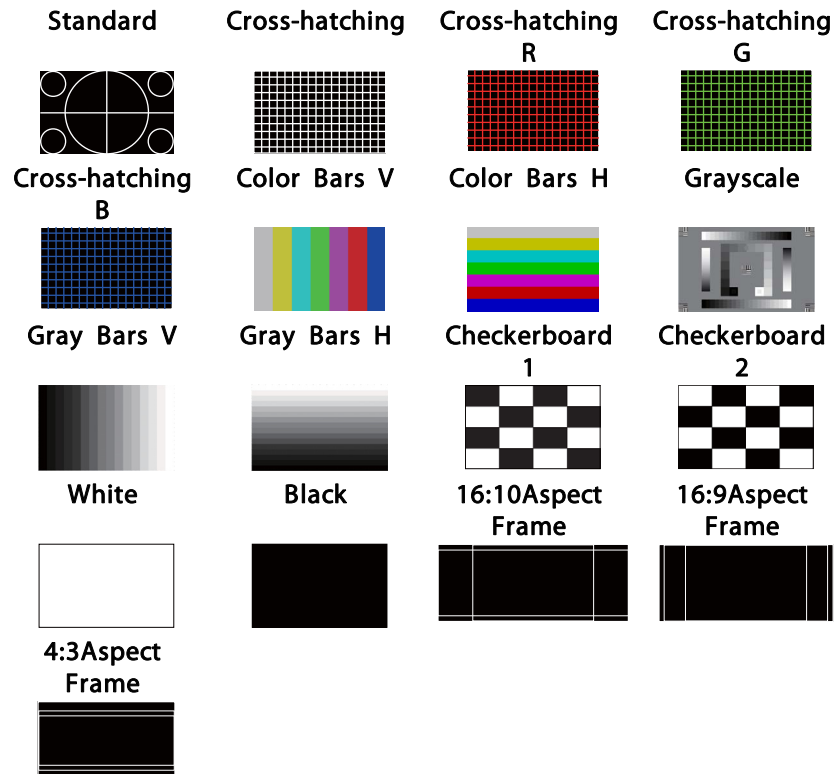
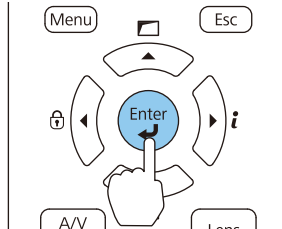

Using the control panel



In addition to lens operations, the following image adjustments can be made while the test pattern is being displayed.

Top Menu Name	Sub Menu/Items
Image	Color Mode  p.77
	White Balance
	Advanced - Gamma*1  p.85 - RGBCMY  p.84
	Reset
Set	Geometry Correction  p.65 Brightness Settings

Top Menu Name	Sub Menu/Items
Extended	Display*2 Color Calibration Multi-Projection*3  p.93

*1 Except for custom settings of gamma

*2 Except for Screen, Panel Alignment, and Color Uniformity

*3 Except for Black Level, Scale, Color Uniformity, and Color Adjustment



- To set menu items that cannot be set while the test pattern is being displayed or to fine-tune the projected image, project an image from the connected device.
- During image adjustment, press the [↑][↓] [Page] buttons on the remote control to change the test pattern.
- You can also select a test pattern from the Configuration menu.
 -  **Settings - Test Pattern** [p.148](#)

3 Press the [Esc] button to close the test pattern.

Adjusting the Position of the Projected Image (Lens Shift)

The lens can be shifted to adjust the position of the projected image, for example, when the projector cannot be installed directly in front of the screen.

The ranges within which the image can be moved are shown below. The position of the projected image cannot be moved to both the horizontal and vertical maximum values.

EB-L1755U/EB-L1750U/EB-L1505UH/EB-L1500UH

When using the ELPLU03/ELPLW05

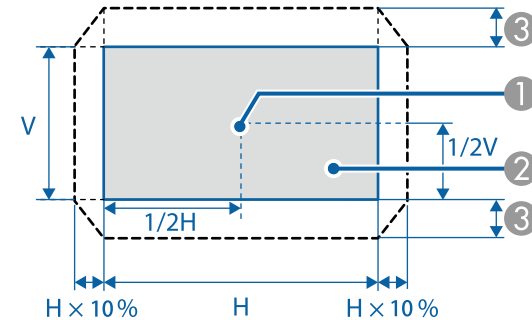

- ① Center of lens
- ② Projected image when the lens position is moved to the home position
- ③ Maximum motion range: $V \times 24\%^*$

* When the horizontal direction is at the maximum value, the image cannot be moved vertically.

When using the ELPLU04/ELPLW06/ELPLM09/ELPLM10/ELPLM11/
ELPLM15/ELPLL08

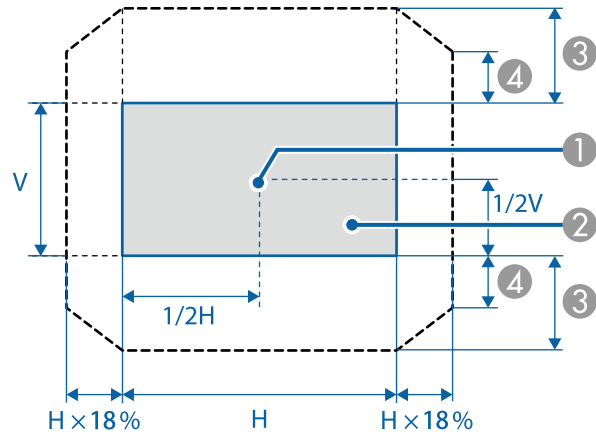

- ① Center of lens
- ② Projected image when the lens position is moved to the home position
- ③ Maximum motion range: $V \times 60\%$
- ④ When the horizontal direction is at the maximum value: $V \times 31\%$

When using the ELPLX02

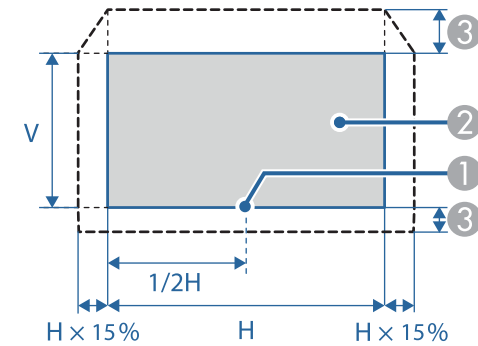

- ① Center of lens
- ② Projected image when the lens position is moved to the home position
- ③ Maximum motion range: $V \times 20\%$ (Top), $V \times 5\%$ (Bottom)*

* When the horizontal direction is at the maximum value, the image cannot be moved upward.

EB-L1715S/EB-L1710S/EB-L1515S/EB-L1510S

When using the ELPLU03/ELPLW05

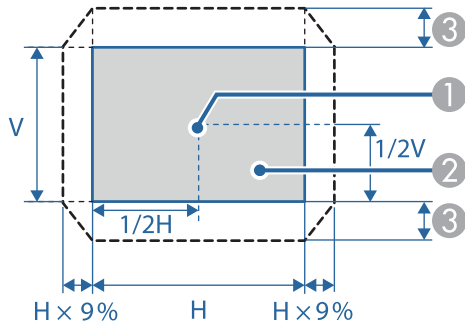

- ① Center of lens
- ② Projected image when the lens position is moved to the home position
- ③ Maximum motion range: $V \times 16\%$ *

* When the horizontal direction is at the maximum value, the image cannot be moved vertically.

When using the ELPLU04/ELPLW06/ELPLM09/ELPLM10/ELPLM11/ELPLM15/ELPLL08

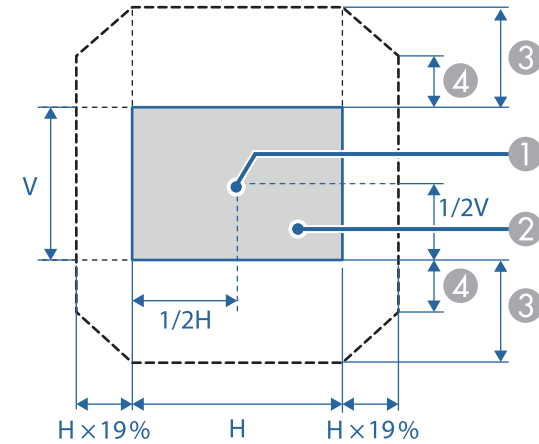

- ① Center of lens
- ② Projected image when the lens position is moved to the home position
- ③ Maximum motion range: $V \times 55\%$ *
- ④ When the horizontal direction is at the maximum value: $V \times 32\%$

* When performing screen matching or color calibration: $V \times 45\%$ (ELPLU04)

When using the ELPLX02

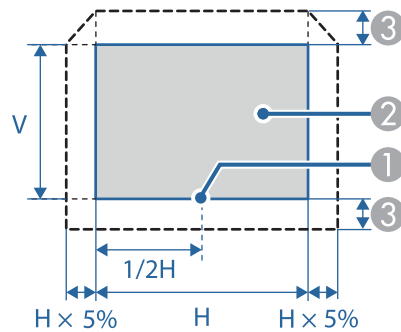

- ① Center of lens
- ② Projected image when the lens position is moved to the home position
- ③ Maximum motion range: $V \times 5\%$ *

* When the horizontal direction is at the maximum value, the image cannot be moved upward.



- When adjusting the image height with the vertical lens shift, adjust by moving the image from the bottom to the top. If it is adjusted from the top to the bottom, the image position may move down slightly after adjusting.
- We recommend setting the focus, zoom, and lens shift at least 20 minutes after you start the projection. After projecting videos, we recommend waiting for more than 20 minutes to make settings for the Focus/Zoom/Lens Shift.
- The image will be clearest when the lens position is moved to the home position.
- If you hold down the [Lens Shift] button on the remote control or the [Lens] button on the control panel for at least three seconds, the lens position moves to the home position.
- If you set **A/V Output** to **Always On**, you can move the lens position to the home position even if the projector is in standby mode.
 - ☛ **Extended - A/V Settings - A/V Output** p.150
- ELPLR04 does not support lens shift.

- 1** Press the [Lens Shift] button on the remote control or the [Lens] button on the control panel.

Repeatedly press the [Lens] button on the control panel until the lens shift adjustment screen is displayed.

Using the remote control

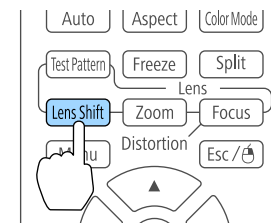

Using the control panel

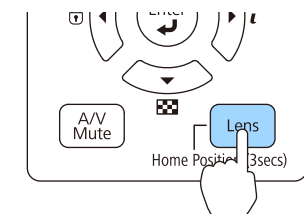

- Press the [▲][▼][◀][▶] buttons to adjust the position of the projected image.

Using the remote control

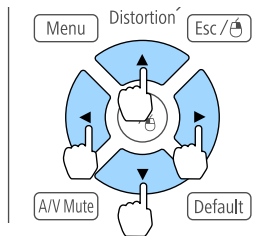

Using the control panel

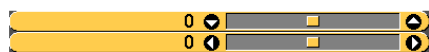
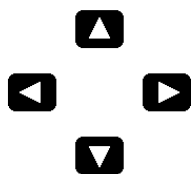
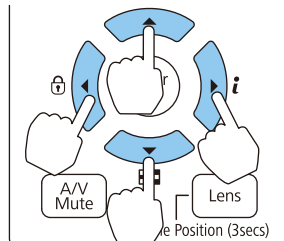

The displayed screen may differ depending on your lens.

- Press the [Esc] button to finish the adjustment.

Adjusting the Image Size



This is not available for ELPLX02 and ELPLR04.

- Press the [Zoom] button on the remote control or the [Lens] button on the control panel.

Repeatedly press the [Lens] button on the control panel until the zoom adjustment screen is displayed.

Using the remote control

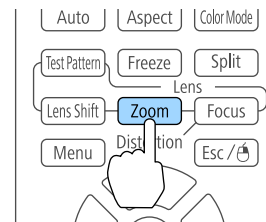

Using the control panel

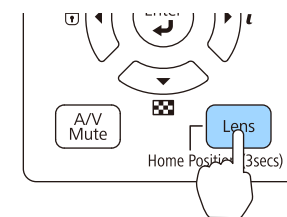

- Press the [◀][▶] buttons to adjust.

Using the remote control

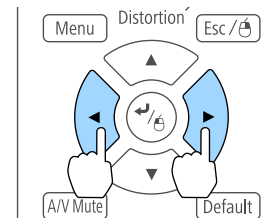

Using the control panel

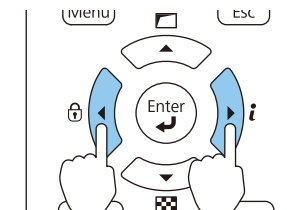

The displayed screen may differ depending on your lens.

- Press the [Esc] button to finish the adjustment.

Correcting the Focus

- 1 Press the [Focus] button or the [Lens] button on the control panel.

Repeatedly press the [Lens] button on the control panel until the focus adjustment screen is displayed.

Using the remote control

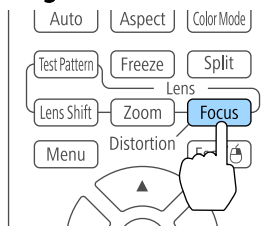

Using the control panel

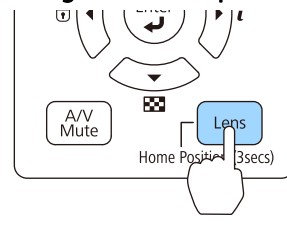

- 2 Press the [◀][▶] buttons to adjust.

Using the remote control

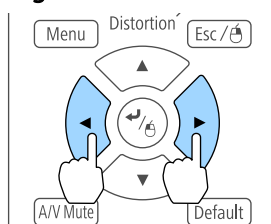

Using the control panel

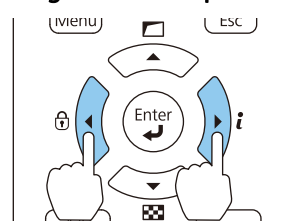

The displayed screen may differ depending on your lens.



When using the following lens, a message prompting you to adjust the distortion (image warping) is displayed. After adjusting the focus, adjust the distortion.

ELPLX02, ELPLU03, ELPLU04, ELPLW05, ELPLU02

☞ "Correcting Distortion (Image Warping)" p.39

- 3 Press the [Esc] button to finish the adjustment.

Correcting Distortion (Image Warping)

When using a short throw zoom lens and focusing at the center of the screen, the surrounding image may warp and be out of focus. Follow the steps below to correct the warping.

- 1 Press the [Focus] button on the remote control or the [Lens] button on the control panel.

Repeatedly press the [Lens] button on the control panel until the focus adjustment screen is displayed.

- 2 Press the [◀][▶] buttons to focus the image around the center of the lens.

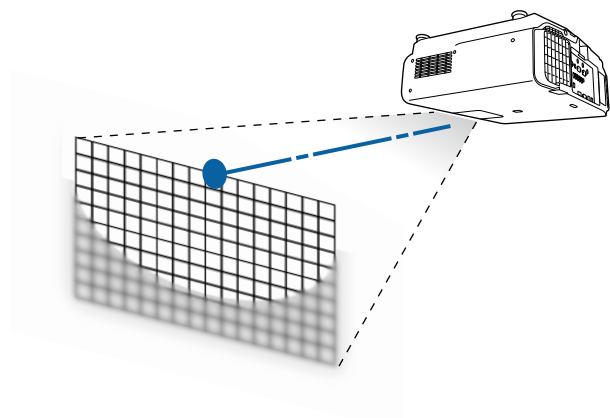

- 3** Press the [Focus] button on the remote control or the [Lens] button on the control panel again.
Repeatedly press the [Lens] button on the control panel until the distortion adjustment screen is displayed.
- 4** Press the [◀][▶] button to adjust the focus of the surrounding area.

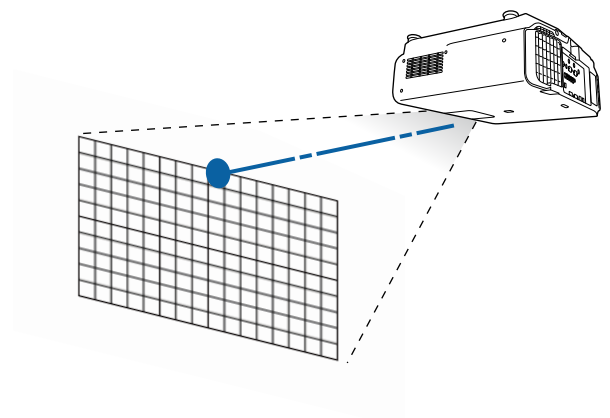

When using the ELPLU02, a message prompting you to manually adjust the distortion is displayed. Turn the distortion ring counterclockwise, and then adjust the focus. After adjusting the focus, manually turn the distortion ring to correct the image warping.

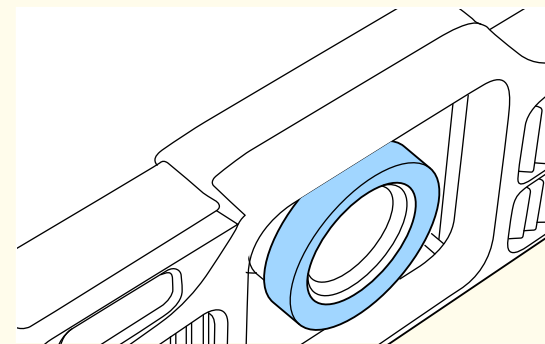

Registering and Loading Lens Adjustment Values

You can register a lens position whose lens shift, zoom, focus, and distortion was adjusted in memory, and load it when necessary. You can register up to 10 values.



- This feature cannot be used if the following lenses are attached. ELPLS04, ELPLU02, ELPLR04, ELPLW04, ELPLM06, ELPLM07, ELPLL07
 - If you did not calibrate your lens, a message is displayed when you save a memory. Select **Yes** to calibrate the lens.
 - The lens position when a memory is loaded may not completely match the lens position when the memory was saved.
 - If there is a large discrepancy between the lens position when a memory is loaded and the lens position when the memory was saved, calibrate the lens.
- ☛ **Extended - Operation - Lens Calibration** [p.150](#)

1 Press the [Memory] button while projecting.

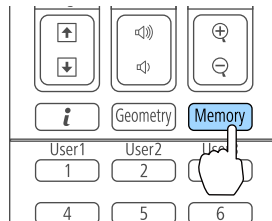

You can also operate from the Configuration menu.
☛ **Settings - Memory** [p.148](#)

2 Select **Lens Position**, and then press the [**↵**] button.

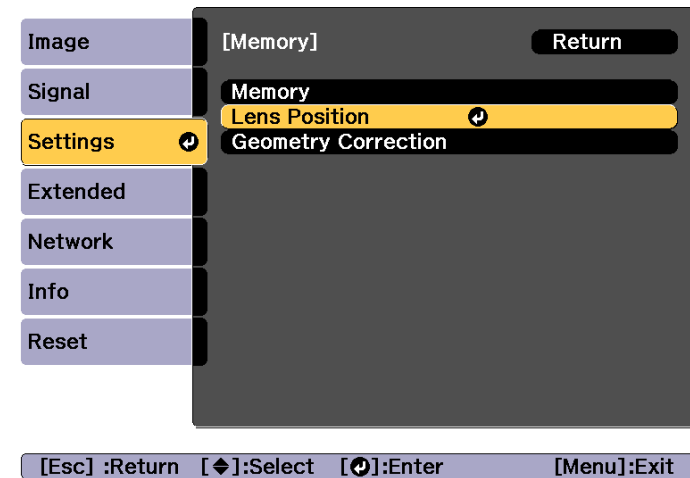

3 Select the function you want to perform, then press the [**↵**] button.

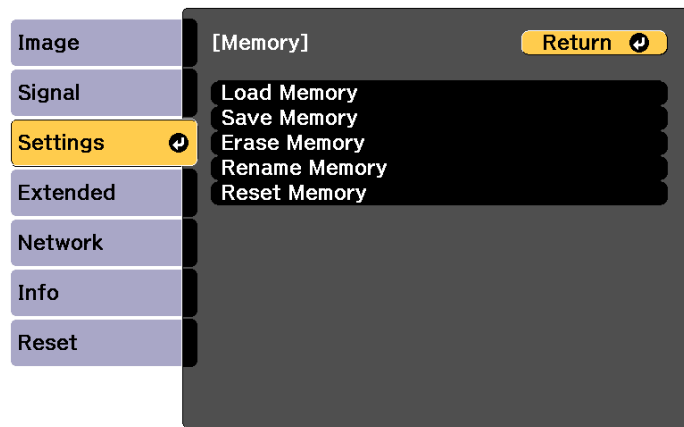

[Esc] / [Return]:Return [Left Arrow]:Select [Menu]:Exit

Function	Explanation
Load Memory	Loads the saved memory. When you select a memory name and press the [Left Arrow] button, the lens is automatically adjusted according to the settings of the selected memory.
Save Memory	Registers current settings in the memory. When you select a memory name and press the [Left Arrow] button, the settings are saved.
Erase Memory	Erases the registered memory. When you select a memory name and press the [Left Arrow] button, a message is displayed. Select Yes , and then press the [Left Arrow] button to erase the selected memory.
Rename Memory	Changes the memory name. Select the memory name you want to change, and then press the [Left Arrow] button. Enter the memory name using the soft keyboard. 🖱️ "Soft keyboard operations" p.157 When you have finished, move the cursor over Finish , and then press the [Left Arrow] button.

Function	Explanation
Reset Memory	Resets the name and settings of a saved memory.

 If the mark on the left of the memory name is turned blue, it means the memory has already been registered. When you select a registered memory, a message is displayed asking you to confirm that you want to overwrite the memory. If you select **Yes**, the previous settings are deleted and the current settings are registered.

Adjusting the Height of the Projected Image (for Normal Installation)

Extend or retract the front feet to make adjustments. You can adjust the position of the image by tilting the projector up to 10 degrees.

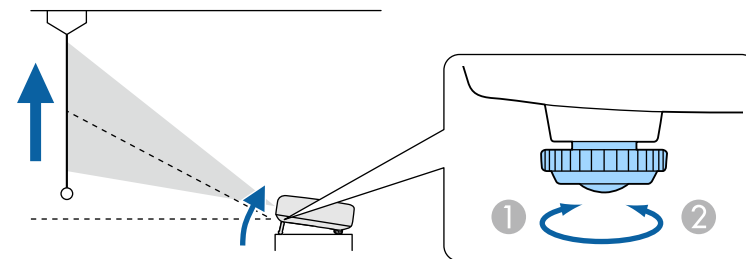

- ① Extend the front feet.
- ② Retract the front feet.

 The larger the angle of tilt, the harder it becomes to focus. Install the projector so that it only needs to be tilted at a small angle.

Adjusting the Horizontal Tilt (for Normal Installation)

Extend and retract the front and rear feet to adjust the projector's horizontal tilt.

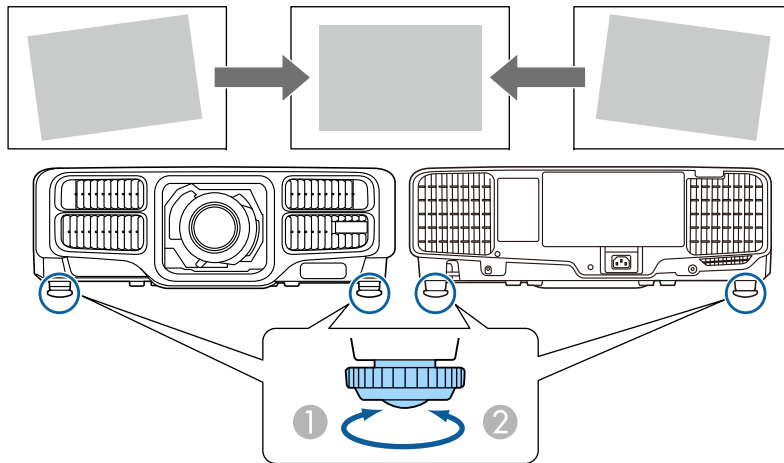

- ① Extend the front and rear feet.
- ② Retract the front and rear feet.

ID Settings

When an ID is set for the projector and the remote control, you can use the remote control to operate only the projector with a matching ID. This is very useful when managing multiple projectors. You can set up to 30 IDs.



- Operation using the remote control is possible only for projectors that are within the operating range of the remote control.
 - ☛ "Remote control operating range" [p.25](#)
- When **Remote Control Type** is set to **Simple** in the configuration menu, you cannot set the remote control ID.
 - ☛ **Extended - Operation - Advanced - Remote Control Type** [p.150](#)
- IDs are ignored when the projector ID is set to **Off** or the remote control ID is set to **0**.
- If you use Epson Web Control, you can operate a specific projector from a mobile device.
 - ☛ "Changing Settings Using a Web Browser (Epson Web Control)" [p.218](#)

Set the projector ID

- 1** Press the [Menu] button while projecting.
 - ☛ "Using the Configuration Menu" [p.140](#)
- 2** Select **Multi-Projection** from **Extended**.
- 3** Select **Projector ID**, and then press the [↵] button.
- 4** Press the [◀][▶] buttons to select an ID number.

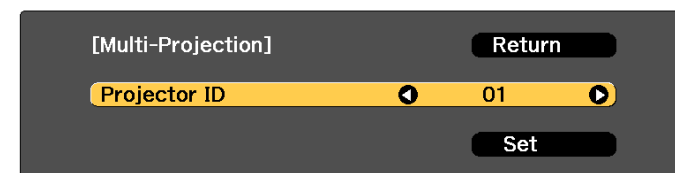

[Esc] :Return [◀▶]:Select

[Menu]:Exit

- 5** Select **Set**, and then press the [**↵**] button.
- 6** Press the [Menu] button to close the Configuration menu.

Checking the projector ID

During projection, press the [**⬆**] button while holding down the [ID] button.

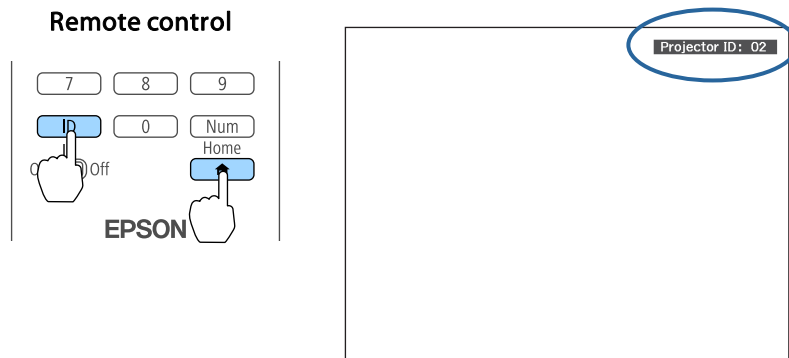

When you press the buttons, the current Projector ID is displayed on the projection screen. It disappears in about three seconds.

Setting the remote control ID

- 1** Set the remote control [ID] switch to On.

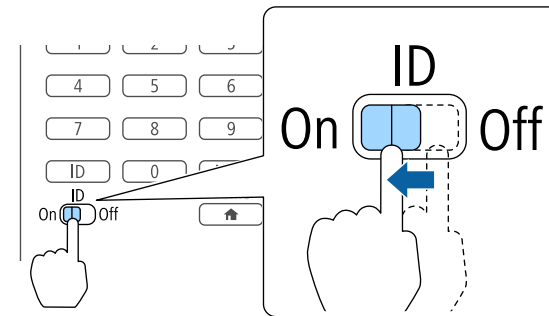

- 2** While holding the [ID] button, press a number button to select a number to match the ID of the projector you want to operate.

☛ "Checking the projector ID" p.44

Enter a two digit number (Example: 01 when the ID is 1).

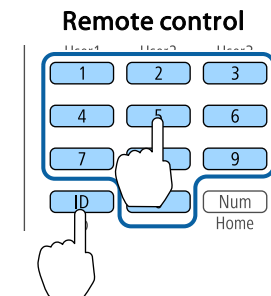

Once this setting has been made, the projector that can be operated by the remote control is limited.



The remote control ID setting is saved in the remote control. Even if the remote control batteries are removed to replace them and so on, the stored ID setting is retained. However, if the batteries are left out for a long time, it is reset to the default value (ID0).

Setting the Time

You can set the time for the projector. The set time is used for the schedule function.

☛ "Scheduling Function" [p.116](#)



- When you turn on the projector for the first time, the message "Do you want to set the time?" is displayed. When you select **Yes**, the screen from step 4 is displayed.
- When **Schedule Protection** is set to **On** in **Password Protection**, settings related to the date and time cannot be changed. You can make changes after setting **Schedule Protection** to **Off**.

☛ "Managing Users (Password Protection)" [p.120](#)

- 1 Press the [Menu] button while projecting.
☛ "Using the Configuration Menu" [p.140](#)
- 2 Select **Operation** from **Extended**.
- 3 Select **Date & Time**, and then press the [↵] button.
- 4 Make settings for the date and time.
Use the soft keyboard to enter the date and time.
☛ "Soft keyboard operations" [p.157](#)

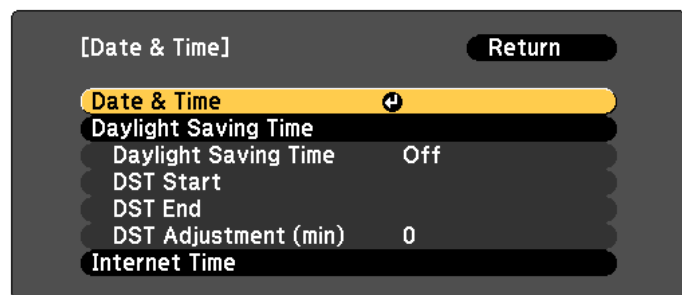

Date & Time

Submenu	Function
Date	Set today's date.
Time	Set the current time.
Time Difference (UTC)	Set the time difference from Coordinated Universal Time.
Set	The settings made in Date & Time are applied.

Daylight Saving Time

Submenu	Function
Daylight Saving Time	Set whether or not (On/Off) to activate the daylight saving time. DST Adjustment (min) adjusts the time difference between the standard time and daylight saving time.
DST Start	Set the date and time to start the daylight saving time.
DST End	Set the date and time to end the daylight saving time.
Set	The settings made in Daylight Saving Time are applied.

Internet Time

Submenu	Function
Internet Time	Set to On to update the time automatically through an Internet time server.
Internet Time Server	Input the IP address for an Internet time server.
Set	The settings made in Internet Time are applied.









When changing settings, make sure you select **Set**, and then press the [↵] button.

- 5 Press the [Menu] button to finish making settings.

Other Settings

Settings related to basic operations

Purpose	Setting Methods
To start/stop projection by turning on/off the main power or plugging in or unplugging the power plug of the projector.	Set Direct Power On to On . (Default value: Off)  Extended - Operation - Direct Power On p.150 The projector can be powered off directly by the breaker because it supports the direct shutdown function.
To disable the automatic shutdown function.	Set Sleep Mode to Off . (Default value: On)  Extended - Operation - Sleep Mode p.150 Set A/V Mute Timer to Off .  Extended - Operation - A/V Mute Settings - A/V Mute Timer p.150
To disable buzzer beeps generated when the projector is powered on/off.	Set Beep to Off . (Default value: On)  Extended - Operation - Advanced - Beep p.150
To operate the projector by communication command even when the power of the projector is off.	Set Standby Mode to Communication On . (Default value: Communication Off)  Extended - Standby Mode p.150
To operate the projector by communication command while executing A/V Mute.	Set A/V Mute Release to A/V Mute .  Extended - Operation - A/V Mute Settings - A/V Mute Release p.150 The default value is Any Button . If you operate the projector while A/V Mute is on, A/V Mute is released.
To turn off the power by pressing the [⏻] button once.	Set Standby Confirmation to Off . (Default value: On)  Extended - Display - Standby Confirmation p.150

Settings related to display

Purpose	Setting Methods
To change the menu position.	Change the settings of Menu Position . ☛ Extended - Display - Menu Position p.150
To change the menu direction.	Change the settings of OSD Rotation . ☛ Extended - Display - OSD Rotation p.150
To prevent the display of menus, messages, or warnings on the screen.	Use User Button to set On-Screen Display to User Button 1 , User Button 2 , or User Button 3 . ☛ Settings - User Button p.148 When you press the button for which On-Screen Display is assigned, menus or messages are not displayed on the screen. When the same button is pressed, they are displayed again. If On-Screen Display is enabled, you cannot operate the Configuration menu (except switching the color mode and input source).
To disable the display of the message on the projection screen when switching the source.	Set Messages to Off . (Default value: On) ☛ Extended - Display - Messages p.150 You can confirm warning by the display of the indicator. ☛ "Reading the Indicators" p.178 Dialogs related to operations and behaviors, laser warnings, termination of Message Broadcasting for Epson Projector Management, and projector ID are displayed.
To reduce the display delay of the image.	Set Image Processing to Fast 1 or Fast 2 . ☛ Signal - Advanced - Image Processing p.146

Purpose	Setting Methods
To register and save the settings of the projected image.	Set Memory . ☛ "Memory Function" p.114 You can save the following settings. <ul style="list-style-type: none"> • Memory: Some settings in the Configuration menu • Lens Position: Adjustment values of the lens shift, zoom, focus, and distortion • Geometry Correction: Adjustment value of the geometry correction
To change the screen displayed on the background.	Change from Display . You can select from blue, black, and logo. If no logo is registered, the EPSON logo is displayed. Display Background : Set the screen display with no image signal input. (Default value: Blue) ☛ Extended - Display - Display Background p.150 Startup Screen : Set whether or not (On/Off) to display the user logo when the projector is turned on. (Default value: On) ☛ Extended - Display - Startup Screen p.150

The port name, location, and connector orientation differ depending on the source being connected.

Connecting a Computer

To project images from a computer, connect the computer using one of the following methods.

① **When using a commercially available computer cable**

Connect the computer's display output port to the projector's Computer port.

You can output audio from the Audio Out port on the projector by connecting the audio output port on the computer to the projector's Audio1 port using a commercially available audio cable.

② **When using a commercially available 5BNC cable**

Connect the computer's display output port to the projector's BNC port.

You can output audio from the Audio Out port on the projector by connecting the audio output port on the computer to the projector's Audio2 port using a commercially available audio cable.

③ **When using a commercially available HDMI cable**

Connect the HDMI port on the computer to the projector's HDMI port.

You can send the computer's audio with the projected image.

④ **When using a commercially available DVI-D cable**

Connect the DVI-D port on the computer to the projector's DVI-D port.

You can output audio from the Audio Out port on the projector by connecting the audio output port on the computer to the projector's Audio3 port using a commercially available audio cable.

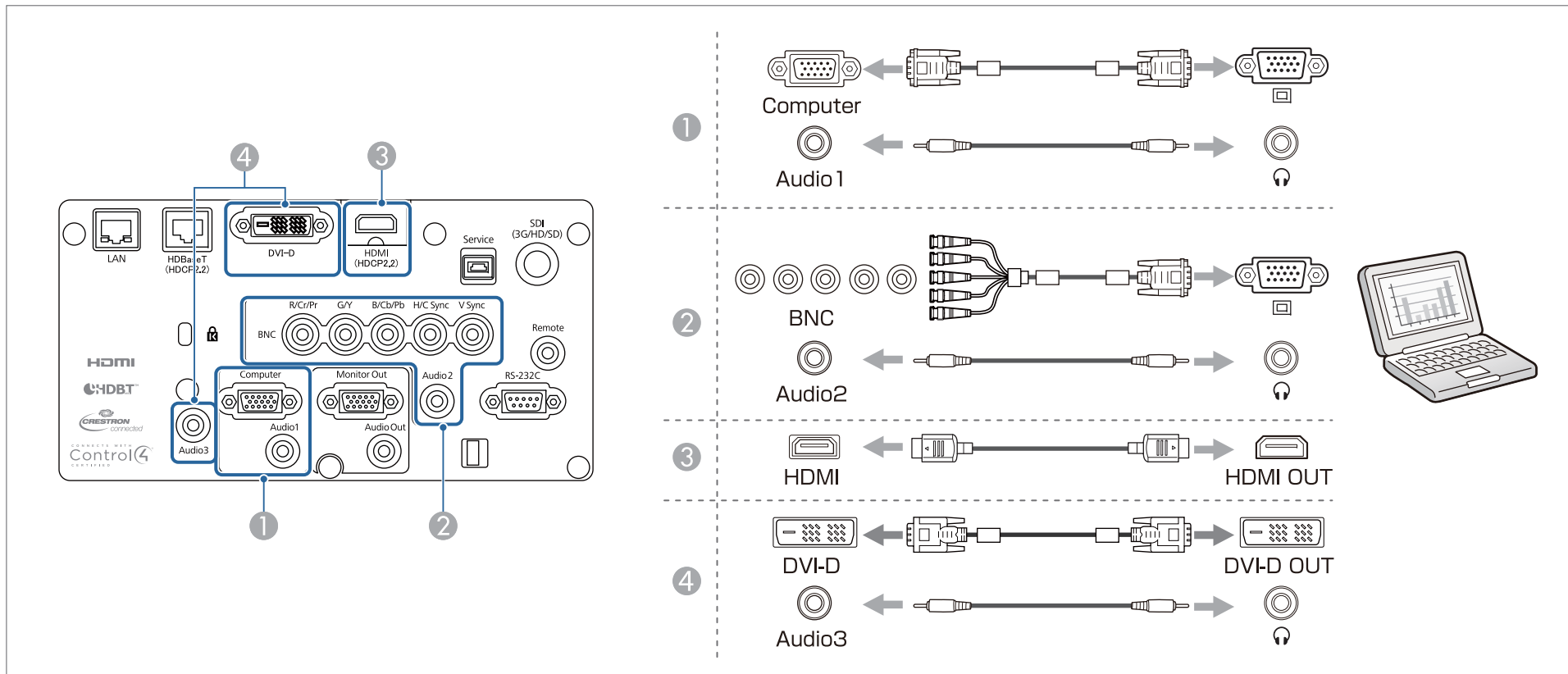

- Change the audio output from **Audio Settings**.
 ➔ **Extended - A/V Settings - Audio Settings** [p.150](#)
- If audio is not sent using an HDMI cable, connect a commercially available audio cable to the Audio3 port to send the audio. Set **HDMI Audio Output** to **Audio3**.
 ➔ **Extended - A/V Settings - Audio Settings - HDMI Audio Output** [p.150](#)

Connecting Image Sources

To project video images, connect to the projector using one of the following methods.

① **When using an optional component video cable (D-sub/component converter)**

☛ "Optional Accessories" [p.240](#)

Connect the component output port on the image source to the projector's Computer port.

You can output audio from the Audio Out port on the projector by connecting the audio output port on the video equipment to the projector's Audio1 port using a commercially available audio cable.

② **When using a commercially available component video cable (RCA) and a BNC/RCA adapter**

Connect the component output port on the video equipment to the projector's BNC port (R/Cr/Pr, G/Y, B/Cb/Pb).

You can output audio from the Audio Out port on the projector by connecting the audio output port on the video equipment to the projector's Audio2 port using a commercially available audio cable.

③ **When using a commercially available BNC video cable (SDI input, EB-L1755U/EB-L1750U/EB-L1505UH/EB-L1500UH only)**

Connect the SDI port on the image source to the projector's SDI input port.

Audio output is not supported.

④ **When using a commercially available HDMI cable**

Connect the HDMI port on the image source to the projector's HDMI port.

You can send the image source's audio with the projected image.

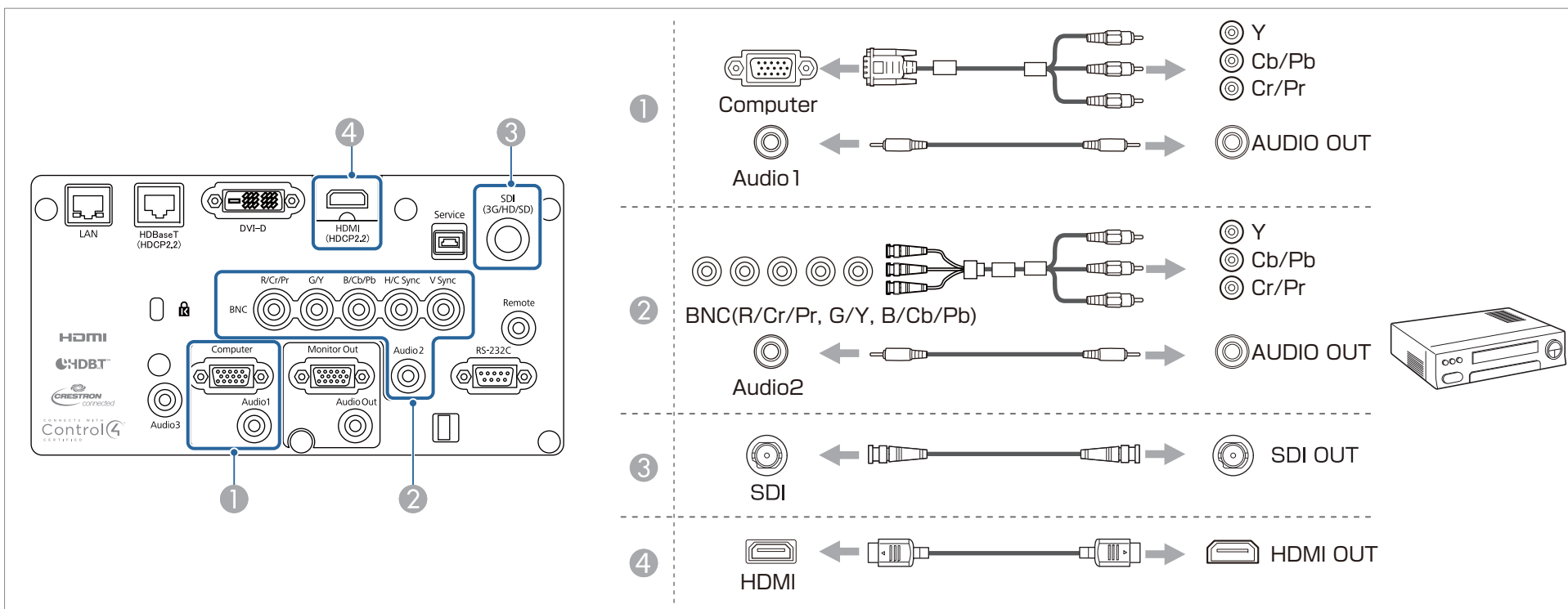

Attention

- If the input source is on when you connect it to the projector, it could cause a malfunction.
- If the orientation or shape of the plug differs, do not try to force it in. The device could be damaged or could malfunction.



- Change the audio output from **Audio Settings**.
 ➤ **Extended - A/V Settings - Audio Settings** [p.150](#)
- If audio is not sent using an HDMI cable, connect a commercially available audio cable to the Audio3 port to send the audio. Set **HDMI Audio Output** to **Audio3**.
 ➤ **Extended - A/V Settings - Audio Settings - HDMI Audio Output** [p.150](#)
- If the source you want to connect to has an unusually shaped port, use the cable supplied with the device or an optional cable to connect to the projector.

Connecting External Equipment

You can output images and audio by connecting an external monitor or speaker.

1 When outputting images to an external monitor

Connect the external monitor to the projector's Monitor Out port using the cable supplied with the external monitor.

2 When outputting audio to an external speaker

Connect the external speaker to the projector's Audio Out port using a commercially available audio cable.

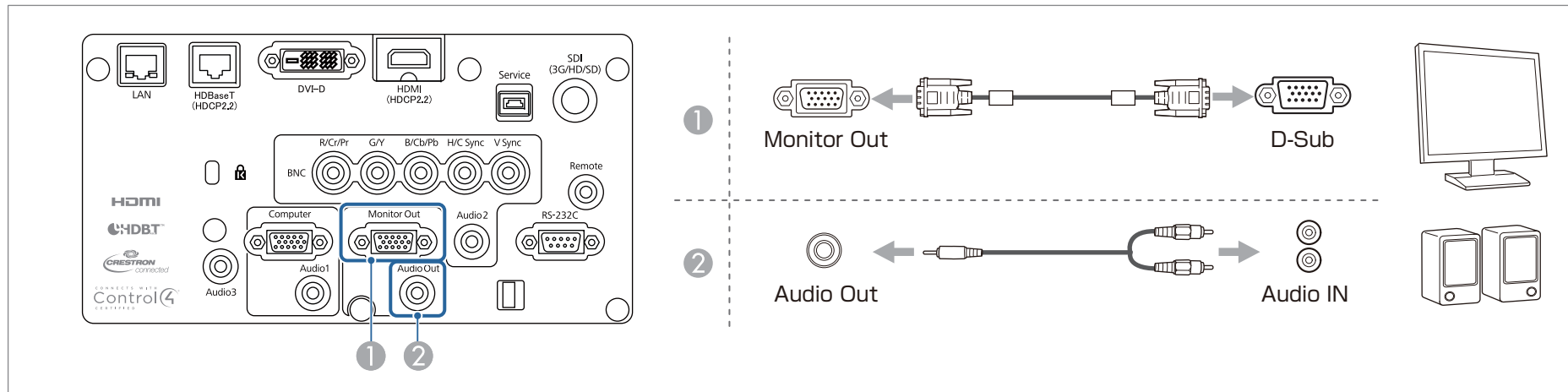

- Set **A/V Output** to **Always On** to output image even when the projector is in standby mode.
 - ☛ **Extended - A/V Settings - A/V Output p.150**
- Only analog RGB signals from the Computer port or BNC port can be output to an external monitor. You can set which signals to output in **Monitor Out**.
 - ☛ **Extended - A/V Settings - Monitor Out p.150**

Connecting a LAN Cable

Connect a LAN port on network hubs or other equipment to the projector's LAN port with a commercially available 100BASE-TX or 10BASE-T LAN cable.

By connecting a computer to the projector over a network, you can project images and check the status of the projector.

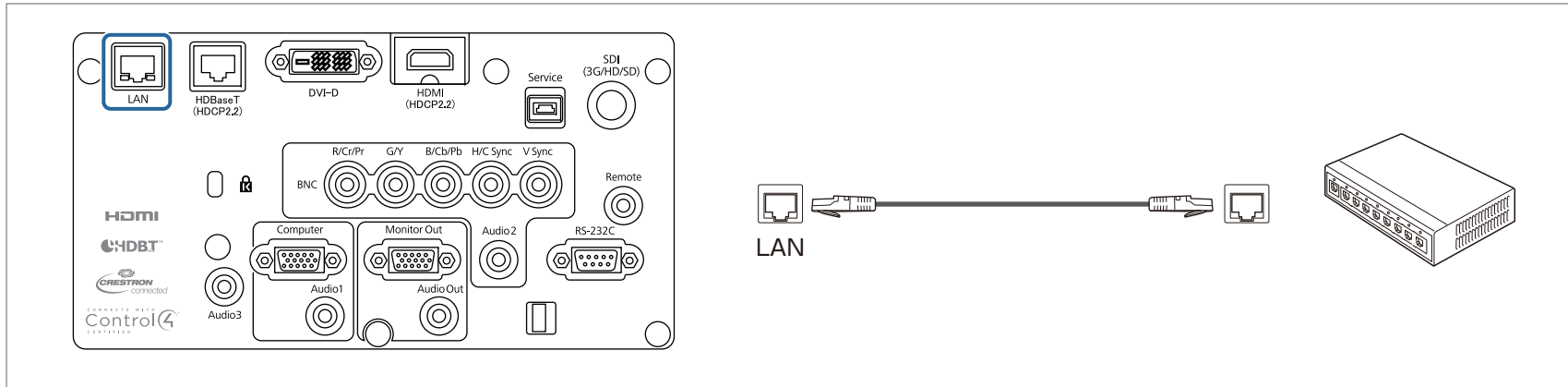

To prevent malfunctions, use a category 5 or higher shielded LAN cable.

Connecting an HDBaseT Transmitter

Connect the optional HDBaseT Transmitter with a commercially available 100BASE-TX LAN cable.

☛ "Optional Accessories" [p.240](#)

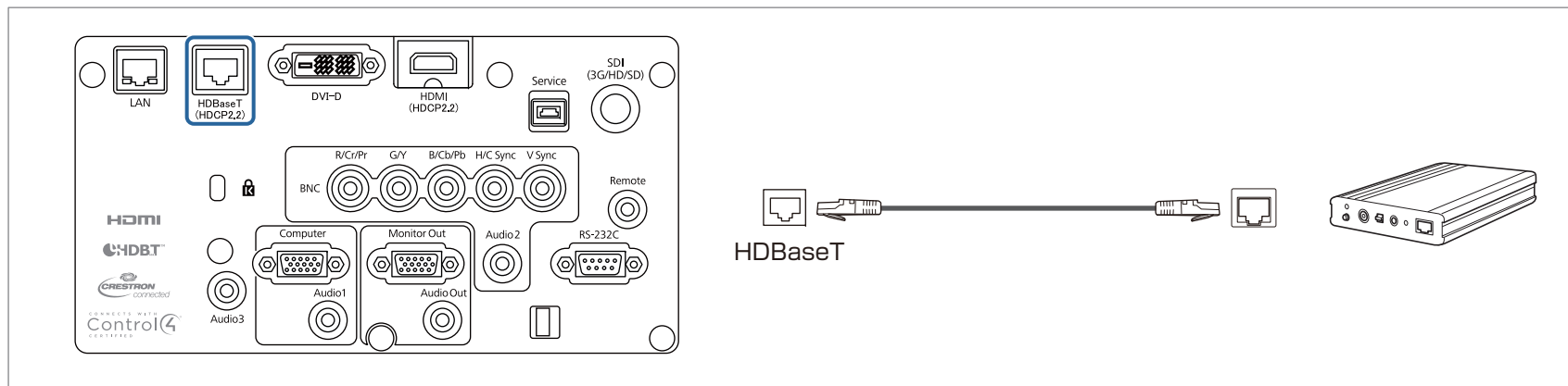

- Make sure you read the User's Guide supplied with the HDBaseT Transmitter carefully before use.
- For the LAN cable, use an HDBaseT Alliance-recommended STP cable (straight) of category 5e or higher. However, operation is not guaranteed for all input/output devices and environments.
- When connecting or disconnecting the LAN cable, make sure you turn off the power for the projector and the HDBaseT Transmitter.
- When performing Ethernet communication or serial communication, or when using the wired remote control via HDBaseT port, set **Control Communications** to **On** from the Configuration menu.
 - ☛ **Extended - HDBaseT - Control Communications** [p.150](#)

Note that when **Control Communications** is set to **On**, the projector's LAN port, RS-232C port, and Remote port are disabled.
- When using the Extron XTP transmitter or switcher, connect to the projector's HDBaseT port. Set **Extron XTP** to **On (Standby Mode and Control Communications)** are automatically set to **On**.
 - ☛ **Extended - HDBaseT - Extron XTP** [p.150](#)

Installing the Wireless LAN Unit

- 1** Remove the air filter cover.
Grip the air filter cover tab between your fingers, and pull up and remove the cover while pressing the tab.

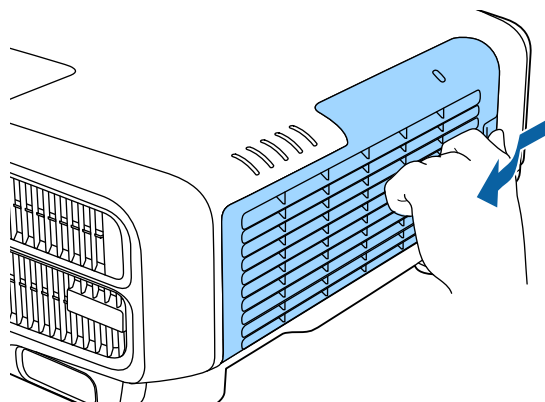

- 2** Remove the stopper for the Wireless LAN unit.

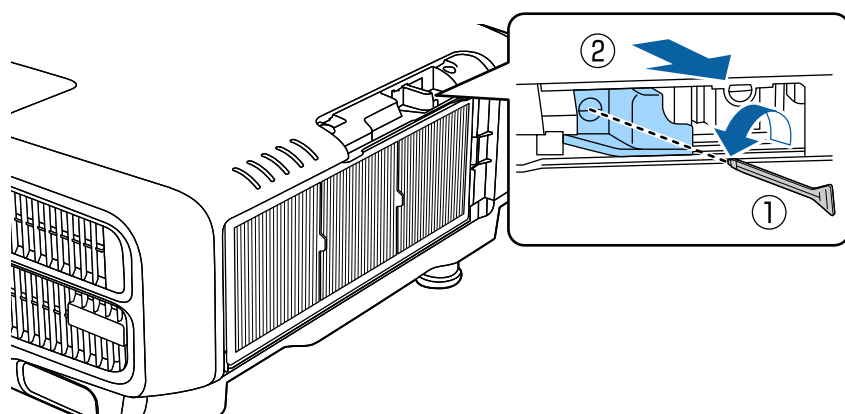

- 3** Install the Wireless LAN unit.

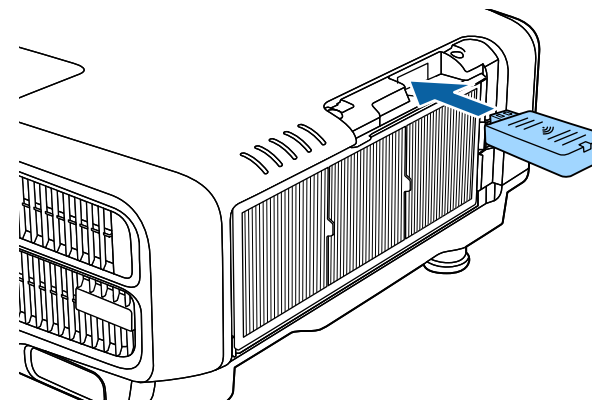

- 4** Secure the stopper with a screw.

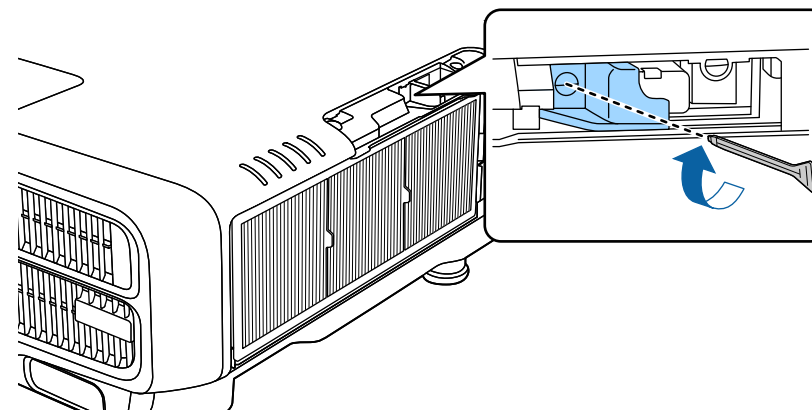

- 5** Attach the air filter cover.

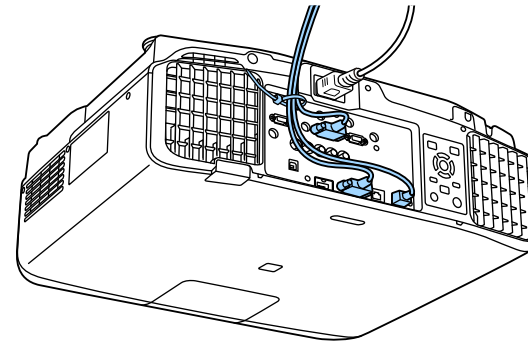
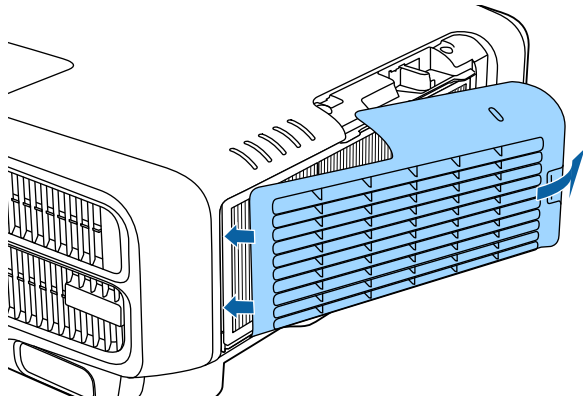

- 2** Insert the tabs on the cable cover into the two slots on the back of the projector.

Attaching the Cable Cover

By attaching the cable cover, you can hide the connected cables giving a nice, clean finish to the projector installation. (The illustrations are of a projector installed on a ceiling.)

Warning

Do not tie the power cord and other connection cables together. Otherwise, it could cause a fire.

Attaching

- 1** Run a commercially available cable tie through the cable holder and tie the cables together.

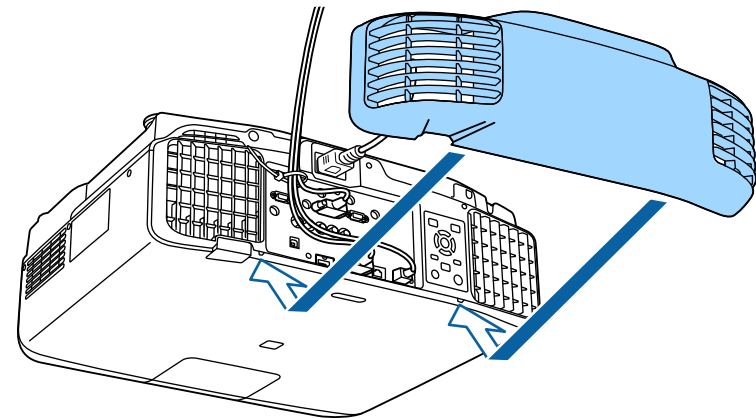

- 3** Tighten the two screws on the cable cover. (You can tighten the screws with your fingers.)

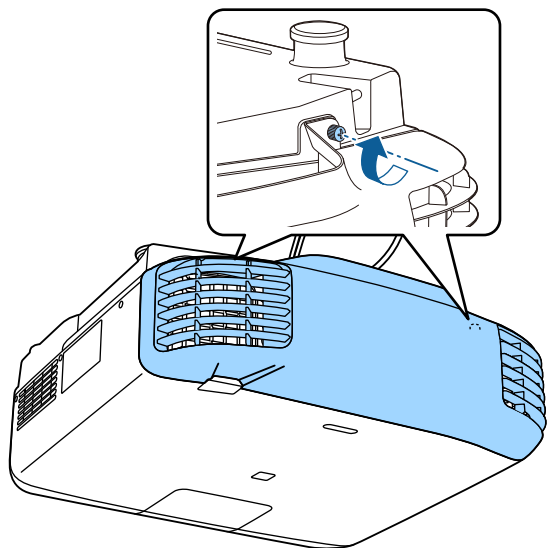



Basic Usage

This chapter explains how to project and adjust images.

Before turning on the projector, connect your computer or video equipment to the projector.

☛ "Connecting Equipment" [p.48](#)

- 1** Connect the projector to an electrical outlet with the power cord.

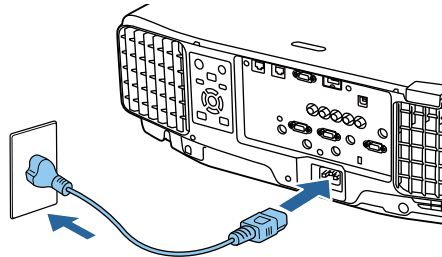

The projector's power indicator turns blue (it is in standby mode). This indicates that the projector is receiving power, but is not yet turned on.

- 2** Press the **[I]** button on the control panel or remote control to turn on the projector.

The confirmation buzzer beeps and the status indicator flashes blue as the projector warms up. Once the projector is warmed up, the status indicator stops flashing and turns blue.

If the image is not projected, try the following.

- Turn on the connected computer or video equipment.
- When using a laptop computer, change the screen output of the computer.
- Insert media such as a DVD and play it back.
- Press the [Search] button on the control panel or the remote control to detect the input source.
- Press the button for the input source that you want to project by using the remote control.
- If the Home screen is displayed, select the input source that you want to project.

Warning

- Do not look into the projector's lens during projection. Doing so may damage your eyes. Be especially careful if children are present.
- During projection, do not block the light from the projector with a book and so on. If the light from the projector is blocked, the area on which the light shines becomes hot which could cause it to melt, burn, or start a fire. Also, the lens may get hot due to the reflected light which could cause the projector to malfunction. To stop projection, use the A/V Mute function or turn off the projector.



- If **Direct Power On** is set to **On** in the **Extended** menu, the projector automatically turns on when the power cord is connected to it. When the power cord is plugged in, note that the projector turns on automatically in cases such as recovery from a power outage.
 - ☛ **Extended - Operation - Direct Power On** [p.150](#)
- If an image signal from the source selected in **Auto Power On** is input, the projector automatically turns on.
 - ☛ **Extended - Operation - Auto Power On** [p.150](#)

Home Screen

You can use the Home screen to easily select input sources or frequently used functions. The Home screen is displayed in the following situations.

- When the [] button on the remote control is pressed
- When the projector is turned on while **Home Screen Auto Disp.** is set to **On**
 - ☛ **Extended - Home Screen - Home Screen Auto Disp.** [p.150](#)
- When there is no signal from the selected input source when the projector is turned on

When the Home screen is displayed, use the [▲][▼][◀][▶] buttons on the control panel or remote control to select an item, and then press the [↵] button.

To hide the Home screen, press the [⬆] button on the remote control again.



7 Select Color Mode.
 🖱️ "Selecting the Projection Quality (Selecting Color Mode)" p.77

 The Home screen disappears after 10 minutes of inactivity.

1	Select the input source that you want to project.
2	Displays the QR code and projects the data of a smartphone or tablet.
3	Displays the Help screen. 🖱️ "Using the Help" p.176
4	Displays the Configuration menu.
5	Executes the function assigned to Custom Function 1 or Custom Function 2 in the Extended menu. 🖱️ Extended - Home Screen - Custom Function 1, Custom Function 2 p.150
6	Select Light Source Mode. 🖱️ "Setting the Brightness" p.77



- To ensure a long projector service life, turn off the projector when you are not using it. The light source's operating life varies depending on the Configuration menu settings, environmental conditions, and usage conditions. The brightness of the projected image drops as projection time elapses.
- The projector can be powered off directly by the breaker because it supports the direct shutdown function.
- When the projector is used continuously for more than 24 hours, or when direct shutdown is used regularly, set **Light Source Calibration** using the scheduling function to adjust the light source periodically.
 - ☛ "Scheduling Function" [p.116](#)

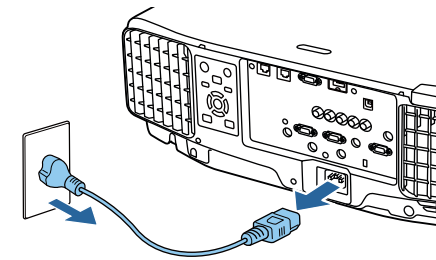

- 1** Press the [⏻] button on the control panel or the remote control. The shutdown confirmation screen is displayed.

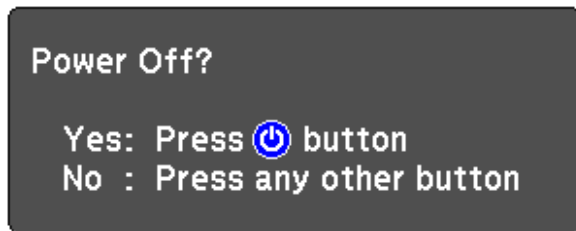

- 2** Press the [⏻] button again. (To cancel, press any other button.) After the buzzer beeps twice, the projected image disappears, and the status indicator turns off.
- 3** Disconnect the power cord.

Automatically Detecting Input Signals and Changing the Projected Image (Source Search)

Press the [Search] button to project images from the port currently receiving an image.

Using the remote control

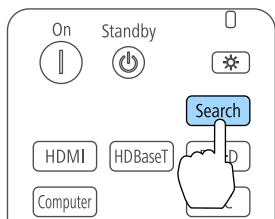

Using the control panel

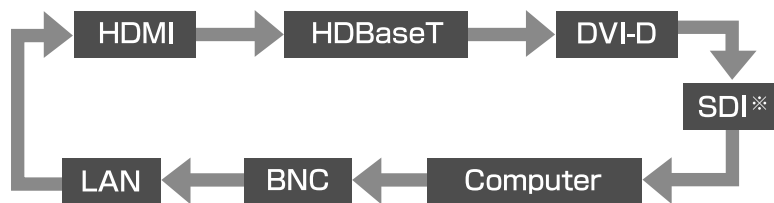
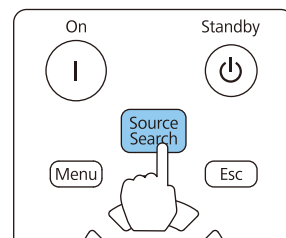

*EB-L1755U/EB-L1750U/EB-L1505UH/EB-L1500UH only

When two or more image sources are connected, repeatedly press the [Search] button until the target image is projected.

When your video equipment is connected, start playback before beginning this operation.



- You can set up the projector so that it automatically detects an image signal from another input source and projects the image when there is no image signal from the current input source.
 - Extended - Operation - Auto Source Search [p.150](#)
- The following screen is displayed while no image signals are input.

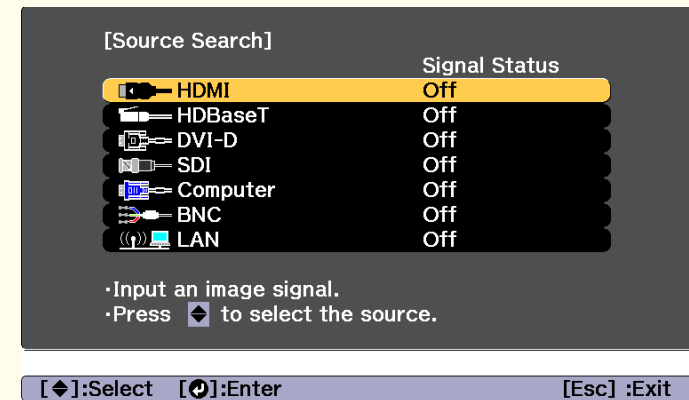

Switching to the Target Image by Remote Control

- Press the button of the input source that you want to project.
The input ports for the buttons are shown below.

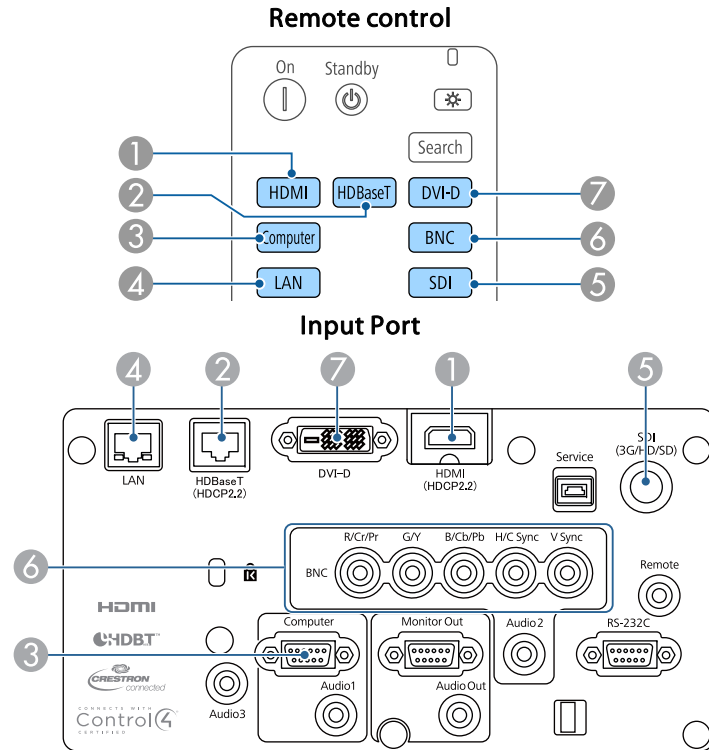

- ④ Changes to images from a computer connected via the network.
- ⑤ For EB-L1755U/EB-L1750U/EB-L1505UH/EB-L1500UH only.

- Press the [] button.

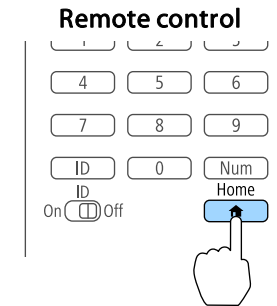

Select the input source to be projected, and then press the [] button.

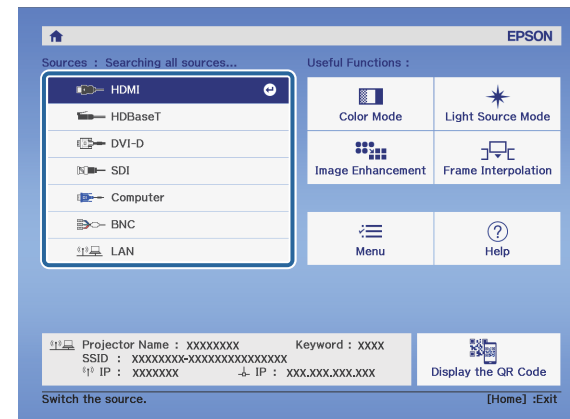

Adjusting the Volume

You can adjust the volume of the audio from the Audio Out port using one of the following methods.

- Press the [Volume] buttons on the remote control to adjust the volume.
 - [<|||>] Increases the volume.
 - [<|>] Decreases the volume.

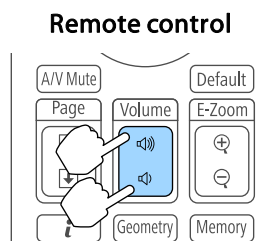

- Adjust the volume from the Configuration menu.
 - 👁 **Settings - Volume** [p.148](#)



Caution

Do not start at high volume.

A sudden excessive volume may cause loss of hearing. Always lower the volume before powering off, so that you can power on and then gradually increase the volume.



When the input source is SDI, audio is not output.

Correcting Distortion in the Projected Image

You can correct keystone distortion in projected images using one of the following methods.

- H/V-Keystone

This allows you to correct distortion in the horizontal and vertical directions independently.

☛ "H/V-Keystone" [p.66](#)

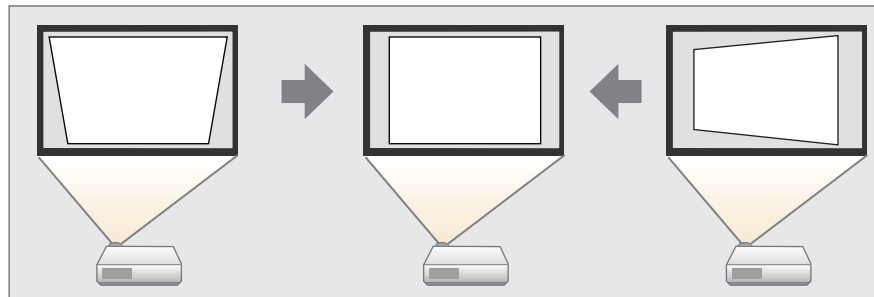

- Quick Corner

Correct the four corners independently.

☛ "Quick Corner" [p.67](#)

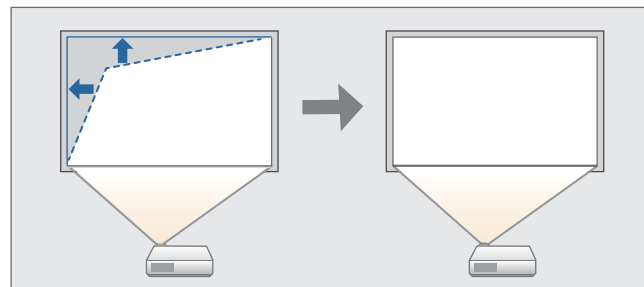

- Curved Surface

Correct distortion that occurs when projecting on a curved surface, and adjust the amount of expansion and contraction.

☛ "Curved Surface" [p.68](#)

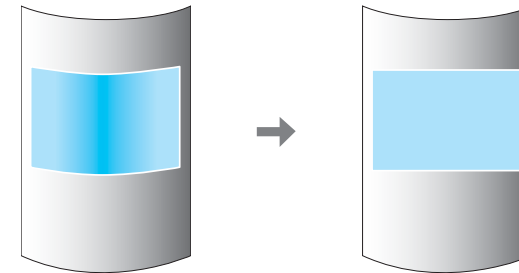

- Corner Wall

This allows you to correct distortion that occurs when projecting on a surface with right angles, such as a square pillar or the corner of a room, and adjust the amount of expansion and contraction.

☛ "Corner Wall" [p.72](#)

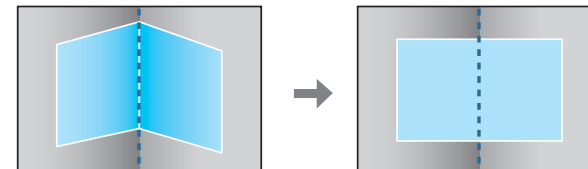

- Point Correction

Corrects slight distortion which occurs partially, or adjusts the image position in an overlapping area when projecting from multiple projectors.

☛ "Point Correction" [p.75](#)

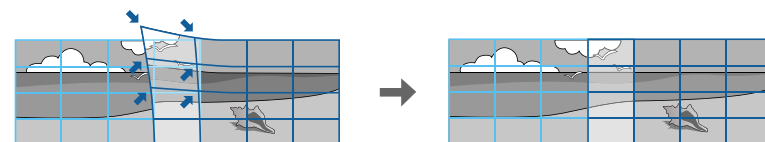



- By pressing the [Geometry] button on the remote control or the [] button on the control panel, a screen for selecting the adjustment method is displayed.
- When you want to re-adjust the projection position and so on, if you want to release the correction status temporarily, set the **Geometry Correction** to **Off**. Even when it is set to **Off**, the correction values are saved.
 - ☛ **Settings - Geometry Correction** p.148
- You can save the geometry correction settings using **Memory** in **Geometry Correction**, and load them when needed.
 - ☛ "Memory Function" p.114

H/V-Keystone

This allows you to correct distortion in the horizontal and vertical directions independently.

Use the following to check the adjustment range for the image.

☛ "H/V-Keystone" p.257

- 1 Press the [Menu] button while projecting.
- 2 Select **Geometry Correction** from **Settings**.
- 3 Select **H/V-Keystone**, and then press the [↵] button.

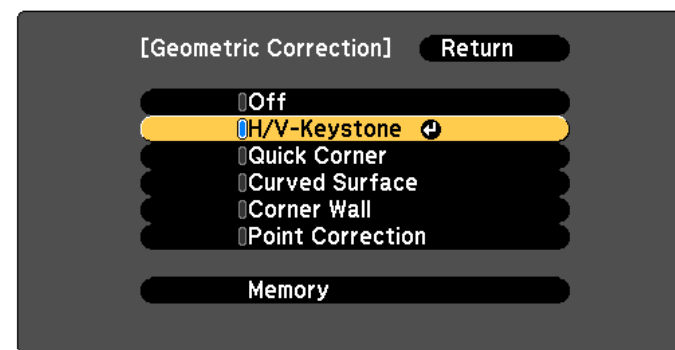

[Esc]:Return [◆]:Select [⏎]:Enter [Menu]:Exit

"If this setting is changed, the image may be distorted." is displayed, press the [↵] button.

- 4 Use the [▲][▼] buttons to select the correction method, and then use the [◀][▶] buttons to make the corrections.

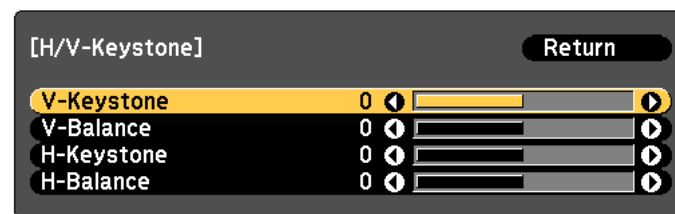

[Esc]:Return [◆]:Select [◀▶]:Adjust [Menu]:Exit [Default]:Reset

Correct the keystone distortion by using **V-Keystone** and **H-Keystone**.

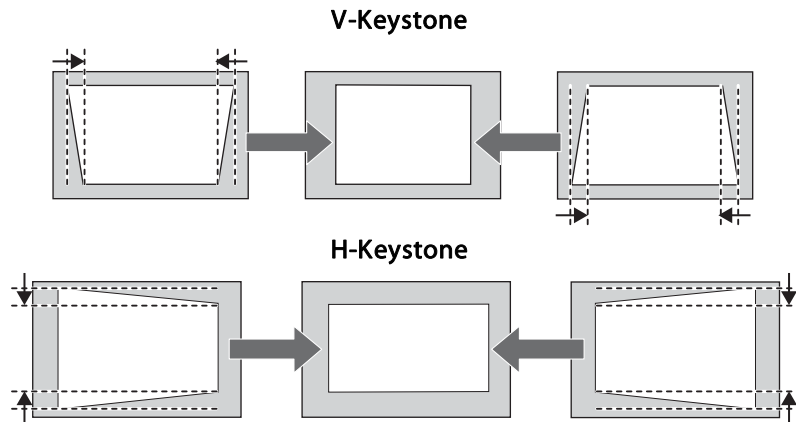

If the image aspect is incorrect, adjust the image balance by using **V-Balance** and **H-Balance**.

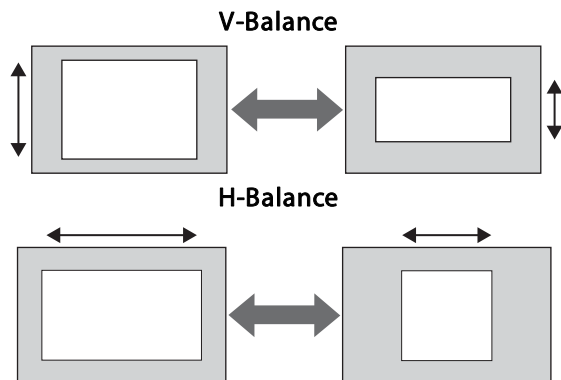

When you correct keystone distortion, the projected image may be reduced.

5 To complete the corrections, press the [Menu] button.



You cannot combine with other correction methods.

Quick Corner

This allows you to correct each of the four corners of the projected image independently.

- 1** Press the [Menu] button while projecting.
- 2** Select **Geometry Correction** from **Settings**.
- 3** Select **Quick Corner**, and then press the [↵] button.

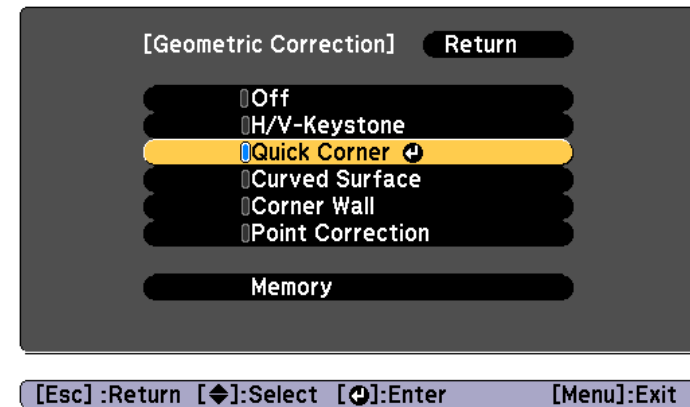

"If this setting is changed, the image may be distorted." is displayed, press the [↵] button again.

- 4** Use the [▲], [▼], [◀], and [▶] buttons to select the corner you want to adjust, and then press the [↵] button.

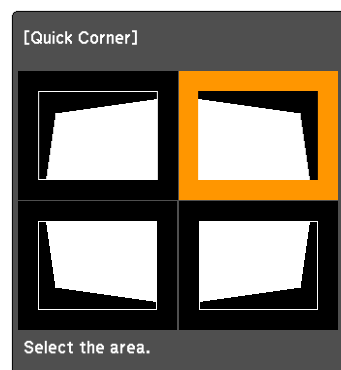

[↔/↔]:Select
 [↵]:Enter
 [Esc] : Return (press for 2 seconds to reset)



If the [Esc] button is pressed for approximately two seconds, the confirm default reset screen is displayed.
 Select **Yes** to reset the result of Quick Corner corrections.

5 Use the [▲], [▼], [◀], and [▶] buttons to correct the position of the corner.

When you press the [↵] button, the screen shown in step 4 that allows you to select the area to be corrected is displayed.

If the message "Cannot adjust any further." is displayed while adjusting, you cannot adjust the shape any further in the direction indicated by the gray triangle.

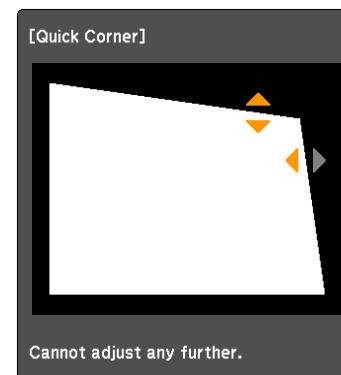

[↔/↔]:Adjust
 [Esc] / [↵]:Return

- 6** Repeat steps 4 and 5 as needed to adjust any remaining corners.
- 7** To complete the corrections, press the [Menu] button.

Curved Surface

This allows you to correct distortion that occurs when projecting on a curved surface, and adjust the amount of expansion and contraction.

Face the projector directly opposing the screen with the lens position moved to the home position.

☛ "Adjusting the Position of the Projected Image (Lens Shift)" [p.34](#)



- Project onto an arc surface with the same radius.
- If a large amount of adjustment is performed, the focus may not be uniform even after making adjustments.
- If **4K Enhancement** is enabled, a message is displayed. Select **Yes** to disable **4K Enhancement**. (EB-L1755U/EB-L1750U/EB-L1505UH/EB-L1500UH only)
 - ☛ **Image - Image Enhancement - 4K Enhancement** [p.143](#)

Use the following to check the adjustment range for the image.

☛ "Curved Surface" [p.257](#)

- 1 Press the [Menu] button while projecting.
- 2 Select **Geometry Correction** from **Settings**.
- 3 Select **Curved Surface**, and then press the [↵] button.

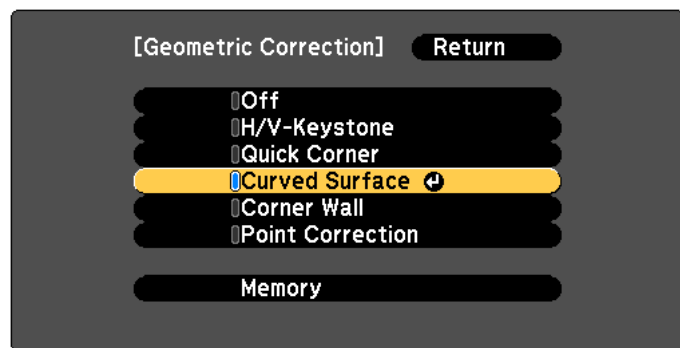

[Esc] :Return [↩]:Select [↵]:Enter [Menu]:Exit

"If this setting is changed, the image may be distorted." is displayed, press the [↵] button.

- 4 Select **Curved Surface**, and then press the [↵] button.

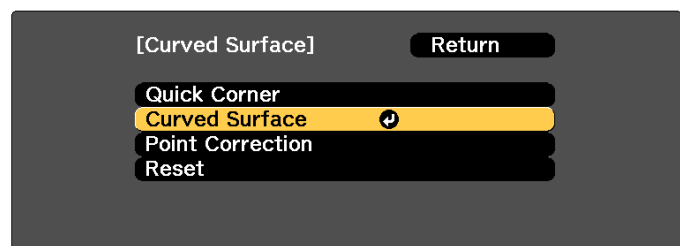

[Esc] :Return [↩]:Select [↵]:Enter [Menu]:Exit

- 5 Select **Correct Shape**, and then press the [↵] button.

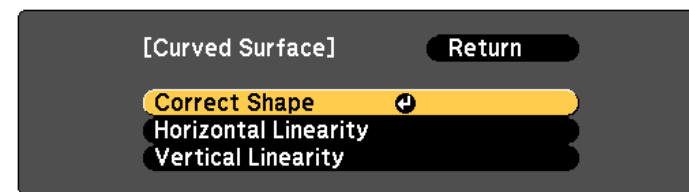

[Esc] :Return [↩]:Select [↵]:Enter [Menu]:Exit

- 6** Use the [▲], [▼], [◀], and [▶] buttons to select the area you want to adjust, and then press the [↵] button.

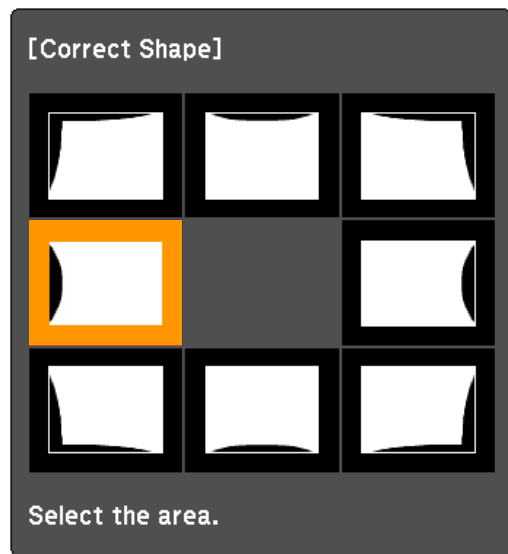

When selecting a corner, you can adjust the two sides next to the corner.



If the [Esc] button is pressed for approximately two seconds, the confirm default reset screen is displayed.

Select **Yes** to reset the result of Curved Surface.

- 7** Use the [▲], [▼], [◀], and [▶] buttons to adjust the shape.

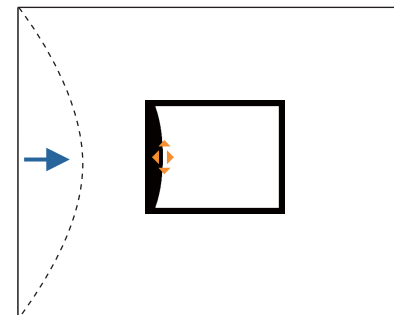

If the triangle in the direction you are adjusting the shape turns gray, as shown in the screenshot below, you cannot adjust the shape any further in that direction.

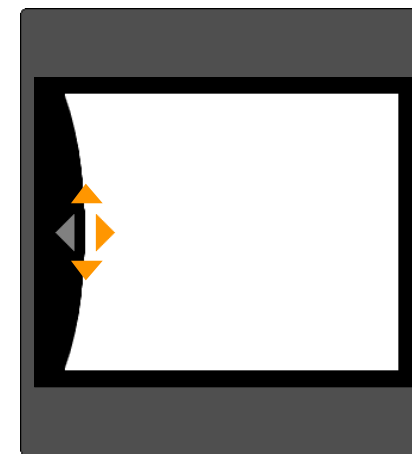

- 8** Press the [Esc] button to return to the previous screen.

- 9** Repeat steps from 6 to 8 as needed to adjust any remaining parts.

If the image expands or contracts, go to the next step and adjust the linearity.

- 10** Press the [Esc] button to display the screen from step 5. Select **Horizontal Linearity** or **Vertical Linearity**, and then press the [↵] button.

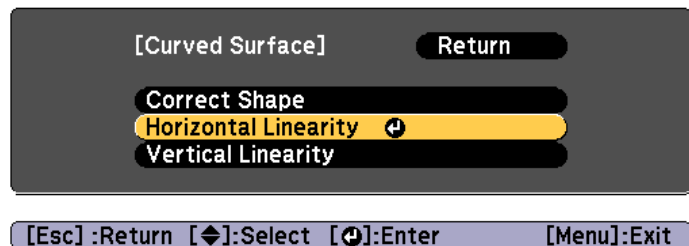

Select **Horizontal Linearity** to adjust the horizontal expansion or contraction, and select **Vertical Linearity** to adjust the vertical expansion or contraction.

- 11** Select the standard line for the adjustments, and then press the [↵] button.

Press the [◀][▶] buttons when selecting **Horizontal Linearity**, and the [▲][▼] buttons when selecting **Vertical Linearity**, and then press [↵].

The selected standard line is displayed in flashing orange and white.

- 12** Adjust the linearity. Correct it so that the distance between lines is equal. When pressing the [◀] button

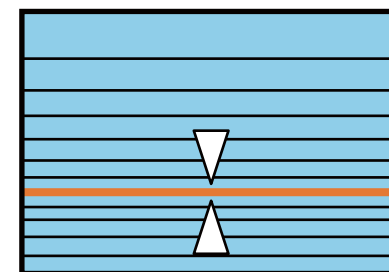
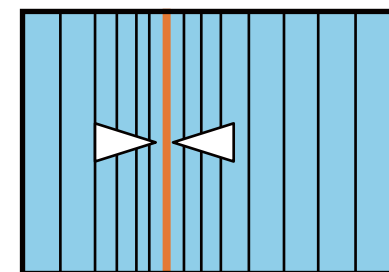

When **Horizontal Linearity** is selected When **Vertical Linearity** is selected

When pressing the [▶] button

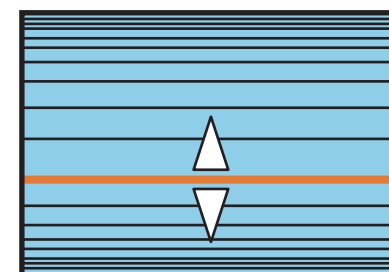
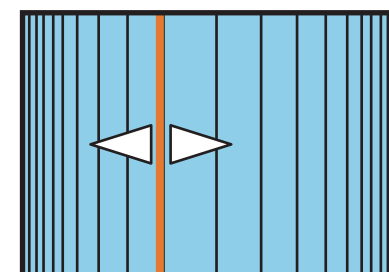

When **Horizontal Linearity** is selected When **Vertical Linearity** is selected

- 13** To complete the corrections, press the [Menu] button.



You can fine tune the corrected results. Use **Quick Corner** to adjust the tilt of the image, and then use **Point Correction** for fine tuning. Select **Quick Corner** or **Point Correction** on the screen from step 4.

☞ "Quick Corner" p.67

☞ "Point Correction" p.75

Corner Wall

This allows you to correct distortion that occurs when projecting on a surface with right angles, such as a square pillar or the corner of a room, and adjust the amount of expansion and contraction.

Face the projector directly opposing the screen with the lens position moved to the home position.

☛ "Adjusting the Position of the Projected Image (Lens Shift)" [p.34](#)



- Project onto a surface with a right angle.
- If a large amount of adjustment is performed, the focus may not be uniform even after making adjustments.
- If **4K Enhancement** is enabled, a message is displayed. Select **Yes** to disable **4K Enhancement**. (EB-L1755U/EB-L1750U/EB-L1505UH/EB-L1500UH only)
 - ☛ **Image - Image Enhancement - 4K Enhancement** [p.143](#)
- This is not available for ELPLX02.

Use the following to check the adjustment range for the image.

☛ "Corner Wall" [p.261](#)

- 1 Press the [Menu] button while projecting.
- 2 Select **Geometry Correction** from **Settings**.
- 3 Select **Corner Wall**, and then press the [↵] button.

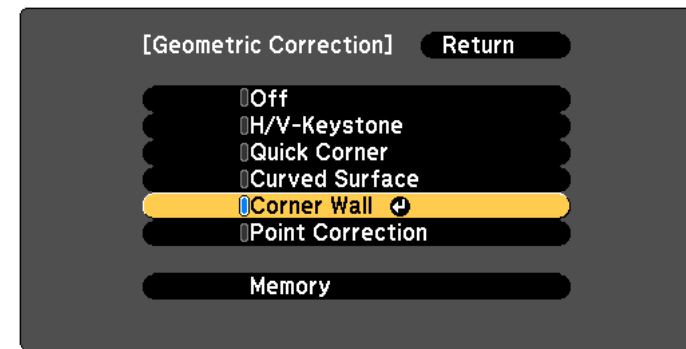

[Esc]:Return [↕]:Select [↵]:Enter [Menu]:Exit

"If this setting is changed, the image may be distorted." is displayed, press the [↵] button again.

- 4 Select **Corner Wall**, and then press the [↵] button.

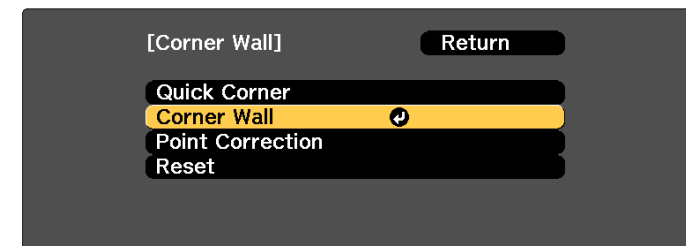

[Esc]:Return [↕]:Select [↵]:Enter [Menu]:Exit

- 5 Select **Corner Type**, and then press the [↵] button.

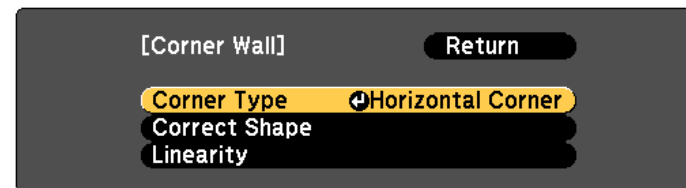

[Esc]:Return [↕]:Select [↵]:Enter [Menu]:Exit

- 6** According to the projection area, select **Horizontal Corner** or **Vertical Corner**, and then press the [**↵**] button.

When the surfaces line up horizontally:

Select **Horizontal Corner**.

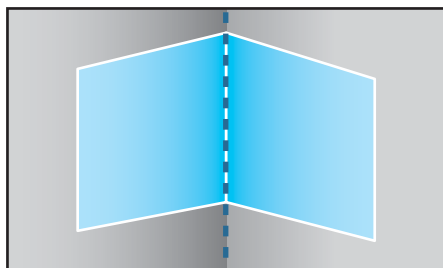

When the surfaces line up vertically:

Select **Vertical Corner**.

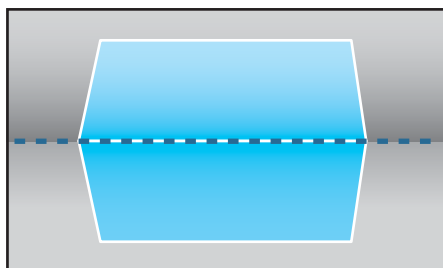

From here on, steps are explained using **Horizontal Corner** as an example.

- 7** Press the [Esc] button to display the screen from step 5. Select **Correct Shape**, and then press the [**↵**] button.

- 8** Adjust the position of the projector and the lens shift so that the line in the center of the screen matches the corner (the point where the two surfaces meet).

☞ "Adjusting the Position of the Projected Image (Lens Shift)"
[p.34](#)

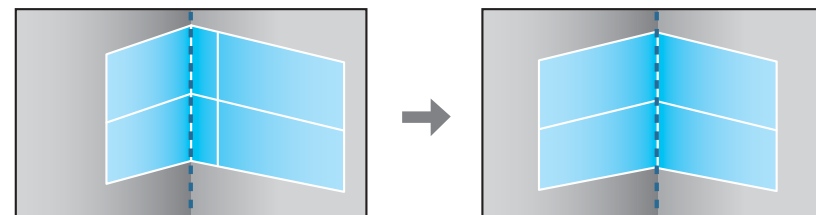

Each time you press the [**↵**] button, you can show or hide the image and the grid.

- 9** Use the [▲], [▼], [◀], and [▶] buttons to select the area you want to adjust, and then press the [↵] button.

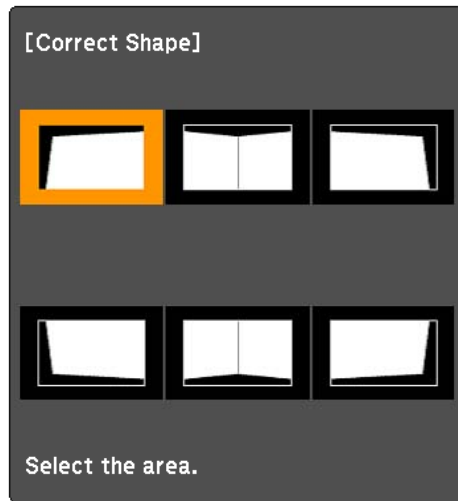

Adjustment tips

When **Horizontal Corner** is selected:

Adjust the upper area based on the lowest point (indicated by the **A** arrow).

Adjust the lower area based on the highest point (indicated by the **B** arrow).

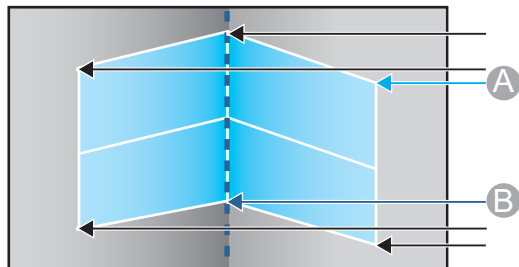

When **Vertical Corner** is selected:

Adjust the left and right based on the point nearest to the vertical line in the center of the screen.



If the [Esc] button is pressed for approximately two seconds, the confirm default reset screen is displayed.

Select **Yes** to reset the result of **Corner Wall**.

- 10** Press the [▲][▼][◀][▶] buttons to adjust the shape. If the message "Cannot adjust any further." is displayed while adjusting, you cannot adjust the shape any further in the direction indicated by the gray triangle.
- 11** Repeat steps 9 and 10 as needed to adjust any remaining parts. If the image expands or contracts, go to the next step and adjust the linearity.
- 12** Press the [Esc] button to display the screen from step 4. Select **Linearity**, and then press the [↵] button.

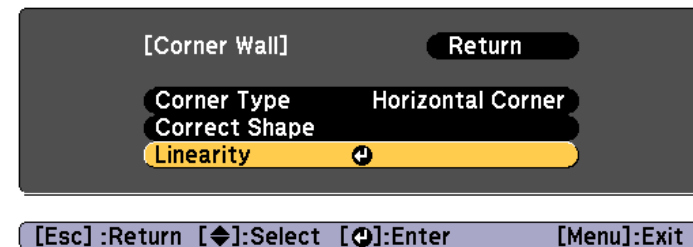

- 13** Press the [◀][▶] buttons to adjust the linearity.
Correct it so that the distance between lines is equal.

When pressing the [◀] button

When **Horizontal Corner** is selected

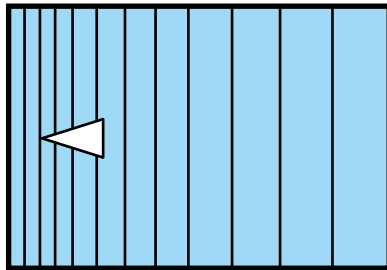

When **Vertical Corner** is selected

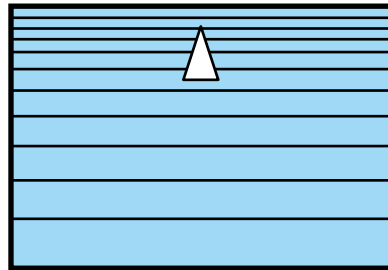

When pressing the [▶] button

When **Horizontal Corner** is selected

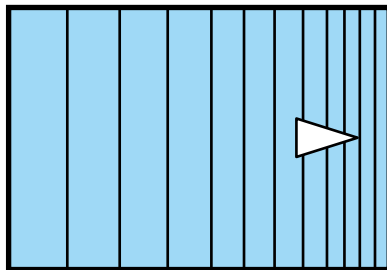

When **Vertical Corner** is selected

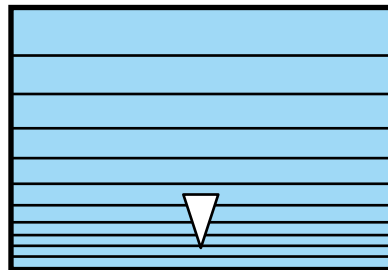

- 14** To complete the corrections, press the [Menu] button.



You can fine tune the corrected results. Use **Quick Corner** to adjust the tilt of the image, and then use **Point Correction** for fine tuning. Select **Quick Corner** or **Point Correction** on the screen from step 4.

- ☛ "Quick Corner" p.67
- ☛ "Point Correction" p.75

Point Correction

Divides the projected image by the grid and corrects the distortion by moving the point of intersection from side to side and up and down.



- You can make corrections in 0.5 pixel increments in all directions within the following ranges.
EB-L1755U/EB-L1750U/EB-L1505UH/EB-L1500UH: Vertical and horizontal up to a maximum of 32 pixels.
EB-L1715S/EB-L1710S/EB-L1515S/EB-L1510S: Vertical and horizontal up to a maximum of 27 pixels.
- If **4K Enhancement** is enabled, a message is displayed. Select **Yes** to disable **4K Enhancement**. (EB-L1755U/EB-L1750U/EB-L1505UH/EB-L1500UH only)
☛ **Image - Image Enhancement - 4K Enhancement** p.143

- 1** Press the [Menu] button while projecting.
- 2** Select **Geometry Correction** from **Settings**.
- 3** Select **Point Correction**, and then press the [↵] button.

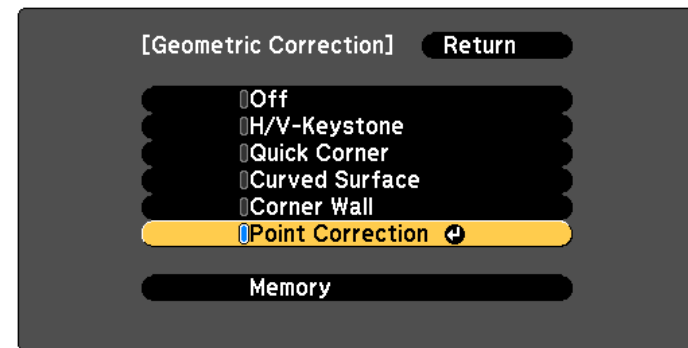

[Esc]:Return [◀]:Select [↵]:Enter [Menu]:Exit

"If this setting is changed, the image may be distorted." is displayed, press the [↵] button again.

- 4** Select **Point Correction**, and then press the [↵] button.

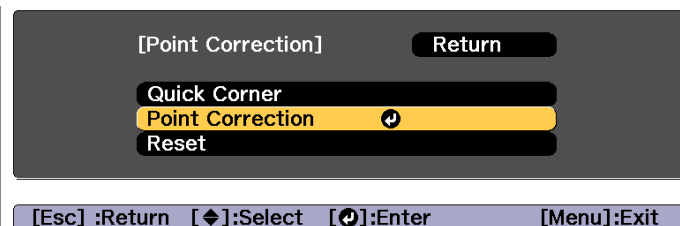

- 5** Select **Point Correction**, and then press the [↵] button.

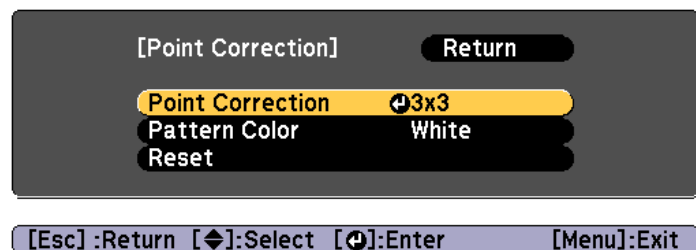

Point Correction	Select the point number (3x3, 5x5, 9x9, 17x17), and then make the Point Correction setting.
Pattern Color	Select the color of the grid when performing corrections.
Reset	Resets all corrections for Point Correction to their default values.

- 6** Select the point number (3x3, 5x5, 9x9, or 17x17), and then press the [↵] button.

- 7** Use the [▲], [▼], [◀], and [▶] buttons to move to the point you want to correct, and then press the [↵] button.

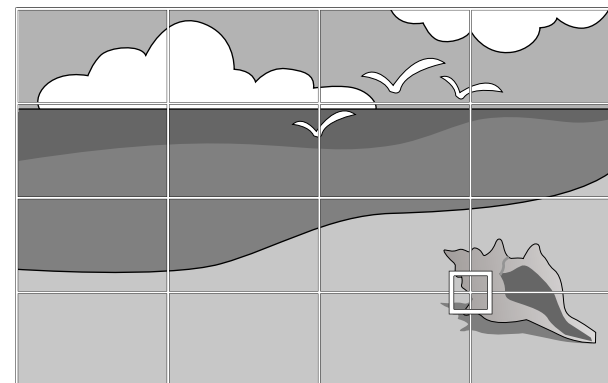

- 8** Use the [▲], [▼], [◀], and [▶] buttons to correct distortion.

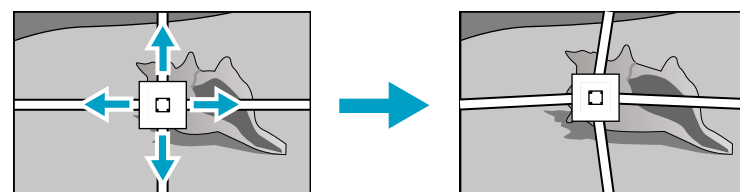

To continue to correct another point, press the [Esc] button to return to the previous screen, then repeat the steps 7 and 8.



Each time you press the [↵] button, you can show or hide the image and the grid.

- 9** To complete the corrections, press the [Menu] button.



You can fine tune the corrected results. Select **Quick Corner** on the screen from step 4 to adjust the tilt of the image.

☞ "Quick Corner" [p.67](#)

Selecting the Projection Quality (Selecting Color Mode)

You can easily obtain the optimum image quality simply by selecting the setting that best corresponds to your surroundings when projecting. The brightness of the image varies depending on the mode selected.

Mode	Application
Dynamic	This is the brightest mode. Ideal for use in a bright room.
Presentation	The images are vivid and brought to life. Ideal for making presentations or watching a TV program in a bright room.
Natural	Reproduces colors faithfully. Ideal for projecting still pictures such as photos.
Cinema	Gives images a natural tone. Ideal for watching films in a dark room.
BT.709	Produces images that conform to the ITU-R BT.709. This is ideal for watching digital TV or Blu-ray discs.
DICOM SIM	This produces images with clear shadows. Ideal for projecting X-ray photographs and other medical images. The projector is not a medical device and cannot be used for medical diagnosis.
Multi-Projection	Minimize the color tone difference between each projected image. Ideal for projecting from multiple projectors.

Each time you press the [Color Mode] button, the Color Mode name is displayed on the screen and the Color Mode changes.

Remote control

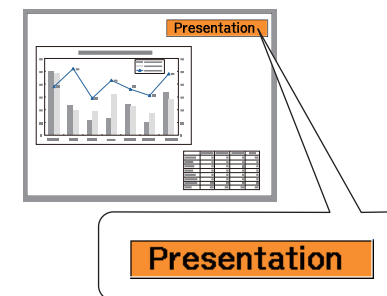
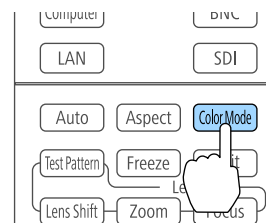

You can set Color Mode from the Configuration menu.

☞ **Image - Color Mode** [p.143](#)

Setting the Brightness

Set the brightness for the light source.

- 1** Press the [Menu] button while projecting.
- 2** Select **Brightness Settings** from **Settings**.

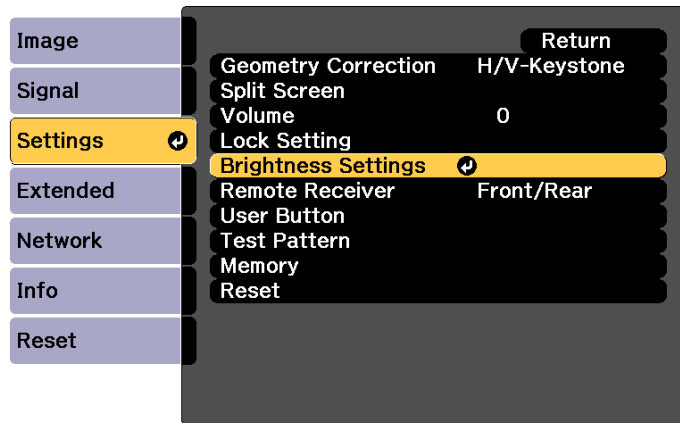

[Esc] :Return [↩]:Select [↵]:Enter [Menu]:Exit

3 Select **Light Source Mode**, and then press the [↵] button.

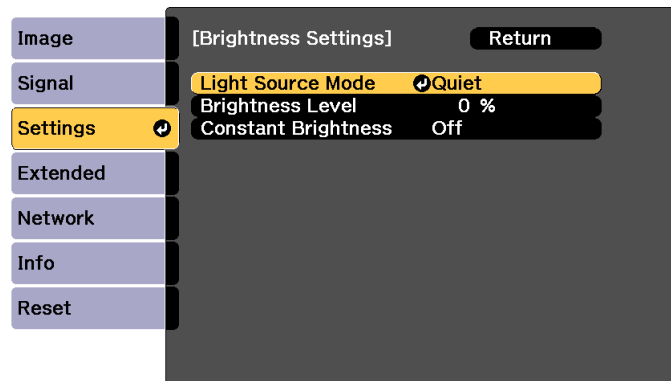

[Esc] :Return [↩]:Select [↵]:Enter [Menu]:Exit

4 Select the item you want to set, and then press the [↵] button.

Normal: Select this if you do not want to decrease the brightness. This makes the target usage time approximately 20,000 hours.

Quiet: Select this if you are concerned about the noise made by the fan. This sets the brightness at 70%. This makes the target usage time approximately 20,000 hours.

Extended: Select this to extend the life expectancy of the light source. This sets the brightness at 70%. This makes the target usage time approximately 30,000 hours.

Custom: Select this to set the **Brightness Level** manually. When **Custom** is selected, **Constant Brightness** is available.



When the following lenses are attached to EB-L1755U/EB-L1750U/EB-L1715S/EB-L1710S, brightness is restricted and you cannot select **Normal**.

ELPLU03, ELPLW05, ELPLM09, ELPLS04, ELPLU02, ELPLR04, ELPLW04, ELPLM06, ELPLM07, ELPLL07

5 When **Light Source Mode** is set to **Custom**, select **Brightness Level**, and then use the [◀][▶] buttons to set the brightness.



When the following lenses are attached to EB-L1755U/EB-L1750U/EB-L1715S/EB-L1710S, adjustments to the maximum **Brightness Level** are restricted.

ELPLU03, ELPLW05, ELPLM09, ELPLS04, ELPLU02, ELPLR04, ELPLW04, ELPLM06, ELPLM07, ELPLL07

6 To maintain a fixed brightness, select **Constant Brightness**, and set it to **On**.



- When **Constant Brightness** is set to **On**, you cannot change the settings for **Light Source Mode** and **Brightness Level**. When you want to change these settings, set **Constant Brightness** to **Off**.
- When **Constant Brightness** is set to **Off**, the value for **Brightness Level** changes depending on the current status of the light source.
- There may be a margin of error in the **Brightness Level**.
- When the projector is used continuously for more than 24 hours, or when direct shutdown is used regularly, set **Light Source Calibration** using the scheduling function. If this is not set, the Constant Brightness function does not work.
 🖱️ "Scheduling Function" [p.116](#)

Display Level	Estimated Remains
	10,000 hours or more
█	8,000 to 9,999 hours
██	6,000 to 7,999 hours
███	4,000 to 5,999 hours
████	2,000 to 3,999 hours
█████	0 to 1,999 hours



The time displayed on the screen is just a guide. 30,000 hours or more is displayed in units of 10,000; 2,000 to 29,999 hours is displayed in units of 1,000; and up to 1,999 hours is displayed in units of 100.

Guide to Estimated Remains

When **Constant Brightness** is set to **On**, the Estimated Remains is displayed. Estimated Remains indicates the amount of time for which constant brightness can be maintained.

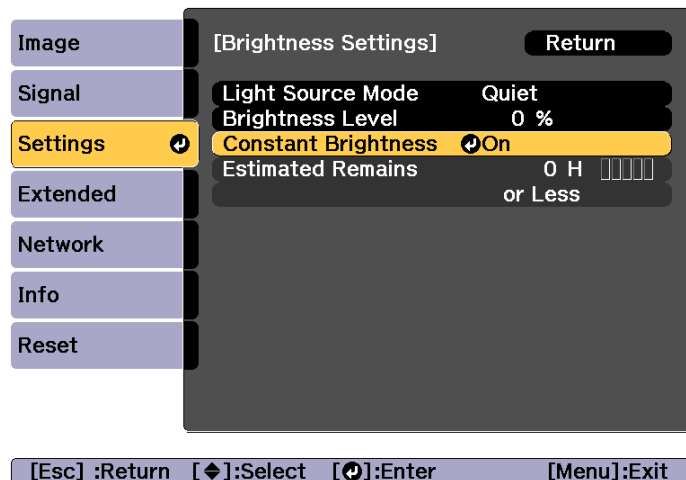

Relationship between Brightness Level and usage time

The following shows the relationship between Brightness Level and usage time.

Make settings according to your desired usage time and the brightness of the projected image.

When Constant Brightness is set to Off

- ①: Brightness Level
- ②: Approximate time until light source brightness is reduced by half

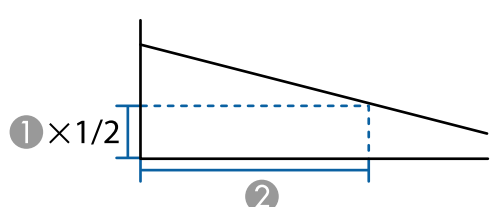
①	②	Illustration
100%	20,000 hours	
90%	21,000 hours	
80%	24,000 hours	
70%	30,000 hours	
60%	37,000 hours	
50%	47,000 hours	

①	②	Illustration
40%	61,000 hours	
30%	71,000 hours	

When Constant Brightness is set to On

- ①: Brightness Level
- ②: Approximate time for which constant brightness of the light source can be maintained

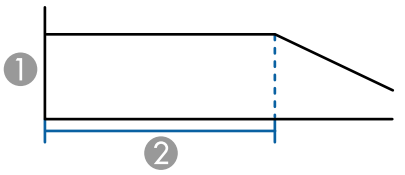
①	②	Illustration
85%	6,000 hours	
80%	10,000 hours	
70%	19,000 hours	
60%	29,000 hours	
50%	41,000 hours	
40%	56,000 hours	
30%	78,000 hours	



- This is an approximate guide only and may change depending on usage and surroundings.
- The times above are the standard hours when using the projector continuously without changing the **Brightness Level** or **Constant Brightness** settings and are not guaranteed.
- When the usage time exceeds 20,000 hours, you may need to replace parts inside the projector.
- When **Constant Brightness** is set to **On**, and the approximate constant time has been exceeded, you may not be able to set a high value for **Brightness Level**.

Setting the Amount of Light of the Projected Image

By automatically setting the luminance according to the brightness of the displayed image, it lets you enjoy deep and rich images.



Dynamic Contrast can only be set when the **Color Mode** is set to **Dynamic** or **Cinema**.

- Press the [Menu] button while projecting.
- Select **Dynamic Contrast** from **Image**, and then press the [↵] button.

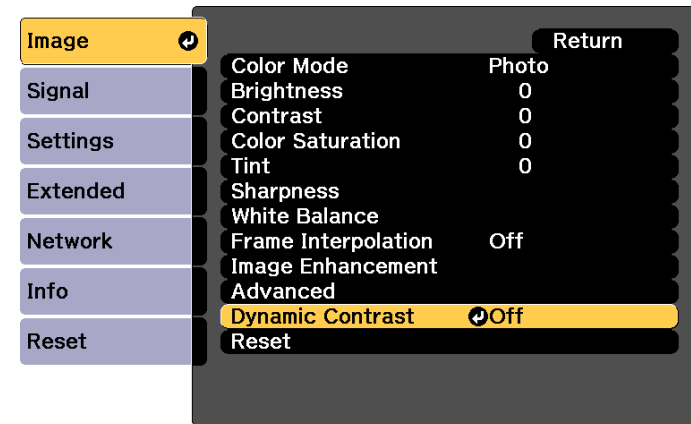



[Esc] :Return [↕]:Select [↵]:Enter [Menu]:Exit

- Select **Normal** or **High Speed**, and then press the [↵] button. The setting is stored for each color mode.
- Press the [Menu] button to finish making settings.

Changing the Aspect Ratio of the Projected Image

You can change the Aspect Ratio of the projected image to suit the type, the ratio of height and width, and the resolution of the input signals.

Available aspect modes vary depending on the Screen Type currently set.

 Set the **Screen Type** before changing the aspect ratio.
 "Screen Settings" [p.31](#)

Changing methods

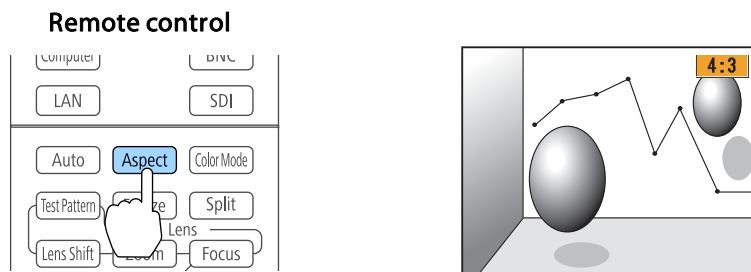

Each time you press the [Aspect] button on the remote control, the aspect mode name is displayed on the screen and the aspect ratio changes.



Aspect Mode	Explanation
Auto	Projects in an appropriate aspect ratio based on information from the signal being input.
Normal	Projects while retaining the aspect ratio of the input image.
4:3	Projects at an aspect ratio of 4:3.
16:9	Projects at an aspect ratio of 16:9.
Full	Projects at the full size of the projected screen.

Aspect Mode	Explanation
H-Zoom	Projects by enlarging the input image to the full width of the projected screen while retaining the aspect ratio. Areas that exceed the edges of the projected screen are not projected.
V-Zoom	Projects by enlarging the input image to the full height of the projected screen while retaining the aspect ratio. Areas that exceed the edges of the projected screen are not projected.
Native	Projects to the center of the projected screen at the resolution of the input image. Areas that exceed the edges of the projected screen are not projected.

 You can also set the aspect ratio from the Configuration menu.

-  **Signal - Aspect** [p.146](#)
- If parts of the computer image are missing, set the **Resolution** setting to **Wide** or **Normal** from the Configuration menu, according to the resolution of the computer.
 -  **Signal - Resolution** [p.146](#)

The aspect mode changes as shown in the tables below.

The following colors in screen images in the tables indicate areas that are not displayed.

: The area where the image is not displayed depending on the screen type setting.

: The area where the image is not displayed depending on the aspect mode setting.

EB-L1755U/EB-L1750U/EB-L1505UH/EB-L1500UH

Screen type setting: 16:10

	Aspect Ratio of Input Signal		
	16:10	16:9	4:3
Auto or Normal			
16:9			
Full			
H-Zoom			
V-Zoom			
Native*			

* The image may differ depending on the resolution of the input signal.

Screen type setting: 16:9

	Aspect Ratio of Input Signal		
	16:10	16:9	4:3
Auto or Normal			

	Aspect Ratio of Input Signal		
	16:10	16:9	4:3
Full			
H-Zoom			
V-Zoom			
Native*			

* The image may differ depending on the resolution of the input signal.

Screen type setting: 4:3

	Aspect Ratio of Input Signal		
	16:10	16:9	4:3
Auto or Normal			
4:3*1			
16:9			

	Aspect Ratio of Input Signal		
	16:10	16:9	4:3
H-Zoom			
V-Zoom			
Native*2			

*1 When inputting an HDTV signal (720p/1080i/1080p), the aspect ratio of the signal is maintained, while the image is trimmed on the left and right and displayed.

*2 Only computer images and images from the HDMI port/HDBaseT port. The image may differ depending on the resolution of the input signal.

EB-L1715S/EB-L1710S/EB-L1515S/EB-L1510S

Screen type setting: 4:3

	Aspect Ratio of Input Signal		
	16:10	16:9	4:3
Auto or Normal			
4:3*1			
16:9			

	Aspect Ratio of Input Signal		
	16:10	16:9	4:3
H-Zoom			
V-Zoom			
Native*2			

*1 When inputting an HDTV signal (720p/1080i/1080p), the aspect ratio of the signal is maintained, while the image is trimmed on the left and right and displayed.

*2 Only computer images and images from the HDMI port/HDBaseT port. The image may differ depending on the resolution of the input signal.

Screen type setting: 16:9

	Aspect Ratio of Input Signal		
	16:10	16:9	4:3
Auto or Normal			
Full			
H-Zoom			
V-Zoom			

	Aspect Ratio of Input Signal		
	16:10	16:9	4:3
Native*			

* The image may differ depending on the resolution of the input signal.

Screen type setting: 16:10

	Aspect Ratio of Input Signal		
	16:10	16:9	4:3
Auto or Normal			
16:9			
Full			
H-Zoom			
V-Zoom			
Native*			

* The image may differ depending on the resolution of the input signal.

Adjusting the Image

Hue, Saturation, and Brightness adjustment

You can adjust the **Hue** (tint), **Saturation** (vividness), and **Brightness** of the six axes R (red), G (green), B (blue), C (cyan), M (magenta), and Y (yellow) according to your preferences.

- 1 Press the [Menu] button while projecting.
- 2 Select **Advanced** from **Image**, and then press the [↵] button.

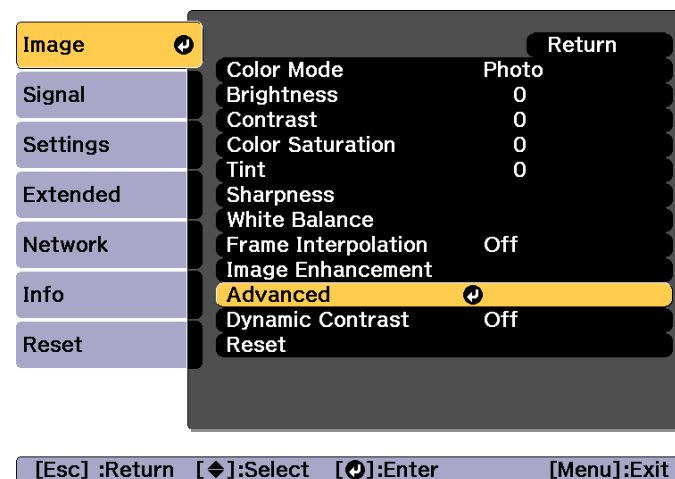

- 3 Select **RGBCMY**, and then press the [↵] button.
- 4 Use the [▲][▼] buttons to select the color you want to adjust, and then press the [↵] button.

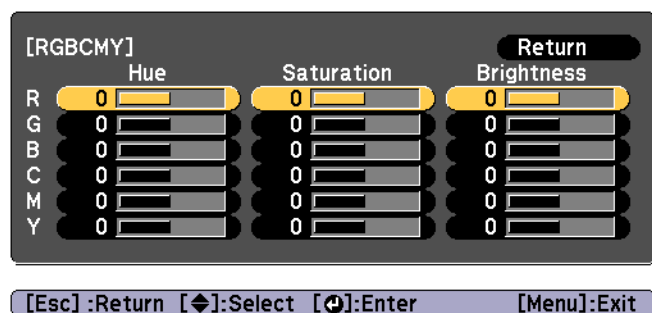

- 5** Use the [▲][▼] buttons to select the item, and then use the [◀][▶] buttons to make the adjustments.

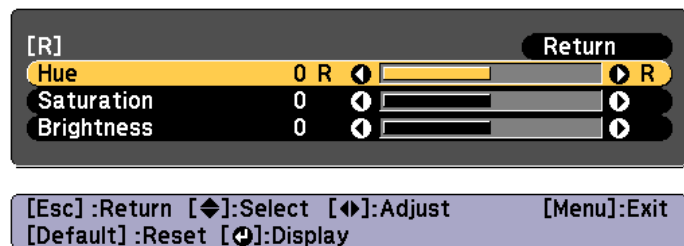

Each time you press the [↵] button, the adjustment screen changes.

- 6** To complete the corrections, press the [Menu] button.

Gamma adjustment

You can adjust differences in the halftone brightness that occurs depending on the connected device.

You can set it by using one of the following methods.

- Select and adjust the correction value
- Adjust using the gamma adjustment graph



Adjust by projecting a still picture. Gamma cannot be adjusted correctly by using movies.

Select and adjust the correction value

- 1** Press the [Menu] button while projecting.
- 2** Select **Advanced** from **Image**, and then press the [↵] button.

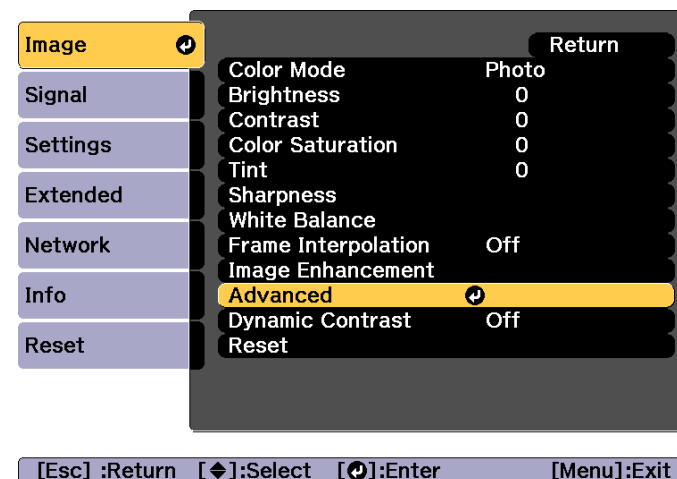

- 3** Select **Gamma**, and then press the [↵] button.
- 4** Use the [▲][▼] buttons to select the correction value, and then use the [↵] button to confirm the selection.

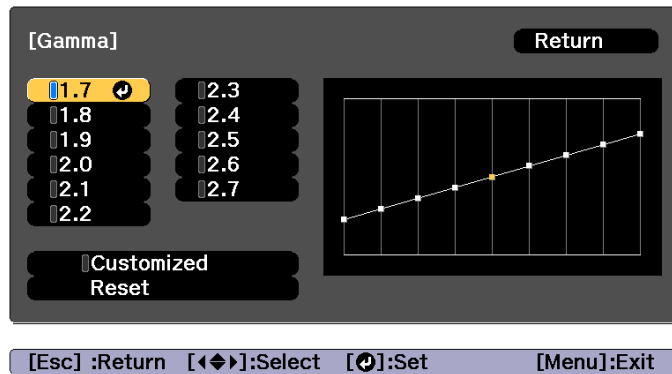

When a larger value is selected, the dark areas of images become brighter, but the color saturation for lighter areas may become weaker. When a smaller value is selected, you can reduce the overall brightness of the image to make the image sharper.

If you select **DICOM SIM** from **Color Mode** on the **Image** menu, select the adjustment value according to the projection size.

- If the projection size is 150 inches or less, select a small value.
- If the projection size is 150 inches or more, select a large value.



Medical images may not be reproduced correctly according to your installation environment and screen specifications.

Adjust using the gamma adjustment graph

Select a tone point on the graph and make adjustments.

- 1 Press the [Menu] button while projecting.
- 2 Select **Advanced** from **Image**, and then press the [Enter] button.

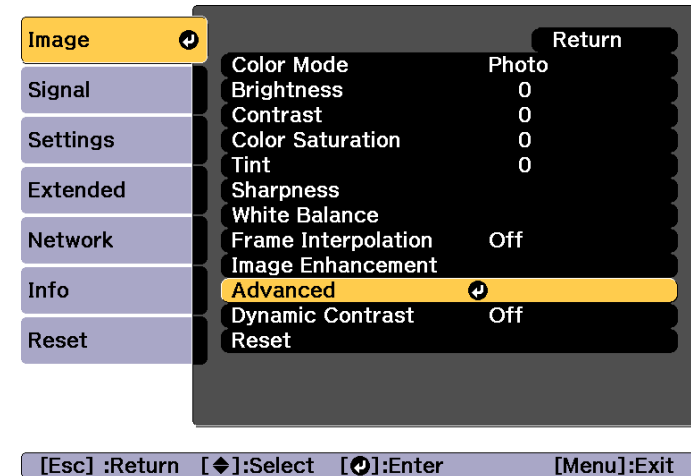

- 3 Select **Gamma**, and then press the [Enter] button.
- 4 Select **Customized**, and confirm using the [Enter] button.
- 5 Use the [Left][Right] buttons to select the tone that you want to change, and then use the [Up][Down] buttons to make the adjustments. When you have finished making changes, confirm by using the [Enter] button.

If you use the [Left][Right] buttons to select the tone that you want to change, the image flashes and you can check the tone area of the adjustment target.

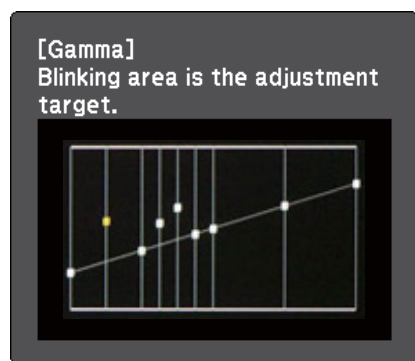

- 6** When **Do you want to continue adjusting the setting?** is displayed, select **Yes** or **No**.

To adjust another tone, select **Yes**, and repeat the procedure from step 5.

Frame Interpolation

The current and previous frames are used to create intermediate frames, interpolating to produce smooth-moving images. You can resolve clumsy-moving images, such as frame skipping when projecting a fast moving image.

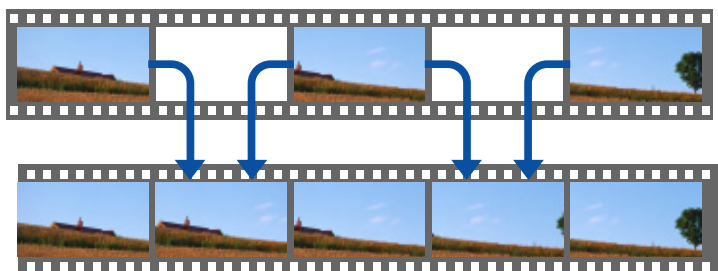

- 1** Press the [Menu] button while projecting.

- 2** Select **Frame Interpolation** from **Image**, and then press the [↵] button.

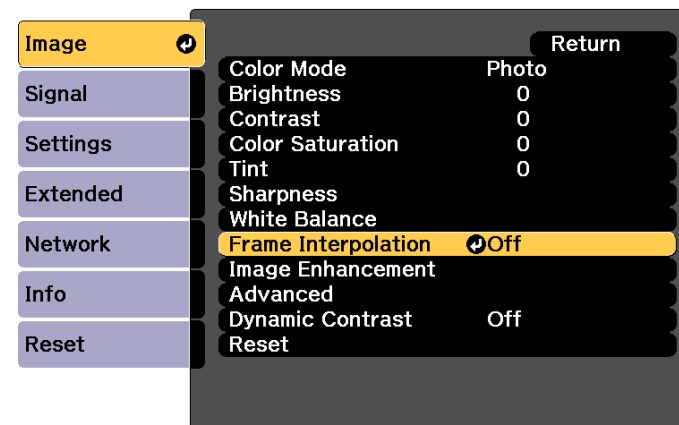

[Esc] :Return [◆]:Select [↵]:Enter [Menu]:Exit

- 3** Select the level of interpolation from **Low**, **Normal** or **High**. Set to **Off** if noise occurs after setting them.

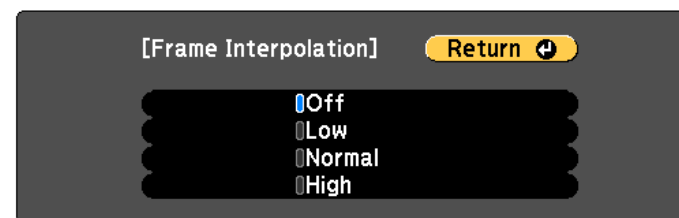

[Esc] / [↵]:Return [◆]:Select [Menu]:Exit

- 4** Press the [Menu] button to finish making settings.

Adjusting Image Resolution (Image Enhancement)

You can adjust the resolution of the image using **Image Enhancement** to reproduce a clear image with an emphatic texture and material feel.

- 1 Press the [Menu] button while projecting.
- 2 Select **Image Enhancement** from **Image**, and then press the [↵] button.

The following screen is displayed.

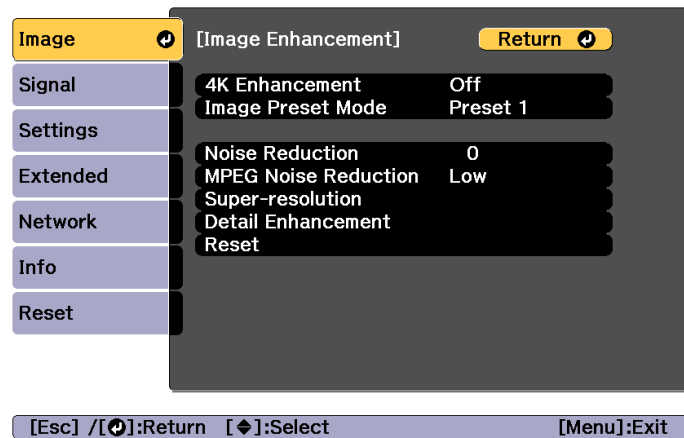

4K Enhancement (EB-L1755U/EB-L1750U/EB-L1505UH/EB-L1500UH only)

4K Enhancement is a function that projects an image at a doubled resolution by diagonally shifting 1 pixel in increments of 0.5 pixels.

A high-resolution image signal is projected in fine detail.

- 1 Select **4K Enhancement** from **Image Enhancement**, and then press the [↵] button.

- 2 Select one of the following, and then press the [↵] button.

Off: Disables 4K Enhancement. If a signal that exceeds the panel resolution of this projector is input, the image is displayed according to the panel resolution of this projector.

Full HD: If a signal with a resolution of 1080i/1080p/WUXGA or higher is input, 4K Enhancement is enabled.

WUXGA+: If a signal with a resolution that exceeds WUXGA is input, 4K Enhancement is enabled. To project a high-resolution movie, you can project a high-definition image by using this setting with **Image Preset Mode**.

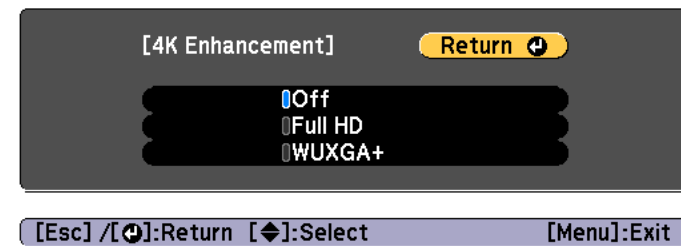

- To project from multiple projectors, select **Off** to unify each image.
- **Off** is ideal for projecting presentation materials from computers and so on.
- If set to **Full HD** or **WUXGA+**, the status corrected using the following function is canceled.
Edge Blending, Scale, Curved Surface, Point Correction, Corner Wall
When **4K Enhancement** is set to **Off**, the settings return to their previous state.

- 3 Press the [Esc] button to return to the previous screen.

Image Preset Mode

Select the optimal setting according to the projected image from five presets prepared in advance.

The following settings are saved in the presets.

Noise Reduction, MPEG Noise Reduction, Super-resolution, Detail Enhancement

1 Select **Image Preset Mode** from **Image Enhancement**, and then press the [↵] button.

2 Select one of the following, and then press the [↵] button.
Preset 1 to Preset 5: The settings saved in advance are applied to the image.

Off: Select this to turn off presets.

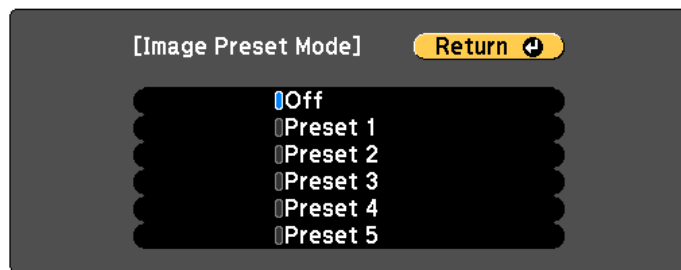

[Esc] / [↵]:Return [↻]:Select [Menu]:Exit



- After selecting **Preset 1 to Preset 5**, you can fine tune each setting individually. The setting after adjustment will be overwritten.
- The setting after adjustment will be overwritten separately when **4K Enhancement** is enabled and disabled.

3 Press the [Esc] button to return to the previous screen.

Noise Reduction

You can smooth out rough images for softer image quality when inputting progressive signals or progressive interlace signals.



This is disabled in the following cases.

- When **Image Processing** is set to **Fast 2**
- When **4K Enhancement** is enabled
- When a signal with a resolution that exceeds WUXGA is input
- When **Image Preset Mode** is **Off**

1 Select **Noise Reduction** from **Image Enhancement**, and then press the [↵] button.

2 Use the [◀][▶] buttons to adjust the value.

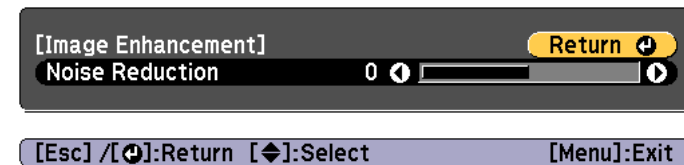

3 Press the [Esc] button to return to the previous screen.

MPEG Noise Reduction

You can reduce dot and block noise that occurs in outlines when projecting MPEG movies.



This is disabled in the following cases.

- When **4K Enhancement** is enabled
- When a signal with a resolution that exceeds WUXGA is input
- When **Image Preset Mode** is **Off**

- 1 Select **MPEG Noise Reduction** from **Image Enhancement**, and then press the [↵] button.
- 2 Select a level to reduce noise from **Low**, **Normal**, or **High**, and then press the [↵] button.

If **Off** is selected, **MPEG Noise Reduction** is disabled.

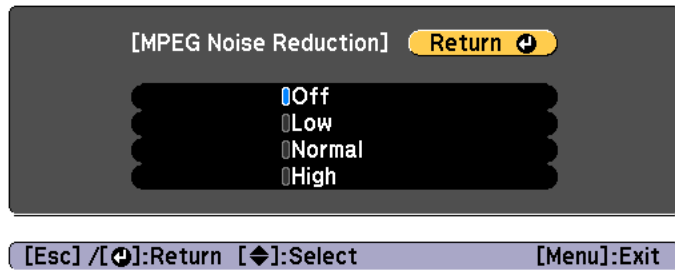

- 3 Press the [Esc] button to return to the previous screen.

Super-resolution

To display a crisp image, you can reduce the blurring that is created on the edge when the resolution of the image signal is scaled up and projected.



Disabled when **Image Preset Mode** is **Off**.

- 1 Select **Super-resolution** from **Image Enhancement**, and then press the [↵] button.

- 2 Use the [▲][▼] buttons to select the item, and then use the [◀][▶] buttons to make the adjustments.

Fine Line Adjust: If this parameter is set to a positive value, details such as hair or fabric patterns will be enhanced.

Soft Focus Detail: If this parameter is set to a positive value, the outline, background, and the other main parts of the objects in the image will be enhanced to show them clearly.

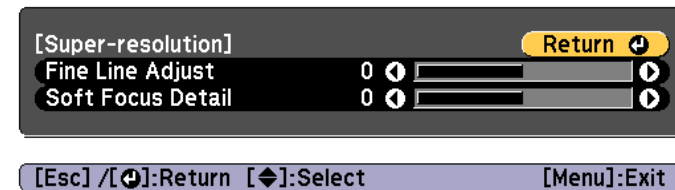

- 3 Press the [Esc] button to return to the previous screen.

Detail Enhancement

You can enhance the contrast in detailed areas of an image to create a more emphatic texture and material feel.



Disabled when **Image Preset Mode** is **Off**.

- 1 Select **Detail Enhancement** from **Image Enhancement**, and then press the [↵] button.

2 Use the [▲][▼] buttons to select the item, and then use the [◀][▶] buttons to make the adjustments.

Strength: The larger the value, the more the contrast is enhanced.

Range: The larger the value, the wider the range of detail enhancement becomes.

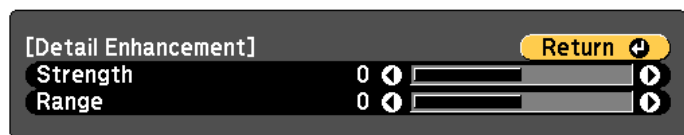

[Esc] / [◀]:Return [▶]:Select [Menu]:Exit



Depending on the image, a highlight may be noticeable at the border between colors. If this bothers you, set a smaller value.

3 Press the [Esc] button to return to the previous screen.

Projecting 3D Images (EB-L1505UH/EB-L1500UH/EB-L1515S/EB-L1510S only)

By using two projectors, you can project passive 3D images. The following are required to project and view 3D images.

- Polarizer
- Passive 3D glasses
- Mount for stacking
- Silver screen for passive 3D



This projector arranges the direction of polarizing projection for R (red), G (green), and B (blue). It is not necessary to inverse left and right eye G (green) image signals.



Useful Functions

This section describes the Multi-Projection, Split Screen, Memory, Schedule, and Security functions.

You can setup multiple projectors to project one large and wide image. You can adjust the difference of brightness and color tone between each projected image to create a seamless screen.



- Set **4K Enhancement** to **Off**. (EB-L1755U/EB-L1750U/EB-L1505UH/EB-L1500UH only)
- We recommend setting the focus, zoom, and lens shift at least 20 minutes after you start the projection, because images are not stable right after turning on the projector.
- If the values for **Geometry Correction** are large, the image position adjustment for overlapping images becomes difficult.
- The Test Pattern can be displayed to adjust the projection status without connecting video equipment.
 - ☛ "Displaying a Test Pattern" [p.32](#)
- If you project a dot by dot image that can be projected without being enlarged or reduced, you can make adjustments precisely.

Adjustment Procedure

Adjusting automatically online

Images from multiple projectors can be automatically adjusted to match the settings on the projector set as the master projector (Screen Matching).

However, when a particularly dark projector is included in the group, the brightness is automatically adjusted according to the dark projector. For the master projector, select a projector whose color and brightness you want to use as the standard.

- When you want the image to be as bright as possible:
Set **Light Source Mode** for all projectors to **Normal**. You can also set **Light Source Mode** to **Custom**, and **Brightness Level** to 100%.

- When you want to match to a specific brightness:
Set **Light Source Mode** to **Custom** for the projector with the darkest projected image, and then adjust **Brightness Level** to the brightness you want to use. Also, set this projector as the master projector.

☛ **Settings - Brightness Settings - Light Source Mode - Brightness Level** [p.148](#)

Advance preparation

- (1) Connect all projectors to a network hub using LAN cables.
- (2) Turning on the master projector.
- (3) Set an ID for the master projector and the remote control.
 - ☛ "Set the projector ID" [p.43](#)
- (4) Turn on all projectors.
- (5) Set the **DHCP** to **On** for all projectors, or check that IP addresses have been assigned.
 - ☛ **Network - Network Configuration - Wired LAN - IP Settings** [p.162](#)
- (6) Make sure that **Sleep Mode** is set to **Off** so that it does not turn off while adjusting.
 - ☛ **Extended - Operation - Sleep Mode** [p.150](#)

Adjusting the projected position

- (1) Adjust the position (angle) of the projector.
 - ☛ "Installation Settings" [p.30](#)
- (2) Adjust the arrangement of the images.
 - ☛ "Performing tiling automatically" [p.94](#)

Adjusting the projected images

- (1) Adjust the aspect ratio of the images.
 - ☛ "Screen Settings" [p.31](#)
 - ☛ "Changing the Aspect Ratio of the Projected Image" [p.81](#)

- (2) Adjust the lens shift.
 - ☛ "Adjusting the Position of the Projected Image (Lens Shift)" [p.34](#)
- (3) Adjust the zoom and focus.
 - ☛ "Adjusting the Image Size" [p.38](#)
 - ☛ "Correcting the Focus" [p.39](#)
- (4) Adjust small differences in the images.
 - ☛ "Point Correction" [p.75](#)
- (5) Adjust the edges of the images.
 - ☛ "Edge Blending" [p.97](#)
 - ☛ "Black Level" [p.99](#)
- (6) Adjust the brightness and tint of the images.
 - ☛ "Screen Matching" [p.102](#)
- (7) Select the sections of the images.
 - ☛ "Displaying a Scaled Image" [p.105](#)

Adjusting manually offline

Adjust the images from all projectors manually.

Advance preparation

- (1) Turn on all projectors.
- (2) Set an ID for all projectors and the remote controls.
 - ☛ "Set the projector ID" [p.43](#)

Adjusting the projected position

- (1) Adjust the position (angle) of the projector.
 - ☛ "Installation Settings" [p.30](#)
- (2) Adjust the arrangement of the images.
 - ☛ "Performing tiling manually" [p.96](#)

Adjusting the projected images

- ☛ "Adjusting the projected images" [p.93](#)

Tiling

Project the same image from multiple projectors to create one large image. You can project by using up to nine projectors.

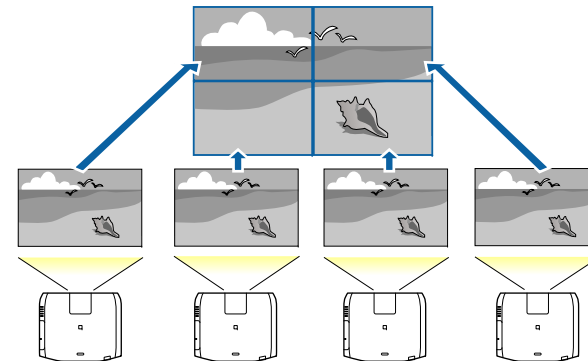

Before performing tiling, adjust the projected image so that it is a rectangle. Also, adjust the size and focus of the images.

- ☛ "Adjusting the Image Size" [p.38](#)

- ☛ "Correcting the Focus" [p.39](#)

Performing tiling automatically

This section explains how to select the projector being used in **Projector Grouping**, and then automatically configure the images being projected.



Location setup is performed using the camera built into the front of the projector. Do not block the camera or the projected images.

- 1 Press the [Menu] button while projecting.
- 2 Select **Multi-Projection** from **Extended**, and then press the [↵] button.
- 3 Select **Projector Grouping**, and then press the [↵] button.
- 4 Select the projectors that will be used for tiling, and then press the [↵] button.

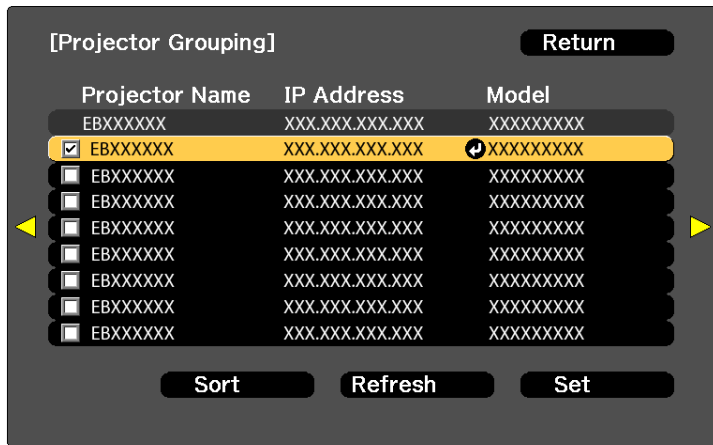

[Esc] :Return [↕]:Select [⏏]:Set [Menu]:Exit

- (1) Select the projectors you want to use to enter a checkmark. Select **Refresh** to update the list. Select **Sort** to sort the projector order.
 - (2) Select **Set**, and then press the [↵] button.
- 5 Select **Tiling**, and then press the [↵] button.
 - 6 Select **Tiling**. Select **Auto**, and then press the [Esc] button.

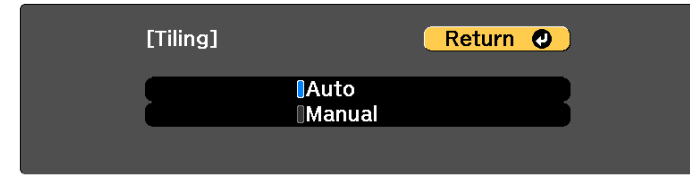

[Esc] /[⏏]:Return [↕]:Select [Menu]:Exit

- 7 Select **Location Setup**, and then press the [↵] button. The image is positioned automatically.

When the message "Assign IDs to projectors that have been located. Do you want to continue?" is displayed, select **Yes**.

When setup is complete, the following screen is displayed.



[Esc] /[⏏]:Return [↔]:Move [Menu]:Exit



If the image is not located correctly, select **Manual** in step 6, and then follow the steps below to locate the image manually.

- (1) Set **Row** and **Column** in **Layout**.
- (2) Select **Set**, and then press the [**↵**] button.
- (3) Select the location in **Location Setup**, and then press the [**↵**] button.
- (4) Repeat step (3) to reposition the location of all projectors.
- (5) Select **Set**, and then press the [**↵**] button.

8 Input the image signal to display the image.

☛ "Automatically Detecting Input Signals and Changing the Projected Image (Source Search)" [p.62](#)

When tiling is complete, adjust any positional gaps and the tint of the projected images.

☛ "Adjusting the projected images" [p.93](#)



- After tiling is complete, do not change the IP addresses or projector names of the projectors. Otherwise the image will not be adjusted automatically.
- After tiling is complete, you can set each projector with one remote control. Select the projector ID for the projector you want to set with the remote control. You can check the projector ID in **Tiling - Location Info**.
☛ "Setting the remote control ID" [p.44](#)

Performing tiling manually

This section explains how to perform location settings for the image manually without performing **Projector Grouping**.

1 Press the [Menu] button while projecting.

2 Select **Multi-Projection** from **Extended**, and then press the [**↵**] button.

3 Select **Tiling**, and then press the [**↵**] button.

4 Select **Layout**, and then press the [**↵**] button.

- (1) Set the number of projectors in **Row** and **Column**.
- (2) Select **Set**, and then press the [**↵**] button.

5 Repeat steps 1 to 4 for each projector to be used for tiling.

6 Select **Location Setup**, and then press the [**↵**] button.

- (1) Set the positions of the projected images in **Row Order** and **Column Order**.
Row Order: Place screens from top to bottom in the order of 1, 2, 3.
Column Order: Place screens from left to right in the order of A, B, C.

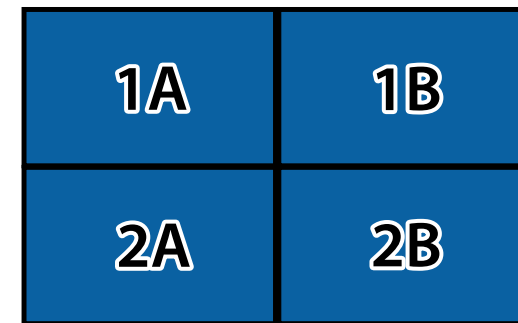

- (2) Select **Set**, and then press the [**↵**] button.

7 Repeat step 6 for each projector.

8 Input the image signal to display the image.

☛ "Automatically Detecting Input Signals and Changing the Projected Image (Source Search)" [p.62](#)

When tiling is complete, adjust any positional gaps and the tint of the projected images.

☛ "Adjusting the projected images" p.93

Edge Blending

You can fine tune the overlapping areas to make seamless screen.

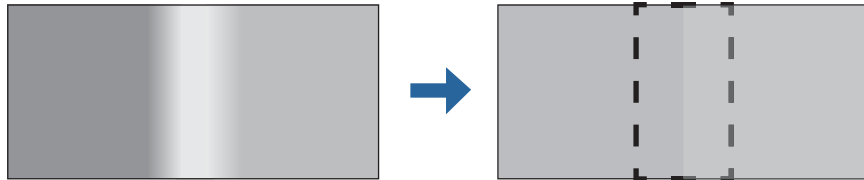

Before performing edge blending to raise the precision of adjustments, press the [Color Mode] button on the remote control, and then set **Color Mode** to **Multi-Projection**.

- 1** Press the [Menu] button while projecting.
- 2** Select **Multi-Projection** from **Extended**.
- 3** Select **Edge Blending**, and then press the [↵] button.
The following screen is displayed.

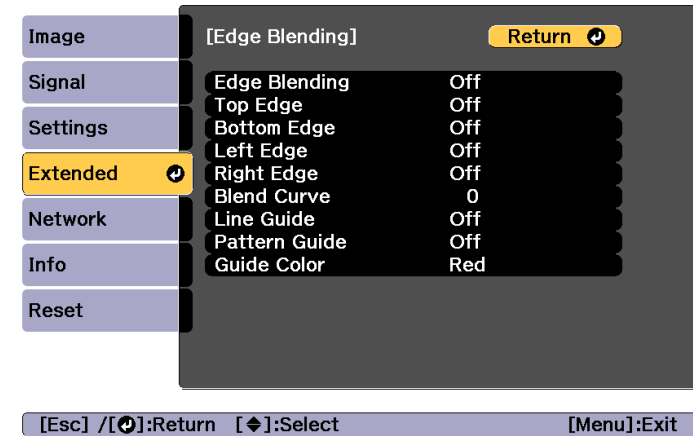

Submenu	Function
Edge Blending	Set to On to activate Edge Blending. Set to Off when not projecting from multiple projectors.
Top Edge/Bottom Edge/Left Edge/Right Edge	<p>Blending: Set to On to activate Edge Blending towards your settings, and the blend range will be shaded.</p> <p>Blend Start Position: Displays blending start position as a red line, and adjusts at the level of one pixel.</p> <p>Blend Range: Adjusts the range to be shaded. Adjustment is possible at the level of one pixel. The maximum range is 45% of the resolution.</p>
Blend Curve	You can select from 16 ways of shading.
Line Guide	Set to On to display a guide on the Edge Blending setting range.
Pattern Guide	Set to On to display a guide to match the position of the Edge Blending setting range.
Guide Color	Select a combination of guide colors from the six provided.

- 4** Turn on Edge Blending.
- (1) Select **Edge Blending**, and then press the [**↵**] button.
 - (2) Select **On**, and then press the [**↵**] button.
 - (3) Press the [Esc] button.

- 5** Set **Line Guide** to **On**.
- (1) Select **Line Guide**, and then press the [**↵**] button.
 - (2) Select **On**, and then press the [**↵**] button.
 - (3) Press the [Esc] button.



If the guide is not clear, you can change the color of the guide in **Guide Color**.

- 6** Set **Pattern Guide** to **On**.
- (1) Select **Pattern Guide**, and then press the [**↵**] button.
 - (2) Select **On**, and then press the [**↵**] button.
 - (3) Press the [Esc] button.

- 7** Set **Top Edge**, **Bottom Edge**, **Left Edge**, or **Right Edge** according to the parts of the image that are overlapped.
- The following shows how to set screen (1) as an example.

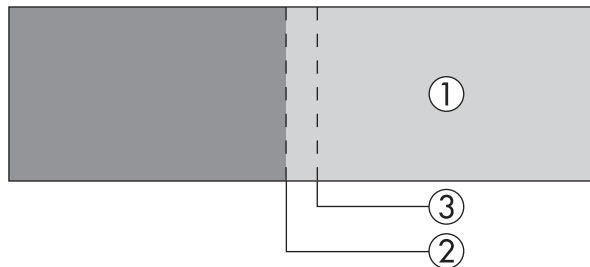

In the example above, you need to adjust the **Left Edge** because you can see the overlapping areas on the left side of the image (1).

- (1) Select **Left Edge**, and then press the [**↵**] button.
- (2) Select **Blending**, and then press the [**↵**] button.
- (3) Select **On**, and then press the [**↵**] button.
- (4) Press the [Esc] button.
- (5) In **Blend Start Position**, align the blending start position with the edge (2) of the image.
- (6) Press the [Esc] button.
- (7) In **Blend Range**, adjust the range (3) to be shaded.
The value for when the overlapped range and the guide are in the same position is the best.

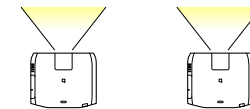
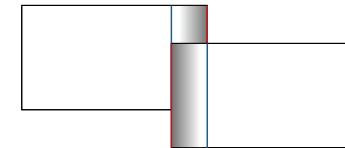

- (8) Press the [Esc] button.

- 8** Set **Blend Curve**.
- (1) Select **Blend Curve**, and then press the [**↵**] button.
 - (2) Select the amount of shading from **0** to **15**, and then press the [**↵**] button.
 - (3) Press the [Esc] button.
- 9** After the settings are complete, set **Line Guide** and **Pattern Guide** to **Off** to finish.

Black Level

When a black image is displayed, only areas where the images overlap stand out. The black level function allows you to match the brightness and tone for areas where the images do not overlap with areas where the images overlap, to make the difference less noticeable.

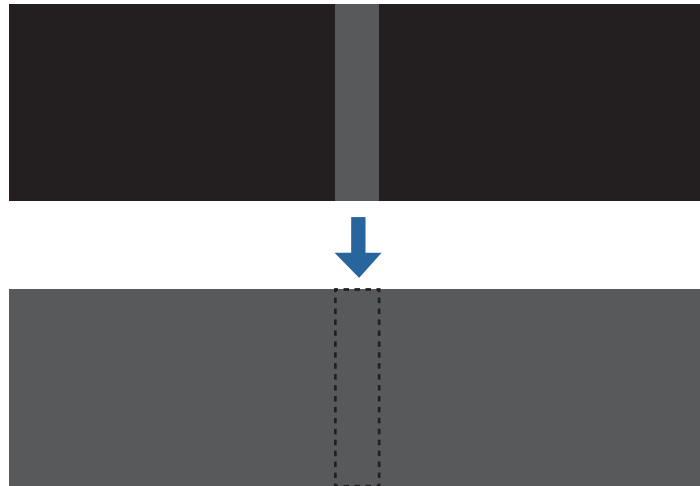

- You cannot adjust the Black Level when a test pattern is displayed.
- If the **Geometry Correction** value is large, you may not be able to adjust correctly.
- The brightness and tone may differ in areas where the images overlap as well as in other areas even after performing black level adjustment.
- If you change the **Top Edge/Bottom Edge/Right Edge/Left Edge** setting, the Black Level is returned to its default value.
 - ☛ "Edge Blending" p.97
- When auto adjustment starts for Screen Matching, the settings for Color Adjustment are automatically adjusted.
 - ☛ "Automatically correct the brightness and tint for multiple projectors" p.103

- 1 Select **Black Level** from **Multi-Projection**, and then press the [**↵**] button.

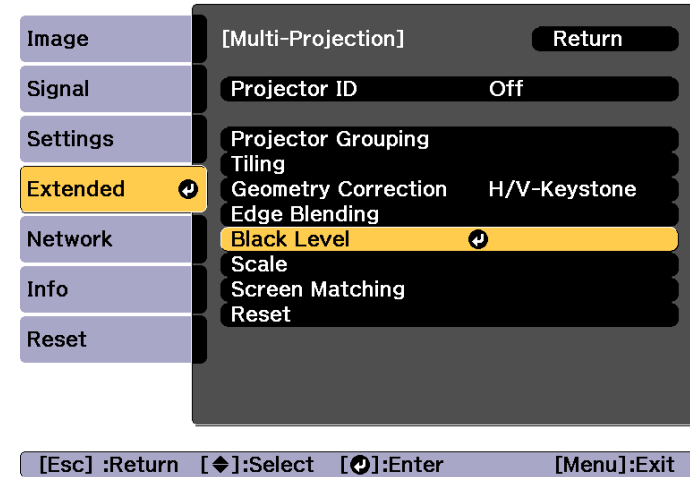

- 2 Select **Color Adjustment**, and then press the [**↵**] button.

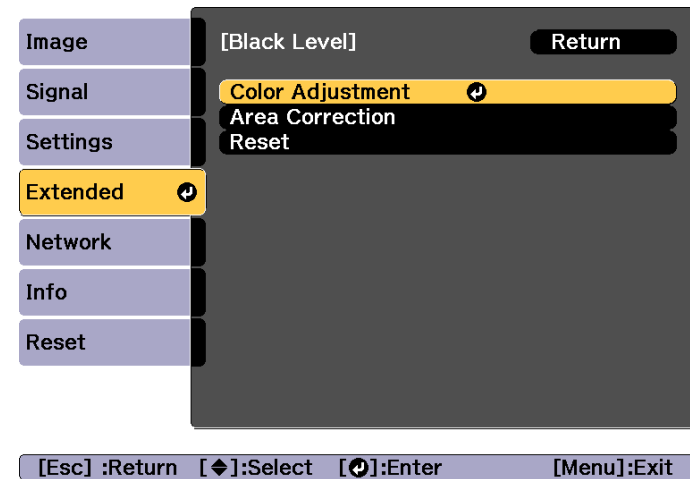

The areas are displayed based on the settings for **Top Edge/Bottom Edge/Right Edge/Left Edge**.

- 3** Select the area you want to adjust, and then press the [**↵**] button.

The selected area is displayed in orange.



When multiple screens are overlapping, adjust based on the area with the most overlap (the brightest area). In the illustration below, first align (2) with (1), and then adjust so that (3) aligns with (2).

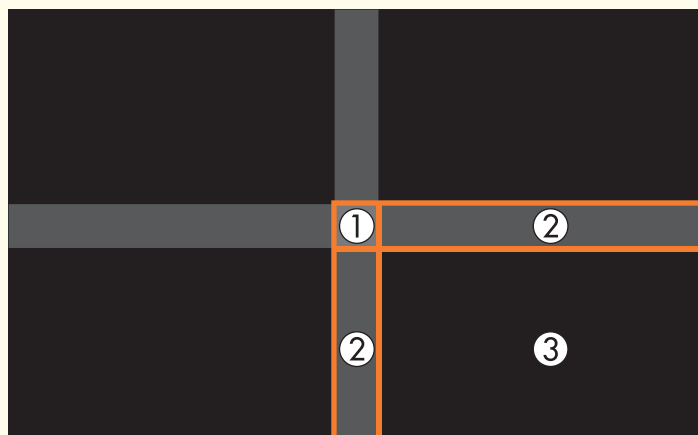

- 4** Adjust the black tone and brightness.

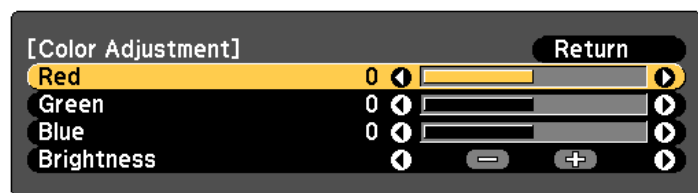

[Esc] :Return [↵]:Select [↔]:Adjust [Menu]:Exit
[Default] :Reset

- 5** Repeat steps 3 and 4 as needed to adjust any remaining parts.



After this, if the tone for some areas do not match, adjust them by **Area Correction**.

- 6** Press the [Esc] button, to return to the screen displayed in step 2.

- 7** Select **Area Correction**, and then press the [**↵**] button.

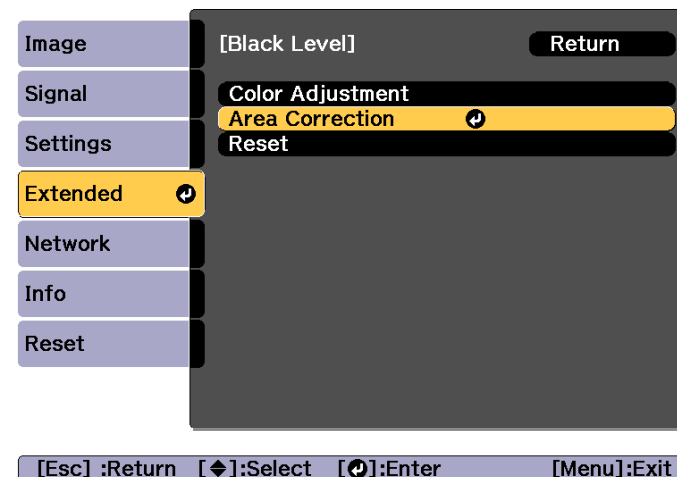

- 8** Select **Start Adjustments**, and then press the [**↵**] button.

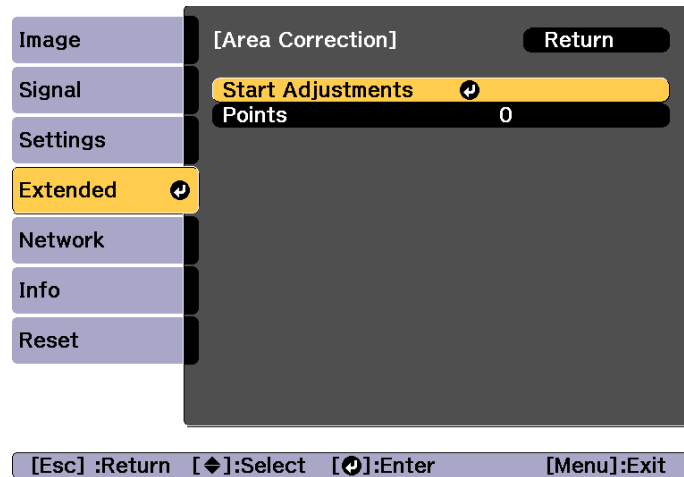

Boundary lines that indicate areas where images overlap are displayed.

The boundary lines are displayed based on the settings for **Top Edge/Bottom Edge/Right Edge/Left Edge**.

- 9** Use the [▲][▼][◀][▶] buttons to select a boundary line of the area you want to adjust.

The selected line is displayed in orange.



- 10** Press the [↵] button to confirm the selection.



- 11** Use the [▲][▼][◀][▶] buttons to adjust the boundary line positions, and then press the [↵] button.

- 12** Press the [▲][▼][◀][▶] buttons to select the point you want to move, and then press the [↵] button.

The selected point is displayed in orange.

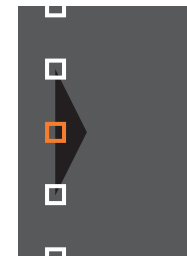

- 13** Press the [▲][▼][◀][▶] buttons to move the point.

To continue to move another point, press the [Esc] button to return to step 12, and then repeat steps 12 and 13.

To adjust another boundary line, press the [Esc] button until the screen for selecting a boundary line from step 9 is displayed.



To return **Black Level** to its default value, press the [Esc] button to return to the screen from step 7, select [Reset], and then press the [↵] button.

- 14** To complete the adjustment, press the [Menu] button.

Screen Matching

Adjust the tint and brightness for multiple projectors.

When projectors are connected to a network, the tint and brightness for multiple projectors are auto adjusted based on the master projector's adjustment values.

When projectors are not connected to a network, or if auto adjustment does not work, you can adjust the tint and brightness for all projectors manually.



- We recommend performing Screen Matching 20 minutes after turning on the projector or canceling A/V mute.
- To increase the accuracy of adjustments, we recommend darkening the room while projecting images and then making adjustments.
- Perform the following on the master projector before starting adjustments.
 - Set the **Color Mode** to **Multi-Projection** with the remote control's [Color Mode] button.
 - Press the [A/V Mute] button on the remote control to cancel A/V Mute.
 - Adjust the following items on the Image menu as necessary. Brightness, Contrast, Color Saturation, Tint, White Balance, Advanced
 - ☛ "Image Menu" [p.143](#)
 - Set the brightness of the projected image.
 - ☛ "Setting the Brightness" [p.77](#)
- When there are large differences in the brightness for each projector due to aging light sources, perform Screen Matching again.
- By using the scheduling function, you can automatically adjust the tint and brightness at the time you set.
 - ☛ "Scheduling Function" [p.116](#)
- See the following if Screen Matching does not work correctly.
 - ☛ "Automatic adjustments are not performed correctly" [p.198](#)

Operating conditions for auto adjustment functions

The auto adjustment functions for Screen Matching are enabled when the following conditions are met.

- The screen surface is flat and not skewed or warped
- Using a matte white diffusion screen
- The projection size is 80 to 200 inches
- The projected image after tiling is rectangular

- All projected images are lined up with no gaps (We recommend using 15 to 45% as the width of overlapping images)
- The projector is setup parallel to the projection surface



- Auto adjustment is not available when using the following lenses.
ELPLX02, ELPLR04, ELPLL08, ELPLL07/
ELPLU03, ELPLU04, ELPLU02 (EB-L1755U/EB-L1750U/EB-L1715S/
EB-L1710S)
- After auto adjustment, the movement range for lens shift is reduced for some lenses.
☛ "Adjusting the Position of the Projected Image (Lens Shift)"
p.34

Automatically correct the brightness and tint for multiple projectors

Automatically correct the brightness and tint for the projectors selected in **Projector Grouping** based on the brightness and tint set for the master projector.



- Check the following before starting auto adjustment.
 - The projector is connected to the network
 - The **Location Setup** for the projector has already been set
- Auto adjustment is performed using the camera built into the front of the projector. Do not block the camera or the projected images.
- The time necessary for auto adjustment varies according to the location and number of projectors and can take up to approximately 12 minutes.
- Settings are auto adjusted for Brightness Settings and Black Level (**Color Adjustment** only).
- After making automatic adjustments, Color Uniformity and Color Matching are returned to their defaults.

1 Select **Screen Matching** from **Multi-Projection**, and then press the [↵] button.

2 Select **Start Auto Adjustment**, and then press the [↵] button.

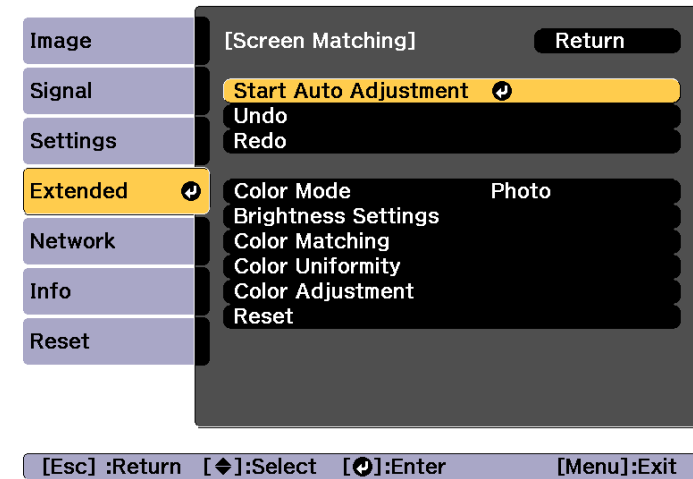

The adjustment pattern is displayed, and adjustment starts. If the projected image is displayed before the adjusting, the procedure is complete.



- See the following if an error occurs.
 - ☛ "Automatic adjustments are not performed correctly" p.198
- To return to the status before auto adjustment, select **Undo**. When you select **Redo** after selecting **Undo**, it returns the image to the status after auto adjustment.
- To return **Screen Matching** to its default value, select **Reset**.
- When **Constant Brightness** in **Brightness Settings** is set to **On** and you want to adjust **Brightness Level** after performing screen matching, select **Reset**.

Color Matching

You can fine tune the color balance and brightness from black to white for each color tone.

When the projectors are not connected to a network, or if you want to adjust manually after the automatic adjustments, perform the following steps on all projectors.

1 Select **Screen Matching** from **Multi-Projection**, and then press the [**↵**] button.

2 Select **Color Matching**, and then press the [**↵**] button.

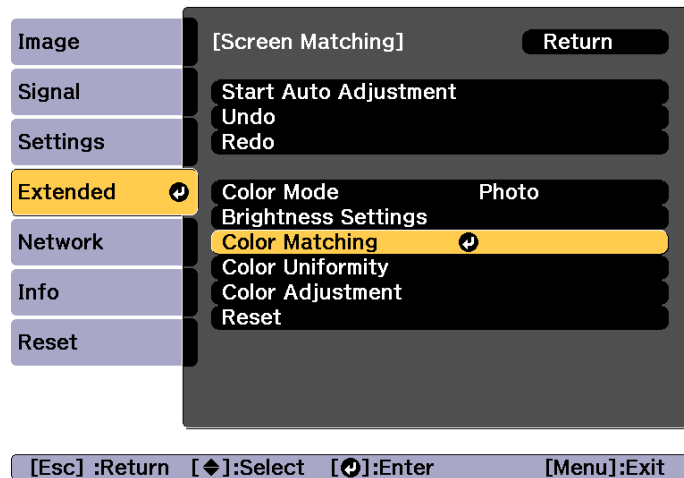

The following screen is displayed.

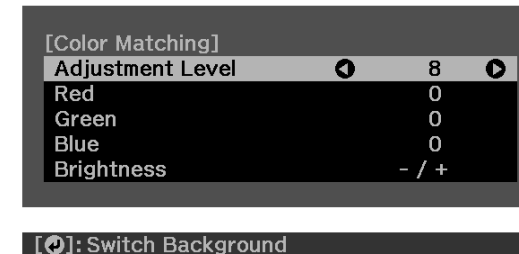

Half of the overlapped area is displayed in black so that it is easy to check the edge of the image.

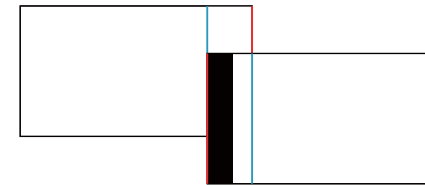

Adjustment Level: There are eight levels from white, through gray, and up to black. You can adjust each level individually.

Red, Green, Blue: Adjusts the tone for each color.

Brightness: Adjusts the image brightness.



Whenever the [**↵**] button is pressed, the screen changes between the projected image and the adjustment screen.

3 Select **Adjustment Level**, and then use the [**◀**][**▶**] buttons to set the adjustment level.

4 Select **Red**, **Green**, or **Blue**, and then press the [**◀**][**▶**] buttons to adjust the color tone.

5 Select **Brightness**, and then use the [**◀**][**▶**] buttons to adjust the brightness.

- 6 Return to step 2 and adjust each level.
- 7 Press the [Esc] button to return to the previous screen.

Displaying a Scaled Image

A section of the image is cropped and displayed. This allows you to create one large image by combining images projected from multiple projectors.

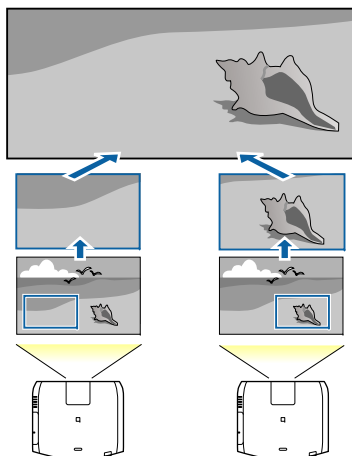

- 1 Project the image, and then press the [Menu] button.
- 2 Select **Multi-Projection** from **Extended**.



You can also perform the same operation from **Scale** in **Signal**.

- 3 Select **Scale**, and then press the [↵] button.

- 4 Turn on **Scale**.

- (1) Select **Scale**, and then press the [↵] button.
- (2) Select **Auto** or **Manual**, and then press the [↵] button.

Auto: Automatically adjusts the clipped area according to the adjustment values in Edge Blending and Tiling. You do not need to perform any steps after step 6.

Manual: Allows you to adjust the clipped area manually.

- (3) Press the [Esc] button to return to the previous screen.



If auto adjustment does not work for the clipped image, adjust the aspect ratio, and then select **Auto**.

☞ "Changing the Aspect Ratio of the Projected Image" p.81

- 5 Set **Scale Mode**.

- (1) Select **Scale Mode**, and then press the [↵] button.

- (2) Select **Zoom Display** or **Full Display**, and then press the [**↵**] button.

Zoom Display: Adjusts according to the image currently displayed.

Enlarge



Move



Full Display: Adjusts according to the projector's panel size (the maximum area in which an image can be displayed).

Enlarge



Move



- (3) Press the [Esc] button to return to the previous screen.

6 Adjust the scale.

Select the adjustment method with the [**▲**][**▼**] buttons, then adjust using the [**◀**][**▶**] buttons.

-+: Enlarges or reduces an image horizontally and vertically at the same time.

Scale Vertically: Enlarges or reduces an image vertically.

Scale Horizontally: Enlarges or reduces an image horizontally.

7 The image is clipped and adjusted.

- (1) Select **Clip Adjustment**, and then press the [**↵**] button.
If you select **Clip Range**, the range and coordinates of the image that the projector will project is displayed.
- (2) Use the [**▲**], [**▼**], [**◀**], and [**▶**] buttons to scroll the image.
Adjust the coordinates and size of each image while viewing the screen.
- (3) Press the [Menu] button to finish making settings.



You can check the displayed area after clipping for the entire image from **Clip Range**.

Projecting Two Images Simultaneously (Split Screen)

You can simultaneously project images from two sources on the right and left of the screen.

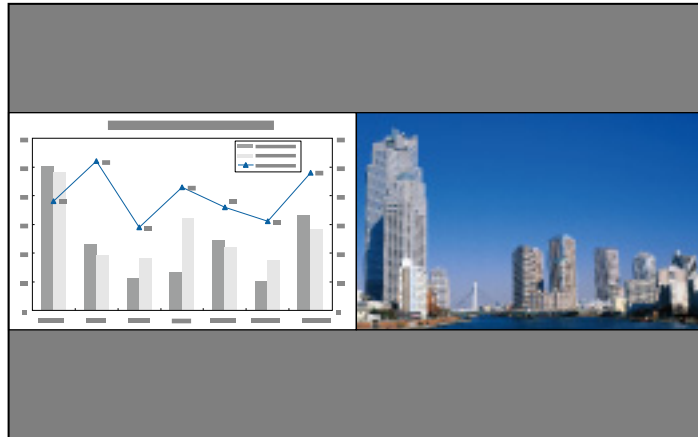

Input Sources for Split Screen Projection

The combinations of input sources that can be projected on a split screen are listed below.

Left Screen	Right Screen						
	HDMI	HDBa-seT	DVI-D	SDI*	Com-puter	BNC	LAN
HDMI	-	✓	✓	✓	✓	✓	✓
HDBaseT	✓	-	✓	✓	✓	✓	✓
DVI-D	✓	✓	-	✓	✓	✓	✓
SDI*	✓	✓	✓	-	-	-	-
Computer	✓	✓	✓	-	-	-	-
BNC	✓	✓	✓	-	-	-	-
LAN	✓	✓	✓	-	-	-	-

* EB-L1755U/EB-L1750U/EB-L1505UH/EB-L1500UH only



- Signals that exceed WUXGA are not supported.
- If **4K Enhancement** is enabled, a message is displayed. Select **Yes** to disable **4K Enhancement**. (EB-L1755U/EB-L1750U/EB-L1505UH/EB-L1500UH only)
 - ☛ **Image - Image Enhancement - 4K Enhancement** [p.143](#)

Operating procedures

Projecting on a split screen

- 1 Press the [Split] button on the remote control while projecting. The currently selected input source is projected on the left of the screen.

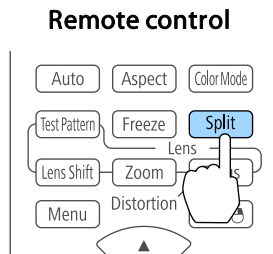

You can perform the same operations from the configuration menu.

☛ [Settings - Split Screen p.148](#)

- 2 Press the [Menu] button. The Split Screen Setup screen is displayed.

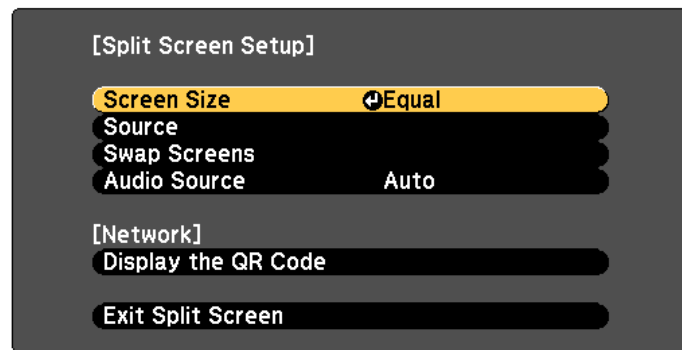

[↔]:Select [↵]:Enter [Menu]:Exit

- 3 Select **Source**, and then press the [↵] button.
- 4 Select each input source for **Left** and **Right**.

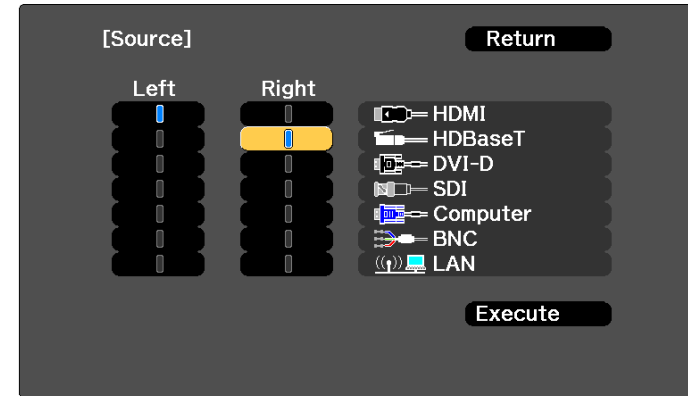

[Esc]:Return [↔]:Select [↵]:Set [Menu]:Exit



You can perform the same operations using the following procedure.

☛ "Automatically Detecting Input Signals and Changing the Projected Image (Source Search)" [p.62](#)

☛ "Switching to the Target Image by Remote Control" [p.63](#)

- 5 Select **Execute**, and then press the [↵] button. To switch the source during split screen projection, start the procedure from step 2.

Switching the left and right screens

Use the following procedure to switch the projected images displayed on the left and right screens.

- 1 Press the [Menu] button during split screen projection.

- 2 Select **Swap Screens**, and then press the [↵] button.
The projected images on the left and right are swapped.

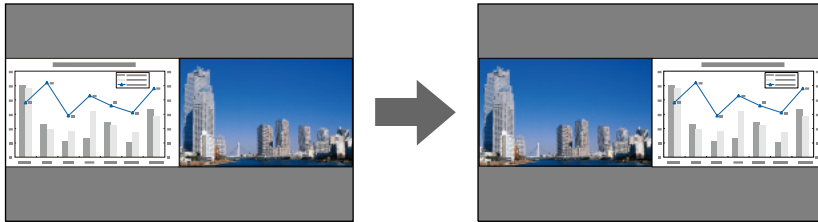

Switching the left and right image sizes

- 1 Press the [Menu] button during split screen projection.
- 2 Select **Screen Size**, and then press the [↵] button.
- 3 Select the screen size you want to display, and then press the [↵] button.

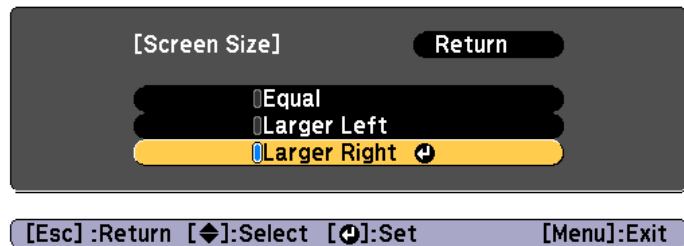

The projected images will appear as shown below after setting the screen size.

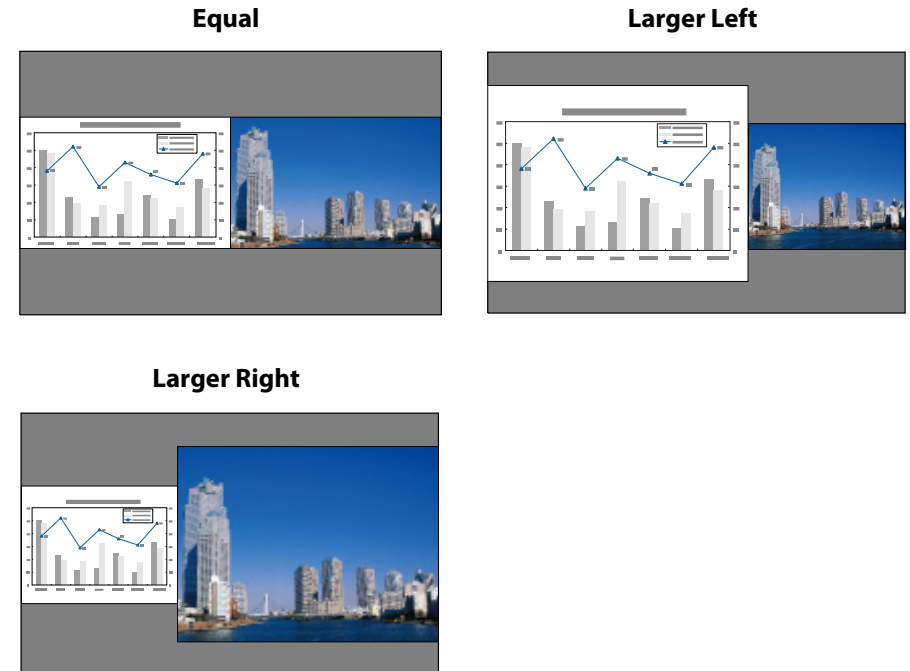

- You cannot enlarge both the left screen and right screen images at the same time.
- When one image is enlarged, the other image is reduced.
- Depending on the video signals that are input, the images on the left and right may not appear to be the same size even if **Equal** is set.

Changing the audio

- 1 Press the [Menu] button during split screen projection.
- 2 Select **Audio Source**, and then press the [↵] button.

- 3** Select the audio you want to output, and then press the [↵] button.

When you select **Auto**, audio is output for the enlarged screen. If the screen sizes are **Equal**, audio is output for the screen on the left.

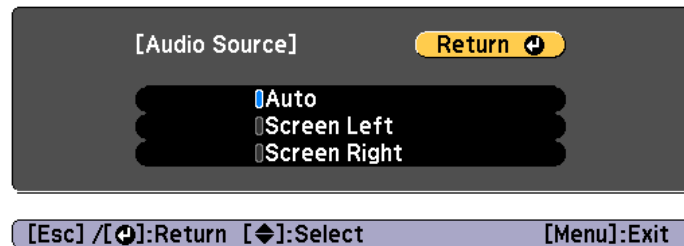

Ending the split screen

Press the [Esc] button to end split screen.

The following steps can also be used to end the split screen.

- Press the [Split] button on the remote control.
- Select **Exit Split Screen** on the Split Screen Setup screen.  [p.108](#)

Restrictions during split screen projection

Operating restrictions

The following operations cannot be performed during split screen projection.

- Setting the configuration menu
- E-Zoom
- Changing the aspect mode
- Using the [User1], [User2], or [User3] button on the remote control
- Help can be displayed only when image signals are not input or when an error or warning notification is displayed.
- The user's logo is not displayed.

Restriction relating to images

- For the image on the right screen, the default values for the **Image** menu are applied. However, the settings for the image projected on the left screen are applied to the image on the right screen for **Color Mode**, **Color Temp.**, and **Super-resolution**.
- **Dynamic Contrast** and **Frame Interpolation** are not available.

Hiding the Image and Sound Temporarily (A/V Mute)

You can use this when you want to focus the audience's attention on what you are saying, or if you do not want to show details such as when you are changing between files during presentations from a computer.

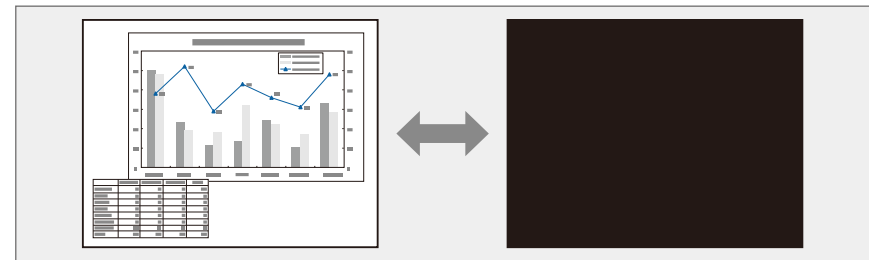

Each time you press the [A/V Mute] button, A/V Mute turns on or off.

Remote control

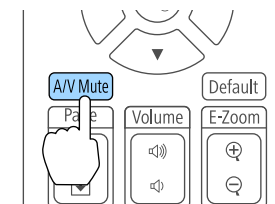



- If you want to fade out or fade in when turning the video on or off, set the desired number of seconds in **Fade-out** and **Fade-in**.
Extended - Operation - A/V Mute Settings - Fade-out, Fade-in p.150
- When A/V mute is activated and no operations are performed for about 2 hours, the projector turns off automatically. If you do not want to turn off the power, set **A/V Mute Timer** to **Off**.
Extended - Operation - A/V Mute Settings - A/V Mute Timer p.150
- When **A/V Mute Release** is set to **A/V Mute** from the configuration menu, the following operations can still be performed without releasing A/V mute.
 - Change the source with the change input buttons on the remote control.
 - Control the projector from a computer using communication commands.**Extended - Operation - A/V Mute Settings - A/V Mute Release p.150**
 A/V mute is only released by pressing the [A/V Mute] button, or by sending an A/V mute Off command.
- When projecting moving images, the images and sound continue to be played back while A/V Mute is on. It is not possible to resume projection from the point where A/V Mute was activated.

Freezing the Image (Freeze)

When Freeze is activated on moving images, the frozen image continues to project on the screen, so you can project a moving image one frame at a time like a still photo. Also, you can perform operations such as changing between files during presentations from a computer without projecting any images if the Freeze function is activated beforehand.

Each time you press the [Freeze] button, Freeze turns on or off.

Remote control

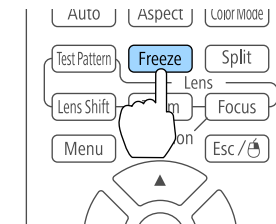

- Audio does not stop.
- When projecting moving images, the images continue to be played back while the screen is frozen. It is not possible to resume projection from the point where the screen was frozen.
- If the [Freeze] button is pressed while the Configuration menu or the Help screen is displayed, the menu or the Help screen that is displayed is closed.
- Freeze still works while E-Zoom is being used.

Enlarging Part of the Image (E-Zoom)

This is useful when you want to expand images to see them in greater detail, such as graphs and tables.

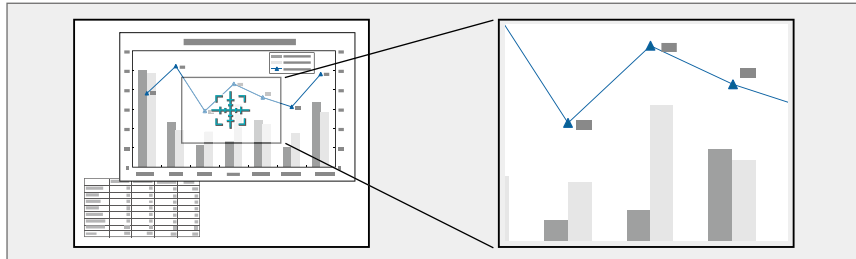

1 Start E-Zoom.

Press the [⊕] button to display the Cross (⊕).

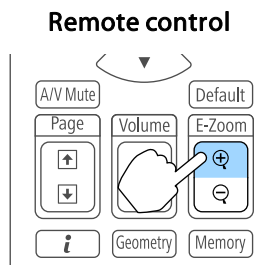

2 Move the Cross (⊕) to the area of the image that you want to enlarge.

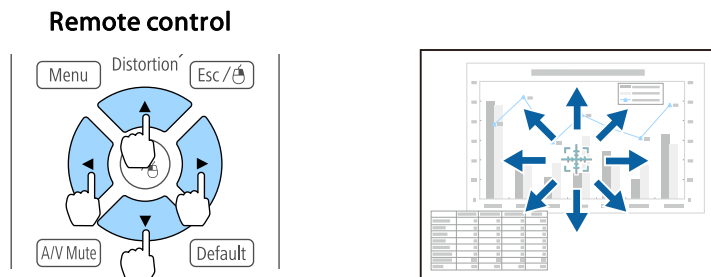

3 Enlarge.

Remote control

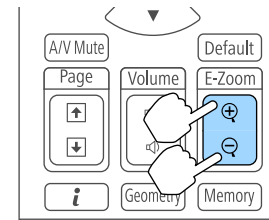

[⊕] button: Expands the area each time it is pressed. You can expand quickly by holding the button down.

[⊖] button: Reduces images that have been enlarged.

[Esc] button: Cancels E-Zoom.



- During enlarged projection, press the [▲], [▼], [◀], or [▶] buttons to scroll the image.
- E-Zoom is unavailable when **Scale** is on.
👉 **Signal - Scale** p.146
- If **4K Enhancement** is enabled, a message is displayed. Select **Yes** to disable **4K Enhancement**. (EB-L1755U/EB-L1750U/EB-L1505UH/EB-L1500UH only)
👉 **Image - Image Enhancement - 4K Enhancement** p.143

Saving a User's Logo

You can save the image that is currently being projected as a User's Logo.



Once a User's Logo has been saved, the logo cannot be returned to the factory default.

- 1 Project the image you want to save as the User's Logo, and then press the [Menu] button.

☛ "Using the Configuration Menu" p.140

- 2 Select **User's Logo** from **Extended**.



- When **User's Logo Protection** from **Password Protection** is set to **On**, a message is displayed and the User's Logo cannot be changed. Perform operations after setting **User's Logo Protection** to **Off**.

☛ "Managing Users (Password Protection)" p.120

- If **User's Logo** is selected when Geometry Correction, E-Zoom or Aspect are being performed, the function currently being performed is temporarily cancelled.

- 3 When the message "Choose this image as the User's Logo?" is displayed, select **Yes**.



When you press the [↵] button, the screen size may change depending on the signal to match the actual resolution of the image signal.

- 4 Move the box to select the part of the image to use as the User's Logo.

You can perform the same operations from the projector's control panel.

Remote control

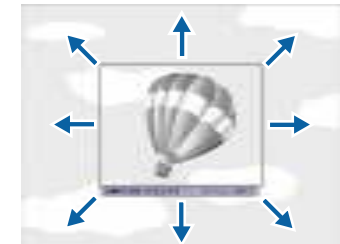
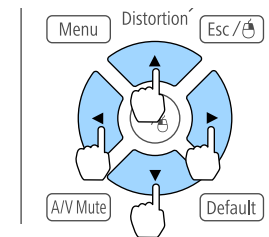

You can save at 400x300 dots in size.

- 5 When you press the [↵] button and the message "Select this image?" is displayed, select **Yes**.

- 6 Select the zoom factor from the zoom setting screen.

- 7 When the message "Save this image as the User's Logo?" is displayed, select **Yes**.

The image is saved. After the image has been saved, the message "Completed." is displayed.



When a User's Logo is saved, the previous User's Logo is erased.

The settings for the image currently displayed and values for geometry correction are saved as a memory, allowing you to load them when necessary.

Saving/Loading/Erasing/Resetting the Memory

- 1 Press the [Memory] button while projecting.

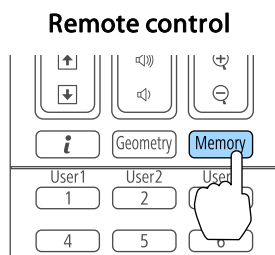

You can also operate from the Configuration menu.

☛ Settings - Memory [p.148](#)

- 2 Select a memory type, and then press the [↵] button.

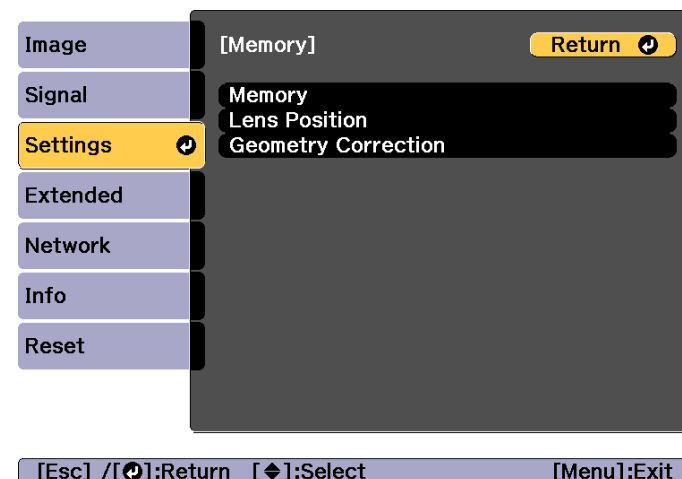

Memory: Settings for the following menu items are saved in the memory. You can register up to 10 values.

Top Menu	Submenu
Image	All setting items
Signal	Scale
Extended	Edge Blending Black Level Color Matching

Lens Position: Registers the position of the lens adjusted using lens shift, zoom, focus, and distortion. You can register up to 10 values.
☛ "Registering and Loading Lens Adjustment Values" [p.41](#)

Geometry Correction: Adjustment value of the geometry correction is saved. You can register up to 3 values.

- 3 Select the function you want to perform, then press the [↵] button.

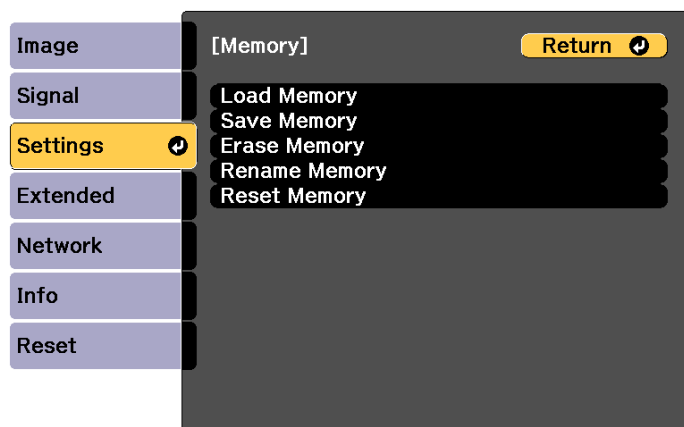

[Esc] / [Return]:Return [Left Arrow]:Select [Menu]:Exit

Function	Explanation
Load Memory	Loads the saved memory. When you select a memory and press the [Left Arrow] button, the settings applied to the current image are replaced with the settings from the memory.
Save Memory	Registers current settings in the memory. When you select a memory name and press the [Left Arrow] button, the settings are saved.
Erase Memory	Erases the registered memory. When you select a memory name and press the [Left Arrow] button, a message is displayed. Select Yes , and then press the [Left Arrow] button to erase the selected memory.
Rename Memory	Changes the memory name. Select the memory name you want to change, and then press the [Left Arrow] button. Enter the memory name using the soft keyboard. ☛ "Soft keyboard operations" p.157 When you have finished, move the cursor over Finish , and then press the [Left Arrow] button.

Function	Explanation
Reset Memory	Resets the name and settings of a saved memory. To reset all memories saved in Memory , Lens Position , and Geometry Correction , use Reset All Memories . ☛ Reset - Reset All Memories p.167



If the mark on the left of the memory name is turned blue, it means the memory has already been registered. When you select a registered memory, a message is displayed asking you to confirm that you want to overwrite the memory. If you select **Yes**, the previous settings are deleted and the current settings are registered.

You can schedule turning the projector power on/off and switching the input source, as events in the schedule. Registered events are executed automatically at the specified time on the specified dates or weekly. You can register up to 30 events in **Schedule**, and one event in **Extended Schedule**.

Saving an Event

Setting an Event

- 1** Press the [Menu] button while projecting.
☛ "Using the Configuration Menu" [p.140](#)
- 2** Select **Schedule Settings** from **Extended**.
- 3** Select **Add New** from **Schedule** or **Extended Schedule**.



- 4** Set the schedule.

Submenu Name	Function
Event Settings	Select an operation of the projector when the event is executed. Select No Change for items that you do not want to change when the event occurs. You can set the following item operations. <p>Schedule</p> <ul style="list-style-type: none"> • Power • Source • Light Source Mode • A/V Mute • Volume • Light Source Calibration <p>Extended Schedule</p> <ul style="list-style-type: none"> • Color Calibration • Screen Matching
Date / Time Settings	Set the date, day of the week, and time to execute the event. You can set up to four weeks later. Use the soft keyboard to enter the date and time. <p>☛ "Soft keyboard operations" p.157</p>

- 5** Select **Save**, and then press the [**↵**] button.
To register additional events, repeat steps 3 to 5.
- 6** Select **Setup complete**, and then select **Yes** to finish saving.

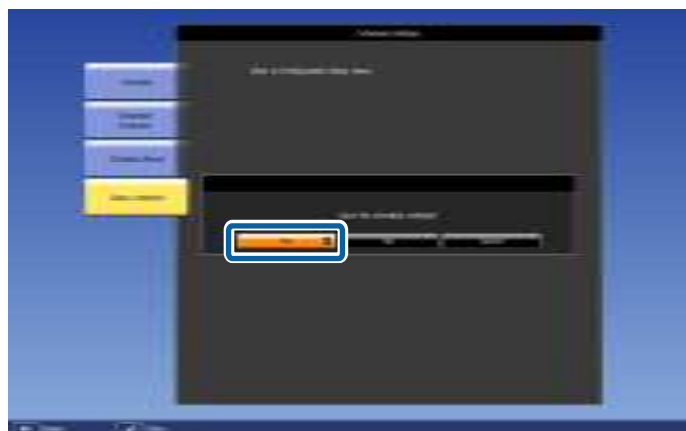





- Light source calibration does not start automatically when the projector is used continuously for more than 24 hours, or when direct shutdown is used regularly. Set **Light Source Calibration** to enable this function after every 100 hours of usage.
- You cannot register a schedule in which Schedule events conflict with an Extended Schedule event.
- You cannot set other events before the following times.
 - Five minutes before or after executing a Color Calibration event.
 - Five minutes before and 30 minutes after executing a Screen Matching event.
- When **Light Source Calibration** is enabled, turn on the projector at least 20 minutes before the event.

Checking an Event

This section explains how to check a Schedule event.



- 1** Press the [Menu] button while projecting.
- 2** Select **Schedule Settings** from **Extended**.
The indicator turns on when an event is saved.



-  (Aqua): Single event
-  (Orange): Regular event
-  (Green): Communication monitoring On/Off
-  (Gray): Disabled event

- Press the [◀][▶] buttons to highlight the date you want to check.
The details of the events registered on the selected date are displayed.



-  (Blue): Enabled event
-  (Gray): Disabled event
-  Regular event

Editing an Event

- Press the [Menu] button while projecting.
☛ "Using the Configuration Menu" p.140
- Select **Schedule Settings** from **Extended**.
- Use the [◀][▶] buttons to highlight the date containing the event you want to edit.



- Highlight the event you want to edit, and then press the [Esc] button.



- Edit the event.

Submenu Name	Function
On/Disabled	Enable or disable the selected event.

Submenu Name	Function
Edit	Edits the content of the selected event. Select Save , and then press the [↵] button to complete the editing.
Clear	Deletes the selected event.
Add New	Saves a new event. Select Save , and then press the [↵] button to complete registering.

6 Select **Setup complete**, and then select **Yes** to finish editing.



To delete all registered events, select **Schedule Reset**, and then select **Yes**. Select **Setup complete**, and then select **Yes** to delete the events.

The projector has the following enhanced security functions.

- **Password protect**
You can limit who can use the projector.
- **Control Panel Lock/Remote Control Button Lock**
You can prevent people changing the settings on the projector without permission.
☛ "Restricting Operation" [p.122](#)
- **Anti-Theft Lock**
The projector is equipped with the following anti-theft security device.
☛ "Anti-Theft Lock" [p.124](#)

Managing Users (Password Protection)

When Password Protection is activated, people who do not know the password cannot use the projector to project images even if the projector power is on. Furthermore, the user's logo that is displayed when you turn on the projector cannot be changed. This acts as an anti-theft function as the projector cannot be used even if it is stolen. At the time of purchase, Password Protection is not activated.

Kinds of Password Protection

The following four kinds of Password Protect settings can be made according to how the projector is being used.

- **Power On Protection**
When **Power On Protection** is **On**, you need to enter a preset password after the projector is plugged in and turned on (this also applies to Direct Power On). If the correct password is not entered, projection does not start.

- **User's Logo Protection**

Even if someone tries to change the User's Logo set by the owner of the projector, it cannot be changed. When **User's Logo Protection** is set to **On**, the following setting changes for the User's Logo are prohibited.

- Capturing a User's Logo
- Setting **Display Background** or **Startup Screen** from **Display**
☛ **Extended - Display** [p.150](#)

- **Network Protection**

When **Network Protection** is set to **On**, changing the settings for **Network** is prohibited.

- ☛ "Network Menu" [p.155](#)

- **Schedule Protection**

When **Schedule Protection** is set to **On**, changing settings for the projector's system time or schedules is prohibited.

- **Remote Camera Access**

When **Remote Camera Access** is set to **On**, changing the settings for **Remote Camera Access** from the **Network** menu is prohibited. The default is **On**.

Setting Password Protection

Use the following procedure to set Password Protect.

- 1 During projection, hold down the [Freeze] button for about five seconds.

The Password Protection setting menu is displayed.

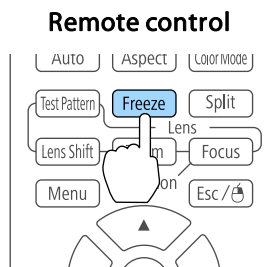

If Password Protection is already activated, you must enter the password.

If the password is entered correctly, the Password Protection setting menu is displayed.

☞ "Entering the password" p.121

- 2 Select the type of Password Protect you want to set, and then press the [↵] button.

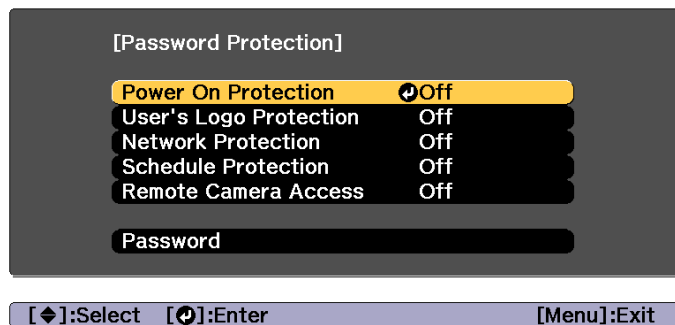

- 3 Select **On**, and then press the [↵] button.
Press the [Esc] button to return to the screen in step 2.

- 4 Set the password.

- (1) Select **Password**, and then press the [↵] button.
- (2) When the message "Change the password?" is displayed, select **Yes** and then press the [↵] button. The default password is set to "0000". Change this to your own desired password. If you select **No**, the screen displayed in step 2 is displayed again.
- (3) While holding down the [Num] button, enter a four digit number using the numeric buttons. The number entered is displayed as "****". When you enter the fourth digit, the confirmation screen is displayed.

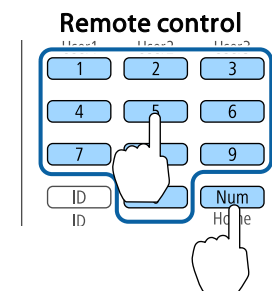

- (4) Re-enter the password.
"Password accepted." is displayed.
If you enter the password incorrectly, a message is displayed prompting you to re-enter the password.

Entering the password

When the password entry screen is displayed, enter the password using the remote control.

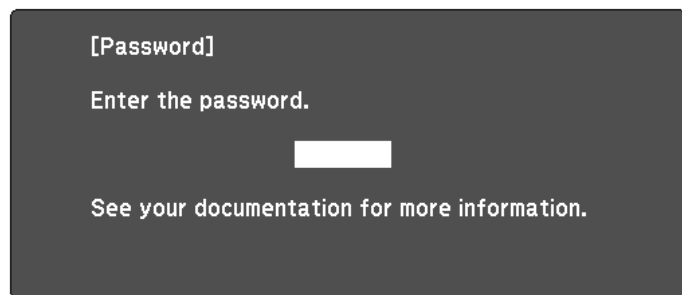

While holding down the [Num] button, enter the password by pressing the numeric buttons.



[0-9] :Enter

When you enter the correct password, Password Protect is temporarily released.

Attention

- If an incorrect password is entered three times in succession, the message "The projector's operation will be locked." is displayed for approximately five minutes, and then the projector switches to standby mode. If this happens, disconnect the power plug from the electrical outlet and then reinsert it and turn the projector's power back on. The projector displays the password entry screen again so that you can enter the correct password.
- If you have forgotten the password, make a note of the "Request Code: xxxxx" number that appears on the screen and contact the nearest address provided in the Epson Projector Contact List.
 [Epson Projector Contact List](#)
- If you continue to repeat the above operation and input the wrong password thirty times in succession, the following message is displayed and the projector does not accept any more password entries. "The projector's operation will be locked. Contact Epson as described in your documentation."
 [Epson Projector Contact List](#)

Restricting Operation

The following three kinds of operation restriction functions are available with the projector.

- **Control Panel Lock**
This is useful at events or shows when you want to deactivate all buttons during projection or at schools when you want to limit button operation.
- **Lens Lock**
This function deactivates all buttons on the remote control related to the lens operation to prevent improper lens adjustment after it is properly adjusted.
- **Remote control button lock**
This function deactivates buttons except for main buttons needed for basic remote control operation, to prevent mistakes in operations.

Control Panel Lock

Perform one of the following to lock the operation buttons on the control panel. Even if the control panel is locked, you can still use the remote control as usual.

- **Full Lock**
All of the buttons on the control panel are locked. You cannot perform any operations from the control panel, including turning the power on or off.
- **Partial Lock**
All of the buttons on the control panel, except for the [⏻] button, are locked.

- 1 Press the [🔒] button on the control panel during projection to display the Control Panel Lock screen.



You can also make settings in **Control Panel Lock** from the configuration menu.

☛ **Settings - Lock Setting - Control Panel Lock** p.148

2 Select either **Full Lock** or **Partial Lock** according to your purpose.

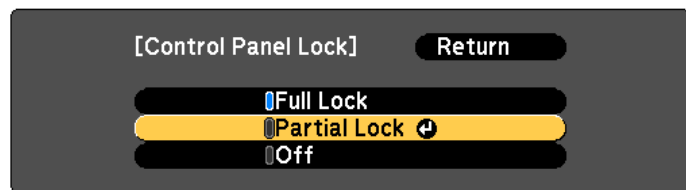

[Esc]:Return [◀]:Select [▶]:Set [Menu]:Exit

3 Select **Yes** when the confirmation message is displayed.

The control panel buttons are locked according to the setting you chose.



You can release the control panel lock by one of the following two methods.

- Use the remote control to set **Control Panel Lock** to **Off** from the configuration menu.
 - ☛ **Settings - Lock Setting - Control Panel Lock** p.148
- Press and hold down the [↵] button on the control panel for about seven seconds, a message is displayed and the lock is released.

Lens Lock

This function locks the following buttons on the remote control related to the lens operation.

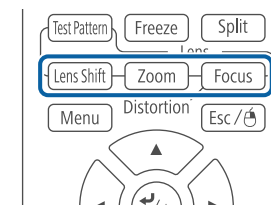

Set the **Lens Lock** to **On** in the Configuration menu.

☛ **Settings - Lock Setting - Lens Lock** p.148

Remote control button lock

This function locks the following buttons on the remote control.

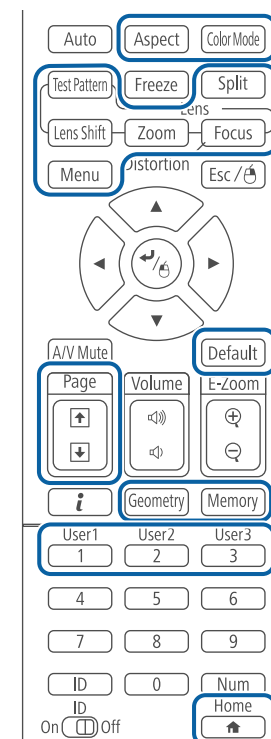

Each time the [Home] button is pressed for approximately 5 seconds, the remote control button lock turns on or off.

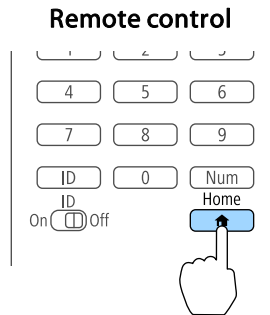

Even if the remote control button lock is on, the following operations are possible.

- Resetting default for the Remote Receiver setting
- Releasing the remote control button lock

Anti-Theft Lock

The projector is equipped with the following types of anti-theft security devices.

- Security slot
The security slot is compatible with the Microsaver Security System manufactured by Kensington.
See the following for more details on the Microsaver Security System.
<http://www.kensington.com/>
- Security cable installation point
A commercially available theft-prevention wire lock can be passed through the installation point to secure the projector to a desk or pillar.

Installing the wire lock

Pass an anti-theft wire lock through the installation point.

See the documentation supplied with the wire lock for locking instructions.

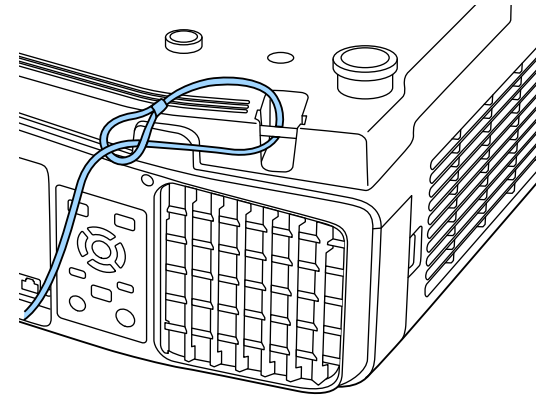

Attention

Do not pass drop-prevention wires through the security cable installation point.



Using the Projector on a Network

Follow the instructions in these sections to set up your projector for use on a network.

You can send images to your projector through a wired network. To do this, connect the projector to your network, and then set up your projector and computer for network projection.

After connecting and setting up the projector, install Epson iProjection from the Epson Projector Software CD-ROM (if available) or Web site.

Epson iProjection software sets up your computer for network projection. It also allows you to hold interactive meetings by projecting user's computer screens over a network. See the Epson iProjection Operation Guide (Windows/Mac) for instructions.

Selecting Wired Network Settings

Before you can project from computers on your network, you need to select network settings on the projector.



Make sure you already connected the projector to your wired network using the LAN port.

☛ "Connecting a LAN Cable" p.53

- 1 Press the [Menu] button on the control panel or remote control.

- 2 Select the **Network** menu and press [Enter].

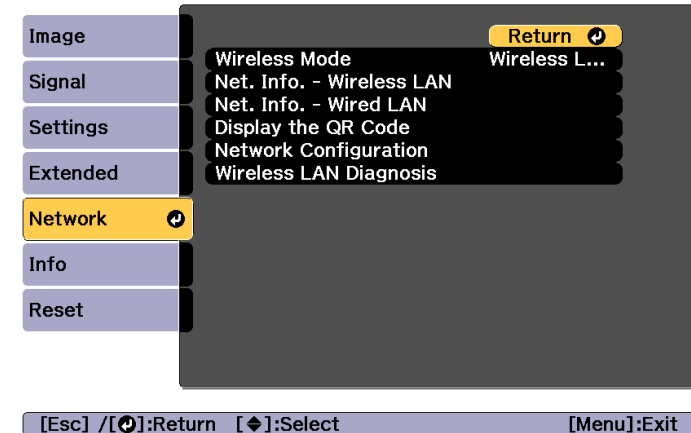

- 3 Select **Network Configuration** and press [Enter].

- 4 Select the **Basic** menu and press [Enter].

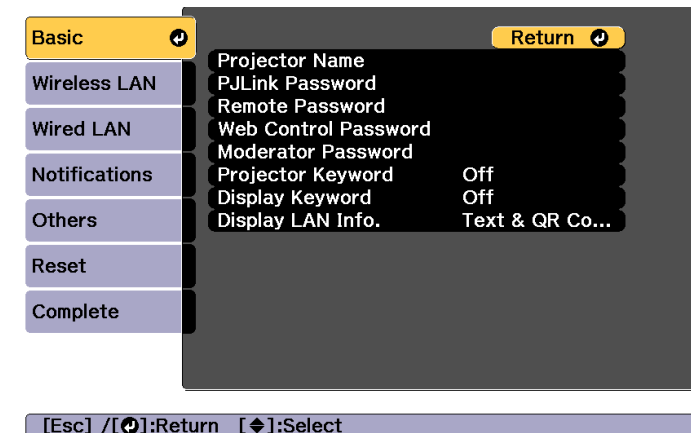

- 5 Select the basic options as necessary.

- **Projector Name:** Enter the projector name used to identify the projector over a network. You can enter up to 16 single-byte alphanumeric characters.
- **PJLink Password:** Lets you set a password for using the PJLink protocol for projector control. You can enter up to 32 single-byte alphanumeric characters.
- **Remote Password:** Lets you set an authentication password for using the Remote function in Epson Web Control when setting or controlling the projector. You can enter up to 8 single-byte alphanumeric characters. (The user name is **EPSONREMOTE**; the default password is **guest**.)
- **Web Control Password:** Lets you set an authentication password for using Web Control in Epson Web Control when setting or controlling the projector. You can enter up to 8 single-byte alphanumeric characters. (The user name is **EPSONWEB**; the default password is **admin**.)
- **Moderator Password:** Lets you set an authentication password for using Epson iProjection when connecting to the projector as a moderator. Enter four digits for the password. (There is no default password.)
- **Projector Keyword:** Lets you turn on a security password to prevent access to the projector by anyone not in the room with it. You must enter a displayed keyword using Epson iProjection to project images and send or receive data.
- **Display Keyword:** Lets you display a projector keyword on the projection screen when connecting to the projector using Epson iProjection.
- **Display LAN Info.** lets you set the display format for the projector's network information.



Use the displayed keyboard to enter the name, passwords and keyword. Press [▲][▼][◀][▶] buttons on the remote control to highlight characters and press [Enter] to select them.

- 6 Select the **Wired LAN** menu and press [Enter].

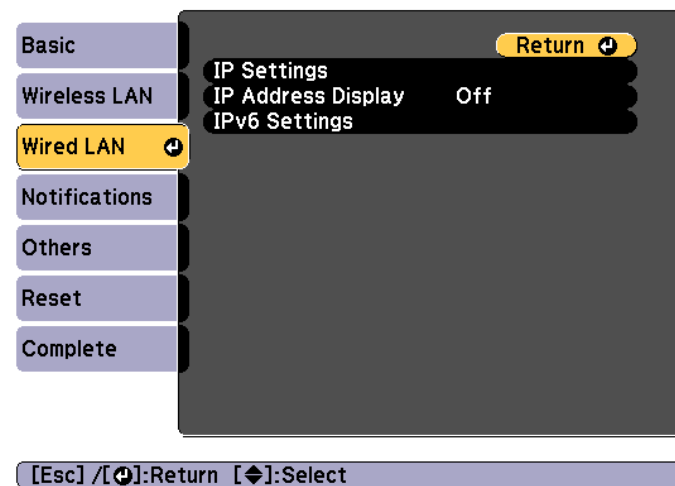

- 7 Assign the IP settings for your network as necessary.

- If your network assigns addresses automatically, select **IP Settings** to set the **DHCP** setting to **On**.
- If you must set addresses manually, select **IP Settings** to set the **DHCP** setting to **Off**, and then enter the projector's **IP Address**, **Subnet Mask**, and **Gateway Address** as necessary.
- If you want to connect the projector to the network using IPv6, select **IPv6 Settings**.
 "Wired LAN menu" [p.162](#)



Press the [▲][▼][◀][▶] buttons on the remote control, and then select the number you want to enter on the soft keyboard displayed. Press the [Enter] button to confirm.

- 8 To prevent the IP address from being displayed on the LAN standby screen and Home screen, set the **IP Address Display** setting to **Off**.

9 If you have finished making settings, select **Setup complete**. Follow the on-screen instructions to save the settings and close the menu.

10 Press the [LAN] button on the remote control.
The wired network settings complete when you see the correct IP address on the LAN standby screen.

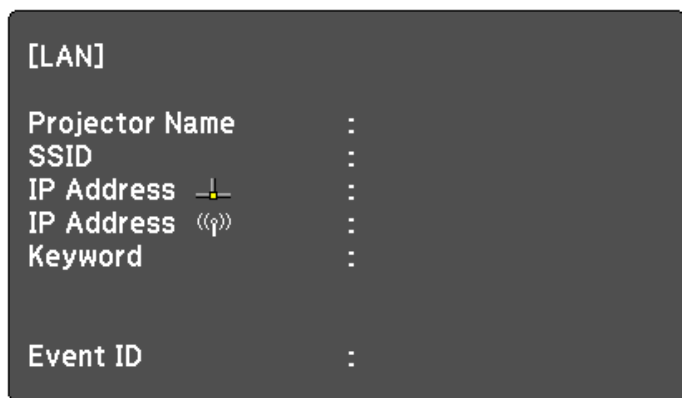

You can send images to your projector through a wireless network.

To do this, you must install the Epson 802.11b/g/n wireless LAN module, and then set up your projector and computer for wireless projection.

☛ "Installing the Wireless LAN Unit" p.55

You can connect the projector to your wireless network by configuring the connection manually using the projector's **Network** menus.

Set the projector's time before configuring the Network menu. If the time is not set, the wireless LAN may not be configured correctly.

☛ "Setting the Time" p.45

After installing the wireless LAN module and setting up the projector, install the network software from the Epson Projector Software CD-ROM (if available) or download the software, as necessary. Use the following software and documentation to set up and control wireless projection:

- Epson iProjection (Windows/Mac) software allows you to hold interactive meetings by projecting the computer screens of users over a network. See the Epson iProjection Operation Guide (Windows/Mac) for instructions.
- Epson iProjection (iOS/Android) app allows you to project from iOS or Android mobile devices.
You can download Epson iProjection (iOS/Android) for free from the App Store or Google Play. Any fees incurred when communicating with the App Store or Google Play are the responsibility of the customer.
- Epson iProjection (Chromebook) allows you to project images from a Chromebook.
You can download Epson iProjection (Chromebook) for free from the Chrome Web Store. Any fees incurred when communicating with the Chrome Web Store are the responsibility of the customer.

Selecting Wireless Network Settings Manually

Before you can project from your wireless network, you need to select network settings for the projector.

- 1 Press the [Menu] button on the control panel or remote control.
- 2 Select the **Network** menu and press [Enter].

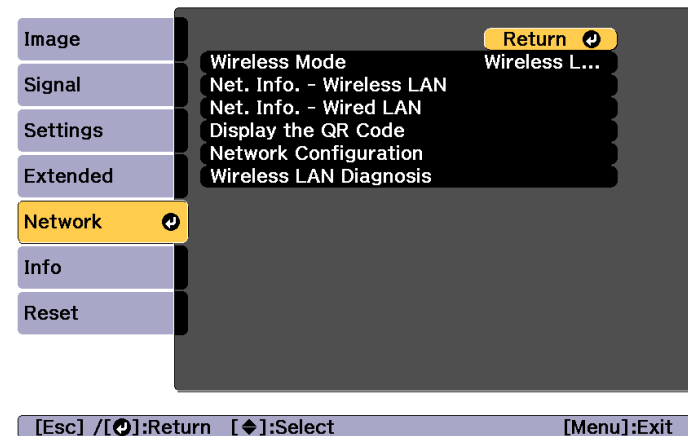

- 3 Set **Wireless Mode** to **Wireless LAN On**.

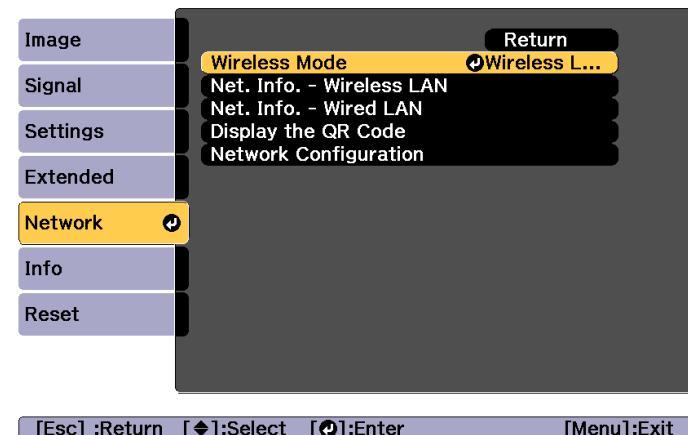

4 Select **Network Configuration** and press [Enter].

5 Select the **Basic** menu and press [Enter].

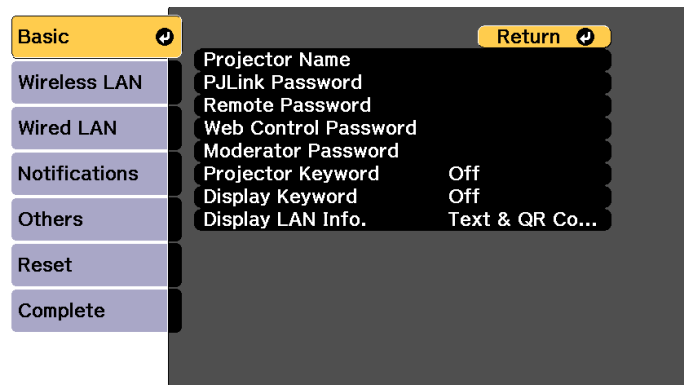

[Esc] / [Home]:Return [Left/Right]:Select

6 Select the basic options as necessary.

- **Projector Name:** Enter the projector name used to identify the projector over a network. You can enter up to 16 single-byte alphanumeric characters.
- **PJLink Password:** Lets you set a password for using the PJLink protocol for projector control. You can enter up to 32 single-byte alphanumeric characters.
- **Remote Password:** Lets you set a password for accessing the projector using Remote in Epson Web Control. You can enter up to 8 single-byte alphanumeric characters. (The user name is **EPSONREMOTE**; the default password is **guest**.)
- **Web Control Password:** Lets you set a password for accessing the projector using Web Control in Epson Web Control. You can enter up to 8 single-byte alphanumeric characters. (User name is **EPSONWEB**; default password is **admin**.)

- **Moderator Password:** Lets you set an authentication password when connecting to the projector as a moderator using Epson iProjection. Enter four digits for the password. (There is no default password.)
- **Projector Keyword:** Lets you turn on a security password to prevent access to the projector by anyone not in the room with it. Turn on "Projector Keyword" when using thumbnail display or the send function between the projector and connected devices.
- **Display Keyword:** Lets you display a projector keyword on the projection screen when connecting to the projector using Epson iProjection.
- **Display LAN Info.** lets you set the display format for the projector's network information.



Use the displayed keyboard to enter the name and password. Press [Up] [Down] [Left] [Right] buttons on the remote control to highlight characters and press [Enter] to select them.

7 Select the **Wireless LAN** menu and press [Enter].

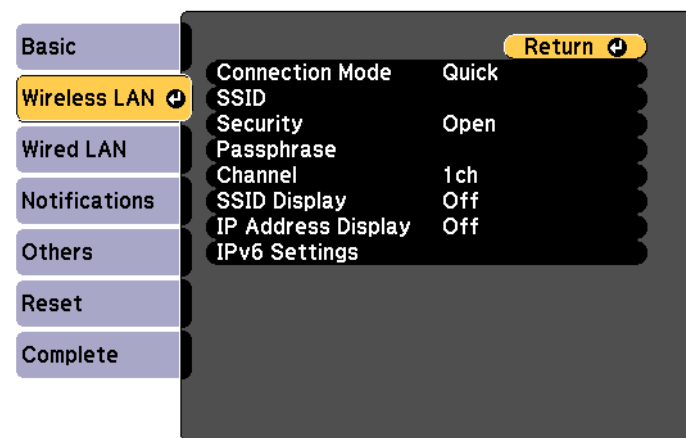

[Esc] / [Home]:Return [Left/Right]:Select

- 8** Select the **Connection Mode** setting.
- **Quick** lets you connect to multiple smartphones, tablets, or computers directly using wireless communication.
 - **Advanced**: Lets you connect to a smartphone, tablet, or computer over a wireless LAN access point.

- 9** If you selected the **Advanced** connection mode, select **Search Access Point** to select the access point you want to connect to.



If you need to assign the SSID manually, select **SSID** to enter the SSID.

- 10** For the **Advanced** connection mode, assign the IP settings for your network as necessary.
- If your network assigns addresses automatically, select **IP Settings** to set the **DHCP** setting to **On**.
 - If you must set addresses manually, select **IP Settings** to set the **DHCP** setting to **Off**, and then enter the projector's **IP Address**, **Subnet Mask**, and **Gateway Address** as necessary.
 - If you want to connect the projector to the network using IPv6, select **IPv6 Settings**.
 ☛ "Wireless LAN menu" [p.158](#)

- 11** To prevent the SSID or IP address from being displayed on the LAN standby screen and Home screen, set the **SSID Display** setting or the **IP Address Display** setting to **Off**.

- 12** If you have finished making settings, select **Setup complete**. Follow the on-screen instructions to save the settings and close the menu.

- 13** Press the [LAN] button on the remote control.
 The wired network settings complete when you see the correct IP address on the LAN standby screen.

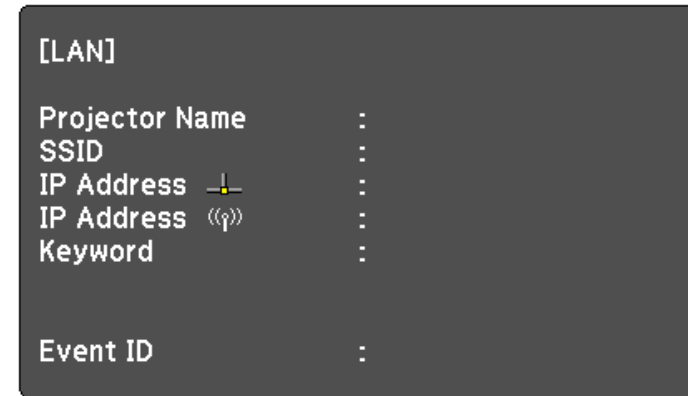

When you have finished making wireless settings for your projector, you need to select the wireless network on your computer. Then start the network software to send images to your projector through a wireless network.

Selecting Wireless Network Settings in Windows

Before connecting to the projector, select the correct wireless network on your computer.

- 1** To access your wireless utility software, double-click the network icon on the Windows taskbar.
- 2** When connecting in Advanced connection mode, select the network name (SSID) of the network the projector is connecting to.
- 3** Click **Connect**.

Selecting Wireless Network Settings in OS X

Before connecting to the projector, select the correct wireless network on your computer.

- 1** Click the AirPort icon on the menu bar at the top of the screen.
- 2** When connecting in Advanced connection mode, make sure AirPort is turned on and select the network name (SSID) of the network the projector is connecting to.

Setting Up Wireless Network Security

You can set up security for your projector to use on a wireless network. Set up one of the following security options to match the settings used on your network:

- WPA2-PSK security
- WPA2-EAP security *
- WPA/WPA2-PSK security *
- WPA/WPA2-EAP security *

* Only available for the Advanced connection mode.



Contact your network administrator for guidance on entering the correct information.

- 1** If you want to set up the WPA2-EAP or WPA/WPA2-EAP security, make sure your digital certificate file is compatible with projector registration and placed directly on the USB storage device.
☛ "Supported Client and CA Certificates" [p.134](#)
- 2** Press the [Menu] button on the control panel or remote control.
- 3** Select the **Network** menu and press [Enter].
- 4** Select **Network Configuration** and press [Enter].

- 5** Select the **Wireless LAN** menu and press [Enter].

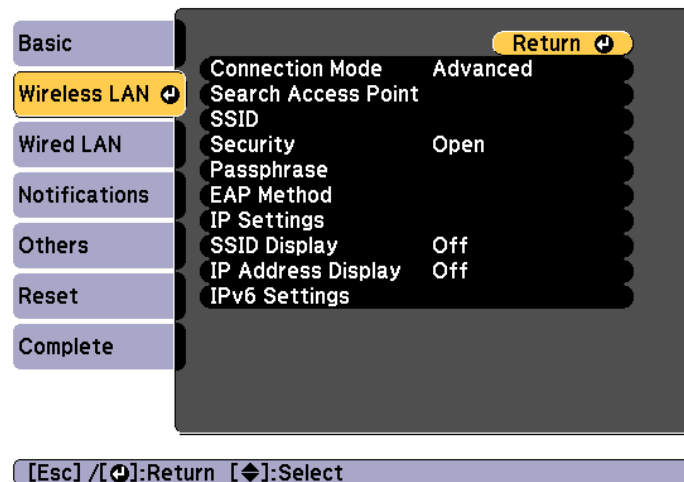

- 6** Select the **Security** setting and press [Enter].

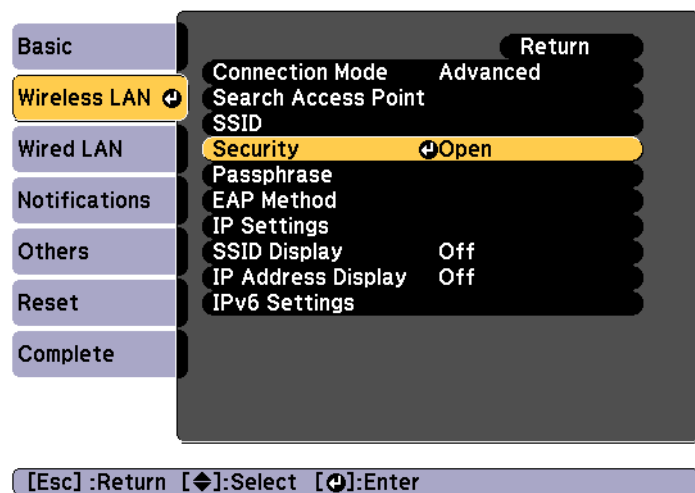

- 7** Select the security settings to match your network settings.

- WPA2-PSK, WPA/WPA2-PSK:

Select **Setup complete**. Follow the on-screen instructions to save the settings and close the menu.

- WPA2-EAP, WPA/WPA2-EAP:

Select **EAP Method** and press [Enter].

- 8** Select the protocol for authentication as the **EAP Type** setting.

- 9** To import your certificate, select the certificate type and press [Enter].

- **Client Certificate** for the **PEAP-TLS** or **EAP-TLS** type
- **CA certificate** for the **PEAP**, **PEAP-TLS**, **EAP-TLS**, or **EAP-FAST** type



You can also register the digital certificates from your Web browser. However, be sure to register just once or the certificate may not install correctly.

☛ "Setting a certificate using a Web browser" [p.226](#)

- 10** Select **Register** and press [Enter].

- 11** Follow the on-screen instructions to connect a USB storage device to the projector's wireless LAN unit port.

If the wireless LAN module is already installed in the projector, remove it.

☛ "Installing the Wireless LAN Unit" [p.55](#)

- 12** Press [Enter] to display the certificate list.

- 13** Select the certificate to import using the displayed list.

A message is displayed prompting you to enter the password for the certificate.

- 14** Enter a password and press [Enter].
The certificate is imported and a completion message appears.

- 15** Select your EAP settings as necessary.

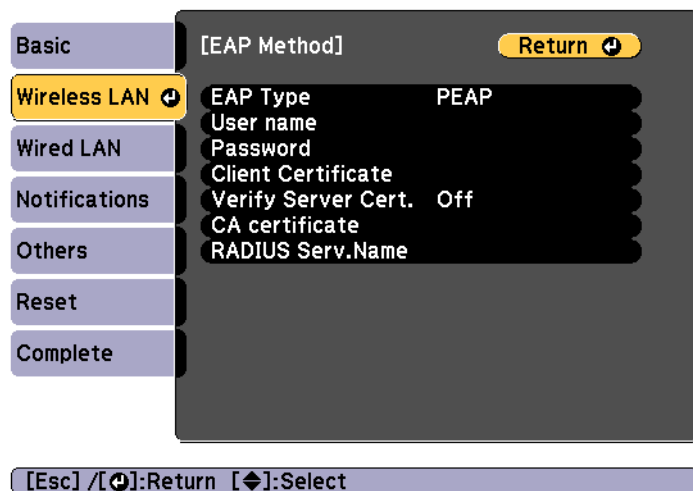

- **User Name:** Enter the user name. You can enter up to 64 single-byte alphanumeric characters. When entering more than 32 characters, use your Web browser to enter the text. When importing a client certificate, the name the certificate was issued to is automatically set.
- **Password:** Enter the password used for authentication in **PEAP**, **EAP-FAST**, and **LEAP**. You can enter up to 64 single-byte alphanumeric characters. When entering more than 32 characters, use your Web browser to enter the text.
- **Verify Server Cert.** lets you select whether or not to verify the server certificate when a CA certificate has been set.
- **RADIUS Serv.Name** lets you enter the server name to be verified.

- 16** If you have finished making settings, select **Setup complete**. Follow the on-screen instructions to save the settings and close the menu.

Supported Client and CA Certificates

You can register these types of digital certificates.

Client Certificate (PEAP-TLS/EAP-TLS)

Item	Explanation
Format	PKCS#12
Extension	PFX, P12
Encryption	RSA
Hashes	MD5/SHA-1/SHA-256/SHA-384/SHA-512
Key length	512/1024/2048/4096 bit
Password *	You need to setup a password. Up to 32 single-byte alphanumeric characters

CA Certificate (PEAP/PEAP-TLS/EAP-TLS/EAP-FAST)

Item	Explanation
Format	X509v3
Extension	DER/CER/PEM
Encryption	RSA
Hashes	MD5/SHA-1/SHA-256/SHA-384/SHA-512
Key length	512/1024/2048/4096 bit
Encoding	BASE64/Binary

* You can set a password using up to 64 alphanumeric characters. When entering more than 32 characters, use your Web browser to enter the text.

☛ "Changing Settings Using a Web Browser (Epson Web Control)"
p.218

Using a QR Code to Connect a Mobile Device

After making the wireless network settings for your projector, you can display a QR code on the screen and use it to connect a mobile device using the Epson iProjection (iOS/Android) app.



- Make sure you have installed the latest version of Epson iProjection on your device (Epson iProjection V1.3.0 or later supports this feature).
- You can download Epson iProjection for free from the App Store or Google Play. Any fees incurred when communicating with the App Store or Google Play are the responsibility of the customer.
- When using Epson iProjection in Quick connection mode, we recommend making security settings.

1 Press the [LAN] button on the remote control.

The QR code is displayed on the projected surface.



- If you do not see the QR code, set the **Display LAN Info.** setting to **Text & QR Code** in the projector's Network menu.
☛ **Network - Network Configuration - Display LAN Info.**
[p.157](#)
- To hide the QR code, press the [Esc] button.
- When the QR code is hidden, press the [Enter] button to display the code.
- You can also display the QR code by selecting the icon on the Home screen.

2 Start Epson iProjection on your mobile device.

3 Read the projected QR code using Epson iProjection to connect it to the projector.



To correctly read the QR code, make sure you face the screen squarely and closely enough so that the projected code fits into the guide of the mobile device's QR code reader. If you are too far from the screen, the code may not be read.

When a connection is established, select **Contents** menu from , and then select the file you want to project.

Using a USB Key to Connect a Windows Computer

You can set up your USB flash drive as a USB key to quickly connect the projector to a wireless LAN supported Windows computer. The USB key allows you to automatically select a computer's wireless network settings and project your presentation wirelessly.

- 1** Set up the USB key using Epson iProjection (Windows/Mac). See the Epson iProjection Operation Guide (Windows/Mac) for instructions.
- 2** Make sure the wireless LAN module is installed.
- 3** Turn on the projector.
- 4** Press the [LAN] button on the remote control. The LAN standby screen is displayed. Verify that an SSID and IP address are displayed.
- 5** Remove the wireless LAN module from the projector and insert the USB key into the same port used for the wireless LAN module.
 "Installing the Wireless LAN Unit" [p.55](#)
You see a projected message that the network information update is complete.
- 6** Remove the USB key.
Reinsert the wireless LAN module into the projector.
- 7** Connect the USB key to a USB port on your computer.



In Windows Vista, if the AutoPlay window is displayed, select **MPPLaunch.exe**, then select **Allow**.

- 8** Follow the on-screen instructions to install the necessary application.



- If the Windows Firewall message is displayed, click **Yes** to disable the firewall.
- You need administrator authority to install the software.
- If it is not installed automatically, double-click **MPPLaunch.exe** in the USB key.

After a few minutes, your computer image is displayed by the projector. If it does not appear, press the [LAN] button on your projector's remote control or restart your computer.

- 9** Run your presentation.
- 10** When you have finished projecting wirelessly, select the **Safely Remove Hardware** option in the Windows taskbar, and then remove the USB key from your computer.



You may need to restart your computer to reactivate your wireless LAN connection.

You can use the HTTPS protocol to increase security between the projector and a Web browser communicating with it. To do this, you create a server certificate, install it on the projector, and turn on the **Secure HTTP** setting in the projector menus to verify the reliability of the Web browser.

☛ **Network - Network Configuration - Others - Secure HTTP** [p.164](#)

Even if you do not install a server certificate, the projector automatically creates a self-signed certificate and allows communication. However, because the self-signed certificate cannot verify reliability from a Web browser, you see a warning about the server's reliability when you access the projector from a Web browser. This warning does not prevent communication.

Importing a Web Server Certificate Using the Menus

You can create your Web server certificate, and import it using the projector menus and a USB flash drive.



You can also register the digital certificates from your Web browser. However, be sure to register just once or the certificate may not install correctly.

☛ "Setting a certificate using a Web browser" [p.226](#)

- 1** If you want to set up the WPA2-EAP or WPA/WPA2-EAP security, make sure your digital certificate file is compatible with projector registration and placed directly on the USB storage device.
☛ "Supported Web Server Certificates" [p.138](#)
- 2** Press the [Menu] button on the control panel or remote control.
- 3** Select the **Network** menu and press [Enter].
- 4** Select **Network Configuration** and press [Enter].

- 5** Select the **Others** menu and press [Enter].

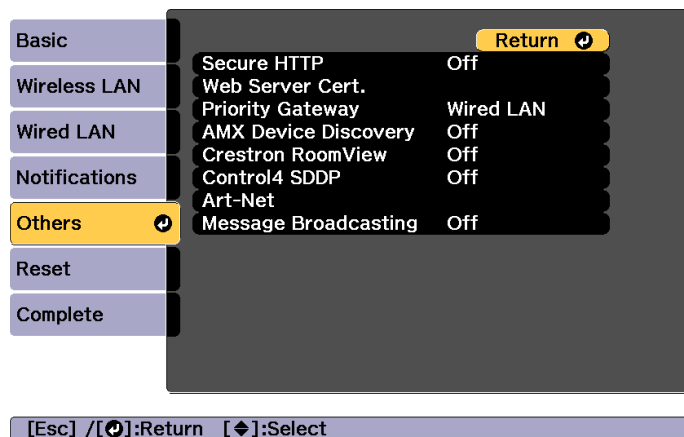

- 6** Select **On** as the **Secure HTTP** setting.
- 7** Select **Web Server Cert.** and press [Enter].
- 8** Select **Register** and press [Enter].
- 9** Follow the on-screen instructions to connect a USB storage device to the projector's wireless LAN unit port.
If the wireless LAN module is already installed in the projector, remove it.
☛ "Installing the Wireless LAN Unit" [p.55](#)
- 10** Press [Enter] to display the certificate list.
- 11** Select the certificate to import using the displayed list.
A message is displayed prompting you to enter the password for the certificate.

- 12** Enter a password and press [Enter].
The certificate is imported and a completion message appears.

Supported Web Server Certificates

You can register these types of digital certificates.

Web Server Certificate (Secure HTTP)

Item	Explanation
Format	PKCS#12
Extension	PFX, P12
Encryption	RSA
Hashes	MD5/SHA-1/SHA-256/SHA-384/SHA-512
Key length	512/1024/2048/4096 bit
Common Name	Network Host Name
Organization	Optional
Password *	You need to setup a password. Up to 32 single-byte alphanumeric characters

* You can set a password using up to 64 alphanumeric characters. When entering more than 32 characters, use your Web browser to enter the text.

☛ "Setting a certificate using a Web browser" [p.226](#)



Configuration Menu

This chapter explains how to use the Configuration menu and its functions.

This section explains how to use the Configuration menu.

Although steps are explained using the remote control as an example, you can perform the same operations from the control panel. Check the guide under the menu for the available buttons and their operations.

1 Display the Configuration menu screen.

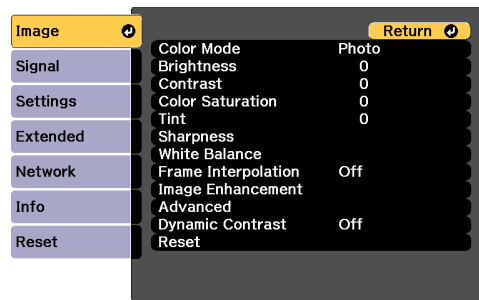
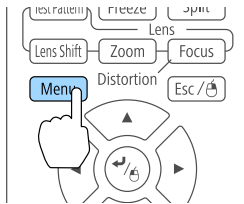

[Esc] / [Enter]:Return [Left]:Select [Right]:Exit

2 Select a top menu item.

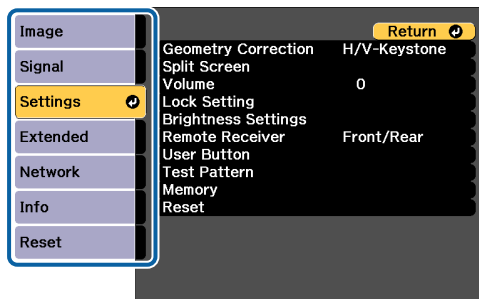
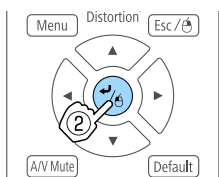
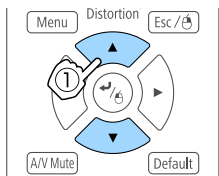

[Esc] / [Enter]:Return [Left]:Select [Right]:Exit

3 Select a submenu item.

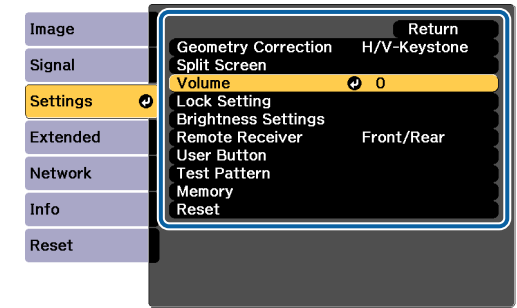
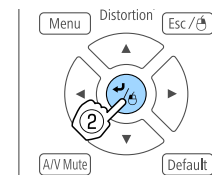
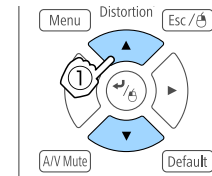

[Esc] :Return [Left]:Select [Right]:Enter [Menu]:Exit

4 Change settings.

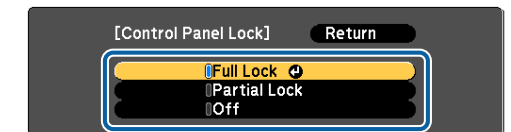
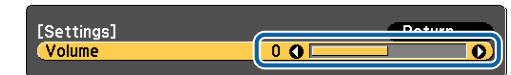
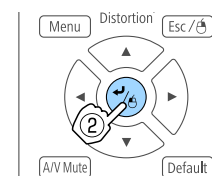
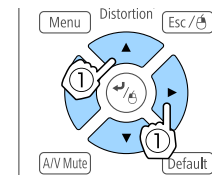

[Esc] :Return [Left]:Select [Right]:Set [Menu]:Exit



When "[Default]: Reset" is displayed on the guide under the menu, pressing the [Default] button on the remote control returns the settings being adjusted to their default values.

5 Press the [Menu] button to finish making settings.

Configuration Menu Table

Settable items vary depending on the model being used and the image signal and source being projected.

Top Menu Name	Submenu Name	Items or Setting Values
Image menu ☛ p.143	Color Mode	Dynamic, Presentation, Natural, Cinema, BT.709, DICOM SIM, Multi-Projection
	Brightness	0 to 100
	Contrast	0 to 100
	Color Saturation	0 to 100
	Tint	0 to 100
	Sharpness	Standard, Thin Line Enhancement, Thick Line Enhancement
	White Balance	Color Temp., G-M Correction, Offset R, Offset G, Offset B, Gain R, Gain G, Gain B
	Frame Interpolation	Off, Low, Normal, and High
	Image Enhancement	4K Enhancement, Image Preset Mode, Noise Reduction, MPEG Noise Reduction, Super-resolution, Detail Enhancement
	Advanced	Gamma, RGBCMY, Deinterlacing
Dynamic Contrast	Off, Normal, and High Speed	
Signal menu ☛ p.146	Resolution	Auto, Wide, Normal, and Manual
	Aspect	Auto, Normal, 4:3, 16:9, Full, H-Zoom, V-Zoom, Native
	Tracking	-
	Sync.	0 to 31
	Position	-128 to 127



Top Menu Name	Submenu Name	Items or Setting Values
	Auto Setup	On, Off
	Overscan	Auto, Off, 4%, and 8%
	Blanking	Top, Bottom, Left, and Right
	Advanced	Video Range, Input Signal, Image Processing, EDID, DDC Buffer
	Scale	Scale, Scale Mode, Scale Vertically, Scale Horizontally, Clip Adjustment, Clip Range
Settings menu ☛ p.148	Geometry Correction	Off, H/V-Keystone, Quick Corner, Curved Surface, Corner Wall, Point Correction, Memory
	Split Screen	-
	Volume	0 to 20
	Lock Setting	Control Panel Lock, Lens Lock
	Brightness Settings	Light Source Mode, Brightness Level, Constant Brightness, Estimated Remains
	Remote Receiver	Front/Rear, Front, Rear, and Off
	User Button	User Button 1, User Button 2, and User Button 3
	Test Pattern	Standard, Cross-hatching, Cross-hatching R, Cross-hatching G, Cross-hatching B, Color Bars V, Color Bars H, Grayscale, Gray Bars V, Gray Bars H, Checkerboard 1, Checkerboard 2, White, Black, Aspect Frame
	Memory	Memory, Lens Position, Geometry Correction
	Extended menu ☛ p.150	Home Screen

Top Menu Name	Submenu Name	Items or Setting Values
	Display	Menu Position, Message Position, Messages, Display Background, Startup Screen, Standby Confirmation, Air Filter Notice, Screen, Panel Alignment, Color Uniformity, OSD Rotation
	User's Logo	-
	Projection	Front, Front/Ceiling, Rear, and Rear/Ceiling
	Operation	Direct Power On, Sleep Mode, Sleep Mode Timer, High Altitude Mode, Auto Source Search, Auto Power On, A/V Mute Settings, Advanced, Date & Time, Lens Calibration
	A/V Settings	A/V Output, Monitor Out, and Audio Settings
	Standby Mode	Communication On and Communication Off
	HDBaseT	Control Communications, Extron XTP
	Color Calibration	Start Auto Adjustment, Undo, Redo, Color Uniformity
	Multi-Projection	Projector ID, Projector Grouping, Tiling, Geometry Correction, Edge Blending, Black Level, Scale, Screen Matching
	Schedule Settings	-
	Language	27 languages

Top Menu Name	Submenu Name	Items or Setting Values
Info menu ☛ p.165	Projector Info	Total Op. Time, Operation Hours, Sources, Input Signal, Resolution, Refresh Rate, Sync Info, Status, Serial Number, Lens Type, Event ID, HDBaseT Signal Level
	Light Source Info	Light Source Hours, Estimated Remains
	Version	Main, Video2
	Status Information	Status Information, Source, Signal Information, Network Wired, Network Wireless, Maintenance, Version
	Voltage Warning Info	-
	Temp Warning Info	-
Reset Menu ☛ p.167	Reset All Memories	-
	Reset All Config	-

Network menu

Top Menu Name	Submenu Name	Items or Setting Values
Basic menu ☛ p.157	Projector Name	-
	PJLink Password	-
	Remote Password	-
	Web Control Password	-
	Moderator Password	-
	Projector Keyword	On, Off
	Display Keyword	On, Off
	Display LAN Info.	Text & QR Code, Text
Wireless LAN menu ☛ p.158	Connection Mode	Quick, Advanced

Top Menu Name	Submenu Name	Items or Setting Values
	Search Access Point	-
	SSID	-
	Security	Open, WPA2-PSK, WPA/WPA2-PSK, WPA2-EAP, WPA/WPA2-EAP
	Passphrase	-
	EAP Method	EAP Type, User name, Password, Client Certificate, Verify Server Cert., CA certificate, RADIUS Serv.Name
	Channel	1ch, 6ch, and 11ch
	IP Settings	DHCP, IP Address, Subnet Mask, Gateway Address
	SSID Display	On, Off
	IP Address Display	On, Off
	IPv6 Settings	IPv6, Auto Configuration, Use Temporary Address
Wired LAN menu  p.162	IP Settings	DHCP, IP Address, Subnet Mask, Gateway Address
	IP Address Display	On, Off
	IPv6 Settings	IPv6, Auto Configuration, Use Temporary Address
Notifications menu  p.164	Mail Notification	On, Off
	SMTP Server	-
	Port Number	-
	From	-

Top Menu Name	Submenu Name	Items or Setting Values
	Address 1 Setting, Address 2 Setting, Address 3 Setting	Email Address, No Signal, System Error, Laser Error, High Temp Error, Air Filter Error, Laser Warning, High Temp Warning, Air Filter Warning, Air Filter Notice, Constant Bright. End
	SNMP	On, Off
	Trap IP Address 1, Trap IP Address 2	-
	Community Name	-
	PJLink Notification	On, Off
	Notified IP Address	-
	Others menu  p.164	Secure HTTP
Web Server Cert.		-
Priority Gateway		Wired LAN, Wireless LAN
AMX Device Discovery		On, Off
Crestron RoomView		On, Off
Control4 SDDP		On, Off
Art-Net		Art-Net, Net, Sub-Net, Universe, Start Channel
Message Broadcasting		On, Off

Image Menu

Settable items vary depending on the image signal and source currently being projected. Setting details are saved for each color mode.

☛ "Automatically Detecting Input Signals and Changing the Projected Image (Source Search)" [p.62](#)

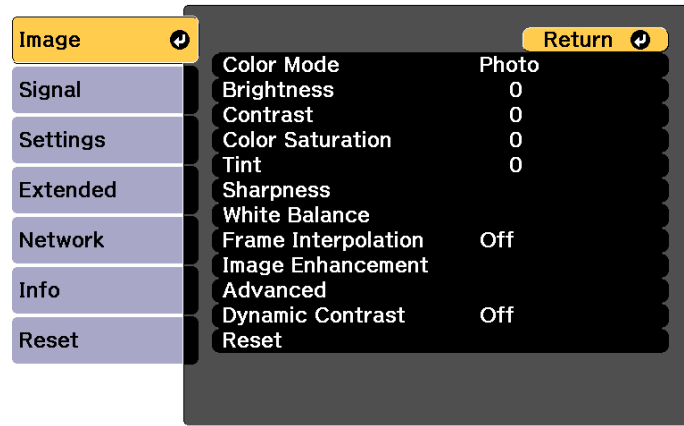

[Esc] / [⏪]:Return [⏩]:Select [Menu]:Exit

Submenu	Function
Color Mode	You can select the quality of the image to suit your surroundings. ☛ "Selecting the Projection Quality (Selecting Color Mode)" p.77
Brightness	Adjusts the image brightness.
Contrast	Adjusts the difference between light and shade in the images.
Color Saturation	Adjusts the color saturation for the images.
Tint	You can adjust the image tint.

Submenu	Function
Sharpness	Standard: You can adjust the image sharpness. Thin Line Enhancement: If this parameter is set to a positive value, details such as hair or fabric patterns will be enhanced. Thick Line Enhancement: If this parameter is set to a positive value, the outline, background, and the other main parts of the objects in the image will be enhanced to show them clearly.
White Balance	You can adjust the overall tint of the image. Color Temp.: You can adjust the overall tint of the image within 14 stages from 3200K to 10000K. The image is tinted blue when a high value is selected and tinted red when a low value is selected. When Color Mode is set to Dynamic , the set Color Temp. may differ from the actual Color Temp. of the light from the projector. Use this menu as a guide. G-M Correction: The color tone is tinted red when set to a negative value, and tinted green when set to a positive value. Offset R/G/B, Gain R/G/B: You can adjust the offset and gain of each color R (red), G (green), and B (blue) individually.
Frame Interpolation *1, 2, 3, 4, 5	You can play fast moving images smoothly by producing intermediate frames between the original frames.

Submenu	Function
Image Enhancement	<p>You can adjust the image resolution.  "Adjusting Image Resolution (Image Enhancement)" p.87</p> <p>4K Enhancement*6: (EB-L1755U/EB-L1750U/EB-L1505UH/EB-L1500UH only) You can project at a doubled resolution.</p> <p>Image Preset Mode: You can select the optimal setting according to the projected image from five presets prepared in advance.</p> <p>Noise Reduction*2, 4, 7: You can smooth out the roughness in progressive images.</p> <p>MPEG Noise Reduction*2, 7: You can reduce dot and block noise that occurs in outlines when projecting MPEG movies.</p> <p>Super-resolution*7: To display a crisp image, you can reduce the blurring that is created on the edge when the resolution of the image signal is scaled up and projected.</p> <p>Detail Enhancement*7: You can enhance the contrast of details in an image.</p> <p>Reset*7: Returns the selected preset to its defaults.</p>
Advanced	<p>You can make adjustments by choosing the following items.</p> <p>Gamma: You can adjust the coloring by selecting one of the gamma correction values, or referring to the projected graph.</p> <p>RGBCMY: You can adjust the hue, saturation, and brightness of each color R (red), G (green), B (blue), C (cyan), M (magenta), Y (yellow) individually.</p> <p>Deinterlacing*4: (Only when the input signal is 480i, 576i, or 1080i) You can convert interlace signals into progressive signals. (IP conversion)</p> <p>Off is ideal for images with a large amount of movement, Video for general video images, and Film/Auto for movie films, computer graphics, and animation.</p>
Dynamic Contrast *8	<p>Set to Normal or High Speed to adjust the iris to obtain the optimum light for images being projected. Select High Speed to make faster iris corrections to match the speed of the scene.</p>

Submenu	Function
Reset	<p>You can reset all adjustment values for the Image menu to their default settings. See the following to return all menu items to their default settings.  "Reset Menu" p.167</p>

- *1 This cannot be set when E-Zoom is used.
- *2 This cannot be set when inputting signals whose resolution is higher than that of WUXGA signals or when 4K Enhancement is enabled.
- *3 This cannot be set when **Edge Blending** is set to **On**, **Scale** is enabled, or **Image Processing** is set to **Fast 1**.
- *4 This cannot be set when **Image Processing** is set to **Fast 2**.
- *5 This cannot be set when **Aspect** is set to **V-Zoom**.
- *6 This cannot be set when **Aspect** is set to **Native**.
- *7 This cannot be set when **Image Preset Mode** is set to **Off**.
- *8 This can be set only if **Color Mode** is set to **Dynamic** or **Cinema**.

Signal Menu

Settable items vary depending on the image signal and source currently being projected. Setting details are saved for each image signal.

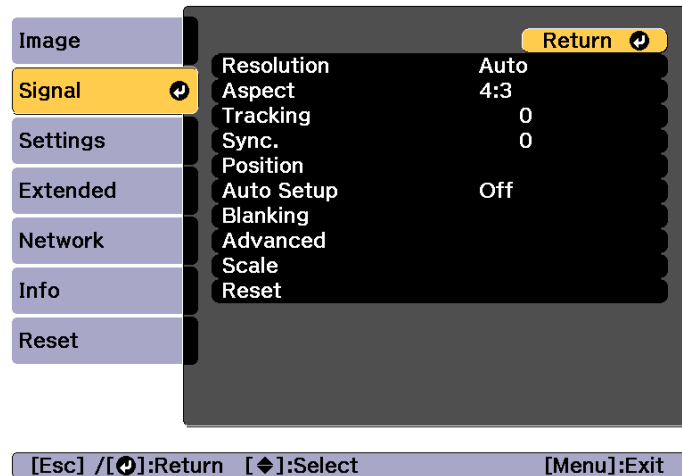

Submenu	Function
Sync.	(Only available when an analog RGB computer signal is being input.) You can adjust computer images when flickering, fuzziness, or interference appear in the images.
Position	You can adjust the display position up, down, left, and right when a part of the image is missing so that the whole image is projected.
Auto Setup	(Only available when an analog RGB computer signal is being input.) Set to On to automatically adjust Tracking, Sync., and Position to the optimum state when the input signal changes.
Overscan	Changes the output image ratio (the range of the projected image). You can set the cropping range to 4% or 8% . When set to Auto , this is automatically adjusted according to the input signal.
Blanking	You can hide images in the set area. Use the [◀] [▶] buttons to adjust the area. You can adjust by using a combination of Top , Bottom , Left , and Right .

Submenu	Function
Resolution	(Only available when an analog RGB computer signal is being input.) Set to Auto to automatically identify the resolution of the input signal. If images are not projected correctly when set to Auto , for example if some of the image is missing, set to Wide for wide screens, or set to Normal for 4:3 or 5:4 screens depending on the connected computer. Manual allows you to specify the resolution. This is ideal when connected computer is fixed.
Aspect	You can set the <u>Aspect Ratio</u> ▶ for projected images. ☛ "Changing the Aspect Ratio of the Projected Image" p.81
Tracking	(Only available when an analog RGB computer signal is being input.) You can adjust computer images when vertical stripes appear in the images.



Submenu	Function
Advanced	<p>You can set by choosing the following items.</p> <p>Video Range: Select the video range for the input signal from the HDMI port, DVI-D port, HDBaseT port, or SDI. Set to Expanded if you are concerned about misadjusted black levels or blown out highlights in the image.</p> <p>Input Signal: Select an input signal from the Computer port or BNC port. If set to Auto, the input signal is set automatically according to the connected equipment. If colors do not appear correctly when set to Auto, select the appropriate signal according to the connected equipment.</p> <p>Image Processing: Changes settings for image processing.</p> <ul style="list-style-type: none"> • Fine: When Frame Interpolation is On, Frame Interpolation is enabled. • Fast 1: Images are displayed quicker without any loss in image quality. • Fast 2: Images are displayed quicker than Fast 1. <p>EDID: (Displayed when the current source is HDMI, HDBaseT, or DVI-D) Disconnect the cable for the image currently being projected from the projector, and then make settings. Change the EDID of the current source when projecting multiple images with different resolutions to display the image correctly. After changing the EDID, restart the projector.</p> <p>The settings for WUXGA projectors are 3840x2160/30Hz, 1920x1200/60Hz (default), 1920x1080/60Hz, 1600x1200/60Hz, and 1400x1050/60Hz.</p> <p>The settings for SXGA+ projectors are 1920x1200/60Hz, 1920x1080/60Hz, 1600x1200/60Hz, 1400x1050/60Hz (default), and 1024x768/60Hz.</p> <p>DDC Buffer: (Displayed when the current source is HDMI or DVI-D) Setting this to On can sometimes improve images that are not displayed correctly from devices connected using an HDMI or DVI extension cable.</p>
Scale	<p>When using multiple projectors to project one image, adjust the range of the image displayed by each projector.</p> <p>☛ "Displaying a Scaled Image" p.105</p>

Submenu	Function
Reset	<p>You can reset all adjustment values on the Signal menu to their default settings, except for Input Signal and EDID.</p> <p>See the following to return all menu items to their default settings.</p> <p>☛ "Reset Menu" p.167</p>

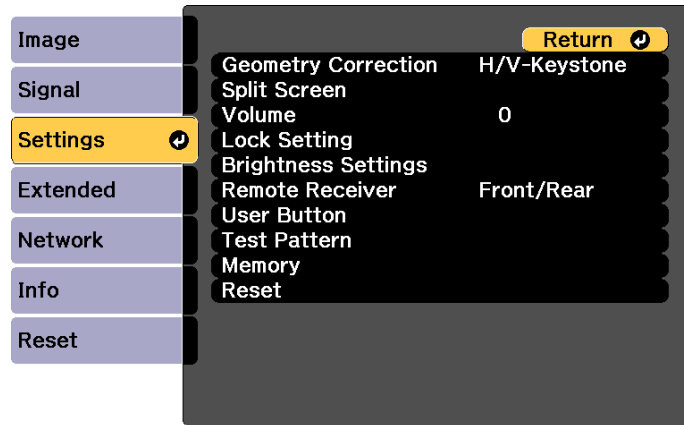
Settings Menu



[Esc] / [Return]:Return [Enter]:Select [Menu]:Exit

Submenu	Function
Geometry Correction	<p>You can correct distortion.</p> <p> "Correcting Distortion in the Projected Image" p.65</p> <ul style="list-style-type: none"> • Off: Temporarily cancels the geometry correction. • H/V-Keystone: Adjust V-Keystone, V-Balance, H-Keystone, and H-Balance to correct vertical and horizontal keystone distortion. • Quick Corner: Select and correct the four corners of the projected image. • Curved Surface: Corrects distortion that occurs when projecting on a curved surface. • Corner Wall: Corrects distortion that occurs when projecting on a surface with right angles. • Point Correction: Divides the projected image into a grid and corrects the distortion by moving the selected point of intersection from side to side and up and down. • Memory: You can save the adjustment value of the geometry correction and load it when needed.  "Memory Function" p.114
Split Screen	<p>You can split the screen into two screens.</p> <p> "Projecting Two Images Simultaneously (Split Screen)" p.107</p>
Volume	<p>You can adjust the volume. Setting values are saved for each source.</p>



Submenu	Function
Lock Setting	<p>Control Panel Lock: You can use this to restrict operation of the projector's control panel.</p> <p>☛ "Control Panel Lock" p.122</p> <p>Lens Lock: When set to On, [Lens Shift], [Zoom], and [Focus] button operations on the remote control are disabled.</p> <p>☛ "Lens Lock" p.123</p>
Brightness Settings	<p>Light Source Mode: Set the brightness for the light source.</p> <ul style="list-style-type: none"> • Normal: Select this if you do not want to decrease the brightness. This makes the target usage time approximately 20,000 hours. • Quiet: Select this if you are concerned about the noise made by the fan, This sets the brightness at 70%. This makes the target usage time 20,000 hours. • Extended: Select this to extend the life expectancy of the light source. This sets the brightness at 70%. This makes the target usage time approximately 30,000 hours. • Custom: Select this to set the brightness level within a range of 30 to 100%. <p>Brightness Level: (Only available when Light Source Mode is set to Custom) Sets the brightness for the light source.</p> <p>Constant Brightness: (Only available when Light Source Mode is set to Custom) When set to On, the brightness of the light source set in Brightness Level is maintained as it is. When Constant Brightness is set to On, you cannot change the settings for Light Source Mode and Brightness Level.</p> <p>☛ "Setting the Brightness" p.77</p> <p>Estimated Remains: When Constant Brightness is set to On, this indicates the amount of time for which constant brightness can be maintained.</p> <p>☛ "Guide to Estimated Remains" p.79</p>

Submenu	Function
Remote Receiver	<p>You can limit the reception of the operation signal from the remote control.</p> <p>When set to Off, you cannot perform any operations from the remote control. If you want to make operations from the remote control, hold down the [Menu] button on the remote control for at least 15 seconds to reset the setting to its default value.</p>
User Button	<p>Select the items in the Configuration menu that you want to assign to the [User1], [User2], and [User3] buttons on the remote control. The following items can be assigned.</p> <p>Light Source Mode, Multi-Projection, Resolution, Image Processing, On-Screen Display, Display the QR Code, Image Enhancement, Frame Interpolation, Screen Matching, Color Calibration</p>
Test Pattern	<p>You can display a test pattern to adjust the projection without connecting other equipment when you set up the projector.</p> <p>☛ "Displaying a Test Pattern" p.32</p>
Memory	<p>Perform operations and make settings for the memory function.</p> <p>☛ "Memory Function" p.114</p>
Reset	<p>You can reset all adjustment values on the Settings menu to their default settings, except for User Button and Memory.</p> <p>See the following to return all menu items to their default settings.</p> <p>☛ "Reset Menu" p.167</p>

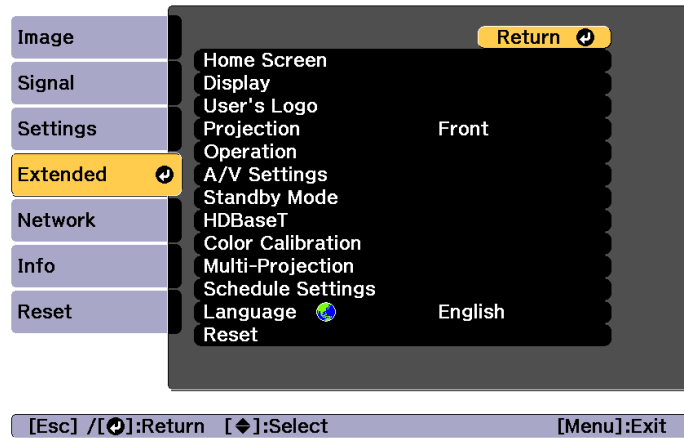
Extended Menu





Submenu	Function
Home Screen	<p>Home Screen Auto Disp.: When set to On, the Home screen is displayed when the projector turns on. The Home screen is not displayed when the selected source has an image signal when the projector turns on.</p> <p>Custom Function 1, Custom Function 2: Select functions to be assigned to the Home screen from the following five functions. Network Settings, Info, Image Enhancement, Frame Interpolation, Split Screen</p>

Submenu	Function
Display	<p>You can make settings related to the projector's display.</p> <p>Menu Position: Select the position to display the menu on the projected screen.</p> <p>Message Position: Select the position to display the message on the projected screen.</p> <p>Messages: When set to Off, the following items will not be displayed.</p> <p>Item names when the Source, Color Mode, or Aspect is changed, messages when no signal is being input, and warnings such as High Temp Warning.</p> <p>Display Background*: You can set the screen background to Black, Blue, or Logo when no image signal is available.</p> <p>Startup Screen*: Set to On to display the User's Logo when you turn on the projector.</p> <p>Standby Confirmation: (This is unavailable when the Remote Control Type is set to Simple.) If it is set to Off, you can turn off the power simply by pressing the [C] button once.</p> <p>Air Filter Notice: You can set whether or not (On/Off) to enable Air Filter Notice. When this is set to On and a clog in the air filter is detected, the message is displayed on the screen.</p> <p>Screen: (This is unavailable when projecting images from a computer over a network.) Set the aspect ratio and position of the projected screen according to the screen being used.  "Screen Settings" p.31</p> <p>Panel Alignment: Correct color misalignments (red and blue) in the screen.  "Panel Alignment" p.213</p> <p>Color Uniformity: Adjusts the color tone balance for the whole screen.  "Color Uniformity" p.215</p> <p>OSD Rotation: Rotates the menu direction by 90° degrees.</p>



Submenu	Function
User's Logo *	You can change the user's logo that is displayed as a background during Display Background, A/V Mute, and so on.  "Saving a User's Logo" p.113
Projection	Select from one of the following projection methods depending on how the projector is installed. Front, Front/Ceiling, Rear, and Rear/Ceiling You can change the setting as follows by pressing down the [A/V Mute] button for about five seconds. Front ↔ Front/Ceiling Rear ↔ Rear/Ceiling



Submenu	Function
Operation	<p>Direct Power On: Set to On to turn on the projector simply by plugging it in. When the power cord is plugged in, note that the projector turns on automatically in cases such as a power outage being restored.</p> <p>Sleep Mode: When set to On, this automatically stops projection when no image signal is being input and no operations are carried out.</p> <p>Sleep Mode Timer: When Sleep Mode is set to On, you can set the time before the projector automatically turns off within a range of 1 to 30 minutes.</p> <p>High Altitude Mode: Set to On when using the projector above an altitude of 1,500 m.</p> <p>Auto Source Search: Set to On to automatically detect an image signal from another source and project the image when there is no image signal from the current source.</p> <p>Auto Power On: If it is set to Computer or BNC, the projector is turned on when the signals are received from the Computer port or BNC port, even when the projector is in standby status.</p> <p>A/V Mute Settings: Perform settings related to A/V mute.</p> <ul style="list-style-type: none"> • Fade-in: Specify the number of seconds for fade-in when displaying an image. • Fade-out: Specify the number of seconds for fade-out when hiding an image. • A/V Mute Timer: When it is set to On, if no operations are performed for about 2 hours after A/V mute is activated, the projector turns off automatically. • A/V Mute Release: When it is set to A/V Mute, you can release A/V mute only by pressing the [A/V Mute] button (or by sending an A/V mute Off command). When set to Any Button, A/V mute is released when any operation is performed on the projector.









Submenu	Function
	<p> "Hiding the Image and Sound Temporarily (A/V Mute)" p.110</p> <p>Advanced: The following items can be set.</p> <ul style="list-style-type: none"> • BNC Sync Termination: Set the termination for the signal from the BNC port. This should usually be set to Off. Set to On when analog (75Ω) termination such as for switchers is necessary. • Remote Control Type: You can select Normal or Simple depending on the type of remote control. Set this item to Normal to use the remote control provided with this projector. When Simple is selected, you can use the remote control provided with other Epson projectors to operate this projector. This is useful if you want to use a remote control that you are already familiar with to operate the projector. However, you cannot use the remote control provided with this projector if this is set to Simple. Make sure that the setting is correct because, if the projector is mounted on the ceiling or somewhere hard to reach, changing it back to Normal may be difficult. Additionally, you cannot use the functions that are not equipped with this projector or the remote control which you use. • Beep: When this is set to On, the confirmation buzzer beeps to notify you that the power turns on or off, or cooling down is finished. • Indicators: When set to Off, the projector's indicators are turned off, except for abnormality or warning. • Instant Off: When set to Enabled, the projector goes into standby status in approximately three seconds after Power Off. If you turn the power on immediately after turning it off, command communication may be cut off. To stabilize command communication, set this to Disabled. When set

Submenu	Function
	<p>to Disabled, the projector goes into standby status in approximately 75 seconds after power off.</p> <ul style="list-style-type: none"> • Inv Direction Button: Set this to On when the projector is installed on a ceiling. • AC Voltage Monitoring: When this is set to On, and the projector is turned off by any method (including direct shutdown) except for pressing the power button, an AC Voltage Warning dialog is displayed the next time the projector is turned on. Set this to Off if you use direct shutdown regularly. • Lens Type: When using the following lens, select the model number of the lens. ELPLS04, ELPLU02, ELPLR04, ELPLW04, ELPLM06, ELPLM07, ELPLL07 <p>Date & Time: Make system time settings for the projector.</p> <p> "Setting the Time" p.45</p> <p>Lens Calibration: Acquires the information of the lens installed on the projector.</p>

Submenu	Function
A/V Settings	<p>A/V Output: Set this to Always On if you want to output audio and images to an external device even when the projector is in standby status.</p> <p>Monitor Out: Select the image source output to an external monitor when the projector is in standby status. When set to Auto, analog RGB signals from the Computer port or the BNC port are output depending on which source was selected when the projector was turned off.</p> <p>Audio Settings: Performs the following audio related settings.</p> <ul style="list-style-type: none"> • Audio Output: Select the audio to be output when projecting images from the Computer port, BNC port, or DVI-D port. When set to Auto, audio is output from the audio input port corresponding to each image input port.  "Connecting Equipment" p.48 • HDMI Audio Output: Select the audio source when projecting images from the HDMI port. If you select HDMI, audio for the image is output as it is. If you select Audio3, audio is output from the Audio3 port.

Submenu	Function
Standby Mode	<p>Standby Mode: If you set this to Communication On, you can perform the following operations even if the projector is in standby mode.</p> <ul style="list-style-type: none"> • Monitor and control the projector over a network. • Output audio and images to an external device. (Only when A/V Output is set to Always On.) • Communication from the HDBaseT port is enabled. (Only when Control Communications is set to On.) <div style="border: 1px solid black; padding: 5px; margin: 10px 0;">  When monitoring or controlling the projector using wireless LAN, set Connection Mode to Advanced.  Network - Wireless LAN - Connection Mode p.158 </div> <p>Port: Select the communication port that remains enabled when the projector is standing by.</p>

Submenu	Function
HDBaseT	<p>Control Communications: (This cannot be set when Extron XTP is set to On.) When set to On, Ethernet communication, serial communication, and the wired remote control through the HDBaseT Transmitter connected to the HDBaseT port are all enabled.</p> <p>Extron XTP: Set to On when you connect the Extron XTP transmitter or switcher to the HDBaseT port. See the following Extron Web site for more details on the XTP system. http://www.extron.com/</p> <div style="border: 1px solid black; padding: 5px; margin-top: 10px;">  <ul style="list-style-type: none"> • When Control Communications or Extron XTP is set to On, Standby Mode is automatically set to Communication On. • When Control Communications or Extron XTP is On, the projector's LAN port, RS-232 port, and Remote port are disabled. • When Extron XTP is set to On, the fan may rotate in standby mode but this is not abnormal. </div>
Color Calibration	<p>Start Auto Adjustment: Automatically adjusts the color tone for the whole screen.  "Color Calibration" p.212</p> <p>Undo: Undoes the auto adjustment.</p> <p>Redo: Redoes the auto adjustment.</p> <p>Color Uniformity: Adjusts the color tone balance for the whole screen.  "Color Uniformity" p.215</p> <p>Reset: You can reset all adjustment values for Color Calibration to their default values.</p>

Submenu	Function
Multi-Projection	<p>Make settings when projecting from multiple projectors.  "Multi-Projection Function" p.93</p> <p>Projector ID: Set the ID from 01 to 30. Off indicates that no ID is set.  "ID Settings" p.43</p> <p>Projector Grouping: When using multiple projectors to project one image, select the projectors being used.</p> <p>Tiling: Set the number of split screens and positions of each projected image.  "Tiling" p.94</p> <p>Geometry Correction: Corrects distortion in the projected image.  "Correcting Distortion in the Projected Image" p.65</p> <p>Edge Blending: Corrects a border between multiple images to create a seamless screen.  "Edge Blending" p.97</p> <p>Black Level: Adjusts the differences in brightness and tone for areas where images overlap and areas where the images do not overlap.  "Black Level" p.99</p> <p>Scale: When using multiple projectors to project one image, adjust the range of the image displayed by each projector.  "Displaying a Scaled Image" p.105</p> <p>Screen Matching: Adjusts the tint and brightness for each projector.  "Screen Matching" p.102</p> <p>Reset: You can reset all adjustment values for the Multi-Projection menu to their default settings.</p>
Schedule Settings	<p>You can set the projector's schedule so that it performs a specific operation at a pre-scheduled time.  "Scheduling Function" p.116</p>
Language	<p>You can set the language for messages and menus.</p>

Submenu	Function
Reset	<p>You can reset all adjustment values for the Extended menu to their default settings. However, the following items are not reset.</p> <p>Screen Type, Screen Position, LCD Alignment, Color Uniformity, Projection, High Altitude Mode, Auto Source Search, A/V Mute Release, Remote Control Type, Inv Direction Button, Lens Type, Date & Time, Lens Calibration, A/V Output, Monitor Out, Standby Mode, Port, Control Communications, Extron XTP, Projector ID, Color Calibration, Projector Grouping, Tiling, Edge Blending, Black Level, Screen Matching, Color Matching, Language</p> <p>See the following to return all menu items to their default settings.</p> <p>☛ "Reset Menu" p.167</p>

* When **User's Logo Protection** is set to **On** in **Password Protection**, you cannot change settings related to user's logo. You can make changes after setting **User's Logo Protection** to **Off**.

☛ "Managing Users (Password Protection)" [p.120](#)

Network Menu

When **Network Protection** is set to **On** in **Password Protection**, a message is displayed and the network settings cannot be changed. Set **Network Protection** to **Off** and then configure the network.

☛ "Setting Password Protection" [p.120](#)

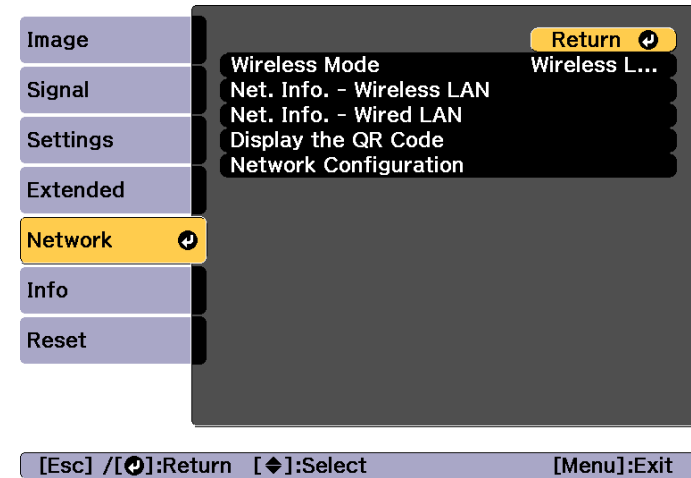

Submenu	Function
Wireless Mode	Set this to Wireless LAN On when connecting the projector and a computer via a wireless LAN. If you do not want to connect via wireless LAN, turn it Off to prevent unauthorized access by others.

Submenu	Function
Net. Info. - Wireless LAN	<p>Displays the following network setting status information.</p> <ul style="list-style-type: none"> • Connection Mode • Wireless LAN Sys. • Antenna Level • Projector Name • SSID • DHCP • IP Address • Subnet Mask • Gateway Address • MAC Address • Region Code <p>When IPv6 is selected, the following information is displayed.</p> <ul style="list-style-type: none"> • IPv6 Address (Manual): IPv6 Address, Prefix Length, Gateway Address • IPv6 Address (Auto): Temporary Address, Link-local Address, Stateless Address, Stateful Address
Net. Info. - Wired LAN	<p>Displays the following network setting status information.</p> <ul style="list-style-type: none"> • Projector Name • DHCP • IP Address • Subnet Mask • Gateway Address • MAC Address • IPv6 Address (Manual): IPv6 Address, Prefix Length, Gateway Address • IPv6 Address (Auto): Temporary Address, Link-local Address, Stateless Address, Stateful Address
Display the QR Code	<p>When connecting iOS or Android devices using Epson iProjection, read the QR code displayed.</p>

Submenu	Function
Network Configuration	<p>The following menus are available for setting Network items. Basic, Wireless LAN, Wired LAN, Notifications, Others, Reset</p>
Remote Camera Access	<p>Set this to On to check the projected image from a remote location. You can also set a password when shooting images using remote camera access from Epson Web Control.</p> <p> "Checking the projected image from a remote location" p.224</p>

Notes on operating the Network menu

Selecting from the top menu and sub menus, and changing selected items is the same as making operations from the Configuration menu.

When done, make sure you go to the **Complete** menu, and select **Yes**, **No**, or **Cancel**. When you select **Yes** or **No**, you are returned to the Configuration menu.

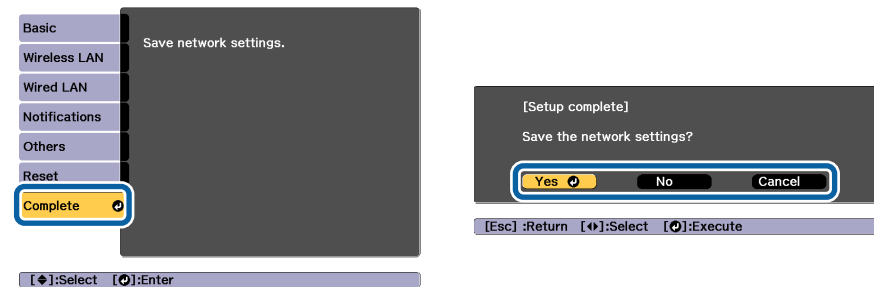

Yes: Saves the settings and exits the Network menu.

No: Does not save the settings and exits the Network menu.

Cancel: Continues displaying the Network menu.

Soft keyboard operations

The Network menu contains items that require input of alphanumerics during setup. In this case, the following software keyboard is displayed. Use [▲][▼][◀][▶] buttons to move the cursor to the desired key, and then press the [↵] button to enter the selected character. Enter figures by holding down the [Num] button on the remote control, and pressing the numeric buttons. After inputting, press **Finish** on the keyboard to confirm your input. Press **Cancel** on the keyboard to cancel your input.



- Each time the **CAPS** key is selected and the [↵] button is pressed, it sets and changes between upper case and lower case letters.
- Each time the **SYM1/2** key is selected and the [↵] button is pressed, it sets and changes the symbol keys for the section enclosed by the frame.

The following types of character can be entered.

Numbers	0123456789
Letters	ABCDEFGHIJKLMNOPQRSTUVWXYZ abcdefghijklmnopqrstuvwxyz
Symbols	!"#\$%&'()*+,-./:;<=>?@[\\]^_`{ }~

Basic menu

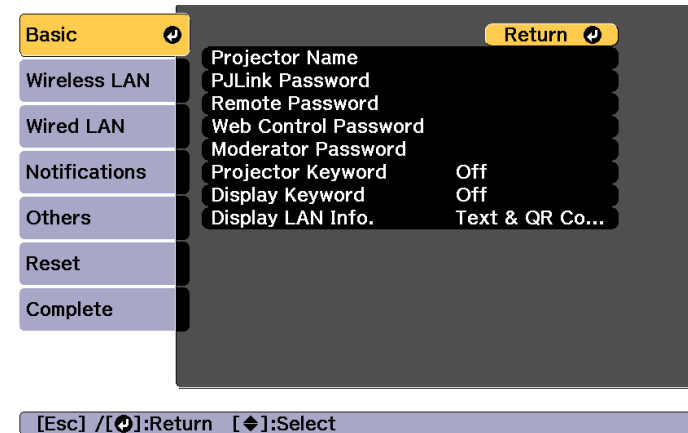

Submenu	Function
Projector Name	Enter the projector name used to identify the projector over a network. When editing, you can enter up to 16 single-byte alphanumeric characters. (" * + , / ; < = > ? [\] ` and spaces cannot be used.)
PLink Password	Set a password to use when you access the projector using compatible PLink software. You can enter up to 32 single-byte alphanumeric characters. (Spaces and symbols cannot be used.) ☛ "About PLink" p.230
Remote Password	Set a password to use Remote in Epson Web Control. You can enter up to 8 single-byte alphanumeric characters. (* : and spaces cannot be used.) The default user name is "EPSONREMOTE" and the default password is "guest". ☛ "Changing Settings Using a Web Browser (Epson Web Control)" p.218

Submenu	Function
Web Control Password	Set a password for authentication to use when making settings and controlling the projector using Web Control in Epson Web Control. You can enter up to eight single-byte alphanumeric characters (* : and spaces cannot be used). The default user name is "EPSONWEB" and the default password is "admin". ☛ "Changing Settings Using a Web Browser (Epson Web Control)" p.218
Moderator Password	Enter the four digit authentication password for using Epson iProjection when connecting to the projector as a moderator. (There is no default password.)
Projector Keyword	Set this to On to enable a security password to prevent other users from accidentally projecting images. When projecting images from a computer or mobile device, you need to enter the keyword displayed on the projection screen in Epson iProjection.
Display Keyword	When this is set to On and when connecting to the projector using Epson iProjection, the projector keyword is displayed on the projection screen. This is only enabled when Projector Keyword is set to On .
Display LAN Info.	Set the display format for the projector's network information. If you display the QR code, you can connect to a network just by reading the QR code in Epson iProjection. Text & QR Code is set by default.

Wireless LAN menu

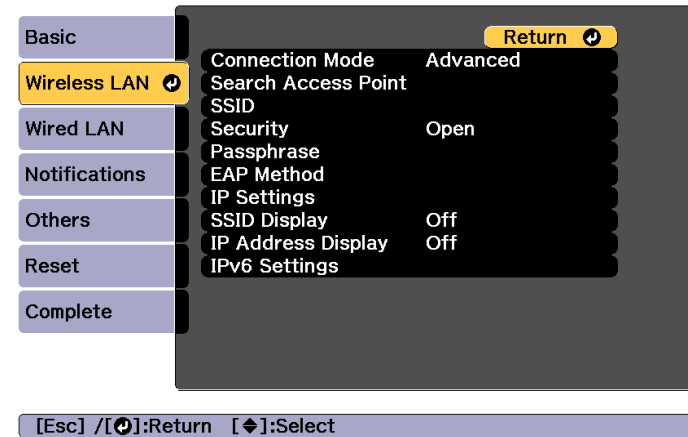

To connect the projector to a computer using a wireless LAN, install the Wireless LAN unit (ELPAP10).

☛ "Installing the Wireless LAN Unit" [p.55](#)



Submenu	Function
Connection Mode	Set the connection mode to use when connecting the projector and a computer via a wireless LAN. Quick: Lets you directly connect to a smartphone, tablet, or computer via a wireless LAN. Advanced: Lets you connect to a smartphone, tablet, or computer over a wireless LAN access point. The connection is established in infrastructure mode.
Search Access Point	When Connection Mode is set to Advanced , you can search for surrounding access points, and set the SSID to be connected from those access points. Depending on the access point settings, they may not be displayed in the list. ☛ "Search Access Point screen" p.161

Submenu	Function
SSID	Enter an SSID. When an SSID is provided for the wireless LAN system in which the projector participates, enter the SSID. You can enter up to 32 single-byte alphanumeric characters.
Security	Select the security type according to the wireless LAN settings. Open: Security is not set. WPA2-PSK: Communication is performed using WPA2 security. Uses AES method for encryption. When establishing a connection from a computer to the projector, enter the value set in the passphrase. WPA/WPA2-PSK*: Connects in WPA personal mode. Encryption method is selected automatically according to the access point settings. Set a passphrase which is the same for the access point. WPA2-EAP*: Communication is performed using WPA2 security. Uses AES method for encryption. WPA/WPA2-EAP*: Connects in WPA enterprise mode. Encryption method is selected automatically according to the access point settings.
Passphrase	Enter a passphrase used to connect to the network when Security is set to WPA2-PSK or WPA/WPA2-PSK . You can enter at least 8 and up to 63 single-byte alphanumeric characters. You can enter up to 32 characters on the Configuration menu. When entering more than 32 characters, use your Web browser to enter the text.  "Changing Settings Using a Web Browser (Epson Web Control)" p.218 When Connection Mode is set to Quick , the initial passphrase is set.

Submenu	Function
EAP Method	Set protocols for WPA2-EAP and WPA/WPA2-EAP authentication. EAP Type: Select the certification protocol. <ul style="list-style-type: none"> • PEAP: Authentication protocol widely used in Windows Server. • PEAP-TLS: Authentication protocol used in Windows Server. Select when using a client certificate. • EAP-TLS: Authentication protocol widely used to use a client certificate. • EAP-FAST, LEAP: Select this when these authentication protocols are used. User name: Enter a user name to be used for authentication. You can enter up to 64 single-byte alphanumeric characters. You can enter up to 32 characters on the Configuration menu. When entering more than 32 characters, use your Web browser to enter the text.  "Changing Settings Using a Web Browser (Epson Web Control)" p.218 If you also need to enter a domain name, add the domain name before the user name separated by a backslash (domain name\user name). Password: Enter the password used for authentication in PEAP, EAP-FAST, and LEAP. You can enter up to 64 single-byte alphanumeric characters. You can enter up to 32 characters on the Configuration menu. When entering more than 32 characters, use your Web browser to enter the text.  "Changing Settings Using a Web Browser (Epson Web Control)" p.218 When the password is entered and Finish is selected, the value is set and displayed as an asterisk (*). Client Certificate: Imports client certificates for use in PEAP-TLS and EAP-TLS.

Submenu	Function
	<p>Verify Server Cert.: Set to On to perform verification for the certificate of the certification server. To verify a server certificate, you need to set CA certificate.</p> <p>CA certificate: Imports CA certificates for use in PEAP, PEAP-TLS, EAP-TLS, and EAP-FAST.</p> <p>RADIUS Serv.Name: Specify the name of the certification server. You can enter up to 32 single-byte alphanumeric characters.</p>
Channel	You can select the channels used to connect in Quick mode. If interference from other signals occurs, use a different channel.
IP Settings*	<p>Perform network settings.</p> <p>DHCP: Set to On to configure the network using DHCP. If this is set to On, you cannot set any more addresses.</p> <p>IP Address: You can enter the IP address assigned to the projector. You can enter a number from 0 to 255 in each field of the address. However, the following IP addresses cannot be used. 0.0.0.0, 127.x.x.x, 224.0.0.0 to 255.255.255.255 (where x is a number from 0 to 255)</p> <p>Subnet Mask: You can enter the Subnet Mask for the projector. You can enter a number from 0 to 255 in each field of the address. However, the following subnet masks cannot be used. 0.0.0.0, 255.255.255.255</p> <p>Gateway Address: You can enter the IP address for the gateway for the projector. You can enter a number from 0 to 255 in each field of the address. However, the following Gateway Address cannot be used. 0.0.0.0, 127.x.x.x, 224.0.0.0 to 255.255.255.255 (where x is a number from 0 to 255)</p>
SSID Display	To prevent the SSID from being displayed on the LAN Standby screen, set this to Off .
IP Address Display	To prevent the IP address from being displayed on the LAN Standby screen, set this to Off .

Submenu	Function
IPv6 Settings	<p>Perform settings to use the IPv6 protocols.</p> <div style="border: 1px solid black; padding: 10px; margin: 10px 0;">  <ul style="list-style-type: none"> • The following functions support IPv6 protocols. <ul style="list-style-type: none"> - Epson Web Control - PjLink • When setting the IPv6 address manually, make settings in Advanced from Epson Web Control. <ul style="list-style-type: none"> ☛ "Changing Settings Using a Web Browser (Epson Web Control)" p.218 </div> <p>IPv6: Set this to On when using IPv6 protocols. Make sure one link local address is set when using IPv6. This is composed of the interface ID created from fe80:: and the projector's MAC address.</p> <p>Auto Configuration: Set this to On to automatically acquire an IPv6 address from RA (Router Advertisement). The address is composed as shown below.</p> <ul style="list-style-type: none"> • Stateless Address (0 to 6): Created automatically by combining the prefix acquired from the RA (Router Advertisement) and the interface ID created from the projector's MAC address. • Stateful Address (0 to 1): Created automatically from the DHCP server using DHCPv6. <p>Use Temporary Address: Set this to On to temporarily validate the IPv6 address (0 to 1) when Auto Configuration is On.</p>

* This can be selected only when Connection Mode is set to **Advanced**.

Type of security

When the optional wireless LAN unit is attached and being used in Advanced connection mode, it is strongly recommended that you set security.

WPA is an encryption standard that improves the security for wireless networks. The projector supports TKIP and AES encryption methods.

WPA also includes user authentication functions. WPA authentication provides two methods: using an authentication server, or authenticating between a computer and an access point without using a server. This projector supports the latter method, without a server.





For setting details, follow the instructions from your network administrator.

Search Access Point screen

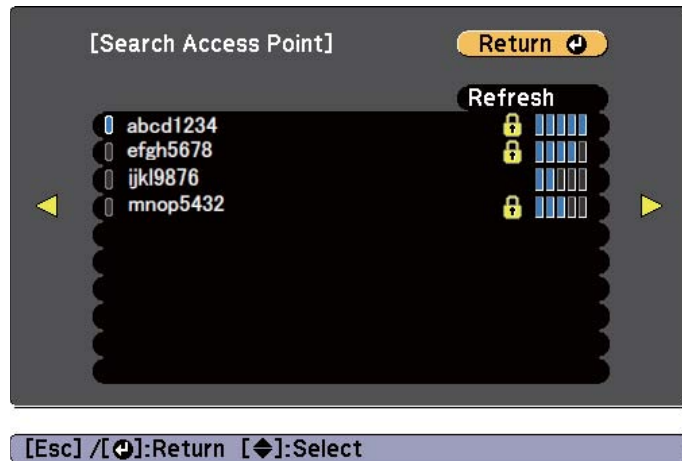
Detected access points are displayed in a list.



Submenu	Function
Refresh	Searches for the access point again.
	Indicates an already set access point.

Submenu	Function
	Indicates the access points where security is set. If you select an access point where security has not been set, the Wireless LAN menu is displayed. If you select an access point where security has been set, the Security menu is displayed. Select a type of security according to the security settings for the access point.

Wired LAN menu

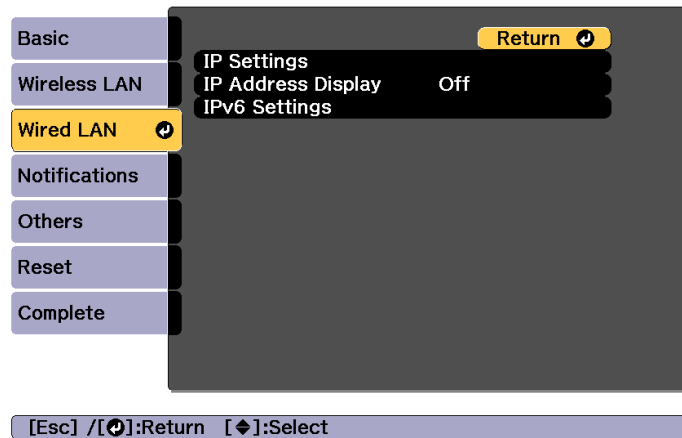

Submenu	Function
IP Settings	<p>You can make settings related to the following addresses.</p> <p>DHCP: Set to On to configure the network using DHCP. If this is set to On, you cannot set any more addresses.</p> <p>IP Address: You can enter the IP address assigned to the projector. You can enter a number from 0 to 255 in each field of the address. However, the following IP addresses cannot be used. 0.0.0.0, 127.x.x.x, 224.0.0.0 to 255.255.255.255 (where x is a number from 0 to 255)</p> <p>Subnet Mask: You can enter the Subnet Mask for the projector. You can enter a number from 0 to 255 in each field of the address. However, the following subnet masks cannot be used. 0.0.0.0, 255.255.255.255</p> <p>Gateway Address: You can enter the IP address for the gateway for the projector. You can enter a number from 0 to 255 in each field of the address. However, the following Gateway Address cannot be used. 0.0.0.0, 127.x.x.x, 224.0.0.0 to 255.255.255.255 (where x is a number from 0 to 255)</p>

Submenu	Function
IP Address Display	To prevent the IP address from being displayed on the LAN Standby screen, set this to Off .
IPv6 Settings	<p>Perform settings to use the IPv6 protocols.</p> <div style="border: 1px solid black; padding: 10px; margin: 10px 0;">  <ul style="list-style-type: none"> The following functions support IPv6 protocols. <ul style="list-style-type: none"> Epson Web Control PJLink When setting the IPv6 address manually, make settings in Advanced from Epson Web Control. <ul style="list-style-type: none"> "Changing Settings Using a Web Browser (Epson Web Control)" p.218 </div> <p>IPv6: Set this to On when using IPv6 protocols. Make sure one link local address is set when using IPv6. This is composed of the interface ID created from fe80:: and the projector's MAC address.</p> <p>Auto Configuration: Set this to On to automatically acquire an IPv6 address from RA (Router Advertisement). The address is composed as shown below.</p> <ul style="list-style-type: none"> Stateless Address (0 to 6): Created automatically by combining the prefix acquired from the RA (Router Advertisement) and the interface ID created from the projector's MAC address. Stateful Address (0 to 1): Created automatically from the DHCP server using DHCPv6. <p>Use Temporary Address: Set this to On to temporarily validate the IPv6 address (0 to 1) when Auto Configuration is On.</p>

Notifications menu

When this is set, you receive an email notification if a problem or warning occurs in the projector.

☛ "Reading error notification mail" p.227

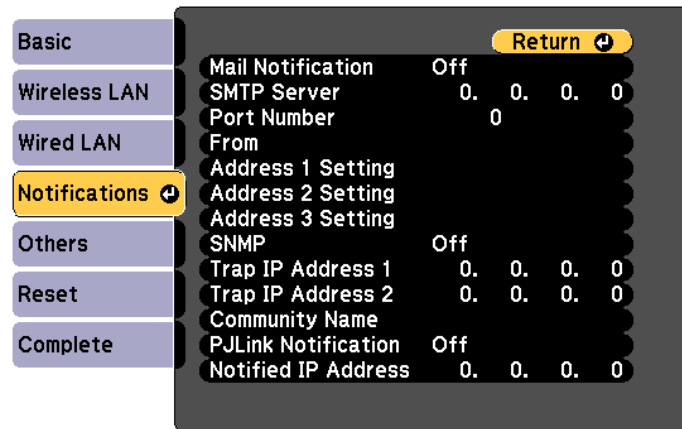

[Esc] / [Return]: Return [Enter]: Select



Submenu	Function
Mail Notification	Set to On to send an email to the preset addresses when a problem or warning occurs with a projector.
SMTP Server	You can input the <u>IP Address</u> for the SMTP server for the projector. You can enter a number from 0 to 255 in each field of the address. However, the following IP addresses cannot be used. 127.x.x.x, 224.0.0.0 to 255.255.255.255 (where x is a number from 0 to 255)
Port Number	You can input the port number for the SMTP server. The default value is 25. You can input numbers between 1 to 65535.
From	Enter the email address of the sender. You can enter up to 64 single-byte alphanumeric characters. You can enter up to 32 characters on the Configuration menu. When entering more than 32 characters, use your Web browser to enter the text. (" () , ; < > [\] and spaces cannot be used.) ☛ "Changing Settings Using a Web Browser (Epson Web Control)" p.218

Submenu	Function
Address 1 Setting/Address 2 Setting/Address 3 Setting	Set the destination email addresses for the notification email, and the notification content. You can register up to three destinations. You can enter up to 64 single-byte alphanumeric characters. You can enter up to 32 characters on the Configuration menu. When entering more than 32 characters, use your Web browser to enter the text. (" () , ; < > [\] and spaces cannot be used.) ☛ "Changing Settings Using a Web Browser (Epson Web Control)" p.218
SNMP	Set to On to monitor the projector using <u>SNMP</u> . To monitor the projector, you need to install the SNMP manager program on your computer. SNMP should be managed by a network administrator. The default value is Off .
Trap IP Address 1/Trap IP Address 2	You can register up to two IP addresses for the SNMP trap notification destination. You can enter a number from 0 to 255 in each field of the address. However, the following IP addresses cannot be used. 127.x.x.x, 224.0.0.0 to 255.255.255.255 (where x is a number from 0 to 255)
Community Name	Set the community name of SNMP. You can enter up to 32 single-byte alphanumeric characters. (Spaces and symbols cannot be used.)
PLink Notification	Set this to On to use the PLink notification function.
Notified IP Address	Enter the IP address of the computer to which you want to send notifications of the projector's operating status using the PLink notification function. You can enter a number from 0 to 255 in each field of the address. However, the following IP addresses cannot be used. 127.x.x.x, 224.0.0.0 to 255.255.255.255 (where x is a number from 0 to 255)

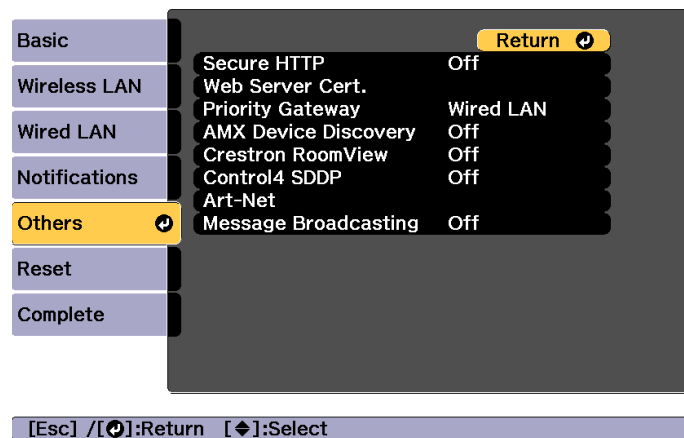
Others menu



Submenu	Function
Secure HTTP	To strengthen security, communication between the projector and computer in Epson Web Control is encrypted. When setting security with Epson Web Control, we recommend setting this to On .
Web Server Cert.	Imports the Web server certificate used in Secure HTTP.
Priority Gateway	For the priority gateway, select either Wired or Wireless .
AMX Device Discovery	When you want to allow the projector to be detected by <u>AMX Device Discovery</u> , set this to On . Set this to Off if you are not connected to an environment controlled by a controller from AMX or AMX Device Discovery.

Submenu	Function
Crestron RoomView	Set this to On only when monitoring or controlling the projector over the network using Crestron RoomView®. Otherwise, set this to Off .  "About Crestron RoomView®" p.230 Changes in projector settings take effect upon restarting. When this is set to On , the following functions are not available. <ul style="list-style-type: none"> • Epson Web Control • The Message Broadcasting feature in the Epson Projector Management software
Control4 SDDP	Set to On if you want to enable the acquisition of the device information by <u>Control4® Simple Device Discovery Protocol (SDDP)</u> .
Art-Net	Art-Net: Set this to On to control the projector using Art-Net.  "Art-Net" p.235 Net/Sub-Net/Universe: Sets the projector's Net/Sub-Net/Universe. Start Channel: Sets the start channel that handles Art-Net.  "Channel definitions" p.235
Message Broadcasting	Set this to On to receive information sent by the Message Broadcasting feature in the Epson Projector Management software. Download software and User's Guides from the following Web site. http://www.epson.com

Reset menu

Resets all of the network settings.

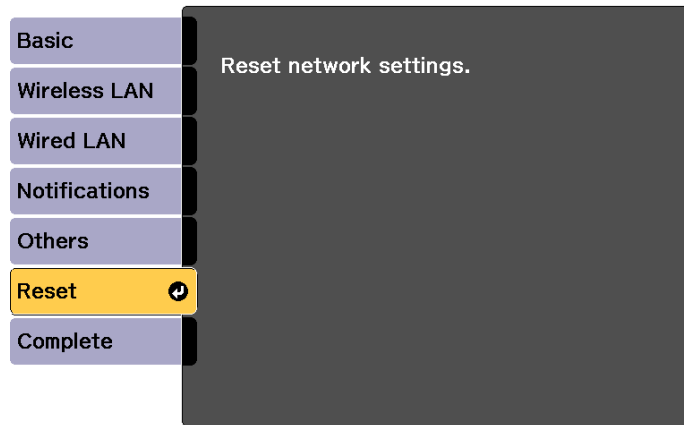

[◀]:Select [↵]:Enter

Submenu	Function
Reset network settings.	To reset all of the Network settings, select Yes .

Info Menu (Display Only)

Lets you check the status of the image signals being projected and the status of the projector. Items that can be displayed vary depending on the source currently being projected.

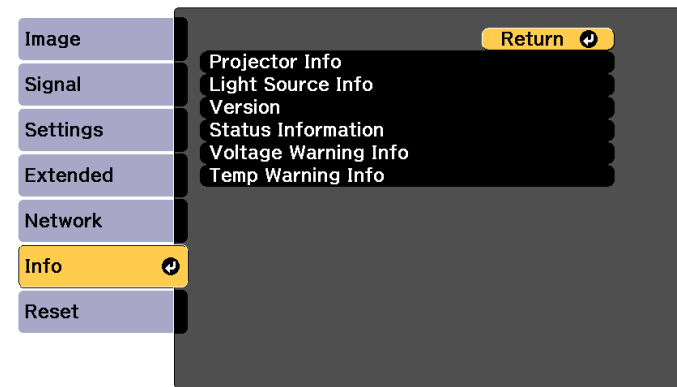

[Esc] / [↵]:Return [◀]:Select [Menu]:Exit

Submenu	Function	
Projector Info	Operation Hours*	Displays the operation time after turning on the projector.
	Source	You can display the source name for the connected equipment currently being projected.
	Input Signal	You can display the content of Input Signal set in the Signal menu according to the source.
	Resolution	You can display the resolution.
	Refresh Rate	You can display the <u>Refresh Rate</u> [▶] .
	Sync Info	You can display the image signal information. This information may be needed if service is required.

Submenu		Function
	Status	This is information about errors that have occurred on the projector. This information may be needed if service is required.
	Serial Number	Displays the projector's serial number.
	Lens Type	Displays the model number of your lens.
	Event ID	When problems occur when the projector and computer are connected through the network, information on the problem is displayed using an Event ID. See the following page for information on interpreting the Event ID. ☛ "About Event ID" p.204
	HDBaseT Signal Level	Displays the level for the image signal being input from the HDBaseT port. When this is displayed in yellow, the strength of the signal level is reduced. We recommend the following signal levels. <ul style="list-style-type: none"> • 1080p: 16dB or more • 4K: 18dB or more
Light Source Info	Light Source Hours	Displays the operating time for the light source according to the light source mode.
	Estimated Remains	When Constant Brightness is set to On , this displays the amount of time for which the brightness of the light source can be maintained.
Version	Main Video2	Displays the projector's firmware version information.
Status Information		Displays the projector's status. ☛ "Reading the Status Display" p.184

Submenu	Function
Voltage Warning Info	Displays up to 10 instances of voltage warnings. When you select Detail when a Warning or Error is displayed, you can check detailed logs for before and after the error was detected. When a brief voltage error is detected as in the following cases, voltage warning information may not be displayed correctly. <ul style="list-style-type: none"> • Brief voltage drop • Brief blackout • When turning on immediately after turning off Wait for at least 10 seconds after turning off the projector before turning it back on. When the projector turns on, check the status information. ☛ "Reading the Status Display" p.184
Temp Warning Info	Displays up to 7 instances of high temperature warnings. When you select Detail when a Warning or Error is displayed, you can check detailed logs for before and after the error was detected.

* The cumulative use time is displayed as "0H" for the first 10 hours. 10 hours and above is displayed as "10H", "11H", and so on.

Reset Menu

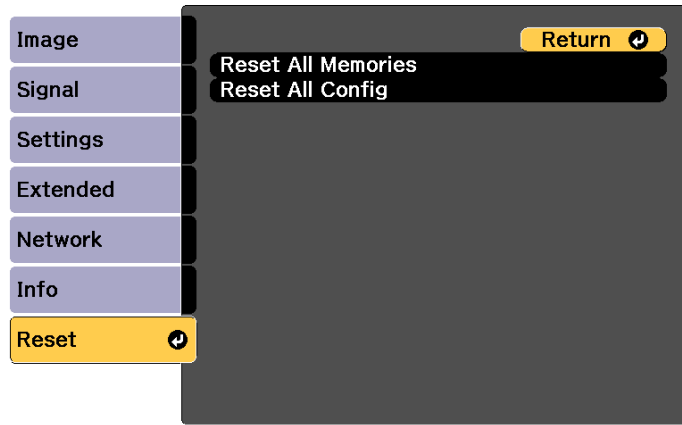

[Esc] / [↩]:Return [⬇]:Select [Menu]:Exit

Submenu	Function
Reset All Memories	Resets all names and settings saved in Memory , Lens Position , and Geometry Correction .  "Memory Function" p.114
Reset All Config	You can reset all items in the Configuration menu to their default settings. The following items are not reset to their defaults: Input Signal , EDID , Memory , User's Logo , all items for Network menus, Language , Date & Time , Panel Alignment , Color Uniformity , Lens Calibration , Color Calibration , Projector Grouping , Screen Matching , Color Matching , Light Source Info , and Operation Hours .

Once the Configuration menu content has been set for one projector, you can use it to perform batch setup for multiple projectors (batch setup function). The batch setup function is only for projectors with the same model number.

Use one of the following methods.

- Setup using a USB flash drive.
- Setup by connecting the computer and projector with a USB cable.
- Setup using EasyMP Network Updater.

This manual explains the USB flash drive and the USB cable methods.



- The following content is not reflected by the batch setup function.
 - The Network menu settings (except for the Notifications menu and the Others menu)
 - Status and Light Source Info in the Info menu
- Perform batch setup before adjusting the projected image. Adjustment values for the projected image, such as Geometry Correction are reflected by the batch setup function. If batch setup is performed after adjusting the projected image, the adjustments you made may change.
- By using the batch setup function, the registered User's Logo is set for the other projectors. Do not register confidential information and so on as the User's Logo.



Caution

Performing batch setup is the customers responsibility. If batch setup fails due to a power failure, communication error, and so on, the customer is responsible for any repair costs incurred.

Setup Using a USB Flash Drive

This section explains how to perform batch setup using a USB flash drive.



- Use a FAT format USB flash drive.
- The batch setup function cannot be used by USB flash drives that incorporate security functions. Use a USB flash drive that does not incorporate security functions.
- The batch setup function cannot be used by USB card readers or USB hard disks.

Saving settings to the USB flash drive

- 1** Disconnect the power cord from the projector, and check that all of the projector's indicators have turned off.
- 2** Connect the USB flash drive to the projector's wireless LAN unit.
 - "Installing the Wireless LAN Unit" [p.55](#)

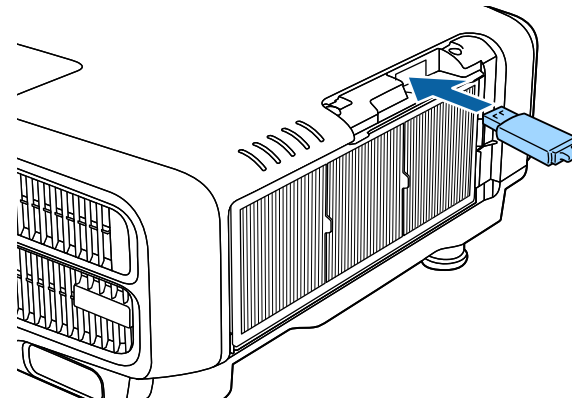



- Connect the USB flash drive directly to the projector. If the USB flash drive is connected to the projector through a USB hub, the settings may not be saved correctly.
- Connect an empty USB flash drive. If the USB flash drive contains data other than the batch setup file, the settings may not be saved correctly.
- If you have saved a batch setup file from another projector to the USB flash drive, delete the file or change the file name. The batch setup function cannot overwrite a batch setup file.
- The file name for the batch setup file is PJCONFDATA.bin. If you need to change the file name, add text after PJCONFDATA. If you change the file name in any other way, the projector may not be able to recognize the file correctly.
- You can only use single-byte characters for the file name.

3 While holding down the [Esc] button on the remote control or the control panel, connect the power cord to the projector.

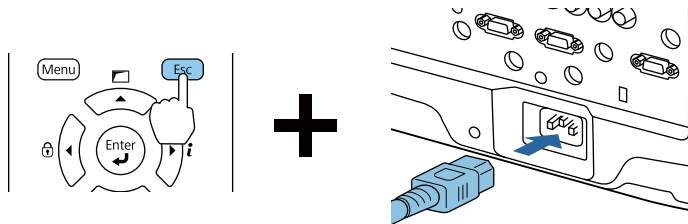

When the projector's indicators turn on as follows, release the [Esc] button.

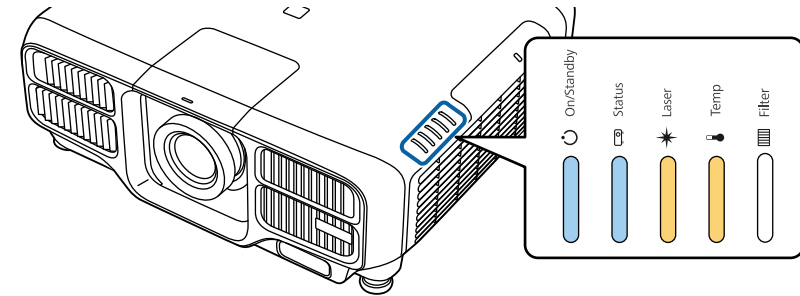

Power supply	Status	Laser	Temp
Blue - On	Blue - On	Orange - On	Orange - On

When all of the indicators start flashing, the batch setup file is being written.

Caution

- Do not disconnect the power cord from the projector while the file is being written. If the power cord is disconnected, the projector may not start correctly.
- Do not disconnect the USB flash drive from the projector while the file is being written. If the USB flash drive is disconnected, the projector may not start correctly.

When writing completes normally, the projector enters standby status.

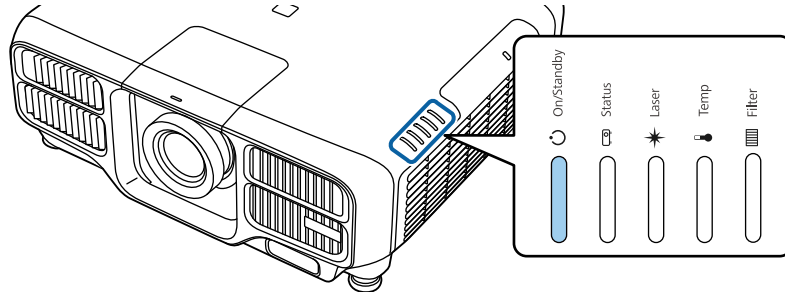

Power supply
Blue - On

When the projector is in standby status, remove the USB flash drive.

Reflecting saved settings to other projectors

- 1** Disconnect the power cord from the projector, and check that all of the projector's indicators have turned off.
- 2** Connect the USB flash drive containing the saved batch setup file to the projector's wireless LAN unit port.

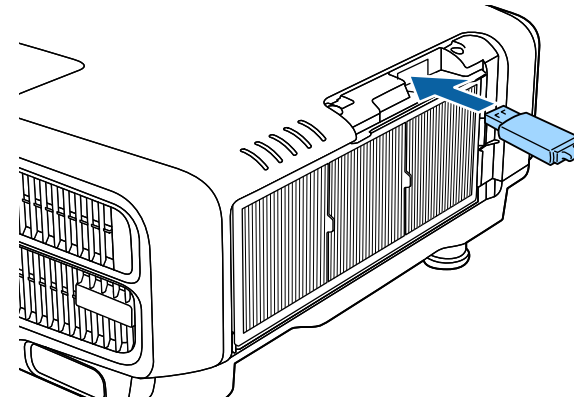

- When the USB flash drive contains 1 to 3 types of batch setup files, the file is reflected to the projector with the same model number. If there are multiple files for a projector with the same model number, the settings may not be reflected correctly.
- When there are four or more types of batch setup files on the USB flash drive, the settings may not be reflected correctly.
- Do not store any data except for the batch setup file on the USB flash drive. If the USB flash drive contains data other than the batch setup file, the settings may not be reflected correctly.

3 While holding down the [Menu] on the remote control or the control panel, connect the power cord to the projector.

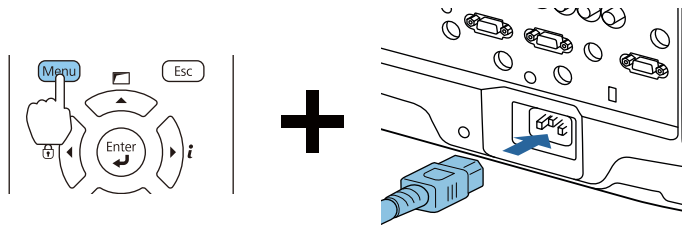

When the projector's indicators turn on as follows, release the [Menu] button.

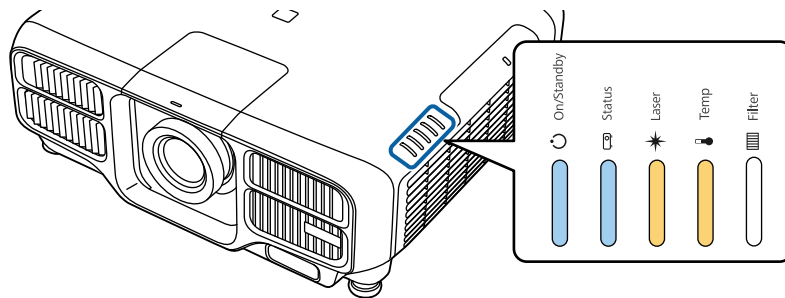

Power supply	Status	Laser	Temp
Blue - On	Blue - On	Orange - On	Orange - On

The indicators remain on for about 75 seconds.

When all of the indicators start flashing, the settings are being written.

! Caution

- Do not disconnect the power cord from the projector while the settings are being written. If the power cord is disconnected, the projector may not start correctly.
- Do not disconnect the USB flash drive from the projector while the settings are being written. If the USB flash drive is disconnected, the projector may not start correctly.

4 When writing completes normally, the projector enters standby status.

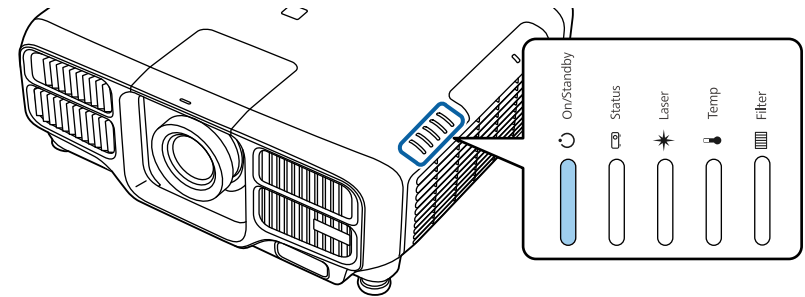

Power supply
Blue - On

When the projector is in standby status, remove the USB flash drive.

Setup by Connecting the Computer and Projector with a USB Cable



The following operating systems support the batch setup function.

- Windows Vista or later
- Mac OS X 10.7.x or later

Saving settings to a computer

- 1 Disconnect the power cord from the projector, and check that all of the projector's indicators have turned off.
- 2 Connect the computer's USB port to the projector's Service port with a USB cable.

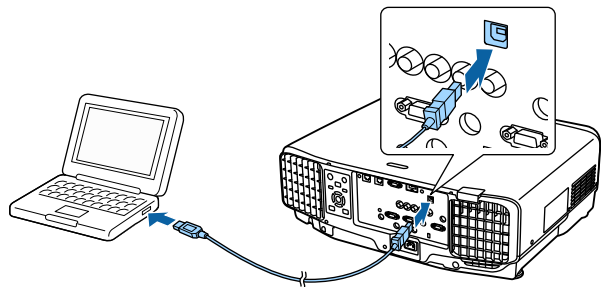

- 3 While holding down the [Esc] button on the remote control or the control panel, connect the power cord to the projector.

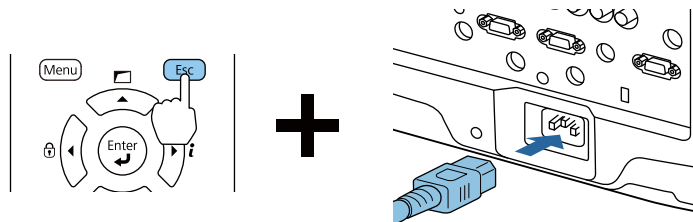

When the projector's indicators turn on as follows, release the [Esc] button.

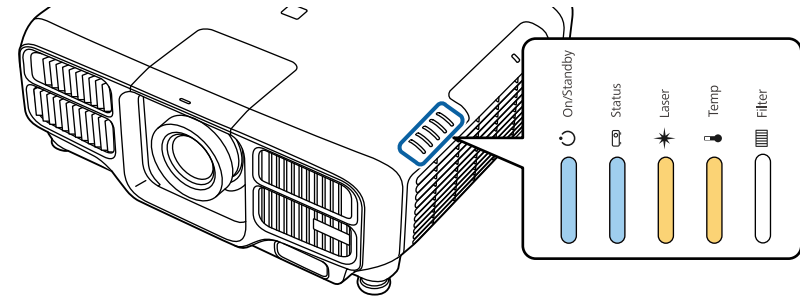

Power supply	Status	Laser	Temp
Blue - On	Blue - On	Orange - On	Orange - On

The projector is recognized as a removable disk by the computer.

- 4 Open the removable disk, and save the batch setup file (PJCONFDATA.bin) to the computer.



If you need to change the name of the batch setup file, add text after PJCONFDATA. If you change the file name, the projector may not be able to recognize the file correctly.

- 5 Perform "Remove USB device" on your computer, and then disconnect the USB cable.



When using OS X, perform "Remove EPSON_PJ".

The projector enters standby status.

Reflecting saved settings to other projectors

- 1** Disconnect the power cord from the projector, and check that all of the projector's indicators have turned off.
- 2** Connect the computer's USB port to the projector's Service port with a USB cable.

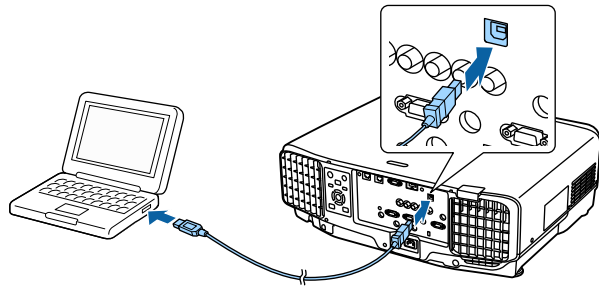

- 3** While holding down the [Menu] on the remote control or the control panel, connect the power cord to the projector.

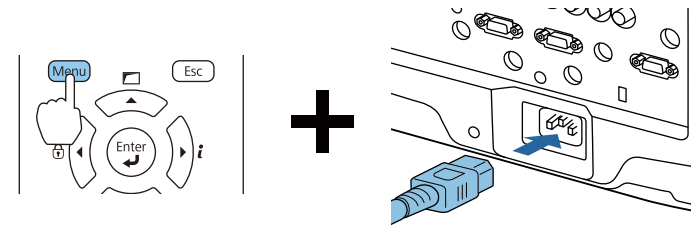

When the projector's indicators turn on as follows, release the [Menu] button.

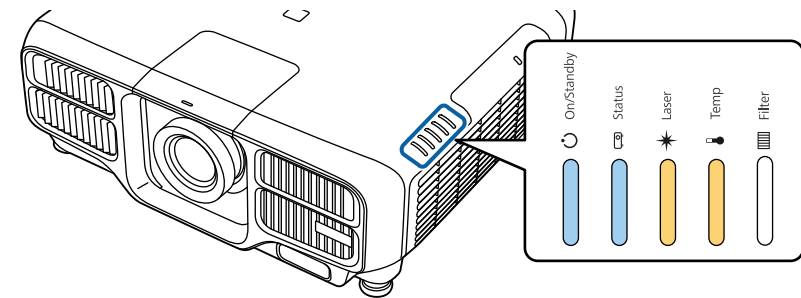

Power supply	Status	Laser	Temp
Blue - On	Blue - On	Orange - On	Orange - On

The projector is recognized as a removable disk by the computer.

- 4** Copy the batch setup file (PJCONFDATA.bin) that you saved to your computer to the top level folder of the removable disk.



Do not copy any files or folders other than the batch setup file to the removable disk.

- 5** Perform "Remove USB device" on your computer, and then disconnect the USB cable.



When using OS X, perform "Remove EPSON_PJ".

When all of the indicators start flashing, the settings are being written.



Caution

Do not disconnect the power cord from the projector while the settings are being written. If the power cord is disconnected, the projector may not start correctly.

When writing completes normally, the projector enters standby status.

When Setup Fails

The Indicators notify you if an error occurs. Check the status of the indicators.

Status of the Indicators	Remedy
<p>Laser: Orange - flashing fast Temp: Orange - flashing fast</p>	<p>The batch setup file may be corrupt, or the USB flash drive may not be connected correctly. Disconnect the USB flash drive, unplug and then plug in the projector's power cord, and then try again.</p>
<p>Power: Blue - flashing fast Status: Blue - flashing fast Laser: Orange - flashing fast Temp: Orange - flashing fast</p>	<p>Writing the settings may have failed and an error may have occurred in the projector's firmware. Stop using the projector, remove the power plug from the electrical outlet, and contact your local dealer or the nearest address provided in the Epson Projector Contact List. Epson Projector Contact List</p>



Troubleshooting

This chapter explains how to identify problems and what to do if a problem is found.

If a problem occurs with the projector, you can display the Help screen to assist you. You can also set the projector to an appropriate state by answering the questions.

- 1 Press the [**Home**] button.

The Home screen is displayed.

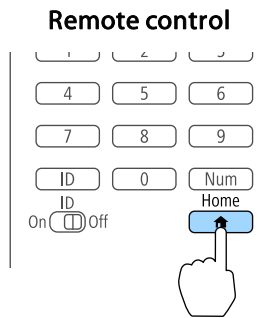

- 2 Select Help, and then press the [**Enter**] button.

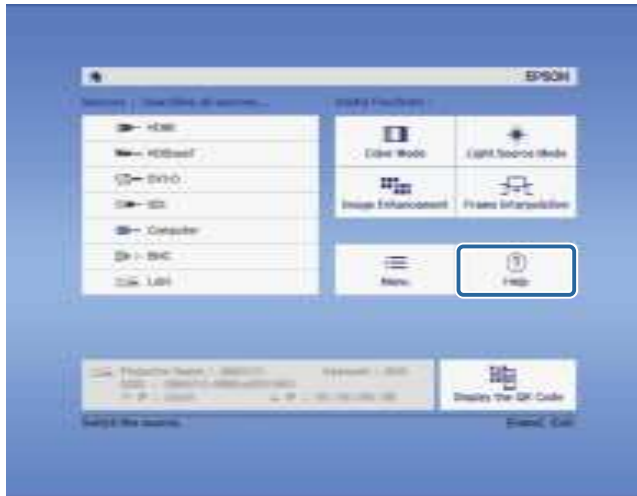

The Help screen is displayed.

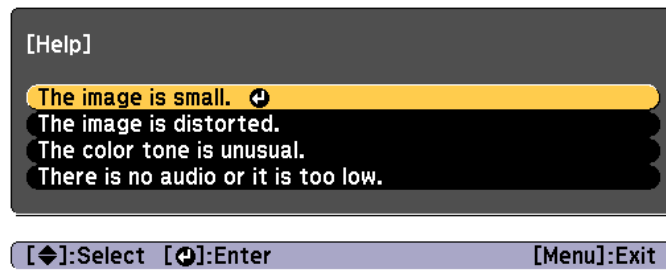

- 3 Select a menu item.

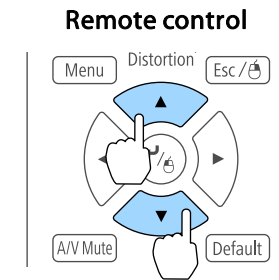

- 4 Confirm the selection.

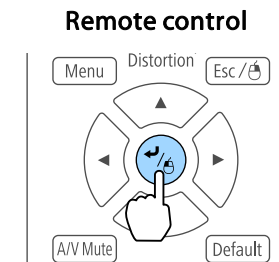

Questions and solutions are displayed as shown on the screen below. Press the [Menu] button to exit Help.

The image is small.

- ❓ Is zoom set to minimum?
· Press the [Zoom] button to change the size of the image.
- ❓ Is the projector too close to the screen?
· Move the projector away from the screen.

[Esc] :Return

[Help] :Exit



See the following if the Help function does not provide a solution to the problem.

☞ "Reading the Indicators" [p.178](#)



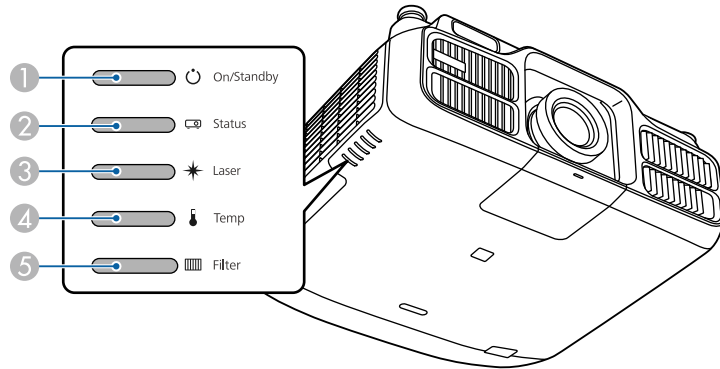







This projector has the following five indicators to indicate the projector's status.























- ① Power indicator
Indicates the projector's status.
- ② Status indicator
Indicates the projector's status.
- ③ Laser indicator
Indicates the light source status.
- ④ Temp indicator
Indicates the internal temperature status. This is normally turned off.
- ⑤ Filter indicator
Indicates the air filter status. This is normally turned off.

The following indicator status are used during regular operation.

"Status varies" indicates that the indicators turn on, off, or flash depending on the status of the projector.



























Indicator					Projector's Status	Explanation
Power supply	Status	Laser	Temp	Filter		
 Blue - On	 Off	 Off	 Off	 Off	Standby condition Network monitoring status	Power is being supplied to the projector. In this status, you can start projecting by pressing the [Ⓜ] button on the remote control or control panel. (Sometimes, when the power cord is unplugged, the power indicator remains lit for a short period, but this is not a fault.) The projector is being monitored and controlled over a network (when Standby Mode is set to Communication On). If the power cord is disconnected and then reconnected in this status, the power indicator flashes blue.
 Blue - On	 Blue - Flashing	 Status varies	 Off	 Off	Warm-up status	This is the status immediately after turning on the projector. Warm-up takes approximately 30 seconds after the light source turns on. The [Ⓜ] button is disabled during warm-up.



























Indicator					Projector's Status	Explanation
Power supply	Status	Laser	Temp	Filter		
 Blue - On	 Blue - On	 Status varies	 Off	 Off	Projecting	The projector is projecting.
 Blue - On	 Blue - Flashing	 Off	 Off	 Off	Cool down status	This is the status immediately after turning off the power. In this status, all buttons are disabled.
 Blue - Flashing	 Off	 Off	 Off	 Off	Preparing Network monitoring	Preparing to monitor and control this projector over a network. During network monitoring preparation, all button operations are disabled.
 Blue - On	 Blue - On	 Blue - Flashing	 Off	 Off	A/V Mute activated	A/V Mute is active.

When an error has occurred in the projector, the error status is indicated by the indicator's color and combination of flashing or lit.

Refer to the following table to see what the indicators mean and how to remedy problems that they indicate.

Indicator					Cause	Remedy or Status
Power supply	Status	Laser	Temp	Filter		
Off	Blue - Flashing	Orange - Flashing	Off	Off	Internal Error	Stop using the projector, remove the power plug from the electrical outlet, and contact your local dealer or the nearest address provided in the Epson Projector Contact List. ☛ Epson Projector Contact List
Off	Blue - Flashing	Off	Orange - Flashing	Off	Fan Error Sensor Error	Stop using the projector, remove the power plug from the electrical outlet, and contact your local dealer or the nearest address provided in the Epson Projector Contact List. ☛ Epson Projector Contact List
Off	Blue - Flashing	Off	Orange - On	Off	High Temp Error (Overheating)	<p>The light source turns off automatically and projection stops. Wait for about five minutes. After about five minutes the projector switches to standby mode, so check the following two points.</p> <ul style="list-style-type: none"> • Check that the air filter and air exhaust vents are clear, and that the projector is not positioned against a wall. • If the air filter are clogged, remove the power cord from the electrical outlet, and then clean or replace them. ☛ "Cleaning the Air Filter" p.207 ☛ "Replacing the Air Filter" p.210 <p>If the error continues after checking the points above, stop using the projector, remove the power plug from the electrical outlet, and contact your local dealer or the nearest address provided in the Epson Projector Contact List. ☛ Epson Projector Contact List</p>
						When using at an altitude of 1500 m or more, set High Altitude Mode to On . ☛ Extended - Operation - High Altitude Mode p.150
Off	Blue - Flashing	Orange - On	Off	Off	Laser Error Retardation Plate Error	Stop using the projector, remove the power plug from the electrical outlet, and contact your local dealer or the nearest address provided in the Epson Projector Contact List. ☛ Epson Projector Contact List

Indicator					Cause	Remedy or Status
Power supply	Status	Laser	Temp	Filter		
 Off	 Blue - Flashing	 Off	 Off	 Orange - On	Filter Airflow Error	<p>Check the following two points.</p> <ul style="list-style-type: none"> • Check that the air filter and air exhaust vents are clear, and that the projector is not positioned against a wall. • If the air filter is clogged, turn off the power, remove the power cord from the electrical outlet, and then clean or replace them. <p> "Cleaning the Air Filter" p.207  "Replacing the Air Filter" p.210</p> <p>After checking, connect the power cord to the electrical outlet.</p> <p>If the error continues after checking the points above, stop using the projector, remove the power plug from the electrical outlet, and contact your local dealer or the nearest address provided in the Epson Projector Contact List.</p> <p> Epson Projector Contact List</p>
 Off	 Blue - Flashing	 Orange - On	 Orange - On	 Off	Lens Shift Error	<p>Stop using the projector, remove the power plug from the electrical outlet, and contact your local dealer or the nearest address provided in the Epson Projector Contact List.</p> <p> Epson Projector Contact List</p>
 Blue - Flashing	 Status varies	 Status varies	 Orange - Flashing	 Status varies	High Temp Warning	<p>This is not an error. However, if the temperature rises too high again, projection stops automatically. Check the following two points.</p> <ul style="list-style-type: none"> • Check that the air filter and air exhaust vents are clear, and that the projector is not positioned against a wall. • If the air filter is clogged, turn off the power, remove the power cord from the electrical outlet, and then clean or replace them. <p> "Cleaning the Air Filter" p.207  "Replacing the Air Filter" p.210</p>
 Blue - Flashing	 Status varies	 Orange - Flashing	 Status varies	 Status varies	Laser Warning	<p>Stop using the projector, remove the power plug from the electrical outlet, and contact your local dealer or the nearest address provided in the Epson Projector Contact List.</p> <p> Epson Projector Contact List</p>

Indicator					Cause	Remedy or Status
Power supply	Status	Laser	Temp	Filter		
 Blue - Flashing	 Status varies	 Orange - Flashing	 Status varies	 Status varies	Lens Warning	An unsupported lens is attached. Use a supported lens.  "Optional Accessories and Consumables" p.240
 Blue - Flashing	 Status varies	 Status varies	 Status varies	 Orange - On	Low Air Flow	This is not an error. However, projection stops automatically if the airflow falls any further. "The air filter is clogged. Clean or replace the air filter." is displayed. Check the following two points. <ul style="list-style-type: none"> • Check that the air filter and air exhaust vents are clear, and that the projector is not positioned against a wall. • If the air filter is clogged, turn off the power, remove the power cord from the electrical outlet, and then clean or replace them. <ul style="list-style-type: none">  "Cleaning the Air Filter" p.207  "Replacing the Air Filter" p.210 If the error continues after checking the points above, stop using the projector, remove the power plug from the electrical outlet, and contact your local dealer or the nearest address provided in the Epson Projector Contact List.  Epson Projector Contact List
 Status varies	 Status varies	 Status varies	 Status varies	 Orange - Flashing	Air Filter Notice	"Time to clean the air filter. Clean or replace the air filter." is displayed. Turn off the projector's power, unplug the power cord from the electrical outlet, and then clean the air filter.  "Cleaning the Air Filter" p.207 The indicators or messages regarding air filter notice are displayed only when Air Filter Notice is set to On in the Configuration menu.  Extended - Display - Air Filter Notice p.150
 Status varies	 Status varies	 Orange - Flashing	 Status varies	 Status varies	Constant Brightness End	Ends the Constant Brightness mode in Brightness Settings .  "Setting the Brightness" p.77



- See the following if the projector is not operating properly, even though the indicators are all showing normal.
 - ☛ "Problem Solving" [p.192](#)
- If the indicators are in a state not shown in this table, stop using the projector, remove the power plug from the electrical outlet, and contact your local dealer or the nearest address provided in the Epson Projector Contact List.
 - ☛ [Epson Projector Contact List](#)

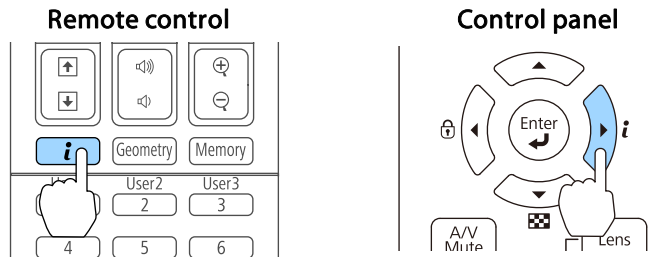

You can display the operating status of the projector on the projected image. You can check the detailed status of the projector by using button operations.

- 1 Press the [i] button while projecting.

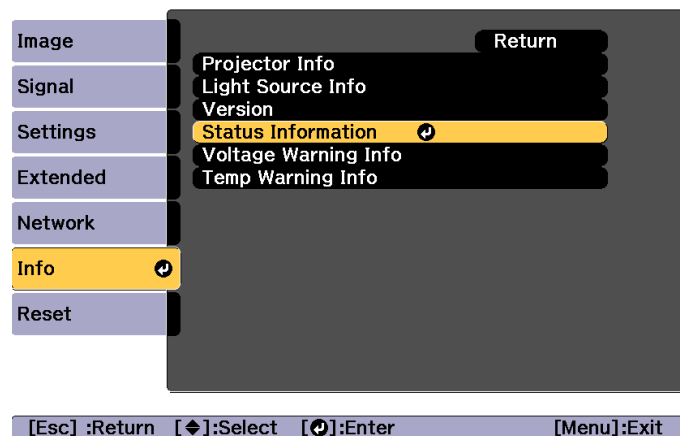

- 2 Select **Status Information**, and then press the [↵] button.



 You can also operate from the Configuration menu.
 **Info - Status Information** [p.165](#)

- 3 Use the [◀][▶] buttons or the [▲][▼] buttons to select a category.

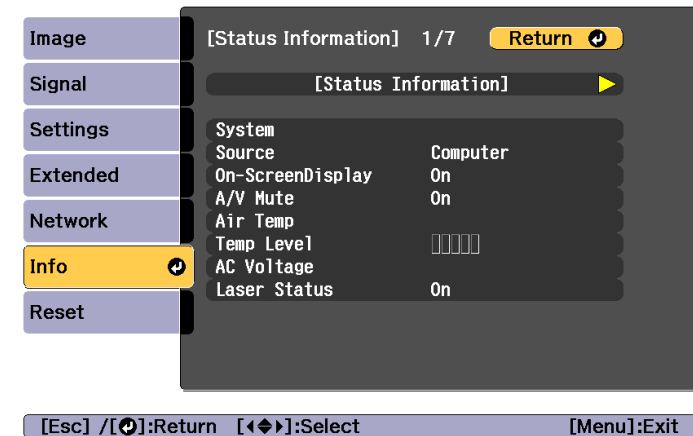

Each display category contains the following information.

Status Information	: Operating status of the projector
Source	: Input signal information
Signal Information	: Input digital signal information
Network Wired	: Wired LAN settings
Network Wireless	: Wireless LAN settings
Maintenance	: Operating time for the projector and light source
Version	: Projector's firmware version

Explanations of the Display Content

Category	Item	Status Display	Explanation
Status Information	System	Displays the projector's status. See the following for more information on how to remedy the errors and warnings. ☛ "Reading the Indicators" p.178	
		OK	The projector is in normal status.
		Warm-Up	The projector is warming up.
		Standby	The projector is in standby status.
		Cool Down	The projector is in cool down status.
		Temp Error	A high temp error has occurred.
		Fan Error	A fan error has occurred.
		Sensor Error	A sensor error has occurred.
		Power Error	A power error (Ballast) has occurred.
		Internal Error	An internal error has occurred.
		Airflow Error	A filter airflow error has occurred.
		Temp Warning	A high temp warning has occurred.
		Internal Warning	A warning about the internal system has occurred.
		Airflow Decline	A low air flow error has occurred.
		Power Warning	A power warning (Ballast) has occurred.
		Clean Filter	An air filter notice has occurred.
		Lens Error	A lens error has occurred.
Laser Error	A laser error has occurred.		
Laser Warning	A laser warning has occurred.		



Category	Item	Status Display	Explanation
Status Information	Source	HDMI	Displays the source name for the connected equipment currently being projected.
		HDBaseT	
		DVI-D	
		SDI	
		Computer	
		BNC	
		LAN	
	On-Screen Display	On	Displays the settings for the On-Screen Display . When set to Off , the menus or messages are not displayed on the projected images.
		Off	
	A/V Mute	On	Displays the operating status of A/V mute.
		Off	
	Air Temp	-	Displays the usage environment temperature.
Temp Level	-		
AC Voltage	-	<p>Monitors the status of the input voltage, and displays a warning or an error when a momentary voltage drop occurs.</p> <p>The 10 most recent logs are displayed in Voltage Warning Info from the Info menu.</p> <p>When you select Detail when a Warning or Error is displayed, you can check detailed logs for before and after the error was detected.</p> <p>Example:</p> <p>175V: Indicates that the voltage is 175V.</p> <p>B50V: Indicates that the voltage is 50V or less.</p> <p>---V: Indicates that there are no voltage logs available.</p> <p>Check the following if logs are not displayed correctly.</p> <p>☛ "Detailed logs and error message are not displayed" p.203</p>	
<Warning1>		<p>Voltage drop: If the input voltage drops below 89 V for more than 1,000 msec, logs for approximately one second* before and after the event (120 logs) are displayed.</p> <p>* The number of seconds varies according to the power supply frequency (50 Hz/60 Hz).</p>	

Category	Item	Status Display	Explanation
		<Warning2>	Power flicker: If the input voltage drops below 85 V for more than 40 msec, and the voltage returns within 60 msec, logs for approximately one second before the power flicker was detected (60 logs) and for approximately 0.1 seconds after (6 logs) are displayed.
		<Error>	Power cut: If the input voltage drops below 85 V for more than 60 msec, the projector is automatically disconnected from the power supply. Logs for approximately one second before the event was detected (60 logs) are displayed. When direct shutdown is enabled, an <Error> is generated when a direct shutdown is performed, however this is not an actual error.
	Laser Status	On Off	Displays the operating status of the light source.
Source	Source	HDMI	Displays the source name for the connected equipment currently being projected.
		HDBaseT	
		DVI-D	
		SDI	
		Computer	
		BNC	
		LAN	
	Resolution	-	Displays the resolution of the current input signal. No Signal: No signals are being input. Not Supported: The projector does not support the current input signal.

Category	Item	Status Display	Explanation
Source	Video Signal	-	Displays the current input video signal.
	Color Space	RGB	Displays the color space of the current input signal.
		YCbCr	
		YPbPr	
	H-Frequency	-	Displays the horizontal frequency of the current input signal.
	V-Frequency	-	Displays the vertical frequency of the current input signal.
	Sync Polarity	H:Posi / V:Posi	Displays the Sync polarity.
		H:Posi / V:Nega	
		H:Nega / V:Posi	
		H:Nega / V:Nega	
	Sync Mode	Composite Sync	Displays the sync type.
		Separate Sync	
		Sync On Green	
	Detected Mode	-	Displays the discriminant resolution of the current input signal.
Video Level	Auto (Normal)	Displays the video level of the projector.	
	Auto (Expanded)		
	Normal		
	Expanded		



Items displayed for source vary depending on the model being used and the image signal and source being projected.

Category	Item	Status Display	Explanation
Signal Information	5V Detection	Detected	Displays the detection results of 5V signals.
		Not Detect	
	TMDS Clock	-	Displays the TMDS frequency of the current input signal.
	TMDS H-Frequency	-	Displays the horizontal frequency of the current input signal.
	TMDS V-Frequency	-	Displays the vertical frequency of the current input signal.
	DetChg 5CFHMP123	-	Displays the factors of signal changes.
	Stable Time	-	Displays the operating time since the input source is determined.
	HDCP Status	Non-HDCP	Displays the HDCP status.
		Passed	
		Failed	
	HDCP Ver	-	Displays the HDCP version.
	AVI Info VIC	-	Displays the VIC information (AVI) of the current input signal.
	AVI InfoChecksum	OK	Displays the checksum result for AVI.
		NG	
	Signal Mode	HDMI	Displays the signal mode.
		DVI	
	Pixel Encoding	RGB	Displays the color space information (AVI) of the current input signal.
YUV4:4:4			
YUV4:2:2			
YUV4:2:0			
HDBaseT Level	-	You can display the image signal information from the HDBaseT port.	



Items displayed for Signal Information vary depending on the model being used and the image signal and source being projected.











Category	Item	Status Display	Explanation
Network Wired	Projector Name	-	Displays the projector name used to identify the projector when connected to a network.
	Connection Mode	HDBaseT	Displays the connection path for LAN.
		LAN	
	DHCP	On	Displays the DHCP settings.
		Off	
	IP Display	On	Displays the IP address display settings.
		Off	
IP Address	-	Displays the IP address.	
MAC Address	-	Displays the MAC address.	
Network Wireless	Projector Name	-	Displays the projector name used to identify the projector when connected to a network.
	Connection Mode	Quick	Displays the connection mode to use when connecting the projector and a computer over a wireless LAN.
		Advanced	
	SSID Display	On	Displays the SSID display settings.
		Off	
	IP Display	On	Displays the IP address display settings.
		Off	
	SSID	-	Displays the SSID.
	IP Address	-	Displays the IP address.
	DHCP	On	Displays the DHCP settings.
		Off	
	MAC Address	-	Displays the MAC address.
	Security	No	Displays the security settings.
WPA2-PSK			
WPA/WPA2-PSK			
Antenna Level	LEVEL 0-5	Displays the reception status for Wi-Fi.	



Category	Item	Status Display	Explanation
Maintenance	Operation Time	-	Displays the total operation time of the projector.
	Laser Op.Time	-	Displays the laser operating time for each setting in Light Source Mode.
Version	Serial No.	-	Displays the projector's serial number.
	Main	-	Displays the projector's firmware version information.
	Video2	-	
	Sub	-	
	Sub2	-	
	Sub3	-	
	HDBaseT	-	

If any of the following problems occur and the indicators do not offer a solution, refer to the pages given for each problem.

Problems Relating to Images







<ul style="list-style-type: none"> • No images appear Projection does not start, the projection area is completely black, or the projection area is completely blue. 	 p.193
<ul style="list-style-type: none"> • Moving images are not displayed Videos played back on a computer are black or no image is projected, or the video is not played back on the computer. 	 p.194
<ul style="list-style-type: none"> • Projection stops automatically 	 p.194
<ul style="list-style-type: none"> • The message "Not supported" is displayed 	 p.194
<ul style="list-style-type: none"> • The message "No Signal" is displayed 	 p.195
<ul style="list-style-type: none"> • Images are fuzzy, out of focus, or distorted 	 p.195
<ul style="list-style-type: none"> • Interference or distortion appear in images 	 p.196
<ul style="list-style-type: none"> • The image is truncated (large) or small, the aspect ratio is not suitable, or the image has been reversed Only part of the image is displayed, the height and width ratios of the image are not correct, or the image may appear reversed from top to bottom or left to right. 	 p.196
<ul style="list-style-type: none"> • Image colors are not right The whole image appears purplish or greenish, images are black & white, or colors appear dull. 	 p.197
<ul style="list-style-type: none"> • Images appear dark 	 p.198
<ul style="list-style-type: none"> • Automatic adjustments are not performed correctly 	 p.198

Problems when Projection Starts

<ul style="list-style-type: none"> • The projector does not turn on 	 p.199
---	---

Other Problems

<ul style="list-style-type: none"> • No sound can be heard or the sound is faint 	 p.200
--	---

<ul style="list-style-type: none"> • The remote control does not work 	 p.201
<ul style="list-style-type: none"> • Nothing appears on the external monitor 	 p.202
<ul style="list-style-type: none"> • I want to change the language for messages and menus 	 p.202
<ul style="list-style-type: none"> • Email is not received even if a problem occurs in the projector 	 p.202
<ul style="list-style-type: none"> • "The battery that saves your clock settings is running low." is displayed 	 p.203
<ul style="list-style-type: none"> • "The projector did not turn off correctly. An instantaneous voltage drop may have occurred." is displayed 	 p.203
<ul style="list-style-type: none"> • Detailed logs and error message are not displayed 	 p.203

Problems Relating to Images

No images appear

Check	Remedy
Did you press the [ⓘ] button on the remote control or control panel?	Press the [ⓘ] button to turn on the power.
Are the indicators switched off?	The power cord is not connected correctly or power is not being supplied. Connect the projector's power cord correctly. Check that your electrical outlet or power source is functioning correctly.
Is A/V Mute active?	Press the [A/V Mute] button to release A/V Mute. ☛ "Hiding the Image and Sound Temporarily (A/V Mute)" p.110
Are the Configuration menu settings correct?	Reset all of the settings. ☛ Reset - Reset All Config p.167
Is the image to be projected completely black? (Only when projecting computer images)	Some input images, such as screen savers, may be completely black.
Is Windows Media Center displayed in full screen? (Only during network connection)	When Windows Media Center is displayed at full screen, you cannot project using a network connection. Reduce the screen size.
Is an application using the Windows DirectX function displayed? (Only during network connection)	Applications using the Windows DirectX function may not display images correctly.
Are you using any other image display equipment with the projector?	Other image display equipment may have a different resolution. Change the EDID setting from the Signal menu. Disconnect the cable for the image currently being projected from the projector, and then make settings. If the settings are made while the cable is connected, the settings are not applied and the image is not displayed correctly. If the cable was connected when you made the settings, disconnect the cable, and then make EDID settings again. Also, make sure you restart the projector after making EDID settings. You can return settings to their initial values using the [Default] button on the remote control. The default value for WUXGA projectors is 1920x1200/60Hz , and the default value for SXGA+ projectors is 1400x1050/60Hz . ☛ Signal - Advanced - EDID p.146

Moving images are not displayed

Check	Remedy
Is the computer's image signal being output to the LCD and the monitor? (Only when projecting images from a laptop computer or a computer with a built-in LCD screen)	Change the image signal from the computer to external output only. Check your computer's documentation, or contact the computer's manufacturer.
Are the contents of the moving image you are trying to project copyright protected?	The projector may not be able to project copyright protected moving images that are being played back on a computer. For more details, see the user's guide supplied with the player.

Projection stops automatically

Check	Remedy
Is Sleep Mode set to On ?	Press the [ⓘ] button to turn on the power. If you do not want to use Sleep Mode, change the setting to Off . ☛ Extended - Operation - Sleep Mode p.150

"The EDID is not set." is displayed

Check	Remedy
Is the EDID set correctly?	Disconnect the cable for the image currently being projected from the projector, and then make EDID settings again. Also, make sure you restart the projector after making EDID settings. ☛ Signal - Advanced - EDID p.146

"Not supported." is displayed

Check	Remedy
Do the image signal resolution and the refresh rate correspond to the mode? (Only when projecting computer images)	Refer to the computer's documentation for how to change the image signal resolution and the refresh rate output from the computer. ☛ "Supported Monitor Displays" p.266

"No Signal." is displayed

Check	Remedy
Are the cables connected correctly?	Check that all the cables required for projection are securely connected. Check that no cables are disconnected and that there are no poor contacts in the cables.
Is the correct port selected?	Change the image by pressing the [Search] button. ☛ "Automatically Detecting Input Signals and Changing the Projected Image (Source Search)" p.62
Is the power for the computer or video source turned on?	Turn the power on for the equipment.
Are the image signals being output to the projector? (Only when projecting images from a laptop computer or a computer with a built-in LCD screen)	If the image signals are only being output to the computer's LCD monitor or to the accessory monitor, you need to change the output to an external destination as well as the computer's own monitor. For some computer models, when the image signals are output externally, they no longer appear on the LCD monitor or accessory monitor. If the connection is made while the power of the projector or computer is already turned on, the Fn key (Function key) that changes the computer's image signal to external output may not work. Turn the power for the computer and the projector off and then back on again. ☛ Computer's documentation

Images are fuzzy, out of focus, or distorted

Check	Remedy
Is the focus adjusted correctly?	Make sure that at least 20 minutes has passed after the projection starts, and press the [Focus] button on the remote control to adjust the focus. ☛ "Correcting the Focus" p.39
Is the projector at the correct distance?	Is it projecting outside of the recommended projection distance range? Setup within the recommended range. ☛ "Screen Size and Projection Distance" p.241
Has condensation formed on the lens?	If the projector is suddenly taken from a cold environment to a warm environment, or if sudden ambient temperature changes occur, condensation may form on the surface of the lens, and this may cause the images to appear fuzzy. Set the projector up in the room about one hour before it is used. If condensation forms on the lens, turn the projector off and wait for the condensation to disappear.

Interference or distortion appear in images

Check	Remedy
Are the cables connected correctly?	Check that all the cables required for projection are securely connected. ☛ "Connecting Equipment" p.48
Is an extension cable being used?	If an extension cable is used, electrical interference may affect the signals.
Is the correct resolution selected? (Only when projecting computer images)	Set the computer so that the signals being output are compatible with the projector. ☛ "Supported Monitor Displays" p.266 ☛ Computer's documentation
Are the Sync and Tracking settings adjusted correctly? (Only when projecting computer images)	Press the [Auto] button on the Remote Control or the [↵] button on the Control panel to perform automatic adjustment. If the images are not adjusted correctly even after performing automatic adjustment, you can also make adjustments from the Configuration menu. ☛ Signal - Tracking, Sync p.146
Is the Resolution set to anything other than Auto ? (Only when projecting on a split screen)	The image may be collapsed if the Resolution on the Configuration menu and the resolution of the projected image are not the same. If the image is collapsed, set the Resolution to Auto . ☛ Signal - Resolution p.146

The image is truncated (large) or small, the aspect is not suitable, or the image has been reversed

Check	Remedy
Have the Screen been set correctly?	Make the appropriate Screen for the screen being used. ☛ "Screen Settings" p.31
Is the aspect adjusted correctly?	Press the [Aspect] button to select an aspect suitable for the input source. ☛ "Changing the Aspect Ratio of the Projected Image" p.81
Is a wide panel computer image being projected? (Only when projecting computer images)	Change the setting according to the signal for the connected equipment. ☛ Signal - Resolution p.146
Is the image still being enlarged by E-Zoom?	Press the [Esc] button on the remote control to cancel E-Zoom. ☛ "Enlarging Part of the Image (E-Zoom)" p.112
Is Scale turned on?	Set Scale to Off on the configuration menu. ☛ Signal - Scale p.146

Check	Remedy
Is the display range restricted by Blanking ?	Appropriately set Blanking in the configuration menu. ☛ Signal - Blanking p.146
Is the image position adjusted correctly?	(Only when projecting analog RGB signals input from the Computer port) Press the [Auto] button on the remote control or the [↵] button on the control panel to adjust the position. You can also adjust the position from the Configuration menu. ☛ Signal - Position p.146
Is the computer set for dual display? (Only when projecting computer images)	If dual display is activated in the Display Properties of the computer's Control Panel, only about half of the image on the computer screen is projected. To display the entire image on the computer screen, turn off the dual display setting. ☛ Computer video driver documentation
Is the correct resolution selected? (Only when projecting computer images)	Set the computer so that the signals being output are compatible with the projector. ☛ "Supported Monitor Displays" p.266 ☛ Computer's documentation
Is the image direction correct?	Make the correct settings in Projection from the Configuration menu. ☛ "Installation Settings" p.30

Image colors are not right

Check	Remedy
Do the input signal settings match the signals from the connected device?	Change the setting according to the signal for the connected equipment. ☛ Signal - Advanced - Input Signal p.146
Is the image brightness adjusted correctly?	Adjust the Brightness setting from the Configuration menu. ☛ Image - Brightness p.143
Are the cables connected correctly?	Check that all the cables required for projection are securely connected. Check that no cables are disconnected and that there are no poor contacts in the cables. ☛ "Connecting Equipment" p.48
Is the Contrast adjusted correctly?	Adjust the Contrast setting from the Configuration menu. ☛ Image - Contrast p.143
Is the color adjustment set correctly?	Adjust the Gamma or RGBCMY setting from the Configuration menu. ☛ Image - Advanced p.143 ☛ "Adjusting the Image" p.84

Check	Remedy
Are the color saturation and tint adjusted correctly?	Adjust the Color Saturation and Tint settings from the Configuration menu. ☛ Image - Color Saturation, Tint p.143
Is the brightness of the room appropriate?	If the room is darker than when the auto adjustment was performed, the tint of the projected images may not be displayed correctly. Make the room darker and then perform auto adjustment again. ☛ "Screen Matching" p.102 ☛ "Color Calibration" p.212

Images appear dark

Check	Remedy
Is the image brightness set correctly?	Check the Brightness and Brightness Settings values from the Configuration menu. ☛ Image - Brightness p.143 ☛ Settings - Brightness Settings p.148
Is the Contrast adjusted correctly?	Adjust the Contrast setting from the Configuration menu. ☛ Image - Contrast p.143
Is only one projector being used?	Check if the following item is set to dark. ☛ Extended - Multi-Projection - Screen Matching - Brightness Settings p.150

Automatic adjustments are not performed correctly

Check	Remedy
Have at least 20 minutes passed since the power was turned on?	Auto adjustment does not work correctly until the temperature of the projector is stable. Perform auto adjustment 20 minutes after turning on the projector or canceling A/V Mute.
Do the Lens Type and the lens being used match?	When using the following lenses, check that the Lens Type and the lens being used match. If a different lens is selected, auto adjustment does not work correctly. ELPLS04, ELPLU02, ELPLW04, ELPLM06, ELPLM07 ☛ Extended - Operation - Advanced - Lens Type p.150
Is the cover of the built-in camera clean?	Make sure that the cover of the built-in camera is clean. Clean the cover if it is dirty.
Is an analog signal being input?	When inputting an analog signal, the color and brightness of the input image changes, and the results of adjustment may not be applied correctly.

Check	Remedy
Has the image been corrected using Geometry Correction?	Auto adjustment may not work for images corrected using Geometry Correction. Set Geometry Correction to Off or reduce the correction range. ☛ Settings - Geometry Correction p.148
Is the brightness of the surroundings appropriate?	If a powerful spotlight or natural light shines into the area during auto adjustment, the brightness of the surroundings changes and auto adjustment does not operate correctly. Make sure the brightness of the surroundings does not change.
Is the blending width 15 to 45%?	If the blending width in Edge Blending is 15% or less, or 45% or more, the Screen Matching function may not operate correctly. Check the blending width. ☛ Extended - Multi-Projection - Edge Blending p.150
Is the message "An error occurred during auto adjustment." displayed?	The following items explain the error codes displayed in the message. <ul style="list-style-type: none"> • During Screen Matching: 0101 Measurement value error; 0102 Measurement failure; 0103 Switch camera failure • During Color Matching: 0201 Measurement value error; 0202 Measurement failure; 0203 Switch camera failure For more details, contact your local dealer or the nearest address provided in the Epson Projector Contact List. ☛ Epson Projector Contact List

Problems when Projection Starts

The projector does not turn on

Check	Remedy
Did you press the [①] button on the remote control or control panel?	Press the [①] button to turn on the power.
Are the indicators switched off?	The power cord is not connected correctly or power is not being supplied. Disconnect and then reconnect the power cord. Check that your electrical outlet or power source is functioning correctly.
Do the indicators turn on and off when the power cord is touched?	There is probably a poor contact in the power cable, or the power cable may be defective. Reinsert the power cable. If this does not solve the problem, stop using the projector, disconnect the power cable from the electrical outlet, and contact your local dealer or the nearest address provided in the Epson Projector Contact List. ☛ Epson Projector Contact List

Check	Remedy
Is the Control Panel Lock set to Full Lock ?	Press the [ⓘ] button on the remote control. If you do not want to use Control Panel Lock , change the setting to Off . ☛ "Control Panel Lock" p.122
Is the correct setting for the remote receiver selected?	Check the Remote Receiver from the Configuration menu. ☛ Settings - Remote Receiver p.148
Was the power cord plugged back in or was the breaker turned on immediately after direct power off?	If the operation described in the column on the left is performed when Direct Power On is set to On , the power may not turn back on. Press the [ⓘ] button to turn on the power.
Is the [ID] switch on the remote control set to On?	When the switch is set to On, you can use the remote control to operate only a projector with a matching ID. Set the [ID] switch to Off. ☛ "Setting the remote control ID" p.44

Other Problems

No sound can be heard or the sound is faint

Check	Remedy
Check that the audio/video cable is securely attached to both the projector and audio source.	Disconnect the cable from the Audio port, and then reconnect the cable.
Is the projector volume set to the minimum?	Adjust the volume so that sound can be heard. ☛ Settings - Volume p.148 ☛ "Adjusting the Volume" p.64
Is the volume for the computer or from the image source set to the minimum?	Adjust the volume so that sound can be heard.
Is A/V Mute active?	Press the [A/V Mute] button to release A/V Mute. ☛ "Hiding the Image and Sound Temporarily (A/V Mute)" p.110
Is the audio cable's specification "No resistance"?	When using a commercially available audio cable, make sure it is labeled "No resistance".
Is it connected with an HDMI cable?	If no audio is output when connecting via an HDMI cable, set the connected equipment to PCM output.
Is the correct audio input selected?	Check the Audio Settings from the configuration menu. ☛ Extended - A/V Settings - Audio Settings p.150

The remote control does not work

Check	Remedy
Is the remote control light-emitting area pointing towards the remote receiver on the projector during operation?	Point the remote control towards the remote receiver. ☛ "Remote control operating range" p.25
Is the remote control too far from the projector?	Check the operating range. ☛ "Remote control operating range" p.25
Is direct sunlight or strong light from fluorescent lamps shining onto the remote receiver?	Set the projector up in a location where strong light does not shine onto the remote receiver.
Is the correct setting for the Remote Receiver selected?	Check the Remote Receiver from the Configuration menu. ☛ Settings - Remote Receiver p.148
Are the batteries dead or have the batteries been inserted correctly?	Make sure the batteries are inserted correctly or replace the batteries with new ones if necessary. ☛ "Replacing the remote control batteries" p.24
Are the remote control ID and the projector ID matched?	Make sure the ID for the projector you want to operate and the ID for the remote control match. To operate all projectors by remote control regardless of the ID setting, set the [ID] switch on the remote control to Off. ☛ "ID Settings" p.43
Does Remote Control Type match the remote control that you are using?	Check the Remote Control Type on the configuration menu. ☛ Extended - Operation - Advanced - Remote Control Type p.150
Is the optional remote control cable connected to the projector's Remote port?	When the remote control cable is connected, the projector's remote receiver is disabled. When not using the remote control cable set, disconnect it from the Remote port.
Is Control Communications or Extron XTP set to On ?	The Remote port is disabled. When using the optional remote control cable set, set Control Communications or Extron XTP to Off . ☛ Extended - HDBaseT p.150
Is the remote control button lock set?	When the remote control button lock is set, buttons except for those needed for basic remote control operations are deactivated. Hold down the [ ☛ "Remote control button lock" p.123

Nothing appears on the external monitor

Check	Remedy
Are images input from a port other than the Computer port or BNC port?	Only RGB signals from the Computer port or the BNC port can be displayed on an external monitor.
Are you projecting a split screen?	Only RGB signals projected on the left screen from the Computer port or the BNC port can be displayed on an external monitor. ☛ "Projecting Two Images Simultaneously (Split Screen)" p.107
Is the projector in standby status?	Check that Standby Mode , A/V Output , and Monitor Out from the Configuration menu are set correctly. ☛ Extended - Standby Mode, A/V Settings p.150

I want to change the language for messages and menus

Check	Remedy
Change the Language setting.	Adjust the Language setting from the Configuration menu. ☛ Extended - Language p.150

Email is not received even if a problem occurs in the projector

Check	Remedy
Is Standby Mode set to Communication On ?	To use the Mail Notification function when the projector is in standby, set Communication On in Standby Mode from the Configuration menu. Also, change the Port according to the network environment in which it is being used. ☛ Extended - Standby Mode p.150
Is power being supplied to the projector?	Check that your electrical outlet or power source is functioning correctly.
Is the Mail Notification function set correctly in the Configuration menu?	An error notification email is sent according to the Notifications settings in the Configuration menu. Check if it is set correctly. ☛ "Notifications menu" p.162

"The battery that saves your clock settings is running low." is displayed

Check	Remedy
The internal power supply that saves your clock settings is running low.	Contact your local dealer or the nearest address provided in the Epson Projector Contact List.  Epson Projector Contact List

"The projector did not turn off correctly. An instantaneous voltage drop may have occurred." is displayed





Check	Remedy
Is direct shutdown enabled or did the voltage drop due to a sudden blackout?	Check the detailed logs in status information.  "Reading the Status Display" p.184

Detailed logs and error message are not displayed

Check	Remedy
Depending on the environment, errors and warnings may not be displayed when turning on the projector after a sudden voltage drop, blackout, or power cut.	Wait for at least 10 seconds after turning off the projector using the power button or pulling the plug out of the outlet before turning the projector back on or re-inserting the plug in the outlet. When the projector turns on, check the status information.

Check the numbers and then apply the following countermeasures. If you cannot resolve the problem, contact your network administrator, or contact your local dealer or the nearest address provided in the Epson Projector Contact List.

 [Epson Projector Contact List](#)

Event ID	Cause	Remedy
0432 0435	Failed to start the network software.	Restart the projector.
0434 0481 0482 0485	Network communication is unstable.	Check the network communication status, and reconnect after waiting for a while.
0433	Cannot play transferred images.	Restart the network software.
0484	Communication was disconnected from the computer.	
0483 04FE	The network software ended unexpectedly.	Check the status of network communications. Restart the projector.
0479 04FF	A system error occurred in the projector.	Restart the projector.
0891	Cannot find an access point with the same SSID.	Set the computer, the access point, and the projector to the same SSID.
0892	The WPA/WPA2 authentication type does not match.	Check that the wireless LAN security settings are correct.
0893	The TKIP/AES encryption types do not match.	 Network - Wireless LAN p.158
0894	Communication was disconnected because the projector connected to an unauthorized access point.	Contact your network administrator for more information.
0898	Failed to acquire DHCP.	Check that the DHCP server is operating correctly. If you are not using DHCP, turn off the DHCP setting.  Network - Wireless LAN p.158 , Wired LAN p.162
0899	Other communication errors	If restarting the projector or network software does not solve the problem, contact your local dealer or the nearest address provided in the Epson Projector Contact List.  Epson Projector Contact List
089A	The EAP authentication type is not the same.	Check that the wireless LAN security settings are correct. Also, check if the certificate is installed correctly.  Network - Wireless LAN p.158
089B	EAP server authentication failed.	
089C	EAP client authentication failed.	



Event ID	Cause	Remedy
089D	Key exchange failed.	
0920	The internal power supply that saves your clock settings is running low.	Contact your local dealer or the nearest address provided in the Epson Projector Contact List.  Epson Projector Contact List



Maintenance

This chapter provides information on maintenance procedures to ensure the best level of performance from the projector for a long time to come.

You should clean the projector if it becomes dirty or if the quality of projected images starts to deteriorate.



Caution

When cleaning, unplug the power cable from the electric outlet. Otherwise, it could cause an electric shock.

Cleaning the Projector's Surface

Clean the projector's surface by wiping it gently with a soft cloth.

If the projector is particularly dirty, moisten the cloth with water containing a small amount of neutral detergent, and then firmly wring the cloth dry before using it to wipe the projector's surface.

Attention

Do not use volatile substances such as wax, alcohol, or thinner to clean the projector's surface. The quality of the case may change or become discolored.

Cleaning the Lens

Use a commercially available cloth for cleaning glasses to gently wipe the lens.



Warning

Do not use sprays that contain flammable gas to remove dust and lint from the lens. The projector may catch fire due to the high internal temperature.

Attention

Do not rub the lens with harsh materials or subject the lens to shocks, as it can easily become damaged.

Cleaning the Air Filter

When the following message is displayed and the filter indicator flashes orange, clean the air filter and the air intake vent.

"Time to clean the air filter. Clean or replace the air filter."

"The projector is overheating. Make sure nothing is blocking the air vent, and clean or replace the air filter."

"The air filter is clogged. Clean or replace the air filter."

Attention

- If dust collects on the air filter, it can cause the internal temperature of the projector to rise, and this can lead to problems with operation and shorten the optical engine's service life. Clean the air filter immediately when the message is displayed.
- Do not rinse the air filter in water. Do not use detergents or solvents.
- When using a brush for cleaning, use one with long soft bristles, and brush it lightly. If it is brushed too strongly, dust will be ground into the air filter and cannot be removed.

Cleaning the air filter

The air filter can be replaced even when the projector is suspended from a ceiling.



After you turn off the projector's power and the confirmation buzzer beeps, disconnect the power cord.

- 2** Remove the air filter cover.
Grip the air filter cover tab between your fingers, and pull up and remove the cover while pressing the tab.

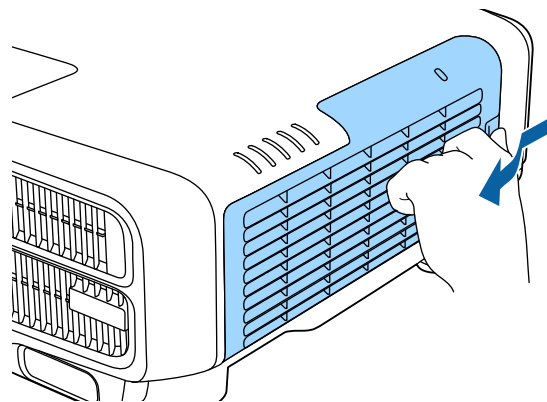

- 3** Remove the air filter.
Grip the tab of the air filter, and pull it straight out.

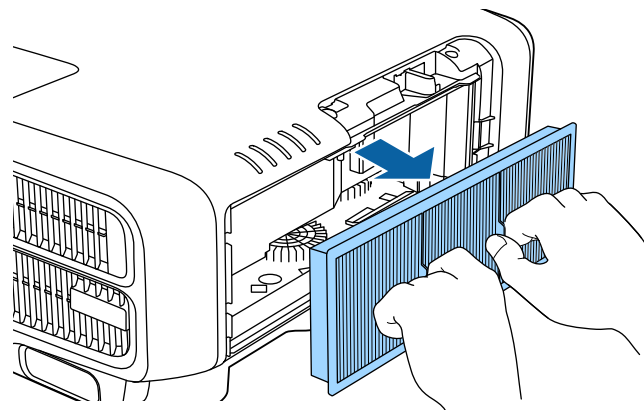

- 4** With the front (the side with tabs) of the air filter facing down, tap the air filter four or five times to shake off the dust.
Turn it over and tap the other side in the same way.

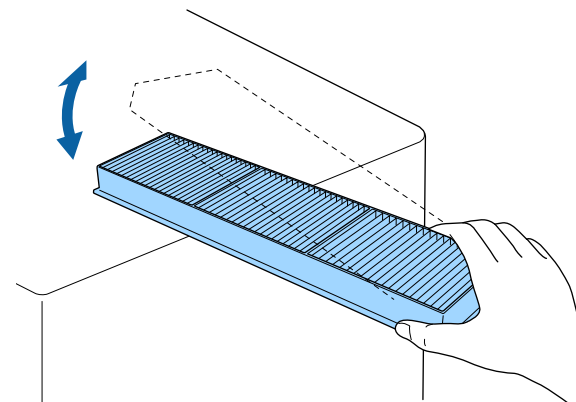

Attention

If the air filter is hit too hard, it may become unusable due to deformities and cracks.

- 5** Remove any dust remaining on the air filter by using a vacuum cleaner from the front side.

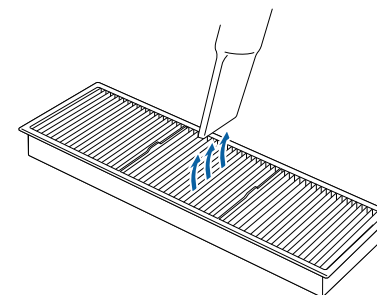

- 6** Replace the air filter.
Press until it clicks into place.

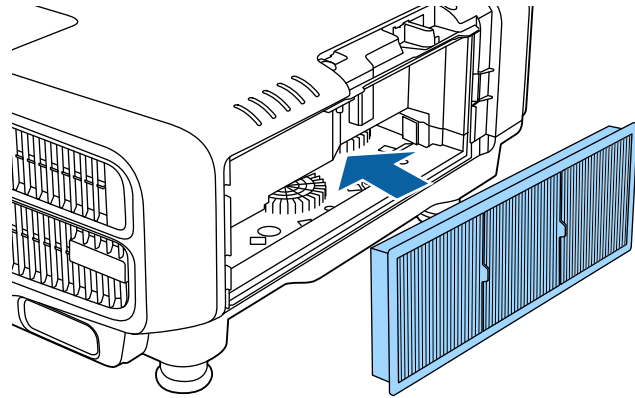

7 Attach the air filter cover.

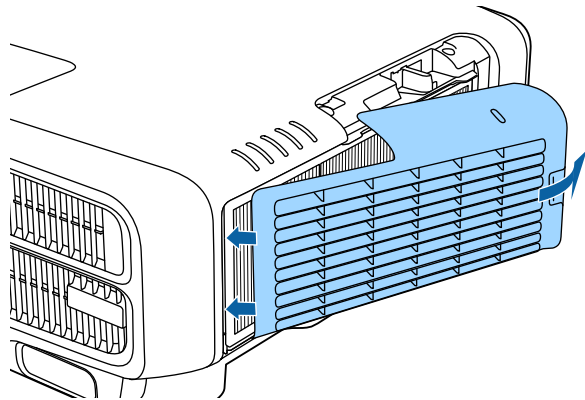

- If a message is frequently displayed, even after cleaning, it is time to replace the air filter. Replace it with a new air filter.
 - ☛ "Replacing the Air Filter" [p.210](#)
- It is recommended that you clean the air filter every 20,000 hours. Clean it more often than this if using the projector in a particularly dusty environment.
- The indicators or messages regarding Air Filter Notice are displayed only when **Air Filter Notice** is set to **On** from the Configuration menu.
 - ☛ **Extended - Display - Air Filter Notice** [p.150](#)

This section explains how to replace the air filter.

Replacing the Air Filter

Air filter replacement period

If the message is displayed frequently even though the air filter has been cleaned, replace the air filter.

How to replace the air filter

The air filter can be replaced even when the projector is suspended from a ceiling.

1 After you turn off the projector's power and the confirmation buzzer beeps, disconnect the power cord.

2 Remove the air filter cover.
Grip the air filter cover tab between your fingers, and pull up and remove the cover while pressing the tab.

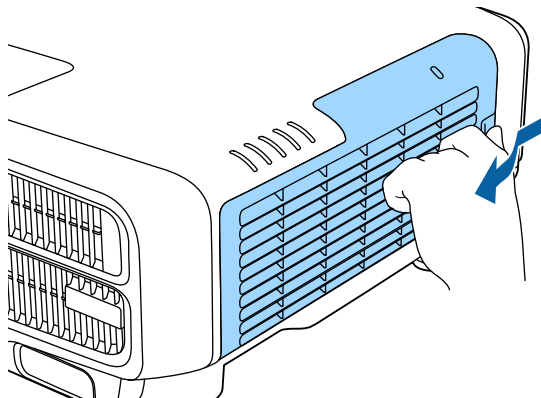

3 Remove the air filter.
Grip the tab of the air filter, and pull it straight out.

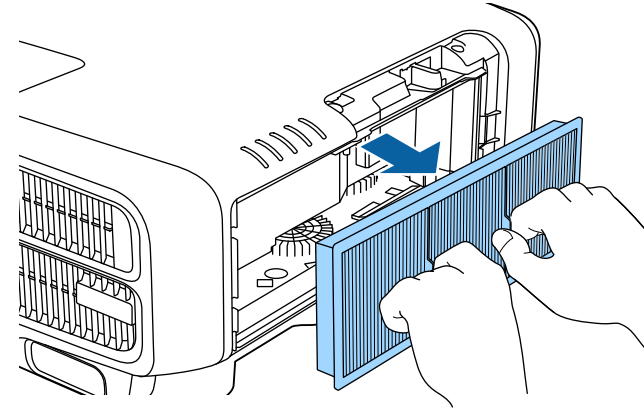

4 Install the new air filter.
Press until it clicks into place.

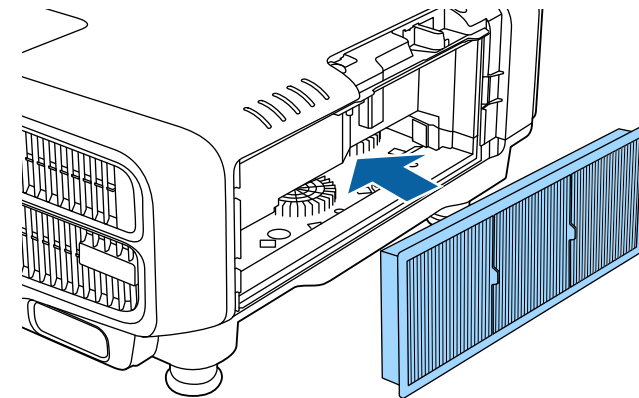

5 Attach the air filter cover.

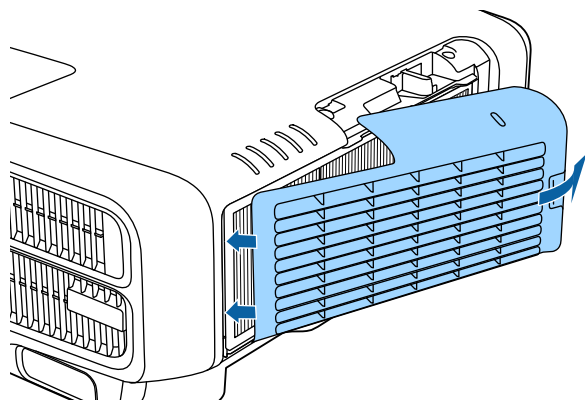

Dispose of used air filters properly in accordance with your local regulations.

Material of the frame part: Polypropylene

Material of the filter part: Polypropylene

Color Calibration

Automatically adjusts aging deterioration of the color tone for the whole screen based on the default color settings.

Operating conditions for auto adjustment functions

The auto adjustment function for Color Calibration works under the following conditions:

- The screen surface is flat and not skewed or warped
- Using a matte white diffusion screen
- The projection size is 80 to 200 inches
- The projector is setup parallel to the projection surface



- Auto adjustment is not available when using the following lenses. ELPLX02, ELPLR04, ELPLL08, ELPLL07
- After auto adjustment, the movement range for lens shift is reduced for some lenses.
 - ☞ "Adjusting the Position of the Projected Image (Lens Shift)" p.34
- We recommend performing Color Calibration 20 minutes after turning on the projector or canceling A/V mute.
- To increase the accuracy of adjustments, we recommend darkening the room while projecting images and then making adjustments.
- Auto adjustment is performed using the camera built into the front of the projector. Do not block the camera or the projected images.
- Auto adjustment takes approximately one minute and 30 seconds.
- After making automatic adjustments, Color Uniformity and Color Matching are returned to their defaults.
- By using the scheduling function, you can automatically adjust the color for the whole screen at the time you set.
 - ☞ "Scheduling Function" p.116
- See the following if Color Calibration does not work correctly.
 - ☞ "Automatic adjustments are not performed correctly" p.198

- 1 Press the [Menu] button while projecting.
- 2 Select **Color Calibration** from **Extended**.
- 3 Select **Start Auto Adjustment**, and then press the [↵] button.

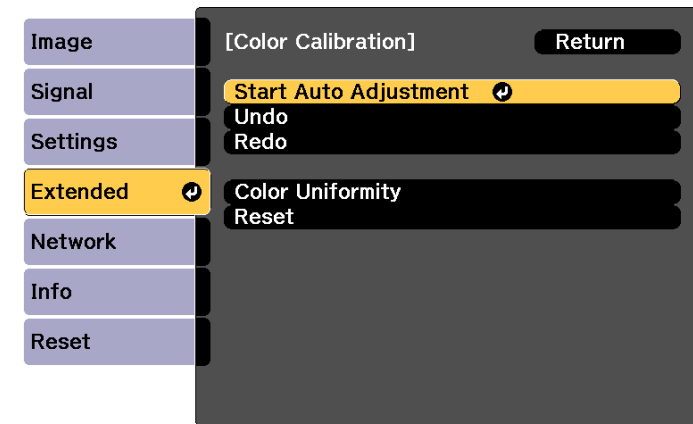

[Esc]:Return [◆]:Select [⏎]:Enter [Menu]:Exit

The adjustment pattern is displayed, and adjustment starts. If the projected image is displayed before the adjusting, the procedure is complete.



- See the following if an error occurs.
 - ☞ "Automatic adjustments are not performed correctly" p.198
- To return to the status before auto adjustment, select **Undo**. When you select **Redo** after selecting **Undo**, it returns the image to the status after auto adjustment.
- To return **Color Calibration** adjustment value to its default value, select **Reset**.

Panel Alignment

Adjusts the pixel color shift for the LCD panel. You can adjust the pixels horizontally and vertically by 0.25 pixel within a range of ± 1 pixel.



- Image quality may decline after performing LCD alignment.
- Images for pixels that extend beyond the edge of the projected screen are not displayed.

- 1 Press the [Menu] button while projecting.
- 2 Select **Display** from **Extended**.
- 3 Select **Panel Alignment**, and then press the [\leftarrow] button.

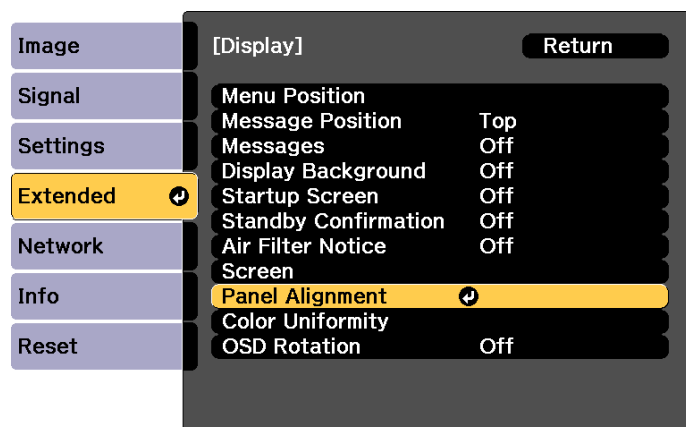

[Esc] :Return [\blacktriangleleft] :Select [\rightarrow] :Enter [Menu] :Exit

- 4 Enable **Panel Alignment**.

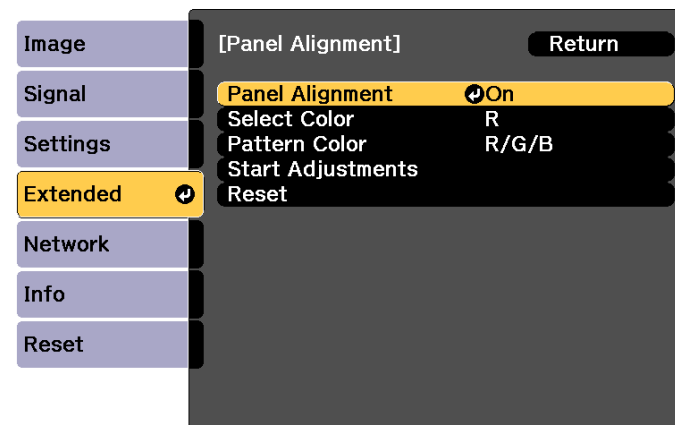

[Esc] :Return [\blacktriangleleft] :Select [\rightarrow] :Enter [Menu] :Exit

- (1) Select **Panel Alignment**, and then press the [\leftarrow] button.
- (2) Select **On**, and then press the [\leftarrow] button.
- (3) Press the [Esc] button to return to the previous screen.

- 5 Select the color you want to adjust.

- (1) Select **Select Color**, and then press the [\leftarrow] button.
- (2) Select **R** (red) or **B** (blue), and then press the [\leftarrow] button.
- (3) Press the [Esc] button to return to the previous screen.

- 6 Select the grid color displayed when making adjustments from **Pattern Color**.

- (1) Select **Pattern Color**, and then press the [\leftarrow] button.

- (2) Select a combination of R (red), G (green), and B (blue) for the grid color.
- R/G/B:** Displays a combination all three colors; red, green and blue. The actual color of the grid is white.
- R/G:** This is available when **R** is selected from **Select Color**. Displays a combination of two colors; red and green. The actual color of the grid is yellow.
- G/B:** This is available when **B** is selected from **Select Color**. Displays a combination of two colors; green and blue. The actual color of the grid is cyan.
- (3) Press the [Esc] button to return to the previous screen.

7 Select **Start Adjustments**, and then press the [] button.

First, adjust the whole LCD panel. When the start confirmation message is displayed, press the [] button to start adjustment.



The image may become distorted while adjusting. The image is restored once adjustments are complete.

8 Use the [][][][] buttons to make adjustments, and then press the [] button.

9 To perform more detailed adjustments, select **Adjust the four corners**, and then press the [] button to confirm.

10 Use the [], [], [], and [] buttons to make adjustments, and then press the [] button to move to the next adjustment point.

11 When you have adjusted all four corners, select **Exit**, and then press the [] button.

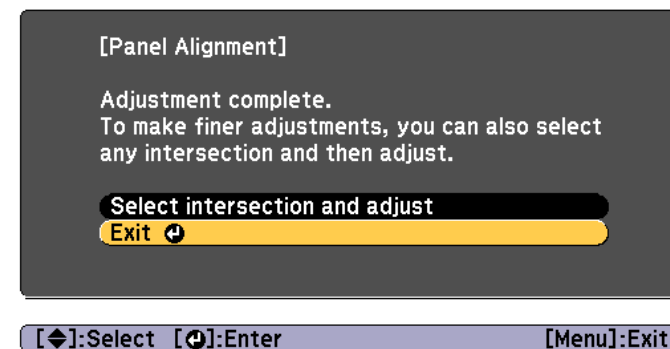

If you feel you still need to make adjustments after correcting all four points, select **Select intersection and adjust** and then continue making adjustments.

Color Uniformity

Adjusts the color tone for the whole screen.



The color tone may not be uniform even after performing color uniformity.

- 1 Press the [Menu] button while projecting.
- 2 Select **Display** from **Extended**.
- 3 Select **Color Uniformity**, and then press the [↵] button.
The following screen is displayed.

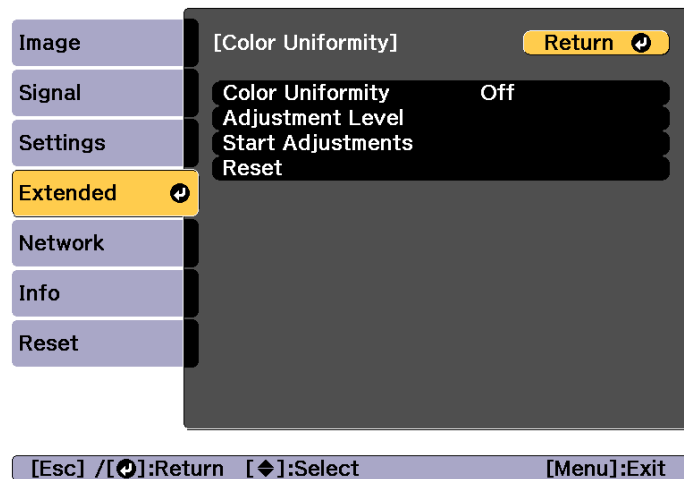

Color Uniformity: Turns color uniformity on or off.

Adjustment Level: There are eight levels from white, through gray, and up to black. You can adjust each level individually.

Start Adjustments: Starts adjusting color uniformity.

Reset: Resets all adjustments and settings for **Color Uniformity** to their default values.



The image may become distorted while adjusting **Color Uniformity**. The image is restored once adjustments are complete.

- 4 Select **Color Uniformity**, and then press the [↵] button.
- 5 Set to **On**, and then press the [Esc] button.
- 6 Select **Adjustment Level**, and then press the [↵] button.
- 7 Use the [◀][▶] buttons to set the adjustment level.
- 8 Press the [Esc] button to return to the previous screen.
- 9 Select **Start Adjustments**, and then press the [↵] button.
- 10 Select the area you want to adjust, and then press the [↵] button.
Adjust the outer areas first, and then adjust the whole screen.

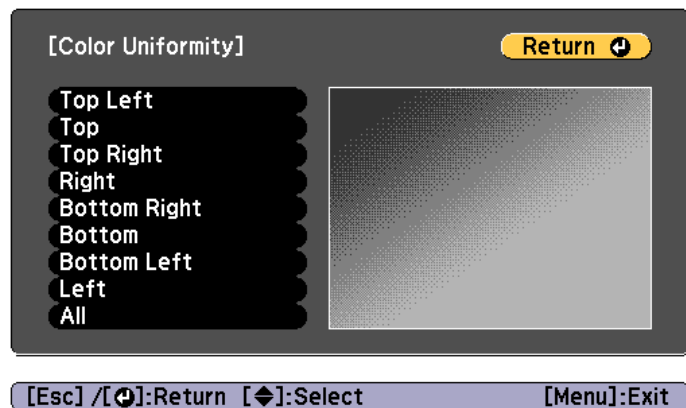

- 11** Use the [▲][▼] buttons to select the color you want to adjust, and then use the [◀][▶] buttons to adjust.

Press the [◀] button to weaken the color tone. Press the [▶] button to strengthen the color tone.

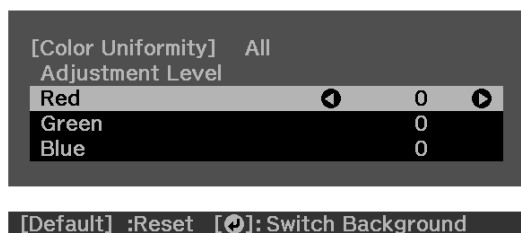

- 12** Return to step 6 and adjust each level.
- 13** To complete the adjustment, press the [Menu] button.



Appendix

Epson Projector Management

Epson Projector Management lets you carry out operations such as checking the status of multiple Epson projectors that are connected to a network at a computer monitor, and controlling the projectors from the computer.

Download the Epson Projector Management software from the following website.

<http://www.epson.com>

Changing Settings Using a Web Browser (Epson Web Control)

By using a Web browser of a computer or mobile device connected to the projector on a network, you can set functions and control the projector. This function allows you to perform setup and control operations remotely. Also, you can operate a specific projector when using multiple projectors.

Use Internet Explorer 9.0 or later or Microsoft Edge as the Web browser. Use Safari for OS X.



If you set **Standby Mode** to **Communication On**, you can use the Web browser to make settings and perform control even if the projector is in standby mode (when the power is off).

☞ **Extended - Standby Mode** [p.150](#)

Displaying the Epson Web Control Screen

Use the following procedure to display the Epson Web Control screen. Make sure your device and projector are ready for the network connection.









If your Web browser is set up to connect via a proxy server, the Epson Web Control screen cannot be displayed. To display Web Control, you need to make settings so that a proxy server is not used for a connection.

- 1** Connect your device to the same network as the connected projector.
The connection method varies depending on the device. See the manual supplied with your device for details. When using a mobile device, check the Wi-Fi settings.
- 2** Start the Web browser on your device.

- 3** Connect by entering the address of the connected projector in the URL field of the Web browser.

The Home screen is displayed.







- ① **Basic Control**
 "Basic Control Screen" [p.219](#)
- ② **OSD Control Pad**
 "OSD Control Pad Screen" [p.220](#)
- ③ **Test Pattern**
 "Test Pattern Operation Screen" [p.222](#)
- ④ **Remote Camera Access**
 "Remote Camera Access screen" [p.223](#)
- ⑤ **Advanced**
 You are moved to the Advanced screen.
- ⑥ **Status Information**
 "Status Information Screen" [p.223](#)
- ⑦ **Lens Control**
 "Lens Control Screen" [p.221](#)



- When performing the functions from the Home screen, you may be prompted to enter the user name and password. The following two types of user names and passwords are available.

Remote: The user name is "EPSONREMOTE" and the default password is "guest".

Web Control: The user name is "EPSONWEB" and the default password is "admin".

- You cannot change the user name. You can change the password in the Network menu from the Configuration menu.
 **Network - Basic - Remote Password, Web Control Password** [p.157](#)
- You must enter the user name for Web Control Password even when the password is disabled.
- You can only set the following items from the **Advanced** screen.
 Monitor Password (up to 16 single-byte alphanumeric characters)
 **Network - Basic - Monitor Password** [p.157](#)
 IPv6 Settings (Manual)
 **Network - IPv6 Settings** [p.158, p.162](#)
 Add HTTP port (for the port number used for Web control, use anything except for 80 (default), 843, 3620, 3621, 3625, 3629, 4352, 4649, 5357, 10000, 10001, 41794)
 **Network - Others** [p.164](#)

Basic Control Screen

You can perform basic projector operations.

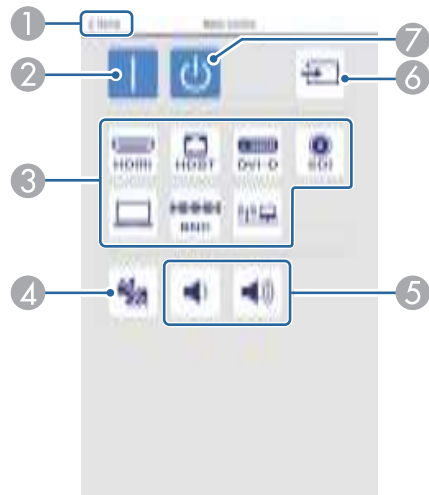

- ① Moves to the Home screen.
- ② Turns the projector on.
- ③ Switches to the target image.
- ④ Turns the video and audio on or off.
- ⑤ You can adjust the volume.
- ⑥ Automatically detects the input signal.
- ⑦ Turns the projector off.

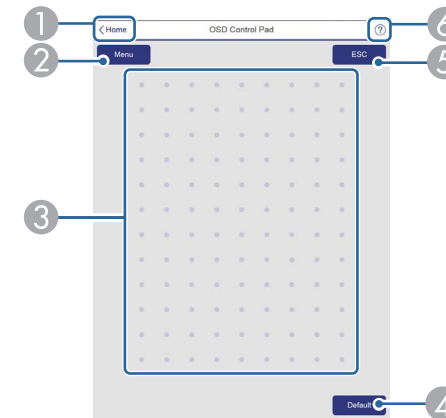

- ① Moves to the Home screen.
- ② Displays and closes the Configuration menu.
- ③ You can operate the Configuration menu using your finger or mouse. Flick to select an item, and tap to confirm the selection.
- ④ When "[Default]:Reset" is displayed on the Configuration menu guide, selecting this icon returns the settings to their default values.
- ⑤ Returns to the previous menu level in the Configuration menu.
- ⑥ Displays information on using the OSD Control Pad.

OSD Control Pad Screen

You can operate the Configuration menu of the projector.



Items in the Configuration menu that cannot be set in Epson Web Control are listed below.

- Signal menu - EDID, DDC Buffer
- Settings Menu - User Button
- Extended menu - Display - Message Position
- Extended Menu - User's Logo
- Extended menu - Operation - Advanced - BNC Sync Termination, AC Voltage Monitoring, Lens Type
- Extended menu - Operation - Lens Calibration
- Extended Menu - Language

The settings for items on each menu are the same as the projector's Configuration menu.

☛ "Configuration Menu" [p.139](#)

Lens Control Screen

You can operate the lens of the projector.

Focus/Distortion Operation Screen

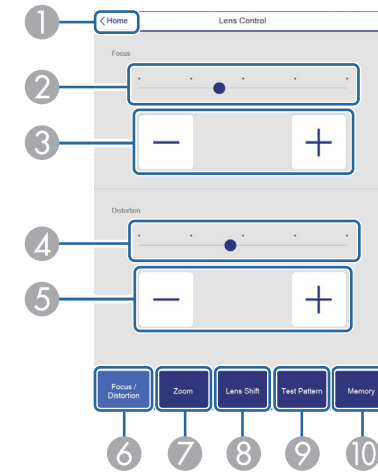

- 1 Moves to the Home screen.
- 2 Move the slider to adjust the focus.
- 3 Press the buttons to adjust the focus.
- 4 Move the slider to adjust image warping.*
- 5 Press the buttons to adjust image warping.*
- 6 Displays the Focus / Distortion operation screen.
- 7 Displays the Zoom operation screen.
- 8 Displays the Lens Shift operation screen.
- 9 Displays the Test Pattern operation screen.
- 10 Displays the Memory operation screen.

* This is not available for ELPLU02.

Zoom Operation Screen

This is not available for ELPLX02 and ELPLR04.

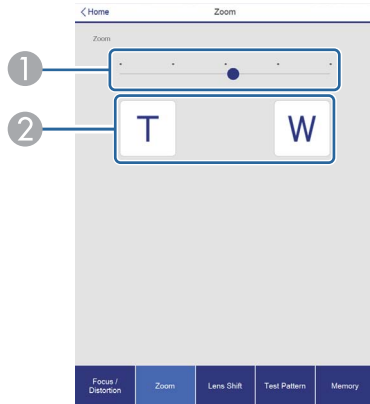

- ① Move the slider to adjust the zoom.
- ② Press the buttons to adjust the zoom.

Lens Shift Operation Screen

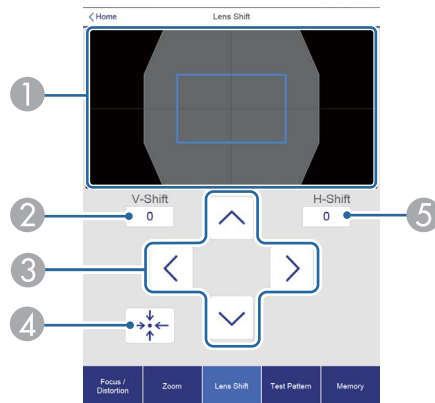

- ① Displays the position of the image as a blue square. When you move the image position, a red square is displayed at the destination.
- ② Displays the vertical image position. You can directly specify the position by tapping it and entering a number.
- ③ Moves the image position up, down, left, or right.

- ④ Moves the lens position to the home position if you press the **OK** button in the confirmation screen.
- ⑤ Displays the horizontal image position. You can directly specify the position by tapping it and entering a number.

Test Pattern Operation Screen

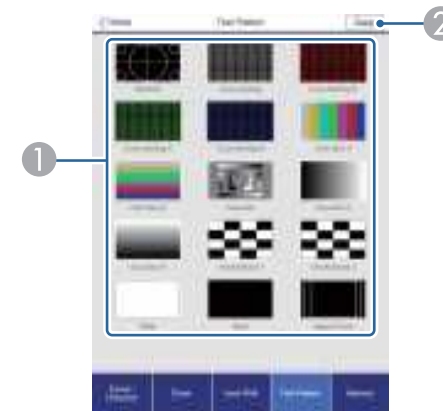

- ① Displays a test pattern.
- ② Closes the test pattern.

Memory Operation Screen

See the following for memory function details.

☞ ["Memory Function" p.114](#)

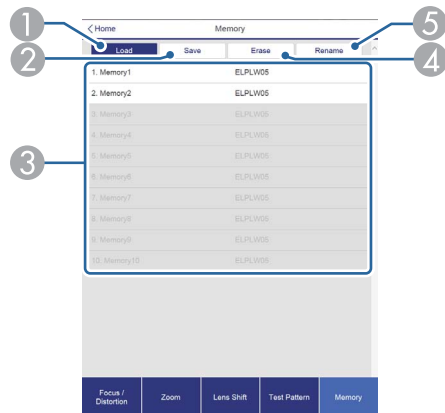

- ① Loads a memory.
- ② Saves a memory.
- ③ Displays a list of memories.
- ④ Erases a memory.
- ⑤ Changes a memory name.

Status Information Screen

You can check the projector's status. See the following for display details.

☛ "Reading the Status Display" [p.184](#)

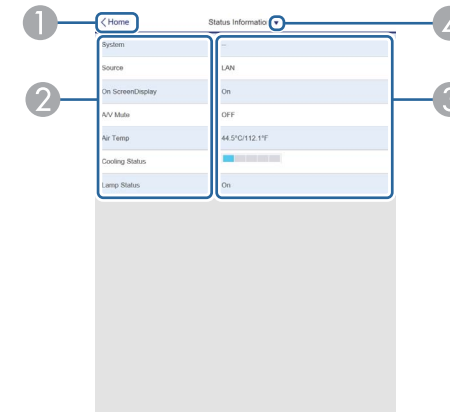

- ① Moves to the Home screen.
- ② Displays the item name.
- ③ Displays the status of each item.
- ④ Selects a category from the following.
Status Information, Source, Signal Information, Network Wired, Network Wireless, Maintenance, Version, Air Temp Info, Voltage Warning Info

Remote Camera Access screen

You can take a picture of the projected image.

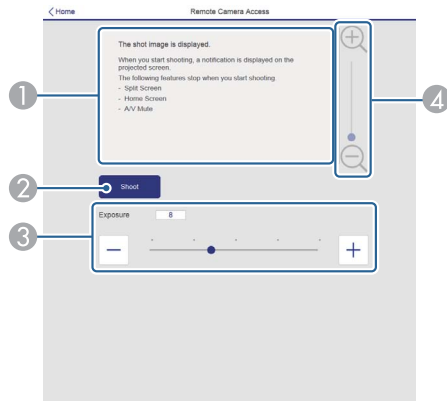

- ① Displays the image you shot.
- ② Press **Shoot** to take a picture of the projected image.
- ③ Adjusts the exposure when shooting.
- ④ Zooms in or zooms out of the image you shot.

Checking the projected image from a remote location

By shooting the projected image from a remote location, you can check it on the device you are using.



- Check that **Secure HTTP** is set to **On** from the **Network - Others** menu.
- This cannot be used when ELPLX02 is attached.
- The remote camera access function is not available when using the following functions.
 - When using the built-in camera (Tiling, Screen Matching, Color Calibration)
 - Lens Calibration
 - The Message Broadcasting feature in the Epson Projector Management software
- The following functions are canceled when using the remote camera access function.
 - Split Screen
 - A/V Mute
 - Home screen display
 - On-Screen Display (when the message is hidden)

- 1** On the **Password Protection** screen, set **Remote Camera Access** to **Off**.

☞ "Setting Password Protection" [p.120](#)

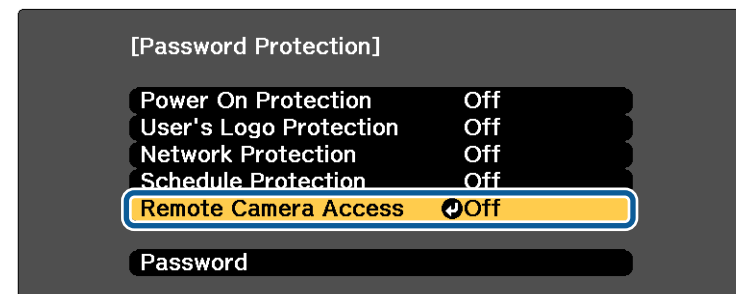

- 2** Select **Remote Camera Access** from **Network**.

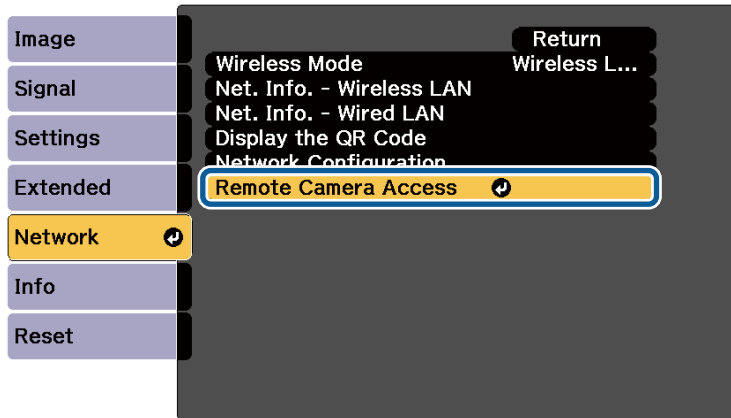

- 3** Select **Password**, and then press the [**↵**] button.

You can set up to 32 single-byte alphanumeric characters for the password (* : and spaces cannot be used).

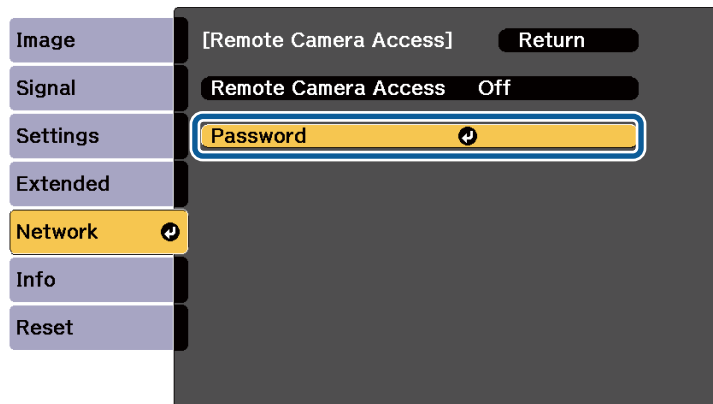

- 4** Set **Remote Camera Access** to **On**.

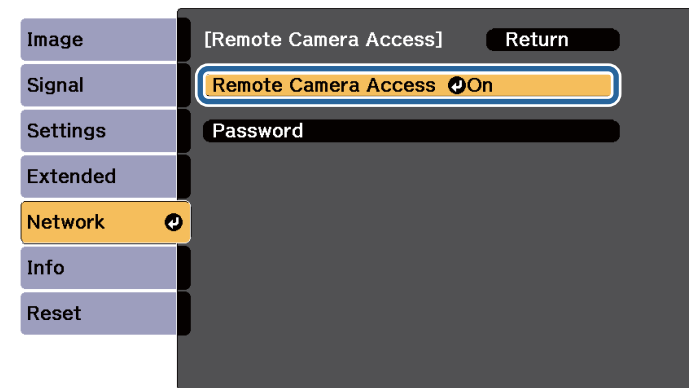

- 5** Launch the Web browser on the computer or mobile device connected to the network.

- 6** Enter the IP address of the projector in the address input box of the browser to connect to the Epson Web Control screen.

7 Select **Remote Camera Access**.

When the login screen is displayed, enter your user name and password. (The user name is EPSONWEB; the default password is admin.)

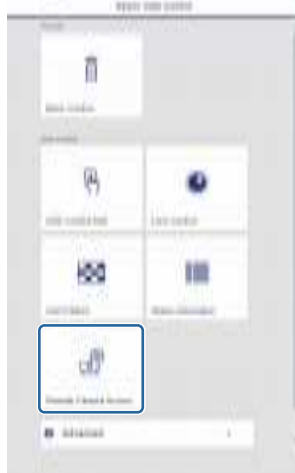

8 Press **Shoot**.

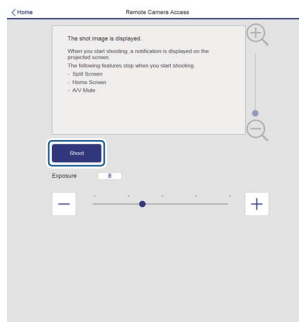

9 If the password screen is displayed, enter the password you set in step 3 for **Remote Camera Access - Password**, and then press **OK**.

A message is displayed on the projected image, and shooting starts. It takes approximately six seconds to acquire the image.



- Adjust the exposure as necessary. If you make any adjustments, shoot again and check the adjusted image.
- When shooting, you cannot perform any operations except for turning off the projector.
- You cannot shoot warning or caution messages.

Setting a certificate using a Web browser

You can use an electronic certificate as the projector's security settings.



You can install the electronic certificate from the projector's Network menu. However, be sure to register just once or the certificate may not install correctly.

☞ "Setting Up Wireless Network Security" [p.132](#)

- 1 Prepare a certificate that is supported by the projector.
- 2 Make sure the projector is turned on.
- 3 Launch the Web browser on the computer or mobile device connected to the network.

- 4** Enter the IP address of the projector in the address input box of the browser to connect to the Epson Web Control screen.

The Epson Web Control screen is displayed.



- 5** Select **Advanced**.



You need to login to display the Advanced screen. When the login screen is displayed, enter your user name and password. (User name is EPSONWEB; default password is admin.)

- 6** Select **Certificate** from **Network**.
- 7** Click the **Choose File** button, select the certificate file.
- 8** Enter the password in the **Password** box, and then click **Send**.
- 9** When the settings are complete, click the **Apply**.

Using the Mail Notification Function to Report Problems

When you set Mail Notification, notification messages are sent to the preset email addresses when a problem or warning occurs with a projector. This will enable the operator to be notified of problems with projectors even at locations away from the projectors.

☛ **Network - Notifications - Mail Notification** p.162



- Up to a maximum of three notification destinations (addresses) can be registered, and notification messages can be sent to all three destinations at once.
- If a projector develops a critical problem and suddenly stops working, it may not be able to send a message notifying an operator of the problem.
- If you set **Standby Mode** to **Communication On**, you can control the projector even if it is in standby mode (when the power is off).

☛ **Extended - Standby Mode** p.150

Reading error notification mail

When the Mail Notification function is set to On and a problem or warning occurs in the projector, the following email will be sent.

Sender: The email address set in **From**

Subject: EPSON Projector

Line 1: The projector name where the problem has occurred

Line 2: The IP address set for the projector where the problem has occurred.

Line 3 and on: Details of the problem

The details of the problem are listed line by line. The main message contents are listed below.

- Clean Air Filter
- Constant brightness expired (Constant Bright. End)
- Internal error
- Fan related error
- Sensor error
- Laser error (Laser Error/Laser Does Not Turn On)
- Laser warning
- Retardation Plate Error
- Internal temperature error
- High-speed cooling in progress
- Low Air Flow
- Low Air Flow Error
- No-signal
No Signal is input to the projector. Check the connection status or check that the power for the signal source is turned on.
- Lens shift error
- No lens

See the following to deal with problems or warnings.

☛ "Reading the Indicators" [p.178](#)

Management Using SNMP

By setting **SNMP** to **On** in the Configuration menu, notification messages are sent to the specified computer when a problem or warning occurs. This allows you to check for problems with projectors even at locations away from the projectors.

☛ **Network - Notifications - SNMP** [p.162](#)



- SNMP should be managed by a network administrator or someone who is familiar with the network.
- To use the SNMP function to monitor the projector, you need to install the SNMP manager program on your computer.
- The SNMP Agent for this projector complies with version 1 (SNMPv1).
- The managing function using SNMP cannot be used over wireless LAN in Quick connection mode.
- Up to two destination IP addresses can be saved.

ESC/VP21 Commands

You can control the projector from an external device using ESC/VP21.

Command list

When the power ON command is transmitted to the projector, the power turns on and it enters warm-up mode. When the projector's power has turned on, a colon ":" (3Ah) is returned.

When a command is input, the projector executes the command and returns a ":", and then accepts the next command.

If the command being processed terminates abnormally, an error message is output and a ":" is returned.

The main contents are listed below.

Item		Command	
Power ON/OFF	On	PWR ON	
	Off	PWR OFF	
Signal selection	Computer	Auto	SOURCE 1F
		RGB	SOURCE 11
		Component	SOURCE 14
	BNC	Auto	SOURCE BF
		RGB	SOURCE B1
		Component	SOURCE B4
	HDMI		SOURCE 30
	LAN		SOURCE 53
	SDI (EB-L1755U/EB-L1750U/EB-L1505UH/EB-L1500UH only)		SOURCE 60
	DVI-D		SOURCE A0
HDBaseT		SOURCE 80	
A/V Mute On/Off	On	MUTE ON	
	Off	MUTE OFF	

Add a Carriage Return (CR) code (0Dh) to the end of each command and transmit.

For more details, contact your local dealer or the nearest address provided in the Epson Projector Contact List.

 [Epson Projector Contact List](#)

Cable layouts

Serial connection

- Connector shape: D-Sub 9-pin (male)
- Projector input port name: RS-232C

<At the projector>

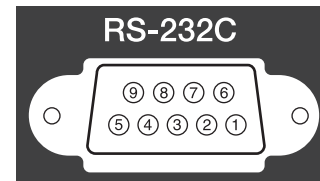

<At the computer>

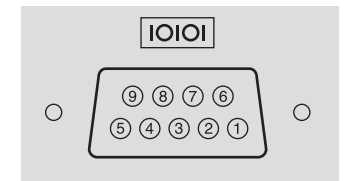

<At the projector>

(PC serial cable)

<At the computer>

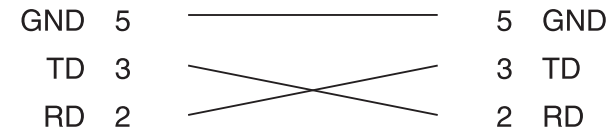

Signal Name	Function
GND	Signal wire ground
TD	Transmit data
RD	Receive data

Communications protocol

- Default baud rate setting: 9600 bps
- Data length: 8 bit

- Parity: None
- Stop-bit: 1 bit
- Flow control: None

About PJLink

PJLink was established by the JBMIA (Japan Business Machine and Information System Industries Association) as a standard protocol for controlling network-compatible projector's as part of their efforts to standardize projector control protocols.

The projector complies with the PJLink Class2 standard established by the JBMIA.

The port number used by the PJLink search function is 4352 (UDP).

You need to make network settings before you can use PJLink. See the following for more information on network settings.

☛ "Network Menu" p.155

It complies with all commands except for the following commands defined by PJLink Class2, and agreement was confirmed by the PJLink standard adaptability verification.

URL: <http://pjlink.jbmia.or.jp/english/>

• Non-compatible commands

Function		PJLink Command
Mute settings	Image muting set	AVMT 11
	Audio muting set	AVMT 21

• Input ports and corresponding input source number

Input Port Name	Input Source Number
Computer	11

Input Port Name	Input Source Number
BNC	13
DVI-D	31
HDMI	32
SDI (EB-L1755U/EB-L1750U/EB-L1505UH/EB-L1500UH only)	34
LAN	52
HDBaseT	56

- Manufacturer name displayed for "Manufacture name information query"
EPSON
- Model name displayed for "Product name information query"
EPSON L1755U/L1750U
EPSON L1505UH/L1500UH
EPSON L1715S/L1710S
EPSON L1515S/L1510S

About Crestron RoomView®

Crestron RoomView® is an integrated control system provided by Crestron®. It can be used to monitor and control multiple devices connected on a network.

The projector supports the control protocol, and can therefore be used in a system built with Crestron RoomView®.

Visit the Crestron® Web site for details on Crestron RoomView®. (Only English-language displays are supported.)

<http://www.crestron.com>

The following provides an overview of Crestron RoomView®.

- **Remote operation using a Web browser**

You can operate a projector from your computer just like using a remote control.

- **Monitoring and control with application software**

You can use Crestron RoomView® Express or Crestron RoomView® Server Edition provided by Crestron® to monitor devices in the system, to communicate with the help desk, and to send emergency messages. See the following Web site for details.

<http://www.crestron.com/getroomview>

This manual describes how to perform operations on your computer using a Web browser.



- You can only enter single-byte alphanumeric characters and symbols.
- The following functions cannot be used while using Crestron RoomView®.
 - ☛ "Changing Settings Using a Web Browser (Epson Web Control)" p.218
 - The Message Broadcasting feature in the Epson Projector Management software
- If you set **Standby Mode** to **Communication On**, you can control the projector even if it is in standby mode (when the power is off).
 - ☛ **Extended - Standby Mode** p.150

Operating a projector from your computer

Displaying the operation window

Check the following before carrying out any operations.

- Make sure the computer and projector are connected to the network.

- Set **Crestron RoomView** to **On** from the **Network** menu.

☛ **Network - Others - Crestron RoomView** p.164

- 1** Start the Web browser on the computer.
- 2** Enter the IP address of the projector in the address field of the Web browser, and press the Enter key on the keyboard.
The operation window is displayed.

Using the operation window

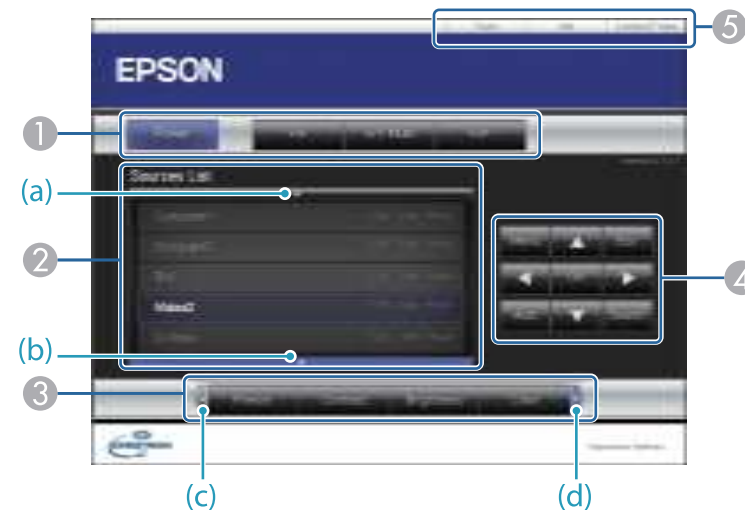



- 1** You can perform the following operations when you click the buttons.



Button	Function
Power	Turns the projector power on or off.
Vol-/Vol+	Adjusts the volume.

Button	Function
A/V Mute	Turns the video and audio on or off.  "Hiding the Image and Sound Temporarily (A/V Mute)" p.110

- Switch to the image from the selected input source. To display input sources that are not shown in Source List, click (a) or (b) to scroll up or down. The current video signal input source is displayed in blue.
You can change the source name if necessary.
- You can perform the following operations when you click the buttons. To display buttons that are not shown in Source List, click (c) or (d) to scroll left or right.

Button	Function
Freeze	Images are paused or unpaused.  "Freezing the Image (Freeze)" p.111
Contrast	Adjusts the difference between light and shade in the images.
Brightness	Adjusts the image brightness.
Color	Adjusts the color saturation for the images.
Sharpness	Adjusts the image sharpness.
Zoom	Click the [⊕] button to enlarge the image without changing the projection size. Click the [⊖] button to reduce an image that was enlarged with the [⊕] button. Click the [▲] [▼] [◀] [▶] buttons to change the position of an enlarged image.  "Enlarging Part of the Image (E-Zoom)" p.112

- The [▲] [▼] [◀] [▶] buttons perform the same operations as the [▲] [▼] [◀] [▶] buttons on the remote control. You can perform the following operations when you click the other buttons.

Button	Function
OK	Performs the same operation as the [↵] button on the remote control.  "Remote Control" p.21
Menu	Displays and closes the Configuration menu.
Auto	If clicked while projecting analog RGB signals from the Computer port, you can automatically optimize Tracking, Sync., and Position.
Search	Changes to the next input source that is sending an image.  "Automatically Detecting Input Signals and Changing the Projected Image (Source Search)" p.62
Esc	Performs the same operation as the [Esc] button on the remote control.  "Remote Control" p.21

- You can perform the following operations when you click the tabs.

Tab	Function
Contact IT Help	Displays the Help Desk window. Used to send messages to, and receive messages from, the administrator using Crestron RoomView® Express.
Info	Displays information on the projector that is currently connected.
Tools	Changes settings in the projector that is currently connected. See the next section.

Using the tools window

The following window is displayed when you click the **Tools** tab on the operation window. You can use this window to change settings in the projector that is currently connected.

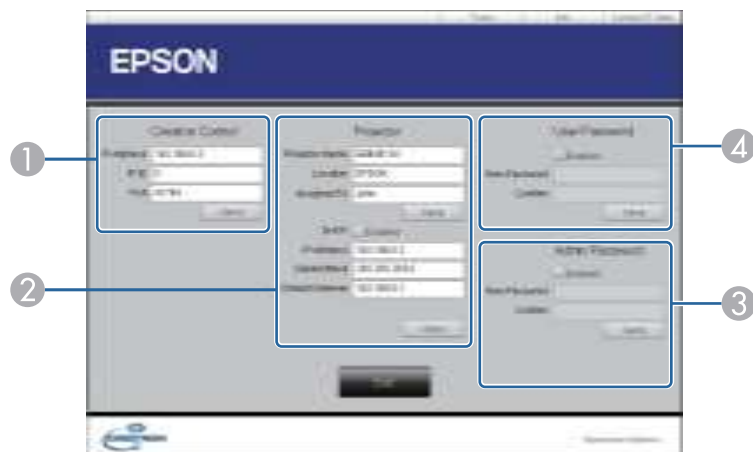

- ① **Crestron Control**
Make settings for Crestron® central controllers.
- ② **Projector**
The following items can be set.

Item	Function
Projector Name	Enter a name to differentiate the projector that is currently connected from other projectors on the network. (The name can contain up to 15 single-byte alphanumeric characters.)
Location	Enter an installation location name for the projector that is currently connected on the network. (The name can contain up to 32 single-byte alphanumeric characters and symbols.)
Assigned To	Enter a user name for the projector. (The name can contain up to 32 single-byte alphanumeric characters and symbols.)

Item	Function
DHCP	Select the Enabled check box to use DHCP. You cannot enter an IP address if DHCP is enabled.
IP Address	Enter the IP address to assign to the currently connected projector.
Subnet Mask	Enter a subnet mask for the currently connected projector.
Default Gateway	Enter the gateway address for the currently connected projector.
Send	Click this button to confirm the changes made to the Projector .

- ③ **Admin Password**
Select the **Enabled** check box to require a password to open the Tools window. The following items can be set.

Item	Function
New Password	Enter the new password when changing the password to open the Tools window. (The name can contain up to 26 single-byte alphanumeric characters.)
Confirm	Enter the same password as you entered in New Password . If the passwords are not the same, an error is displayed.
Send	Click this button to confirm the changes made to the Admin Password .

- ④ **User Password**
Select the **Enabled** check box to require a password to open the operation window on the computer. The following items can be set.

Item	Function
New Password	Enter the new password when changing the password to open the operation window. (The name can contain up to 26 single-byte alphanumeric characters.)
Confirm	Enter the same password as you entered in New Password . If the passwords are not the same, an error is displayed.
Send	Click this button to confirm the changes made to the User Password .

Art-Net

Art-Net is an Ethernet communication protocol based on the TCP/IP protocol.

You can control the projector by using a DMX controller or an application system.

Channel definitions

The following explains the channel definitions used when controlling the projector in Art-Net.

Channel	Function	Operation		Parameters	Default	Operation Content
1	Adjusting light (Dimming)	0% - 100%		0 - 255	0	Sets the image brightness.
2	Shutter control	Shutter	Open	0 - 63	128	Enables/disables A/V Mute.
		Non-operational		64 - 191		
		Shutter	Closed	192 - 255		
3	Switch source	Non-operational		0 - 7	0	Changes to the specified source.
		HDMI		8 - 15		
		Non-operational		16 - 23		
		HDBaseT		24 - 31		
		DVI-D		32 - 39		
		Non-operational		40 - 47		
		SDI		48 - 55		
		Computer		56 - 63		
		Non-operational		64 - 71		
		BNC		72 - 79		
		LAN		80 - 87		
		Non-operational		88 - 95		
Non-operational		96 - 255				

Channel	Function	Operation		Parameters	Default	Operation Content
4	Lens position	Non-operational		0 - 31	0	Moves the lens shift to the home position.
		Move to home position		32 - 63		
		Non-operational		64 - 255		
5	Horizontal lens shift	(+) lens adjustment	Movement - Large	0 - 31	128	Performs horizontal lens shift using the amount of movement specified.
			Movement - Medium	32 - 63		
			Movement - Small	64 - 95		
		Non-operational		96 - 159		
		(-) lens adjustment	Movement - Small	160 - 191		
			Movement - Medium	192 - 223		
			Movement - Large	224 - 255		
6	Vertical lens shift	(+) lens adjustment	Movement - Large	0 - 31	128	Performs vertical lens shift using the amount of movement specified.
			Movement - Medium	32 - 63		
			Movement - Small	64 - 95		
		Non-operational		96 - 159		
		(-) lens adjustment	Movement - Small	160 - 191		
			Movement - Medium	192 - 223		
			Movement - Large	224 - 255		
7	Electronic zoom	(+) lens adjustment	Movement - Large	0 - 31	128	Performs electronic zoom using the amount of movement specified.
			Movement - Medium	32 - 63		
			Movement - Small	64 - 95		
		Non-operational		96 - 159		

Channel	Function	Operation		Parameters	Default	Operation Content
		(-) lens adjustment	Movement - Small	160 - 191		
			Movement - Medium	192 - 223		
			Movement - Large	224 - 255		
8	Electronic focus	(+) lens adjustment	Movement - Large	0 - 31	128	Performs electronic focus using the amount of movement specified.
			Movement - Medium	32 - 63		
			Movement - Small	64 - 95		
		Non-operational		96 - 159		
		(-) lens adjustment	Movement - Small	160 - 191		
			Movement - Medium	192 - 223		
			Movement - Large	224 - 255		
9	Electronic distortion	(+) lens adjustment	Movement - Large	0 - 31	128	Performs electronic distortion using the amount of movement specified.
			Movement - Medium	32 - 63		
			Movement - Small	64 - 95		
		Non-operational		96 - 159		
		(-) lens adjustment	Movement - Small	160 - 191		
			Movement - Medium	192 - 223		
			Movement - Large	224 - 255		
10	Load lens memory	Non-operational		0 - 15	0	Loads the specified lens memory.
		Load lens memory 1		16 - 31		
		Load lens memory 2		32 - 47		
		Load lens memory 3		48 - 63		

Channel	Function	Operation	Parameters	Default	Operation Content
		Load lens memory 4	64 - 79		
		Load lens memory 5	80 - 95		
		Load lens memory 6	96 - 111		
		Load lens memory 7	112 - 127		
		Load lens memory 8	128 - 143		
		Load lens memory 9	144 - 159		
		Load lens memory 10	160 - 175		
		Non-operational	176 - 255		
11	Power control	Power off	0 - 63	128	Turns the projector power on or off.
		Non-operational	64 - 191		
		Power on	192 - 255		
12	Geometry correction	Off	0 - 15	255	Performs geometry correction.
		Horizontal/vertical distortion (Keystone)	16 - 31		
		Quick Corner	32 - 47		
		Point Correction	48 - 63		
		Curved Surface	64 - 79		
		Corner Wall	80 - 95		
		Load geometry correction memory 1	96 - 111		Loads a geometry correction memory.
		Load geometry correction memory 2	112 - 127		
		Load geometry correction memory 3	128 - 143		
		Non-operational	144 - 175		
13	Lock	Cannot control	0 - 127	0	Enables/disables Art-Net operations.
		Can control	128 - 255		



While controlling the projector using Art-Net and performing operations from the remote control or control panel, settings made by the DMX controller or application software may differ from the actual projector's status. When you want to apply all the channel controls to the projector, set Channel 13 to "Cannot control", then set it back to "Can control".

The following optional accessories and consumables are available. Please purchase these products as and when needed. The following list of optional accessories and consumables is current as of: August 2017. Details of accessories are subject to change without notice and availability may vary depending on the country of purchase.

Optional Accessories

Lens unit

ELPLX02, ELPLU03, ELPLU04, ELPLW05, ELPLW06, ELPLM10, ELPLM11, ELPLM15, ELPLL08

See the following for more information on the projection distance for each lens.

☛ "Screen Size and Projection Distance" [p.241](#)

Computer cable ELPKC02

(1.8 m - for mini D-Sub15-pin/mini D-Sub 15pin)

Computer cable ELPKC09

(3 m - for mini D-Sub15-pin/mini D-Sub 15pin)

Computer cable ELPKC10

(20 m - for mini D-Sub15-pin/mini D-Sub 15pin)

Component video cable ELPKC19

(3 m - for mini D-Sub 15-pin/RCA male×3)

Use to connect a [Component Video](#)  source.

Remote control cable set ELPKC28

(10 m 2 piece set)

Use this to guarantee operation from the remote control from a distance.

HDBaseT Transmitter ELPHD01

This transmitter performs long distance transmissions for HDMI signals and control signals for 1 LAN cable. Based on the [HDBaseT](#)  standard. (HDCP 2.2 is not supported.)

Wireless LAN unit ELPAP10

Use when connecting the projector to a computer wirelessly and projecting.

Polarizer ELPPL01

Use this when stacking two projectors and projecting 3D images.

Passive 3D Glasses (standard five piece set) ELPGS02A

Passive 3D Glasses (five piece set for children) ELPGS02B

Passive polarized 3D glasses. Use these when viewing 3D images with two projectors.

Document Camera ELPDC13, ELPDC21

Use when projecting images such as books, OHP documents, or slides.

Low ceiling mount* ELPMB47

High ceiling mount* ELPMB48

Use when installing the projector on a ceiling.

* Special expertise is required to suspend the projector from a ceiling. Contact your local dealer or the nearest address provided in the Epson Projector Contact List. ☛ [Epson Projector Contact List](#)

Consumables

Air Filter ELPAF51

Use as a replacement for used air filters.

Projection Distance for EB-L1755U/EB-L1750U/EB-L1505UH/EB-L1500UH

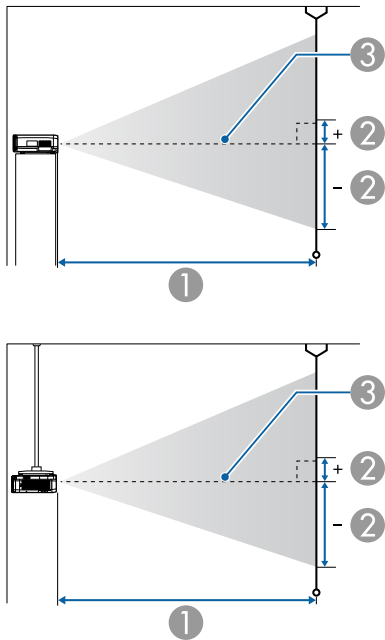

- ① Projection distance
- ② is the distance from the center of the lens to the base of the screen. This changes depending on the setting for vertical lens shift.
- ③ Center of lens

ELPLM15/ELPLM09/ELPLS04

This section shows the projection distances for models equipped with standard lenses.

Unit: cm

4:3 Screen Size		①	②
		Minimum (Wide) to Maximum (Tele)	Vertical Lens Shift Bottom to Top
60"	122x91	226 to 370	-101 to +9
80"	163x122	304 to 497	-134 to +12
100"	203x152	383 to 623	-168 to +15
120"	244x183	461 to 749	-201 to +18
150"	305x229	578 to 938	-252 to +23
200"	406x305	773 to 1253	-335 to +31
250"	508x381	969 to 1569	-419 to +38
440"	894x671	1711 to 2767	-738 to +67

Unit: cm

16:9 Screen Size		①	②
		Minimum (Wide) to Maximum (Tele)	Vertical Lens Shift Bottom to Top
60"	133x75	205 to 336	-87 to +13
80"	177x100	276 to 450	-116 to +17
100"	221x125	347 to 565	-145 to +21
120"	266x149	417 to 679	-174 to +25
150"	332x187	524 to 851	-218 to +31
200"	443x249	701 to 1137	-291 to +42
250"	553x311	879 to 1423	-363 to +52
440"	974x548	1552 to 2511	-640 to +92



Unit: cm

16:10 Screen Size		①	②
		Minimum (Wide) to Maximum (Tele)	Vertical Lens Shift Bottom to Top
60"	130x81	199 to 326	-89 to +8
80"	172x108	268 to 438	-119 to +11
100"	215x135	337 to 549	-148 to +14
120"	258x162	406 to 661	-178 to +16
150"	323x202	509 to 828	-222 to +20
200"	431x269	682 to 1106	-296 to +27
250"	538x337	855 to 1385	-370 to +34
500"	1077x673	1717 to 2777	-741 to +68

ELPLX02

See the user's guide supplied with the lens unit.

ELPLU03

Unit: cm

4:3 Screen Size		①	②
		Minimum (Wide) to Maximum (Tele)	Vertical Lens Shift Bottom to Top
80"	163x122	91 to 111	-90 to -32
100"	203x152	115 to 139	-113 to -40
120"	244x183	139 to 168	-135 to -47
150"	305x229	175 to 211	-169 to -59
200"	406x305	234 to 282	-226 to -79
250"	508x381	293 to 353	-282 to -99

4:3 Screen Size		①	②
		Minimum (Wide) to Maximum (Tele)	Vertical Lens Shift Bottom to Top
440"	894x671	519 to 624	-497 to -174

Unit: cm

16:9 Screen Size		①	②
		Minimum (Wide) to Maximum (Tele)	Vertical Lens Shift Bottom to Top
80"	177x100	83 to 100	-76 to -23
100"	221x125	104 to 126	-96 to -29
120"	266x149	126 to 152	-115 to -35
150"	332x187	158 to 191	-143 to -43
200"	443x249	212 to 256	-191 to -58
250"	553x311	266 to 320	-239 to -72
440"	974x548	471 to 566	-420 to -127

Unit: cm

16:10 Screen Size		①	②
		Minimum (Wide) to Maximum (Tele)	Vertical Lens Shift Bottom to Top
80"	172x108	80 to 97	-80 to -28
100"	215x135	101 to 123	-100 to -35
110"	237x148	112 to 135	-110 to -38
120"	258x162	122 to 148	-120 to -42
150"	323x202	154 to 186	-150 to -52
200"	431x269	206 to 249	-199 to -70
250"	538x337	259 to 312	-249 to -87
400"	862x539	416 to 500	-399 to -140



16:10 Screen Size		①	②
		Minimum (Wide) to Maximum (Tele)	Vertical Lens Shift Bottom to Top
500"	1077x673	521 to 626	-499 to -175

16:9 Screen Size		①	②
		Minimum (Wide) to Maximum (Tele)	Vertical Lens Shift Bottom to Top
200"	443x249	286 to 346	-291 to +42
250"	553x311	359 to 433	-363 to +52
440"	974x548	637 to 767	-640 to +92

ELPLU04/ELPLU02

Unit: cm

4:3 Screen Size		①	②
		Minimum (Wide) to Maximum (Tele)	Vertical Lens Shift Bottom to Top
60"	122x91	91 to 110	-101 to +9
80"	163x122	123 to 149	-134 to +12
100"	203x152	155 to 188	-168 to +15
120"	244x183	187 to 226	-201 to +18
150"	305x229	236 to 284	-252 to +23
200"	406x305	316 to 381	-335 to +31
250"	508x381	396 to 478	-419 to +38
440"	894x671	702 to 845	-738 to +67

Unit: cm

16:9 Screen Size		①	②
		Minimum (Wide) to Maximum (Tele)	Vertical Lens Shift Bottom to Top
60"	133x75	82 to 100	-87 to +13
80"	177x100	111 to 135	-116 to +17
100"	221x125	140 to 170	-145 to +21
120"	266x149	170 to 205	-174 to +25
150"	332x187	213 to 258	-218 to +31

Unit: cm

16:10 Screen Size		①	②
		Minimum (Wide) to Maximum (Tele)	Vertical Lens Shift Bottom to Top
60"	130x81	80 to 97	-89 to +8
80"	172x108	108 to 131	-119 to +11
100"	215x135	136 to 165	-148 to +14
120"	258x162	165 to 199	-178 to +16
150"	323x202	207 to 251	-222 to +20
200"	431x269	278 to 336	-296 to +27
250"	538x337	349 to 421	-370 to +34
500"	1077x673	704 to 848	-741 to +68

Unit: cm

ELPLW05

4:3 Screen Size		①	②
		Minimum (Wide) to Maximum (Tele)	Vertical Lens Shift Bottom to Top
60"	122x91	108 to 154	-68 to -24
80"	163x122	147 to 207	-90 to -32
100"	203x152	185 to 260	-113 to -40



4:3 Screen Size		①	②
		Minimum (Wide) to Maximum (Tele)	Vertical Lens Shift Bottom to Top
120"	244x183	224 to 313	-135 to -47
150"	305x229	282 to 393	-169 to -59
200"	406x305	378 to 526	-226 to -79
250"	508x381	475 to 659	-282 to -99
440"	894x671	841 to 1165	-497 to -174

Unit: cm

16:9 Screen Size		①	②
		Minimum (Wide) to Maximum (Tele)	Vertical Lens Shift Bottom to Top
60"	133x75	97 to 139	-57 to -17
80"	177x100	132 to 187	-76 to -23
100"	221x125	167 to 236	-96 to -29
120"	266x149	202 to 284	-115 to -35
150"	332x187	255 to 357	-143 to -43
200"	443x249	343 to 477	-191 to -58
250"	553x311	430 to 598	-239 to -72
440"	974x548	763 to 1057	-420 to -127

Unit: cm

16:10 Screen Size		①	②
		Minimum (Wide) to Maximum (Tele)	Vertical Lens Shift Bottom to Top
60"	130x81	94 to 135	-60 to -21
80"	172x108	129 to 182	-80 to -28
100"	215x135	163 to 229	-100 to -35

16:10 Screen Size		①	②
		Minimum (Wide) to Maximum (Tele)	Vertical Lens Shift Bottom to Top
120"	258x162	197 to 276	-120 to -42
150"	323x202	248 to 347	-150 to -52
200"	431x269	333 to 464	-199 to -70
250"	538x337	418 to 582	-249 to -87
400"	862x539	674 to 934	-399 to -140
500"	1077x673	844 to 1169	-499 to -175

ELPLW06/ELPLW04

Unit: cm

4:3 Screen Size		①	②
		Minimum (Wide) to Maximum (Tele)	Vertical Lens Shift Bottom to Top
60"	122x91	170 to 234	-101 to +9
80"	163x122	229 to 315	-134 to +12
100"	203x152	288 to 395	-168 to +15
120"	244x183	348 to 475	-201 to +18
150"	305x229	436 to 596	-252 to +23
200"	406x305	584 to 797	-335 to +31
250"	508x381	732 to 998	-419 to +38
440"	894x671	1295 to 1762	-738 to +67



Unit: cm

16:9 Screen Size		①	②
		Minimum (Wide) to Maximum (Tele)	Vertical Lens Shift Bottom to Top
60"	133x75	154 to 212	-87 to +13
80"	177x100	207 to 285	-116 to +17
100"	221x125	261 to 358	-145 to +21
120"	266x149	315 to 431	-174 to +25
150"	332x187	395 to 540	-218 to +31
200"	443x249	530 to 723	-291 to +42
250"	553x311	664 to 905	-363 to +52
440"	974x548	1175 to 1599	-640 to +92

Unit: cm

16:10 Screen Size		①	②
		Minimum (Wide) to Maximum (Tele)	Vertical Lens Shift Bottom to Top
60"	130x81	149 to 206	-89 to +8
80"	172x108	202 to 277	-119 to +11
100"	215x135	254 to 348	-148 to +14
120"	258x162	306 to 419	-178 to +16
150"	323x202	385 to 526	-222 to +20
200"	431x269	515 to 703	-296 to +27
250"	538x337	646 to 881	-370 to +34
500"	1077x673	1299 to 1769	-741 to +68

ELPLM10/ELPLM06

Unit: cm

4:3 Screen Size		①	②
		Minimum (Wide) to Maximum (Tele)	Vertical Lens Shift Bottom to Top
60"	122x91	349 to 537	-101 to +9
80"	163x122	469 to 720	-134 to +12
100"	203x152	590 to 904	-168 to +15
120"	244x183	710 to 1087	-201 to +18
150"	305x229	891 to 1362	-252 to +23
200"	406x305	1193 to 1821	-335 to +31
250"	508x381	1494 to 2279	-419 to +38
440"	894x671	2640 to 4021	-738 to +67

Unit: cm

16:9 Screen Size		①	②
		Minimum (Wide) to Maximum (Tele)	Vertical Lens Shift Bottom to Top
60"	133x75	315 to 486	-87 to +13
80"	177x100	425 to 653	-116 to +17
100"	221x125	534 to 819	-145 to +21
120"	266x149	664 to 986	-174 to +25
150"	332x187	808 to 1236	-218 to +31
200"	443x249	1082 to 1652	-291 to +42
250"	553x311	1355 to 2068	-363 to +52
440"	974x548	2395 to 3650	-640 to +92



Unit: cm

16:10 Screen Size		①	②
		Minimum (Wide) to Maximum (Tele)	Vertical Lens Shift Bottom to Top
60"	130x81	306 to 473	-89 to +8
80"	172x108	413 to 635	-119 to +11
100"	215x135	519 to 797	-148 to +14
120"	258x162	626 to 959	-178 to +16
150"	323x202	786 to 1202	-222 to +20
200"	431x269	1052 to 1607	-296 to +27
250"	538x337	1318 to 2012	-370 to +34
500"	1077x673	2650 to 4036	-741 to +68

Unit: cm

16:9 Screen Size		①	②
		Minimum (Wide) to Maximum (Tele)	Vertical Lens Shift Bottom to Top
60"	133x75	458 to 706	-87 to +13
80"	177x100	618 to 949	-116 to +17
100"	221x125	779 to 1192	-145 to +21
120"	266x149	939 to 1436	-174 to +25
150"	332x187	1180 to 1800	-218 to +31
200"	443x249	1581 to 2408	-291 to +42
250"	553x311	1983 to 3016	-363 to +52
440"	974x548	3508 to 5327	-640 to +92

ELPLM11/ELPLM07

Unit: cm

4:3 Screen Size		①	②
		Minimum (Wide) to Maximum (Tele)	Vertical Lens Shift Bottom to Top
60"	122x91	507 to 780	-101 to +9
80"	163x122	683 to 1048	-134 to +12
100"	203x152	860 to 1316	-168 to +15
120"	244x183	1037 to 1584	-201 to +18
150"	305x229	1302 to 1985	-252 to +23
200"	406x305	1744 to 2655	-335 to +31
250"	508x381	2186 to 3325	-419 to +38
440"	894x671	3866 to 5870	-738 to +67

Unit: cm

16:10 Screen Size		①	②
		Minimum (Wide) to Maximum (Tele)	Vertical Lens Shift Bottom to Top
60"	130x81	445 to 686	-89 to +8
80"	172x108	601 to 923	-119 to +11
100"	215x135	757 to 1160	-148 to +14
120"	258x162	913 to 1396	-178 to +16
150"	323x202	1147 to 1751	-222 to +20
200"	431x269	1538 to 2343	-296 to +27
250"	538x337	1928 to 2934	-370 to +34
500"	1077x673	3881 to 5892	-741 to +68



ELPLL08/ELPLL07

Unit: cm

4:3 Screen Size		①	②
		Minimum (Wide) to Maximum (Tele)	Vertical Lens Shift Bottom to Top
60"	122x91	756 to 1069	-101 to +9
80"	163x122	1019 to 1436	-134 to +12
100"	203x152	1281 to 1803	-168 to +15
120"	244x183	1544 to 2170	-201 to +18
150"	305x229	1937 to 2720	-252 to +23
200"	406x305	2594 to 3637	-335 to +31
250"	508x381	3250 to 4555	-419 to +38
440"	894x671	5744 to 8041	-738 to +67

Unit: cm

16:9 Screen Size		①	②
		Minimum (Wide) to Maximum (Tele)	Vertical Lens Shift Bottom to Top
60"	133x75	683 to 968	-87 to +13
80"	177x100	922 to 1301	-116 to +17
100"	221x125	1160 to 1634	-145 to +21
120"	266x149	1398 to 1967	-174 to +25
150"	332x187	1756 to 2467	-218 to +31
200"	443x249	2352 to 3300	-291 to +42
250"	553x311	2948 to 4132	-363 to +52
440"	974x548	5212 to 7297	-640 to +92

Unit: cm

16:10 Screen Size		①	②
		Minimum (Wide) to Maximum (Tele)	Vertical Lens Shift Bottom to Top
60"	130x81	664 to 941	-89 to +8
80"	172x108	896 to 1265	-119 to +11
100"	215x135	1128 to 1589	-148 to +14
120"	258x162	1360 to 1913	-178 to +16
150"	323x202	1708 to 2399	-222 to +20
200"	431x269	2287 to 3209	-296 to +27
250"	538x337	2867 to 4020	-370 to +34
500"	1077x673	5765 to 8071	-741 to +68

ELPLR04

Lens shift is not supported.

Unit: cm

4:3 Screen Size		①	②
60"	122x91	99	-46
80"	163x122	134	-61
100"	203x152	169	-76
120"	244x183	205	-91
150"	305x229	257	-114
200"	406x305	345	-152
250"	508x381	433	-191
440"	894x671	768	-335

Unit: cm

16:9 Screen Size		①	②
60"	133x75	89	-37
80"	177x100	121	-50
100"	221x125	153	-62
120"	266x149	185	-75
150"	332x187	233	-93
200"	443x249	313	-125
250"	553x311	393	-156
440"	974x548	697	-274

Unit: cm

16:10 Screen Size		①	②
60"	130x81	87	-40
80"	172x108	118	-54
100"	215x135	149	-67
120"	258x162	180	-81
150"	323x202	227	-101
200"	431x269	304	-135
250"	538x337	382	-168
500"	1077x673	771	-337

Projection Distance for EB-L1715S/EB-L1710S/EB-L1515S/EB-L1510S

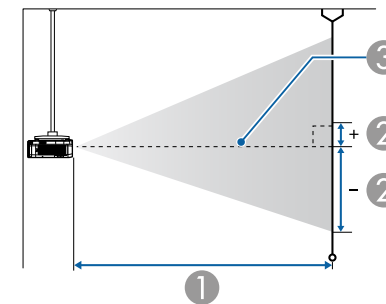
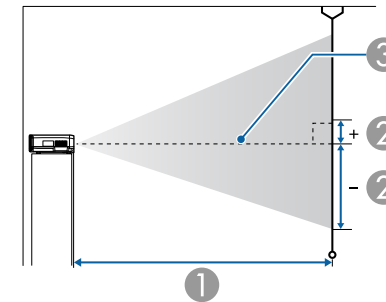

- ① Projection distance
- ② is the distance from the center of the lens to the base of the screen. This changes depending on the setting for vertical lens shift.
- ③ Center of lens

ELPLM15/ELPLM09/ELPLS04

This section shows the projection distances for models equipped with standard lenses.



Unit: cm

4:3 Screen Size		①	②
		Minimum (Wide) to Maximum (Tele)	Vertical Lens Shift Bottom to Top
60"	122x91	193 to 318	-96 to +5
80"	163x122	260 to 427	-128 to +6
100"	203x152	328 to 536	-160 to +8
120"	244x183	395 to 644	-192 to +9
150"	305x229	496 to 808	-240 to +11
180"	366x274	596 to 971	-288 to +14
200"	406x305	663 to 1079	-320 to +15
300"	610x457	999 to 1623	-480 to +23
500"	1016x762	1671 to 2710	-800 to +38

Unit: cm

16:10 Screen Size		①	②
		Minimum (Wide) to Maximum (Tele)	Vertical Lens Shift Bottom to Top
60"	129x81	205 to 338	-94 to +13
80"	172x108	277 to 453	-125 to +17
100"	215x135	348 to 568	-156 to +22
120"	258x162	419 to 684	-187 to +26
150"	323x202	526 to 856	-234 to +32
180"	388x242	633 to 1029	-281 to +39
200"	431x269	704 to 1145	-312 to +43
300"	646x404	1060 to 1721	-469 to +65
450"	969x606	1594 to 2585	-703 to +97

Unit: cm

16:9 Screen Size		①	②
		Minimum (Wide) to Maximum (Tele)	Vertical Lens Shift Bottom to Top
60"	133x75	211 to 347	-92 to +17
80"	177x100	285 to 466	-123 to +23
100"	221x125	358 to 584	-154 to +29
120"	266x149	431 to 703	-184 to +35
150"	332x187	541 to 880	-230 to +44
180"	398x224	650 to 1058	-276 to +52
200"	443x249	724 to 1177	-307 to +58
300"	664x374	1089 to 1769	-461 to +87
450"	996x560	1638 to 2658	-691 to +131

ELPLX02

See the user's guide supplied with the lens unit.

ELPLU03

Unit: cm

4:3 Screen Size		①	②
		Minimum (Wide) to Maximum (Tele)	Vertical Lens Shift Bottom to Top
80"	163x122	78 to 95	-80 to -41
100"	203x152	99 to 120	-101 to -52
120"	244x183	119 to 144	-121 to -62
150"	305x229	150 to 181	-151 to -78
180"	366x274	180 to 218	-181 to -93



4:3 Screen Size		①	②
		Minimum (Wide) to Maximum (Tele)	Vertical Lens Shift Bottom to Top
200"	406x305	201 to 242	-201 to -104
300"	610x457	302 to 365	-302 to -155
500"	1016x762	506 to 610	-503 to -259

Unit: cm

16:9 Screen Size		①	②
		Minimum (Wide) to Maximum (Tele)	Vertical Lens Shift Bottom to Top
80"	177x100	86 to 104	-71 to -29
100"	221x125	108 to 130	-89 to -36
120"	266x149	130 to 157	-107 to -43
150"	332x187	163 to 197	-133 to -54
180"	398x224	197 to 237	-160 to -64
200"	443x249	219 to 264	-178 to -71
300"	664x374	330 to 398	-267 to -107
450"	996x560	496 to 598	-400 to -161

Unit: cm

16:10 Screen Size		①	②
		Minimum (Wide) to Maximum (Tele)	Vertical Lens Shift Bottom to Top
80"	172x108	83 to 101	-75 to -33
100"	215x135	105 to 127	-93 to -41
120"	258x162	126 to 153	-112 to -50
150"	323x202	159 to 192	-140 to -62
180"	388x242	191 to 231	-168 to -75

16:10 Screen Size		①	②
		Minimum (Wide) to Maximum (Tele)	Vertical Lens Shift Bottom to Top
200"	431x269	213 to 257	-186 to -83
300"	646x404	321 to 387	-280 to -124
450"	969x606	483 to 582	-419 to -186

ELPLU04/ELPLU02

Unit: cm

4:3 Screen Size		①	②
		Minimum (Wide) to Maximum (Tele)	Vertical Lens Shift Bottom to Top
60"	122x91	78 to 95	-96 to +5
80"	163x122	105 to 128	-128 to +6
100"	203x152	132 to 161	-160 to +8
120"	244x183	160 to 194	-192 to +9
150"	305x229	201 to 244	-240 to +11
180"	366x274	242 to 294	-288 to +14
200"	406x305	270 to 327	-320 to +15
300"	610x457	407 to 493	-480 to +23
500"	1016x762	681 to 824	-800 to +38

Unit: cm

16:9 Screen Size		①	②
		Minimum (Wide) to Maximum (Tele)	Vertical Lens Shift Bottom to Top
60"	133x75	85 to 104	-92 to +17
80"	177x100	115 to 140	-123 to +23



16:9 Screen Size		①	②
		Minimum (Wide) to Maximum (Tele)	Vertical Lens Shift Bottom to Top
100"	221x125	145 to 176	-154 to +29
120"	266x149	175 to 212	-184 to +35
150"	332x187	219 to 266	-230 to +44
180"	398x224	264 to 320	-276 to +52
200"	443x249	294 to 356	-307 to +58
300"	664x374	444 to 537	-461 to +87
450"	996x560	668 to 808	-691 to +131

Unit: cm

16:10 Screen Size		①	②
		Minimum (Wide) to Maximum (Tele)	Vertical Lens Shift Bottom to Top
60"	129x81	83 to 101	-94 to +13
80"	172x108	112 to 136	-125 to +17
100"	215x135	141 to 171	-156 to +22
120"	258x162	170 to 206	-187 to +26
150"	323x202	213 to 259	-234 to +32
180"	388x242	257 to 311	-281 to +39
200"	431x269	286 to 347	-312 to +43
300"	646x404	432 to 522	-469 to +65
450"	969x606	650 to 786	-703 to +97

ELPLW05

Unit: cm

4:3 Screen Size		①	②
		Minimum (Wide) to Maximum (Tele)	Vertical Lens Shift Bottom to Top
60"	122x91	92 to 132	-60 to -31
80"	163x122	125 to 177	-80 to -41
100"	203x152	158 to 223	-101 to -52
120"	244x183	191 to 269	-121 to -62
150"	305x229	241 to 338	-151 to -78
180"	366x274	291 to 406	-181 to -93
200"	406x305	324 to 452	-201 to -104
300"	610x457	490 to 681	-302 to -155
500"	1016x762	822 to 1139	-503 to -259

Unit: cm

16:9 Screen Size		①	②
		Minimum (Wide) to Maximum (Tele)	Vertical Lens Shift Bottom to Top
60"	133x75	101 to 144	-53 to -21
80"	177x100	137 to 194	-71 to -29
100"	221x125	173 to 244	-89 to -36
120"	266x149	209 to 294	-107 to -43
150"	332x187	263 to 368	-133 to -54
180"	398x224	317 to 443	-160 to -64
200"	443x249	354 to 493	-178 to -71
300"	664x374	534 to 743	-267 to -107
450"	996x560	805 to 1117	-400 to -161



Unit: cm

16:10 Screen Size		①	②
		Minimum (Wide) to Maximum (Tele)	Vertical Lens Shift Bottom to Top
60"	129x81	98 to 140	-56 to -25
80"	172x108	133 to 188	-75 to -33
100"	215x135	168 to 237	-93 to -41
120"	258x162	203 to 285	-112 to -50
150"	323x202	256 to 358	-140 to -62
180"	388x242	309 to 431	-168 to -75
200"	431x269	344 to 480	-186 to -83
300"	646x404	520 to 722	-280 to -124
450"	969x606	783 to 1087	-419 to -186

Unit: cm

16:9 Screen Size		①	②
		Minimum (Wide) to Maximum (Tele)	Vertical Lens Shift Bottom to Top
60"	133x75	159 to 219	-92 to +17
80"	177x100	215 to 294	-123 to +23
100"	221x125	270 to 370	-154 to +29
120"	266x149	326 to 445	-184 to +35
150"	332x187	409 to 558	-230 to +44
180"	398x224	493 to 671	-276 to +52
200"	443x249	548 to 746	-307 to +58
300"	664x374	826 to 1123	-461 to +87
450"	996x560	1243 to 1688	-691 to +131

ELPLW06/ELPLW04

Unit: cm

4:3 Screen Size		①	②
		Minimum (Wide) to Maximum (Tele)	Vertical Lens Shift Bottom to Top
60"	122x91	145 to 200	-96 to +5
80"	163x122	196 to 269	-128 to +6
100"	203x152	247 to 339	-160 to +8
120"	244x183	298 to 408	-192 to +9
150"	305x229	375 to 511	-240 to +11
180"	366x274	452 to 615	-288 to +14
200"	406x305	503 to 684	-320 to +15
300"	610x457	758 to 1030	-480 to +23
500"	1016x762	1268 to 1721	-800 to +38

Unit: cm

16:10 Screen Size		①	②
		Minimum (Wide) to Maximum (Tele)	Vertical Lens Shift Bottom to Top
60"	129x81	155 to 213	-94 to +13
80"	172x108	209 to 286	-125 to +17
100"	215x135	263 to 359	-156 to +22
120"	258x162	317 to 433	-187 to +26
150"	323x202	398 to 543	-234 to +32
180"	388x242	479 to 652	-281 to +39
200"	431x269	533 to 726	-312 to +43
300"	646x404	804 to 1092	-469 to +65
450"	969x606	1210 to 1642	-703 to +97



ELPLM10/ELPLM06

Unit: cm

4:3 Screen Size		①	②
		Minimum (Wide) to Maximum (Tele)	Vertical Lens Shift Bottom to Top
60"	122x91	298 to 461	-96 to +5
80"	163x122	401 to 619	-128 to +6
100"	203x152	505 to 777	-160 to +8
120"	244x183	609 to 935	-192 to +9
150"	305x229	764 to 1172	-240 to +11
180"	366x274	919 to 1409	-288 to +14
200"	406x305	1023 to 1567	-320 to +15
300"	610x457	1541 to 2358	-480 to +23
500"	1016x762	2578 to 3938	-800 to +38

Unit: cm

16:10 Screen Size		①	②
		Minimum (Wide) to Maximum (Tele)	Vertical Lens Shift Bottom to Top
60"	129x81	316 to 490	-94 to +13
80"	172x108	426 to 657	-125 to +17
100"	215x135	536 to 825	-156 to +22
120"	258x162	646 to 992	-187 to +26
150"	323x202	811 to 1243	-234 to +32
180"	388x242	975 to 1495	-281 to +39
200"	431x269	1085 to 1662	-312 to +43
300"	646x404	1635 to 2500	-469 to +65
450"	969x606	2458 to 3757	-703 to +97

Unit: cm

16:9 Screen Size		①	②
		Minimum (Wide) to Maximum (Tele)	Vertical Lens Shift Bottom to Top
60"	133x75	325 to 503	-92 to +17
80"	177x100	438 to 676	-123 to +23
100"	221x125	551 to 848	-154 to +29
120"	266x149	664 to 1020	-184 to +35
150"	332x187	834 to 1278	-230 to +44
180"	398x224	1003 to 1537	-276 to +52
200"	443x249	1116 to 1709	-307 to +58
300"	664x374	1680 to 2570	-461 to +87
450"	996x560	2527 to 3861	-691 to +131

ELPLM11/ELPLM07

Unit: cm

4:3 Screen Size		①	②
		Minimum (Wide) to Maximum (Tele)	Vertical Lens Shift Bottom to Top
60"	122x91	431 to 668	-96 to +5
80"	163x122	583 to 899	-128 to +6
100"	203x152	735 to 1129	-160 to +8
120"	244x183	887 to 1360	-192 to +9
150"	305x229	1114 to 1706	-240 to +11
180"	366x274	1342 to 2052	-288 to +14
200"	406x305	1494 to 2283	-320 to +15
300"	610x457	2253 to 3436	-480 to +23
500"	1016x762	3771 to 5742	-800 to +38

Unit: cm

16:9 Screen Size		①	②
		Minimum (Wide) to Maximum (Tele)	Vertical Lens Shift Bottom to Top
60"	133x75	472 to 730	-92 to +17
80"	177x100	637 to 981	-123 to +23
100"	221x125	803 to 1233	-154 to +29
120"	266x149	968 to 1484	-184 to +35
150"	332x187	1216 to 1861	-230 to +44
180"	398x224	1464 to 2238	-276 to +52
200"	443x249	1630 to 2489	-307 to +58
300"	664x374	2457 to 3745	-461 to +87
450"	996x560	3697 to 5630	-691 to +131

Unit: cm

16:10 Screen Size		①	②
		Minimum (Wide) to Maximum (Tele)	Vertical Lens Shift Bottom to Top
60"	129x81	459 to 710	-94 to +13
80"	172x108	620 to 954	-125 to +17
100"	215x135	780 to 1199	-156 to +22
120"	258x162	941 to 1443	-187 to +26
150"	323x202	1183 to 1810	-234 to +32
180"	388x242	1424 to 2176	-281 to +39
200"	431x269	1585 to 2421	-312 to +43
300"	646x404	2389 to 3643	-469 to +65
450"	969x606	3596 to 5477	-703 to +97

ELPLL08/ELPLL07

Unit: cm

4:3 Screen Size		①	②
		Minimum (Wide) to Maximum (Tele)	Vertical Lens Shift Bottom to Top
60"	122x91	645 to 916	-96 to +5
80"	163x122	871 to 1232	-128 to +6
100"	203x152	1096 to 1547	-160 to +8
120"	244x183	1322 to 1863	-192 to +9
150"	305x229	1661 to 2337	-240 to +11
180"	366x274	2000 to 2811	-288 to +14
200"	406x305	2225 to 3127	-320 to +15
300"	610x457	3354 to 4706	-480 to +23
500"	1016x762	5612 to 7865	-800 to +38

Unit: cm

16:9 Screen Size		①	②
		Minimum (Wide) to Maximum (Tele)	Vertical Lens Shift Bottom to Top
60"	133x75	705 to 1001	-92 to +17
80"	177x100	951 to 1345	-123 to +23
100"	221x125	1197 to 1689	-154 to +29
120"	266x149	1443 to 2033	-184 to +35
150"	332x187	1812 to 2549	-230 to +44
180"	398x224	2181 to 3065	-276 to +52
200"	443x249	2427 to 3409	-307 to +58
300"	664x374	3657 to 5130	-461 to +87
450"	996x560	5502 to 7711	-691 to +131



Unit: cm

16:10 Screen Size		①	②
		Minimum (Wide) to Maximum (Tele)	Vertical Lens Shift Bottom to Top
60"	129x81	685 to 973	-94 to +13
80"	172x108	925 to 1307	-125 to +17
100"	215x135	1164 to 1642	-156 to +22
120"	258x162	1403 to 1977	-187 to +26
150"	323x202	1762 to 2479	-234 to +32
180"	388x242	2121 to 2982	-281 to +39
200"	431x269	2361 to 3316	-312 to +43
300"	646x404	3557 to 4991	-469 to +65
450"	969x606	5352 to 7502	-703 to +97

Unit: cm

16:9 Screen Size		①	②
60"	133x75	92	-37
80"	177x100	125	-50
100"	221x125	158	-62
120"	266x149	191	-75
150"	332x187	241	-93
180"	398x224	291	-112
200"	443x249	324	-125
300"	664x374	489	-187
450"	996x560	736	-280

Unit: cm

ELPLR04

Unit: cm

4:3 Screen Size		①	②
60"	122x91	84	-46
80"	163x122	115	-61
100"	203x152	145	-76
120"	244x183	175	-91
150"	305x229	221	-114
180"	366x274	266	-137
200"	406x305	296	-152
300"	610x457	448	-229
500"	1016x762	751	-381

16:10 Screen Size		①	②
60"	129x81	90	-40
80"	172x108	122	-54
100"	215x135	154	-67
120"	258x162	186	-81
150"	323x202	234	-101
180"	388x242	283	-121
200"	431x269	315	-135
300"	646x404	475	-202
450"	969x606	716	-303

Polarizer (ELPPL01) Installation Distance (EB-L1505UH/EB-L1500UH/EB-L1515S/EB-L1510S Only)

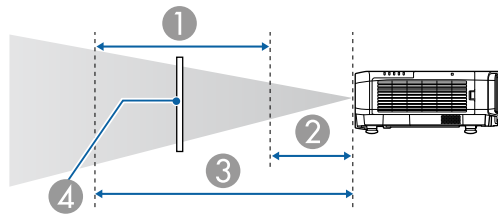

- ① Possible installation range of the polarizer
- ② Shortest distance from the projection lens to the polarizer
- ③ Longest distance from the projection lens to the polarizer
- ④ Polarizer (ELPPL01)

Units: mm

Lens type	①	
	②	③
ELPLW06/ELPLW04	90	100
ELPLM15/ELPLM09/ ELPLS04	140	150

* The guaranteed operational environmental temperature is less than 35°C.

H/V-Keystone

☛ "H/V-Keystone" p.66

Lens type	Vertical	Horizontal
ELPLM15/ELPLM09/ ELPLS04	-44° to 44°	-30° to 30°
ELPLX02	-16° to 16°	-16° to 16°
ELPLU03	-28° to 28°	-28° to 28°
ELPLU04/ELPLU02	-31° to 31°	-30° to 30°
ELPLR04	-31° to 31°	-30° to 30°
ELPLW05	-41° to 41°	-30° to 30°
ELPLW06/ELPLW04	-41° to 41°	-30° to 30°
ELPLM10/ELPLM06	-45° to 45°	-30° to 30°
ELPLM11/ELPLM07	-45° to 45°	-30° to 30°
ELPLL08/ELPLL07	-45° to 45°	-30° to 30°

Curved Surface

☛ "Curved Surface" p.68

The values in the table are the minimum values for R/L in the illustration. (Approximate value when projecting at maximum zoom. ELPLR04 does not support lens shift.)

EB-L1755U/EB-L1750U/EB-L1505UH/EB-L1500UH

Horizontally curved surface (concave)

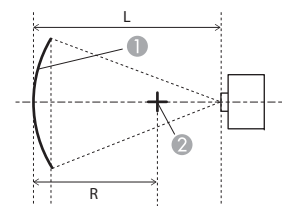

- ① Screen
- ② Center of the circle of which the curved surface is an arc
- L Projection distance
- R Radius of the circle of which the curved surface is an arc

Top view

Lens type	Vertical lens shift: Home position	Vertical lens shift: Top
	Side view	Side view
ELPLM15/ELPLM09/ ELPLS04	0.27	0.28
ELPLX02	-	2.84
ELPLU03	0.40	0.40
ELPLU04/ELPLU02	0.45	0.53
ELPLR04	0.43	-
ELPLW05	0.41	0.41
ELPLW06/ELPLW04	0.33	0.34
ELPLM10/ELPLM06	0.19	0.20
ELPLM11/ELPLM07	0.14	0.14
ELPLL08/ELPLL07	0.10	0.10

Horizontally curved surface (convex)

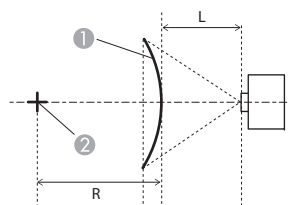

- ① Screen
- ② Center of the circle of which the curved surface is an arc
- L Projection distance
- R Radius of the circle of which the curved surface is an arc

Top view

Vertically curved surface (concave)

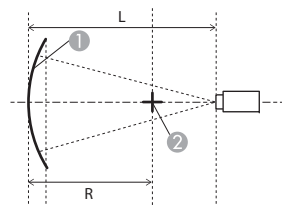

- ① Screen
- ② Center of the circle of which the curved surface is an arc
- L Projection distance
- R Radius of the circle of which the curved surface is an arc

Side view

Lens type	Vertical lens shift: Home position	Vertical lens shift: Top
ELPLM15/ELPLM09/ ELPLS04	0.52	0.54
ELPLX02	-	3.52
ELPLU03	3.52	3.52
ELPLU04/ELPLU02	2.22	2.35
ELPLR04	1.89	-
ELPLW05	1.63	1.64
ELPLW06/ELPLW04	0.79	0.82
ELPLM10/ELPLM06	0.29	0.30
ELPLM11/ELPLM07	0.18	0.19
ELPLL08/ELPLL07	0.12	0.12

Lens type	Vertical lens shift: Home position	Vertical lens shift: Top
ELPLM15/ELPLM09/ ELPLS04	0.19	0.22
ELPLX02	-	2.09
ELPLU03	0.31	0.32
ELPLU04/ELPLU02	0.37	0.63
ELPLR04	0.35	-
ELPLW05	0.33	0.35
ELPLW06/ELPLW04	0.24	0.29
ELPLM10/ELPLM06	0.13	0.15
ELPLM11/ELPLM07	0.10	0.11
ELPLL08/ELPLL07	0.08	0.08

Vertically curved surface (convex)

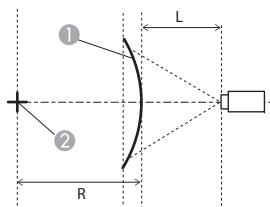

- ① Screen
- ② Center of the circle of which the curved surface is an arc
- L Projection distance
- R Radius of the circle of which the curved surface is an arc

Side view

EB-L1715S/EB-L1710S/EB-L1515S/EB-L1510S

Horizontally curved surface (concave)

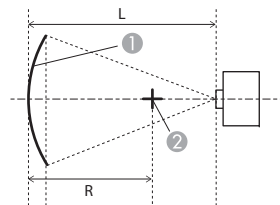

- ① Screen
- ② Center of the circle of which the curved surface is an arc
- L Projection distance
- R Radius of the circle of which the curved surface is an arc

Top view

Lens type	Vertical lens shift: Home position	Vertical lens shift: Top
ELPLM15/ELPLM09/ ELPLS04	0.28	0.33
ELPLX02	-	3.52
ELPLU03	0.87	0.92
ELPLU04/ELPLU02	1.10	1.29
ELPLR04	0.94	-
ELPLW05	0.82	0.85
ELPLW06/ELPLW04	0.41	0.48
ELPLM10/ELPLM06	0.16	0.19
ELPLM11/ELPLM07	0.11	0.12
ELPLL08/ELPLL07	0.08	0.08

Lens type	Vertical lens shift: Home position	Vertical lens shift: Top
ELPLM15/ELPLM09/ ELPLS04	0.27	0.28
ELPLX02	-	2.68
ELPLU03	0.41	0.41
ELPLU04/ELPLU02	0.46	0.66
ELPLR04	0.43	-
ELPLW05	0.41	0.41
ELPLW06/ELPLW04	0.33	0.33
ELPLM10/ELPLM06	0.19	0.20
ELPLM11/ELPLM07	0.14	0.14
ELPLL08/ELPLL07	0.10	0.10

Horizontally curved surface (convex)

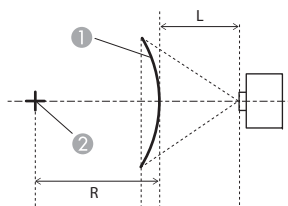

- ① Screen
- ② Center of the circle of which the curved surface is an arc
- L Projection distance
- R Radius of the circle of which the curved surface is an arc

Top view

Vertically curved surface (concave)

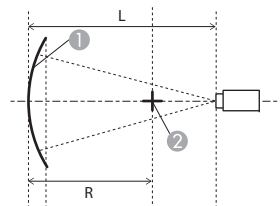

- ① Screen
- ② Center of the circle of which the curved surface is an arc
- L Projection distance
- R Radius of the circle of which the curved surface is an arc

Side view

Lens type	Vertical lens shift: Home position	Vertical lens shift: Top
ELPLM15/ELPLM09/ ELPLS04	0.52	0.54
ELPLX02	-	3.52
ELPLU03	3.52	3.52
ELPLU04/ELPLU02	2.22	2.32
ELPLR04	1.90	-
ELPLW05	1.62	1.63
ELPLW06/ELPLW04	0.79	0.81
ELPLM10/ELPLM06	0.29	0.30
ELPLM11/ELPLM07	0.19	0.19
ELPLL08/ELPLL07	0.12	0.12

Lens type	Vertical lens shift: Home position	Vertical lens shift: Top
ELPLM15/ELPLM09/ ELPLS04	0.19	0.22
ELPLX02	-	1.90
ELPLU03	0.30	0.31
ELPLU04/ELPLU02	0.37	0.55
ELPLR04	0.35	-
ELPLW05	0.33	0.34
ELPLW06/ELPLW04	0.24	0.29
ELPLM10/ELPLM06	0.13	0.15
ELPLM11/ELPLM07	0.10	0.11
ELPLL08/ELPLL07	0.07	0.08

Vertically curved surface (convex)

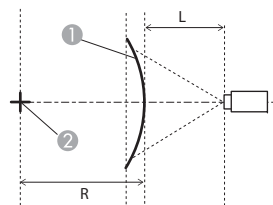

- ① Screen
 - ② Center of the circle of which the curved surface is an arc
- L Projection distance
R Radius of the circle of which the curved surface is an arc

Side view

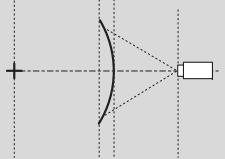
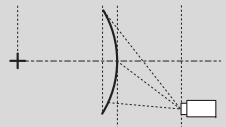
Lens type	Vertical lens shift: Home position	Vertical lens shift: Top
	 Side view	 Side view
ELPLM15/ELPLM09/ELPLS04	0.26	0.32
ELPLX02	-	3.52
ELPLU03	0.76	0.79
ELPLU04/ELPLU02	1.02	1.27
ELPLR04	0.87	-
ELPLW05	0.75	0.77
ELPLW06/ELPLW04	0.38	0.47
ELPLM10/ELPLM06	0.16	0.19
ELPLM11/ELPLM07	0.11	0.12
ELPLL08/ELPLL07	0.08	0.08

Corner Wall

☞ "Corner Wall" [p.72](#)

The α in the figure is the maximum angle in which the projector can move. See the table below for detailed values. (Approximate value when projecting at maximum zoom. ELPLR04 does not support lens shift.)

EB-L1755U/EB-L1750U/EB-L1505UH/EB-L1500UH

Concave horizontal corner correction (correction to bilateral symmetry by using corners as the center line)

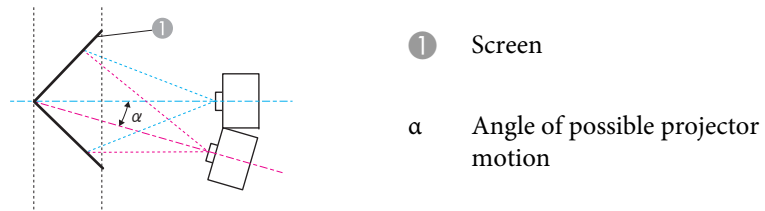

Top view

Lens type	Vertical lens shift: Home position Side view	Vertical lens shift: Top Side view
ELPLM15/ELPLM09/ ELPLS04	31°	25°
ELPLX02	-	-
ELPLU03	30°	23°
ELPLU04/ELPLU02	29°	11°
ELPLR04	30°	-
ELPLW05	30°	24°
ELPLW06/ELPLW04	32°	21°
ELPLM10/ELPLM06	30°	30°
ELPLM11/ELPLM07	29°	29°
ELPLL08/ELPLL07	29°	28°

Convex horizontal corner correction (correction to bilateral symmetry by using corners as the center line)

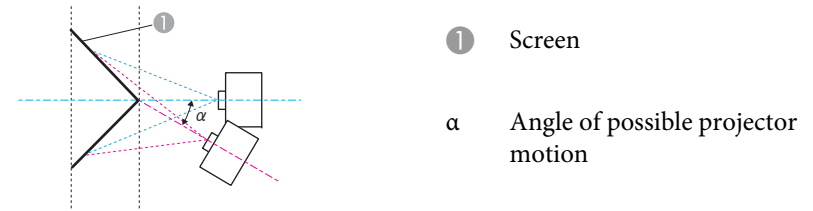

Top view

Lens type	Vertical lens shift: Home position Side view	Vertical lens shift: Top Side view
ELPLM15/ELPLM09/ ELPLS04	15°	15°
ELPLX02	-	-
ELPLU03	1°	1°
ELPLU04/ELPLU02	0°	*
ELPLR04	1°	-
ELPLW05	3°	3°
ELPLW06/ELPLW04	11°	11°
ELPLM10/ELPLM06	19°	19°
ELPLM11/ELPLM07	22°	21°
ELPLL08/ELPLL07	23°	23°

*Cannot be corrected accurately. Move the lens position to the home position.

Concave vertical corner correction (correction to horizontal symmetry by using corners as the center line)

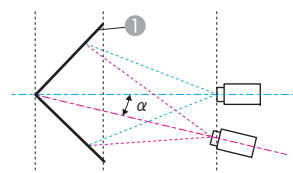

Side view

① Screen

α Angle of possible projector motion

Convex vertical corner correction (correction to horizontal symmetry by using corners as the center line)

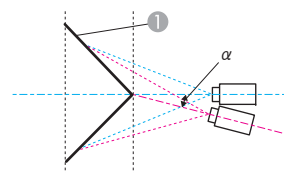

Side view

① Screen

α Angle of possible projector motion

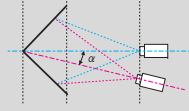
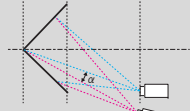
Lens type	Vertical lens shift: Home position  Side view	Vertical lens shift: Top  Side view
ELPLM15/ELPLM09/ ELPLS04	29°	14°
ELPLX02	-	-
ELPLU03	32°	20°
ELPLU04/ELPLU02	33°	2°
ELPLR04	32°	-
ELPLW05	32°	21°
ELPLW06/ELPLW04	31°	13°
ELPLM10/ELPLM06	25°	16°
ELPLM11/ELPLM07	24°	17°
ELPLL08/ELPLL07	23°	19°

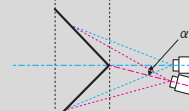
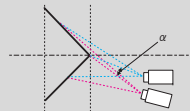
Lens type	Vertical lens shift: Home position  Side view	Vertical lens shift: Top  Side view
ELPLM15/ELPLM09/ ELPLS04	20°	8°
ELPLX02	-	-
ELPLU03	11°	2°
ELPLU04/ELPLU02	9°	:
ELPLR04	11°	-
ELPLW05	12°	3°
ELPLW06/ELPLW04	17°	3°
ELPLM10/ELPLM06	22°	13°
ELPLM11/ELPLM07	22°	16°
ELPLL08/ELPLL07	22°	17°

*Cannot be corrected accurately. Move the lens position to the home position.

EB-L1715S/EB-L1710S/EB-L1515S/EB-L1510S

Concave horizontal corner correction (correction to bilateral symmetry by using corners as the center line)

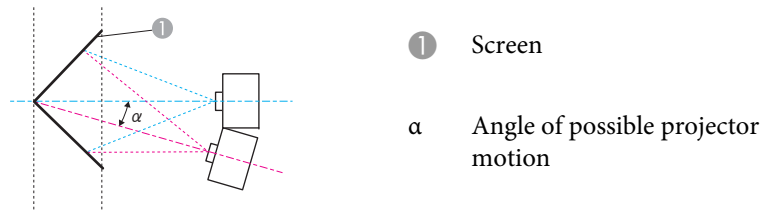

Top view

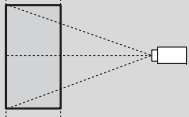
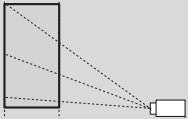
Lens type	Vertical lens shift: Home position	Vertical lens shift: Top
		
	Side view	Side view
ELPLM15/ELPLM09/ ELPLS04	31°	22°
ELPLX02	-	-
ELPLU03	26°	21°
ELPLU04/ELPLU02	25°	6°
ELPLR04	26°	-
ELPLW05	27°	22°
ELPLW06/ELPLW04	31°	18°
ELPLM10/ELPLM06	30°	28°
ELPLM11/ELPLM07	29°	29°
ELPLL08/ELPLL07	29°	29°

Convex horizontal corner correction (correction to bilateral symmetry by using corners as the center line)

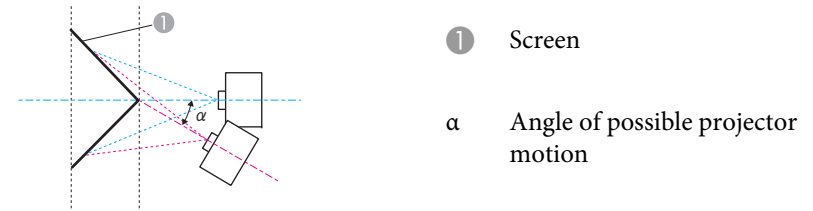

Top view

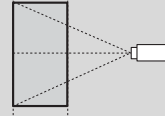
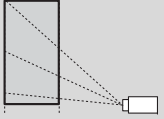
Lens type	Vertical lens shift: Home position	Vertical lens shift: Top
		
	Side view	Side view
ELPLM15/ELPLM09/ ELPLS04	15°	15°
ELPLX02	-	-
ELPLU03	1°	1°
ELPLU04/ELPLU02	-	-
ELPLR04	1°	-
ELPLW05	2°	2°
ELPLW06/ELPLW04	11°	10°
ELPLM10/ELPLM06	19°	19°
ELPLM11/ELPLM07	22°	21°
ELPLL08/ELPLL07	23°	23°

Concave vertical corner correction (correction to horizontal symmetry by using corners as the center line)

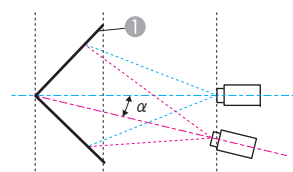

Side view

- ① Screen
- α Angle of possible projector motion

Convex vertical corner correction (correction to horizontal symmetry by using corners as the center line)

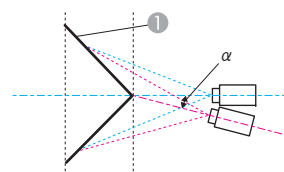

Side view

- ① Screen
- α Angle of possible projector motion

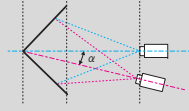
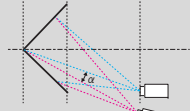
Lens type	Vertical lens shift: Home position  Side view	Vertical lens shift: Top  Side view
ELPLM15/ELPLM09/ ELPLS04	30°	17°
ELPLX02	-	-
ELPLU03	32°	24°
ELPLU04/ELPLU02	33°	3°
ELPLR04	32°	-
ELPLW05	32°	25°
ELPLW06/ELPLW04	31°	14°
ELPLM10/ELPLM06	27°	19°
ELPLM11/ELPLM07	26°	20°
ELPLL08/ELPLL07	26°	21°

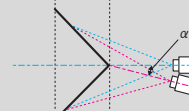
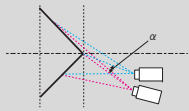
Lens type	Vertical lens shift: Home position  Side view	Vertical lens shift: Top  Side view
ELPLM15/ELPLM09/ ELPLS04	20°	8°
ELPLX02	-	-
ELPLU03	10°	4°
ELPLU04/ELPLU02	8°	*
ELPLR04	10°	-
ELPLW05	12°	6°
ELPLW06/ELPLW04	17°	3°
ELPLM10/ELPLM06	22°	14°
ELPLM11/ELPLM07	24°	18°
ELPLL08/ELPLL07	24°	20°

*Cannot be corrected accurately. Move the lens position to the home position.



Signal Type	Signal Format	Resolution (Dot)		V Sync (Hz)	Computer/BNC		HDMI			HDBaseT			DVI-D				
					RGB	YCbCr	RGB (8bit)	YCbCr (8bit)			RGB (8bit)	YCbCr (8bit)			RGB (8bit)	YCbCr (8bit)	
								4:4:4	4:2:2	4:2:0		4:4:4	4:2:2	4:2:0		4:4:4	4:2:2
	WXGA++	1600	900	60	✓		✓				✓				✓		
	SXGA	1152	864	70	✓												
				75	✓												
				85	✓												
	1280	960	60	✓		✓					✓					✓	
			75	✓													
			85	✓													
	1280	1024	60	✓		✓					✓					✓	
			75	✓													
			85	✓													
	SXGA+	1400	1050	60	✓		✓				✓					✓	
				75	✓												
	WSXGA+	1680	1050	60	✓ *2		✓				✓					✓	
	UXGA	1600	1200	60	✓		✓				✓					✓	
	1920x1080	1920	1080	50	✓		✓				✓					✓	
				60	✓		✓				✓					✓	
	WUXGA RB*1	1920	1200	60	✓		✓				✓					✓	
QXGA	2048	1536	60			✓				✓							
WQHD	2560	1440	60			✓				✓							
WQXGA RB*1	2560	1600	60			✓				✓							
SD	SDTV (480i)	720	480	59.94		✓	✓	✓	✓	✓	✓	✓			✓	✓	✓
	SDTV (576i)	720	576	50		✓	✓	✓	✓	✓	✓	✓			✓	✓	✓
	SDTV (480p)	720	480	59.94	✓	✓	✓	✓	✓	✓	✓	✓			✓	✓	✓
	SDTV (576p)	720	576	50	✓	✓	✓	✓	✓	✓	✓	✓			✓	✓	✓

Signal Type	Signal Format	Resolution (Dot)		V Sync (Hz)	Computer/BNC		HDMI			HDBaseT			DVI-D		
					RGB	YCbCr	RGB (8bit)	YCbCr (8bit)		RGB (8bit)	YCbCr (8bit)		RGB (8bit)	YCbCr (8bit)	
								4:4:4	4:2:2		4:2:0	4:4:4		4:2:2	4:2:0
				59.94					✓			✓			
				60					✓			✓			

*1 Based on VESA CVT-RB (Reduced Blanking)

*2 Only when **Wide** is selected in **Resolution** from the Signal menu.

SDI

Mode	Signal Format	Resolution (Dot)		V Sync (Hz)	SDI	
					YCbCr (10bit)	Level
SD-SDI	SDTV (480i)	720	480	59.94	✓	-
	SDTV (576i)	720	576	50	✓	-
HD-SDI	HDTV (720p)	1280	720	50	✓	-
				59.94	✓	-
				60	✓	-
	HDTV (1080i)	1920	1080	50	✓	-
				59.94	✓	-
				60	✓	-
	HDTV (1080p)	1920	1080	23.98	✓	-
				24	✓	-
				25	✓	-
				29.97	✓	-
				30	✓	-
3G-SDI	HDTV (1080p)	1920	1080	50	✓	A



Signal Type	Signal Format	Resolution (Dot)		V Sync (Hz)	Computer/BNC		HDMI			HDBaseT			DVI-D					
					RGB	YCbCr	RGB (8bit)	YCbCr (8bit)			RGB (8bit)	YCbCr (8bit)			RGB (8bit)	YCbCr (8bit)		
								4:4:4	4:2:2	4:2:0		4:4:4	4:2:2	4:2:0		4:4:4	4:2:2	
	WXGA+	1280	800	60	✓		✓				✓				✓			
				75	✓													
				85	✓													
		1366	768	60	✓		✓				✓				✓			
		1440	900	60	✓		✓					✓				✓		
				75	✓													
	85			✓														
	WXGA++	1600	900	60	✓		✓				✓				✓			
	SXGA	1152	864	70	✓													
				75	✓													
				85	✓													
		1280	960	60	✓		✓					✓				✓		
				75	✓													
				85	✓													
		1280	1024	60	✓		✓					✓				✓		
				75	✓													
				85	✓													
	SXGA+	1400	1050	60	✓		✓				✓				✓			
				75	✓													
	WSXGA+	1680	1050	60	✓ *2		✓				✓				✓			
	UXGA	1600	1200	60	✓		✓				✓				✓			
1920x1080	1920	1080	50	✓		✓				✓				✓				
			60	✓		✓				✓				✓				
WUXGA RB*1	1920	1200	60			✓				✓				✓				



Signal Type	Signal Format	Resolution (Dot)		V Sync (Hz)	Computer/BNC		HDMI			HDBaseT			DVI-D				
					RGB	YCbCr	RGB (8bit)	YCbCr (8bit)			RGB (8bit)	YCbCr (8bit)			RGB (8bit)	YCbCr (8bit)	
								4:4:4	4:2:2	4:2:0		4:4:4	4:2:2	4:2:0		4:4:4	4:2:2
SD	SDTV (480i)	720	480	59.94		✓	✓	✓	✓		✓	✓	✓		✓	✓	✓
	SDTV (576i)	720	576	50		✓	✓	✓	✓		✓	✓	✓		✓	✓	✓
	SDTV (480p)	720	480	59.94	✓	✓	✓	✓	✓		✓	✓	✓		✓	✓	✓
	SDTV (576p)	720	576	50	✓	✓	✓	✓	✓		✓	✓	✓		✓	✓	✓
HD	HDTV (720p)	1280	720	50	✓	✓	✓	✓	✓		✓	✓	✓		✓	✓	✓
				59.94	✓	✓	✓	✓	✓		✓	✓	✓		✓	✓	✓
				60	✓	✓	✓	✓	✓		✓	✓	✓		✓	✓	✓
	HDTV (1080i)	1920	1080	50		✓	✓	✓	✓		✓	✓	✓		✓	✓	✓
				59.94		✓	✓	✓	✓		✓	✓	✓		✓	✓	✓
				60		✓	✓	✓	✓		✓	✓	✓		✓	✓	✓
	HDTV (1080p)	1920	1080	23.98			✓	✓	✓		✓	✓	✓		✓	✓	✓
				24			✓	✓	✓		✓	✓	✓		✓	✓	✓
				29.97			✓	✓	✓		✓	✓	✓		✓	✓	✓
				30			✓	✓	✓		✓	✓	✓		✓	✓	✓
				50	✓		✓	✓	✓		✓	✓	✓		✓	✓	✓
				59.94	✓		✓	✓	✓		✓	✓	✓		✓	✓	✓
				60	✓		✓	✓	✓		✓	✓	✓		✓	✓	✓

*1 Based on VESA CVT-RB (Reduced Blanking)

*2 Only when **Wide** is selected in **Resolution** from the Signal menu.

Projector General Specifications

Product name	EB-L1755U EB-L1750U	EB-L1505UH EB-L1500UH	EB-L1715S EB-L1710S	EB-L1515S EB-L1510S	
Dimensions	586 (W) x 185 (H) x 492 (D) mm (not including raised section)				
LCD panel size	1.03" Wide		1.06"		
Display method	Polysilicon TFT active matrix				
Resolution	2,304,000 WUXGA (1920 (W) x 1200 (H) dots) x 3		1,470,000 SXGA+ (1400 (W) x 1050 (H) dots) x 3		
Focus adjustment	Automatic				
Zoom adjustment*1	Automatic (1-1.61)				
Lens shift*2	Automatic (Maximum vertical direction of approx. 60%, Maximum horizontal direction of approx. 18%)*3		Automatic (Maximum vertical direction of approx. 55%, Maximum horizontal direction of approx. 19%)*4		
Light source	Laser diode				
Light source output power	288 W	252 W	288 W	252 W	
Wavelength	450-460 nm				
Light source life expectancy*5	Approximately 20,000 hours (Light Source Mode: Normal, Quiet) Approximately 30,000 hours (Light Source Mode: Extended)				
Power supply	100-240V AC±10% 50/60Hz 11.0-4.7A	100-240V AC±10% 50/60Hz 9.6-4.2A	100-240V AC±10% 50/60Hz 11.0-4.7A	100-240V AC±10% 50/60Hz 9.6-4.2A	
Power consumption	100 to 120 V area	Rated power consumption: 1082 W Standby power consumption (Communication On): 2.0 W Standby power consumption (Communication Off): 0.3 W	Rated power consumption: 955 W Standby power consumption (Communication On): 2.0 W Standby power consumption (Communication Off): 0.3 W	Rated power consumption: 1082 W Standby power consumption (Communication On): 2.0 W Standby power consumption (Communication Off): 0.3 W	Rated power consumption: 955 W Standby power consumption (Communication On): 2.0 W Standby power consumption (Communication Off): 0.3 W

	220 to 240 V area	Rated power consumption: 1024 W Standby power consumption (Communication On): 2.0 W Standby power consumption (Communication Off): 0.3 W	Rated power consumption: 908 W Standby power consumption (Communication On): 2.0 W Standby power consumption (Communication Off): 0.3 W	Rated power consumption: 1024 W Standby power consumption (Communication On): 2.0 W Standby power consumption (Communication Off): 0.3 W	Rated power consumption: 908 W Standby power consumption (Communication On): 2.0 W Standby power consumption (Communication Off): 0.3 W
Operating altitude	Altitude 0 to 3,048 m				
Operating temperature	0 to +50°C*6 (Altitude of 0 to 1,500 m, no condensation) 0 to +45°C*6 (Altitude of 1,501 to 3,048 m, no condensation)				
Storage temperature	-10 to +60°C (No condensation)				
Mass*1	Approx. 24 kg				

*1 The specifications are when ELPLM15 is attached.

*2 ELPLR04 does not support lens shift.

*3 ELPLU03/ELPLW05 has a maximum vertical direction of approx. 24% and a maximum horizontal direction of approx. 10%.

ELPLX02 has a maximum up direction of approx. 20%, a maximum down direction of approx. 5%, and a maximum horizontal direction of approx. 15%.

*4 ELPLU03/ELPLW05 has a maximum vertical direction of approx. 16% and a maximum horizontal direction of approx. 9%.

ELPLX02 has a maximum vertical direction of approx. 5% and a maximum horizontal direction of approx. 5%.

*5 Approximate time until light source brightness is reduced by half.

*6 If the surrounding temperature gets too high, the brightness is automatically dimmed.

(Approximately 40°C at an altitude of 0 to 1,500 m, and approximately 35°C at an altitude of 1,501 to 3,048 m; however, this may vary depending on the surroundings and so on.)

Product name			EB-L1755U EB-L1750U	EB-L1505UH EB-L1500UH	EB-L1715S EB-L1710S	EB-L1515S EB-L1510S
Connectors	Computer Port	1	Mini D-Sub15-pin (female) blue			
	Audio1 port	1	Stereo mini jack (3.5Φ)			
	BNC port	1	5BNC (female)			
	Audio2 port	1	Stereo mini jack (3.5Φ)			
	DVI-D port	1	DVI-D 24pin Single link HDCP compatible			
	HDMI port	1	HDMI HDCP2.2 supported (Audio is only supported by PCM)		HDMI HDCP supported (Audio is only supported by PCM)	
	Audio3 port	1	Stereo mini jack (3.5Φ)			
	Audio Out port	1	Stereo mini jack (3.5Φ)			
	Monitor Out port	1	Mini D-Sub15-pin (female) black			
	HDBaseT port	1	RJ-45 (HDCP2.2 supported)		RJ-45 (HDCP supported)	
	LAN port	1	RJ-45			
	SDI input port	1	1BNC (female)		-	
	Service port*	1	USB connector (Type B)			
	RS-232C port	1	Mini D-Sub 9-pin (male)			
	Remote port	1	Stereo mini jack (3.5Φ)			
USB port (Only for wireless LAN unit)*	1	USB connector (Type A)				

* Supports USB 2.0. However, USB ports are not guaranteed to operate all devices that support USB.



This product is also designed for IT power distribution system with phase-to-phase voltage 230V.

DECLARATION of CONFORMITY

According to 47CFR, Part 2 and 15

Class B Personal Computers and Peripherals; and/or
CPU Boards and Power Supplies used with Class B Personal Computers

We: Epson America, Inc.
Located at: 3840 Kilroy Airport Way
MS: 3-13
Long Beach, CA 90806
Tel: 562-981-3840

Declare under sole responsibility that the product identified herein, complies with 47CFR Part 2 and 15 of the FCC rules as a Class B digital device. Each product marketed, is identical to the representative unit tested and found to be compliant with the standards. Records maintained continue to reflect the equipment being produced can be expected to be within the variation accepted, due to quantity production and testing on a statistical basis as required by 47CFR 2.909. Operation is subject to the following two conditions : (1) this device may not cause harmful interference, and (2) this device must accept any interference received, including interference that may cause undesired operation.

Trade Name: EPSON
Type of Product: LCD Projector
Model: H890C/H891C/H892C/H910C

**FCC Compliance Statement
For United States Users**

This equipment has been tested and found to comply with the limits for a Class B digital device, pursuant to Part 15 of the FCC Rules. These limits are designed to provide reasonable protection against harmful interference in a residential installation. This equipment generates, uses, and can radiate radio frequency energy and, if not installed and used in accordance with the instructions, may cause harmful interference to radio communications. However, there is no guarantee that interference will not occur in a particular installation. If this equipment does cause interference to radio or television reception, which can be determined by turning the equipment off and on, the user is encouraged to try to correct the interference by one or more of the following measures.

- Reorient or relocate the receiving antenna.
- Increase the separation between the equipment and receiver.
- Connect the equipment into an outlet on a circuit different from that to which the receiver is connected.
- Consult the dealer or an experienced radio/TV technician for help.

WARNING

The connection of a non-shielded equipment interface cable to this equipment will invalidate the FCC Certification or Declaration of this device and may cause interference levels which exceed the limits established by the FCC for this equipment. It is the responsibility of the user to obtain and use a shielded equipment interface cable with this device. If this equipment has more than one interface connector, do not leave cables connected to unused interfaces. Changes or modifications not expressly approved by the manufacturer could void the user's authority to operate the equipment.

Units: mm

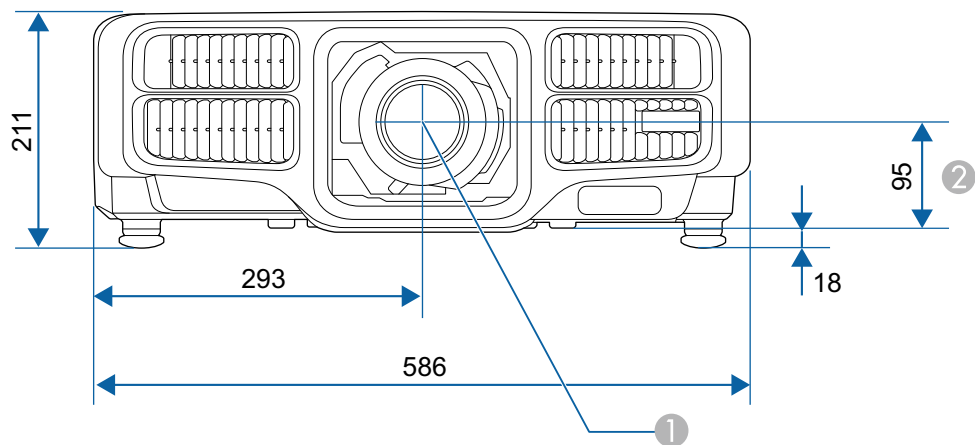

- ① Center of lens
- ② Distance from center of lens to suspension bracket fixing point

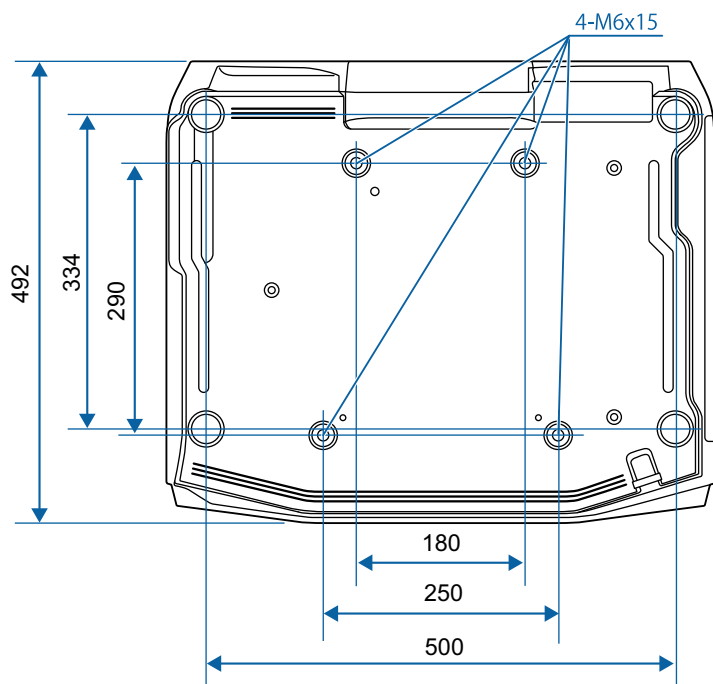

This section briefly explains the difficult terms that are not explained in the text of this guide. For details, refer to other commercially available publications.

AMX Device Discovery	AMX Device Discovery is a technology developed by AMX to facilitate AMX control systems for easy operation of the target equipment. Epson have implemented this protocol technology, and have provided a setting to enable the protocol function (ON). See the AMX Web site for more details. URL: http://www.amx.com/
Aspect Ratio	The ratio between an image's length and its height. Screens with a horizontal:vertical ratio of 16:9, such as HDTV screens, are known as wide screens. SDTV and general computer displays have an aspect ratio of 4:3.
Component Video	A method that separates the video signal into a luminance component (Y), and a blue minus luminance (Cb or Pb) and a red minus luminance (Cr or Pr).
Composite video	A method that combines the video signal into a luminance component and a color component for transmission down a single cable.
Contrast	The relative brightness of the light and dark areas of an image can be increased or decreased to make text and graphics stand out more clearly, or to make them appear softer. Adjusting this particular property of an image is called contrast adjustment.
Control4 Simple Device Discovery Protocol (SDDP)	Control4 SDDP is a technology developed by Control4 to allow Control4 control systems to acquire device information for the projector. Epson have implemented this protocol technology, and have provided a setting to enable the protocol function (ON). See the Control4 Web site for more details. URL: http://www.control4.com/
DHCP	An abbreviation of Dynamic Host Configuration Protocol, this protocol automatically assigns an IP Address to equipment connected to a network.
DICOM	An acronym for Digital Imaging and Communications in Medicine. An international standard that defines image standards and a communications protocol for medical images.
Gateway Address	This is a server (router) for communicating across a network (subnet) divided according to Subnet Mask .
HDBaseT	The connection standard for consumer electronics determined by the HDBaseT Alliance. Communicates various control signals such as uncompressed HD video, audio and 100BASE-TX Ethernet using a LAN cable.
HDCP	HDCP is an abbreviation for High-bandwidth Digital Content Protection. It is used to prevent illegal copying and protect copyrights by encrypting digital signals sent over DVI and HDMI ports. HDCP2.2 is a copyright protection standard for 4K content.
HDTV	An abbreviation for High-Definition Television that refers to high-definition systems which satisfy the following conditions. <ul style="list-style-type: none"> • Vertical resolution of 720p or 1080i or greater (p = Progressive, i = Interlace) • Screen Aspect Ratio of 16:9
Infrastructure mode	A method for wireless LAN connection in which devices communicate through access points.
Interlace	Transmits information needed to create one screen by sending every other line, starting from the top of the image and working down to the bottom. Images are more likely to flicker because one frame is displayed every other line.

IP Address	A number to identify a computer connected to a network.
Progressive	Projects information to create one screen at a time, displaying the image for one frame. Even though the number of scan lines is the same, the amount of flicker in images decreases because the volume of information has doubled compared with an interlace system.
Refresh Rate	The light-emitting element of a display maintains the same luminosity and color for an extremely short time. Because of this, the image must be scanned many times per second to refresh the light-emitting element. The number of refresh operations per second is called the Refresh rate and is expressed in hertz (Hz).
SDTV	An abbreviation for Standard Definition Television that refers to standard television systems which do not satisfy the conditions for HDTV ▶ High-Definition Television.
SNMP	An abbreviation for Simple Network Management Protocol, which is the protocol for monitoring and controlling devices such as routers and computers connected to a TCP/IP network.
Subnet Mask	This is a numerical value that defines the number of bits used for the network address on a divided network (subnet) from the IP address.
Sync.	The signals output from computers have a specific frequency. If the projector frequency does not match this frequency, the resulting images are not of a good quality. The process of matching the phases of these signals (the relative position of the crests and the troughs in the signal) is called Synchronization. If the signals are not synchronized, flickering, blurriness, and horizontal interference occur.
Tracking	The signals output from computers have a specific frequency. If the projector frequency does not match this frequency, the resulting images are not of a good quality. The process of matching the frequency of these signals (the number of crests in the signal) is called Tracking. If Tracking is not carried out correctly, wide vertical stripes appear in the signal.
Trap IP Address	This is the IP Address ▶ for the destination computer used for error notification in SNMP.

All rights reserved. No part of this publication may be reproduced, stored in a retrieval system, or transmitted in any form or by any means, electronic, mechanical, photocopying, recording, or otherwise, without the prior written permission of Seiko Epson Corporation. No patent liability is assumed with respect to the use of the information contained herein. Neither is any liability assumed for damages resulting from the use of the information contained herein.

Neither Seiko Epson Corporation nor its affiliates shall be liable to the purchaser of this product or third parties for damages, losses, costs, or expenses incurred by the purchaser or third parties as a result of: accident, misuse, or abuse of this product or unauthorized modifications, repairs, or alterations to this product, or (excluding the U.S.) failure to strictly comply with Seiko Epson Corporation's operating and maintenance instructions.

Seiko Epson Corporation shall not be liable against any damages or problems arising from the use of any options or any consumable products other than those designated as Original Epson Products or Epson Approved Products by Seiko Epson Corporation.

The contents of this guide may be changed or updated without further notice.

Illustrations in this guide and the actual projector may differ.

Restriction of Use

When this product is used for applications requiring high reliability/safety such as transportation devices related to aviation, rail, marine, automotive etc.; disaster prevention devices; various safety devices etc; or functional/precision devices etc, you should use this product only after giving consideration to including fail-safes and redundancies into your design to maintain safety and total system reliability. Because this product was not intended for use in applications requiring extremely high reliability/safety such as aerospace equipment, main communication equipment, nuclear power control equipment, or medical equipment related to direct medical care etc, please make your own judgment on this product's suitability after a full evaluation.

About Notations

Microsoft® Windows Vista® operating system
Microsoft® Windows® 7 operating system
Microsoft® Windows® 8 operating system
Microsoft® Windows® 8.1 operating system
Microsoft® Windows® 10 operating system

In this guide, the operating systems above are referred to as "Windows Vista", "Windows 7", "Windows 8", "Windows 8.1", and "Windows 10". Furthermore, these may be referred to as the collective term Windows, and multiple versions of Windows may be referred to as, for example, Windows Vista/7/8/8.1/10, with the Windows notation omitted.

OS X 10.7.x
OS X 10.8.x
OS X 10.9.x
OS X 10.10.x
OS X 10.11.x
macOS 10.12.x

In this guide, the operating systems above are referred to as "OS X 10.7.x", "OS X 10.8.x", "OS X 10.9.x", "OS X 10.10.x", "OS X 10.11.x", and "macOS 10.12.x". Furthermore, the collective term "OS X" is used to refer to them all.

Trademarks and Copyrights

"EPSON" is a registered trademark of Seiko Epson Corporation. "EXCEED YOUR VISION" and "ELPLP" are trademarks or registered trademarks of Seiko Epson Corporation.

Mac, Mac OS, and OS X, are trademarks of Apple Inc.

Microsoft, Windows, Windows Vista, PowerPoint, and Windows logo are trademarks or registered trademarks of Microsoft Corporation in the United States and/or other countries.

App Store is a service mark of Apple Inc.

Google Play is a trademark of Google Inc.

HDMI and High-Definition Multimedia Interface are the trademarks or registered trademarks of HDMI Licensing LLC. 

PJLink trademark is a trademark applied for registration or is already registered in Japan, the United States of America and other countries and areas.

WPA™ and WPA2™ are registered trademarks of the Wi-Fi Alliance.

"QR Code" is a registered trademark of DENSO WAVE INCORPORATED.

Crestron and Crestron RoomView are registered trademarks of Crestron Electronics, Inc.

Art-Net™ Designed by and Copyright Artistic Licence Holdings Ltd.

Extron® and XTP® are registered trademarks of Extron Electronics.

HDBaseT™ and the HDBaseT Alliance logo are trademarks of the HDBaseT Alliance.

Other product names used herein are also for identification purposes only and may be trademarks of their respective owners. Epson disclaims any and all rights in those marks.







©SEIKO EPSON CORPORATION 2017. All rights reserved.







Indication of the manufacturer and the importer in accordance with requirements of directive 2011/65/EU (RoHS)

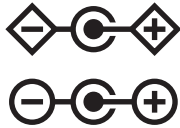

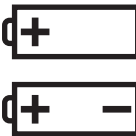





Manufacturer: SEIKO EPSON CORPORATION
Address: 3-5, Owa 3-chome, Suwa-shi, Nagano-ken 392-8502 Japan
Telephone: 81-266-52-3131
<http://www.epson.com/>

Importer: SEIKO EUROPE B.V.
Address: Azië building, Atlas ArenA, Hoogoorddreef 5, 1101 BA Amsterdam
Zuidoost The Netherlands
Telephone: 31-20-314-5000
<http://www.epson.com/europe.html>

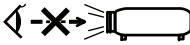
The following table lists the meaning of the safety symbols labeled on the equipment.

No.	Symbol mark	Approved standards	Meaning
①		IEC60417 No. 5007	"ON" (power) To indicate connection to the mains.
②		IEC60417 No. 5008	"OFF" (power) To indicate disconnection from the mains.
③		IEC60417 No. 5009	Stand-by To identify the switch or switch position by means of which part of the equipment is switched on in order to bring it into the stand-by condition.
④		ISO7000 No. 0434B IEC3864-B3.1	Caution To identify general caution when using the product.
⑤		IEC60417 No. 5041	Caution, hot surface To indicate that the marked item can be hot and should not be touched without taking care.
⑥		IEC60417 No. 6042 ISO3864-B3.6	Caution, risk of electric shock To identify equipment that has risk of electric shock.
⑦		IEC60417 No. 5957	For indoor use only To identify electrical equipment designed primarily for indoor use.
⑧		IEC60417 No. 5926	Polarity of d.c. power connector To identify the positive and negative connections (the polarity) on a piece of equipment to which a d.c. power supply may be connected.

No.	Symbol mark	Approved standards	Meaning
⑨		IEC60417 No. 5001B	Battery, general On battery powered equipment. To identify a device for instance a cover for the battery compartment, or the connector terminals.
⑩		IEC60417 No. 5002	Positioning of cell To identify the battery holder itself and to identify the positioning of the cell(s) inside the battery holder.
⑪		IEC60417 No. 5019	Protective earth To identify any terminal which is intended for connection to an external conductor for protection against electric shock in case of a fault, or the terminal of a protective earth electrode.
⑫		IEC60417 No. 5017	Earth To identify an earth (ground) terminal in cases where symbol No. 11 is not explicitly required.
⑬		IEC60417 No. 5032	Alternating current To indicate on the rating plate that the equipment is suitable for alternating current only; to identify relevant terminals.
⑭		IEC60417 No. 5031	Direct current To indicate on the rating plate that the equipment is suitable for direct current only; to identify relevant terminals.
⑮		IEC60417 No. 5172	Class II equipment To identify equipment meeting the safety requirements specified for Class II equipment according to IEC 61140.

No.	Symbol mark	Approved standards	Meaning
16		ISO 3864	General prohibition To identify actions or operations that are prohibited.
17		ISO 3864	Contact prohibition To indicate injury that could occur due to touching a specific part of the equipment.
18		---	Never look into the projection lens while the projector is on.
19		---	To indicate that the marked item don't place anything on projector.
20		ISO3864 IEC60825-1	Caution, laser radiation To indicate the equipment has a laser radiation part.
21		ISO 3864	Disassembly prohibition To indicate a risk of injury, such as electric shock, if the equipment is disassembled.
22		---	Never look into the lens while the LED for lighting is on.
23		IEC60417 No. 5266	Standby, partial standby To indicate that part of the equipment is in the ready status.
24		ISO3864 IEC60417 No. 5057	Caution, movable parts To indicate that you must keep away from movable parts according to protection standards.

A

A/V Mute	20, 110
A/V Settings	153
Air exhaust vent	17
Air Filter Notice	150
Air filter replacement period	210
AMX Device Discovery	164
Art-Net	164
Aspect	81, 146
Audio Out port	18
Audio1 port	18
Audio2 port	18
Audio3 port	18
Auto Setup	146

B

Basic menu	157
Batch setup function	168
Beep	152
Black Level	154
BNC port	18
BNC Sync Termination	152
Brightness	144
BT.709	77

C

Ceiling	151
Ceiling mount fixing points	20
Cinema	77
Cleaning	207
Cleaning the air filter and air intake vent	207

Cleaning the projector's surface	207
Color Adjustment	145
Color adjustment	145
Color Mode	77, 144
Color Saturation	144
Color Uniformity	150, 154
Computer Port	18
Configuration menu	140
Consumables	240
Contrast	144
Control panel	20
Control4 SDDP	164
Corner Wall	72
Crestron RoomView	164, 230
Cross	112

D

Date & Time	152
DHCP	160, 162
DICOM SIM	77
Direct Power On	151
Display	150
Display Background	150
Distance	241
Document Camera	240
Dynamic	77
Dynamic Contrast	145

E

Edge Blending	97, 154
EDID	147, 193
Epson Projector Management	218
Epson Web Control	218

Esc	21
ESC/VP21	228
Event ID	166
Extended menu	150
Extron XTP	154
E-Zoom	112

F

Filter Indicator	178
Focus	39
Freeze	111
Front	151
Front adjustable feet	19
Full Lock	122

G

Gateway Address	160, 162
Geometry Correction	148

H

H/V-Keystone	148
HDBaseT	154
HDBaseT port	19
HDBaseT Signal Quality	166
HDMI port	19
Help function	176
High Altitude Mode	151
Home Screen	59
How to replace the air filter	210

I

Image Menu	143
------------------	-----

- Indicators 178
 - Info menu 165
 - Input Signal 165
 - Installation requirements 30
 - Installation settings 30
 - IP Address 160, 162
- L**
- Language 154
 - Lens Operation Lock 123
 - Lens Replacement Cover 28
 - Lens shift 34
 - Light Source Calibration 7, 116
- M**
- Mail Notification 163, 227
 - Memory 149
 - Menu 20
 - Message Broadcasting 164
 - Messages 150
 - Monitor displays 266
 - Monitor Out port 18
 - Multi-Projection 77, 154
 - Multi-Projection function 93
- N**
- Natural 77
 - Network Configuration 156
 - Network information 156
 - Network menu 155
 - Notification email address 1/2/3 163
- O**
- Operating Temperature 274
 - Operation 151
 - Optional accessories 240
 - Overheating 180
 - Overscan 146
- P**
- Panel Alignment 150
 - Part names and functions 16
 - Password protect 120
 - PJLink 230
 - PJLink Password 157
 - Port Number 163
 - Position 146
 - Power inlet 17
 - Power On Protection 120
 - Presentation 77
 - Priority Gateway 164
 - Projection 151
 - Projection lens 28
 - Projector 59, 61
 - Projector ID 43
 - Projector keyword 158
 - Projector Name 157
- Q**
- Quick Corner 148
- R**
- Reading mail 227
 - Rear 151
 - Rear feet 19
 - Refresh Rate 165
 - Remote control 21
 - Remote control button lock 123
 - Remote control ID 44
 - Remote port 19
 - Remote receiver 16
 - Replacing batteries 24
 - Reset All 167
 - Reset Memory 167
 - Reset menu 167
 - Resolution 146, 165
 - RoomView 231
 - RS-232C port 19
- S**
- Scale 147, 154
 - Schedule 116
 - Schedule Settings 154
 - Screen 150
 - Screen settings 31
 - Screen Size 109
 - Screen size 241
 - Search Access Point 161
 - Serial Number 166
 - Settings menu 148
 - Sharpness 144
 - Signal menu 146
 - SMTP Server 163
 - SNMP 228
 - Soft keyboard 157
 - Source 108, 165
 - Source Search 20, 62

Specifications	273	Wired LAN menu	162
Split Screen	148	Wireless LAN menu	158
Split Screen Setup	108		
Standby Mode	153		
Startup Screen	150		
Status	166		
Status indicators	16		
Storage temperature	274		
Subnet Mask	160, 162		
Supported monitor displays	266		
Swap Screens	109		
Sync Info	165		
Sync.	146		

T

Test Pattern	32, 149
Tint	144
Tracking	146
Trap IP Address 1/2	163

U

User Button	149
User's Logo	113
User's Logo Protection	120

V

Volume	148
--------------	-----

W

Web browser	218
Web Control Password	158
White Balance	144