



Digital Projector User Manual

Home Entertainment Series | TK810

V1.00



Warranty and Copyright information

Limited warranty

BenQ warrants this product against any defects in material and workmanship, under normal usage and storage.

Proof of purchase date will be required with any warranty claim. In the event this product is found to be defective within the warranty period, BenQ's only obligation and your exclusive remedy shall be replacement of any defective parts (labor included). To obtain warranty service, immediately notify the dealer from which you purchased the product of any defects.

Important: The above warranty shall be void if the customer fails to operate the product in accordance with BenQ's written instructions, especially the ambient humidity must be in-between 10% and 90%, temperature in-between 0°C and 35°C, altitude lower than 4920 feet, and avoiding to operate the projector in a dusty environment. This warranty gives you specific legal rights, and you may have other rights which vary from country to country.

For other information, please visit www.BenQ.com.

Copyright

Copyright © 2019 by BenQ Corporation. All rights reserved. No part of this publication may be reproduced, transmitted, transcribed, stored in a retrieval system or translated into any language or computer language, in any form or by any means, electronic, mechanical, magnetic, optical, chemical, manual or otherwise, without the prior written permission of BenQ Corporation.

Disclaimer

BenQ Corporation makes no representations or warranties, either expressed or implied, with respect to the contents hereof and specifically disclaims any warranties, merchantability or fitness for any particular purpose. Further, BenQ Corporation reserves the right to revise this publication and to make changes from time to time in the contents hereof without obligation to notify any person of such revision or changes.

*DLP, Digital Micromirror Device and DMD are trademarks of Texas Instruments. Others are copyrights of their respective companies or organizations.

Patents

Please go to <http://patmarking.benq.com/> for the details on BenQ projector patent coverage.

Table of Contents

Warranty and Copyright information	2
Important safety instructions	4
Introduction	7
Shipping contents	7
Projector exterior view	8
Controls and functions	9
Positioning your projector	11
Choosing a location	11
Obtaining a preferred projected image size	12
Mounting the projector	12
Operation	14
Installing the USB wireless dongle	14
Starting up the projector	14
Shutting down the projector	16
Adjusting the projected image	17
Fine-tuning the image size and clarity	17
Correcting keystone	17
BenQ Launcher	19
The BenQ Launcher home page	19
Navigating the BenQ Launcher home page	20
Using Voice Assistant	20
Using BenQ Launcher Settings	21
Connection	22
Wireless Connections	23
Wireless Hotspot	28
Bluetooth Connections	30
USB Connections	32
Software update	33
Navigating the Settings	34
Using the Settings	34
General	35
Display	37
Preference	42
Other menus	45
Maintenance	46
Care of the projector	46
Light information	46
Troubleshooting	52
Specifications	53
Projector specifications	53
Dimensions	54
Timing chart	55

Important safety instructions

Your projector is designed and tested to meet the latest standards for safety of information technology equipment. However, to ensure safe use of this product, it is important that you follow the instructions mentioned in this manual and marked on the product.

1. **Please read this manual before you operate your projector.** Save it for future reference.



2. **Do not look straight at the projector lens during operation.** The intense light beam may damage your eyes.

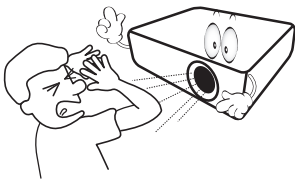

3. **Refer servicing to qualified service personnel.**

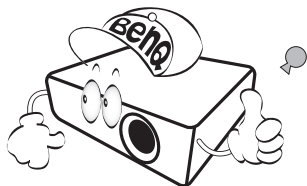

4. **Always open the lens shutter (if any) or remove the lens cap (if any) when the projector lamp is on.**

5. The lamp becomes extremely hot during operation. Allow the projector to cool for approximately 45 minutes prior to removing the lamp assembly for replacement.



6. In some countries, the line voltage is NOT stable. This projector is designed to operate safely within a mains voltage between 100 to 240 volts AC, but could fail if power cuts or surges of ± 10 volts occur. **In areas where the mains voltage may fluctuate or cut out, it is recommended that you connect your projector through a power stabilizer, surge protector or uninterruptible power supply (UPS).**

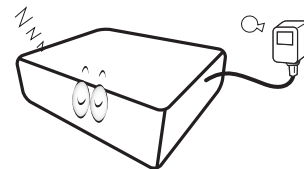

7. Do not block the projection lens with any objects when the projector is under operation as this could cause the objects to become heated and deformed or even cause a fire. To temporarily turn off the lamp, use the blank function.

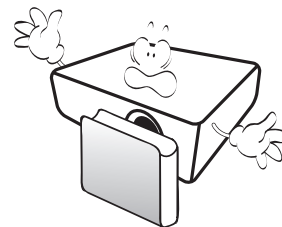

8. Do not operate lamps beyond the rated lamp life. Excessive operation of lamps beyond the rated life could cause them to break on rare occasions.



9. Never replace the lamp assembly or any electronic components unless the projector is unplugged.



10. Do not place this product on an unstable cart, stand, or table. The product may fall, sustaining serious damage.

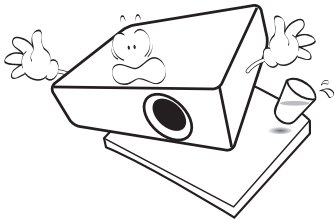

11. Do not attempt to disassemble this projector. There are dangerous high voltages inside which may cause death if you should come into contact with live parts. The only user serviceable part is the lamp which has its own removable cover.

Under no circumstances should you ever undo or remove any other covers. Refer servicing only to suitably qualified professional service personnel.

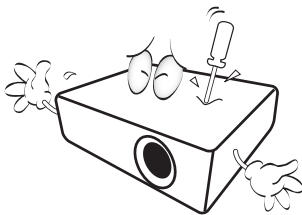

12. Do not block the ventilation holes.

- Do not place this projector on a blanket, bedding or any other soft surface.
- Do not cover this projector with a cloth or any other item.
- Do not place inflammables near the projector.

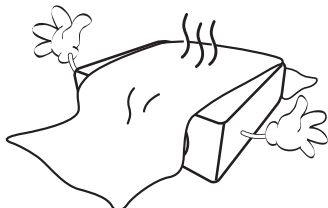

If the ventilation holes are seriously obstructed, overheating inside the projector may result in a fire.

13. Always place the projector on a level, horizontal surface during operation.

- Do not use if tilted at an angle of more than 10 degrees left to right, nor at angle of more than 15 degrees front to back. Using the projector when it is not fully horizontal may cause a malfunction of, or damage to, the lamp.

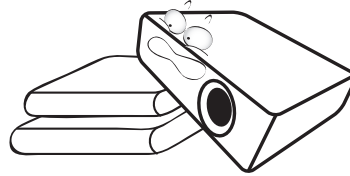

14. Do not stand the projector on end vertically. Doing so may cause the projector to fall over, causing injury or resulting in damage to the projector.



15. Do not step on the projector or place any objects upon it. Besides probable physical damage to the projector, doing so may result in accidents and possible injury.

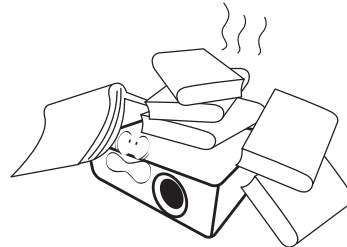

16. When the projector is under operation, you may sense some heated air and odor from its ventilation grill. It is a normal phenomenon and not a product defect.

17. Do not place liquids near or on the projector. Liquids spilled into the projector may cause it to fail. If the projector does become wet, disconnect it from the power supply's power outlet and call BenQ to have the projector serviced.

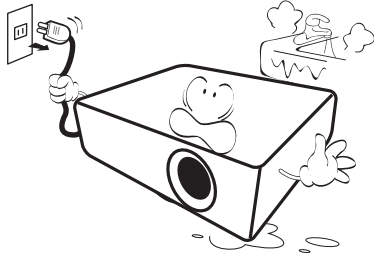

18. This product is capable of displaying inverted images for ceiling/wall mount installation.

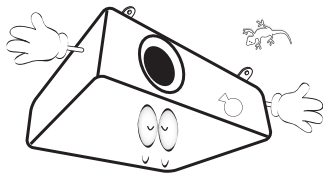

19. This apparatus must be earthed.



- Hg - Lamp contains mercury. Manage in accordance with local disposal laws. See www.lamprecycle.org.
- To avoid damaging the DLP chips, never aim a high-power laser beam into the projection lens.

20. Do not place this projector in any of the following environments.

- Space that is poorly ventilated or confined. Allow at least 50 cm clearance from walls and free flow of air around the projector.
- Locations where temperatures may become excessively high, such as the inside of a car with all windows rolled up.
- Locations where excessive humidity, dust, or cigarette smoke may contaminate optical components, shorten the projector's life span and darken the image.

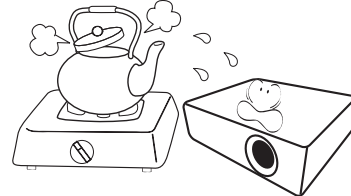

- Locations near fire alarms
- Locations with an ambient temperature above 40°C / 104°F
- Locations where the altitudes are higher than 3000 m (10000 feet).

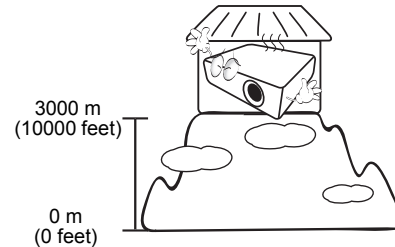

Introduction

Shipping contents

Carefully unpack and verify that you have all of the items shown below. If any of these items are missing, please contact your place of purchase.

Standard accessories

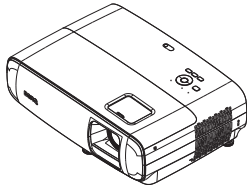

Projector

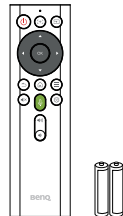

Remote control with batteries



User manual CD



Quick start guide and Warranty card*

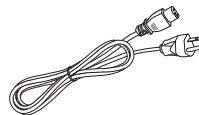

Power cord

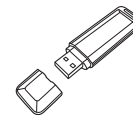

USB wireless dongle



- The supplied accessories will be suitable for your region, and may differ from those illustrated.
- *The warranty card is only supplied in some specific regions. Please consult your dealer for detailed information.

Optional accessories

1. Spare lamp kit
2. 3D glasses

Replacing the remote control batteries

1. Press and open the battery cover, as illustrated.
2. Remove the old batteries (if applicable) and install two AAA batteries. Make sure that the positive and negative ends are positioned correctly, as illustrated.
3. Replace the battery cover until it clicks into place.

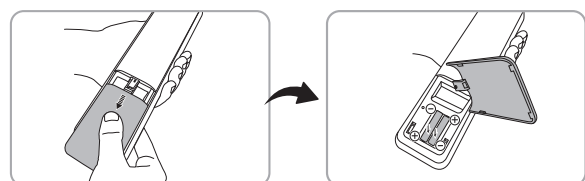

- Avoid leaving the remote control and batteries in an excessive heat or humid environment like the kitchen, bathroom, sauna, sunroom or in a closed car.
- Replace only with the same or equivalent type recommended by the battery manufacturer.
- Dispose of the used batteries according to the manufacturer's instructions and local environment regulations for your region.
- Never throw the batteries into a fire. There may be danger of an explosion.
- If the batteries are dead or if you will not be using the remote control for an extended period of time, remove the batteries to avoid damage to the remote control from possible battery leakage.

Projector exterior view

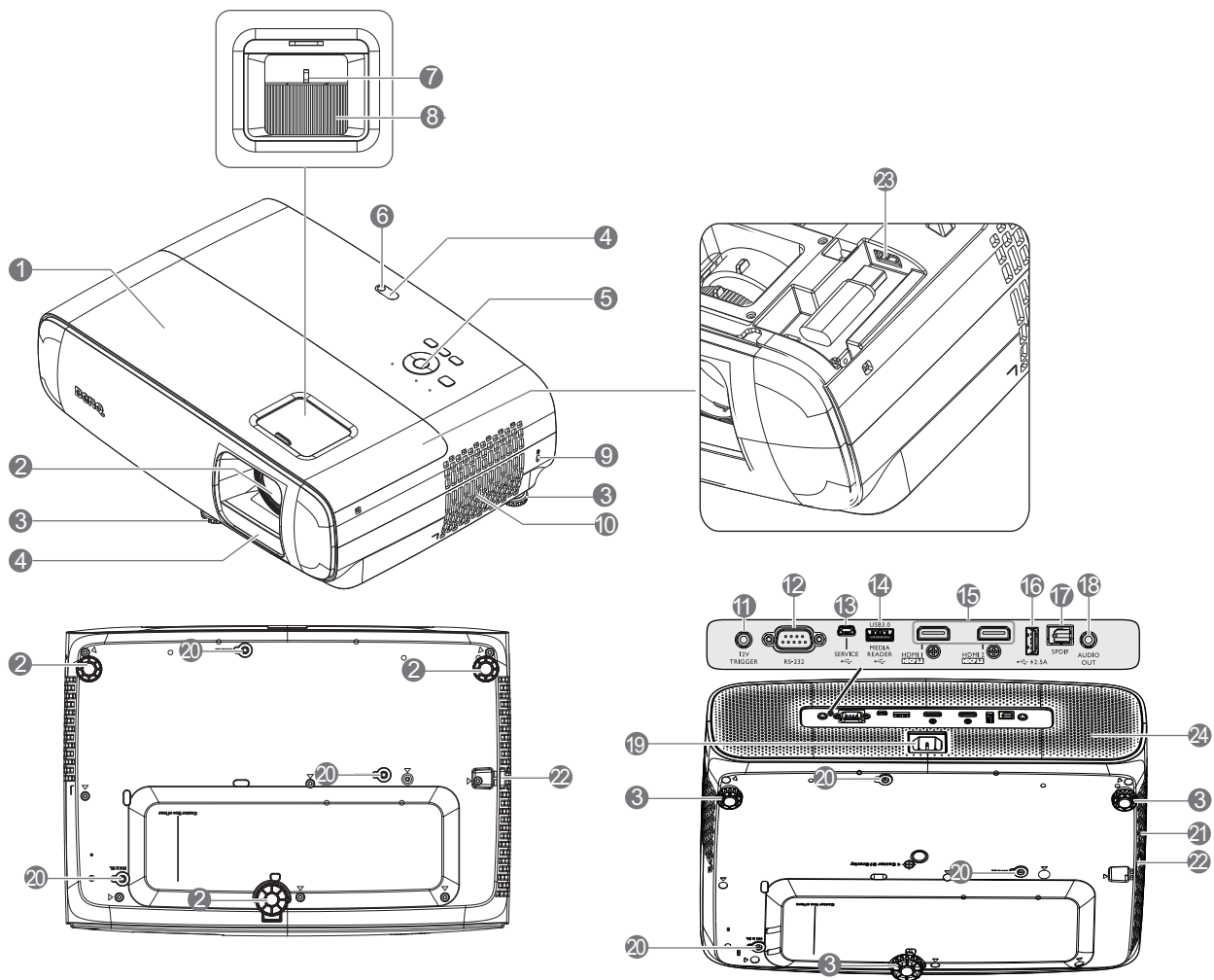

- 1. Lamp cover
- 2. Projection lens
- 3. Adjuster feet
- 4. IR remote sensor
- 5. External control panel
(See [Controls and functions on page 9.](#))
- 6. Light sensor
- 7. Zoom ring
- 8. Focus ring
- 9. Kensington anti-theft lock slot
- 10. Vent (air inlet)
- 11. 12V DC output terminal
Triggers external devices such as an electric screen or light control, etc.
- 12. RS-232 control port
- 13. USB Mini-B port (for firmware upgrades)
- 14. USB Type-A port (USB 3.0: 5V 1.5A media reader/drive, firmware download)
- 15. HDMI 1/ HDMI 2 input port (Version 2.0b)
- 16. USB Type-A port (USB 2.0: 2.5A power supply)
- 17. SPDIF output port
- 18. Audio output jack
- 19. AC power jack
- 20. Wall mount holes
- 21. Vent (air exhaust)
- 22. Security bar
- 23. USB Type-A port (USB wireless dongle)*
- 24. Speaker

* Located under the lamp cover. Before you plug into the dongle, remove the lamp cover and then install it back into position. Do not turn the power on with the lamp cover open.

Controls and functions

Projector & Remote control



All the key presses described in this document are available on the remote control or projector.

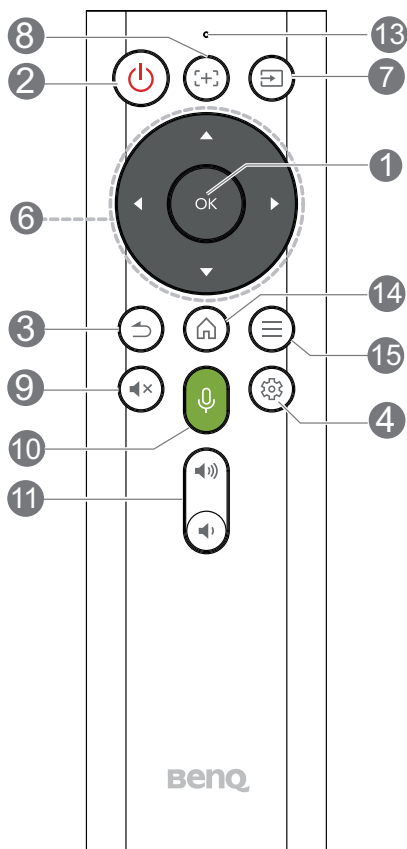
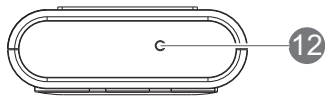
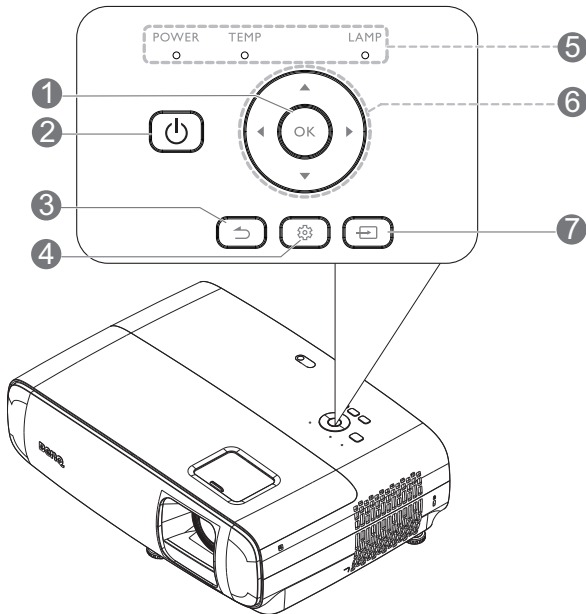

1. OK

Used to confirm the selection on the **BenQ Launcher** menu.

2. Power

Turns the projector off and on after initial startup.

3. Back

Used to return to the previous layer.

4. Settings

Enter **Settings** menu.

5. POWER indicator light/TEMPERature warning light/LAMP indicator light

(See [Indicators](#) on page 51.)

6. Arrow keys (▲, ▼, ◀, ▶)*

When the On-Screen Display (OSD) menu is activated, these keys are used as directional arrows to select the desired menu items and to make adjustments.

7. Source*

Displays the source selection bar.

8. Cursor*

Pressing this key to enable or disable mouse cursor.

9. Mute*

Toggles projector audio between on and off.

10. Voice button*

Press and hold the voice button to activate voice assistant. Hold this key and speak to the microphone at the top of the remote control while using voice assistant.

11. Volume keys*

Decreases or increase the projector volume.

12. Microphone

Receives voice command.

13. LED Indicator

Flashes when the key is pressed or when doing Bluetooth Remote Control Pairing.

Press **Home** and **Menu** on the remote control at the same time for at least 3 seconds until the LED Indicator is flashing for pairing. If pairing is completed, then the LED Indicator will stop flashing.

14. **Home***

Press this key to enter the **BenQ Launcher** home menu.

15. **Menu***

Launches the Apps related settings when operating in All Apps.



- Do not block the projection lens from projecting as this could cause the blocking object to become heated and deformed or even cause a fire.

- Keys with "*" means that they are workable when the remote control is connected to **Bluetooth**.

Remote control effective range

The remote control must be held at an angle within with a range of 8 metres (~26 feet) at an angle of 30-degrees (left and right) and 20-degrees (up and down).

Make sure that there are no obstacles between the remote control and the IR sensor(s) on the projector that might obstruct the infra-red beam.

In a completely open environment, the distance of Bluetooth remote control will be within 10 meters. However, the remote control distance will be affected by the obstacles such as the wall or wireless signal.

- Operating the projector from the front

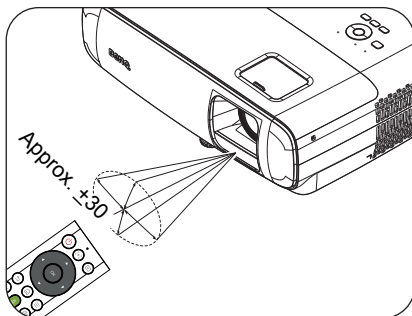

- Operating the projector from the top

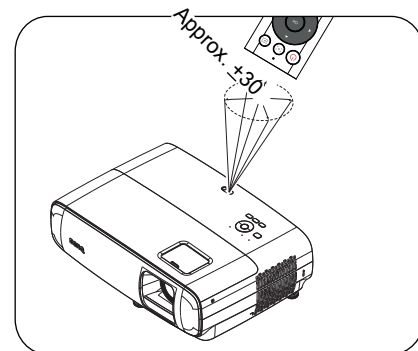

Positioning your projector

Choosing a location

Before choosing an installation location for your projector, take the following factors into consideration:

- Size and position of your screen
- Electrical outlet location
- Location and distance between the projector and the rest of your equipment

You can install your projector in the following ways.

1. Front Table

Select this location with the projector placed on the table in front of the screen. This is the most common way to position the projector for quick setup and portability.

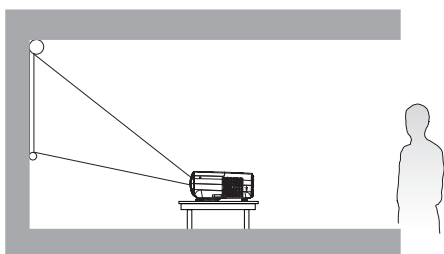

2. Rear Table

Select this location with the projector placed on the table behind the screen. Note that a special rear projection screen is required.

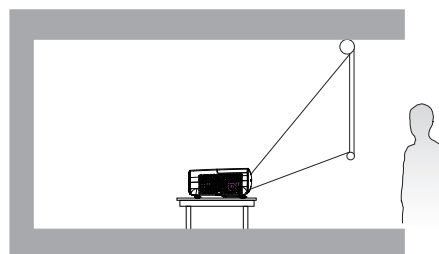

3. Front Ceiling

Select this location with the projector suspended upside-down in front of the screen. Purchase the BenQ Projector Ceiling/Wall Mount Kit from your dealer to mount your projector.

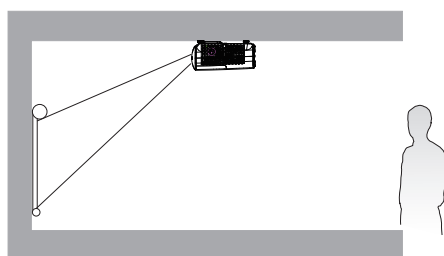

4. Rear Ceiling

Select this location with the projector suspended upside-down from behind the screen. Note that a special rear projection screen and the BenQ Projector Ceiling/Wall Mount Kit are required for this installation location.

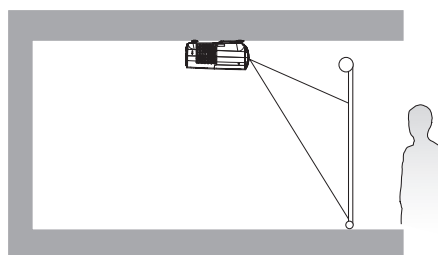

You can do one of the steps below to choose **Projector Position**:

1. If this is the first time you turn on the projector, the first step in setup wizard will guide you to select a setting. See [Starting up the projector](#).
2. From **BenQ Launcher** home page, go to **Settings > Preference > Installation > Projector installation** and select a setting.

Obtaining a preferred projected image size

The distance from the projector lens to the screen, the zoom setting (if available), and the video format each factors in the projected image size.

Projection dimensions

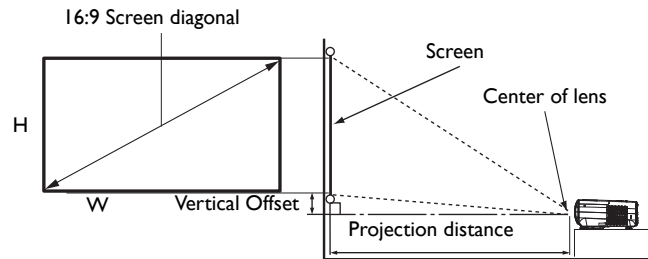

- The screen aspect ratio is 16:9 and the projected picture is in a 16:9 aspect ratio

Screen size				Distance from screen (mm)			Vertical offset (mm)
Diagonal		H (mm)	W (mm)	Min length	Average	Max length	
Inch	mm			(max. zoom)		(min. zoom)	
30	762	374	664	957	1007	1057	21
40	1016	498	886	1291	1358	1425	28
50	1270	623	1107	1624	1708	1792	35
60	1524	747	1328	1958	2059	2160	41
80	2032	996	1771	2625	2760	2895	55
100	2540	1245	2214	3293	3462	3631	69
120	3048	1494	2657	3960	4163	4366	83
140	3556	1743	3099	4627	4864	5101	97
160	4064	1992	3542	5295	5566	5837	111
180	4572	2241	3985	5962	6267	6572	124
200	5080	2491	4428	6629	6968	7307	138
220	5588	2740	4870	7296	7670	8043	152
250	6350	3113	5535	8297	8722	9146	173
300	7620	3736	6641	9966	10475	10984	207

For example, if you are using a 120-inch screen, the recommended projection distance is 4163 mm.

If your measured projection distance is 6000 mm, the closest match in the "Distance from screen (mm)" column is 6267 mm. Looking across this row shows that a 180" (about 4.6 m) screen is required.

Mounting the projector

If you intend to mount your projector, we strongly recommend that you use a proper fitting BenQ projector mounting kit and that you ensure it is securely and safely installed.

If you use a non-BenQ brand projector mounting kit, there is a safety risk that the projector may fall down due to an improper attachment through the use of the wrong gauge or length screws.

Before mounting the projector

- Purchase a BenQ projector mounting kit from the place you purchased your BenQ projector.
- BenQ recommends that you also purchase a separate Kensington lock compatible security cable and attach it securely to both the Kensington lock slot on the projector and the base of the mounting

bracket. This will perform the secondary role of restraining the projector should its attachment to the mounting bracket become loose.

- Ask your dealer to install the projector for you. Installing the projector on your own may cause it to fall and result in injury.
- Take necessary procedures to prevent the projector from falling off such as during an earthquake.
- The warranty doesn't cover any product damage caused by mounting the projector with a non-BenQ brand projector mounting kit.
- Consider the surrounding temperature where the projector is ceiling/wall mounted. If a heater is used, the temperature around the ceiling/wall may be higher than expected.
- Read the user manual for the mounting kit about the range of torque. Tightening with torque exceeding the recommended range may cause damage to the projector and subsequently falling off.
- Make sure the power outlet is at an accessible height so that you can easily shut down the projector.

Ceiling/Wall mount installation diagram

Ceiling/Wall mount screw: M4
(Max L = 25 mm; Min L = 20 mm)

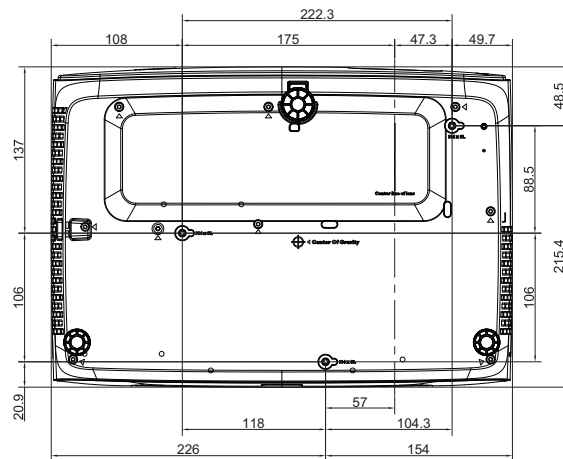

Unit: mm

Operation

Installing the USB wireless dongle

Follow the illustrations below to install the USB wireless dongle. Make sure that the lamp cover is installed back after the USB wireless dongle is plugged. Do not turn the power on with the lamp cover open.

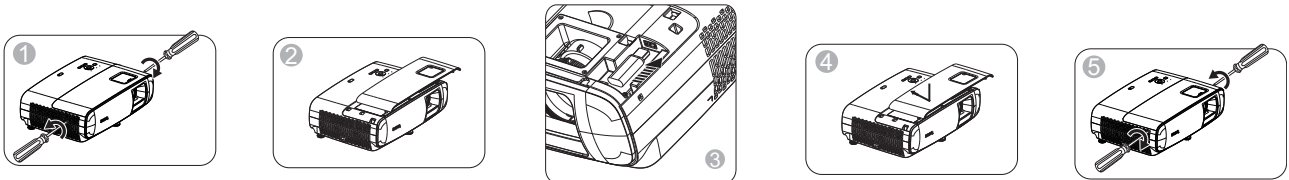





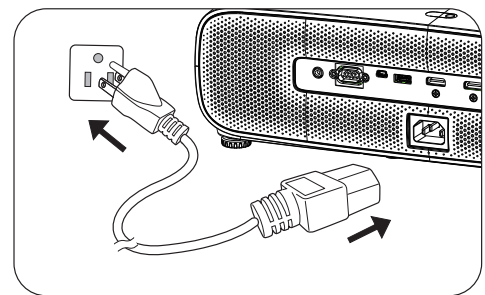

Starting up the projector

1. Plug the power cord. Turn on the power outlet switch (where fitted). The power indicator on the projector lights orange after power has been applied.
2. Plug the USB wireless dongle. It is highly recommended to plug it into the hidden dongle port located under the lamp cover. If not, the 2 USB ports in the rear view also support USB wireless dongle.
3. Press  on the projector or remote control to start the projector. The power indicator flashes green and stays green when the projector is on.



The start up procedure takes about 30 seconds. In the later stage of start up, a startup logo is projected.

(If necessary) Rotate the focus ring to adjust the image clearness.

4. If this is the first time you turn on the projector, the setup wizard appears to guide you through setting up the projector. If you have already done this, skip this step and move on to the next step.
 - Use the arrow keys (///) on the projector or remote control to move through the menu items.
 - Use **OK** to confirm the selected menu item.
 - Use  **Back** to return to the previous menu.
 - Use  **Android Menu** on remote control to skip a menu.

Step 1:

Select **Projector installation**.

For more information about projector position, see [Choosing a location](#).



Step 2:

Select **Language**.



Step 3:

Configure the **Remote Control Pairing**

Press **Home** and **Menu** on the remote control at the same time for at least 3 seconds until the LED Indicator is flashing for pairing. If pairing is completed, then the LED Indicator will stop flashing.



Step 4:

Adjust **Vertical Keystone**.



Step 5:

Configure the **Wireless Network Setting** settings by selecting the wireless network and entering the password.



To connect to a hidden wireless network select **Add New Network** and enter the **SSID**, security setting, and password for the network.

Step 6:
Select **Time Zone**.





Step 7:
Read **Privacy Policy** and press **OK**.
You've completed the setup wizard; you may now connect a device to the projector to project video. See [Connection on page 22](#) for more information.



- ! Please use the original accessories (e.g. power cord) to avoid possible dangers such as electric shock and fire.
- ! If the projector is still hot from previous activity, it will run the cooling fan for approximately 90 seconds before energizing the lamp.
- ✎ The Setup Wizard screenshots are for reference only and may differ from the actual design.
- ✎ If the frequency/resolution of the input signal exceeds the projector's operating range, you will see the message "Out of Range" displayed on the background screen. Please change to an input signal which is compatible with the projector's resolution or set the input signal to a lower setting. See [Timing chart on page 55](#).

Shutting down the projector

1. Press  and a confirmation message will appear prompting you. If you don't respond in a few seconds, the message will disappear.
2. Press  a second time. The power indicator flashes orange, the projection lamp shuts down, and the fans will continue to run for approximately 90 seconds to cool down the projector.
3. Once the cooling process finishes, the power indicator becomes a steady orange and fans stop. Disconnect the power cord from the power outlet.

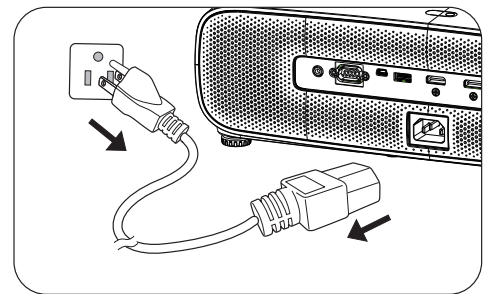

- ✎ To protect the lamp, the projector will not respond to any commands during the cooling process.
- ✎ Avoid turning on the projector immediately after turning it off as excessive heat may shorten lamp life.
- ✎ Lamp life results will vary depending on environmental conditions and usage.