

DLP® Projector

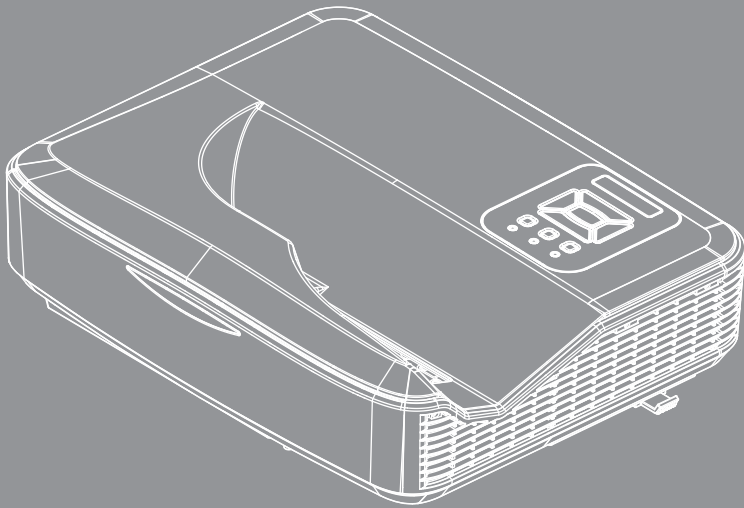



Table of Contents

Table of Contents	2	Multimedia	44
Usage Notice	3	<i>Accessing Multimedia Files</i>	44
<i>Safety Information</i>	3	<i>How to access Multimedia mode</i>	44
<i>Precautions</i>	4	Appendices	62
Introduction	6	<i>Installing and Cleaning the Optional</i>	
<i>Package Overview</i>	6	<i>Dust Filter</i>	62
<i>Product Overview</i>	7	<i>MMA Support List</i>	63
<i>Main Unit</i>	7	<i>Compatibility Modes</i>	68
<i>Control Panel</i>	8	<i>VGA Analog</i>	68
<i>Input/Output Connections</i>	9	<i>HDMI Digital</i>	70
<i>Remote Control</i>	10	<i>RS232 Protocol Function List</i>	72
Installation	11	<i>Regulation & Safety Notices</i>	74
<i>Connecting the Projector</i>	11	<i>Ceiling Mount Installation</i>	77
<i>Connect to Computer/Notebook</i>	11		
<i>Connect to Video Sources</i>	12		
<i>Powering the Projector On / Off</i>	13		
<i>Powering On the Projector</i>	13		
<i>Powering Off the Projector</i>	14		
<i>Warning Indicator</i>	14		
<i>Adjusting the Projected Image</i>	15		
<i>Adjusting the Projector's Height</i>	15		
<i>Adjusting the Projector's Focus</i>	16		
<i>Adjusting Projection Image Size</i>			
<i>(Diagonal)</i>	17		
User Controls	19		
<i>Control Panel & Remote Control</i>	19		
<i>Control Panel</i>	19		
<i>Remote Control</i>	20		
<i>IR Remote codes</i>	22		
<i>Structure</i>	23		
<i>On-screen Display Menus</i>	23		
<i>How to operate</i>	26		
<i>Picture</i>	27		
<i>Screen</i>	29		
<i>Setting</i>	31		
<i>Volume</i>	33		
<i>Options</i>	34		
<i>Options Laser Settings</i>	36		
<i>3D</i>	37		
<i>LAN</i>	38		

Usage Notice

Safety Information

	The lightning flash with arrow head within an equilateral triangle is intended to alert the user to the presence of uninsulated "dangerous voltage" within the product's enclosure that may be of sufficient magnitude to constitute a risk of electric shock to persons.
	The exclamation point within an equilateral triangle is intended to alert the user to the presence of important operating and maintenance (servicing) instructions in the literature accompanying the appliance.

WARNING: TO REDUCE THE RISK OF FIRE OR ELECTRIC SHOCK, DO NOT EXPOSE THIS APPLIANCE TO RAIN OR MOISTURE. DANGEROUS HIGH VOLTAGES ARE PRESENT INSIDE THE ENCLOSURE. DO NOT OPEN THE CABINET. REFER SERVICING TO QUALIFIED PERSONNEL ONLY.

Class B emissions limits

This Class B digital apparatus meets all requirements of the Canadian Interference-Causing Equipment Regulations.

Important Safety Instruction

1. Do not block any ventilation openings. To ensure reliable operation of the projector and to protect from over heating, it is recommended to install the projector in a location that does not block ventilation. As an example, do not place the projector on a crowded coffee table, sofa, bed, etc. Do not put the projector in an enclosure such as a book case or a cabinet that restricts air flow.
2. Do not use the projector near water or moisture. To reduce the risk of fire and/or electric shock, do not expose the projector to rain or moisture.
3. Do not install near heat sources such as radiators, heaters, stoves or any other apparatus such as amplifiers that emits heat.
4. Clean only with dry cloth.
5. Only use attachments/accessories specified by the manufacturer.
6. Do not use the unit if it has been physically damaged or abused.
Physical damage/abuse would be (but not limited to):
 - Unit has been dropped.
 - Power supply cord or plug has been damaged.
 - Liquid has been spilled on to the projector.
 - Projector has been exposed to rain or moisture.
 - Something has fallen in the projector or something is loose inside.Do not attempt to service the unit yourself. Opening or removing covers may expose you to dangerous voltages or other hazards.
7. Do not let objects or liquids enter the projector. They may touch dangerous voltage points and short out parts that could result in fire or electric shock.
8. See projector enclosure for safety related markings.
9. The unit should only be repaired by appropriate service personnel.

Usage Notice

Precautions



Please follow all warnings, precautions and maintenance as recommended in this user's guide.

- Warning- Do not look into the projector's lens when the lamp is on. The bright light may hurt and damage your eyes.

- Warning- To reduce the risk of fire or electric shock, do not expose this projector to rain or moisture.

- Warning- Please do not open or disassemble the projector as this may cause electric shock.

Usage Notice

Do:

- ❖ Turn off and unplug the power plug from the AC outlet before cleaning the product.
- ❖ Use a soft dry cloth with mild detergent to clean the display housing.
- ❖ Disconnect the power plug from AC outlet if the product is not being used for a long period of time.

Do not:

- ❖ Block the slots and openings on the unit provided for ventilation.
- ❖ Use abrasive cleaners, waxes or solvents to clean the unit.
- ❖ Use under the following conditions:
 - In extremely hot, cold or humid environments.
 - ▶ Sea level to 6000 feet
Extremely hot: > 35°C
Extremely cool: < 5°C
 - ▶ 6000 feet above
Extremely hot: > 30°C
Extremely cool: < 5°C
 - ▶ Extremely humid: > 70% R.H. (Relative Humidity)
 - In areas susceptible to excessive dust and dirt.
 - Near any appliance generating a strong magnetic field.
 - In direct sunlight.

Introduction

Package Overview

Unpack and inspect the box contents to ensure all parts listed below are in the box. If something is missing, please contact your nearest customer service center.

Standard Accessories

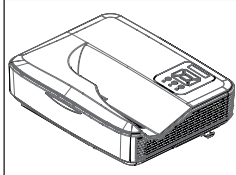

Projector

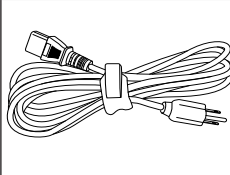

Power Cord

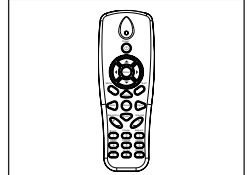

Remote



- ❖ Optional accessories vary depending on model, specification and region.
- ❖ For other laser curtain accessories, please refer to the laser curtain user manual.
- ❖ *For European warranty information please visit www.optoma-europe.com

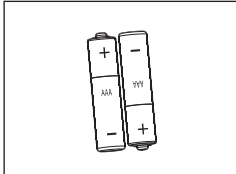

2 AAA Batteries

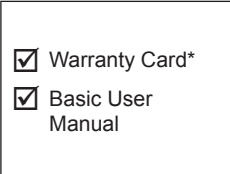

- Warranty Card*
- Basic User Manual

Documentation

Optional Accessories

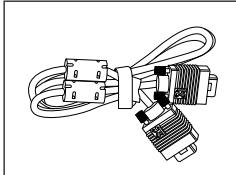

VGA Cable

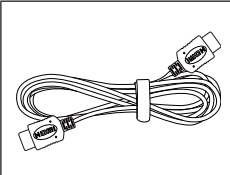

HDMI Cable

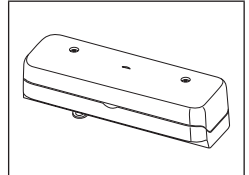

Laser Curtain Module

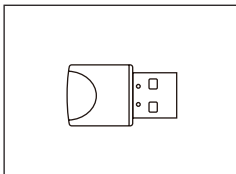

Wifi Dongle

Product Overview

Main Unit

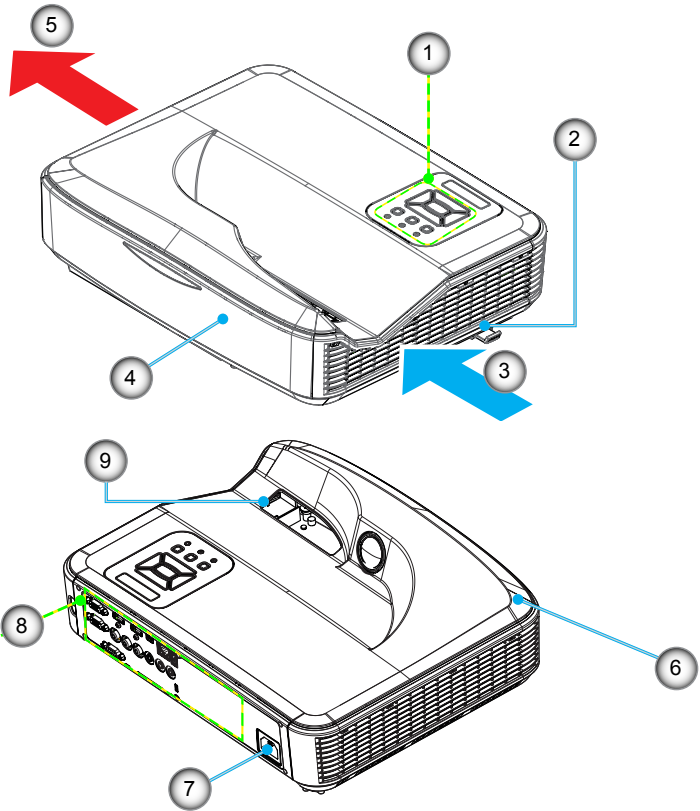

- ❖ The interface is subject to model's specifications.
- ❖ Do not block projector in/out air vents and keep a minimum 30cm distance.

- | | |
|-------------------------|-------------------------------|
| 1. Control Panel | 6. Speaker |
| 2. Focus Switch | 7. Power Socket |
| 3. Ventilation (inlet) | 8. Input / Output Connections |
| 4. IR Receiver | 9. Lens |
| 5. Ventilation (outlet) | |

Introduction

Control Panel

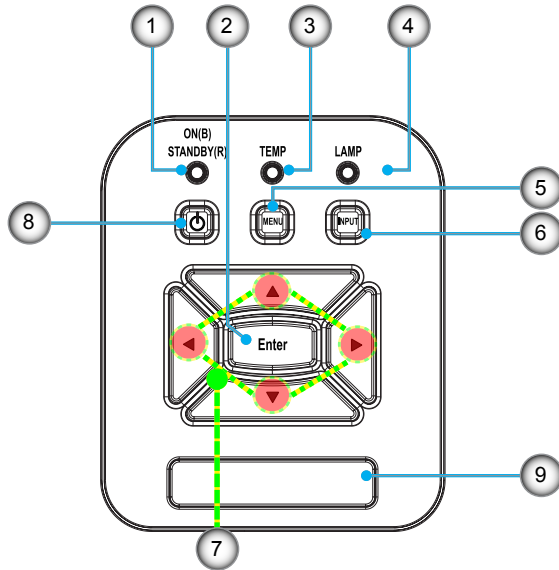

1. Power LED
2. Enter
3. Temp LED
4. Lamp LED
5. Menu
6. Input
7. Four Directional Select Keys
8. Power/Standby button
9. IR Receiver

Input/Output Connections

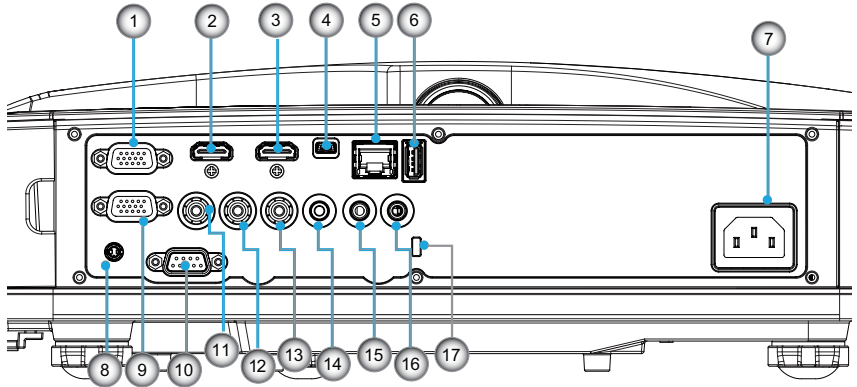

❖ The interface is subject to model's specifications.



❖ Monitor loop through only support in VGA1-In/YPbPr.

1. VGA1-In/YPbPr Connector
(PC Analog Signal/Component Video Input/HDTV/YPbPr)
2. HDMI2 Input Connector
3. HDMI1 Input Connector
4. USB Connector (Connect to PC for Remote Mouse function)
5. RJ45 connector
6. USB Type A Connector
7. Power Socket
8. Interactive connector (3.5mm mini-jack, depending on Model)
9. VGA-Out/VGA2-In Connector
10. RS-232 Connector (9-pin DIN Type)
11. Composite Video Input Connector
12. Composite Audio Input (right) Connector
13. Composite Audio Input (left) Connector
14. Audio Output Connector (3.5mm mini jack)
15. Audio Input Connector (3.5mm mini jack)
16. Audio Input Connector (microphone)
17. Kensington™ Lock Port

Introduction

Remote Control

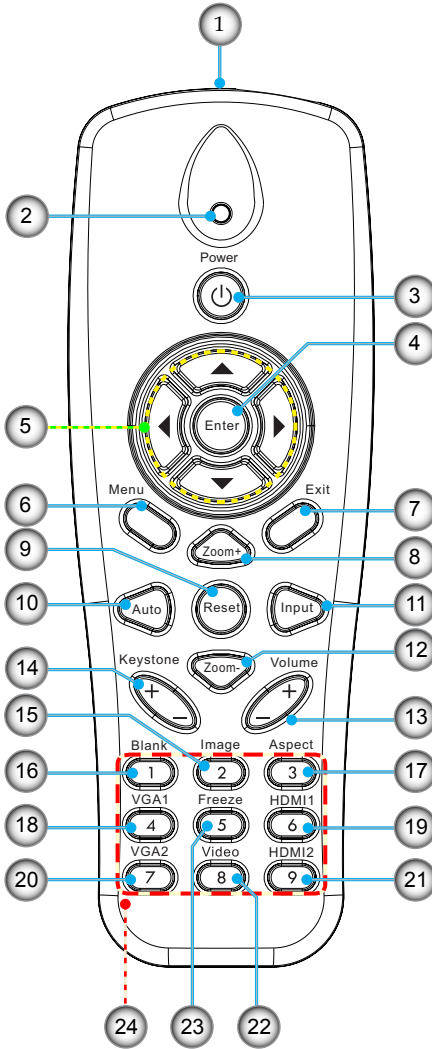

1. Infrared transmitter
2. LED Indicator
3. Power On/Off
4. OK
5. Four Directional Select Keys
6. Menu
7. Exit
8. Zoom in
9. Reset
10. Auto
11. Source
12. Zoom out
13. Volume +/-
14. Keystone +/-
15. Image
16. Black screen
17. Aspect ratio
18. VGA1
19. HDMI1
20. VGA2
21. HDMI2
22. Video
23. Screen freeze
24. Numbered keypad (for password input)



❖ Some keys may have not function for models which do not support these features.

Connecting the Projector Connect to Computer/Notebook

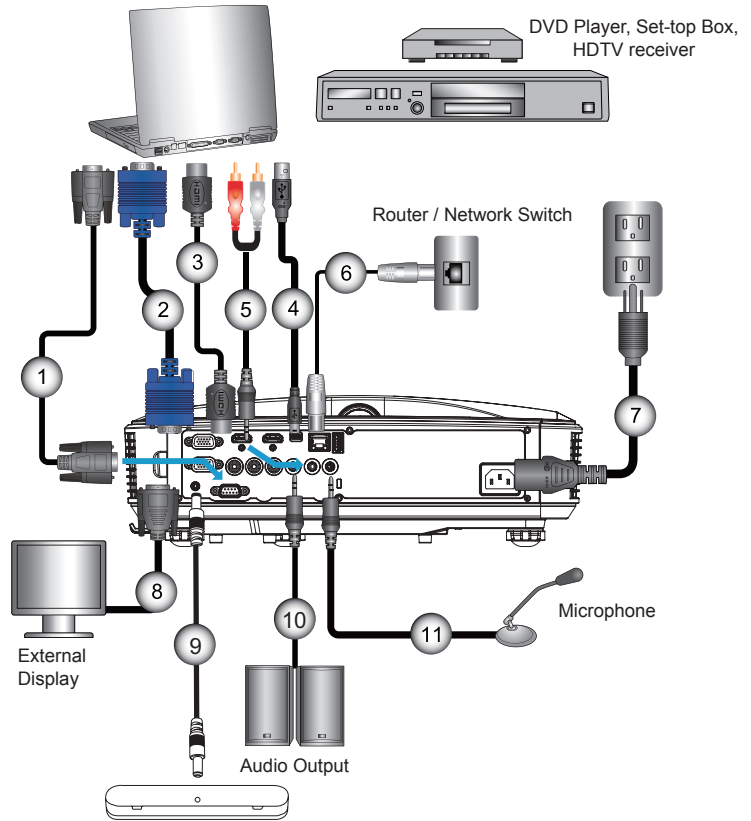

- ❖ Due to the difference in applications for each country, some regions may have different accessories.
- ❖ (*) Optional accessory

1.....	*RS232 Cable
2.....	*VGA Cable
3.....	*HDMI Cable
4.....	*USB Cable
5.....	*Audio Cable/RCA
6.....	*RJ45 Cable
7.....	Power Cord
8.....	*VGA Output Cable
9.....	Interactive Cable
10.....	*Audio Output Cable
11.....	*Microphone Input Cable

Installation

Connect to Video Sources

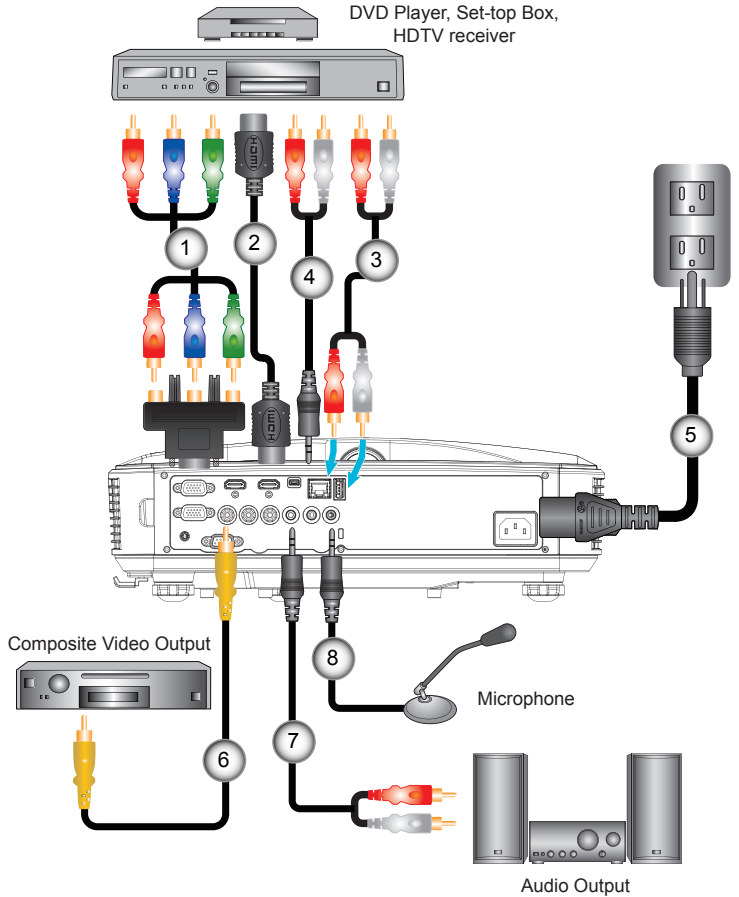

Powering the Projector On / Off

Powering On the Projector

1. Securely connect the power cord and signal cable. When connected, the POWER/STANDBY LED will turn Orange.
2. Turn on the lamp by pressing “” button either on the projector or on the remote. At this moment, the POWER/STANDBY LED will now turn Blue. **1**

The startup screen will display in approximately 10 seconds. The first time you use the projector, you will be asked to select the preferred language and power saving mode.

3. Turn on and connect the source that you want to display on the screen (computer, notebook, video player, etc). The projector will detect the source automatically. If not, push menu button and go to “OPTIONS”.
Make sure that the “Source Lock” has been set to “Off”.

- ❖ If you connect multiple sources at the same time, press the “INPUT” button on the control panel or direct source keys on the remote control to switch between inputs.



❖ When the power mode is in standby mode (power consumption < 0.5W), the VGA output/ input and audio will be deactivated when the projector is in standby.



❖ Turn on the projector first and then select the signal sources.

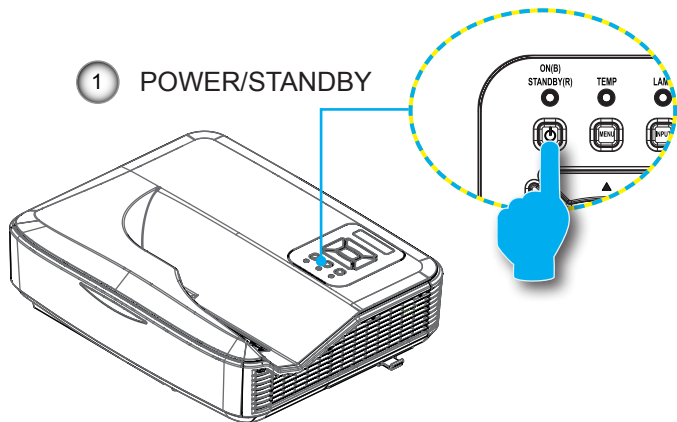



Installation

Powering Off the Projector

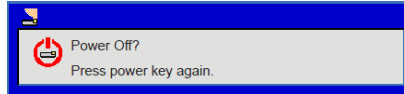
1. Press the “” button on the remote control or on the control panel to turn off the projector. The following message will be displayed on the screen.



Press the “” button again to confirm otherwise the message will disappear after 10 seconds. When you press the “” button for the second time, the fan will start cooling the system and will shut down.

2. The cooling fans continue to operate for about 4 seconds for cooling cycle and the POWER/STANDBY LED will flash Orange. When the POWER/STANDBY LED lights solid Orange, the projector has entered standby mode.

If you wish to turn the projector back on, you must wait until the projector has completed the cooling cycle and has entered standby mode. Once in standby mode, simply press “” button to restart the projector.

3. Disconnect the power cord from the electrical outlet and the projector.

Warning Indicator



❖ Contact the nearest service center if the projector displays these symptoms.

When the warning indicators (see below) come on, the projector will automatically shutdown:

- ❖ “LAMP” LED indicator is lit red and if “POWER/STANDBY” indicator flashes amber.
- ❖ “TEMP” LED indicator is lit red, this indicates the projector has overheated. Under normal conditions, the projector can be switched back on.
- ❖ “TEMP” LED indicator flashes red and if “POWER/STANDBY” indicator flashes amber.

Unplug the power cord from the projector, wait for 30 seconds and try again. If the warning indicator light up again, please contact your nearest service center for assistance.

Adjusting the Projected Image

Adjusting the Projector's Height

The projector is equipped with elevator feet for adjusting the image height.

1. Locate the adjustable foot you wish to modify on the underside of the projector.
2. Rotate the adjustable ring clockwise to raise the projector or counter clockwise to lower it. Repeat with the remaining feet as needed.

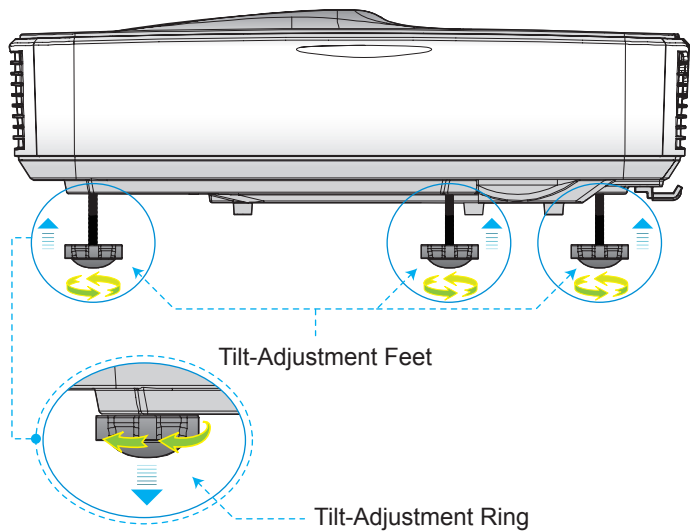

Installation

Adjusting the Projector's Focus

To focus the image, slide the focus switch to left/right until the image is clear.

- ▶ 1080p series: The projector will focus at distances from 1.443 to 1.887 feet (0.437 to 0.572 meters).
- ▶ WXGA series: The projector will focus at distances (lens to wall) from 1.59~2.16 feet (0.49~0.66 meters)

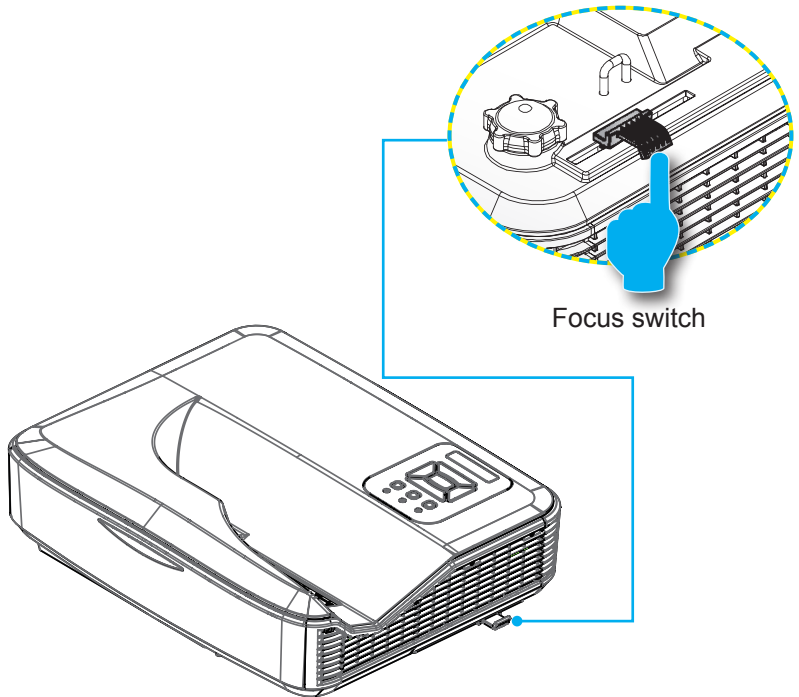

Installation

Adjusting Projection Image Size (Diagonal)

- ▶ 1080p series: Projection Image Size from 80" to 100" (2.03 to 2.54 meters).
- ▶ WXGA series: The projector will focus at distances (lens to wall) from 1.59~2.16 feet (0.49~0.66 meters)

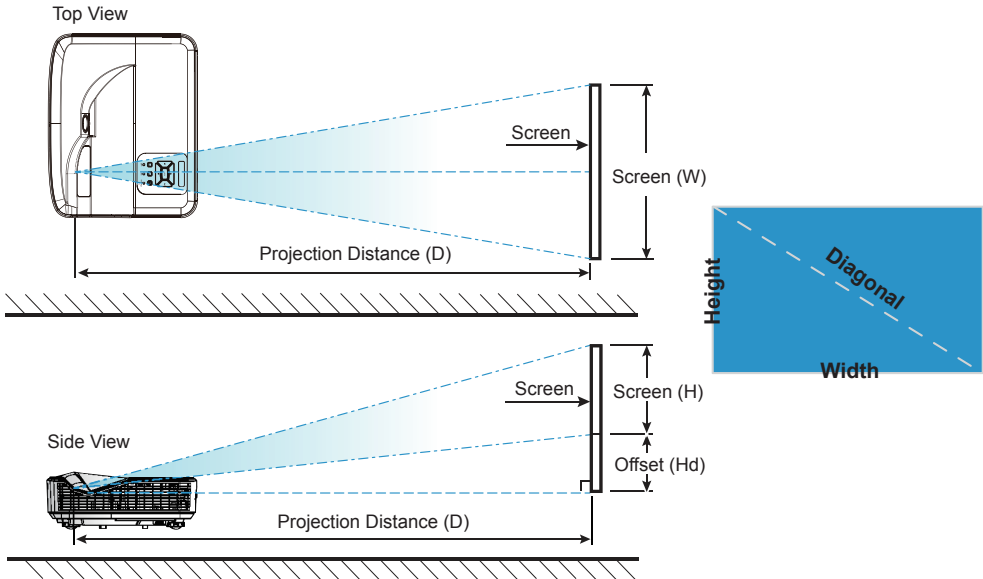

1080P (16:9) Wall mount installation measurement chart

Diagonal image size (S) in inch	Diagonal image size (S) in mm	Image width (W) in mm	Image height (H) in mm	Distance from surface of whiteboard to center of projector mount (T) in mm	Distance from surface of whiteboard to back of projector (T1) in mm	Distance from top of image to top of wall plate (O) in mm	Distance from top of image to top of interface boss (O1) in mm	Distance from top of image to top of projector (O2) in mm
87	2210	1926	1083	370	233	364	288	268
88	2235	1948	1096	376	239	367	291	271
89	2261	1970	1108	382	245	370	294	274
90	2286	1992	1121	387	250	372	296	276
91	2311	2015	1133	393	256	375	299	279
92	2337	2037	1146	398	261	377	301	281
93	2362	2059	1158	404	267	380	304	284
94	2388	2081	1171	409	272	383	307	287
95	2413	2103	1183	415	278	385	309	289
96	2438	2125	1196	421	284	388	312	292
97	2464	2147	1208	426	289	390	314	294

Installation

1080P (16:9) Wall mount installation measurement chart								
Diagonal image size (S) in inch	Diagonal image size (S) in mm	Image width (W) in mm	Image height (H) in mm	Distance from surface of whiteboard to center of projector mount (T) in mm	Distance from surface of whiteboard to back of projector (T1) in mm	Distance from top of image to top of wall plate (O) in mm	Distance from top of image to top of interface boss (O1) in mm	Distance from top of image to top of projector (O2) in mm
98	2489	2170	1220	432	295	393	317	297
99	2515	2192	1233	437	300	396	320	300
100	2540	2214	1245	443	306	398	322	302
101	2565	2236	1258	448	311	401	325	305
102	2591	2258	1270	454	317	403	327	307

WXGA (16:10) Wall mount installation measurement chart								
Diagonal image size (S) in inch	Diagonal image size (S) in mm	Image width (W) in mm	Image height (H) in mm	Distance from surface of whiteboard to center of projector mount (T) in mm	Distance from surface of whiteboard to back of projector (T1) in mm	Distance from top of image to top of wall plate (O) in mm	Distance from top of image to top of interface boss (O1) in mm	Distance from top of image to top of projector (O2) in mm
85	2159	1831	1144	370	233	342	266	246
86	2184	1852	1158	376	239	344	268	248
87	2210	1874	1171	382	245	346	270	250
88	2235	1895	1185	387	250	349	273	253
89	2261	1917	1198	393	256	351	275	255
90	2286	1939	1212	399	262	353	277	257
91	2311	1960	1225	404	267	356	280	260
92	2337	1982	1239	410	273	358	282	262
93	2362	2003	1252	416	279	361	285	265
94	2388	2025	1265	422	285	363	287	267
95	2413	2046	1279	427	290	365	289	269
96	2438	2068	1292	433	296	368	292	272
97	2464	2089	1306	439	302	370	294	274
98	2489	2111	1319	444	307	373	297	277
99	2515	2132	1333	450	313	375	299	279
100	2540	2154	1346	456	319	377	301	281
101	2565	2175	1360	461	324	380	304	284
102	2591	2197	1373	467	330	382	306	286
103	2616	2219	1387	473	336	384	308	288
104	2642	2240	1400	479	342	387	311	291
105	2667	2262	1414	484	347	389	313	293
106	2692	2283	1427	490	353	392	316	296
107	2718	2305	1440	496	359	394	318	298
108	2743	2326	1454	501	364	396	320	300
109	2769	2348	1467	507	370	399	323	303
110	2794	2369	1481	513	376	401	325	305
111	2819	2391	1494	519	382	403	327	307
112	2845	2412	1508	524	387	406	330	310
113	2870	2434	1521	530	393	408	332	312
114	2896	2455	1535	536	399	411	335	315
115	2921	2477	1548	541	404	413	337	317

❖ This table is for user's reference only.

User Controls

Control Panel & Remote Control

Control Panel

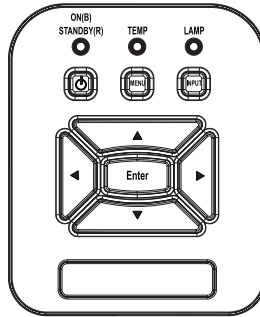

Using the Control Panel

POWER		Refer to the “Power On/Off the Projector” section on pages 13-14.
Enter		Press “Enter” to confirm your item selection.
INPUT		Press “INPUT” to select an input signal.
MENU		Press “MENU” to launch the on-screen display (OSD) menu. To exit OSD, press “MENU” again.
Four Directional Select Keys		Use ▲▼◀▶ to select items or make adjustments to your selection.
LAMP LED		Refer to the LED indicator of the projector light source status.
TEMP LED		Refer to the LED indicator of the projector temperature status.
ON/STANDBY LED		Refer to the LED indicator of the projector power status.

User Controls

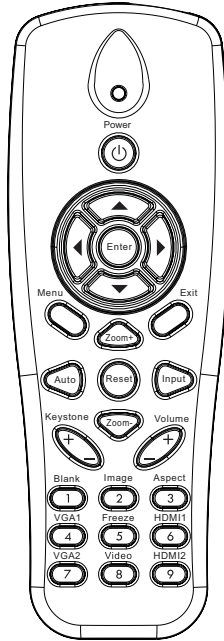

Remote Control

Using the Remote Control

Infrared transmitter	Sends signals to the projector.
LED	LED Indicator.
Power 	Refer to the “Power On/Off the Projector” section on pages 15-16.
Exit	Press “Exit” to close the OSD menu.
Zoom in	Zoom in the projector display.
Reset	Return the adjustments and settings to the factory default values. (except for lamp counter)
Zoom out	Zoom out the projector display.
Enter	Confirm your item selection.
Source	Press “Source” to select an input signal.
Auto	Automatically synchronizes the projector to the input source.
Four Directional Select Keys	Use ▲ ▼ ◀ ▶ to select items or make adjustments to your selection.
Keystone +/-	Adjust image distortion caused by tilting the projector.
Volume +/-	Adjust to increase / decrease the volume.
Aspect ratio	Use this function to choose your desired aspect ratio.
Menu	Press “Menu” to launch the on-screen display (OSD) menu. To exit OSD, press “Menu” again.

User Controls

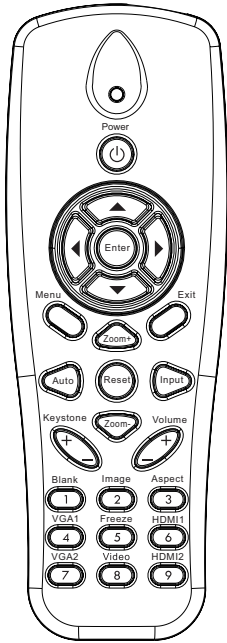

Using the Remote Control

VGA1	Press "VGA1" to choose VGA IN 1 connector.
Blank screen	Momentarily turns off/on the audio and video.
HDMI1	Press "HDMI1" to choose HDMI IN 1 connector.
HDMI2	Press "HDMI2" to choose HDMI IN 2 connector.
VGA2	Press "VGA2" to choose VGA IN 2 connector.
Video	Press "Video" to choose Composite video source.
Screen freeze	Pause the screen image. Press again to resume the screen image.
Image	Select the display mode from Bright, PC, Movie, Game, and User.

User Controls

IR Remote codes

key legend	NEC_CODE			
	Custom Code		Data	
	Byte1	Byte2	Byte3	Byte4
Power	FF	FF	E8	17
Up	FF	FF	E7	18
Left	FF	FF	E6	19
Enter	FF	FF	F8	7
4	FF	FF	F7	8
Down	FF	FF	F6	9
Menu	FF	FF	EB	14
Zoom+	FF	FF	FB	4
Exit	FF	FF	FF	0
Auto	FF	FF	FA	5
Reset	FF	FF	EA	15
Input	FF	FF	E0	1F
Zoom-	FF	FF	FE	1
Keystone+	FF	FF	F0	0F
Keystone -	FF	FF	E2	1D
Volume-	FF	FF	F2	0D
Volume+	FF	FF	BD	42
Blank/1	FF	FF	BE	41
Image/2	FF	FF	F3	0C
Aspect/3	FF	FF	E3	1C
VGA1 /4	FF	FF	BF	40
Freeze/5	FF	FF	EC	13
HDMI1/6	FF	FF	E5	1A
VGA2 /7	FF	FF	E4	1B
HDMI2 /8	FF	FF	EF	10
S-Video /9	FF	FF	E1	1E

User Controls

On-screen Display Menus

The Projector has multilingual On-screen Display menus that allow you to make image adjustments and change a variety of settings.

Structure

Note: Please note that the on-screen display (OSD) menus vary according to the signal type selected and the projector model you are using.

Main Menu	Sub Menu	Setting	
Picture	Color Mode		Bright/PC/Movie/Game/Blending./User (Change Color Mode to User Mode if customer changes the settings)
	Wall Color		White/ Light Yellow/ Light Blue/ Pink/ Dark Green
	Brightness		
	Contrast		
	Sharpness		
	Saturation		
	Hue		
	Gamma		
	Color Temp		
	Color Matching	White/Red/ Green/Blue/Cyan/ Magenta/Yellow	Hue/ Saturation /Gain
Screen	Aspect Ratio		Auto/4:3/16:9/16:10
	Phase		
	Clock		
	H.Position		
	V.Position		
	Digital Zoom		
	Orientation		Front/Front Ceiling/Rear/Rear Ceiling
	Size		

User Controls

Settings	Language		English/German/French/Italian/Spanish/ Polish/Swedish/Dutch/Portugese/Japanese/ Traditional Chinese/ Simplified Chinese/ Korean/Russian/Arabic/Norsk/Turkish/Danish	
	Menu Location		Left Top, Right Top, Center, Left Bottom, Right Bottom	
	Closed Caption		Off/CC1/CC2/CC3/CC4	
	VGA OUT (Standby)		Off/On	
	LAN (Standby)		Off/On	
	VGA-2 (Function)	Inout/Output		
	Test Pattern		Off/On	
	Reset to Default		Yes/No	
Volume	Speaker		On/Off	
	Line Out		On/Off	
	Microphone		On/Off	
	Mute		On/Off	
	Volume			
	Microphone Volume			
Options	Logo		Default/User	
	Logo Capture			
	Auto Source		On/Off	
	Input		VGA-1, VGA-2, HDMI-1, HDMI-2, Video, MULTIMEDIA	
	Auto Power Off (Min.)			
	SSI Settings			SSI Hours Used (Normal)
				SSI Hours Used (ECO)
		SSI Power Mode		Normal, ECO
	High Altitude	On/Off		
	Filter Settings	Filter Reminder		
Cleaning Up Reminder			Yes/No	

User Controls

Options	Information		Model Name
			SNID
			Source
			Resolution
			SW Version
			Aspect Ratio
3D	3D		Off/On
	3D Invert		On/Off
	3D Format		Frame Packing
			Side-by-Side (Half)
			Top and Bottom
			Frame Sequential
		Field Sequential	
1080p @ 24		96Hz/144Hz	
Interactive	Interactive Setting		On/Off(interactive SKU only)
Network	Status		
	DHCP Client		On/Off
	IP Address		
	Subnet Mask		
	Gateway		
	DNS		
	MAC Address		
	Group Name		
	Projector Name		
	Location		
	Contact		

User Controls

How to operate

1. To open the OSD menu, press “Menu” on the Remote Control or Projector Keypad.
2. When OSD is displayed, use the ▲▼ keys to select any item in the main menu. While making a selection on a particular page, press the ► or “Enter” key to enter sub menu.
3. Use the ▲▼ keys to select the desired item and adjust the settings using the ◀▶ key.
4. Select the next item to be adjusted in the sub menu and adjust as described above.
5. Press “Enter” to confirm, and the screen will return to the main menu.
6. To exit, press “Menu” again. The OSD menu will close and the projector will automatically save the new settings.

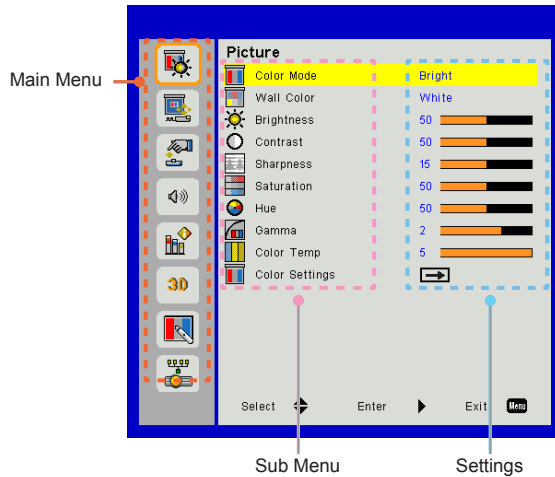

Picture

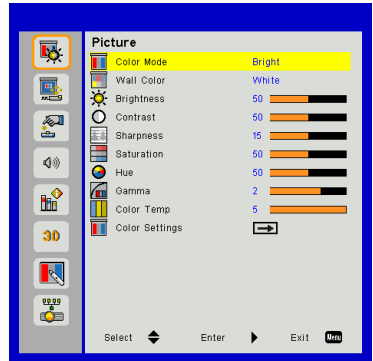

Color Mode

There are many factory presets optimized for various types of images. Use the ◀ or ▶ button to select the item.

- ▶ Bright: For brightness optimization.
- ▶ PC: For meeting presentation.
- ▶ Movie: For playing video content.
- ▶ Game: For game content.
- ▶ User: Memorize user's settings.
- ▶ Blending: For Blending application.

Wall Color

Use this function to obtain an optimized screen image according to the wall color. You can select from "White", "Light Yellow", "Light Blue", "Pink", and "Dark Green".

Brightness

Adjust the brightness of the image.

- ▶ Press the ◀ button to darken image.
- ▶ Press the ▶ button to brighten image.

Contrast

The Contrast controls the difference between the lightest and darkest parts of the picture. Adjusting the contrast changes the amount of black and white in the image.

- ▶ Press the ◀ button to decrease the contrast.
- ▶ Press the ▶ button to increase the contrast.

User Controls



- ❖ “Sharpness”, “Saturation” and “Hue” functions are only supported under video mode.

Sharpness

Adjust the sharpness of the image.

- ▶ Press the ◀ button to decrease the sharpness.
- ▶ Press the ▶ button to increase the sharpness.

Saturation

Adjust a video image from black and white to fully saturated color.

- ▶ Press the ◀ button to decrease the amount of saturation in the image.
- ▶ Press the ▶ button to increase the amount of saturation in the image.

Hue

Adjust the color balance of red and green.

- ▶ Press the ◀ button to increase the amount of green in the image.
- ▶ Press the ▶ button to increase the amount of red in the image.

Gamma

This allows you to adjust the gamma value to obtain the better image contrast for the input.

Color Temp

This allows you to adjust the color temperature. At higher temperature, the screen looks colder; at lower temperature, the screen looks warmer.

Color Settings

Use these settings for advanced adjustment of the individual Red, Green, Blue, Cyan, Magenta and Yellow Colors.

Screen



Aspect Ratio

- ▶ Auto: Keep the image with original width-height ratio and maximize the image to fit native horizontal or vertical pixels.
- ▶ 4:3: The image will be scaled to fit the screen and displayed using a 4:3 ratio.
- ▶ 16:9: The image will be scaled to fit the width of the screen and the height adjusted to display the image using a 16:9 ratio.
- ▶ 16:10: The image will be scaled to fit the width of the screen and the height adjusted to display the image using a 16:10 ratio.



- ❖ “H. Position” and “V. Position” ranges will depend on input source.

Phase

Synchronize the signal timing of the display with the graphic card. If the image appears to be unstable or flickers, use this function to correct it.

Clock

Adjust to achieve an optimal image when there is a vertical flicker in the image.

H. Position

- ▶ Press the ◀ button to move the image left.
- ▶ Press the ▶ button to move the image right.

User Controls

V. Position

- ▶ Press the ◀ button to move the image down.
- ▶ Press the ▶ button to move the image up.

Digital Zoom

- ▶ Press the ◀ button to reduce the size of an image.
- ▶ Press the ▶ button to magnify an image on the projection screen.

V Keystone

Press the ◀ or ▶ button to adjust image distortion vertically. If the image looks trapezoidal, this option can help make the image rectangular.

Orientation

- ▶ Front: The image is projected straight on the screen.
- ▶ Front Ceiling: This is the default selection. When selected, the image will turn upside down.
- ▶ Rear: When selected, the image will appear reversed.
- ▶ Rear Ceiling: When selected, the image will appear reversed in upside down position.

User Controls

Setting



Language

Choose the multilingual OSD menu. Press the ◀ or ▶ button into the sub menu and then use the ▲ or ▼ button to select your preferred language. Press ▶ on the remote control to finalize the selection.



Menu Location

Choose the menu location on the display screen.

Closed Caption

Use this function to enable close caption menu. Select an appropriate closed captions option: Off, CC1, CC2, CC3, and CC4.

VGA Output (Standby)

Choose "On" to enable VGA OUT connection.

User Controls

LAN (Standby)

Choose “On” to enable LAN connection. Choose “Off” to disable LAN connection.

VGA B (Function)

- ▶ Input: Choose “Input” to let the VGA port works as a VGA input function.
- ▶ Output: Choose “Output” to enable the VGA Out function once the projector is powered on.

Test Pattern

Display a test pattern.

Reset

Choose “Yes” to return the parameters on all menus to the factory default settings.

Volume



Speaker

- ▶ Choose "On" to enable the speaker.
- ▶ Choose "Off" to disable the speaker.

Line Out

- ▶ Choose "On" to enable the line out function.
- ▶ Choose "Off" to disable the line out function.

Microphone

- ▶ Choose "On" to enable the microphone.
- ▶ Choose "Off" to disable the microphone.

Mute

- ▶ Choose "On" to turn mute on.
- ▶ Choose "Off" to turn mute off.

Volume

- ▶ Press the ◀ button to decrease the volume.
- ▶ Press the ▶ button to increase the volume.

Microphone Volume

- ▶ Press the ◀ button to decrease the microphone volume.
- ▶ Press the ▶ button to increase the microphone volume.

User Controls

Options

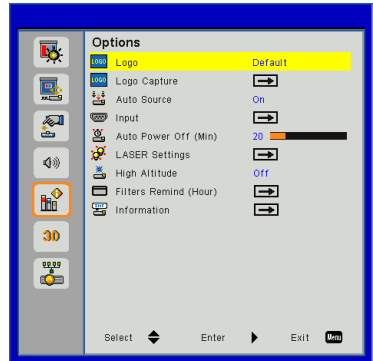

Logo

Use this function to set the desired startup screen. If changes are made they will take effect the next time the projector is powered on.

- ▶ Default: The default startup screen.
- ▶ User: Use stored picture from “Logo Capture” function.



- ❖ For successful logo capture, please ensure that the on-screen image does not exceed the projector's native resolution. (WXGA:1280x800).
- ❖ “Logo Capture” is not available when 3D is enabled.
- ❖ Before active this function, it is recommended that “Aspect Ratio” is set to the “Auto”.
- ❖ When auto source is ON the system will search Multimedia source if user had ever chosen multimedia source or it will skip multimedia source.

Logo Capture

Press ▶ button to capture an image of the picture currently displayed on screen.

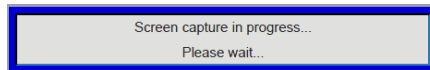

Auto Source

- ▶ On: The projector will search for other signals if the current input signal is lost.
- ▶ Off: The projector will only search current input connection.

Input

Press ▶ button to enable/disable input sources. The projector will not search for inputs that are not selected.





- ❖ Dynamic Black™ is available when “Color Mode” is set to “Movie”.
- ❖ When “Dynamic Black” is available, “Laser Power Mode” selection is not available.

Auto Power Off (Min)

Sets the countdown timer interval. The countdown timer will start, when there is no signal being sent to the projector. The projector will automatically power off when the countdown has finished (in minutes).

Laser Settings

Refer to page 32.

High Altitude

- ▶ On: The built-in fans run at high speed. Select this option when using the projector at altitudes above 2500 feet/762 meters or higher.
- ▶ Off: The built-in fans automatically run at a variable speed according to the internal temperature.

Filters Remind (Hour)

- ▶ Filters Remind (Hour): Set the filter reminder time.
- ▶ Cleaning Up Remind: Select “Yes” to reset the dust filter hour counter after replacing or cleaning the dust filter.

Information

Display the projector information for model name, SNID, source, resolution, software version, and aspect ratio on the screen.

User Controls

Options | Laser Settings

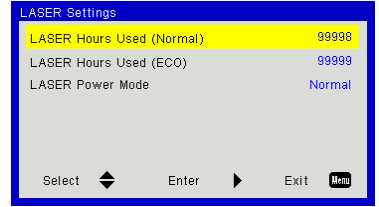

Laser Hours Used (Normal)

Display the projection time of normal mode.

Laser Hours Used (ECO)

Display the projection time of ECO mode.

Laser Power Mode

- ▶ Normal: Normal mode.
- ▶ ECO: Use this function to dim the projector lamp which will lower power consumption and extend the lamp life.

3D



- ❖ “Frame Sequential” is supported the DLP Link 3D input signals from VGA / HDMI connector.
- ❖ “Frame Sequential” / “Field Sequential” are supported the HQFS 3D input signals from Composite/ S-Video connector.
- ❖ “Frame Packing” / “Side-by-Side(Half)” / “Top and Bottom” are supported from HDMI 1.4a 3D input signals.

3D

- ▶ Auto: When a HDMI 1.4a 3D timing identification signal is detected, the 3D image is selected automatically.
- ▶ Choose “On” to enable 3D function.
- ▶ Choose “Auto” to detected 3D signal automatically.

3D Invert

If you see a discrete or overlapping image while wearing DLP 3D glasses, you may need to execute “Invert” to get best match of left/ right image sequence to get the correct image.

3D Format

Use this feature to select the 3D format. Options are: “Frame Packing”, “Side-by-Side (Half)”, “Top and Bottom”, “Frame Sequential”, and “Field Sequential”.

1080p@24

Use this feature to select 96 or 144Hz refresh rate as using 3D glasses in the 1080p @ 24 frame packing.

User Controls

LAN

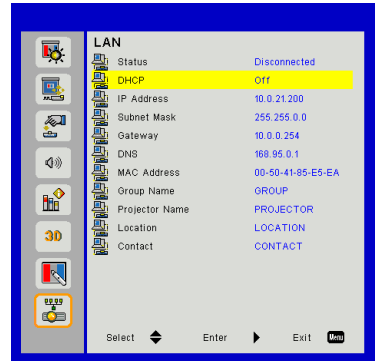

- ❖ IP, Subnet Mask, Gateway, and DNS configuration assignment please access to web control page. How to access web control page please refer to page 36.

Status

Display the network connection status.

DHCP

Configure the DHCP settings.

- ▶ On: Choose “On” to let the projector to obtain an IP address automatically from your network.
- ▶ Off: Choose “Off” to assign IP, Subnet Mask, Gateway, and DNS configuration manually.

IP Address

Display an IP address.

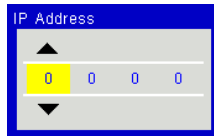

Subnet Mask

Display the subnet mask number.

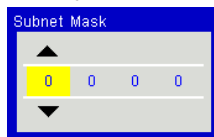

User Controls

Gateway

Display the default gateway of the network connected to the projector.

DNS

Display the DNS number.

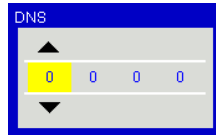

MAC Address

Display the MAC address.

Group Name

Display the group name.

Projector Name

Display the projector name.

Location

Display the projector location.

Contact

Display the contact information.

User Controls

How to use web browser to control your projector

1. Turn on DHCP to allow a DHCP server to automatically assign an IP, or manually enter the required network information.

Status	Connect
DHCP	Off
IP Address	172.16.1.42
Subnet Mask	255.255.255.0
Gateway	172.16.1.254
DNS	172.16.1.1

2. Then choose apply and press **OK** button to complete the configuration process.
3. Open your web browser and type in IP Address from the OSD LAN screen then the web page will display as below:



4. Based on network web-page for the input-string in [tools] tab, the limitation for Input-Length is in the below list ("space" and the other punctuation key included):

Category	Item	Input-Length (characters)
Crestron Control	IP Address	15
	IP ID	2
	Port	5
Projector	Projector Name	10
	Location	9
	Assigned To	9
Network Configuration	DHCP (Enabled)	(N/A)
	IP Address	15
	Subnet Mask	15
	Default Gateway	15
	DNS Server	15
User Password	Enabled	(N/A)
	New Password	15
	Confirm	15
Admin Password	Enabled	(N/A)
	New Password	15
	Confirm	15



- ❖ When you used the projector IP address, you will can not link to your service server.



User Controls

When making a direct connection from your computer to the projector

Step 1: Find an IP Address (192.168.0.100) from LAN function of projector.



Step 2: Select apply and press “Enter” button to submit function or press “menu” key to exit.

Step 3: To open Network Connections, click **Start**, click **Control Panel**, click **Network and Internet Connections**, and then click **Network Connections**. Click the connection you want to configure, and then, under **Network Tasks** , click **Change settings of this connection**.

Step 4: On the **General** tab, under **This connection uses the following items**, click **Internet Protocol (TCP/IP)**, and then click “Properties.”



Step 5: Click **Use the following IP address**, and type in as below:

- 1) IP address: 192.168.0.100
- 2) Subnet mask: 255.255.255.0
- 3) Default gateway: 192.168.0.254

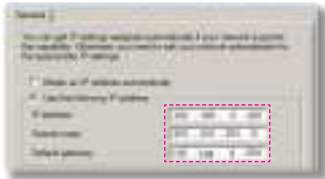

Step 6: To open Internet Options, click IE web browser, click Internet Options, click the **Connections** tab and click “LAN Settings...”.



Step 7: The **Local Area Network (LAN) Setting** dialog box appears. In the **Proxy Server** area, cancel the **Use a proxy server for your LAN** check box, then click “OK” button twice.

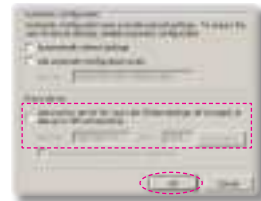

Step 8: Open your IE and type in the IP address of 192.168.0.100 in the URL then press “Enter” key.

User Controls

Crestron RoomView Control Tool

Crestron RoomView™ provides a central monitoring station for 250+ control systems on a single Ethernet network (more are possible, the number depends on the combination of IP ID and IP address). Crestron RoomView monitors each projector, including projector's online status, system power, lamp life, network setting and hardware faults, plus any custom attribute as defined by the Administrator. The Administrator can add, delete, or edit room information, contact information and events, which are logged automatically by the software for all users. (Operation UI as following image)

1. Main Screen



2. Edit Room



❖ Crestron RoomView's function is set according to the products' models and specifications.

User Controls

3. Edit Attribute

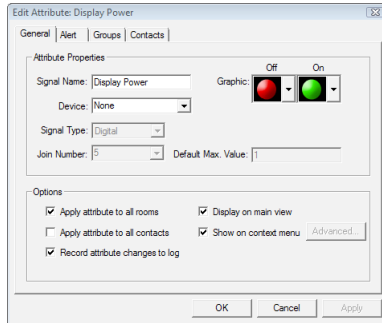

4. Edit Event

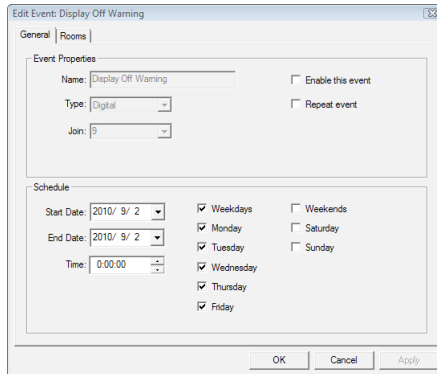

For further information, please visit:

<http://www.crestron.com> & www.crestron.com/getroomview.

Multimedia

Accessing Multimedia Files

This projector supports two methods to project the media files (photos, videos, music, documents) stored on following devices:

- a. Via Wireless dongle (optional) - wirelessly access the media files stored on your mobile phone, tablet PC, notebook, or desktop.
- b. Via USB flash drive - directly access the media files stored in the device.

How to access Multimedia mode

1. Plug a wireless dongle or a USB flash drive into the USB connector at the back of projector.



- ❖ In Multimedia source mode the keypad MENU key is used as EXIT key. User can press keypad "Power" key then press keypad "MENU" key to show MENU OSD in Multimedia source mode.
- ❖ When Auto Source is ON the system will search Multimedia source if user had ever chosen Multimedia source or it will skip Multimedia source.
- ❖ The projector will automatically restart the **Multimedia** system and back to Multimedia menu if there is no any action after few hours.

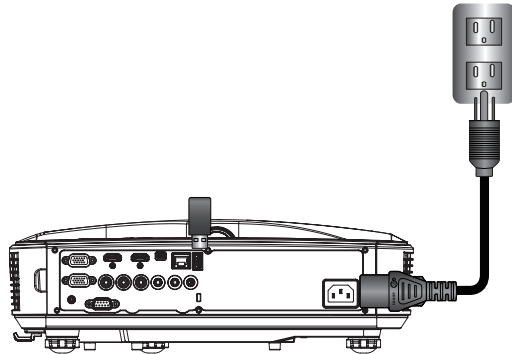

2. Press "INPUT" on the remote control or on the control panel to turn on the projector. When the Input menu appears, press the ▲▼ keys to select "Multimedia" and the "Enter" key to confirm.

Mobile Display

To access the media files stored on your mobile device or tablet PC, do the following:

1. On **Multimedia** menu, select **Mobile/Tablet**.



2. On your mobile device or tablet PC, download “EZ-View” application App Store (iOS) or Play Store (Android).



3. Enable your mobile device or tablet PC WiFi function, and search the AP name listed in the Wi-Fi network list.
4. The WIFI initial connection, you will be prompted to enter a password. Enter the password as screen AP Name as step2.
5. Launch “EZ-View” application and enter the PCTOOL password as step3
6. Wait until the connection is established. The media files on your mobile device or tablet PC can be accessed using the projector.

Multimedia

Laptop Display

To access the media files stored on your laptop/notebook, do the following:

1. On **Multimedia** menu, select **Laptop**.



2. Enable your laptop/notebook WiFi function, and search the AP name listed in the Wi-Fi network list.



3. On the WIFI initial connection, you will be prompted to enter a password. Enter the password as step2.
4. Open your web browser and enter the IP address under the same subnet. Then select "Wifi" on the left side of web page to install application required by the operation system.
5. After install completed. Launch "EZ-View" application and enter the control code shown on the right-bottom side of the screen.

6. Wait until the connection is established. The media files on your laptop/notebook can be accessed using the projector.

Desktop Display

To access the media files stored on your desktop, do the following:

1. On **Multimedia** menu, select **Desktop**.



2. Open your web browser and enter the IP address. Then select "Wifi" on the left side of the screen and install application required by the operation system.



Multimedia

3. After install complete. Launch “EZ-View” application and enter the control code shown on the right-bottom side of the screen.
4. Wait until the connection is established. The media files on your desktop can be accessed using the projector.

EZ-View

1. Before opening the EZ-View application, user must input the password displayed on screen.
2. The application provides following function for image mirroring.
3. Mode selection: graphic mode provide slower refresh rate, better quality image. Video mode have better refresh performance to display video.
4. Display selection: can display desktop or extension desktop on your laptop or PC.
5. Split screen: can mirror different users on screen. Maximum number of screen is four.



- ❖ PowerPoint animations are not supported.
- ❖ Details about MMA support list please refer to Appendices.

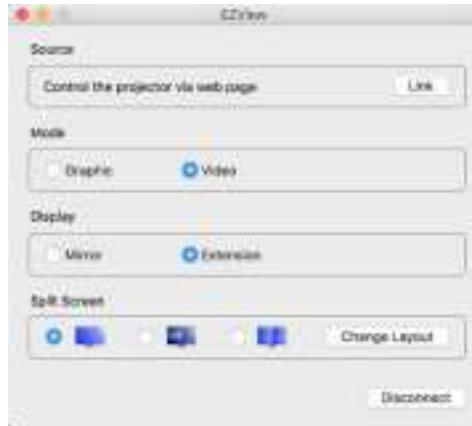

USB Storage Display

To access the media files stored on your USB flash drive, do the following:

Multimedia

Supported File Format

Multimedia Category	File Format
Photo	BMP, JPG, PNG
Music	MP3, WMA
Video	AVI, MOV, MP4, RM, RMVB, DAT, MPG, ISO, TS, MKV, VOB, and WMV
Document	WORD, EXCEL, PPT*, PDF

1. On **Multimedia** menu, select **USB Disk**. Sometimes selecting USB is slower. This is resulted from ready USB media.



2. Use the ▲▼ keys to select the file category and press the "Enter" key.



Multimedia

3. Use the ▲▼ keys to select the file to view/play and press the “Enter” key to confirm.











Photo

1. Select the Photo will enter to file list.
Use up, down, left, right key to select the picture.



2. Select one picture and push the enter key.
Push enter key to show the tool bar, push back key to display tool bar.
The tool bar includes whirling, full screen (keep the original ratio), previous image next image, slide show, delete, image information and exit.
User first press “Enter” key to select one of function on tool bar and then continue press the “Enter” to proceed different options on the function. Then press left/right to previous/next function. But when user selects rotation/zoom, user can press the “Enter” key to toggle between different options. User can press “Exit” key to leave the function.



Functions	Defined
	Degree change: 0, 90, 180, 270 Enter key looping Back key leave and no save function
	Zoom in: x1, x2, x3, x4 Enter key looping In zoom in mode use arrow key to move content. Back key leave and no save function
	Full screen Keep image ratio and no save function
	Previous image
	Next image
	Slide show Press to start and re-press to stop
	Delete from USB disk
	Copy to internal memory Not support in this model
	Information
	Close tool bar

Video

1. Select the Video will enter to file list
Use up and down key to select the video file.



Multimedia

2. Select the video file and push the enter key to play video.
Push enter key to show the tool bar, push back key to display tool bar.

Functions	Key defined
reverse	left key
forward	right key
play/ pause	enter
display mode	only show the play mode was repeat or single To configure the play mode, user can reach to settings/Video/repeat mode to change the repeat mode



Music

1. Select the Music will enter to file list.
Use up and down key to select the audio file.



2. Select the audio file and push enter key to play music.

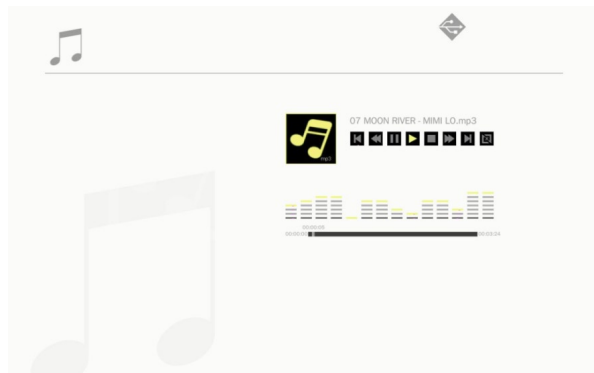

Functions	Key defined
previous file	up key
next file	down key
rewind	left key
forward	right key
play/ pause	enter
display mode	only show the play mode was repeat or single To configure the play mode, user can reach to settings/Music/repeat mode to change the repeat mode







Multimedia

Office viewer

1. Select the office viewer will enter to file list.
Use up and down key to select the document file.



2. Select one document and push the enter key.
Push enter key to show the tool bar, push back key to display tool bar.
The tool bar includes screen pan, zoom in, zoom out, information.

Functions	Defined
	Left shift content Enter key to use
	Right shift content Enter key to use
	UP shift content Enter key to use
	Down shift content Enter key to use
	Zoom in Enter key to use
	Zoom out Enter key to use
	Display mode Please see the note3

Multimedia

	Close tool bar Enter key to use
---	------------------------------------

*Note 1. The decode time depend how many objects embedded in document file, not depend the size of file.

*Note 2. Office viewer will set the display ratio by each document files.

*Note 3. Display mode behavior:

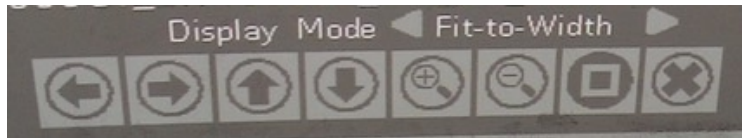

1. select display mode and press enter key, then use right/left key select "fit to screen, fit to high or fit to screen" and press enter key to confirm.
2. Enter Exit key to leave display mode, then use right/left key to select other functions.

Configuring Multimedia Settings

To change the settings, do the following:

1. On **Multimedia** menu, select **Settings**.



2. Use the ▲ ▼ keys to select the desired menu option and press the "Enter" key to enter the submenu.

Multimedia



- ▶ System: Select this option to view the firmware version and update firmware.
- ▶ Video: Select this option to change the display ratio and set the repeat mode.
- ▶ Photo: Select this option to change the display ratio, slideshow pattern, and slideshow duration.
- ▶ Music: Select this option to set the repeat mode.
- ▶ WiFi: Select this option to configure the Wi-Fi connection.

3. Use the ▲▼ keys to select the adjust/select the setting and press the “Enter” key to confirm.

WiFi Setting

For configuring WIFI setting, user has to configure the AP setting and client mode setting. It relies on network topology illustrated as below.

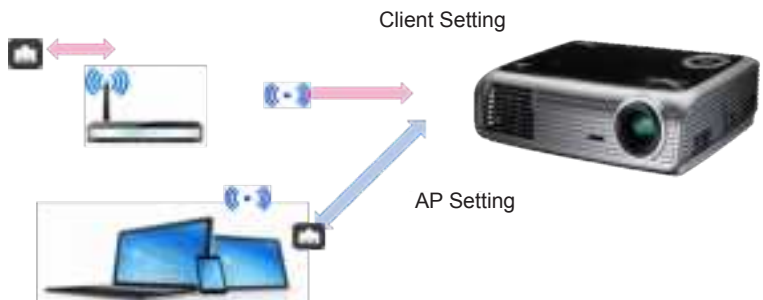

✓ AP setting

The AP setting defines the SSID between projector and user PC. The projector acts as a WIFI access point. PC/Laptops connects this WIFI access point can use the multimedia mirroring/streaming function with EZ-View software. This setting is similar with access point, user can define the SSID name, password here.

✓ Client mode setting.

In multimedia card, the projector can be as access point but also a client to public WIFI access point. In the other words, the projector has capability to wirelessly connect to internet. Similar with laptop connects to internet, user must defines password a select appropriate public access point. Projector and its access point users can connect to internet via WIFI connection. If projector already connects internet via RJ45, user can ignore the setting here.

User can use the left/right key to toggle the setting between the AP setting and client mode setting. Use up/down key to move to each item on the setting.



In the AP setting, user can define the SSID name, and defines the password in PSK item. Security item do not have capability to change, only WPA2 encryption is supported in AP mode.

Multimedia

Following is the steps to configure the item.

- 1) Use the up/down to control the blue focus to select SSID item then push enter key. A virtual keyboard will popup and the SSID will be cleared for user input. When input completed, press the exit key on remote control and navigate with up/down key to proceed previous/next item.

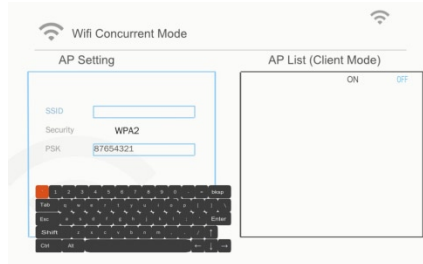

- 2) Use up/down key to reach PSK item. Then follow procedure as case 1 to input the PSK. 8 characters are required.

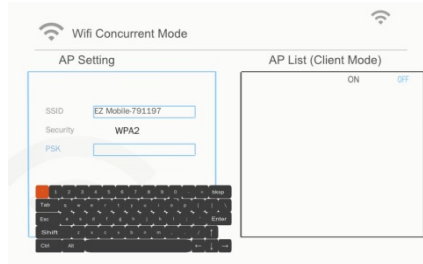

Multimedia

- 3) After that, move up/down key to select "V" then push enter key to finish AP setting. Projector media card will restart and need to wait couple of seconds. If you want to cancel configuration, move to "X" button and then push enter key. The SSID and PSK setting will drawback to original setting.



If projector needs to connect to internet with wireless, user has to configure the client mode. Using the right/left key to move the active window to client mode and configure with following procedures.

- 1) Use the up, down key to control the blue focus to select "on" for AP List(Client mode) then push enter key.



- 2) Using up/down key to choose the WIFI router which you want to connect and push enter key.

Multimedia



- 3) After choosing the access point, user has to input the password in left side PSK window and then select OK to proceed.



- 4) Connection status will display on bottom side and will show successful once connection is completed. Check sign on the access point will display as blue.



- ❖ For security reason, security item do not have capability to change, only WPA2 encryption is supported in AP mode. In client mode setting, WPA/WPA2 are supported.



Appendices

Installing and Cleaning the Optional Dust Filter

We recommend you clean the dust filter every 500 hours of operation, or more often if you are using the projector in a dusty environment.

When the warning message appears on the screen, do the following to clean the air filter:

The usage time of the dust filter is reached.
Please clean the dust filters for better performance.



- ❖ The optional dust filter should be used in dusty environments.
- ❖ If the dust filter is installed, a proper maintenance will prevent overheating and projector malfunction.
- ❖ The dust filter is optional.
- ❖ The specific interfaces are selected in terms of the specifications of types.

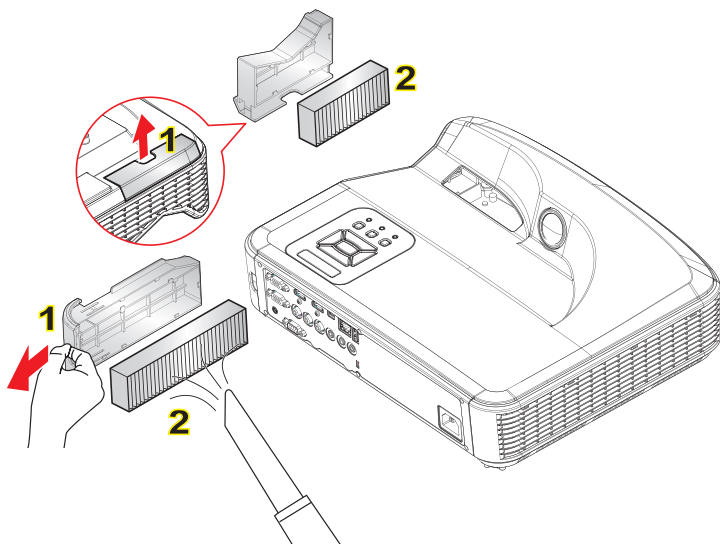

○ Air Filter Cleaning Procedure: ○

1. Switch off the power to the projector by pressing the “**⏻**” button.
 2. Disconnect the power cord.
 3. Pull out the dust filter, as shown in the illustration. **1**
 4. Carefully remove the dust filter. Then clean or change the filter. **2**
- To install the filter, reverse the previous steps.
5. Turn on the projector and reset the filter usage counter after the dust filter is replaced.

MMA Support List

Image

Image Format	Profile	Color Space	Size Limitation
JPEG	Baseline	YUV400	8000 x 6000
		YUV420	8000 x 6000
		YUV422	8000 x 6000
		YUV440	8000 x 6000
		YUV444	8000 x 6000
	Progressive	YUV400	Width <= 10240 & height <= 6400
		YUV420	
		YUV422	
		YUV440	
		YUV444	
BMP	No Limit	No Limit	No Limit

Audio

Audio Format	Sample Rate (KHz)	Bit Rate (Kbps)
MP1/MP2/MP3	8-48	8-320
WMA	22-48	5-320
OGG	8-48	64-320
ADPCM-WAV	8-48	32-384
PCM-WAV	8-48	128-1536

Appendices

Video

File Extensions	Audio/ Video	Codec	Profile/Level Support	Explanation
.avi .mkv	Video	MJPEG	Up to 1080P 30fps 80Mbps	
		H.264/AVC	Up to High Profile , Levels 1- 4.1 (1080P 30fps 25Mbps)	Support less than 6 reference frames
		XVID	Up to Advance Simple profile (1080P 30fps 30Mbps)	
		WMV3 (WMV Ver9)	Up to Main Profile; Low, Medium Level (1080P 30fps 25Mbps)	
		MPEG2	Main profile, Low and Main Levels (1080P 30fps 30Mbps)	
		MPEG4	Advanced Simple Profile (frame picture) , Levels 0-5 (1080P 30fps 30Mbps)	
.avi .mkv	Video	VC-1	Simple and Main Profile; Low, Medium and High Levels (1080P 30fps 25Mbps)	Not Support VC-1 Advance Profile
	Audio	MPEG-1 Layer I, II		
		MPEG-1 Layer III (mp3)		
		PCM		
		ADPCM		

Appendices

.ts	Video	MPEG2	Main profile, Low and Main Levels (1080P 30fps 30Mbps)	
		H.264/AVC	Up to High Profile , Levels 1- 4.1 (1080P 30fps 25Mbps)	Support less than 6 reference frames
.ts	Video	MPEG-1 Layer I, II		
		MPEG-1 Layer III (mp3)		
		LPCM		
.dat .vob .mpg .mpeg	Video	MPEG1	Main profile, Low and Main Levels (1080P 30fps 30Mbps)	D-picture not support
		MPEG2	Main profile, Low and Main Levels (1080P 30fps 30Mbps)	
	Audio	MPEG-1 Layer I, II		
		MPEG-1 Layer III (mp3)		
		LPCM		
.mov .mp4	Video	MPEG4	Advanced Simple Profile (frame picture) , Levels 0-5 (1080P 30fps 30Mbps)	
		H.264/AVC	Up to High Profile, Levels 1- 4.1 (1080P 30fps 25Mbps)	Support less than 6 reference frames
	Audio	AMR		
		PCM		
		ADPCM		

Appendices

.wmv	Video	WMV3 (WMV Ver9)	Up to Main Profile; Low, Medium Level (1080P 30fps 25Mbps)	
	Audio	WMA2 (WMA Ver9 & Ver9.1)		Not Support WMA Ver9 Pro

Subtitle

Format	Font	Subtitle Size
Standard SRT	UTF-8 / UTF-16	8bits up to 1280 x 800
SMI		
SSA/ASS		

Note: DO NOT support mixed code in subtitle files.

Office Viewer

File Format	Support Version	Pages/ Lines Limitation	Size Limitation	Comment
Adobe PDF	PDF 1.0	Up to 1000 pages (One File)	Up to 75MB	
	PDF 1.1			
	PDF 1.2			
	PDF 1.3			
	PDF 1.4			
MS PowerPoint	British PowerPoint 97.	Up to 1000 pages (One File)	Up to 19MB	No support Slide Show order
	PowerPoint 2000, 2002, 2003.			
	PowerPoint 2007(.pptx).			
	PowerPoint 2010(.pptx),.			
	Office XP PowerPoint.			
	PowerPoint presentation-2003 and earlier(.ppx)			
PowerPoint presentation-2007 and 2010(.ppsx)				

Appendices

MS Word	British Word95	Because office viewer does not load all pages of MS Word file at the same time, there are no obvious limitations of page and line.	Up to 100MB	Not support Bold Text in Simple Chinese front
	Word97, 2000, 2002, 2003			
	Word 2007 (.docx), 2010 (.docx)			
MS Excel	British Excel 95	Row Limit: up to 595	Up to 15MB	Not support password-protected sheets
	Excel 97, 2000, 2002, 2003	Row Limit: up to 595		
	Excel 2007 (.xlsx), 2010 (.xlsx)	Sheet: up to 100		
	Office XP Excel			

Note: Any one of three limitations above can not appear on one excel file simultaneously

Storage

Storage	Device type	File system	File&Dir Level
Internal Memory	TLC/MLC/SLC 8/12/24/40/60 bit ECC NAND	FAT16, FAT32 NTFS, ExFAT	Support Max 999 directories and Max 9,999 Files Support at most 10th level directory
USB	USB Flash,USB-HardDisk		
SD Card	SDHC,SDXC		

Not recommend to connect with the Portable Hard Drive over 250GB

Appendices

Compatibility Modes

▶ VGA Analog

a. PC signal			
Modes	Resolution	V. Frequency [Hz]	H. Frequency [Hz]
VGA	640x480	60	31.5
	640x480	67	35.0
	640x480	72	37.9
	640x480	75	37.5
	640x480	85	43.3
	640x480	120	61.9
IBM	720x400	70	31.5
SVGA	800x600	56	35.1
	800x600	60	37.9
	800x600	72	48.1
	800x600	75	46.9
	800x600	85	53.7
	800x600	120	77.4
Apple, MAC II	832x624	75	49.1
XGA	1024x768	60	48.4
	1024x768	70	56.5
	1024x768	75	60.0
	1024x768	85	68.7
	1024x768	120	99.0
Apple, MAC II	1152x870	75	68.7
SXGA	1280x1024	60	64.0
	1280x1024	72	77.0
	1280x1024	75	80.0
QuadVGA	1280x960	60	60.0
	1280x960	75	75.2
SXGA+	1400x1050	60	65.3
UXGA	1600x1200	60	75.0

Appendices

b. Extended wide timing			
Modes	Resolution	V. Frequency [Hz]	H. Frequency [Hz]
WXGA	1280x720	60	44.8
	1280x800	60	49.6
	1366x768	60	47.7
	1440x900	60	59.9
WSXGA+	1680x1050	60	65.3
c. Component signal			
Modes	Resolution	V. Frequency [Hz]	H. Frequency [Hz]
480i	720x480 (1440x480)	59.94(29.97)	15.7
576i	720x576 (1440x576)	50(25)	15.6
480p	720x480	59.94	31.5
576p	720x576	50	31.3
720p	1280x720	60	45.0
	1280x720	50	37.5
1080i	1920x1080	60(30)	33.8
	1920x1080	50(25)	28.1
1080p	1920x1080	23.98/24	27.0
	1920x1080	60	67.5
	1920x1080	50	56.3

Appendices

▶ HDMI Digital

a. PC signal			
Modes	Resolution	V. Frequency [Hz]	H. Frequency [Hz]
VGA	640x480	60	31.5
	640x480	67	35.0
	640x480	72	37.9
	640x480	75	37.5
	640x480	85	43.3
	640x480	120	61.9
IBM	720x400	70	31.5
SVGA	800x600	56	35.1
	800x600	60	37.9
	800x600	72	48.1
	800x600	75	46.9
	800x600	85	53.7
	800x600	120	77.4
Apple, MAC II	832x624	75	49.1
XGA	1024x768	60	48.4
	1024x768	70	56.5
	1024x768	75	60.0
	1024x768	85	68.7
	1024x768	120	99.0
Apple, MAC II	1152x870	75	68.7
SXGA	1280x1024	60	64.0
	1280x1024	72	77.0
	1280x1024	75	80.0
QuadVGA	1280x960	60	60.0
	1280x960	75	75.2
SXGA+	1400x1050	60	65.3
UXGA	1600x1200	60	75.0

Appendices

b. Extended wide timing			
Modes	Resolution	V. Frequency [Hz]	H. Frequency [Hz]
WXGA	1280x720	60	44.8
	1280x800	60	49.6
	1366x768	60	47.7
	1440x900	60	59.9
WSXGA+	1680x1050	60	65.3
c. Video signal			
Modes	Resolution	V. Frequency [Hz]	H. Frequency [Hz]
480p	640x480	59.94/60	31.5
480i	720x480 (1440x480)	59.94(29.97)	15.7
576i	720x576 (1440x576)	50(25)	15.6
480p	720x480	59.94	31.5
576p	720x576	50	31.3
720p	1280x720	60	45.0
	1280x720	50	37.5
1080i	1920x1080	60(30)	33.8
	1920x1080	50(25)	28.1
1080p	1920x1080	23.98/24	27.0
	1920x1080	60	67.5
	1920x1080	50	56.3
d. HDMI 1.4a mandatory 3D timing- Video Signal			
Modes	Resolution	V. Frequency [Hz]	H. Frequency [Hz]
Frame Packing	720p	50	31.5
	720p	59.94/60	15.7
	1080p	23.98/24	15.6
Side-by-Side (Half)	1080i	50	31.5
	1080i	59.94/60	31.3
Top and Bottom	720p	50	45.0
	720p	59.94/60	37.5
	1080p	23.98/24	33.8

Appendices

RS232 Protocol Function List

		A. VGA Analog			
		(1) PC Signal			
Modes	Resolution	V.Frequency [Hz]	H.Frequency [KHz]	Pixel CLK [MHz]	EDID Description
VGA	640x480	60	31.5	25..2	Established Timings 1
	640x480	67	35.0	26.8	Established Timings 1
	640x480	72	37.9	31.5	Established Timings 1
	640x480	75	37.5	31.5	Established Timings 1
	640x480	85	43.3	36.0	
IBM SVGA	720x400	70	31.5	28.3	Established Timings 1
	800x600	56	35.1	36.0	Established Timings 1
	800x600	60	37.9	40.0	Established Timings 1
	800x600	72	48.1	50.0	Established Timings 2
	800x600	75	46.9	49.5	Established Timings 2
	800x600	85	53.7	56.3	
Apple, Mac II	832x624	75	49.1	57.3	Established Timings 2
XGA	1024x768	60	48.4	65.0	WXGA: Established Timings 2 XGA: Established Timings 2 and (Native)DetailedTiming / Descriptor Block 1
	1024x768	70	56.5	75.0	Established Timings 2
	1024x768	75	60.0	78.8	Established Timings 2
	1024x768	85	68.7	94.5	
	1024x768	120	99.0	137.8	Standard Timing Identification
Apple, Mac II	1152x870	75	68.7	100.0	Manufacturer's Reserved Timing
SXGA	1280x1024	60	64.0	108.0	
	1280x1024	72	77.0	133.0	
	1280x1024	75	80.0	135.0	Established Timings 2
QuadVGA	1280x960	60	60.0	101.3	Standard Timing Identification
	1280x960	75	75.2	130.0	
SXGA+	1400x1050	60	65.3	121.8	
UXGA	1600x1200	60	75.0	161.0	Standard Timing Identification
(2) Extended Wide timing					
WXGA	1280x720	60	44.8	74.2	Standard Timing Identification
	1280x800	60	49.6	83.5	WXGA: (Native)DetailedTiming/DescriptorBlock1 XGA: Standard Timing Identification
	1366x768	60	47.7	84.8	
	1440x900	60	59.9	106.5	Standard Timing Identification
WSXGA+	1680x1050	60	65.3	146.3	WXGA: Standard Timing Identification XGA: N/A
	1920x720	60	44.35	92.25	
(3) Component Signal					
480i	720x480 (1440x480)	59.94(29.97)	15.7	13.5	
576i	720x576 (1440x576)	50(25)	15.6	13.5	
480p	720x480	59.94	31.5	27.0	
576p	720x576	50	31.3	27.0	
720p	1280x720	60	45.0	74.25	
720p	1280x720	50	37.5	74.25	
1080i	1920x1080	60(30)	33.8	74.25	
1080i	1920x1080	50(25)	28.1	74.25	
1080p	1920x1080	23.98/24	27.0	74.25	
1080p	1920x1080	60	67.5	148.5	
1080p	1920x1080	50	56.3	148.5	
B. HDMI Digital					
(1) PC Signal					
VGA	640x480	60	31.5	25..2	Established Timings 1
	640x480	67	35.0	26.8	Established Timings 1
	640x480	72	37.9	31.5	Established Timings 1

Appendices

	640x480	75	37.5	31.5	Established Timings 1
	640x480	85	43.3	36.0	
IBM	720x400	70	31.5	28.3	Established Timings 1
SVGA	800x600	56	35.1	36.0	Established Timings 1
	800x600	60	37.9	40.0	Established Timings 1
	800x600	72	48.1	50.0	Established Timings 2
	800x600	75	46.9	49.5	Established Timings 2
	800x600	85	53.7	56.3	
Apple, Mac II	832x624	75	49.1	57.3	Established Timings 2
XGA	1024x768	60	48.4	65.0	WXGA: Established Timings 2 XGA: Established Timings 2 and (Native)Detailed Timing / Descriptor Block 1
	1024x768	70	56.5	75.0	Established Timings 2
	1024x768	75	60.0	78.8	Established Timings 2
	1024x768	85	68.7	94.5	
	1024x768	120	99.0	137.8	Standard Timing Identification
Apple, Mac II	1152x870	75	68.7	100.0	Manufacturer's Reserved Timing
SXGA	1280x1024	60	64.0	108.0	
	1280x1024	72	77.0	133.0	
	1280x1024	75	80.0	135.0	Established Timings 2
QuadVGA	1280x960	60	60.0	101.3	Standard Timing Identification
	1280x960	75	75.2	130.0	
SXGA+	1400x1050	60	65.3	121.8	
UXGA	1600x1200	60	75.0	161.0	Standard Timing Identification
(2) Extended Wide timing					
WXGA	1280x720	60	44.8	74.2	Standard Timing Identification
	1280x800	60	49.6	83.5	WXGA: (Native)DetailedTiming/DescriptorBlock1 XGA: Standard Timing Identification
	1366x768	60	47.7	84.8	
	1440x900	60	59.9	106.5	Standard Timing Identification
WSXGA+	1680x1050	60	65.3	146.3	WXGA: Standard Timing Identification XGA: N/A
	1920x720	60	44.35	92.25	
(3) HDMI - Video Signal					
640x480p	640x480	59.94/60	31.5	25.2	Short Video Descriptor of CEA EDID Timing
480i	720x480 (1440x480)	59.94(29.97)	15.7	13.5	Short Video Descriptor of CEA EDID Timing
576i	720x576 (1440x576)	50(25)	15.6	13.5	Short Video Descriptor of CEA EDID Timing
480p	720x480	59.94	31.5	27.0	Short Video Descriptor of CEA EDID Timing
576p	720x576	50	31.3	27.0	Short Video Descriptor of CEA EDID Timing
720p	1280x720	60	45.0	74.25	(Native)Short Video Descriptor of CEA EDID Timing
720p	1280x720	50	37.5	74.25	(Native)Short Video Descriptor of CEA EDID Timing
1080i	1920x1080	60(30)	33.8	74.25	Short Video Descriptor of CEA EDID Timing
1080i	1920x1080	50(25)	28.1	74.25	Short Video Descriptor of CEA EDID Timing
1080p	1920x1080	23.98/24	27.0	74.25	Short Video Descriptor of CEA EDID Timing
1080p	1920x1080	60	67.5	148.5	Short Video Descriptor of CEA EDID Timing
1080p	1920x1080	50	56.3	148.5	Short Video Descriptor of CEA EDID Timing
(4) HDMI 1.4a mandatory 3D timing- Video Signal					
Frame Packing	720p	50			Short Video Descriptor of CEA EDID Timing
	720p	59.94/60			Short Video Descriptor of CEA EDID Timing
	1080p	23.98/24			Short Video Descriptor of CEA EDID Timing
Side-by-Side	1080i	50			Short Video Descriptor of CEA EDID Timing
	1080i	59.94/60			Short Video Descriptor of CEA EDID Timing
Top-and-Bottom	720p	50			Short Video Descriptor of CEA EDID Timing
	720p	59.94/60			Short Video Descriptor of CEA EDID Timing
	1080p	23.98/24			Short Video Descriptor of CEA EDID Timing
(5) Input signal frequency range					
Analog: fh=15kHz ~ 100kHz, fv=24Hz ~ 120Hz, Max. pixel rate: 162.5MHz					
Digital (HDMI): fh=15kHz ~ 100kHz, fv=24Hz ~ 120Hz, Max. pixel rate: 200MHz					

Appendices

Regulation & Safety Notices

This appendix lists the general notices of your projector.

FCC notice

This device has been tested and found to comply with the limits for a Class B digital device pursuant to Part 15 of the FCC rules. These limits are designed to provide reasonable protection against harmful interference in a residential installation. This device generates, uses and can radiate radio frequency energy and, if not installed and used in accordance with the instructions, may cause harmful interference to radio communications.

However, there is no guarantee that interference will not occur in a particular installation. If this device does cause harmful interference to radio or television reception, which can be determined by turning the device off and on, the user is encouraged to try to correct the interference by one or more of the following measures:

- Reorient or relocate the receiving antenna.
- Increase the separation between the device and receiver.
- Connect the device into an outlet on a circuit different from that to which the receiver is connected.
- Consult the dealer or an experienced radio/television technician for help.

Notice: Shielded cables

All connections to other computing devices must be made using shielded cables to maintain compliance with FCC regulations.

Caution

Changes or modifications not expressly approved by the manufacturer could void the user's authority, which is granted by the Federal Communications Commission, to operate this projector.

Appendices

Operation conditions

This device complies with Part 15 of the FCC Rules. Operation is subject to the following two conditions:

1. This device may not cause harmful interference and
2. This device must accept any interference received, including interference that may cause undesired operation.

Notice: Canadian users

This Class B digital apparatus complies with Canadian ICES-003.

Remarque à l'intention des utilisateurs canadiens

Cet appareil numérique de la classe B est conforme à la norme NMB-003 du Canada.

Declaration of Conformity for EU countries

- EMC Directive 2004/108/EC (including amendments)
- Low Voltage Directive 2006/95/EC
- R & TTE Directive 1999/5/EC (if product has RF function)

Disposal instructions



Do not throw this electronic device into the trash when discarding. To minimize pollution and ensure utmost protection of the global environment, please recycle it.

Appendices

Safety notice

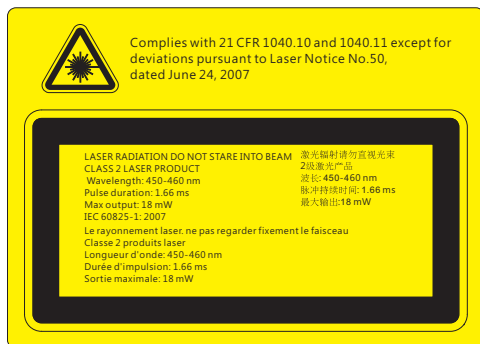

WARNING

- This projector is a Class 2 laser device that conforms with IEC 60825-1:2007 and CFR 1040.10 and 1040.11.
- Class 2 laser product, Do Not Stare Into Beam.
- This projector has built-in Class 4 laser module. Disassembly or modification is very dangerous and should never be attempted.
- Any operation or adjustment not specifically instructed by the user's guide creates the risk of hazardous laser radiation exposure.
- Do not open or disassemble the projector as this may cause damage by the exposure of laser radiation.
- Do not stare into beam when the projector is on. The bright light may result in permanent eye damage.
- Without following the control, adjustment or operation procedure may cause damage by the exposure of laser radiation.
- Adequate instructions for assembly, operation, and maintenance, including clear warnings concerning precautions to avoid possible exposure to laser and collateral radiation in excess of the accessible emission limits in Class 2.

Ceiling Mount Installation

1. To prevent damage to your projector, please use the Optoma ceiling mount.
2. If you wish to use a third party ceiling mount kit, please ensure the screws used to attach a mount to the projector meet the following specifications:

- ▶ Screw type: M4*3
- ▶ Minimum screw length: 10mm



❖ Please note that damage resulting from incorrect installation will void the warranty.



⚠ Warning:

1. If you buy a ceiling mount from another company, please be sure to use the correct screw size. Screw size will vary depending on the thickness of the mounting plate.
2. Be sure to keep at least 10 cm gap between the ceiling and the bottom of the projector.
3. Avoid installing the projector near a heat source.

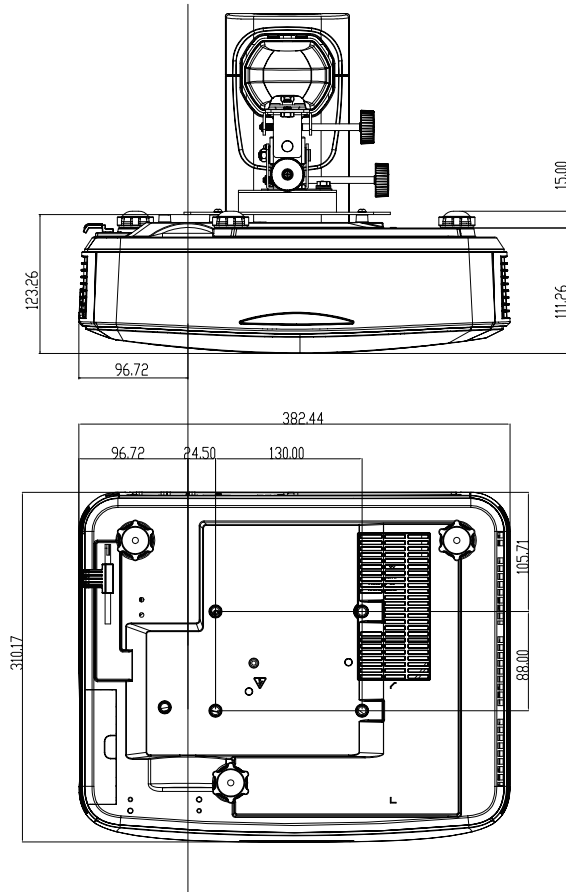



Appendices

Optoma global offices

For service or support, please contact your local office.



USA

3178 Laurelview Ct.
Fremont, CA 94538, USA
www.optomausa.com

 888-289-6786
 510-897-8601
 services@optoma.com



Canada

3178 Laurelview Ct.
Fremont, CA 94538, USA
www.optomausa.com

 888-289-6786
 510-897-8601
 services@optoma.com

Latin America

3178 Laurelview Ct.
Fremont, CA 94538, USA
www.optomausa.com

 888-289-6786
 510-897-8601
 services@optoma.com



Europe

42 Caxton Way, The Watford Business Park
Watford, Hertfordshire,
WD18 8QZ, UK
www.optoma.eu
Service Tel : +44 (0)1923 691865

 +44 (0) 1923 691 800
 +44 (0) 1923 691 888
 service@tsc-europe.com

Benelux BV

Randstad 22-123
1316 BW Almere
The Netherlands
www.optoma.nl

 +31 (0) 36 820 0252
 +31 (0) 36 548 9052

France

Bâtiment E
81-83 avenue Edouard Vaillant
92100 Boulogne Billancourt,
France

 +33 1 41 46 12 20
 +33 1 41 46 94 35
 savoptoma@optoma.fr



Spain

C/ José Hierro,36 Of. 1C
28522 Rivas VaciaMadrid,
Spain

 +34 91 499 06 06
 +34 91 670 08 32



Deutschland

Wiesenstrasse 21 W
D40549 Düsseldorf,
Germany

 +49 (0) 211 506 6670
 +49 (0) 211 506 66799
 info@optoma.de

Scandinavia



Lerpeveien 25
3040 Drammen
Norway

 +47 32 98 89 90
 +47 32 98 89 99
 info@optoma.no

PO.BOX 9515
3038 Drammen
Norway

Korea

WOOMI TECH.CO.,LTD.
4F.Minu Bldg.33-14, Kangnam-Ku,
seoul,135-815, KOREA

 +82+2+34430004
 +82+2+34430005

Japan

東京都足立区綾瀬3-25-18



株式会社オーエス

コンタクトセンター:0120-380-495

 info@os-worldwide.com
www.os-worldwide.com



Taiwan

12F., No.213,Sec. 3, Beixin Rd.,
Xindian Dist., New Taipei City 231,
Taiwan, R.O.C.
www.optoma.com.tw

 +886-2-8911-8600
 +886-2-8911-6550
 services@optoma.com.tw
asia.optoma.com



Hong Kong

Unit A, 27/F Dragon Centre,
79 Wing Hong Street,
Cheung Sha Wan,
Kowloon, Hong Kong

 +852-2396-8968
 +852-2370-1222
www.optoma.com.hk

China

5F, No. 1205, Kaixuan Rd.,
Changning District
Shanghai, 200052, China

 +86-21-62947376
 +86-21-62947375
www.optoma.com.cn

