

ViewSonic®



M1+

Portable Cinema

User Guide

IMPORTANT: Please read this User Guide to obtain important information on installing and using your product in a safe manner, as well as registering your product for future service. Warranty information contained in this User Guide will describe your limited coverage from ViewSonic Corporation, which is also found on our web site at <http://www.viewsonic.com> in English, or in specific languages using the Regional selection box in the upper right corner of our website. "Antes de operar su equipo lea cuidadosamente las instrucciones en este manual"

Model No. VS17337

Compliance Information

FCC Statement

This device complies with part 15 of FCC Rules. Operation is subject to the following two conditions: (1) this device may not cause harmful interference, and (2) this device must accept any interference received, including interference that may cause undesired operation.

This equipment has been tested and found to comply with the limits for a Class B digital device, pursuant to part 15 of the FCC Rules. These limits are designed to provide reasonable protection against harmful interference in a residential installation. This equipment generates, uses, and can radiate radio frequency energy, and if not installed and used in accordance with the instructions, may cause harmful interference to radio communications. However, there is no guarantee that interference will not occur in a particular installation. If this equipment does cause harmful interference to radio or television reception, which can be determined by turning the equipment off and on, the user is encouraged to try to correct the interference by one or more of the following measures:

- Reorient or relocate the receiving antenna.
- Increase the separation between the equipment and receiver.
- Connect the equipment into an outlet on a circuit different from that to which the receiver is connected.
- Consult the dealer or an experienced radio/TV technician for help.

Warning: You are cautioned that changes or modifications not expressly approved by the party responsible for compliance could void your authority to operate the equipment.

The device for the band 5150-5250 MHz is only for indoor usage to reduce potential for harmful interference to co-channel mobile satellite systems.

les dispositifs fonctionnant dans la bande 5150-5250 MHz sont réservés uniquement pour une utilisation à l'intérieur afin de réduire les risques de brouillage préjudiciable aux systèmes de satellites mobiles utilisant les mêmes canaux.

For Canada

RF regulatory statement

This device contains licence-exempt transmitter(s)/receiver(s) that comply with Innovation, Science and Economic Development Canada's licence-exempt RSS(s). Operation is subject to the following two conditions:

- (1) This device may not cause interference.
- (2) This device must accept any interference, including interference that may cause undesired operation of the device.

L'émetteur/récepteur exempt de licence contenu dans le présent appareil est conforme aux CNR d'Innovation, Sciences et Développement économique Canada applicables aux appareils radio exempts de licence. L'exploitation est autorisée aux deux conditions suivantes :

1. L'appareil ne doit pas produire de brouillage;
2. L'appareil doit accepter tout brouillage radioélectrique subi, même si le brouillage est susceptible d'en compromettre le fonctionnement.

RF exposure statement:

IC Radiation Exposure Statement

This equipment complies with IC RSS-102 radiation exposure limit set forth for an uncontrolled environment. This equipment should be installed and operated with minimum distance 20cm between the radiator and your body.

Déclaration d'exposition à la radiation : Cet équipement respecte les limites d'exposition aux rayonnements IC définies pour un environnement non contrôlé. Cet équipement doit être installé et mis en marche à une distance minimale de 20 cm qui sépare l'élément rayonnant de votre corps.

L'émetteur ne doit ni être utilisé avec une autre antenne ou un autre émetteur ni se trouver à leur proximité.

CAN ICES-3 (B)/NMB-3(B)

CE Conformity for European Countries



The device complies with the EMC Directive 2014/30/EU and Low Voltage Directive 2014/35/EU. and Ecodesign Directive 2009/125 / EC. and Radio Equipment Directive 2014/53/EU

Following information is only for EU-member states:

The mark is in compliance with the Waste Electrical and Electronic Equipment Directive 2012/19/EU (WEEE).

The mark indicates the requirement NOT to dispose the equipment including any spent or discarded batteries or accumulators as unsorted municipal waste, but use the return and collection systems available.

If the batteries, accumulators and button cells included with this equipment, display the chemical symbol Hg, Cd, or Pb, then it means that the battery has a heavy metal content of more than 0.0005% Mercury or more than, 0.002% Cadmium, or more than 0.004% Lead. Follow directive (2006/66 / EC) for battery disposal instructions.



Important Safety Instructions

1. Read these instructions.
2. Keep these instructions.
3. Heed all warnings.
4. Follow all instructions.
5. Do not use this unit near water.
6. Clean with a soft, dry cloth.
7. Do not block any ventilation openings. Install the unit in accordance with the manufacturer's instructions.
8. Do not install near any heat sources such as radiators, heat registers, stoves, or other devices (including amplifiers) that produce heat.
9. Do not defeat the safety purpose of the polarized or grounding-type plug. A polarized plug has two blades with one wider than the other. A grounding type plug has two blades and a third grounding prong. The wide blade and the third prong are provided for your safety. If the provided plug does not fit into your outlet, consult an electrician for replacement of the obsolete outlet.
10. Protect the power cord from being walked on or pinched particularly at plugs. Convenience receptacles and the point where they exit from the unit. Be sure that the power outlet is located near the unit so that it is easily accessible.
11. Only use attachments/accessories specified by the manufacturer.
12. Use only with the cart, stand, tripod, bracket, or table specified by the manufacturer, or sold with the unit. When a cart is used, use caution when moving the cart/unit combination to avoid injury from tipping over.
13. Unplug this unit when unused for long periods of time.
14. Refer all servicing to qualified service personnel. Servicing is required when the unit has been damaged in any way, such as: if the power-supply cord or plug is damaged, if liquid is spilled onto or objects fall into the unit, if the unit is exposed to rain or moisture, or if the unit does not operate normally or has been dropped.



Declaration of RoHS2 Compliance

This product has been designed and manufactured in compliance with Directive 2011/65/EU of the European Parliament and the Council on restriction of the use of certain hazardous substances in electrical and electronic equipment (RoHS2 Directive) and is deemed to comply with the maximum concentration values issued by the European Technical Adaptation Committee (TAC) as shown below:

Substance	Proposed Maximum Concentration	Actual Concentration
Lead (Pb)	0.1%	< 0.1%
Mercury (Hg)	0.1%	< 0.1%
Cadmium (Cd)	0.01%	< 0.01%
Hexavalent Chromium (Cr ⁶⁺)	0.1%	< 0.1%
Polybrominated biphenyls (PBB)	0.1%	< 0.1%
Polybrominated diphenyl ethers (PBDE)	0.1%	< 0.1%
Bis(2-ethylhexyl) phthalate (DEHP)	0.1%	< 0.1%
Butyl benzyl phthalate (BBP)	0.1%	< 0.1%
Dibutyl phthalate (DBP)	0.1%	< 0.1%
Diisobutyl phthalate (DIBP)	0.1%	< 0.1%

Certain components of products as stated above are exempted under the Annex III of the RoHS2 Directives as noted below:

Examples of exempted components are:

1. Lead in glass of cathode ray tubes.
2. Lead in glass of fluorescent tubes not exceeding 0.2% by weight.
3. Lead as an alloying element in aluminium containing up to 0.4% lead by weight.
4. Copper alloy containing up to 4% lead by weight.
5. Lead in high melting temperature type solders (i.e. lead-based alloys containing 85% by weight or more lead).
6. Electrical and electronic components containing lead in a glass or ceramic other than dielectric ceramic in capacitors, e.g. piezoelectronic devices, or in a glass or ceramic matrix compound.

Copyright Information

Copyright © ViewSonic® Corporation, 2020. All rights reserved.
Macintosh and Power Macintosh are registered trademarks of Apple Inc.
Microsoft, Windows, Windows NT, and the Windows logo are registered trademarks of Microsoft Corporation in the United States and other countries.
ViewSonic, the three birds logo, OnView, ViewMatch, and ViewMeter are registered trademarks of ViewSonic Corporation.
VESA is a registered trademark of the Video Electronics Standards Association.
DPMS and DDC are trademarks of VESA.
PS/2, VGA and XGA are registered trademarks of International Business Machines Corporation.
Disclaimer: ViewSonic Corporation shall not be liable for technical or editorial errors or omissions contained herein; nor for incidental or consequential damages resulting from furnishing this material, or the performance or use of this product.
In the interest of continuing product improvement, ViewSonic Corporation reserves the right to change product specifications without notice. Information in this document may change without notice.
No part of this document may be copied, reproduced, or transmitted by any means, for any purpose without prior written permission from ViewSonic Corporation.

Product Registration

To fulfill possible future product needs, and to receive additional product information as it becomes available, please visit your region section on ViewSonic's website to register your product online.
The ViewSonic CD also provides an opportunity for you to print the product registration form. Upon completion, please mail or fax to a respective ViewSonic office. To find your registration form, use the directory “:\CD\Registration”.
Registering your product will best prepare you for future customer service needs. Please print this user guide and fill the information in the “For Your Records” section. For additional information, please see the “Customer Support” section in this guide.

For Your Records

Product Name:	M1+ ViewSonic LED Projector
Model Number:	VS17337
Document Number:	M1+_UG_ENG Rev. 1B 05-28-20
Serial Number:	_____
Purchase Date:	_____

Product disposal at end of product life

ViewSonic respects the environment and is committed to working and living green. Thank you for being part of Smarter, Greener Computing. Please visit ViewSonic website to learn more.
USA & Canada: <http://www.viewsonic.com/company/green/recycle-program/>
Europe: <http://www.viewsoniceurope.com/eu/support/call-desk/>
Taiwan: <http://recycle.epa.gov.tw>

Table of Contents

Introduction.....	1
Projector features	1
Shipping contents	2
Package Overview.....	2
Product Overview	3
Controls and functions	4
Setting up	7
Power On/Off.....	8
Mount the Projector	10
Open the smart stand and adjust the focus ring.....	11
Adjust Projected Image	12
Positioning your projector.....	13
Using the menus.....	14
Adjusting your projector's settings.....	16
Connect the projector to your device.....	17
Different menu options	18
M1+ FW Upgrade	20
Wallpaper	21
Image Settings.....	21
About the aspect ratio.....	22
Auto Keystone	23
V Keystone	23
Brightness.....	23
Contrast.....	23
Projector Position	24
Harman Kardon - Adjusting the audio settings	25
Muting the Sound	25
Adjusting the Sound level.....	25

Adjusting the Audio Mode.....	26
Adjusting the Light source settings.....	26
Reset All Settings	27
Eye Protection	27
Viewing different file	27
Using the 3D function	31
OSD Menu System.....	42
Specification sheet	44
HDMI Support Video Timing	46
HDMI Support PC Timing	47
3D Support Timing.....	48
USB-C Support Timing	49

Introduction

Projector features

The Portable Cinema providing users with high-performance LED projection and a user-friendly design to deliver high reliability and ease of use.

Some of the features may not be available on your projector. Actual performance may vary and subject to model specifications.

- 360 degree smart stand enable instant Power ON / OFF (with Lens cover function).
- Auto keystone to correct distorted image automatically.
- Eye Protection function avoiding objects get close to the direct light from optical engine (30cm distance / 30 degree).
- USB-C for video transmission and power supply.
- Embedded battery for easy outdoor projection (up to 6 hours).
- Switchable light source mode to extend your battery usage hours.
- 16GB internal storage (Max. 12GB available storage for users).
- User-friendly UI design for easy navigation.
- Music mode enables users to enjoy music without projection image.
- Short throw lens design to allow 1.6m distance to project 60" screen size.
- LED light source with excellent light source life (30,000 hrs).
- Supports 3D display.
- Color modes providing choices for different projection purposes.
- Multi-language On-Screen Display (OSD) menus.

 **The apparent brightness of the projected image will vary depending on the ambient lighting conditions, selected input signal contrast/brightness settings, and is directly proportional to projection distance.**

Shipping contents

Package Overview

Carefully unpack and verify that you have all of the items shown below. If any of these items are missing, please contact your place of purchase.

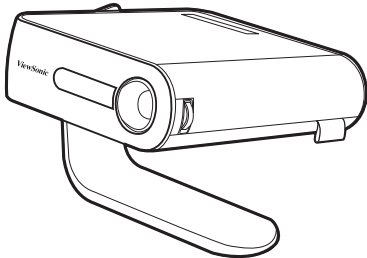

Projector



AC Power Cord

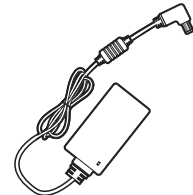

AC Power Adapter

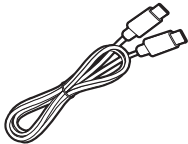

USB-C Cable (1M)



Remote Control (with batteries)

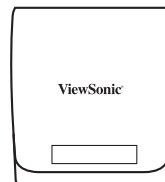

Soft Carrying Bag



Quick Start Guide

Others

- Warranty Card (for specific regions ONLY)

NOTES

- Due to different applications in each Country, some regions may have different accessories..
- Make sure to properly discard the used batteries according to local regulations.



Product Overview

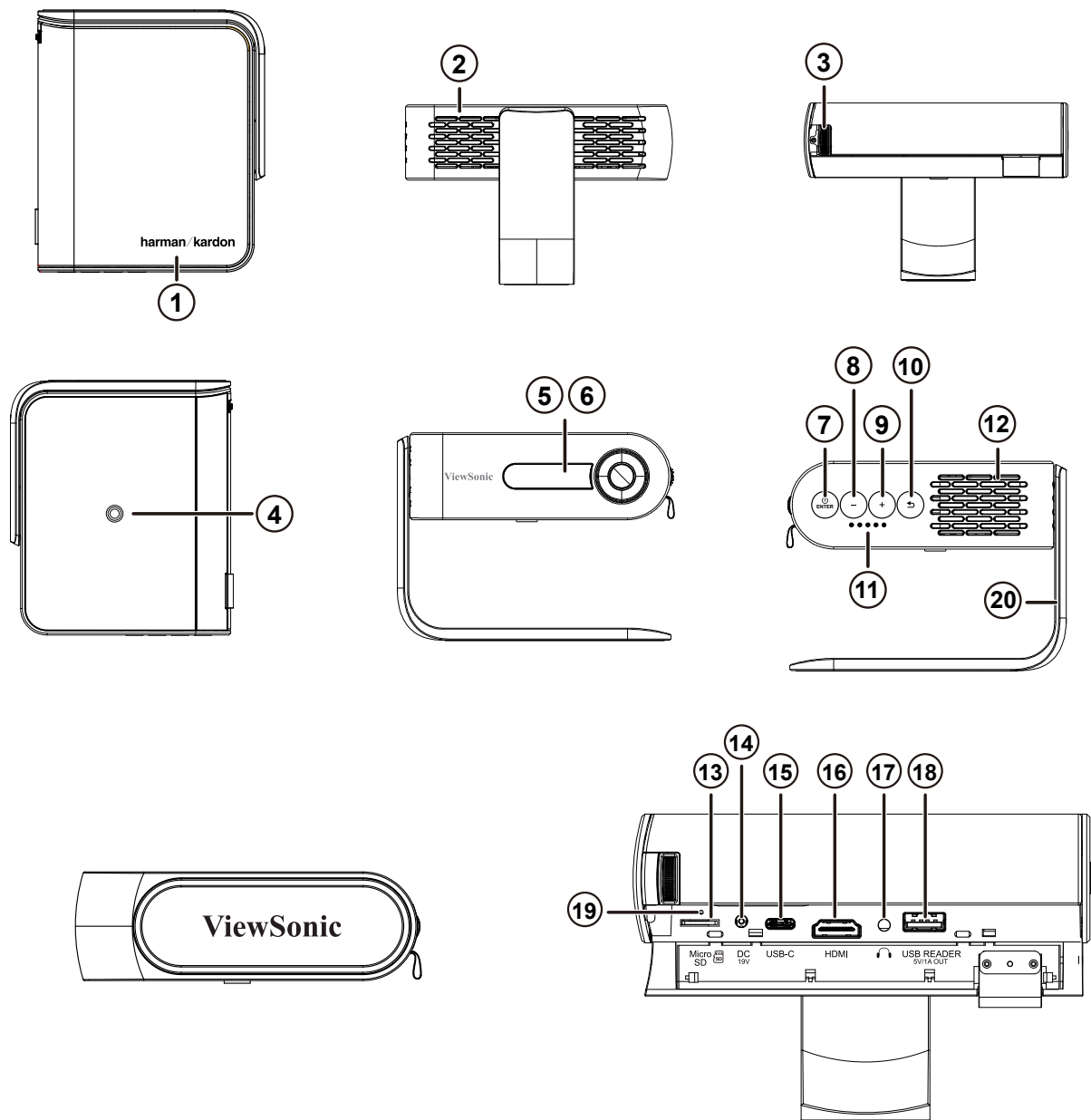

- | | | |
|--------------------------|-----------------------|----------------------------|
| 1. Speaker | 8. Volume - / Down | 15. USB-C |
| 2. Ventilation | 9. Volume + / Up | 16. HDMI port |
| 3. Focus Ring | 10. Return | 17. Headphone |
| 4. Tripod hole | 11. Battery indicator | 18. USB Reader (5V1A out) |
| 5. IR receiver | 12. Speaker PR | 19. Reset button** |
| 6. Eye Protection sensor | 13. Micro SD | 20. 360 degree smart stand |
| 7. Enter / Power button | 14. DC in | |

** Insert a paper clip into the reset button to restart the projector if system freezing.

Controls and functions

Projector

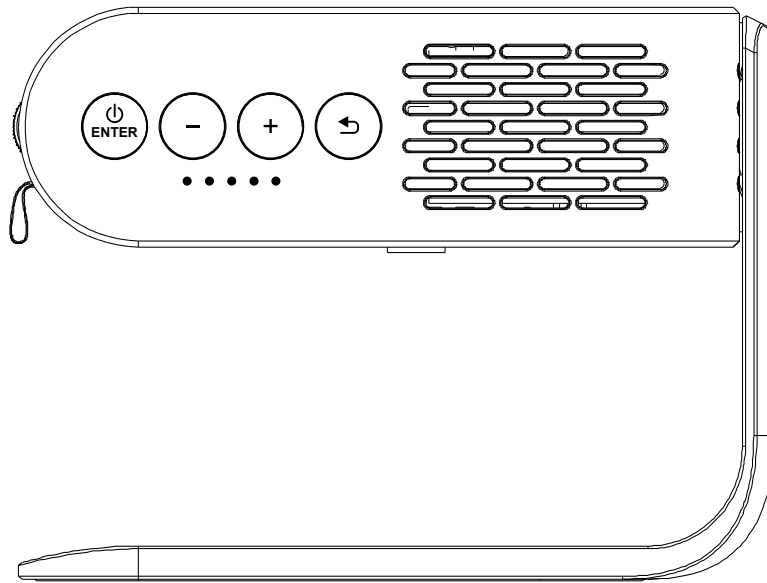

	Power / Enter <ul style="list-style-type: none">- Press 3 seconds to power on/off the projector- Enacts the selected On-Screen Display(OSD) menu item.
	Volume down <ul style="list-style-type: none">- Decrease the volume level.- Down
	Volume up <ul style="list-style-type: none">- Increase the volume level.- Up
	Return <ul style="list-style-type: none">- Return to the previous stage/level
	Battery indicator light <ul style="list-style-type: none">- Indicates the status of the embedded battery.

Remote Control

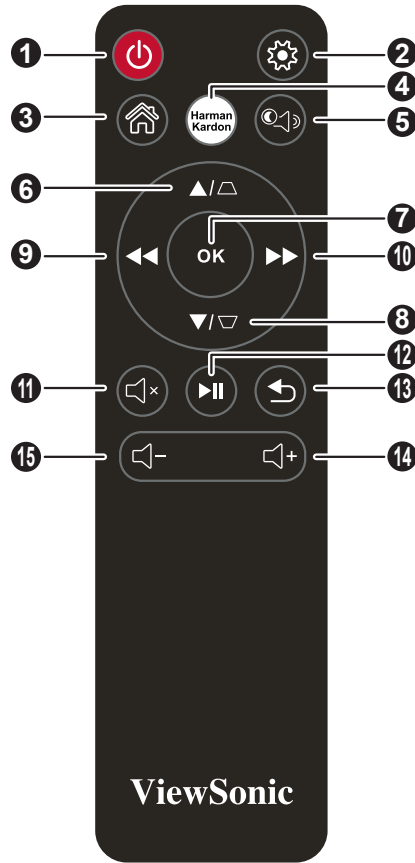

- | | |
|---------------------------|---------------------|
| 1. Power button | 9. LEFT / BACKWARD |
| 2. Settings | 10. RIGHT / FORWARD |
| 3. Home | 11. MUTE |
| 4. Harman Kardon Settings | 12. PLAY / PAUSE |
| 5. Bluetooth Mode | 13. RETURN |
| 6. UP / KEYSTONE | 14. Volume Up |
| 7. OK | 15. Volume Down |
| 8. DOWN / KEYSTONE | |

Remote control effectiverange

Refer to the illustration about the location of the Infra-Red (IR) remote control sensor(s). The remote control must be held at an angle within 30 degrees perpendicular to the projector's IR remote control sensor(s) to function correctly. The distance between the remote control and the sensor(s) should not exceed 8 meters (~26 feet).

Make sure that there are no obstacles between the remote control and the IR sensor(s) on the projector that might obstruct the infra-red beam.

Replacing the remote control battery

1. To open the battery cover, turn the remote control over to view its back, open the cover in the direction of the arrow as illustrated.
2. Remove any existing batteries (if necessary) and install two AAA batteries observing the battery polarities as indicated in the base of the battery compartment. Positive (+) goes to positive and negative (-) goes to negative.
3. Refit the cover by aligning it with the base and pushing it back down into position. Stop when it clicks into place.

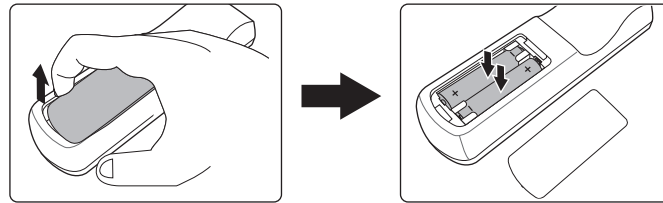

Warning

- Avoid leaving the remote control and batteries in an excessive heat or humid environment like the kitchen, bathroom, sauna, sunroom or in a closed car.
- Replace only with the same or equivalent type recommended by the battery manufacturer.
- Dispose of the used batteries according to the manufacturer's instructions and local environment regulations for your region.
- Never throw the batteries into a fire. There may be danger of an explosion.
- If the batteries are drained or if you will not be using the remote control for an extended period of time, remove the batteries to avoid damage to the remote control from possible battery leakage.

Setting up

Operating your projector

This portable projector allows you to plug and play your devices so you can easily open multimedia files and hear audio straight from its built-in Harman Kardon speakers.

For your safety and to maintain the quality of this unit, refer to the following steps when operating your Projector.

Power On/Off

Using power cord

1. Connect the power cord to the power adapter.
2. Connect the AC power cord to a power source
3. Connect the DC power connector to your projector.

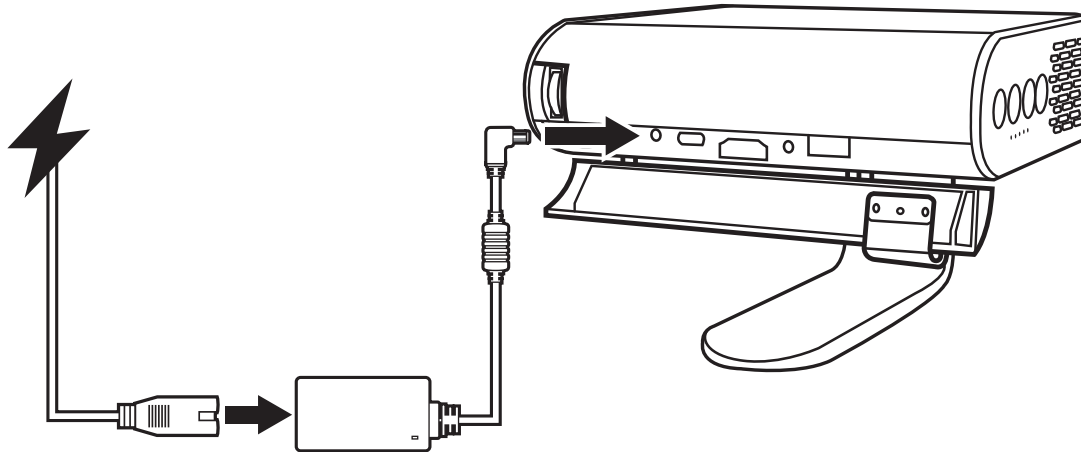

 Charge the projector for 4.5 hours before using it in battery mode for the first time.

IMPORTANT!

- Use only the bundled power adapter to charge the battery pack and supply power to your LED projector.
- Ensure that your LED projector is connected to the power adapter before turning it on for the first time. We strongly recommend that you use a grounded wall socket while using your LED projector on power adapter mode.
- The socket outlet must be easily accessible and near your LED projector.
- To disconnect your LED projector from its main power supply, unplug your LED projector from the power socket.

Warning

Read the following precautions for your LED projector's battery.

- The battery used in this device may present a risk of fire or chemical burn if removed or disassembled.
- Follow the warning labels for your personal safety. • Risk of explosion if battery is replaced by an incorrect type.
- Do not dispose of in fire. • Never attempt to short-circuit your LED projector's battery.
- Never attempt to disassemble and reassemble the battery.
- Discontinue usage if leakage is found. • The battery and its components must be recycled or disposed of properly.
- Keep the battery and other small components away from children,

Using The Battery

Warning message is displayed when the battery is running out.

As your battery is low, the projector will be turned off in a minute.

If the screen shows a low battery message, be sure to charge the battery.

Battery using time information

Status	Time and Display
Charging	About 4.5 hours
Usage Hours	Up to <u>6hrs</u> battery life (with Battery Saving mode and without USB power supply)
Battery Level indicator (Charging)	<ul style="list-style-type: none">• During charging: Power button with Red LED light up• Full charge: Power button with White LED light up



There will be a very low power consumption during standby mode, suggest to full charge the battery before usage every time.

Mount the Projector

Screw a standard tripod into the screw hole on the projector.

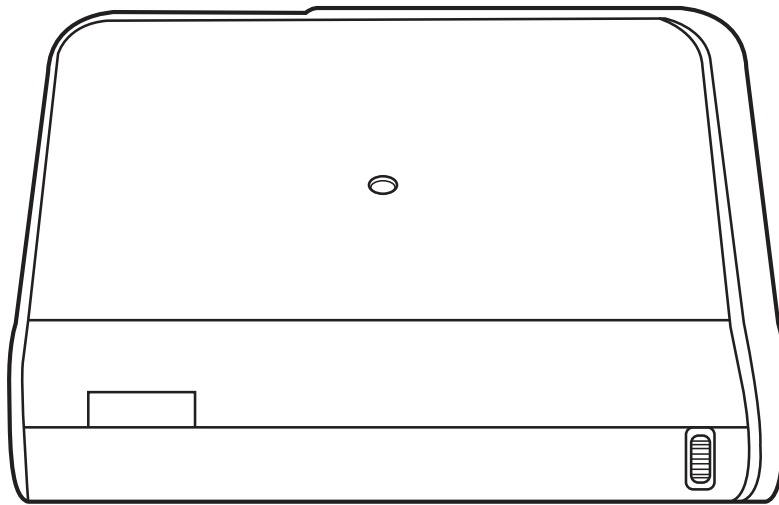

 The tripod is not included.

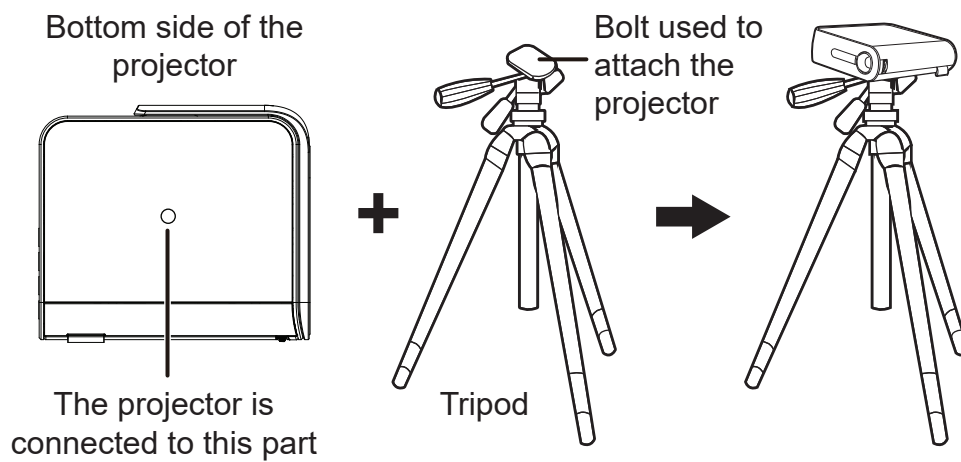

Open the smart stand and adjust the focus ring

- Open the smart stand by moving its lens cover down

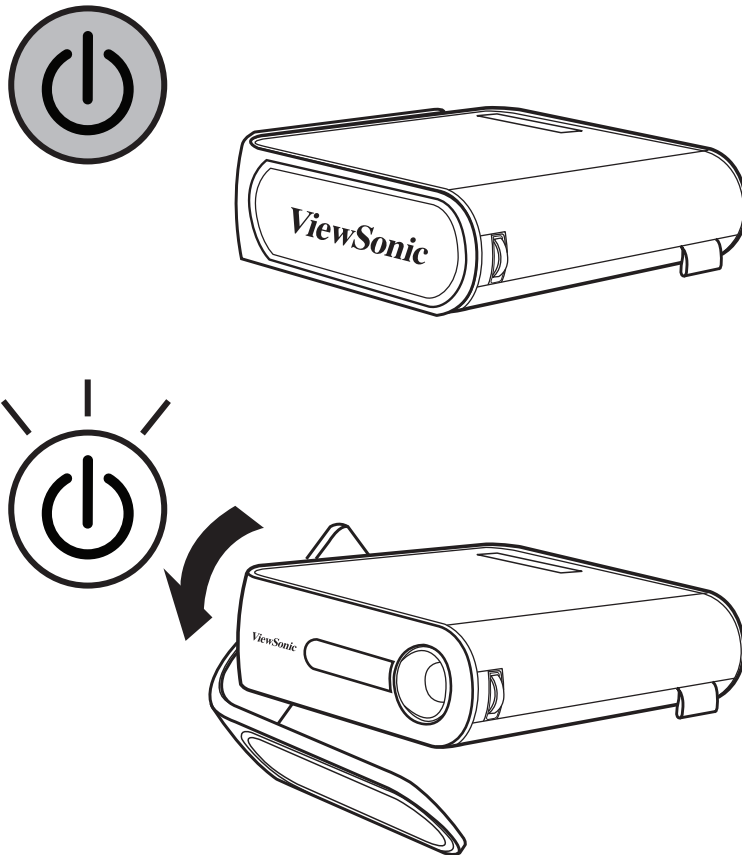

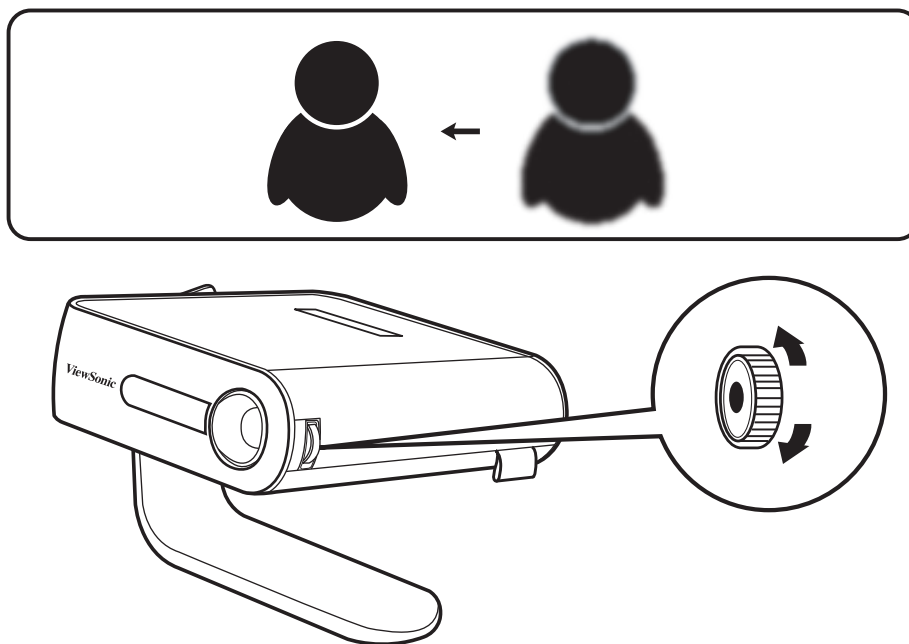

- Adjust the image focus of the projection onscreen by moving the focus ring up and down.

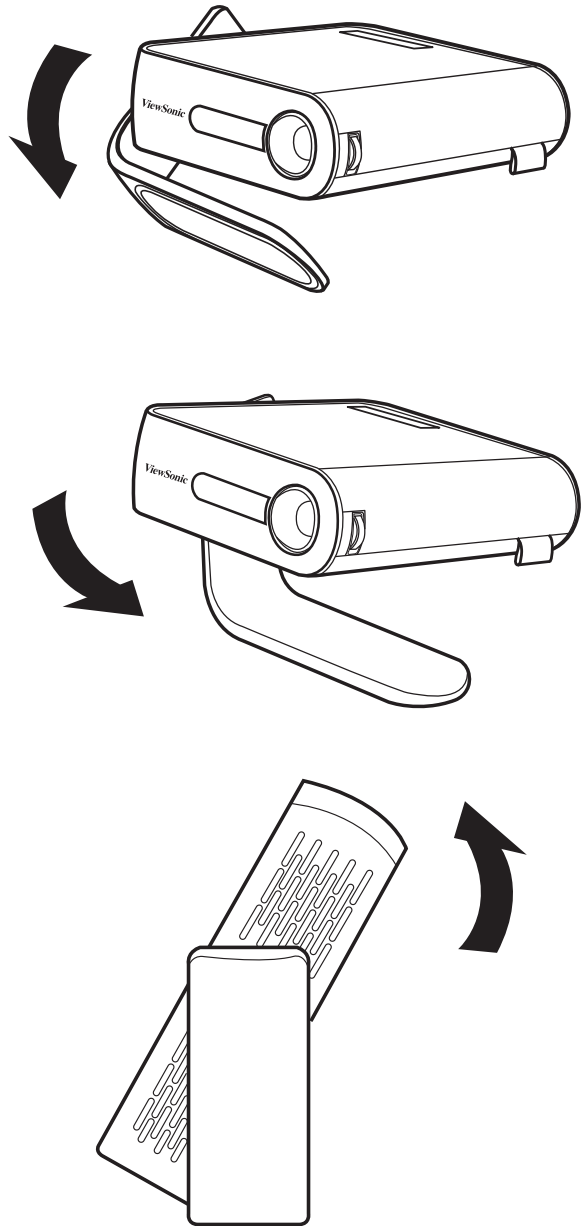

Adjust Projected Image

The projector is equipped with a smart stand for adjusting the projected image



 Using Auto Keystone to adjust image (refer to details in Page 29)

Positioning your projector

Screen size and projection distance table

Adjust the LED projector's distance from the screen using the below table:

(a) Screen Size		16:9 image on a 16:9 Screen					
		(b) Image Width		(c) Image height		(d) Projection Distance	
inch	mm	inch	mm	inch	mm	inch	mm
24	610	21	531	12	299	25	637
30	762	26	664	15	373	31	796
40	1016	35	885	20	498	42	1062
50	1270	44	1106	25	622	52	1327
60	1524	52	1327	29	747	63	1593
70	1778	61	1549	34	871	73	1858
80	2032	70	1770	39	996	84	2124
90	2286	78	1991	44	1120	94	2389
100	2540	87	2212	49	1245	105	2655

Using the menus

The projector is equipped with On-Screen Display (OSD) menus for making various adjustments and settings.

The OSD screenshots below are for reference only, and may differ from the actual design. Below is the overview of the OSD menu.

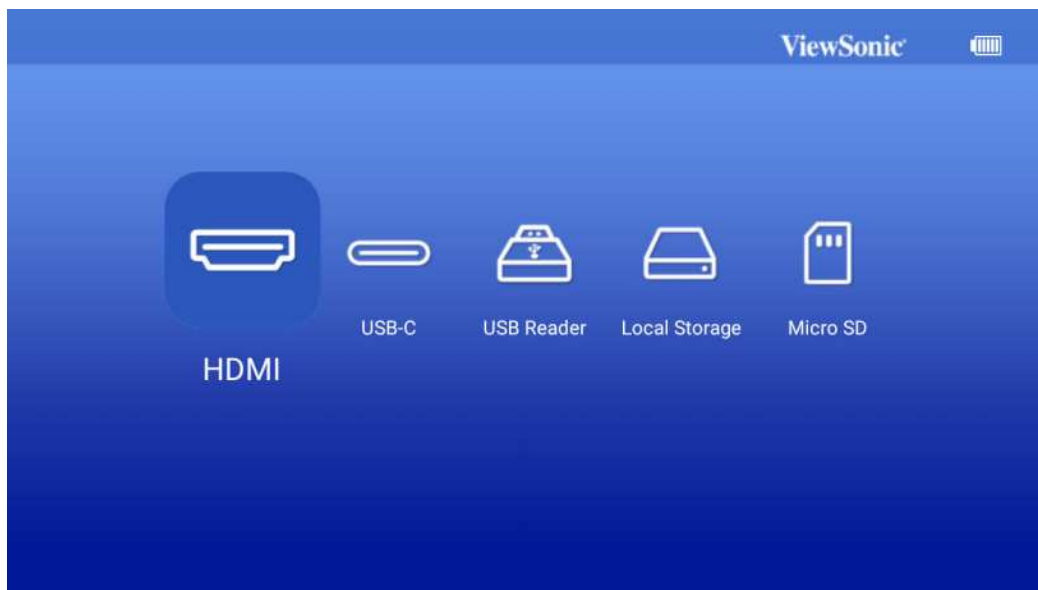
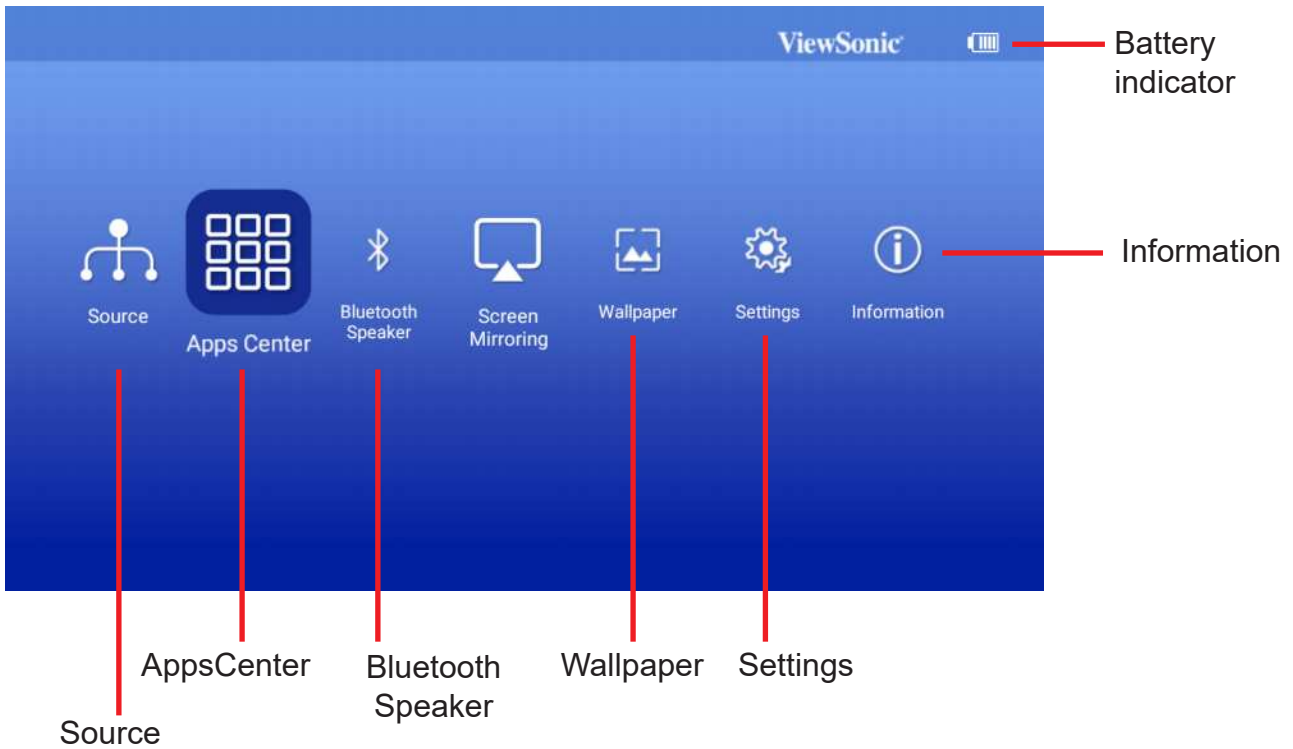

Launch the onscreen display by opening the smart stand of your projector
OSD menus will be shown after ViewSonic start up screen.

To use the OSD menus, please select your language first.

1. Press Settings button on remote to turn the OSD setting page on
2. Use < / > to highlight the Settings menu.

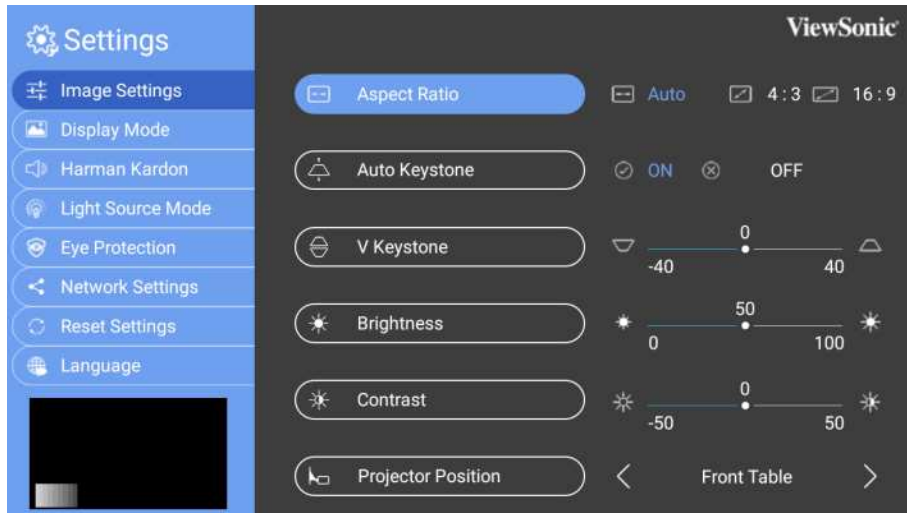

3. Press ▼ to highlight language and press to select a preferred Language.
4. Press OK to save the settings
5. Press Return / Home button to leave or return to Home page.

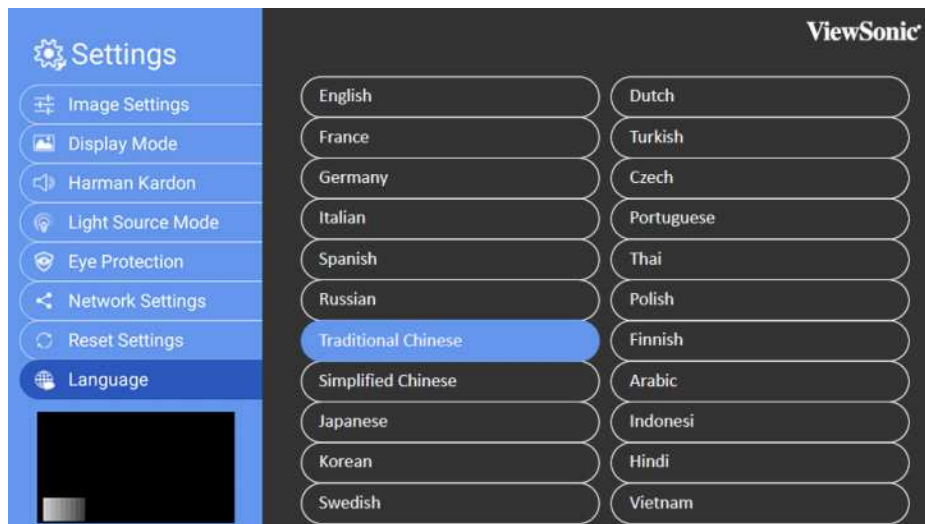

Adjusting your projector's settings

Refer to the following steps when accessing the onscreen display menu options to adjust your projector settings:

1. Launch the onscreen display menu
2. Press < / > to select the menu option you would like to access
3. Press < / > to adjust the settings according to your preference.
4. Press OK to save the new settings.
5. Press settings to go back the settings page
6. Press Home to go back to the home page

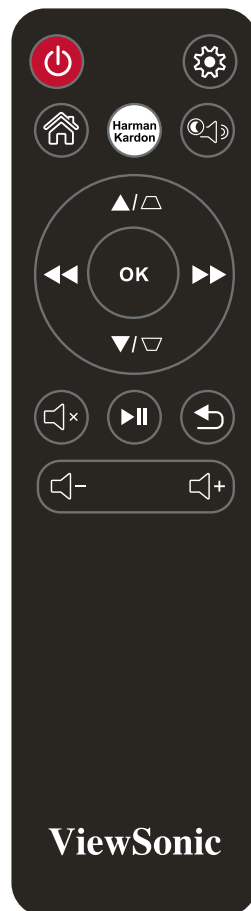

Connect the projector to your device

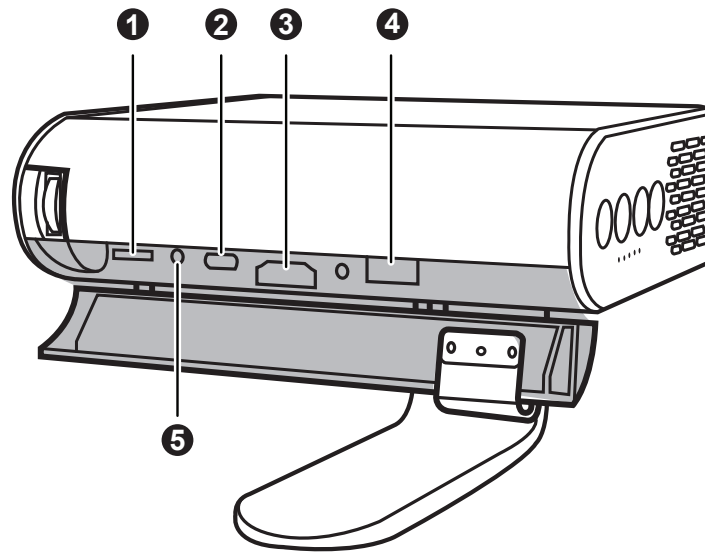

1. Please use the supplied USB-C cable to make sure the compatibility.
2. Please make sure your USB-C device can support video transmission

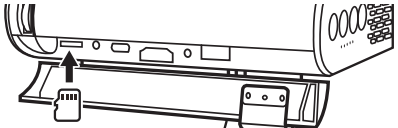
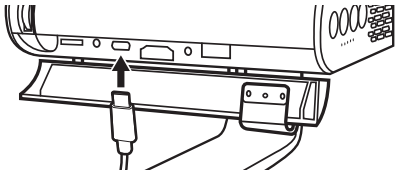
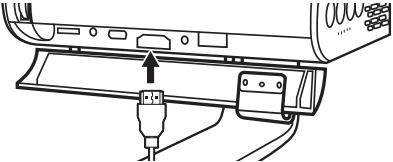
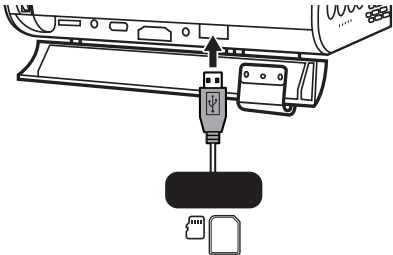
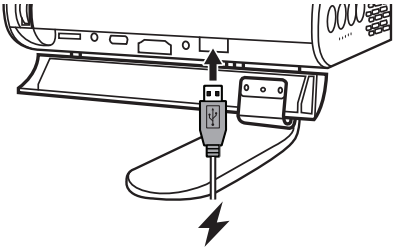
1	Micro SD - SDHC (up to 32GB) - FAT32 / NTFS	
2	USB-C	
3	HDMI - iPhone/iPad need to buy additional adapter, to avoid compatible issue, please use Apple authorized accessories	
4	USB Reader - FAT32 / NTFS - Hard disk support up to 1TB	
5	USB Power Supply (5V1A)	

Different menu options

Switching input signal

Different input signals can be used to connect with the projector.

1. Different source is shown on the OSD homepage.
2. Press < / > until your desire signal is selected and press OK.

Once detected, the selected source information will be displayed on the screen for seconds.

HDMI 1.4 / HDCP 1.4 support timing:

480i
480p
576i
576p
720/50p
720/60p
1080/24P
1080/25P
1080/30P
1080/50i
1080/60i
1080/50P
1080/60P

USB Reader

- Flash Drive support up to 128GB
- Format: FAT32 / NTFS
- Hard disk support up to 1TB
- FW update



M1+ FW Upgrade

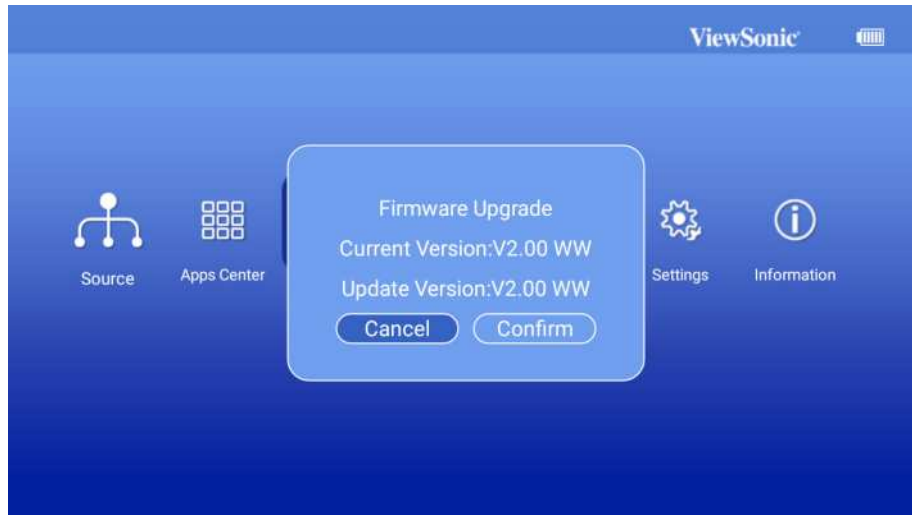

1. Copy FW “MstarUpgrade.bin and M1+.bin)” to FAT32 USB from ViewSonic website
2. Power on the projector
3. Plug in USB with new FW (USB Format: FAT32)
4. Auto detect and pop up FW upgrade confirmation message



5. Click “**Confirm**”
6. Page with the loading bar will be appeared
7. After reached 100%, will return to ViewSonic start up screen for loading again
8. The whole upgrading process will take around 5~10 mins
9. After finishing the process, will return to the Home page

Wallpaper

Select this menu option to change the OSD wallpaper.

You may select your preferred picture from the pre-installed wallpaper collection.

GO to **Wallpaper** > choose selected wallpaper and press OK

Wallpaper example:

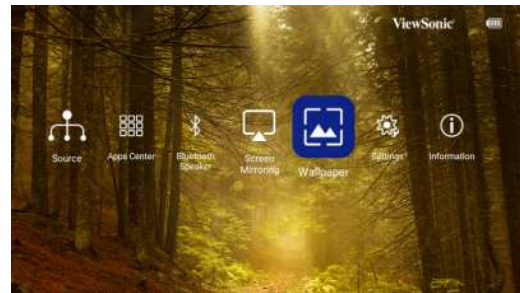
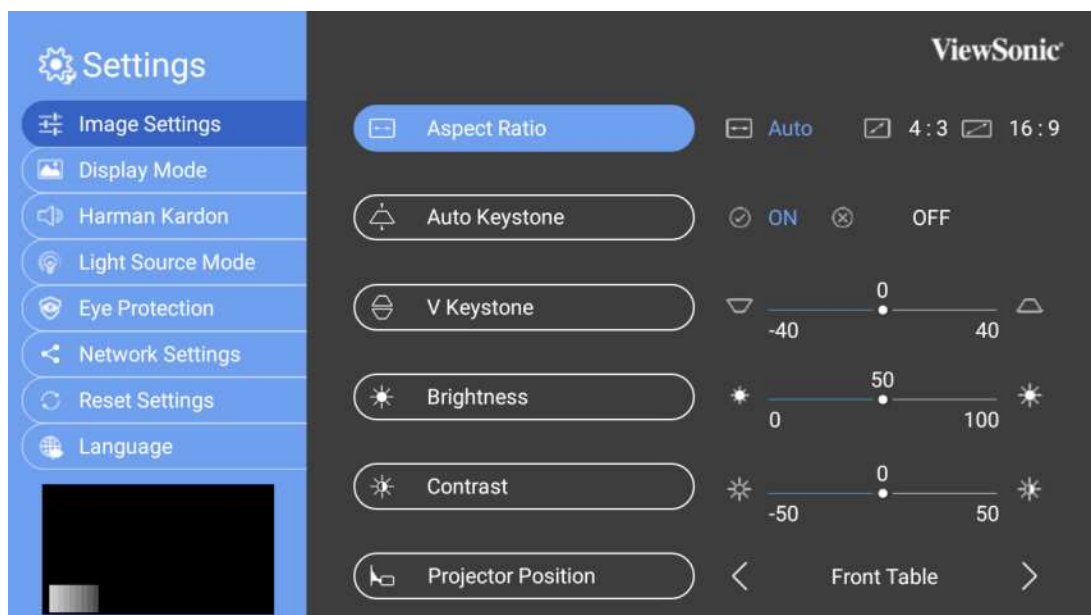

Image Settings

Aspect Ratio

Go to **Settings** > **Image Settings** > **Aspect Ratio**

Press < / > to select an aspect ratio to suit the format of the video signal and your display requirements, and press OK.



About the aspect ratio

 In the picture below, the black portions are inactive areas and the white portions are active areas. OSD menus can be displayed on those unused black areas.

1. **Auto:** Proportional scaling of an image to fit the projector's natural resolution in its horizontal width. This is suitable where the incoming image is neither in 4:3 nor 16:9 aspect ratios but where you want to make most use of the screen without altering the image's aspect ratio.

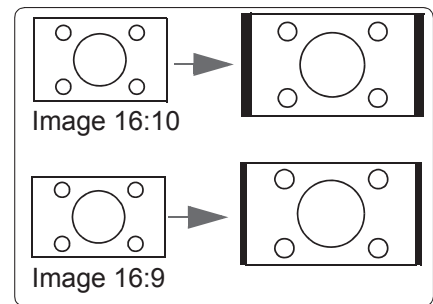

2. **4:3:** Scales a picture so that it is displayed in the center of the screen with a 4:3 aspect ratio. This is most suitable for 4:3 pictures such as those for computer monitors, standard definition TV, and 4:3 aspect DVD movies as these can be displayed without aspect alteration.

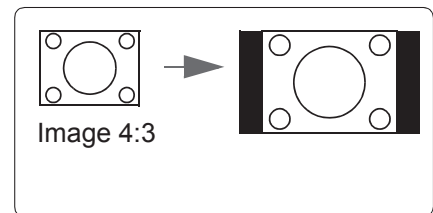

3. **16:9:** Scales a picture so that it is displayed in the center of the screen with a 16:9 aspect ratio. This is most suitable for images which are already in a 16:9 aspect such as high definition TV because as these can be displayed without aspect alteration.

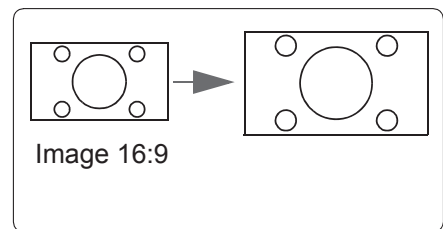

Auto Keystone

Auto Keystone provides a rectangular screen image by automatically adjusting the Keystone number when there is a trapezoidal screen image caused by tilting of the projector.

Go to **Settings > Image Settings > Auto Keystone**

Press < / > to select:

- ON: Automatically adjusts the Keystone number.
- OFF: Manually adjusts the Keystone number.

V Keystone

To prevent the screen image from becoming trapezoidal, Keystone adjusts the top and bottom width of the image if the projector is not set at a right angle to the screen.

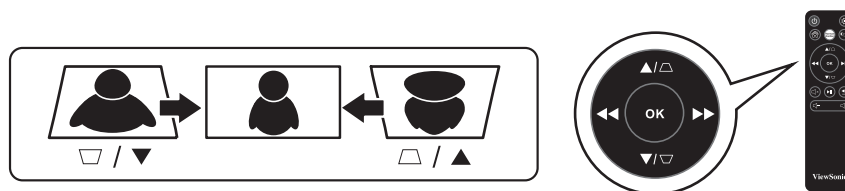

Go to **Settings > Image Settings > V Keystone**

Press < / > to adjust keystone, keystone can be adjusted from -40 to 40.

Press OK when finished.

If available, you can press keystone buttons on the remote control to adjust the projector's keystone.

Brightness

The higher the value, the brighter the image. And lower the setting, darker the image. Adjusting this control so the black areas of the image to appear just as black and that detail in the dark areas is visible.



Go to **Settings > Image Settings > Brightness**

Press < / > to adjust brightness, brightness can be adjusted from 0 to 100.

Press OK when finished.

Contrast

The higher the value, the greater the contrast. Use this to set the peak white level after you have previously adjusted the Brightness setting to suit your selected input and viewing environment.



Go to **Settings > Image Settings > Contrast**

Press < / > to adjust contrast, contrast can be adjusted from -50 to 50.

Press OK when finished.

Projector Position

Personal preference and room layout will decide the installation location.

Go to **Settings > Image Settings> Projector Position**

Press < / > to adjust position.

Press OK when finished.

The projector is designed to be installed in one of the following locations:

1. Front Table

The projector is placed near the floor in front of the screen.

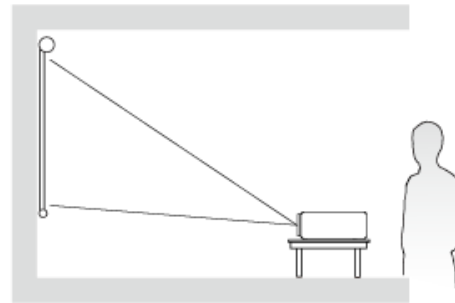

2. Front Ceiling

The projector is suspended upside-down from the ceiling in front of the screen.

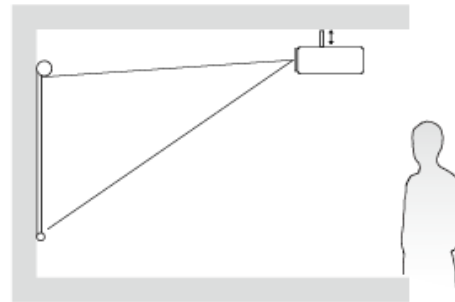

3. Rear Ceiling

The projector is suspended upside-down from the ceiling behind the screen.

NOTT: A special rear projection screen is required.

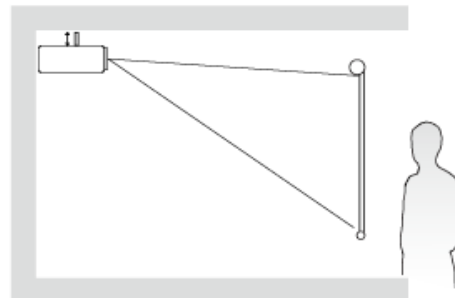

4. Rear Table

The projector is placed near the floor behind the screen.

NOTT: A special rear projection screen is required.

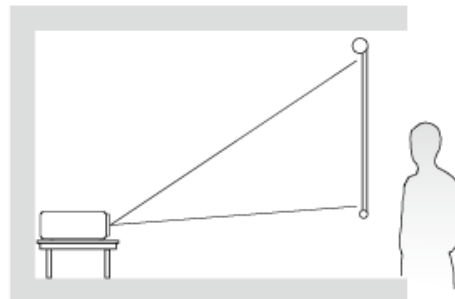

Optimizing the image

Select the Display Mode

The projector is preset with several predefined picture modes so that you can choose one to suit your operating environment and input signal picture type.

To select an operation mode that suits your need, you can follow one of the following steps.

Go to **Settings** > Display Mode

Press up / down to select a desired mode.

Press OK when finished.

Display Mode	Mode	
	Brightest	Maximizes the brightness of the projected image. This mode is suitable for environments where high brightness is required, such as using the projector in well lit rooms.
	Standard	Displays images in standard levels of contrast, brightness, and sharpness.
	Theater	Optimizes the image for movie.

Harman Kardon - Adjusting the audio settings



The sound adjustments made as below will have an effect on the projector speaker.

Muting the Sound

Go to **Settings** > Harman Kardon > MUTE

Press < / > to adjust ON / OFF.

Press OK when finished.

 If available, you can press  on the remote control to toggle the projector audio between on and off.

Adjusting the Sound level

Go to **Settings** > Harman Kardon > Audio Volume

Press < / > to adjust volume, volume can be adjusted from 0 to 20.

Press OK when finished.

 If available, you can press  or  on the remote control to adjust the projector's sound level.

Adjusting the Audio Mode

Go to **Settings** > **Harman Kardon** > **Audio Mode**

Press up / down to select a desired mode.

Press OK when finished.

Sound Mode	Mode	
	Movie	Sets audio optimized for a specific genre.
	Bass Booster	
	Instrumental	

If available, you can press Harman Kardon on the remote control to adjust the projector's sound mode.

Adjusting the Light source settings

Go to **Settings** > Light Source Mode

Press up / down to select a desired mode.

Press OK when finished.

To keep the projection playtime as long as possible, you can do the following settings via the OSD menu.

Light Source Mode	Mode		Playtime for Battery
	Full	• Default mode when connecting with power adapter	2.5 hours
	Eco	• Default mode when using with embedded battery.	3 hours
	Extended Eco		4 hours
	Battery Saving		6 hours

Using Battery Saving mode reduces system noise and power consumption. If the Battery saving mode is selected, the light output will be reduced and result in darker projected pictures.

Reset All Settings

Returns all settings to the factory preset values.

The following settings will still remain: Language, Keystone, Go to **Settings > Reset Settings > All Settings**

Press < / > to select Reset / Cancel.

Press OK when finished.

Eye Protection

To protect children's eye on direct light damage, when an object get closer to the lens, and will automatically turn to a blank image

Distance: 30cm / 30 degree between the lens and the object

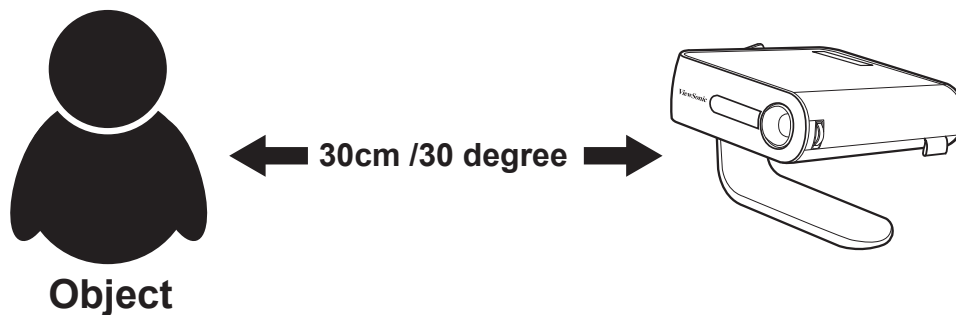

Go to **Settings > Eye Protection**

Press < / > to select sensor ON / OFF.

Press OK when finished.

Viewing different file

Go to **Homepage > selected input source**

Connect a device:

- USB Reader
- Local Storage
- Micro SD

Use up and down, </> button to select the file you want and press the OK button

For single file: Press OK when finished.



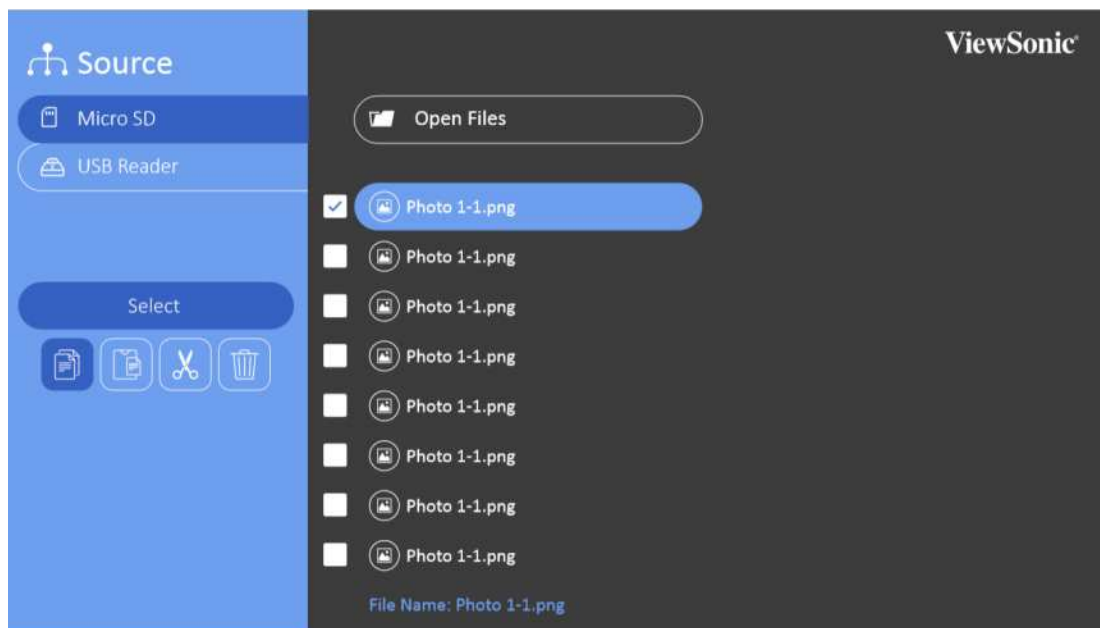
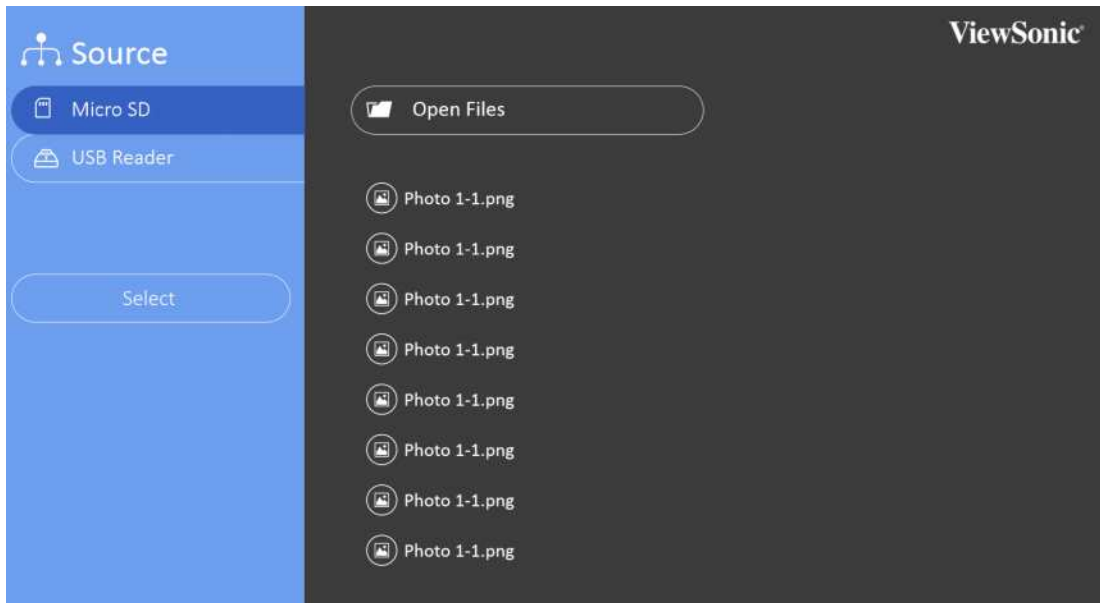













For multiple files: Click “Select”, boxes will be appeared in front of each file, press OK and up/down to select multiple files. Then select Copy / Paste / Cut/ Delete under “Select” button. Go to Homepage and select your sources again, Paste your selected files on your desired location.



- Photo: Slide show supported
- Video: Repeat supported
- Music: Repeat / shuffle supported

Press OK on remote control or Enter on keypad to show the control bar when playing video / music / photo.

Control playback by using the following buttons.

Picture		Video	
	Backward		Backward
	Play		Fast backward
	Next		Play
	Zoom in		Pause
	Zoom out		Fast Forward
	Rotate (left)		Next
	Rotate (right)		Volume Control
	Others (including 3D settings)		Others (including 3D settings)

Office support format

		Items	Indicators
I.	Document viewing function	1 doc/docx	Able to open and read documents in doc/docx
		2 xls/xlsx	Able to open and read documents in xls/xlsx
		3 ppt/pptx	Able to open and read documents in ppt/pptx
		4 Pdf	Able to open and read documents in pdf
II.	Supporting Interface Language	1 Supporting Interface 44 languages	English, Simplified Chinese, Chinese (TW), Chinese (HK), Spanish (LA), French (EU), PT (EU), PT (BR), German, Russian, Italian, Swedish, Spanish (EU), Korean, Arabic, Farsi, Serbian, Bosnian, Macedonian, Bulgarian, Ukrainian, Greek, Norwegian, Danish, Czech, Hungarian, Slovak, Polish, Romanian, Finnish, Estonian, Latvian, Lithuanian, British English, Slovenian, Croatian, Turkish, Vietnamese, Bahasa Indonesia, Dutch, Malay, Thai, Hindi, Hebrew, Burmese, Catalan.

Tips for using USB reader:

- Some USB storage devices may not work or may work incorrectly.
- If you use a USB extension cable, the USB device may not be recognized or may not work properly.
- Use only USB storage devices formatted with the Windows FAT32 or NTFS file system.
- If the file size is too large or users moving too fast to next page, it will take some time for file loading.
- Data in USB storage device can be damaged so be sure to back up important files. Data maintenance is the user's responsibility and the manufacturer is not responsible for data loss.

Multimedia support format

Extension	Codec	
.xvid .avi	Video	Xvid, H.264
	Audio	MP3
.mp4 .m4v .mov	Video	H.264/MPEG 4
	Audio	AAC
.mkv	Video	H.264
.ts .trp .tp .mts .m2ts	Video	H.264, MPEG2
	Audio	MP3/AAC
	Video	MPEG1, MPEG2
	Audio	DVD-LPCM
	Video	MPEG1

Using the 3D function

This portable cinema features 3D function which enables you to enjoy 3D movies, videos, and sporting events in a more realistic way by presenting the depth of the images. You need to wear a pair of 3D glasses to view 3D images.

If the 3D signal is input from an HDMI 1.4a compatible device, the portable cinema detects the signal for 3D Sync information and once detected, it projects images in 3D format automatically.

To activate 3D functions:

1. Press OK, video control bar will pop up when playing videos
2. Select the 3D settings icon, the 3D Settings menu is displayed in the right bottom corner.
3. Highlight 3D self detect and change to Auto.

When the 3D Sync function is on:

- The brightness level of the projected image will decrease.
- The Color Mode cannot be adjusted.

If you discover the inversion of the 3D image depth, set the 3D Sync Invert function to ON to correct the problem.

Video Control Menu



3D OSD menu



Wireless Connection

Wireless Screen Mirroring

Screen Mirroring provides a wireless connection for users to mirror the screen on their personal iOS or Android smart device.



To use Screen Mirroring:

1. Open the M1+ Settings, and go to: **Network Settings > Wi-Fi > On.**
2. Connect the M1+ to your wireless router.

NOTE: Ensure your device is connected to the same network as the projector.

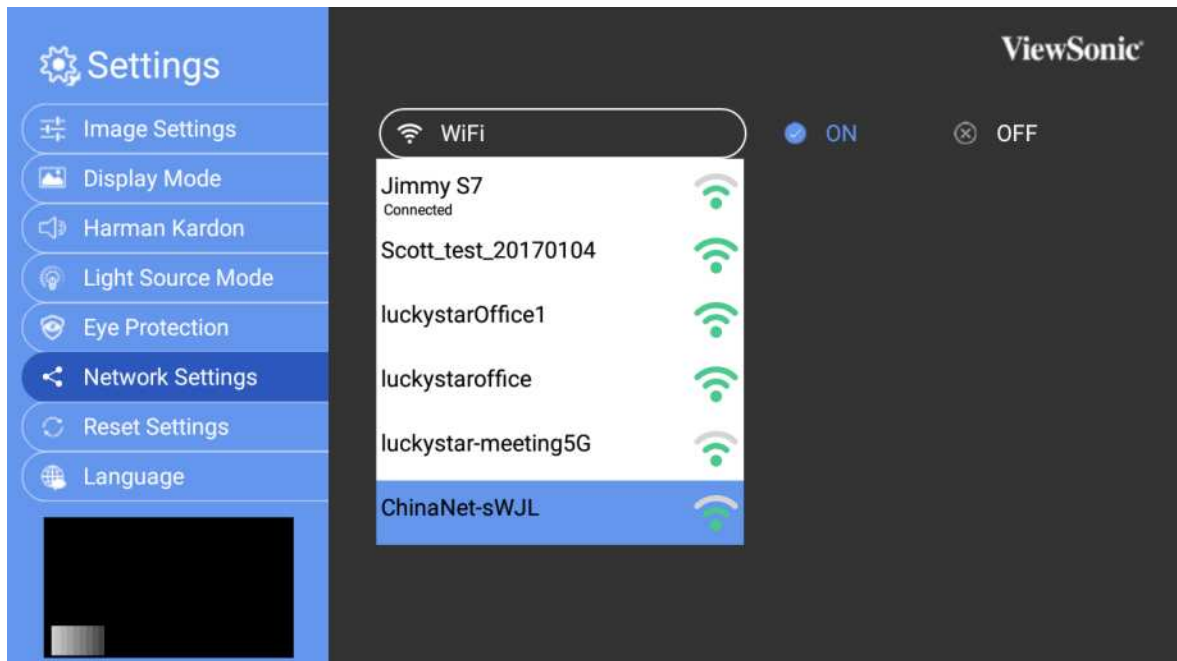

3. On the Home Screen, select **Screen Mirroring**.

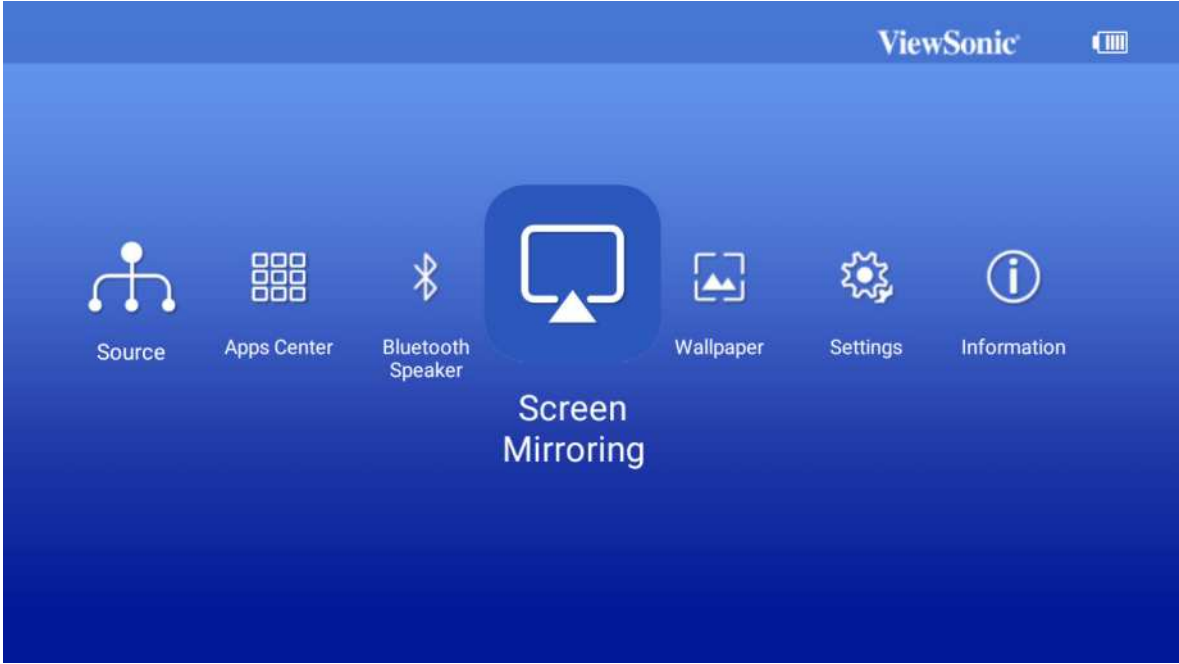

4. Once inside the **Screen Mirroring** menu, follow the below directions:

NOTE: Ensure your device is connected to the same network as the projector.

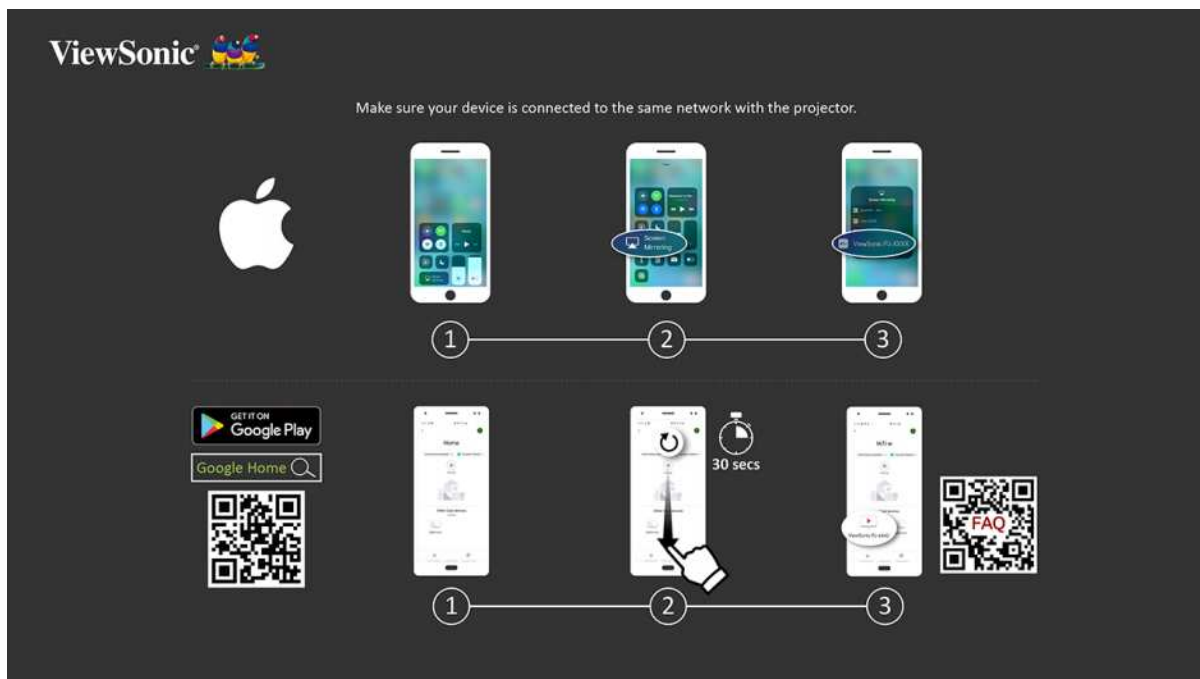

For iOS:

1. Access the drop down control menu.
2. Select the “Screen Mirroring” icon.
3. Choose “ViewSonic PJ-XXXX”.

For Android:

1. Download and install the “Google Home” application and open it.
2. Pull-to-refresh the app and wait for 30 seconds.
3. “ViewSonic PJ-XXXX” will now be visible, select it.

NOTE:

- Some Android devices support direct “Casting”. If your device does, go to the Casting feature and choose “ViewSonic PJ-XXX” from the list of available devices. You can also scan the FAQ QR code and follow the steps to directly cast your Android device.
- Ensure your network environment is working normally.
- Wireless network quality will affect performance.
- 5Ghz Wi-Fi connection is preferred and better than 2.4Ghz.
- The Netflix App is not supported.

Using the Bluetooth Speaker

The projector is equipped with a Bluetooth speaker that allows the user to connect their device wirelessly for audio playback.

To connect and pair your device:

1. On the Home Screen, select **Bluetooth Speaker**.

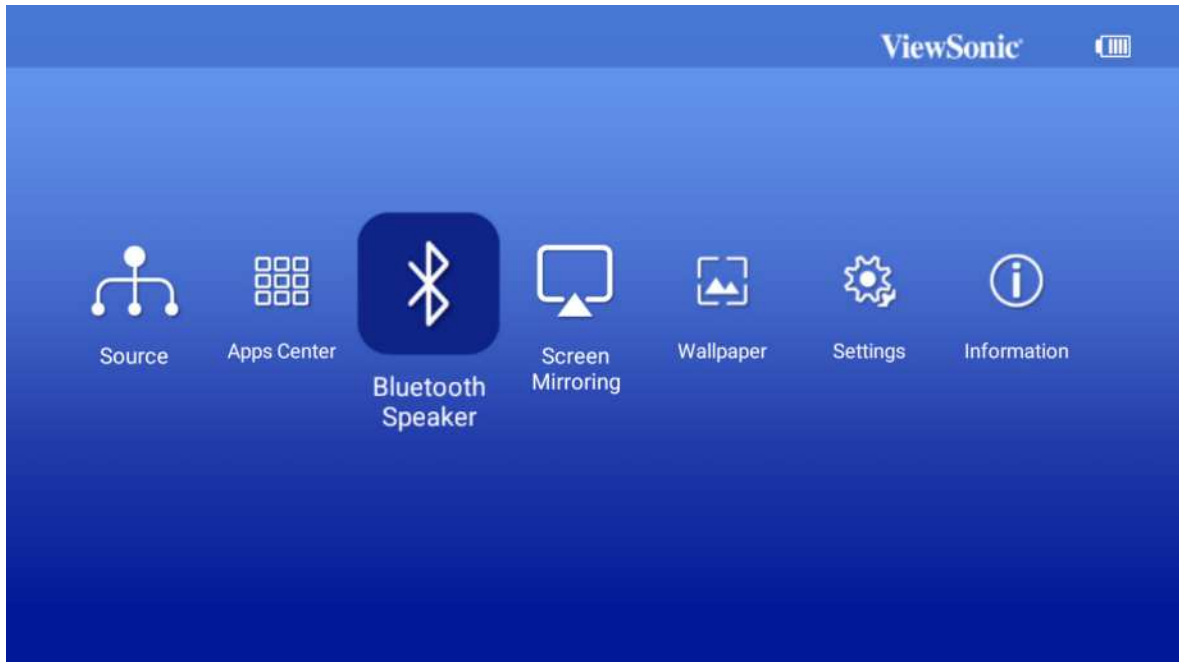

2. When prompted, select "Confirm".

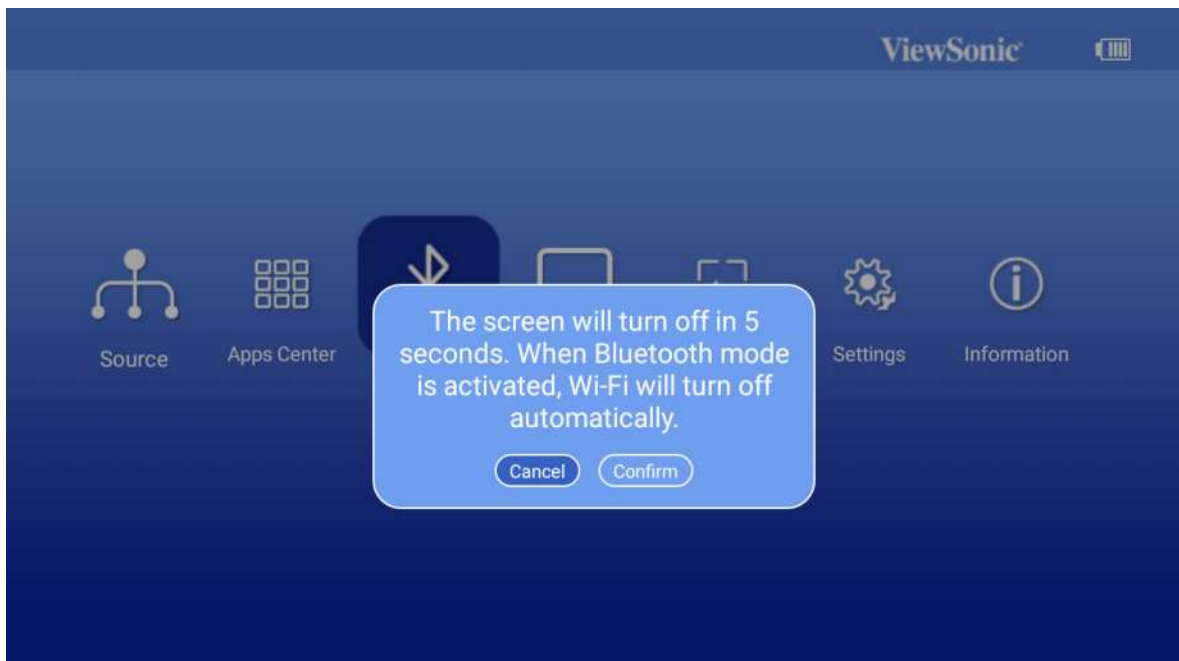

3. Additionally, you can also use the remote control to activate the Bluetooth Speaker.

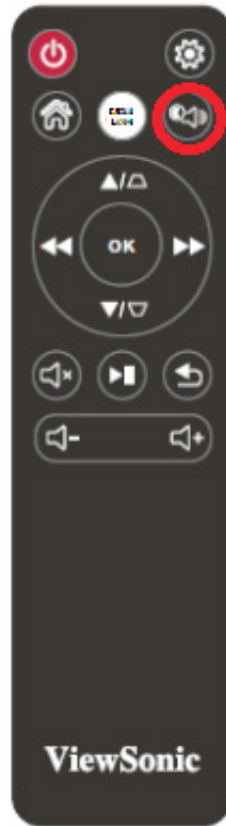

Apps Center

View, launch, and uninstall Apps.

4. To view your Apps, select: **Home > Apps Center**.

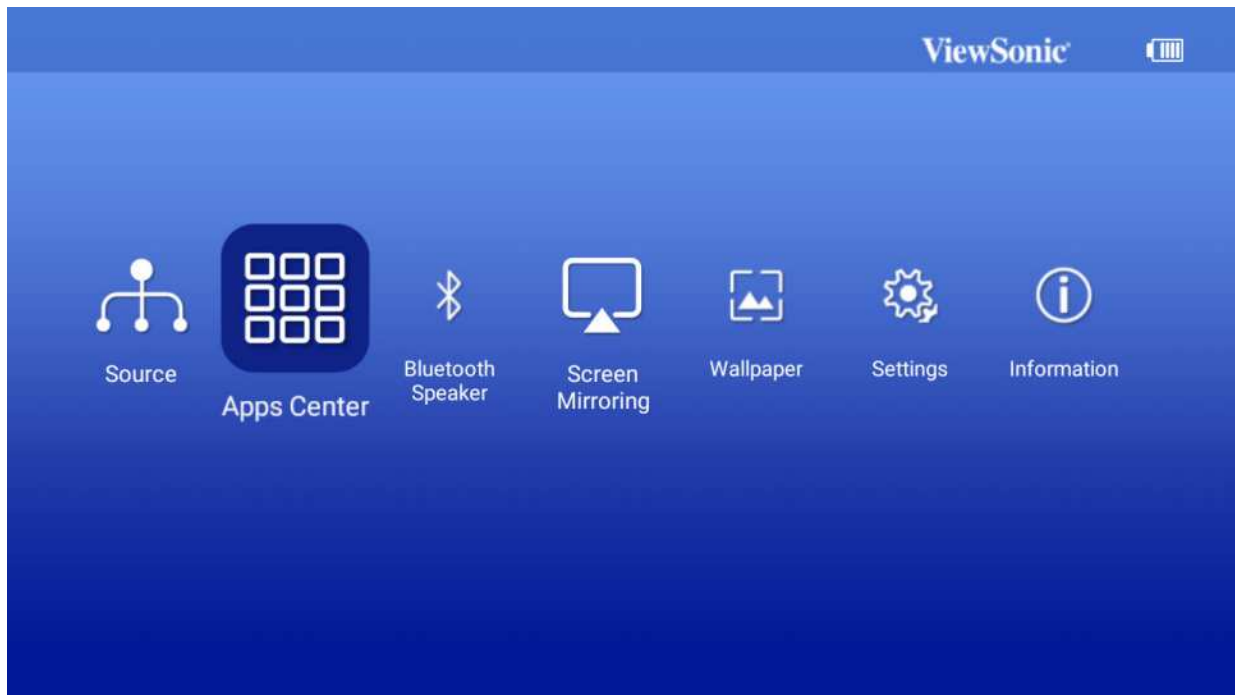

5. Use the direction buttons to select the desired App. Then press **OK** on the remote control to launch the App.

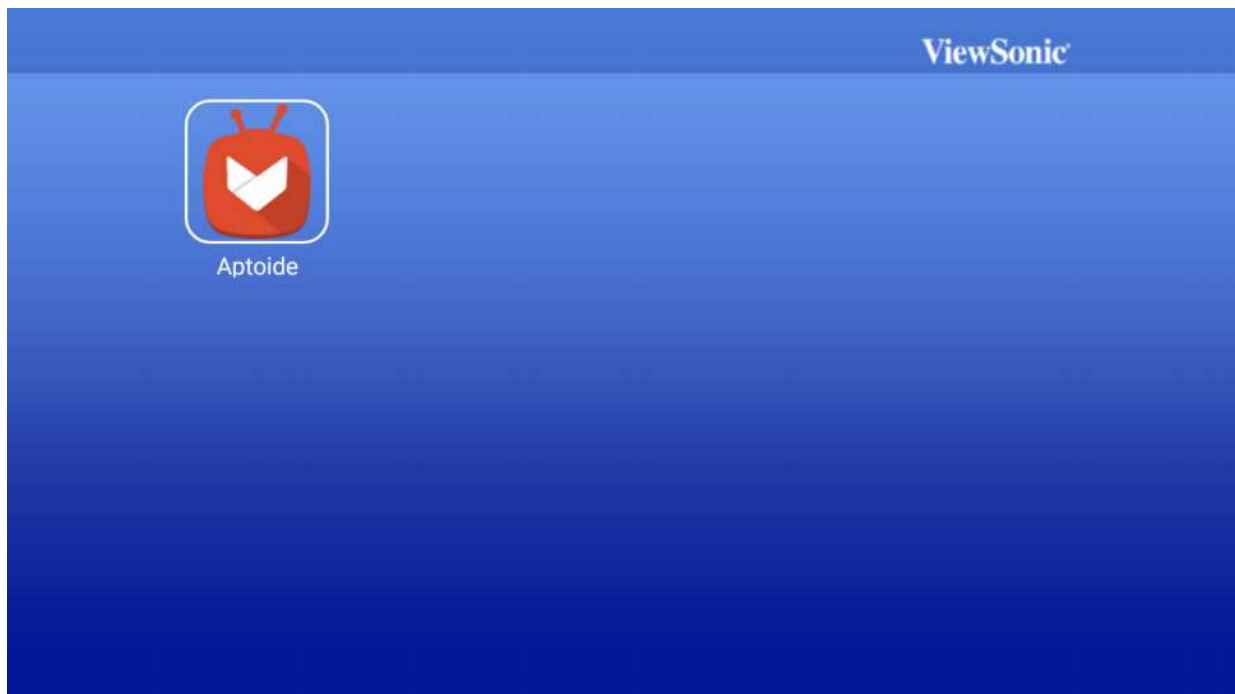

NOTE: Press the **Home** button on the remote control to return to the **Home Screen** at anytime.

To Uninstall Apps

1. Open the **Apps Center** by selecting: **Home > Apps Center**.
2. Use the directional buttons to select the desired App.
3. Press and hold **OK** on the remote control for three (3) seconds. The below dialogue box will appear:

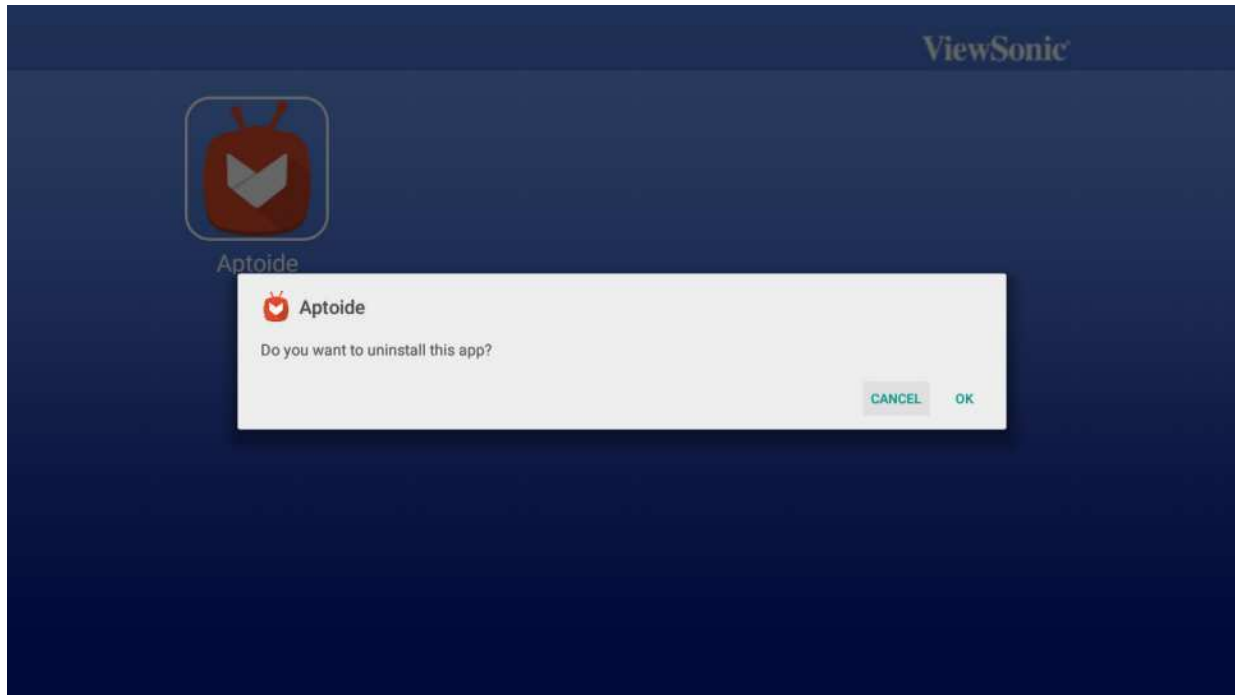

4. Select **OK** to uninstall the App.

NOTE: Press the **Home** button on the remote control to return to the **Home Screen** at anytime.

Aptoide

The projector is pre-loaded with the Aptoide store, which allows users to download and install different Apps.

5. Select: Home > Apps Center > Aptoide.

6. Use the direction buttons to navigate the menu options. When you find your App, press the OK button to install the App.

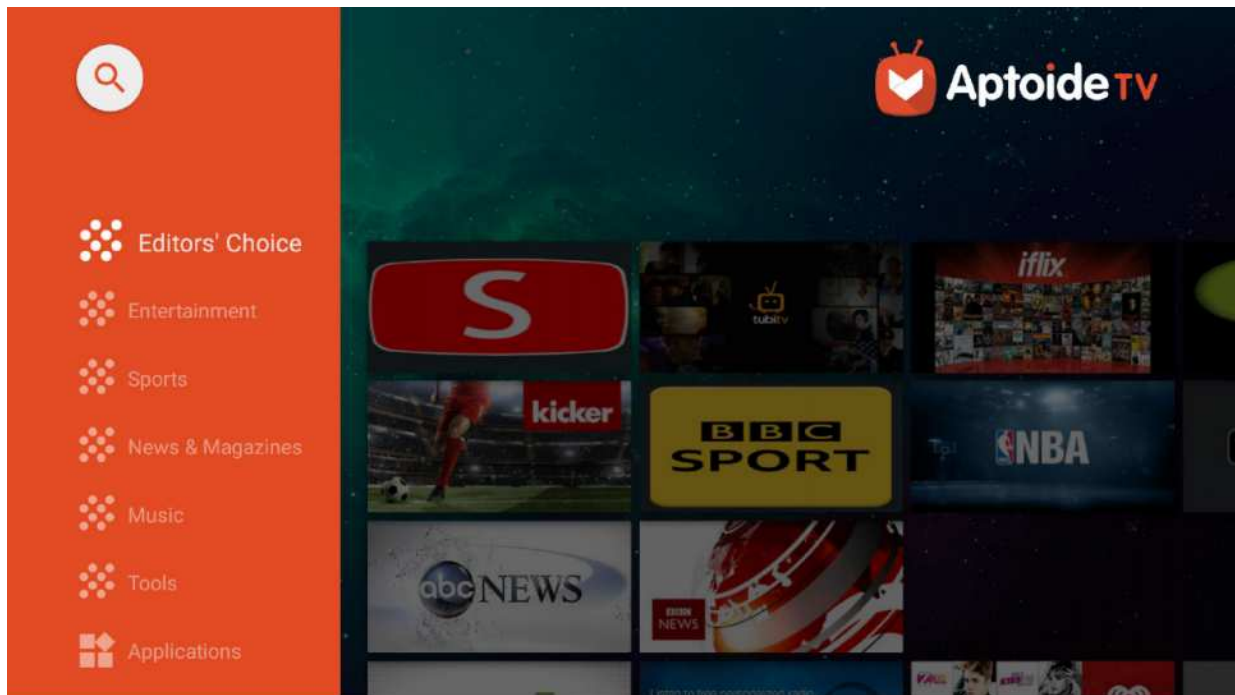

NOTE:

- Users can install third-party Apps by .apk file via USB. However, some third-party Apps may have compatibility issues.
- It is recommended that both Application (App) and Local storage capacity not be less than 1 GB in order to ensure smooth operation.
- 4 GB of App system storage is provided.
- APPs not pre-loaded by ViewSonic may not be compatible or work properly.
- Some APPs may require a Keyboard and Mouse.
- Some APPs may be Region-Specific.
- Le APP non precaricate da ViewSonic potrebbero non essere compatibili né funzionare correttamente.
- Alcune APP potrebbero richiedere tastiera e mouse.
- Alcune APP potrebbero essere specifiche della regione.

OSD Menu System

Menu system

Please note that the on-screen display (OSD) menus vary according to the signal type selected.

The menu items are available when the projector detects at least one valid signal. If there is no equipment connected to the projector or no signal detected, limited menu items are accessible.

Source	Main Menu	Sub-menu	Options
HDMI		3D Self Detect	Manual / Auto
		3D Conversion	None / Side by Side / Top & Bottom / Frame Packing / Frame sequential / Line alternative
		3D Sync Invert	ON / OFF
		Hue	Range : 0 ~ 100
		Sharpness	Range : 0 ~ 100
		Saturation	Range : 0 ~ 100
USB-C		3D Self Detect	Manual / Auto
		3D Conversion	None / Side by Side / Top & Bottom / Frame Packing / Frame sequential / Line alternative
		3D Sync Invert	ON / OFF
		Hue	Range : 0 ~ 100
		Sharpness	Range : 0 ~ 100
		Saturation	Range : 0 ~ 100
USB Reader	Play	Video Control Bar (appear with icon)	Backwards / Forward / Fast backwards / Fast Forward / Play / Pause / Volume / settings
		Photos Control Bar (appear with icon)	Backwards / Play / Forward / Zoom in / Zoom out / Rotate / settings
		Music Control Bar (appear with icon)	Backwards / Play / Forward / Repeat / Shuffle
	Select	Copy / Paste / Cut / Delete	
Local storage	Play	Video Control Bar (appear with icon)	Backwards / Forward / Fast backwards / Fast Forward / Play / Pause / Volume / settings
		Photos Control Bar (appear with icon)	Backwards / Play / Forward / Zoom in / Zoom out / Rotate / settings
		Music Control Bar (appear with icon)	Backwards / Play / Forward / Repeat / Shuffle
	Select	Copy / Paste / Cut / Delete	

Source	Main Menu	Sub-menu	Options
Micro SD	Play	Video Control Bar (appear with icon)	Backwards / Forward / Fast backwards / Fast Forward / Play / Pause / Volume / settings
		Photos Control Bar (appear with icon)	Backwards / Play / Forward / Zoom in / Zoom out / Rotate / settings
		Music Control Bar (appear with icon)	Backwards / Play / Forward / Repeat / Shuffle
	Select	Copy / Paste / Cut / Delete	
Screen Mirroring			
Settings	Image Settings	Aspect Ratio	Auto / 4:3 / 16:9
		Auto Keystone	ON / OFF
		V Keystone	V Range: +40 ~ -40 (0)
		Brightness	Range: 0 ~ 100
		Contrast	Range: -50 ~ 50
		Projectro Position	Front Table / Rear Table / Front Ceiling / Rear Ceiling
	Display Mode	Brightest / Standard / Theater	
	Harman Kardon	Mute	ON / OFF
		Audio Volume	Range; 0 ~ 20 (10)
		Audio Mode	Movie / Bass Booster / Instrumental
	Light Source Mode	Full / Eco / Extended Eco / Battery Saving	
	Eye Protection	ON / OFF	
	Network Settings	WiFi	ON / OFF
	Reset Settings	All Reset	Reset / Cancel
Language	English/ France / Germany/ Italian/ Spanish/ Russian/ 繁體中文/ 简体中文/ 日本 語/ 한국어/ Swedish/ Dutch/ Turkish/ Czech/ Portuguese/ Thai/ Polish/ Finnish/Arabic/ Indonesi/ Hindi/ Vietnam		
AppsCenter			
Bluetooth Speaker			
Wallpaper			

Source	Main Menu	Sub-menu	Options
Information	Color Mode		
	Light Source Mode		
	Local storage capacity		
	App Storage Of Local		
	Bluetooth		
	Firmware Version		

NOTE: The info of WiFi/IP/MAC can be shown at information page.

Specification sheet

Specification	
Projection system	DLP™ 0.2" WVGA
Native Resolution	854x480
Brightness	300 LED Lumens
Contrast Ratio	120000:1
Display Color	1.07 Billion Colors
Light Source	LED
Light source life (Nor/SuperEco)	30000 hours
Lamp Watt	10W RGB LED
Lens	F=1.7, f=5.5mm
Projection Offset	100%+/-5%
Throw Ratio	1.2
Image size	24"-100"
Throw Distance	38"@1m
Keystone	+/- 40° (Vertical)
Optical Zoom	Fixed
Audible Noise (Eco)	25dB
Local storage	Total 16GB (12GB available storage)
Resolution Support	VGA(640 x 480) to FullHD(1920 x 1080)
HDTV Compatibility	480i, 480p, 576i, 576p, 720p, 1080i, 1080p
Horizontal Frequency	15h~135kHz
Vertical Scan Rate	23~120Hz
Input	
HDMI / HDCP	1 (HDMI 1.4 / HDCP 1.4)
SD Card	Micro SD (Support up to 32GB, SDHC)
USB-C	1 (5V/ 2A)
WiFi	1
Bluetooth	1
Output	
Audio out (3.5mm)	1
Speaker	3W Cube x 2
USB type A (Power)	1 (5V/ 1A)
Others	
Power Supply Voltage	19.V  3.42A (Adapter Input 100-240V @ 50/60 Hz)
Power Consumption	45W@100VAC Standby: <0.5W
Operating Temperature	0~40°C
Carton	Color

Net Weight	0.75kg
Dimensions (WxDxH) w/ adjustment foot	146x126x40mm
Language	English, French, Spanish, Thai, Korean, German, Italian, Russian, Swedish, Dutch, Polish, Czech, T-Chinese, S-Chinese, Japanese, Turkish, Portuguese, Finnish, Indonesian, India, Arabic, Vietnamese, Greek
Standard Accessory	
Power Cord	1
Remote Control	1
QSG	1
USB-C Cable	1 (1m)
Optional Accessory	
Warranty Card	Yes (for specific regions only)
Carry Bag	1
Feature Map	
SuperColor	•
3D Blu-ray	•
3D Ready	•
SonicExpert	•
SonicMode	•
360° Tilt Angle Projection	•
Porait mode	•
Auto V Keystone	•
USB Reader	•
Quick Power On	•
Quick Power Off	•
Eye Protection	•
Wireless screen mirroring	•

HDMI Support Video Timing

Timing	Resolution	Horizontal frequency (KHz)	Vertical frequency (Hz)	Dot Clock Frequency (MHz)
480i	720(1440) x 480	15.73	59.94	27
480p	720 x 480	31.47	59.94	27
576i	720(1440) x 576	15.63	50	27
576p	720 x 576	31.25	50	27
720/50p	1280 x 720	37.5	50	74.25
720/60p	1280 x 720	45.00	60	74.25
1080/24P	1920 x 1080	27	24	74.25
1080/25P	1920 x 1080	28.13	25	74.25
1080/30P	1920 x 1080	33.75	30	74.25
1080/50i	1920 x 1080	28.13	50	74.25
1080/60i	1920 x 1080	33.75	60	74.25
1080/50P	1920 x 1080	56.25	50	148.5
1080/60P	1920 x 1080	67.5	60	148.5

HDMI Support PC Timing

Resolution	Mode	Refresh rate (Hz)	H-frequency (kHz)	Clock (MHz)
640 x 480	VGA_60	59.940	31.469	25.175
	VGA_72	72.809	37.861	31.500
	VGA_75	75.000	37.500	31.500
	VGA_85	85.008	43.269	36.000
	VGA_120	119.518	61.910	52.500
720 x 400	720x400_70	70.087	31.469	28.3221
800 x 600	SVGA_56	56.250	35.156	36.000
	SVGA_60	60.317	37.879	40.000
	SVGA_72	72.188	48.077	50.000
	SVGA_75	75.000	46.875	49.500
	SVGA_85	85.061	53.674	56.250
	SVGA_120	119.854	77.425	83.000
1024 x 768	XGA_60	60.004	65.000	65.000
	XGA_70	70.069	75.000	75.000
	XGA_75	75.029	78.750	78.750
	XGA_85	84.997	94.500	94.500
	XGA_120	119.804	137.750	137.750
1152 x 864	1152 x 864_75	75.00	67.500	108.000
1280 x 768	1280 x 768_60	60	47.396	68.25
	1280 x 768_60	59.870	47.776	79.5
	1280 x 768_75	74.893	60.289	102.25
	1280 x 768_85	84.837	68.633	117.50
1280 x 800	WXGA_60	59.810	49.702	83.500
	WXGA_75	74.934	62.795	106.500
	WXGA_85	84.880	71.554	122.500
1280 x 1024	SXGA_60	60.020	63.981	108.000
	SXGA_75	75.025	79.976	135.000
	SXGA_85	85.024	91.146	157.500
1280 x 960	1280 x 960_60	60.000	60.000	108
	1280 x 960_85	85.002	85.938	148.500
1360 x 768	1360 x 768_60	60.015	47.712	85.500
1366 x 768	1366 x 768_60			
1440 x 900	WXGA+_60	60	55.469	88.75
	WXGA+_60	59.887	55.935	106.500
	WXGA+_75	74.984	70.635	136.75
	WXGA+_85	84.842	80.430	157.000
1400X1050	SXGA+_60	59.978	65.317	121.750
1600x1200	UXGA	60.000	75.000	162.000
1680 x 1050	1680x1050_60	59.883	64.674	119.000
		59.954	65.290	146.250

Resolution	Mode	Refresh rate (Hz)	H-frequency (kHz)	Clock (MHz)
1920 x 1200	1920x1200_60	59.950	74.038	154.000
640x480@67Hz	MAC13	66.667	35.000	30.240
832x624@75Hz	MAC16	74.546	49.722	57.280
1024x768@75Hz	MAC19	75.020	60.241	80.000
1152x870@75Hz	MAC21	75.06	68.68	100.00

3D Support Timing

HDMI/DP 3D (BlueRay3D with info frame)				
Signal	Resolution (dots)	Aspect Ratio	Refresh Rate (Hz)	Support
Frame packing				
1080p	1920 x 1080	16:9	23.98/24	Yes
720p	1280 x 720	16:9	50/59.94/60	Yes
Side by side				
1080i	1920 x 1080	16:9	50/59.94/60	Yes
Top and Bottom				
1080p	1920 x 1080	16:9	23.98/24	Yes
720p	1280 x 720	16:9	50/59.94/60	Yes

3D (HDMI/USB C) manual setting				
Signal	Resolution (dots)	Aspect Ratio	Refresh Rate (Hz)	Support
SVGA	800 x 600	4:3	60* / 120**	Yes
XGA	1024 x 768	4:3	60* / 120**	Yes
HD	1280 x 720	16:9	60* / 120**	Yes
WXGA	1280 x 800	16:9	60* / 120**	Yes
HDTV (1080p)	1920 x 1080	16:9	60	Yes
for Video Signal				
SDTV (480i)***	720 x 480	4:3 / 16:9	60	No

Note:

* 60Hz signals are supported for side by side, top and bottom, frame sequential

** 120 Hz signals are support for frame sequential only

*** Video signal (SDTV 480i) is support for frame sequential only

USB-C Support Timing

Timing	Resolution	Horizontal frequency (KHz)	Vertical frequency (Hz)	Dot Clock Frequency (MHz)
480i	720 (1440) x 480	15.73	59.94	27
480p	720 x 480	31.47	59.94	27
576i	720 (1440) x 576	15.63	50	27
576p	720 x 576	31.25	50	27
720/50p	1280 x 720	37.5	50	74.25
720/60p	1280 x 720	45.00	60	74.25
1080/24P	1920 x 1080	27	24	74.25
1080/25P	1920 x 1080	28.13	25	74.25
1080/30P	1920 x 1080	33.75	30	74.25
1080/50i	1920 x 1080	28.13	50	74.25
1080/60i	1920 x 1080	33.75	60	74.25
1080/50P	1920 x 1080	56.25	50	148.5
1080/60P	1920 x 1080	67.5	60	148.5

Customer Support

For technical support or product service, see the table below or contact your reseller.

Note: You will need the product serial number.

Country/ Region	Website	Country/ Region	Website
Asia Pacific & Africa			
Australia	www.viewsonic.com/au/	Bangladesh	www.viewsonic.com/bd/
中国 (China)	www.viewsonic.com.cn	香港 (繁體中文)	www.viewsonic.com/hk/
Hong Kong (English)	www.viewsonic.com/hk-en/	India	www.viewsonic.com/in/
Indonesia	www.viewsonic.com/id/	Israel	www.viewsonic.com/il/
日本 (Japan)	www.viewsonic.com/jp/	Korea	www.viewsonic.com/kr/
Malaysia	www.viewsonic.com/my/	Middle East	www.viewsonic.com/me/
Myanmar	www.viewsonic.com/mm/	Nepal	www.viewsonic.com/np/
New Zealand	www.viewsonic.com/nz/	Pakistan	www.viewsonic.com/pk/
Philippines	www.viewsonic.com/ph/	Singapore	www.viewsonic.com/sg/
臺灣 (Taiwan)	www.viewsonic.com/tw/	ประเทศไทย	www.viewsonic.com/th/
Việt Nam	www.viewsonic.com/vn/	South Africa & Mauritius	www.viewsonic.com/za/
Americas			
United States	www.viewsonic.com/us	Canada	www.viewsonic.com/us
Latin America	www.viewsonic.com/la		
Europe			
Europe	www.viewsonic.com/eu/	France	www.viewsonic.com/fr/
Deutschland	www.viewsonic.com/de/	Қазақстан	www.viewsonic.com/kz/
Россия	www.viewsonic.com/ru/	España	www.viewsonic.com/es/
Türkiye	www.viewsonic.com/tr/	Україна	www.viewsonic.com/ua/
United Kingdom	www.viewsonic.com/uk/		

Limited Warranty

ViewSonic® Projector

What the warranty covers:

ViewSonic warrants its products to be free from defects in material and workmanship, under normal use, during the warranty period. If a product proves to be defective in material or workmanship during the warranty period, ViewSonic will, at its sole option, repair or replace the product with a like product. Replacement product or parts may include remanufactured or refurbished parts or components.

For warranty in North and South American, please visit the following web site for warranty information, <https://www.viewsonic.com/us/support/limited-warranties/standard-warranty>

For other regions:

Limited One (1) year General Warranty

ViewSonic's standard warranty period is one (1) year for any product model in any country, unless a longer warranty period is specified and provided by ViewSonic. Please refer to the ViewSonic website in your country to check the local terms and model variants, and see if the product model in your country is eligible for a longer warranty period.

Limited One (1) year Heavy Usage Warranty:

Under heavy usage settings, where a projector's use includes more than fourteen (14) hours average daily usage, North and South America: One (1) year warranty for all parts excluding the Light Source, one (1) year for labor, and ninety (90) days for the original Light Source from the date of the first consumer purchase; Europe: One (1) year warranty for all parts excluding the Light Source, one (1) year for labor, and ninety (90) days for the original Light Source from the date of the first consumer purchase.

Other regions or countries: Please check with your local dealer or local ViewSonic office for the warranty information.

Light Source warranty subject to terms and conditions, verification and approval. Applies to manufacturer's installed Light Source only. All accessory Light Source purchased separately are warranted for 90 days.

Who the warranty protects:

This warranty is valid only for the first consumer purchaser.

What the warranty does not cover:

1. Any product on which the serial number has been defaced, modified or removed.
2. Damage, deterioration, failure, or malfunction resulting from:
 - a. Accident, abuse, misuse, neglect, fire, water, lightning, or other acts of nature, improper maintenance, unauthorized product modification, or failure to follow instructions supplied with the product.
 - b. Operation outside of product specifications.
 - c. Operation of the product for other than the normal intended use or not under normal conditions.
 - d. Repair or attempted repair by anyone not authorized by ViewSonic.
 - e. Any damage of the product due to shipment.
 - f. Removal or installation of the product.

- g. Causes external to the product, such as electric power fluctuations or failure.
 - h. Use of supplies or parts not meeting ViewSonic's specifications.
 - i. Normal wear and tear.
 - j. Any other cause which does not relate to a product defect.
3. Removal, installation, and set-up service charges.

How to get service:

1. For information about receiving service under warranty, contact ViewSonic Customer Support (please refer to "Customer Support" page). You will need to provide your product's serial number.
2. To obtain warranted service, you will be required to provide (a) the original dated sales slip, (b) your name, (c) your address, (d) a description of the problem, and (e) the serial number of the product.
3. Take or ship the product freight prepaid in the original container to an authorized ViewSonic service center or ViewSonic.
4. For additional information or the name of the nearest ViewSonic service center, contact ViewSonic.

Limitation of implied warranties:

There are no warranties, express or implied, which extend beyond the description contained herein including the implied warranty of merchantability and fitness for a particular purpose.

Exclusion of damages:

ViewSonic's liability is limited to the cost of repair or replacement of the product.

ViewSonic shall not be liable for:

1. Damage to other property caused by any defects in the product, damages based upon inconvenience, loss of use of the product, loss of time, loss of profits, loss of business opportunity, loss of goodwill, interference with business relationships, or other commercial loss, even if advised of the possibility of such damages.
2. Any other damages, whether incidental, consequential or otherwise.
3. Any claim against the customer by any other party.

Effect of local law:

This warranty gives you specific legal rights, and you may also have other rights which vary from local authority. Some local governances do not allow limitations on implied warranties and/or do not allow the exclusion of incidental or consequential damages, so the above limitations and exclusions may not apply to you.

Sales outside the U.S.A. and Canada:

For warranty information and service on ViewSonic products sold outside of the U.S.A. and Canada, contact ViewSonic or your local ViewSonic dealer.

The warranty period for this product in mainland China (Hong Kong, Macao and Taiwan Excluded) is subject to the terms and conditions of the Maintenance Guarantee Card.

For users in Europe and Russia, full details of warranty provided can be found in www.viewsoniceurope.com under Support/Warranty Information.

Mexico Limited Warranty

ViewSonic® Projector

What the warranty covers:

ViewSonic warrants its products to be free from defects in material and workmanship, under normal use, during the warranty period. If a product proves to be defective in material or workmanship during the warranty period, ViewSonic will, at its sole option, repair or replace the product with a like product. Replacement product or parts may include remanufactured or refurbished parts or components & accessories.

How long the warranty is effective:

ViewSonic's standard warranty period is one (1) year for any product model in any country, unless a longer warranty period is specified and provided by ViewSonic. Please refer to the ViewSonic website in your country to check the local terms and model variants, and see if the product model in your country is eligible for a longer warranty period.

Who the warranty protects:

This warranty is valid only for the first consumer purchaser.

What the warranty does not cover:

1. Any product on which the serial number has been defaced, modified or removed.
2. Damage, deterioration or malfunction resulting from:
 - a. Accident, misuse, neglect, fire, water, lightning, or other acts of nature, unauthorized product modification, unauthorized attempted repair, or failure to follow instructions supplied with the product.
 - b. Any damage of the product due to shipment.
 - c. Causes external to the product, such as electrical power fluctuations or failure.
 - d. Use of supplies or parts not meeting ViewSonic's specifications.
 - e. Normal wear and tear.
 - f. Any other cause which does not relate to a product defect.
3. Any product exhibiting a condition commonly known as "image burn-in" which results when a static image is displayed on the product for an extended period of time.
4. Removal, installation, insurance, and set-up service charges.

How to get service:

For information about receiving service under warranty, contact ViewSonic Customer Support (Please refer to the attached Customer Support page). You will need to provide your product's serial number, so please record the product information in the space provided below on your purchase for your future use. Please retain your receipt of proof of purchase to support your warranty claim.

For Your Records

Product Name: _____ Model Number: _____
Document Number: _____ Serial Number: _____
Purchase Date: _____ Extended Warranty Purchase? _____ (Y/N)
If so, what date does warranty expire? _____

1. To obtain warranty service, you will be required to provide (a) the original dated sales slip, (b) your name, (c) your address, (d) a description of the problem, and (e) the serial number of the product.
2. Take or ship the product in the original container packaging to an authorized ViewSonic service center.
3. Round trip transportation costs for in-warranty products will be paid by ViewSonic.

Limitation of implied warranties:

There are no warranties, express or implied, which extend beyond the description contained herein including the implied warranty of merchantability and fitness for a particular purpose.

Exclusion of damages:

ViewSonic's liability is limited to the cost of repair or replacement of the product. ViewSonic shall not be liable for:

1. Damage to other property caused by any defects in the product, damages based upon inconvenience, loss of use of the product, loss of time, loss of profits, loss of business opportunity, loss of goodwill, interference with business relationships, or other commercial loss, even if advised of the possibility of such damages.
2. Any other damages, whether incidental, consequential or otherwise.
3. Any claim against the customer by any other party.
4. Repair or attempted repair by anyone not authorized by ViewSonic.

Contact Information for Sales & Authorized Service (Centro Autorizado de Servicio) within Mexico:	
Name, address, of manufacturer and importers: México, Av. de la Palma #8 Piso 2 Despacho 203, Corporativo Interpalmas, Col. San Fernando Huixquilucan, Estado de México Tel: (55) 3605-1099 http://www.viewsonic.com/la/soporte/index.htm	
NÚMERO GRATIS DE ASISTENCIA TÉCNICA PARA TODO MÉXICO: 001.866.823.2004	
Hermosillo: Distribuciones y Servicios Computacionales SA de CV. Calle Juarez 284 local 2 Col. Bugambillas C.P: 83140 Tel: 01-66-22-14-9005 E-Mail: disc2@hmo.megared.net.mx	Villahermosa: Compumantenimientos Garantizados, S.A. de C.V. AV. GREGORIO MENDEZ #1504 COL, FLORIDA C.P. 86040 Tel: 01 (993) 3 52 00 47 / 3522074 / 3 52 20 09 E-Mail: compumantenimientos@prodigy.net.mx
Puebla, Pue. (Matriz): RENTA Y DATOS, S.A. DE C.V. Domicilio: 29 SUR 721 COL. LA PAZ 72160 PUEBLA, PUE. Tel: 01(52).222.891.55.77 CON 10 LINEAS E-Mail: datos@puebla.megared.net.mx	Veracruz, Ver.: CONEXION Y DESARROLLO, S.A DE C.V. Av. Americas # 419 ENTRE PINZÓN Y ALVARADO Fracc. Reforma C.P. 91919 Tel: 01-22-91-00-31-67 E-Mail: gacosta@qplus.com.mx
Chihuahua Soluciones Globales en Computación C. Magisterio # 3321 Col. Magisterial Chihuahua, Chih. Tel: 4136954 E-Mail: Cefeo@soluglobales.com	Cuernavaca Compusupport de Cuernavaca SA de CV Francisco Leyva # 178 Col. Miguel Hidalgo C.P. 62040, Cuernavaca Morelos Tel: 01 777 3180579 / 01 777 3124014 E-Mail: aquevedo@compusupportcva.com
Distrito Federal: QPLUS, S.A. de C.V. Av. Coyoacán 931 Col. Del Valle 03100, México, D.F. Tel: 01(52)55-50-00-27-35 E-Mail : gacosta@qplus.com.mx	Guadalajara, Jal.: SERVICRECE, S.A. de C.V. Av. Niños Héroes # 2281 Col. Arcos Sur, Sector Juárez 44170, Guadalajara, Jalisco Tel: 01(52)33-36-15-15-43 E-Mail: mmiranda@servicrece.com
Guerrero Acapulco GS Computación (Grupo Sesicomp) Progreso #6-A, Colo Centro 39300 Acapulco, Guerrero Tel: 744-48-32627	Monterrey: Global Product Services Mar Caribe # 1987, Esquina con Golfo Pérsico Fracc. Bernardo Reyes, CP 64280 Monterrey N.L. México Tel: 8129-5103 E-Mail: aydeem@gps1.com.mx
MERIDA: ELECTROSER Av Reforma No. 403Gx39 y 41 Mérida, Yucatán, México CP97000 Tel: (52) 999-925-1916 E-Mail: rrrb@sureste.com	Oaxaca, Oax.: CENTRO DE DISTRIBUCION Y SERVICIO, S.A. de C.V. Murguía # 708 P.A., Col. Centro, 68000, Oaxaca Tel: 01(52)95-15-15-22-22 Fax: 01(52)95-15-13-67-00 E-Mail: gpotai2001@hotmail.com
Tijuana: STD Av Ferrocarril Sonora #3780 L-C Col 20 de Noviembre Tijuana, Mexico	FOR USA SUPPORT: ViewSonic Corporation 14035 Pipeline Ave. Chino, CA 91710, USA Tel: 800-688-6688 E-Mail: http://www.viewsonic.com



ViewSonic®