

# Video Projector

Operating Instructions

VPL-HW10

**BRAVIA**

**SXRD**  
Silicon X-tal Reflective Display

**HDMI™**  
HIGH-DEFINITION MULTIMEDIA INTERFACE

# WARNING

**To reduce the risk of fire or electric shock, do not expose this apparatus to rain or moisture.**

**To avoid electrical shock, do not open the cabinet. Refer servicing to qualified personnel only.**

**THIS APPARATUS MUST BE EARTHED.**

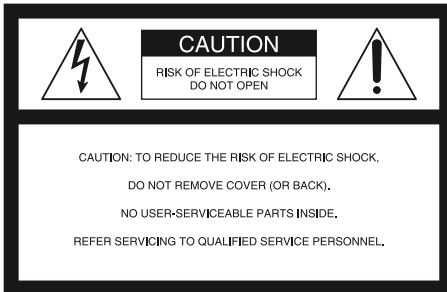

This symbol is intended to alert the user to the presence of uninsulated “dangerous voltage” within the product’s enclosure that may be of sufficient magnitude to constitute a risk of electric shock to persons.



This symbol is intended to alert the user to the presence of important operating and maintenance (servicing) instructions in the literature accompanying the appliance.

## For customers in the USA

If you have any questions about this product, you may call:  
Sony Customer Information Service Center  
1-800-222-7669 or <http://www.sony.com/>  
The number below is for FCC related matters only.

## Declaration of Conformity

Trade Name: SONY

Model No.: VPL-HW10

Responsible Party: Sony Electronics Inc.

Address: 16530 Via Esprillo, San Diego, CA 92127 U.S.A.

Telephone Number: 858-942-2230

This device complies with Part 15 of the FCC Rules. Operation is subject to the following two conditions: (1) This device may not cause harmful interference, and (2) this device must accept any interference received, including interference that may cause undesired operation.

This equipment has been tested and found to comply with the limits for a Class B digital device, pursuant to Part 15 of the FCC Rules. These limits are designed to provide reasonable protection against harmful interference in a residential installation. This equipment generates, uses, and can radiate radio frequency energy and, if not installed and used in accordance with the instructions, may cause harmful interference to radio communications. However, there is no guarantee that interference will not occur in a particular installation. If this equipment does cause harmful interference to radio or television reception, which can be determined by turning the equipment off and on, the user is encouraged to try to correct the interference by one or more of the following measures:

- Reorient or relocate the receiving antenna.
- Increase the separation between the equipment and receiver.
- Connect the equipment into an outlet on a circuit different from that to which the receiver is connected.
- Consult the dealer or an experienced radio/TV technician for help.

You are cautioned that any changes or modifications not expressly approved in this manual could void your authority to operate this equipment.

All interface cables used to connect peripherals must be shielded in order to comply with the limits for a digital device pursuant to Subpart B of Part 15 of FCC Rules.

### **Disposal of Used Lamp**

This projector's lamp contains mercury and should be disposed of properly. Consult your local authorities regarding safe disposal. The material contained in this lamp are similar to those of a fluorescent lamp, so you should dispose of it in the same way.

### **For customers in the United States**

Lamp in this product contains mercury. Disposal of these materials may be regulated due to environmental considerations. For disposal or recycling information, please contact your local authorities or the Electronic Industries Alliance ([www.eiae.org](http://www.eiae.org)).

### **For customers in Europe**

The manufacturer of this product is Sony Corporation, 1-7-1 Konan Minato-ku Tokyo, 108-0075 Japan. The Authorized Representative for EMC and product safety is Sony Deutschland GmbH, Hedelfinger Strasse 61, 70327 Stuttgart, Germany. For any service or guarantee matters please refer to the addresses given in separate service or guarantee documents.

### **For kundene i Norge**

Dette utstyret kan kobles til et IT-strømfordelingssystem.

### **Trademark Information**

HDMI, the HDMI logo and High-Definition Multimedia Interface are trademarks or registered trademarks of HDMI Licensing LLC.

“Blu-ray Disc” is a trademark.

### For customers in Canada

This Class B digital apparatus complies with Canadian ICES-003.

### For customers in Europe



**Disposal of waste batteries (applicable in the European Union and other European countries with separate collection systems)**

This symbol on the battery or on the packaging indicates that the battery provided with this product shall not be treated as household waste.

By ensuring these batteries are disposed of correctly, you will help prevent potentially negative consequences for the environment and human health which could otherwise be caused by inappropriate waste handling of the battery. The recycling of the materials will help to conserve natural resources.

In case of products that for safety, performance or data integrity reasons require a permanent connection with an incorporated battery, this battery should be replaced by qualified service staff only.

To ensure that the battery will be treated properly, hand over the product at end-of-life to the applicable collection point for the recycling of electrical and electronic equipment.

For all other batteries, please view the section on how to remove the battery from the product safely. Hand the battery over to the applicable collection point for the recycling of waste batteries.

For more detailed information about recycling of this product or battery, please contact your local Civic Office, your household waste disposal service or the shop where you purchased the product.

The socket-outlet should be installed near the equipment and be easily accessible.

### CAUTION

RISK OF EXPLOSION IF BATTERY IS REPLACED BY AN INCORRECT TYPE.

DISPOSED OF USED BATTERIES ACCORDING TO THE LOCAL RULES.



**Disposal of Old Electrical & Electronic Equipment (Applicable in the European Union and other European countries with separate collection systems)**

This symbol on the product or on its packaging indicates that this product shall not be treated as household waste. Instead it shall be handed over to the applicable collection point for the recycling of electrical and electronic equipment. By ensuring this product is disposed of correctly, you will help prevent potential negative consequences for the environment and human health, which could otherwise be caused by inappropriate waste handling of this product. The recycling of materials will help to conserve natural resources. For more detailed information about recycling of this product, please contact your local Civic Office, your household waste disposal service or the shop where you purchased the product.

### For customers in Taiwan only



廢電池請回收  
僅適用於台灣

---

# Table of Contents

Precautions .....	7
-------------------	---

## Location of Controls

Front/Right Side .....	8
Rear/Bottom .....	9
Remote Control .....	10

## Connections and Preparations

Unpacking .....	11
Step 1: Installing the Projector .....	12
Before Setting Up the Projector .....	12
Positioning the Projector and a screen .....	14
Step 2: Connecting the Projector .....	18
Connecting to a VCR .....	18
Connecting to a Computer .....	21
Step 3: Adjusting the Picture Position .....	22
Step 4: Selecting the Menu Language .....	26

## Projecting

Projecting the Picture on the Screen .....	28
Turning Off the Power .....	29
Selecting the Wide Screen Mode .....	30
Selecting the Picture Viewing Mode .....	32
Adjusting the Picture Quality .....	33
Adjusting the Picture Using Real Color Processing .....	34
Using Other Functions .....	36

## Using the Menus

Operation through the Menus .....	37
Picture Menu .....	41
Advanced Picture Menu .....	44
Screen Menu .....	45
Setup Menu .....	47
Function Menu .....	49
Installation Menu .....	50
Information Menu .....	52
About the Preset Memory No. ....	53

## Others

About the Control for HDMI .....	54
About the x.v.Color .....	54
Troubleshooting .....	55
Warning Indicators .....	57
Message Lists .....	58
Replacing the Lamp and the Air Filter and Cleaning the Ventilation Holes (intake) .....	59
Cleaning the Air Filter .....	62
Fitting the Lens Cap .....	62
Cleaning and the Screen of the Projector .....	63
Specifications .....	64
Preset Signals .....	66
Input Signals and Adjustable/ Setting Items .....	69
Ceiling Installation .....	71
Index .....	75

---

# Precautions

---

## On safety

- Check that the operating voltage of your unit is identical with the voltage of your local power supply.
- Should any liquid or solid object fall into the cabinet, unplug the unit and have it checked by qualified personnel before operating it further.
- Unplug the unit from the wall outlet if it is not to be used for several days.
- To disconnect the cord, pull it out by the plug. Never pull the cord itself.
- The wall outlet should be near the unit and easily accessible.
- The unit is not disconnected to the AC power source (mains) as long as it is connected to the wall outlet, even if the unit itself has been turned off.
- Do not look into the lens while the lamp is on.
- Do not place your hand or objects near the ventilation holes. The air coming out is hot.

---

## On preventing internal heat build-up

After you turn off the power with the I/⏻ (ON/STANDBY) switch, do not disconnect the unit from the wall outlet while the cooling fan is still running.

## Caution

The projector is equipped with ventilation holes (intake) and ventilation holes (exhaust). Do not block or place anything near these holes, or internal heat build-up may occur, causing picture degradation or damage to the projector.

---

## On repacking

Save the original shipping carton and packing material; they will come in handy if you ever have to ship your unit. For maximum protection, repack your unit as it was originally packed at the factory.

# Location of Controls

## Front/Right Side

You can use the buttons on the control panel with the same names as those on the remote control to operate the projector.

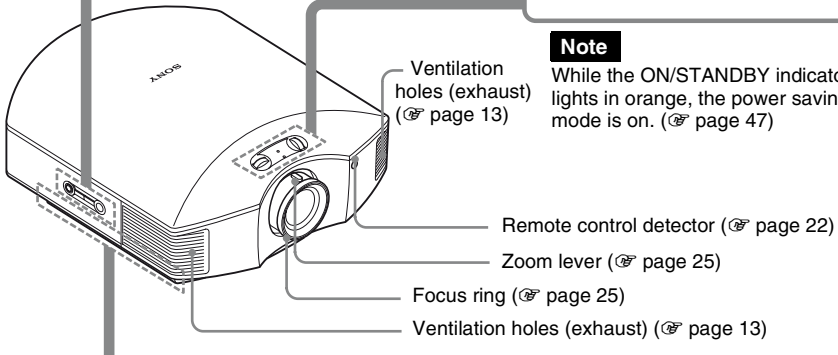
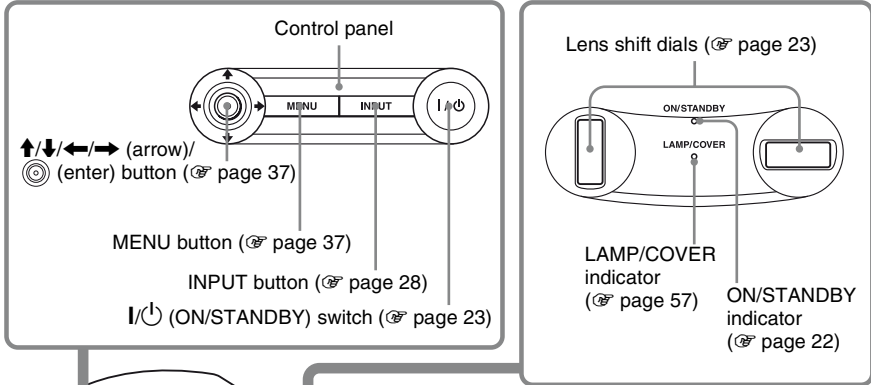

**Note**

While the ON/STANDBY indicator lights in orange, the power saving mode is on. (☞ page 47)

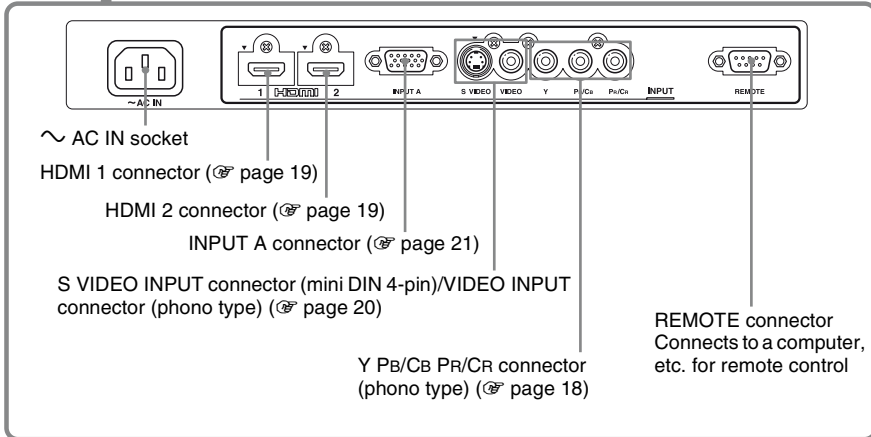



# Rear/Bottom

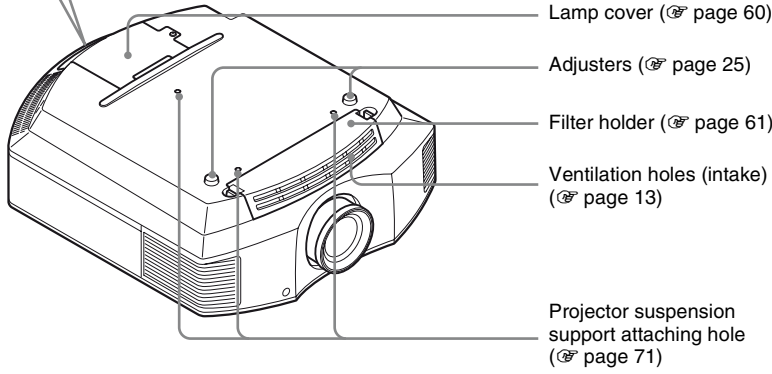
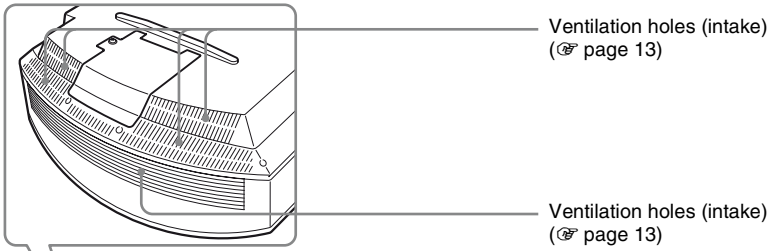
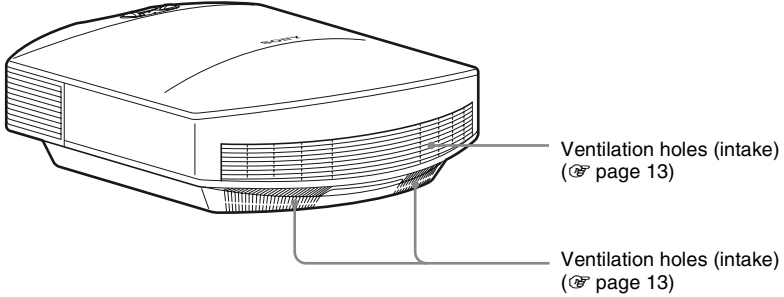

# Remote Control

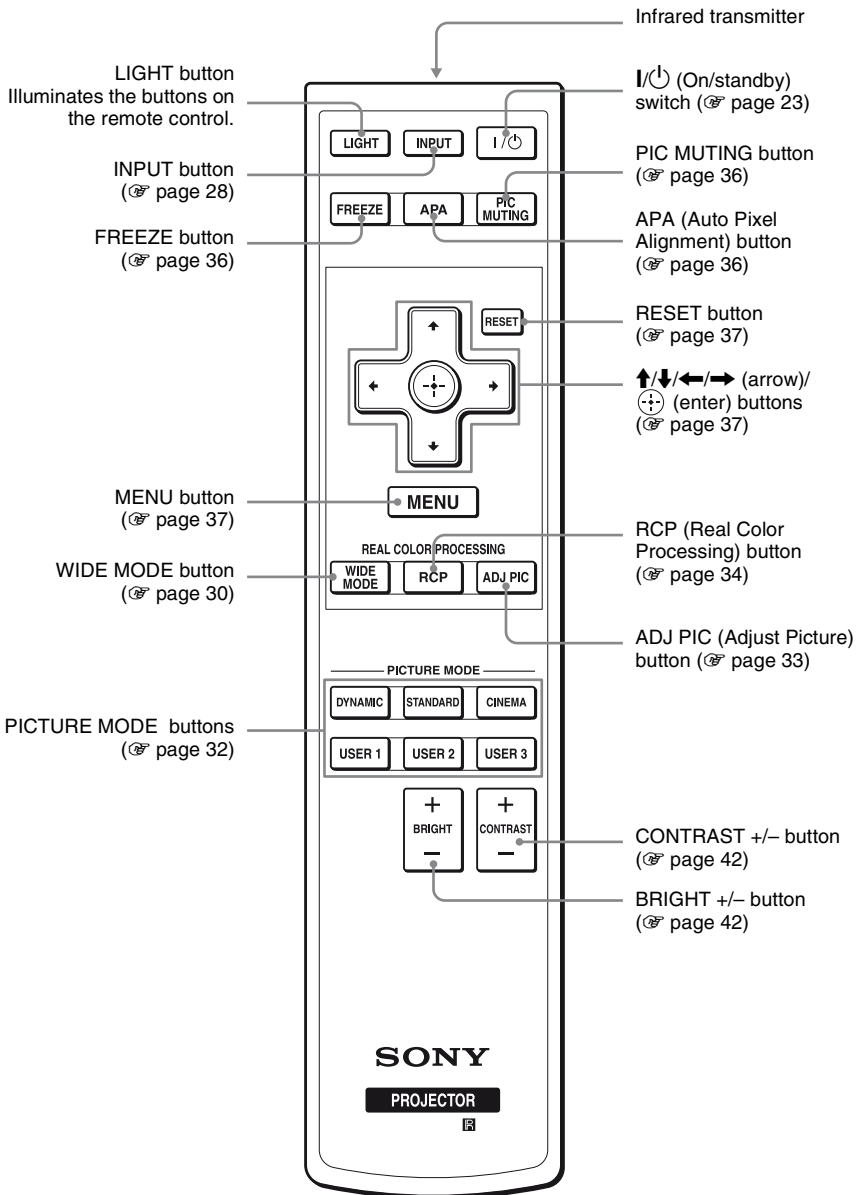

# Connections and Preparations

This section describes how to install the projector and screen, how to connect the equipment from which you want to project the picture, etc.

## Unpacking

Check the carton to make sure it contains the following items:

- Remote control (1) and Size AA (R6) batteries (2)
- AC power cord (1)
- Lens cap (1)  
When you have purchased the projector, the lens cap is put onto the lens. Remove this lens cap when you use the projector.
- Operating Instructions (this manual)

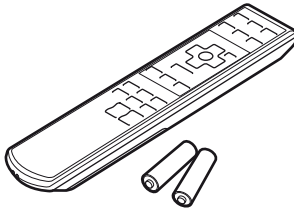

## Inserting the batteries into the remote control

Push and slide to open.

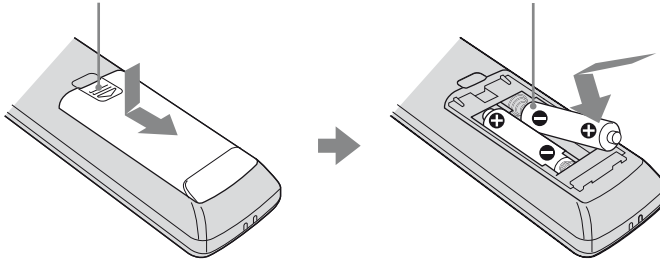

Insert the batteries **+** side first as shown in the illustration. Inserting them forcibly or with the polarities reversed may cause a short circuit and may generate heat.

## Caution about handling the remote control

- Handle the remote control with care. Do not drop or step on it, or spill liquid of any kind onto it.
- Do not place the remote in a location near a heat source, a place subject to direct sunlight, or a damp room.

# Step 1: Installing the Projector

The projector displays pictures output from a VCR or other device.

The lens shift allows you to have broader options for placing the projector and viewing pictures easily.

## Before Setting Up the Projector

### Unsuitable installation

Do not place the projector in the following situations, which may cause malfunction or damage to the projector.

#### Poorly ventilated location

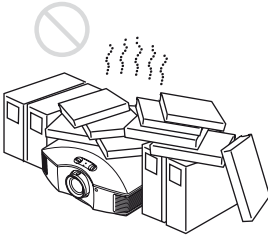

Leave space of more than 30 cm (11 7/8 inches) around the unit.

#### Hot and humid



Locations subject to direct cool or warm air from an air-conditioner

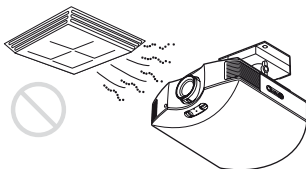

Installing the projector in such a location may cause a malfunction of the unit due to moisture condensation or rise in temperature.

#### Near a heat or smoke sensor

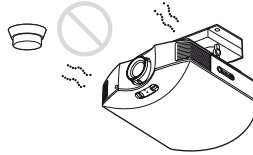

Malfunction of the sensor may occur.

#### Very dusty and extremely smoky locations



### Install in a location away from walls

To maintain the performance and reliability of the projector, allow at least 30 cm (11 7/8 inches) between the projector and walls.

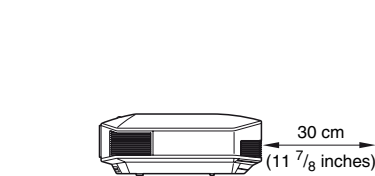
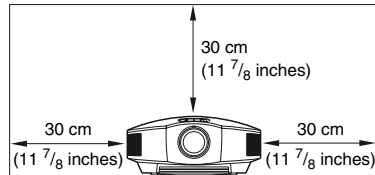

## Improper use

Do not do any of the following while using the projector.

### Blocking the ventilation holes (intake or exhaust)

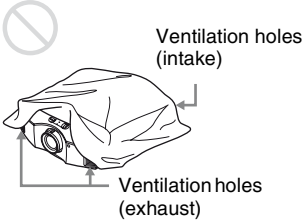

### Tip

For details on the location of the ventilation holes (intake or exhaust), see “Location of Controls” (☞ page 8).

### Tilting front/rear and left/right

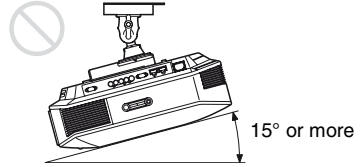
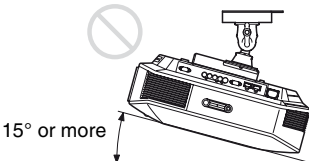
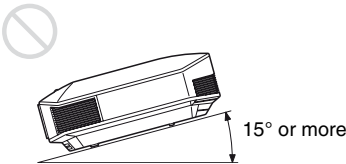
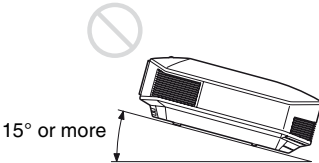
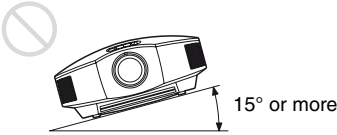

Avoid using the projector tilted at an angle of more than 15 degrees.

Do not install the projector anywhere other than on a level surface or on the ceiling. Installing the projector in such a location may result in uneven color uniformity or reduce the reliability of the effects of the lamp.

### When installing the unit at altitudes

When using the projector at an altitude of 1,500 m or higher, set “Cooling Setting” in the Setup  menu to “High” (☞ page 47). Failing to set this mode when using the projector at high altitudes could have adverse effects, such as reducing the reliability of certain components.

## Positioning the Projector and a screen

The installation distance between the projector and a screen varies depending on the size of the screen or whether or not you use the lens shift features.

### 1 Determine the installation position of the projector and screen.

You can obtain a good quality picture if you position the projector so that the center of the lens is within the area indicated in gray in the illustration.

Use the values  $L$ ,  $x$  and  $y$  in the table on page 15 or 16 as a guide.

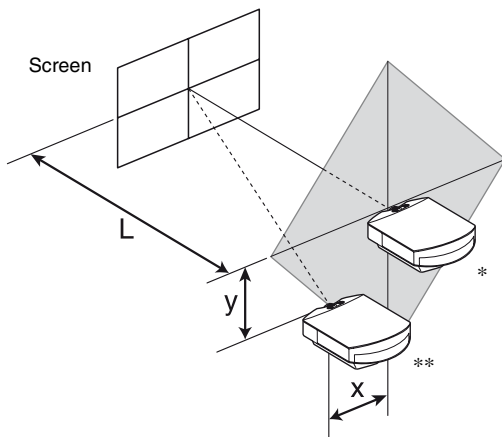

\* Installation position not using lens shift ( $x = 0$ ,  $y = 0$ )

\*\* Example of installation position using lens shift ( $x$ ,  $y$ )

**L:** Distance between the screen and the front end of the projector's lens.

**x:** Horizontal distance between the center of the screen and the center of the projector's lens.

**y:** Vertical distance between the center of the screen and the center of the projector's lens.

For installation of the projector on a ceiling, see "Ceiling Installation." (☞ page 71)

For details on the lens shift feature, see "Step 3: Adjusting the Picture Position."

(☞ page 22)

### When using the 16:9 aspect ratio screen size

Screen Size SS (inches)		40	60	80	100	120	150	200	250	300
(mm)		1016	1524	2032	2540	3048	3810	5080	6350	7620
L	minimum	1201 (47 3/8)	1825 (71 7/8)	2448 (96 1/2)	3072 (121)	3695 (145 1/2)	4631 (182 3/8)	6189 (243 3/4)	7748 (305 1/8)	9307 (366 1/2)
	maximum	1840 (72 1/2)	2782 (109 5/8)	3723 (146 5/8)	4664 (183 5/8)	5605 (220 3/4)	7017 (276 3/8)	9371 (369)	11724 (461 5/8)	14077 (554 1/4)
x		0 (0)	0 (0)	0 (0)	0 (0)	0 (0)	0 (0)	0 (0)	0 (0)	0 (0)
y		324 (12 7/8)	486 (19 1/4)	648 (25 5/8)	809 (31 7/8)	971 (38 1/4)	1214 (47 7/8)	1619 (63 3/4)	2024 (79 3/4)	2428 (95 5/8)
x		44 (1 3/4)	66 (2 5/8)	89 (3 5/8)	111 (4 3/8)	133 (5 1/4)	166 (6 5/8)	221 (8 3/4)	277 (11)	332 (13 1/8)
y		259 (10 1/4)	389 (15 3/8)	518 (20 1/2)	648 (25 5/8)	777 (30 5/8)	971 (38 1/4)	1295 (51)	1619 (63 3/4)	1943 (76 1/2)
x		89 (3 5/8)	133 (5 1/4)	177 (7)	221 (8 3/4)	266 (10 1/2)	332 (13 1/8)	443 (17 1/2)	553 (21 7/8)	664 (26 1/4)
y		194 (7 3/4)	291 (11 1/2)	389 (15 3/8)	486 (19 1/4)	583 (23)	728 (28 3/4)	971 (38 1/4)	1214 (47 7/8)	1457 (57 3/8)
x		133 (5 1/4)	199 (7 7/8)	266 (10 1/2)	332 (13 1/8)	398 (15 3/4)	498 (19 5/8)	664 (26 1/4)	830 (32 3/4)	996 (39 1/4)
y		130 (5 1/8)	194 (7 3/4)	259 (10 1/4)	324 (12 7/8)	389 (15 3/8)	486 (19 1/4)	648 (25 5/8)	809 (31 7/8)	971 (38 1/4)
x		177 (7)	266 (10 1/2)	354 (14)	443 (17 1/2)	531 (21)	664 (26 1/4)	886 (35)	1107 (43 5/8)	1328 (52 3/8)
y		65 (2 5/8)	97 (3 7/8)	130 (5 1/8)	162 (6 1/2)	194 (7 3/4)	243 (9 5/8)	324 (12 7/8)	405 (16)	486 (19 1/4)
x		221 (8 3/4)	332 (13 1/8)	443 (17 1/2)	553 (21 7/8)	664 (26 1/4)	830 (32 3/4)	1107 (43 5/8)	1384 (54 1/2)	1660 (65 3/8)
y		0 (0)	0 (0)	0 (0)	0 (0)	0 (0)	0 (0)	0 (0)	0 (0)	0 (0)

Unit: mm (inches)

To calculate the installation positions

$$L (\text{minimum}) = 31.1781 (1 \frac{7}{32}) \times SS - 46.1543 (1 \frac{13}{16})$$

$$L (\text{maximum}) = 47.0644 (1 \frac{27}{32}) \times SS - 42.3308 (1 \frac{21}{32})$$

$$y = -1.463 \times x (\text{mm or inch}) + 8.0942 (5 \frac{7}{16}) \times SS$$

## When using the 4:3 aspect ratio screen size

Screen Size SS (inches)		40	60	80	100	120	150	200	250	300
(mm)		1016	1524	2032	2540	3048	3810	5080	6350	7620
L	minimum	1480 (58 <sup>3</sup> / <sub>8</sub> )	2243 (88 <sup>3</sup> / <sub>8</sub> )	3006 (118 <sup>3</sup> / <sub>8</sub> )	3770 (148 <sup>1</sup> / <sub>2</sub> )	4533 (178 <sup>1</sup> / <sub>2</sub> )	5677 (223 <sup>5</sup> / <sub>8</sub> )	7585 (298 <sup>5</sup> / <sub>8</sub> )	9493 (373 <sup>3</sup> / <sub>4</sub> )	11401 (448 <sup>7</sup> / <sub>8</sub> )
	maximum	2262 (89 <sup>1</sup> / <sub>8</sub> )	3414 (134 <sup>1</sup> / <sub>2</sub> )	4566 (179 <sup>7</sup> / <sub>8</sub> )	5718 (225 <sup>1</sup> / <sub>8</sub> )	6870 (270 <sup>1</sup> / <sub>2</sub> )	8598 (338 <sup>5</sup> / <sub>8</sub> )	11478 (452)	14357 (565 <sup>1</sup> / <sub>4</sub> )	17237 (678 <sup>5</sup> / <sub>8</sub> )
x		0 (0)	0 (0)	0 (0)	0 (0)	0 (0)	0 (0)	0 (0)	0 (0)	0 (0)
y		396 (15 <sup>5</sup> / <sub>8</sub> )	594 (23 <sup>1</sup> / <sub>2</sub> )	792 (31 <sup>1</sup> / <sub>4</sub> )	991 (39 <sup>1</sup> / <sub>8</sub> )	1189 (46 <sup>7</sup> / <sub>8</sub> )	1486 (58 <sup>5</sup> / <sub>8</sub> )	1981 (78)	2477 (97 <sup>5</sup> / <sub>8</sub> )	2972 (117 <sup>1</sup> / <sub>8</sub> )
x		54 (2 <sup>1</sup> / <sub>4</sub> )	81 (3 <sup>1</sup> / <sub>4</sub> )	108 (4 <sup>3</sup> / <sub>8</sub> )	135 (5 <sup>3</sup> / <sub>8</sub> )	163 (6 <sup>1</sup> / <sub>2</sub> )	203 (8)	271 (10 <sup>3</sup> / <sub>4</sub> )	339 (13 <sup>3</sup> / <sub>8</sub> )	406 (16)
y		317 (12 <sup>1</sup> / <sub>2</sub> )	475 (18 <sup>3</sup> / <sub>4</sub> )	634 (25)	792 (31 <sup>1</sup> / <sub>4</sub> )	951 (37 <sup>1</sup> / <sub>2</sub> )	1189 (46 <sup>7</sup> / <sub>8</sub> )	1585 (62 <sup>1</sup> / <sub>2</sub> )	1981 (78)	2377 (93 <sup>5</sup> / <sub>8</sub> )
x		108 (4 <sup>3</sup> / <sub>8</sub> )	163 (6 <sup>1</sup> / <sub>2</sub> )	217 (8 <sup>5</sup> / <sub>8</sub> )	271 (10 <sup>3</sup> / <sub>4</sub> )	325 (12 <sup>7</sup> / <sub>8</sub> )	406 (16)	542 (21 <sup>3</sup> / <sub>8</sub> )	677 (26 <sup>3</sup> / <sub>4</sub> )	813 (32 <sup>1</sup> / <sub>8</sub> )
y		238 (9 <sup>3</sup> / <sub>8</sub> )	357 (14 <sup>1</sup> / <sub>8</sub> )	475 (18 <sup>3</sup> / <sub>4</sub> )	594 (23 <sup>1</sup> / <sub>2</sub> )	713 (28 <sup>1</sup> / <sub>8</sub> )	892 (35 <sup>1</sup> / <sub>8</sub> )	1189 (46 <sup>7</sup> / <sub>8</sub> )	1486 (58 <sup>5</sup> / <sub>8</sub> )	1783 (70 <sup>1</sup> / <sub>4</sub> )
x		163 (6 <sup>1</sup> / <sub>2</sub> )	244 (9 <sup>5</sup> / <sub>8</sub> )	325 (12 <sup>7</sup> / <sub>8</sub> )	406 (16)	488 (19 <sup>1</sup> / <sub>4</sub> )	610 (24 <sup>1</sup> / <sub>8</sub> )	813 (32 <sup>1</sup> / <sub>8</sub> )	1016 (40)	1219 (48)
y		158 (6 <sup>1</sup> / <sub>4</sub> )	238 (9 <sup>3</sup> / <sub>8</sub> )	317 (12 <sup>1</sup> / <sub>2</sub> )	396 (15 <sup>5</sup> / <sub>8</sub> )	475 (18 <sup>3</sup> / <sub>4</sub> )	594 (23 <sup>1</sup> / <sub>2</sub> )	792 (31 <sup>1</sup> / <sub>4</sub> )	991 (39 <sup>1</sup> / <sub>8</sub> )	1189 (46 <sup>7</sup> / <sub>8</sub> )
x		217 (8 <sup>5</sup> / <sub>8</sub> )	325 (12 <sup>7</sup> / <sub>8</sub> )	433 (17 <sup>1</sup> / <sub>8</sub> )	542 (21 <sup>3</sup> / <sub>8</sub> )	650 (25 <sup>5</sup> / <sub>8</sub> )	813 (32 <sup>1</sup> / <sub>8</sub> )	1084 (42 <sup>3</sup> / <sub>4</sub> )	1355 (53 <sup>3</sup> / <sub>8</sub> )	1626 (64 <sup>1</sup> / <sub>8</sub> )
y		79 (3 <sup>1</sup> / <sub>8</sub> )	119 (4 <sup>3</sup> / <sub>4</sub> )	158 (6 <sup>1</sup> / <sub>4</sub> )	198 (7 <sup>7</sup> / <sub>8</sub> )	238 (9 <sup>3</sup> / <sub>8</sub> )	297 (11 <sup>3</sup> / <sub>4</sub> )	396 (15 <sup>5</sup> / <sub>8</sub> )	495 (19 <sup>1</sup> / <sub>2</sub> )	594 (23 <sup>1</sup> / <sub>2</sub> )
x		271 (10 <sup>3</sup> / <sub>4</sub> )	406 (16)	542 (21 <sup>3</sup> / <sub>8</sub> )	677 (26 <sup>3</sup> / <sub>4</sub> )	813 (32 <sup>1</sup> / <sub>8</sub> )	1016 (40)	1355 (53 <sup>3</sup> / <sub>8</sub> )	1693 (66 <sup>3</sup> / <sub>4</sub> )	2032 (80)
y		0 (0)	0 (0)	0 (0)	0 (0)	0 (0)	0 (0)	0 (0)	0 (0)	0 (0)

Unit: mm (inches)

To calculate the installation positions

$$L (\text{minimum}) = 38.1569 (1 \frac{1}{2}) \times SS - 46.1543 (1 \frac{13}{16})$$

$$L (\text{maximum}) = 57.5992 (2 \frac{9}{32}) \times SS - 42.3308 (1 \frac{21}{32})$$

$$y = -1.463 \times x (\text{mm or inch}) + 9.9060 (3 \frac{3}{8}) \times SS$$



## 2 Position the projector so that the lens is parallel to the screen.

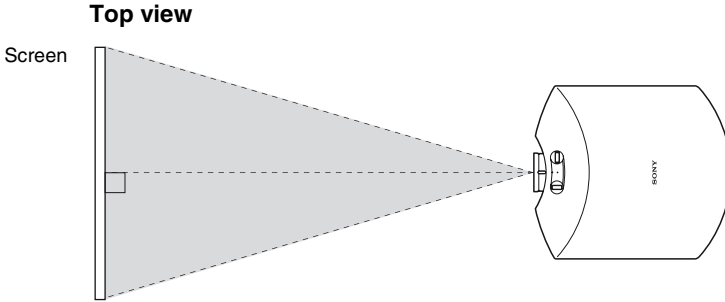

## 3 Project an image on the screen and adjust the picture so that it fits the screen. (☞ page 22)

To project an image, connect video equipment to the projector. (☞ page 18)

### Note

When using a screen with an uneven surface, stripes pattern may rarely appear on the screen depending on the distance between the screen and the projector or the zooming magnifications. This is not a malfunction of the projector.

## Step 2: Connecting the Projector

**When making connections, be sure to do the following:**



- Turn off all equipment before making any connections.
- Use the proper cables for each connection.
- Insert the cable plugs properly; poor connection at the plugs may cause a malfunction or poor picture quality. When pulling out a cable, be sure to pull it out from the plug, not the cable itself.
- Refer to the operating instructions of the connected equipment.

### Connecting to a VCR

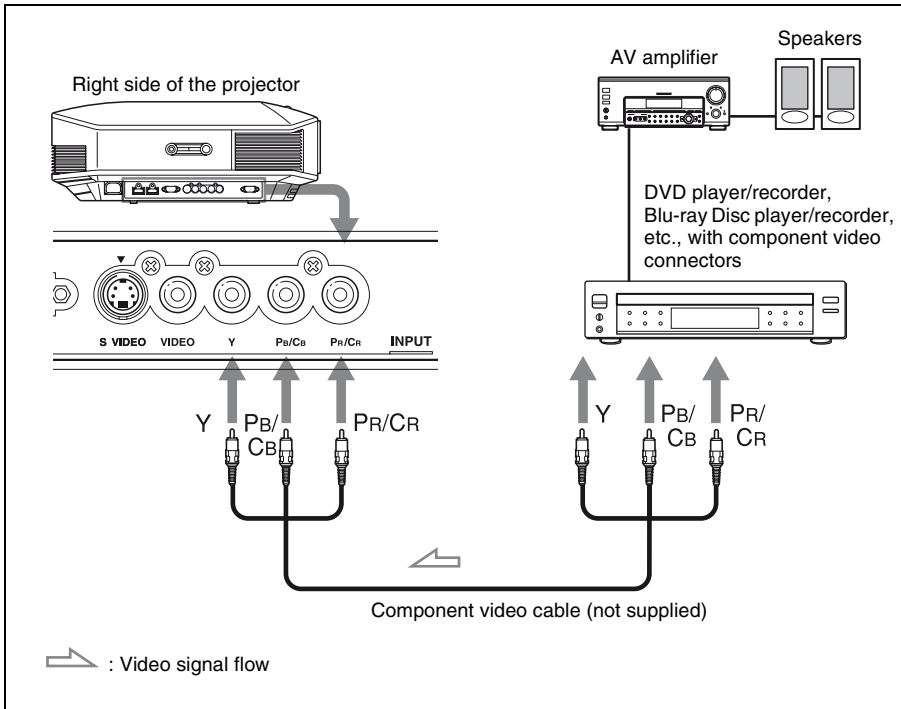
**To connect to a DVD player/recorder or Blu-ray Disc player/recorder equipped with component video connectors**



## To connect to a DVD player/recorder or Blu-ray Disc player/recorder equipped with HDMI output

You can enjoy better picture quality by connecting a DVD player/recorder or Blu-ray Disc player/recorder equipped with HDMI output to the HDMI input of the projector. Moreover, if you have a Control for HDMI compatible equipment, you can operate the projector synchronizing with the Control for HDMI compatible equipment. For details, see the Function  menu ( page 49) and “About the Control for HDMI” ( page 54).

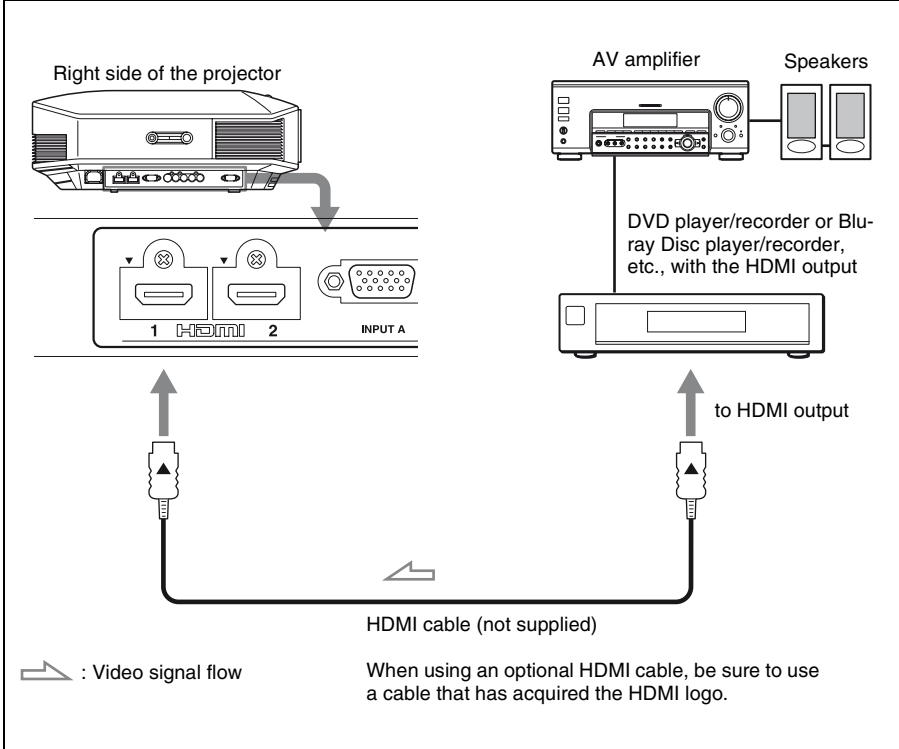

### Notes

- When connecting equipment to the HDMI input of the projector, be sure to use equipment that have acquired the HDMI logo.
- When connecting an HDMI cable to the projector, make sure the ▼ mark on the upper part of the HDMI input of the projector and the ▲ mark on the connector of the cable is set at the same position.
- If the picture from equipment connected to the projector with an HDMI cable is not clear, check the settings of the connected equipment.

Control for HDMI is an HDMI standard mutual control function which uses the HDMI CEC (Consumer Electronics Control) specification.

This projector supports DeepColor, x.v.Color, LipSync and computer input signal of HDMI standards. It also supports HDCP.

## To connect to a VCR equipped with the S video connector or video connector

You can connect a DVD player/recorder, hard disk video recorder, VCR or laser disk player, which is not equipped with component video connectors.

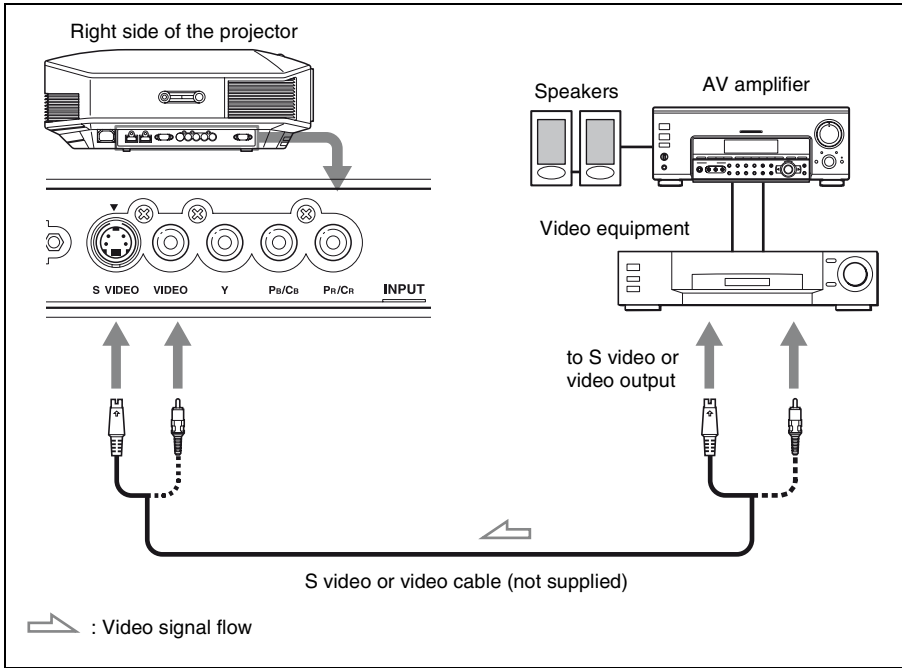

### Tip



If you do not know to which connector you should connect the cable, S VIDEO INPUT (S video input connector) or VIDEO INPUT (video input connector), connect it to S VIDEO to enjoy better picture quality.

If the equipment to be connected has no S video connector, connect the cable to the video output.

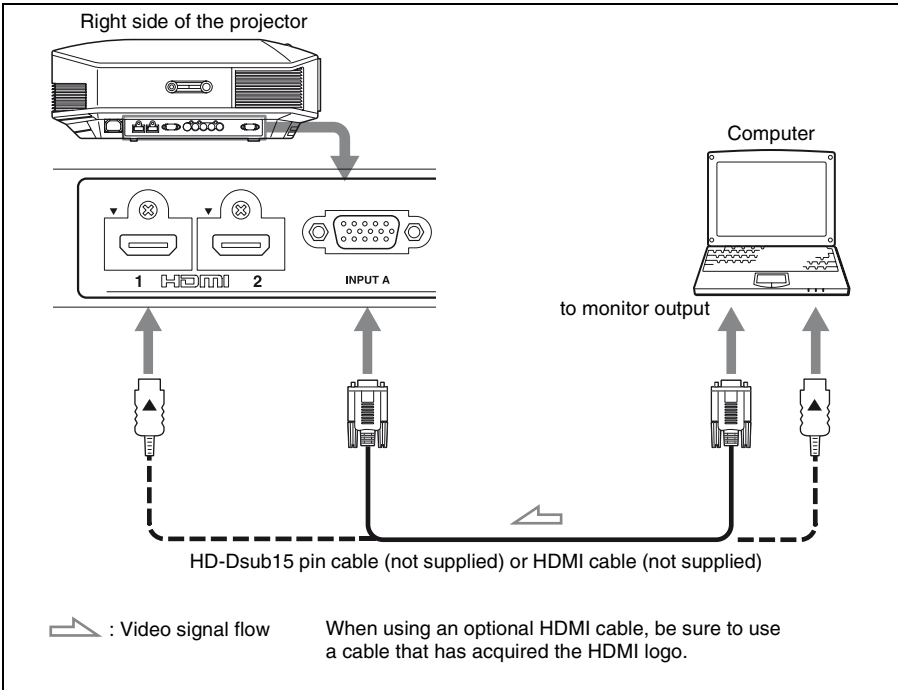
## Connecting to a Computer



### Tip

When connecting an HD-Dsub15 pin cable, set "Input-A Signal Sel." in the Setup  menu to "Auto" or "Computer." If the input signal does not appear properly, set it to "Computer." ( pages 48, 58)

### Notes

- When connecting an HDMI cable, make sure the ▼ mark on the upper part of the HDMI input of the projector and the ▲ mark on the connector of the cable is set at the same position.
- If you set your computer, such as a notebook type, to output the signal to both computer's display and this equipment, the picture of the equipment may not appear properly. Set your computer to output the signal to only the external monitor. For details, refer to the computer's operating instructions supplied with your computer. For settings of the computer, consult with the manufacturer of the computer.
- If the picture from equipment connected to the projector with an HDMI cable is not clear, check the settings of the connected equipment.

# Step 3: Adjusting the Picture Position

Project an image on the screen and then adjust the picture position.

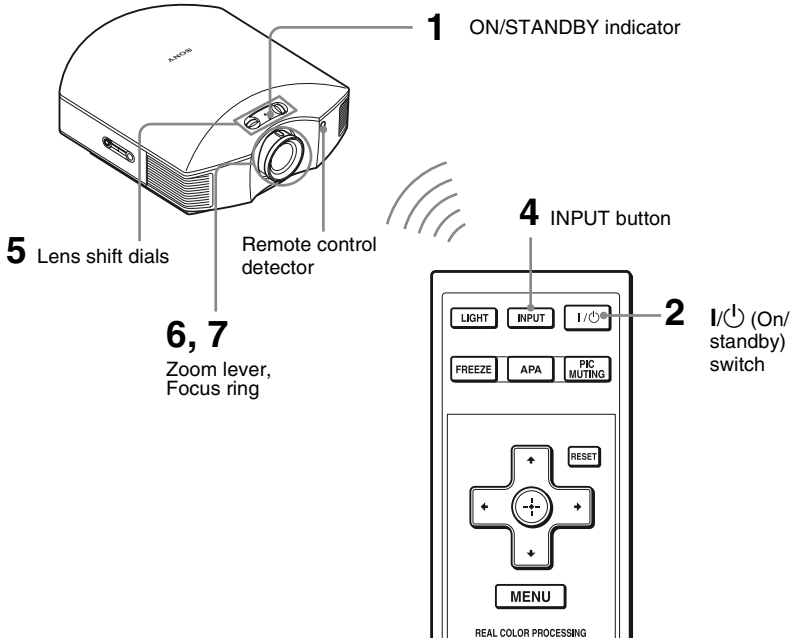

## Tip

The I/⏻ (ON/STANDBY), INPUT, MENU, and ↑/↓/←/→/⊙ (joystick) buttons on the side panel of the projector function the same as those on the remote control.

## Note

Depending on the installation location of the projector, you may not control it with the remote control. In this case, point the remote control to the screen instead of the projector.

ON/STANDBY



Lights in red.

## 1 After connecting the AC cord to the projector plug the AC cord into a wall outlet.

The ON/STANDBY indicator lights in red and the projector goes into standby mode.

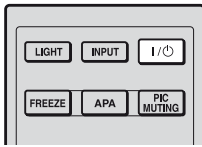

## ON/STANDBY



Flashes in green for a while (tens of seconds) and then lights in green.

## 2 Press the I/⏻ (ON/STANDBY) switch to turn on the projector.

The ON/STANDBY indicator flashes in green, and then lights in green. When the ON/STANDBY indicator flashes, “Starting...” appears on the screen.

## 3 Turn on the equipment connected to the projector.

Refer to the operating instructions of the connected equipment.

## 4 Press INPUT to project the picture on the screen.

Each time you press the button, the input indication and equipment to be projected change. (☞ page 28)

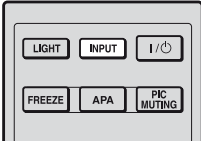

### Tips

- You can select the desired language for the menu screen. For details, refer to “Step 4: Selecting the Menu Language”. (☞ page 26)
- When “Auto Input Search” is set to “On” in the Function  menu, the input terminal with effective signals is automatically displayed by pressing INPUT. (☞ page 49)

## 5 Move both lens shift dials to adjust the picture position.

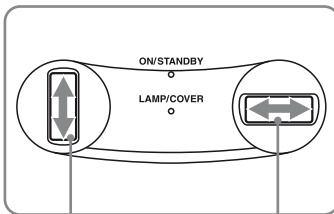

To adjust the vertical position

To adjust the horizontal position

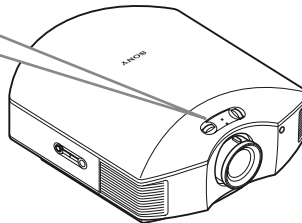



## To adjust the horizontal position

Turn the lens shift dial right or left.

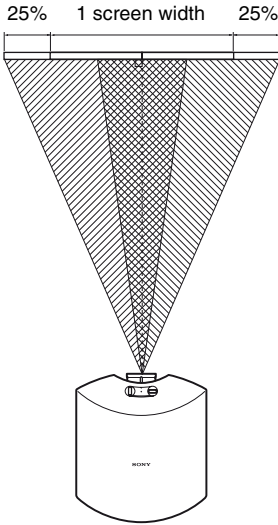
The picture projected on the screen moves right or left by a maximum of 25% of the screen width from the center of the lens.



Top view

-  : Picture position when moving the picture to the left at maximum
-  : Picture position when moving the picture to the right at maximum



## To adjust the vertical position

Turn the lens shift dial up or down.

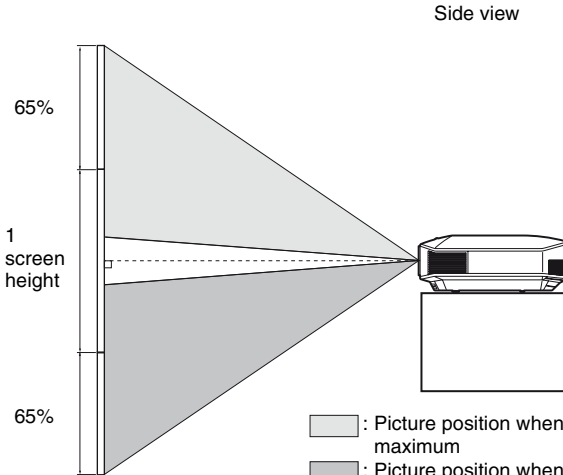
The picture projected on the screen moves up or down by a maximum of 65% of the screen height from the center of the lens.



Side view

-  : Picture position when moving the picture upward at maximum
-  : Picture position when moving the picture downward at maximum

### Note

When you use both the horizontal and vertical lens shift features at the same time, the distance the picture projected on the screen moves differ depending on how much the lens shift is adjusted. For details, see the table on page 15 or 16.



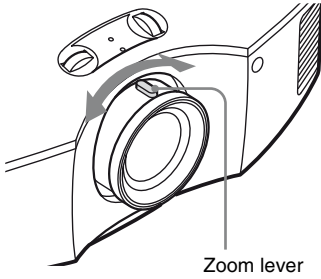

- 6** Adjust the picture size using the zoom lever.

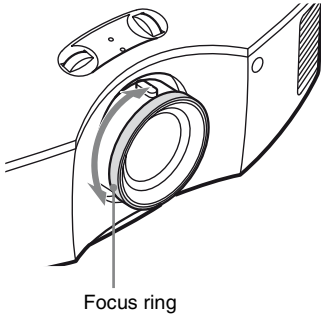

- 7** Adjust the focus using the focus ring.

### To adjust the tilt of the installation surface

If the projector is installed on an uneven surface, use the adjusters to keep the projector level.

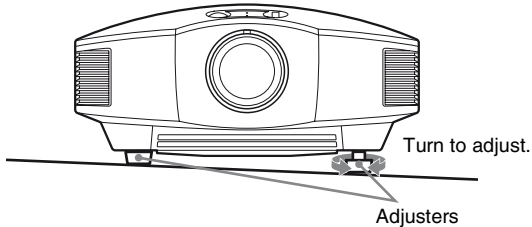

#### Note

Be careful not to catch your finger when turning the adjusters.

# Step 4: Selecting the Menu Language

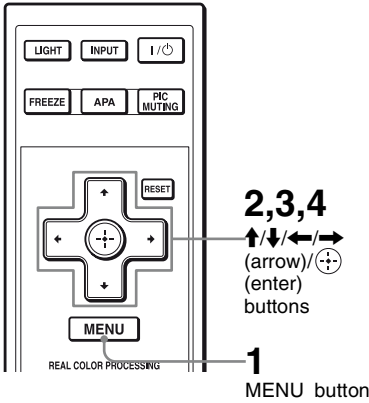

You can select one of 16 languages for displaying the menu and other on-screen displays. The factory default setting is English. To change the current menu language, set the desired language with the menu screen.



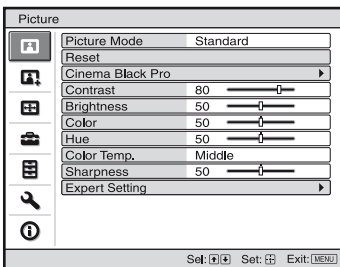

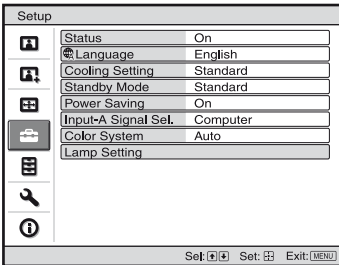
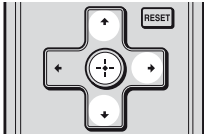
- 1 Press MENU.**  
The menu appears.





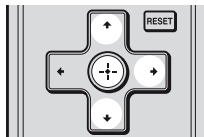

- 2** Press **↑/↓** to select the **Setup**  menu, and press **→** or .
- The setting items of the selected menu appears.

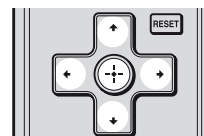

- 3** Press **↑/↓** to select “Language,” and press **→** or .



- 4** Press **↑/↓/←/→** to select a language, and press .
- The menu changes to the selected language.

### To clear the menu

Press MENU.

# Projecting

This section describes how to operate the projector to view the picture from the equipment connected to the projector. It also describes how to adjust the quality of the picture to suit your taste.

## Projecting the Picture on the Screen

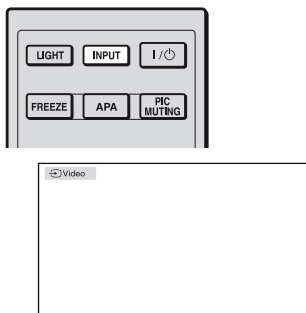



**Example:** To view the picture from the video equipment connected to the VIDEO INPUT connector.

- 1 Power on both the equipment and the device connected to the equipment.**
- 2 Press INPUT repeatedly to select the input you want to project on the screen.**  
Display the indication of the input you want.

To view the picture from	Press INPUT to display
Video equipment connected to the VIDEO INPUT connector	Video
Video equipment connected to the S VIDEO INPUT connector	S-Video
Component equipment connected to the Y Pb/Cb Pr/Cr connector	Component
RGB/component equipment connected to the INPUT A connector	Input-A*
Equipment connected to the HDMI 1 connector	HDMI 1
Equipment connected to the HDMI 2 connector	HDMI 2

\* Set the “Input-A Signal Sel.” setting in the Setup  menu according to the signal input. When you set it to “Auto,” and cannot display the picture properly, select an appropriate signal according to the input signal. (☞ pages 48, 53)

### Tips

- When “Auto Input Search” is set to “On” in the Function  menu, the input terminal with effective signals is automatically displayed by pressing INPUT.
- When the “Control for HDMI” is set to “On” in the Function  menu, the input terminal with effective signals is automatically displayed, synchronizing with the operation of the equipment connected to HDMI 1 or HDMI 2 input of the projector. (Only when the connected equipment supports Control for HDMI compatible.)



## Notes on input of HDMI signal

The projector adjusts the RGB dynamic range of the equipment connected with HDMI cable to the following to suit the HDMI standard and display in best picture quality.

When video signal is input: Limited (16-235)

When computer signal is input: Full (0-255)

When a signal other than those of HDMI standard is input, the following symptoms may occur.

- When a video signal is input, the color gradation of the dark area or bright area may become unclear, or texts may become faded. In this case, switch the RGB dynamic range of the connected equipment to Limited (16-235). If this adjustment is unavailable, adjust “Brightness”, “Contrast”, or “Sharpness” in the Picture  menu of the projector. (📖 page 42)
- When a computer signal is input, the texts may become faded. In this case, adjust the “Sharpness” in the Picture  menu. (📖 page 42)

## Turning Off the Power

### 1 Press the I/⏻ (ON/STANDBY) switch.

A message “POWER OFF?” appears on the screen.

### 2 Press the I/⏻ (ON/STANDBY) switch again before the message disappears.

The ON/STANDBY indicator flashes in green and the fan continues to run to reduce the internal heat. First, the ON/STANDBY indicator flashes quickly, during which you will not be able to light up the ON/STANDBY indicator with the I/⏻ (ON/STANDBY) switch.

### 3 Confirm that the fan stops running and the ON/STANDBY indicator lights in red.

You can turn off the projector by holding the I/⏻ (ON/STANDBY) switch for about 1 second, instead of performing the above steps.

# Selecting the Wide Screen Mode

You can enjoy various wide screen modes according to the video signal received.

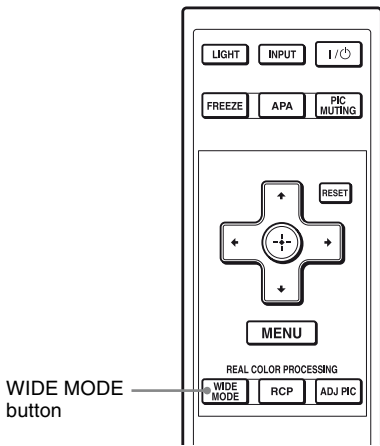

## Press WIDE MODE.

Each time you press the button, you can select the “Wide Mode” setting.

You can also select it using the menu.

(☞ page 45)

Original image

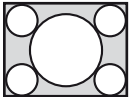

When the Wide Mode is operated

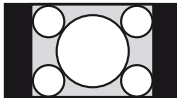
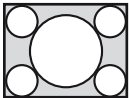
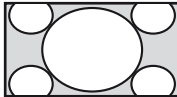

Squeezed

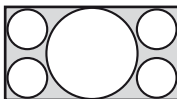
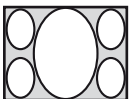

## Wide Zoom

A 4:3 aspect ratio picture is enlarged naturally to fill the screen. The upper and lower portions of the screen are slightly cut off.

## Normal

A 4:3 aspect ratio picture is displayed in the center of the screen and enlarged to fill the screen vertically.

## Full

A picture squeezed to 4:3 aspect ratio is displayed in its original aspect ratio. When a 4:3 aspect ratio picture is displayed, the picture is enlarged horizontally to fill the 16:9 screen.

## Tip

Squeezed: An original 16:9 aspect ratio picture is recorded horizontally compressed to a 4:3 picture.

Letterbox picture with side panels



Letterbox picture

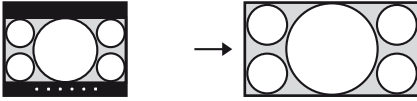

## Zoom

A 16:9 aspect ratio picture is enlarged vertically and horizontally in the same ratio to fill the screen. Use this mode to view a letterbox picture or a letterbox picture with side panels.

If the subtitle of a movie, etc. is hidden and cannot be seen, adjust the screen with “Vertical Size” and “V Center” to display the subtitle. (☞ page 46)



## Full 1 (When a computer signal is input)

Displays a picture on the whole of the screen without changing the aspect ratio of the original picture.

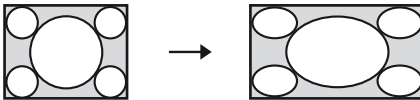

## Full 2 (When a computer signal is input)

Displays a picture on the whole of the screen.

### Note

You can adjust the vertical position of the picture with “V Center” and “Vertical Size” in the Screen  menu only when “Zoom” is selected. (☞ page 46)

## Notes on selecting the wide screen mode

The projector is featured with the WIDE MODE. When changing the settings of WIDE MODE, use caution as described below.

- Select the wide screen mode taking into account that changing the aspect ratio of the original picture will provide a different look from that of the original image.
- Note that if the projector is used for profit or for public viewing, modifying the original picture by switching to the wide mode may constitute an infringement of the rights of authors or producers, which are legally protected.

# Selecting the Picture Viewing Mode

You can select the picture viewing mode that best suits the type of program or room conditions.

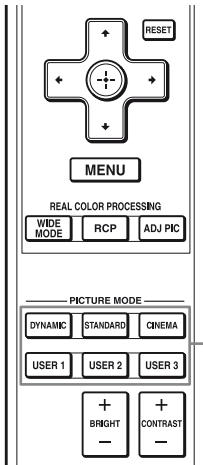

PICTURE MODE buttons  
DYNAMIC  
STANDARD  
CINEMA  
USER 1,  
USER 2  
and USER 3

Press one of the **PICTURE MODE** buttons (**DYNAMIC, STANDARD, CINEMA** and **USER 1, USER 2** and **USER 3**).

## **DYNAMIC**

Vivid picture quality that enhances the sharpness and contrast of the picture.

## **STANDARD**

Standard picture quality that emphasizes on naturalness.

## **CINEMA**

Picture quality suited for watching movies.

## **USER 1, USER 2 and USER 3**

You can adjust the quality of the picture to suit your taste and store the settings into the selected memory of the projector. Press one of the **USER 1, USER 2** and **USER 3** buttons, then adjust the picture by using the buttons on the remote control or the menus (☞ pages 33, 41). The settings are stored, and you can view the picture with the adjusted picture quality by pressing the button.



# Adjusting the Picture Quality

You can adjust the picture quality that suits your taste by selecting the adjustment items with the remote control. The adjusted data can be stored in each picture mode.

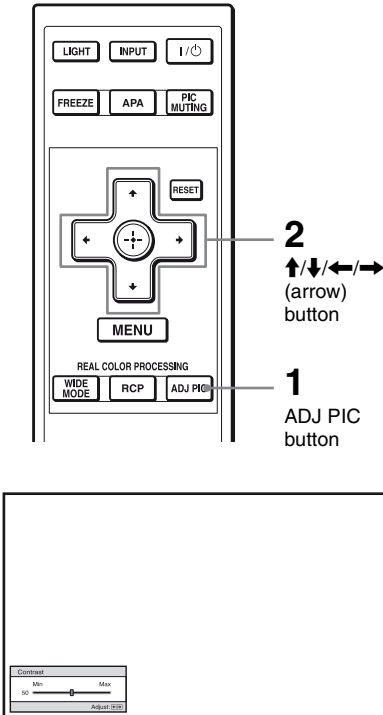

**Example:** To adjust the contrast

## 1 Press ADJ. PIC.

Each time you press the button, the following adjustment windows are displayed repeatedly in sequence. “Advanced Iris”, “Lamp Control”, “Contrast”, “Brightness”, “Color”, “Hue”, “Color Temp.”, “Sharpness”, “NR”, “MPEG NR”, “Film Mode”, “Black Level Adj.”, “Gamma Correction”, “x.v.Color”, “Color Space”.



For details on each adjustment, see the Picture  menu. (☞ page 41)

### Note

Some adjustment windows cannot be displayed, depending on the type of input signal. For details, see “Input Signals and Adjustable/Setting Items” (☞ page 69)

## 2 Make the setting or adjustment on an item.

### When changing the adjustment level

To increase the value, press .  
To decrease the value, press .

### When changing the setting

Press  to change the setting.

# Adjusting the Picture Using Real Color Processing

The Real Color Processing (RCP) feature allows you to adjust the color and hue of each target of the projected picture you specify independently. You can thus obtain a picture more suitable to your taste.

## Tip

Freeze the scene of the video source when you are adjusting the picture using Real Color Processing.

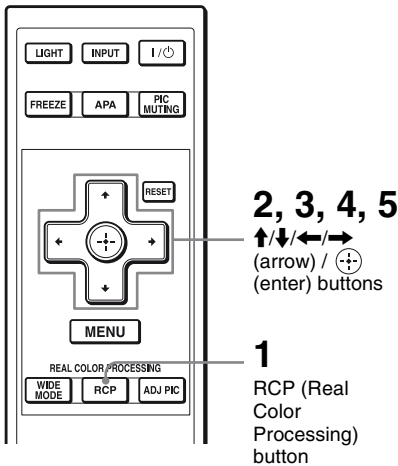

- 1 Press RCP on the remote control.
- 2 Press **↑/↓** to select “User 1,” “User 2” or “User 3,” then press **→**.

The RCP (Real Color Processing) window appears.

- 3 Select the target color you want to adjust.

Repeat steps **1** and **2** described below to specify the target color.

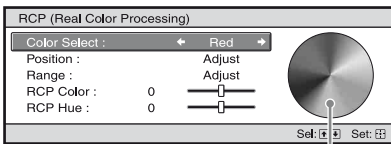

Reference palette

- 1 Press **↑/↓** to select “Color Select,” then press **←/→** to select the color you want to adjust among “Red,” “Yellow,” “Green,” “Cyan,” “Blue” and “Magenta.”

Only the portions that correspond to the specified color will be colored and the other portions will be displayed in black and white. The reference palette in the RCP window also shows the adjustable colors. Select the desired setting to adjust the color on the projected image using the reference palette as a guide.

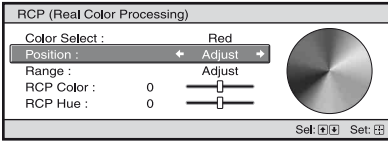

- 2 Press  $\uparrow/\downarrow$  to select “Position” or “Range,” and specify it more delicate color position and color range you want to adjust using  $\leftarrow/\rightarrow$ .

#### 4 Adjust the color of the specified portions.

Press  $\uparrow/\downarrow$  to select “RCP Color” or “RCP Hue,” then adjust the color or hue of the portions selected in step 3 to suit your taste using  $\leftarrow/\rightarrow$  while watching the projected picture. The picture is returned to normal color during adjustment.

#### 5 After the adjustment is complete, press $\oplus$ .

The RCP window disappears and the picture of step 2 is appeared. Then after a few seconds, normal picture is restored.

#### Tip

There are some limitations on selection of position and range.

# Using Other Functions

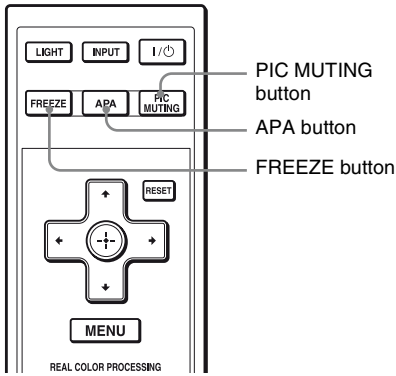

## Press PIC MUTING.

Press to temporarily turn off a projected picture. To return to the previous screen, press PIC MUTING again.

## Press APA.

Press to automatically adjust a picture from a computer to a position where it looks clear.

## Press FREEZE.

Press to pause and display a projected picture. To return to the previous screen, press FREEZE again.

### Note

APA and FREEZE are available only for computer signal.

# Using the Menus

This section describes how to make various adjustments and settings using the menus.

## Operation through the Menus

The projector is equipped with an on-screen menu for making various adjustments and settings. Some of the adjustable/setting items are displayed in a pop-up menu, in a setting menu or adjustment menu with no main menu, or in the next menu window. If you select an item name followed by an arrow (▶), the next menu window with setting items appears. To change the on-screen menu language, see “Step 4: Selecting the Menu Language.” (☞ page 26)

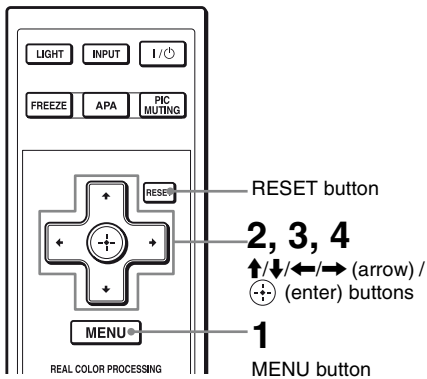



## 1 Press MENU.

The menu window appears.

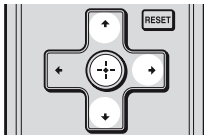
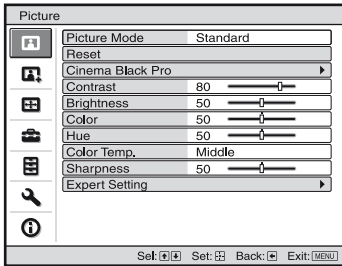

## 2 Press ↑/↓ to select a menu item, and press → or ⬇️.

The items that can be set or adjusted with the selected menu appear. The item presently selected is shown in yellow.

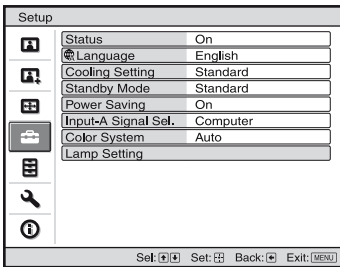

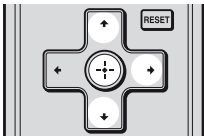

**3** Press **↑/↓** to select an item you want to set or adjust and press **→** or **⊕**.

The setting items are displayed in a pop-up menu, in a setting menu, in an adjustment menu or in the next menu window.

Pop-up menu

Setting items



Setting menu

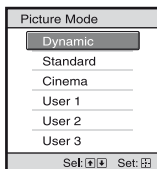

Adjustment menu

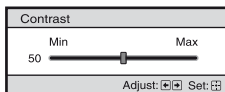

Next menu window

Setting items

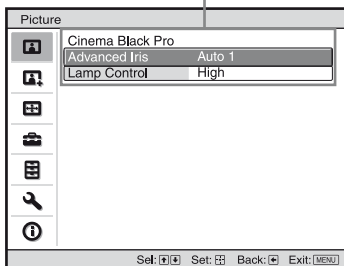

## 4 Make the setting or adjustment of an item.

### When changing the adjustment level

To increase the value, press **↑/→**.

To decrease the value, press **↓/←**.

Press **⊕** to restore the original screen.

### When changing the setting

Press **↑/↓** to change the setting.

Press **⊕** to restore the original screen.

You can restore the original screen using **←** depending on the selected item.

## Items that cannot be adjusted

Adjustable items differ depending on the input signal. The items that cannot be adjusted or set do not appear in the menu.

(☞ page 69)

## To clear the menu

Press MENU.

## To reset the picture that has been adjusted

Select “Reset” from Picture **Ⓜ** menu.

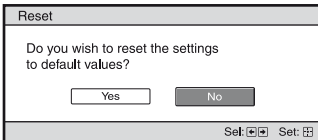

When the screen display appears, select “Yes” using **←** and press **⊕**.

All of the following settings are reset to its factory preset value.

The settings of “Cinema Black Pro”,

“Contrast”, “Brightness”, “Color”,

“Hue”, “Color Temp”, “Sharpness” and

“Expert Setting” on the Picture **Ⓜ** menu

## To reset the items that have been adjusted

Select an item in the Menu screen, and display the pop-up menu, the setting menu, and the adjustment menu.

Press the RESET on the remote control to reset only the selected settings to its factory preset value.

### Note

RESET button on the remote control is available only when the adjustment menu or the setting menu is selected.



# Picture Menu

The Picture menu is used for adjusting the picture.

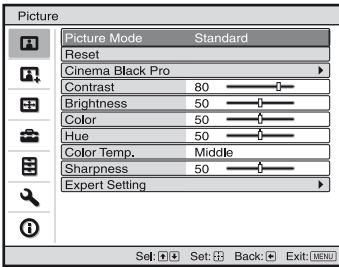

## Note

These items may not be available, depending on the type of input signal. For details, see “Input Signals and Adjustable/Setting Items” (page 69).

<p><b>Picture Mode</b></p>	<p><b>You can select the picture viewing mode that best suits the type of picture or the environment.</b></p> <p><b>Dynamic:</b> Vivid picture quality that enhances sharpness and contrast of the picture.</p> <p><b>Standard:</b> Standard picture quality that emphasizes on naturalness.</p> <p><b>Cinema:</b> Picture quality suited for watching movies.</p> <p><b>User 1, User 2, User 3:</b> You can adjust the quality of the picture to suit your taste and then store the settings. Once the settings are stored, you can view the picture with the adjusted picture quality by pressing the PICTURE MODE button on the remote control.</p> <p><b>To store the settings</b></p> <ol style="list-style-type: none"> <li>1 Select User 1, User 2, or User 3.</li> <li>2 Adjust the items you want in the menus.</li> </ol> <p><b>Tip</b></p> <p>You can also store the settings if the picture quality is adjusted in “Dynamic”, “Standard” or “Cinema”. To reset everything to the factory settings, select “Reset” from the menu.</p>
----------------------------	--

<b>Cinema Black Pro</b>	<p><b>Advanced Iris</b>  <b>Switches the iris function during projection.</b>  <b>Auto 1:</b> Automatically switches to an optimum iris according to a projected scene. The contrast of the scene is emphasized most.  <b>Auto 2:</b> An optimum iris becomes smaller than when set to “Auto 1”. The contrast of the scene becomes reduced.  <b>Sensitivity:</b> If “Auto 1” or “Auto 2” is selected, either “Recommend”, “Fast”, or “Slow” can be selected according to the desired response speed with Sensitivity Mode.  <b>Manual:</b> Manually adjusts the Iris.</p> <div data-bbox="555 357 777 445" style="text-align: center;"> </div> <p><b>Off:</b> Normal contrast.</p>
	<p><b>Lamp Control</b>  <b>Switches the lamp wattage during projection.</b>  <b>High:</b> Normal wattage.  <b>Low:</b> Enhances the black by reducing the lamp wattage.  <b>Tip</b>  When you switch from “Low” to “High”, the number of turns of the fan increases, and the fan noise becomes slightly louder.</p>
<b>Contrast</b>	<p><b>Adjusts the white area of pictures (white level).</b>  The higher the setting, the greater the contrast. The lower the setting, the lower the contrast.  You can make adjustments by pressing the CONTRAST+/- on the remote control.</p>
<b>Brightness</b>	<p><b>Adjusts the brightness of the picture.</b>  The higher the setting, the brighter the picture. The lower the setting, the darker the picture.  You can make adjustments by pressing the BRIGHT+/- on the remote control.</p>
<b>Color</b>	<p><b>Adjusts the intensity of the color density.</b>  The higher the setting, the greater the intensity. The lower the setting, the lower the intensity.</p>
<b>Hue</b>	<p><b>Adjusts the color tone.</b>  The higher the setting, the more greenish the picture becomes. The lower the setting, the more reddish the picture becomes.</p>
<b>Color Temp.</b>	<p><b>Adjusts the color temperature.</b>  <b>High:</b> Gives white colors a blue tint.  <b>Middle:</b> Gives a neutral tint between “High” and “Low”.  <b>Low:</b> Gives white colors a red tint.  <b>Custom 1, Custom 2, Custom 3, Custom 4:</b> Enables you to adjust, set, and store your favorite color temperature.</p>
<b>Sharpness</b>	<p><b>Sharpens the outline of the picture, or reduces the noise.</b>  The higher the setting, the sharper the picture. The lower the setting, the softer the picture, thus reducing the noise.</p>

<b>Expert Setting</b>	<p><b>NR (Noise Reduction)</b>  <b>Reduces the roughness or noise of the picture.</b>  Usually, select “Off”.  If the picture is rough or noisy, select a setting from among “Low”, “Middle” or “High” according to the input signal source.</p>
	<p><b>MPEG NR (MPEG Noise Reduction)</b>  <b>Reduces block noise and mosquito noise, in particular in digital signals.</b>  <b>Block NR:</b> Reduces digital noise that appears in mosaic-like pattern.  <b>Mosquito NR:</b> Reduces digital noise that appears near the outline of the picture.</p>
	<p><b>Film Mode</b>  <b>According to the film source you have selected, make a setting for playback.</b>  <b>Auto:</b> Reproduces a 2-3 or 2-2 Pull-Down format video signal, such as film sources, in a smooth picture movement. When a video signal other than 2-3 or 2-2 Pull-Down format is input, the picture is played back in progressive format.  <b>Off:</b> Plays back the picture in progressive format without detecting video signals automatically.</p>
	<p><b>Black Level Adj. (Adjust)</b>  <b>Produces a bolder, dynamic picture.</b>  Set according to the input signal source.  <b>High:</b> Gives higher emphasis to the black color.  <b>Low:</b> Gives lower emphasis to the black color.  <b>Off:</b> Cancels this feature.</p>
	<p><b>Gamma Correction</b>  <b>Adjusts the response characteristics of the tone of the picture.</b>  Select a favorite tone from 3 options.  <b>Gamma 1:</b> Makes the scene a little brighter overall.  <b>Gamma 2:</b> Makes the scene brighter overall.  <b>Gamma 3:</b> Makes the scene darker overall.  <b>Off:</b> Gamma Correction is “Off”</p>
	<p><b>x.v.Color</b>  <b>Set this item when playing back an x.v.Color video signal.</b>  Set this item to “On” when connecting the projector with equipment that supports x.v.Color and playing back an x.v.Color video signal.  For details on x.v.Color, see “About the x.v.Color” (ⓘ page 54).</p>
	<p><b>Color Space</b>  <b>You can convert the range of color reproduction.</b>  <b>Normal:</b> Converts the color to Hi-Vision color.  <b>Wide:</b> Reproduces more natural color tones in a wider range of color reproduction, compared to “Normal”.</p>

---

# Advanced Picture Menu

The Advanced Picture is used for adjusting the picture more.

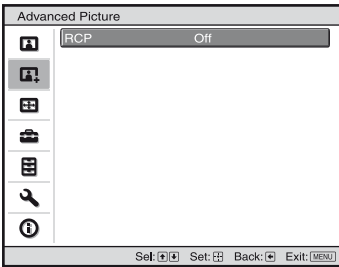

## RCP (Real Color Processing)

**You can adjust the color and hue of each selected portion of the picture independently.**

**User 1, User 2, User 3:** You can adjust the picture using Real Color Processing and store the settings. Once the settings are stored, you can view the picture with the adjusted picture quality.

**Off:** Cancels this feature.

For details, see “Adjusting the Picture Using Real Color Processing”.  
(📖 page 34)

# Screen Menu



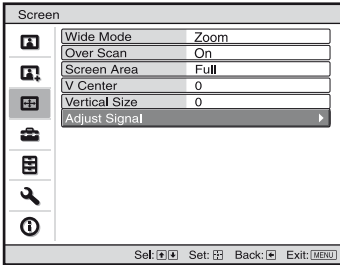



The Screen menu is used to adjust the input signal. You can adjust the size of the picture, and select wide screen mode, etc.



## Note

These items may not be available, depending on the type of input signal. For details, see “Input Signals and Adjustable/Setting Items” (☞ page 69).

<p><b>Wide Mode (Video signal)</b></p>	<p>You can set the aspect ratio of the picture to be displayed for the current input signal. (☞ page 30) This item is enabled only when a video signal (preset memory numbers 1 to 14) (☞ page 66) is input.</p> <p><b>Wide Zoom:</b> A 4:3 aspect ratio picture is enlarged naturally to fill the screen. The upper and lower portions of the screen are slightly cut off.</p> <p><b>Normal:</b> A 4:3 aspect ratio picture is displayed in the center of the screen and enlarged to fill the screen vertically.</p> <p><b>Full:</b> A picture squeezed to 4:3 aspect ratio is displayed in its original aspect ratio. When a 4:3 aspect ratio picture is displayed, the picture is enlarged horizontally to fill the 16:9 screen.</p> <p><b>Zoom:</b> A 16:9 aspect ratio picture is enlarged vertically and horizontally in the same ratio to fill the screen.</p> <p>You can switch settings by pressing WIDE MODE on the remote control.</p>
<p><b>Wide Mode (Computer signal)</b></p>	<p>You can set the aspect ratio of the picture to be displayed for the current input signal. (☞ page 31) This item is enabled only when a computer signal is input.</p> <p><b>Full 1:</b> Displays a picture on the whole of the screen without changing the aspect ratio of the original picture.</p> <p><b>Full 2:</b> Displays a picture on the whole of the screen.</p> <p><b>Zoom:</b> A 16:9 aspect ratio picture is enlarged vertically and horizontally in the same ratio to fill the screen.</p> <p>You can switch settings by pressing WIDE MODE on the remote control.</p>

<b>Over Scan</b>	<p><b>Hides the outline of the picture.</b>  <b>On:</b> Hides the outline of the input picture. Select this setting when noise appears along the edge of the picture.  <b>Off:</b> Projects the whole of the input picture.</p> <p><b>Tip</b>  To display the displayable region within the four directions of the screen, refer to “Blanking” on the Installation  menu ( page 50).</p>
<b>Screen Area</b>	<p><b>Selects the size of the picture when a Hi-Vision picture is overscanned.</b>  <b>Full:</b> Expands the picture on the whole of the screen.  <b>Through:</b> Does not expand the picture on the whole of the screen.</p>
<b>V Center</b>	<p><b>Adjust the whole picture by moving up and down on the screen.</b>  As the selected number increases, the screen moves up, and as the selected number decreases, the screen moves down.</p>
<b>Vertical Size</b>	<p><b>Reduces or enlarges the picture vertically.</b>  The screen is enlarged as the setting increases and reduced as the setting decreases. If the subtitle of a movie, etc. cannot be seen, use this together with “V Center”.</p>
<b>Adjust Signal</b>	<p><b>You can adjust the input signal.</b>  <b>APA:</b> Adjusts “Phase”, “Pitch”, and “Shift” automatically to a position that suits the image signal for pictures from a computer. You can make adjustments by pressing APA on the remote control.  <b>Phase:</b> Adjusts the dot phase and the phase of computer signal of pictures from a computer. Adjusts the picture to the point where it looks clearest.  <b>Pitch:</b> Adjusts the horizontal size of the picture from a computer.  As the number increases, the picture becomes wider, and as the number decreases, the picture becomes narrower. Adjust the setting to match the number of dots of the input signal.  <b>Shift:</b> Adjusts the position of the picture.  <b>H:</b> As the setting for H (horizontal) increases, the picture moves to the right, and as the setting decreases, the picture moves to the left. Use  /  to adjust the horizontal position.  <b>V:</b> As the setting for V (vertical) increases, the picture moves up, and as the setting decreases, the picture moves down. Use  /  to adjust the vertical position.</p>

# Setup Menu

The Setup menu is used to change the factory preset settings, etc.

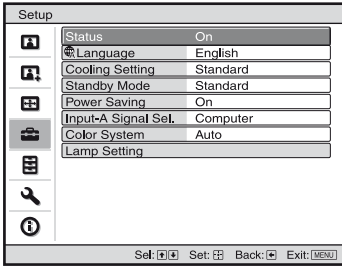

<b>Status</b>	<p><b>Sets whether or not the on-screen display is displayed.</b> Set to “Off” to turn off the on-screen displays except for certain menus, message when turning off the power, and warning messages.</p>
<b>Language</b>	<p><b>Selects the language used in the menu and on-screen displays.</b> Available languages are: English, Dutch, French, Italian, German, Spanish, Portuguese, Russian, Swedish, Norwegian, Japanese, Chinese (Simplified Chinese), Chinese (Traditional Chinese), Korean, Thai and Arabic.</p>
<b>Cooling Setting</b>	<p><b>Use this item when using the projector at high altitudes.</b> <b>High:</b> Use this setting when using the projector at an altitude of 1,500 m or higher. <b>Standard:</b> Use this setting when using the projector at normal altitudes.</p> <p><b>Note</b> When this item is set to “High”, the fan noise becomes slightly louder since the number of fan rotation increases.</p>
<b>Standby Mode</b>	<p><b>Lowers the power consumption in standby.</b> When set to “Standard”, the power consumption in standby becomes normal. When set to “Low”, the power consumption in standby is lowered.</p> <p><b>Note</b> When this item is set to “Low”, the Control for HDMI function will not operate.</p>
<b>Power Saving</b>	<p><b>Sets the power saving mode.</b> When set to “On”, the projector goes into power saving mode if no signal is input for 10 minutes. At that time, the ON/STANDBY indicator lights in orange, then the screen becomes dark. In power saving mode, the power saving mode is cancelled if a signal is input or any button on the projector or the remote control is pressed. If you do not want to set the projector to power saving mode, select “Off”.</p>

<p><b>Input-A Signal Sel.</b></p>	<p><b>Selects the type of signal input from the equipment connected to the INPUT A connector.</b>  Selects the type of signal input from the equipment by selecting "Input-A" with the INPUT button.  <b>Auto:</b> Selects the input signal type automatically.  <b>Computer:</b> Inputs the signal from a computer.  <b>Video GBR:</b> Inputs the signal from a TV game or HDTV broadcast.  <b>Component:</b> Inputs the component signal from a DVD player/recorder, Blu-ray Disc player/recorder, digital tuner, etc.</p> <p><b>Note</b></p> <p>When the input signal is not displayed correctly with this item set to "Auto," select the item according to the input signal.</p>
<p><b>Color System</b></p>	<p><b>Selects the color system of the input signal.</b>  <b>Auto:</b> Selects the color system of the input signal automatically from among NTSC<sup>3.58</sup>, PAL, SECAM, NTSC<sup>4.43</sup>, PAL-M, PAL-N, or PAL60.  "NTSC<sup>3.58</sup>"-"PAL-N": Allows you to set the color system to the selected system manually.</p> <p><b>Note</b></p> <p>Normally, set this to "Auto." If the picture is distorted or colorless, select the color system appropriate for the input signal.</p>
<p><b>Lamp Setting</b></p>	<p><b>When replacing the lamps, set the desired lamp setting.</b>  (☞ page 61)</p>



# Function Menu

The Function menu is used for changing the settings of the various functions of the projector.

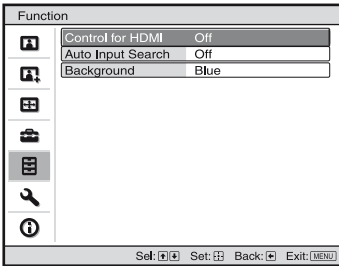





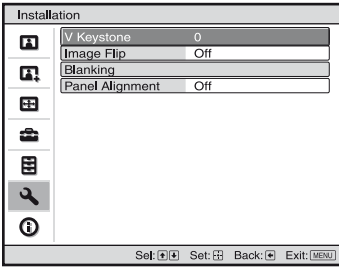

<p><b>Control for HDMI</b></p>	<p><b>Selects the function whether to turn the Control for HDMI function effective, when the HDMI 1 INPUT and HDMI 2 INPUT connectors are connected to a Control for HDMI compatible equipment.</b></p> <p><b>Control for HDMI:</b> When set to “On”, the Control for HDMI function is turned effective and the following settings can be assigned.</p> <p><b>Device Auto Power Off:</b> When set to on “On”, the projector is powered off while the Control for HDMI compatible equipment connected to the projector is also powered off at the same time.</p> <p><b>PJ Auto Power On:</b> When set to “On”, the Control for HDMI compatible equipment connected to the projector is automatically powered on or played back, etc., while the projector is also powered on at the same time.</p> <p><b>Device List:</b> Lists all the Control for HDMI compatible equipment connected to the HDMI 1 and HDMI 2 INPUT connectors of the projector.</p> <p><b>Notes</b></p> <ul style="list-style-type: none"> <li>• When “Standby Mode” is set to “Low”, this item will not operate.</li> <li>• To operate the connected equipment, be sure the equipment is Control for HDMI compatible and assign the appropriate settings to use the Control for HDMI function.</li> </ul> <p>For details, see “About the Control for HDMI” (Ⓞ page 54).</p>
<p><b>Auto Input Search</b></p>	<p><b>Detects the input signal and displays the detected input signal automatically when the INPUT button is pressed.</b></p> <p>When set to “On”, the input terminal with effective signal is automatically detected and pictures are displayed by pressing INPUT. Input signals are detected in the sequence of Component, HDMI 1, HDMI 2, Video, S-video and Input-A, and the input terminal that follows the currently selected input terminal will be detected. Set this to “Off” when you want to select an input selector with no input signal, or you want to switch the setting manually.</p>
<p><b>Background</b></p>	<p><b>Selects the background color of the screen when no signal is input.</b></p> <p>You can select “Black” or “Blue”.</p>

# Installation Menu

The Installation menu is used for changing the installation settings.



<p><b>V Keystone</b></p>	<p><b>Corrects the vertical trapezoidal distortion of the picture.</b>  <b>When the bottom of the trapezoid is longer than the top</b> (  ):          Sets a lower value (– direction)  <b>When the top of the trapezoid is longer than the bottom</b> (  ):          Sets a higher value (+ direction).</p> <p><b>Note</b></p> <p>Depending on the picture position adjusted with the lens shift feature, the aspect ratio of the picture may change from the original or picture distortion may occur with V Keystone adjustment.</p>
<p><b>Image Flip</b></p>	<p><b>Flips the picture on the screen horizontally and/or vertically.</b>  <b>Off:</b> The picture does not flip.  <b>HV:</b> Flips the picture horizontally and vertically.  <b>H:</b> Flips the picture horizontally.  <b>V:</b> Flips the picture vertically.          Use this item for installation for the backside projection or ceiling installation.</p>
<p><b>Blanking</b></p>	<p><b>This feature allows you to adjust the displayable region within the four directions of the screen.</b>          Select each screen edge “Left / Right / Top / Bottom” on the Blanking adjustment screen with  /  buttons. Adjust the desired Blanking value with  /  button.</p> <div data-bbox="557 1109 828 1268" data-label="Image"> <p>The screenshot shows a "Blanking" menu with four input fields: "Left:" with value "2", "Right:" with value "3", "Top:" with value "2", and "Bottom:" with value "3". Navigation buttons at the bottom are "Set: [F4]", "Adjust: [F5]", and "Set: [F6]".</p> </div> <p><b>Note</b></p> <p>When both the “Blanking” and the “V Keystone” are adjusted at the same time, the “Blanking” cannot be adjusted correctly. When using the “Blanking”, make sure that you set the “V Keystone” to “0”.</p>

**Panel Alignment**

**This feature allows you to adjust the gaps in the color of characters or the picture.**

When set to “On”, the “Adjust Color” and the “Pattern Color” can be assigned and adjusted.

**Adjust Color:** Assigns the desired color to adjust the gaps in color. Select “R” (Red) or “B” (Blue) to make adjustments based on “G” (Green).

**Pattern Color:** Select “R/G” (Red and Green) or “R/G/B” (White, all colors) when the “Adjust Color” is “R” (Red). Select “B/G” (Blue and Green) or “R/G/B” (White, all colors) only when the “Adjust Color” is “B” (Blue).

**Adjust:** Assign the settings of the horizontal direction (H) with ← / → buttons and the vertical direction (V) with ↑ / ↓ buttons on the Shift Adjust screen. The colors selected in the “Adjust Color” can be adjusted with the ← / →, ↑ / ↓ buttons in each direction.

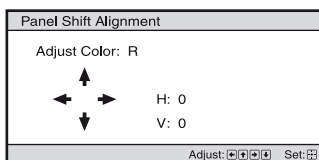

**Reset:** Returns to the factory settings.

**Note**

Depending on the adjustments made above, the number of display pixel may decrease. Also, colors may become uneven or the resolution may change.

**Tip**

If colors appear on the edge of the screen after making the adjustments above, adjust the region of the picture to display with “Blanking” in the Installation  menu. (Ⓞ page 50)

# Information Menu

The Information menu displays the model name, serial number, the horizontal and vertical frequencies of the input signal and the cumulated hours of usage of the lamp.

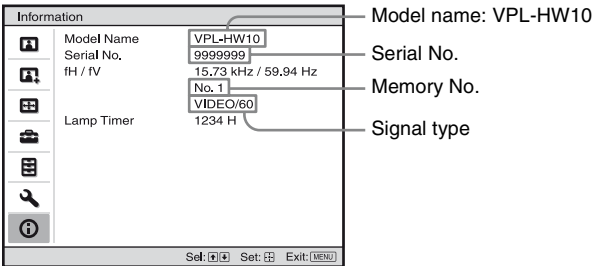



<b>Model name</b>	Displays the model name (VPL-HW10).
<b>Serial No.</b>	Displays the serial number.
<b>fH (horizontal frequency)</b>	Displays the horizontal frequency of the input signal.
<b>fV (vertical frequency)</b>	Displays the vertical frequency of the input signal.
<b>Memory No.</b>	Displays the preset memory number of the input signal.
<b>Signal type</b>	Displays the type of the input signal.
<b>Lamp Timer</b>	Indicates how long the lamp has been turned on (total usage).

## Notes

- fH (horizontal frequency) and fV (vertical frequency) may not be displayed depending on the input signal used on the projector.
- You cannot change the displays listed above.

## About the Preset Memory No.

This projector has 38 types of preset data for input signals (the preset memory). When the preset signal is input, the projector automatically detects the signal type and recalls the data for the signal from the preset memory to adjust it to an optimum picture. The memory number and signal type of that signal are displayed in the Information  menu.

You can also adjust the preset data through the Screen  menu.

This projector also contains 20 different user memories beside the preset memories used for inputting analog computer signals. You can save input signals that have not been preset on these user memories.

When an unpreset signal is input for the first time, a memory number is displayed as 0.

When you adjust the data of the signal in the Screen  menu, it will be registered to the projector. If more than 20 user memories are registered, the newest memory always overwrites the oldest one.

See the chart on page 66 to find if the signal is registered to the preset memory.

### Note

When the aspect ratio of input signal does not match the screen size, a part of the screen is displayed in black.

# Others

This section describes about the other functions, how to solve the problems, how to replace the lamp and air filter, etc.

---

## About the Control for HDMI

### What is the Control for HDMI?

Control for HDMI is an HDMI standard mutual control function which uses the HDMI CEC (Consumer Electronics Control) specification. By connecting a variety of Control for HDMI compatible equipment such as a DVD recorder, an AV amplifier, etc., with an HDMI cable, you can operate your equipment synchronizing with the Control for HDMI compatible equipment connected to the equipment. When using the Control for HDMI function, be sure to assign the appropriate connection and settings.

### Connecting a Control for HDMI compatible equipment

Connect the projector with a Control for HDMI compatible equipment using an HDMI cable. Be sure to use a cable that has acquired the HDMI logo for your connection.

#### Note

The Control for HDMI function is available only between Sony Control for HDMI compatible equipment.

### Setting the Control for HDMI

Be sure to assign the appropriate connections for both the projector and the Control for HDMI compatible equipment connected to the projector. For settings of the projector, see page 49. For settings of the Control for HDMI compatible equipment connected to the projector, refer to its operational instructions.

## What you can do with the Control for HDMI

- **System Standby**  
You can power off the projector and the Control for HDMI compatible equipment connected to the projector at the same time.
- **One Touch Play**  
When the Control for HDMI compatible equipment connected to the projector is played back, the projector is also automatically powered on, and its input setting is synchronized at the same time.

#### Notes

- To operate the connected equipment, be sure the equipment is Control for HDMI compatible and assign the appropriate settings to use the Control for HDMI function.
- Depending on the connected equipment, the Control for HDMI function may not work appropriately. For the settings of the connected equipment, refer to the operating instructions of the equipment.

---

## About the x.v.Color

- “x.v.Color” is a promotion name given to the products that have the capability to realize a wide color space based on the xvYCC specifications and is a trademark of Sony Corporation.
- xvYCC is an international standard of the technical specifications of the extended-gamut color space for video signals. The color gamut of xvYCC is wider than the one of sRGB that is used with the current television system.







# Troubleshooting



If the projector appears to be operating erratically, try to diagnose and correct the problem using the following instructions. If the problem persists, consult with qualified Sony personnel.

## Power

Symptom	Cause and Remedy
The power is not turned on.	<ul style="list-style-type: none"> <li>→ The power may not turn on if you turn the power off with I/⏻ (ON/STANDBY) switch and turn it on again in a short time. After about 1 minute, turn the power on.</li> <li>→ Close the lamp cover securely, then tighten the screws securely. (☞ page 60)</li> <li>→ Close the filter holder securely. (☞ page 61)</li> <li>→ Check warning indicators. (☞ page 57)</li> </ul>

## Picture

Symptom	Cause and Remedy
No picture.	<ul style="list-style-type: none"> <li>→ Check that the proper connections have been made. (☞ page 18)</li> <li>→ Select the input source correctly using the INPUT button. (☞ page 28)</li> <li>→ Set the computer signal to output from an external monitor.</li> <li>→ Set the computer signal to output only to an external monitor.</li> <li>→ Select “Computer,” “Component” or “Video GBR” for “Input-A Signal Sel.” on the Setup  menu according to the input signal. (☞ page 48)</li> </ul>
The picture from the INPUT A connector is colored strange.	<ul style="list-style-type: none"> <li>→ Select “Computer,” “Component” or “Video GBR” for “Input-A Signal Sel.” on the Setup  menu according to the input signal. (☞ page 48)</li> </ul>
The picture from the VIDEO INPUT or S VIDEO INPUT connector is colored strange.	<ul style="list-style-type: none"> <li>→ Adjust the picture of the Picture  menu. (☞ page 41)</li> <li>→ Set “Color System” in the Setup  menu to match the color system being input. (☞ page 48)</li> </ul>
The bright area of the picture may become unclear or texts may become faded. (When HDMI video signal is input)	<ul style="list-style-type: none"> <li>→ This symptom may occur when a signal other than those of HDMI standard is input. (☞ page 29) Switch the RGB dynamic range of the connected equipment to Limited (16-235). If this adjustment is unavailable, adjust “Brightness”, “Contrast”, or “Sharpness” in the Picture  menu of the projector. (☞ page 42)</li> </ul>
The texts may become faded when connected with a computer. (When computer signal is input)	<ul style="list-style-type: none"> <li>→ This symptom may occur when a signal other than those of HDMI standard is input. (☞ page 29) Adjust “Sharpness” in the Picture  menu. (☞ page 42)</li> </ul>

Symptom	Cause and Remedy
The picture is too dark.	→ Adjust the “Contrast” or “Brightness” of the Picture  menu properly. (☞ page 42)
The picture is not clear.	→ Adjust the focus. (☞ page 25) → Condensation has accumulated on the lens. Leave the projector for about 2 hours with the power on.
The picture flickers.	→ For pictures from a computer, activate “APA” and adjust the current input signal. → Adjust “Phase” for “Adjust Signal” in the Screen  menu properly. (☞ page 46)
The color of characters or the picture is not appropriate.	→ Select the desired color registration in “Panel Alignment” of Installation  menu (☞ page 51).

## On-screen display

Symptom	Cause and Remedy
On-screen display does not appear.	→ Set “Status” in the Setup  menu to “On.” (☞ page 47) → Check if the ON/STANDBY indicator should light in green.
The model name does not disappear from the screen.	→ The display mode of the projector may be set at the time of purchase. Consult with your local dealer or qualified Sony personnel.

## Remote control

Symptom	Cause and Remedy
The remote control does not work.	→ Batteries could be weak. Replace them with new batteries. (☞ page 11) → Insert the batteries with the correct polarities. (☞ page 11) → If there is a fluorescent lamp near the remote control detector, the projector may work improperly or inadvertently.

## Others

Symptom	Cause and Remedy
The fan is noisy.	→ Check the setting of “Cooling Setting” in the Setup  menu. (☞ page 47) → Make sure that the room temperature is not too high. → Check the installation conditions. (☞ page 12) The number of fan rotation increases to maintain the product reliability of the projector’s components in a room, where the temperature is higher than normal. The fan noise becomes slightly louder. The approximate normal temperature is 25°C.
Image is left on the screen. (image retention)	→ When High contrast non-moving images are displayed for a long period of time, there may be some image retention on the screen. This is only a temporary condition. Turning off the power for a while will eliminate the retained image.



## Warning Indicators

The ON/STANDBY or LAMP/COVER indicator lights up or flashes if there is any trouble with your projector.

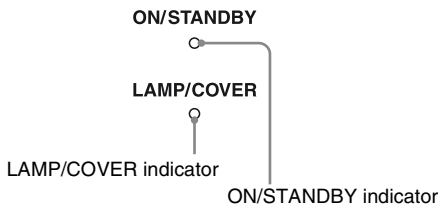

Symptom	Cause and Remedy
LAMP/COVER flashes in red. (A repetition rate of 2 flashes)	<ul style="list-style-type: none"> <li>→ Close the lamp cover securely, then tighten the screws securely. (☞ page 60)</li> <li>→ Close the filter holder securely. (☞ page 61)</li> </ul>
LAMP/COVER flashes in red. (A repetition rate of 3 flashes)	<ul style="list-style-type: none"> <li>→ The lamp has reached the end of its useful lifespan. Replace the lamp. (☞ page 59)</li> <li>→ The lamp has reached a high temperature. Wait until the lamp cools, and then turn on the power again.</li> </ul>
ON/STANDBY flashes in red. (A repetition rate of 4 flashes)	<ul style="list-style-type: none"> <li>→ The fan is broken. Consult with qualified Sony personnel.</li> </ul>
ON/STANDBY flashes in red. (A repetition rate of 2 flashes)	<ul style="list-style-type: none"> <li>→ The internal temperature is unusually high. Check to ensure that if nothing is blocking the ventilation holes or whether or not the projector is being used at high altitudes.</li> </ul>
ON/STANDBY flashes in red. (A repetition rate of 6 flashes)	<ul style="list-style-type: none"> <li>→ Press the I/⏻ (ON/STANDBY) switch to turn on the projector. If the power is not turned on, disconnect the AC power cord, then confirm the ON/STANDBY lamp is turned off. After about 10 seconds, reconnect the AC power cord and turn on the power again. If the indicators still light up, the electrical system has a problem. Consult with qualified Sony personnel.</li> </ul>

### Note

When a warning indicator other than the above starts flashing, and the symptom persists even after carrying out the above methods, consult with qualified Sony personnel.

## Message Lists

### Warning messages

Message	Cause and Remedy
High temp.! Lamp off in 1 min.	<ul style="list-style-type: none"> <li>→ Turn off the power.</li> <li>→ Check to ensure that nothing is blocking the ventilation holes. (☞ page 13)</li> </ul>
Frequency is out of range!	<ul style="list-style-type: none"> <li>→ Frequency is out of range. Input a signal that is within the acceptable frequency range of the projector. (☞ page 66)</li> </ul>
Please check Input-A Signal Sel.	<ul style="list-style-type: none"> <li>→ Set “Input-A Signal Sel.” in the Setup  menu to “Computer” when an RGB signal is input from a computer. (☞ page 48)</li> </ul>
Please replace the Lamp/Filter.	<ul style="list-style-type: none"> <li>→ It is time to replace the lamp. Replace the lamp. (☞ page 59)</li> <li>→ Also, replace the air filter too. Restart cleaning the ventilation holes (intake). (☞ page 59)</li> </ul> <p>If this message appears again after you replace the lamp and filter, the lamp replacement process is not complete. Check the lamp replacement process. (☞ page 59)</p> <p><b>Note</b></p> <p>To clear this message, press any button either on the remote control or the control panel of the projector once.</p>
Please clean the filter.	<ul style="list-style-type: none"> <li>→ It is time to clean the air filter. Clean the air filter. (☞ page 62)</li> </ul> <p><b>Note</b></p> <p>To clear this message, press any button either on the remote control or the control panel of the projector once.</p>
Please clean the filter. Have you finished? Yes No	<ul style="list-style-type: none"> <li>→ It is time to clean the air filter. Clean the air filter. (☞ page 62)</li> <li>→ If you cleaned the air filter, select “Yes.” If you did not clean the air filter, select “No.”</li> </ul>
Projector temperature is high. Cooling Setting should be “High” if projector is being used at high altitude.	<ul style="list-style-type: none"> <li>→ Check to ensure that the ventilation holes on the unit are not covered. (☞ page 13)</li> <li>→ When using the projector at high altitude, set the Cooling Setting to “High”. (☞ page 47)</li> </ul> <p><b>Note</b></p> <p>When temperature inside the projector remains high, the Cooling Setting is switched to “High” in 1 minute, then the fan speed increases.</p>

### Caution messages

Message	Cause and Remedy
x↔	<ul style="list-style-type: none"> <li>→ No signal is input in the selected input. Check connections. (☞ page 18)</li> </ul>
Not applicable!	<ul style="list-style-type: none"> <li>→ Press the appropriate button.</li> <li>→ The operation to be activated by the button is currently prohibited.</li> </ul>

# Replacing the Lamp and the Air Filter and Cleaning the Ventilation Holes (intake)

Tools you need to get started:

- Projector Lamp LMP-H201 (optional)
- Standard Phillips screwdriver
- Cloth (for scratch protection)

The lamp used for the light source has a certain lifespan. When the lamp dims, the color balance of the picture becomes strange, or “Please replace the Lamp/Filter.” appears on the screen, the lamp may be exhausted. Replace the lamp with a new one (not supplied) without delay.

Use an LMP-H201 Projector Lamp as the replacement lamp.

The air filter is supplied with the LMP-H201 Projector Lamp. When you replace the lamp, it is also time to replace the air filter.

Whenever you replace the lamp, be sure to replace the air filter with a new one. Also clean the ventilation holes (intake).

## Caution

- The lamp remains hot after the projector is turned off with the I/⏻ (ON/STANDBY) switch. If you touch the lamp, you may burn your fingers. When you replace the lamp, wait for at least 1 hour for the lamp to cool.
- Do not touch the surface of the lens. If you touch it, wipe off the fingerprints with a soft cloth.
- Pay special attention to replacing the lamp when the projector is installed on the ceiling.
- When removing the lamp unit, make sure it remains horizontal, then pull straight up. Do not tilt the lamp unit. If you pull out the lamp unit while tilted and if the lamp breaks, the pieces may scatter, causing injury.
- When you remove the air filter, be careful not to let any dust fall into the projector.
- Replacing the air filter is crucial to maintain the good performance of the projector or to prevent malfunction to it. When a warning

message for replacing the air filter appears, replace the air filter immediately.

- 1 Turn off the projector and unplug the AC power cord.
- 2 When setting the projector on a flat surface such as a desk etc., put a cloth to prevent the surface from being scratched. Reverse the projector as illustrated, then place it on the cloth.

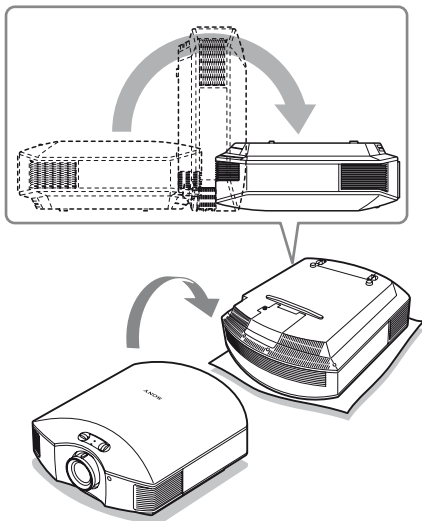

## Notes

- When the lamp is damaged the broken pieces of the lamp may become scattered, if you do not reverse the projector. This may cause injury.
- Be sure that the projector is placed on a stable surface.

- 3** Loosen the screw on the lamp cover with a Philips screwdriver, and then open the lamp cover.

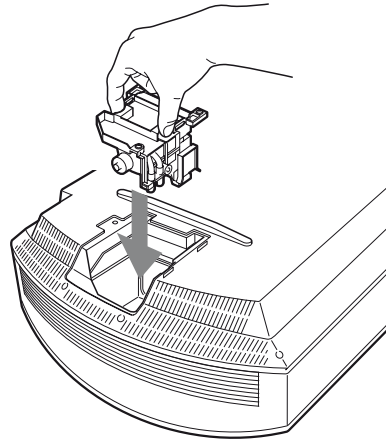
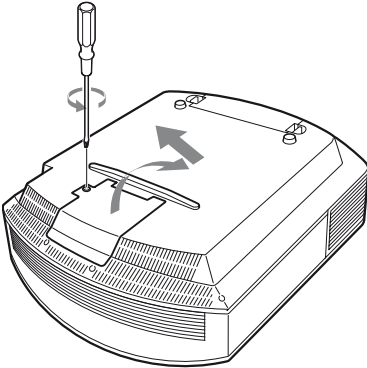

- 4** Loosen the 3 screws on the lamp with the Phillips screwdriver. Hold up the handle, then pull the lamp straight out.

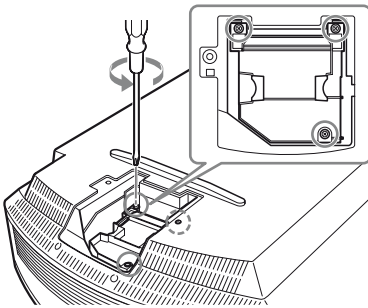

**Note**

Be careful not to touch the optical block inside the unit.

- 6** Close the lamp cover, then tighten the screws.

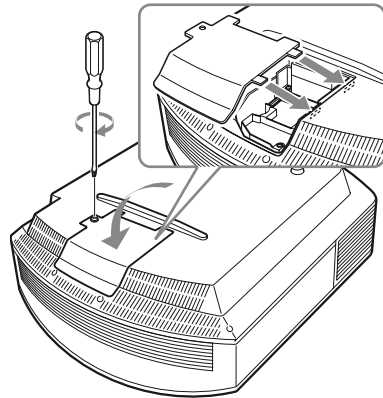

- 5** Hold the handle of the new lamp and push it in securely until it reaches the end, and then tighten the 3 screws.

## 7 Remove the filter holder.

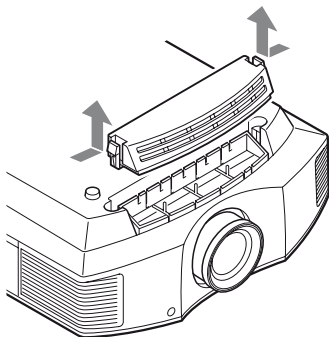

## 8 Remove the air filter.

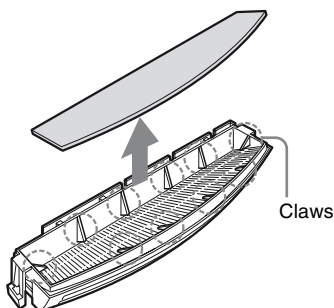

## 9 Attach the new air filter so that it fits into the each claws (10 positions) on the filter holder.

### Note

Attach the air filter aligning it with the shape of the filter holder.  
Also, do not touch the fan after removing the air filter that is set deep inside the projector.

## 10 Attach the filter holder.

### Note

The projector will not turn on unless the filter holder is securely closed.

## 11 Wipe dust off the ventilation holes (intake) with a soft cloth.

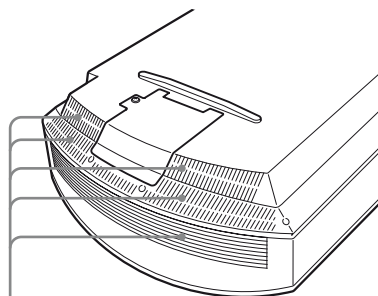

Ventilation holes (intake)

## 12 Place the project back on its original position.

## 13 Turn on the projector, then select the desired setting item on the Setup menu. The menu screen below will be appeared.

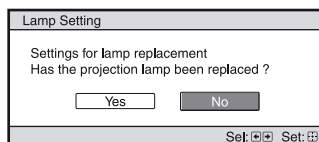

## 14 Select "Yes".

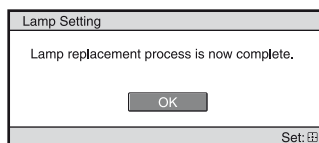

### Caution

Do not put your hands into the lamp replacement slot, and do not allow any liquid or other objects into the slot to avoid electrical shock or fire.

### Notes

- Be sure to use an LMP-H201 Projector Lamp for replacement. If you use lamps other than the LMP-H201, the projector may malfunction.

- Be sure to turn off the projector and unplug the power cord before replacing the lamp, then check the ON/STANDBY lamp has already been turned off.
- The projector will not turn on unless the lamp is securely installed in place.
- The projector will not turn on unless the lamp cover are securely closed.
- To cancel a message displayed on the screen, press either the button on the remote control or the one on the control panel on the projector.

**Note**

The lamp contains mercury. The disposal rules for used fluorescent tubes depend on where you live. Follow the waste disposal policy in your area.

---

## Cleaning the Air Filter

When “Please clean the filter.” appears on the screen, you should clean the air filter. The air filter should be cleaned every 1,500 hours. This value varies depending on the environment or how the projector is used. 1,500 hours are approximate. After washing the air filter with a mild detergent solution, dry it in a shaded place.

**Notes**

- When you clean the air filter, make sure you do not damage it. For details on how to attach and remove the air filter, see “Replacing the Lamp and the Air Filter and Cleaning the Ventilation Holes (intake)” Steps 7 to 10. (Ⓜ page 61)
- When you remove the air filter, be careful not to let any dust fall into the projector.
- Cleaning the air filter is crucial to maintain the good performance of the projector or to prevent malfunction to it. When a warning message for cleaning the air filter appears, clean the air filter immediately.

---

## Fitting the Lens Cap

When fitting the lens cap onto the lens, position the lens cap so that the concave on the side of the lens cap will fit the zoom lever, as shown in the illustration.

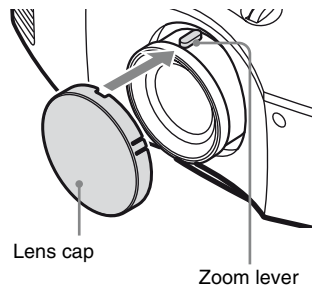

---

# Cleaning and the Screen of the Projector

## Cleaning the lens

The lens surface is especially treated to reduce reflection of light.

As incorrect maintenance may impair the performance of the projector, take care with respect to the following:

- Wipe the lens gently with a soft cloth such as a cleaning cloth or glass cleaning cloth.
- Stubborn stains may be removed with a soft cloth such as a cleaning cloth or glass cleaning cloth lightly dampened with water.
- Never use solvent such as alcohol, benzene or thinner, or acid, alkaline or abrasive detergent, or chemical cleaning cloth, as they will damage the lens surface.

## Cleaning the cabinet

- To remove dust from the cabinet, wipe gently with a soft cloth. If dust is persistent, wipe with a soft cloth slightly moistened with a diluted mild detergent solution.
- Never use any type of abrasive pad, alkaline/acid cleaner, scouring powder, or volatile solvent, such as alcohol, benzene, thinner or insecticide.
- Using such materials or maintaining prolonged contact with rubber or vinyl materials may result in damage to the screen surface and cabinet material.

## Black points and bright points (red, blue, or green) on the screen

The projector is manufactured using high-precision technology.

You may, however, see tiny black points and/or bright points (red, blue, or green) that continuously appear on the projector.

This is a normal result of the manufacturing process and does not indicate a malfunction.

---

# Specifications

---

## System

Projection system	SXRD panel, 1 lens, projection system
LCD panel	0.61-inch (15.4 mm) SXRD panel 6,220,800 pixels (2,073,600 pixels × 3)
Lens	1.6 times zoom lens (manual) f=18.5 mm to 29.6 mm F2.50 to F3.40
Lamp	200 W Ultra High Pressure Lamp
Projection picture size	40 inches to 300 inches (1,016 mm to 7,620 mm) (measured diagonally)
Color system	NTSC <sub>3.58</sub> /PAL/SECAM/ NTSC <sub>4.43</sub> /PAL-M/PAL-N/PAL60 system, switched automatically/ manually (PAL60 system not switched manually)
Acceptable video signals	15 kHz RGB/component 50/60 Hz, Progressive component 50/60 Hz, 480/60i, 576/50i, 480/60p, 576/50p, 720/60p, 720/50p, 1080/60i, 1080/50i, 1080/24PsF (48i), 1080/60p (HDMI input only), 1080/50p (HDMI input only), 1080/24p (HDMI input only), Composite video, Y/C video
Acceptable computer signals	fH: 19 kHz to 72 kHz fV: 48 Hz to 92 Hz Maximum resolution 1920 × 1080 (HDMI input only) For details, see "Preset Signals". (Ⓖ page 66)

---

## Input

Video input	VIDEO: phono type Composite video: 1 V <sub>p</sub> -p±2 dB sync negative (75 ohms terminated) S VIDEO: Y/C mini DIN 4-pin type Y (luminance): 1 V <sub>p</sub> -p±2 dB sync negative (75 ohms terminated) C (chrominance): burst 0.286 V <sub>p</sub> -p ±2 dB (NTSC) (75 ohms terminated), or burst 0.3 V <sub>p</sub> -p±2 dB (PAL) (75 ohms terminated)
-------------	--

## Y PB/CB PR/CR

Component: phono type  
Y with Sync: 1 V<sub>p</sub>-p±2dB sync  
negative (75 ohms terminated)  
PB/CB: 0.7 V<sub>p</sub>-p±2dB (75 ohms  
terminated)  
PR/CR: 0.7 V<sub>p</sub>-p±2 dB (75 ohms  
terminated)

## HDMI

Digital RGB/Y C<sub>B</sub> (P<sub>B</sub>) C<sub>R</sub> (P<sub>R</sub>)

## INPUT A

HD D-sub 15-pins  
Analog RGB/component:  
R/CR (P<sub>R</sub>): 0.7 V<sub>p</sub>-p±2 dB  
(75 ohms terminated)  
G: 0.7 V<sub>p</sub>-p±2 dB  
(75 ohms terminated)  
G with sync/Y: 1 V<sub>p</sub>-p±2 dB sync  
negative (75 ohms terminated)  
B/C<sub>B</sub> (P<sub>B</sub>): 0.7 V<sub>p</sub>-p±2 dB  
(75 ohms terminated)  
SYNC/HD: Composite sync input:  
TTL level, positive/negative  
Horizontal sync input: TTL level,  
positive/negative  
VD: Vertical sync input: TTL  
level, positive/negative

## REMOTE

RS-232C: D-sub 9-pins (female)

---

## General

### Dimensions

407.4 mm × 179.2 mm ×  
463.9 mm (16 <sup>1</sup>/<sub>8</sub> × 7 <sup>1</sup>/<sub>8</sub> × 18 <sup>3</sup>/<sub>8</sub>  
inches) (w/h/d)

Mass Approx. 10 kg (22 lb 1 oz)

### Power requirements

AC 100 V to 240 V, 3.0 A to 1.3 A,  
50/60 Hz

### Power consumption

Max. 300 W  
Standby mode: 8 W  
Standby mode (low): 0.5 W

### Operating temperature

5°C to 35°C (41°F to 95°F)

### Operating humidity

35% to 85% (no condensation)

### Storage temperature

-20°C to +60°C (-4°F to +140°F)

### Storage humidity

10% to 90%



---

## Supplied accessories

- Remote control RM-PJAW15 (1)
- Size AA (R6) batteries (2)
- AC power cord (1)
- Lens cap (1)
- Operating Instructions (1)

Design and specifications are subject to change without notice.

## Optional accessories

- Projector Lamp LMP-H201 (for replacement)
- Projector Suspension Support PSS-H10

## Warning on power connection

Use a proper power cord for your local power supply.

	The United States, Canada	Continental Europe	UK, Ireland, Australia, New Zealand	Japan	China
Plug type	YP-3	YP-12A	*	YP-359	VM0722
Female end	YC-13	YC-13D	VM0303B	YC-13	VM0724
Cord type	SVT	H05VV-F	CEE (13) 53 rd (OC)	VCTF	227 IEC 53(RVV)
Rated Voltage & Current	10A/125V	10A/250V	10A/250V	12A/125V	10A/250V
Safety approval	UL/CSA	VDE	VDE	DENANHO	CCC

\* Use a rated plug that complies with the regulation of each country/region and the specifications.

## Preset Signals

The following table shows the signals and video formats which you can project using this unit.

When a signal other than the preset signal shown below is input, the picture may not be displayed properly.

Memory No.	Preset signal (resolution)		fH (kHz)	fV (Hz)	Sync	H Size
1	VIDEO/60	60 Hz	15.734	59.940	–	–
2	VIDEO/50	50 Hz	15.625	50.000	–	–
3	480/60i	480/60i (720 × 480i)	15.734	59.940	SonG/Y or composite sync	–
4	576/50i	576/50i (720 × 576i)	15.625	50.000	SonG/Y or composite sync /composite video	–
5	480/60p	480/60p (Progressive NTSC) (720 × 480p)	31.470	60.000	SonG/Y	–
6	576/50p	576/50p (Progressive PAL) (720 × 576p)	31.250	50.000	SonG/Y	–
7	1080/60i	1035/60i (1920 × 1035i) 1080/60i (1920 × 1080i)	33.750	60.000	SonG/Y	–
8	1080/50i	1080/50i (1920 × 1080i)	28.130	50.000	SonG/Y	–

Memory No.	Preset signal (resolution)		fH (kHz)	fV (Hz)	Sync	H Size
9	1080/24PsF (48i)	1080/24PsF (48i) (1920 × 1080i)	27.000	48.000	SonG/Y	–
10	720/60p	720/60p (1280 × 720p)	45.000	60.000	SonG/Y	–
11	720/50p	720/50p (1280 × 720p)	37.500	50.000	SonG/Y	–
12	1080/60p	1080/60p (1920 × 1080p)	67.500	60.000	–	–
13	1080/50p	1080/50p (1920 × 1080p)	56.260	50.000	–	–
14	1080/24p	1080/24p (1920 × 1080p)	26.973	23.976	–	–
21	640 × 350	VGA-1 (VGA350)	31.469	70.086	H-pos, V-neg	800
22		VESA 85 (VGA350)	37.861	85.080	H-pos, V-neg	832
23	640 × 400	NEC PC98	24.823	56.416	H-neg V-neg	848
24		VGA-2 (TEXT) /VESA70	31.469	70.086	H-neg V-pos	800
25		VESA 85 (VGA400)	37.861	85.080	H-neg, V-pos	832
26	640 × 480	VESA 60	31.469	59.940	H-neg, V-neg	800
27		Mac 13	35.000	66.667	H-neg, V-neg	864
28		VESA 72	37.861	72.809	H-neg, V-neg	832
29		VESA 75 (IBM M3)	37.500	75.000	H-neg, V-neg	840
30		VESA 85 (IBM M4)	43.269	85.008	H-neg, V-neg	832
31	800 × 600	VESA 56	35.156	56.250	H-pos, V-pos	1024
32		VESA 60	37.879	60.317	H-pos, V-pos	1056
33		VESA 72	48.077	72.188	H-pos, V-pos	1040
34		VESA 75 (IBM M5)	46.875	75.000	H-pos, V-pos	1056
35		VESA 85	53.674	85.061	H-pos, V-pos	1048
36	832 × 624	Mac 16	49.724	74.550	H-neg, V-neg	1152
37	1024 × 768	VESA 60	48.363	60.004	H-neg, V-neg	1344
38		VESA 70	56.476	70.069	H-neg, V-neg	1328
39		VESA 75	60.023	75.029	H-pos, V-pos	1312
45	1280 × 960	VESA 60	60.000	60.000	H-pos, V-pos	1800

Memory No.	Preset signal (resolution)		fH (kHz)	fV (Hz)	Sync	H Size
47	1280 × 1024	VESA 60	63.974	60.013	H-pos, V-pos	1696
50	1400 × 1050	SXGA +	65.317	59.978	H-neg, V-pos	1864
55	1280 × 768	1280 × 768/60	47.776	59.870	H-neg, V-pos	1664
56	1280 × 720	1280 × 720/60	44.772	59.855	H-neg, V-pos	1664

## Preset memory numbers for each input signal

### Analog signal

Signal	Preset memory number
Video signal (VIDEO INPUT and S VIDEO INPUT connectors)	1, 2
Component signal (INPUT A and Y Pb/Cb Pr/ Cr connectors)	3 to 11
Video GBR signal (INPUT A connector)	3 to 11
Computer signal (INPUT A connector)	21 to 39, 55 to 56

### Digital signal

Signal	Preset memory number
Component signal (HDMI 1, 2 connectors)	3 to 8, 10 to 14
Video GBR signal (HDMI 1, 2 connectors)	3 to 8, 10 to 14
Computer signal (HDMI 1, 2 connectors)	10 to 13*, 26, 32, 36, 37, 45, 47, 50, 55

\* Some digital signals input from computers may be displayed as preset memory number of Component or Video GBR signal.

## Input Signals and Adjustable/Setting Items

The items in the menus available to adjust differ depending on the input signal. The following tables indicate them.

The items that cannot be adjusted are not displayed in the menu.

### Picture Menu

Item	Input signal			
	Video signal	Component signal	Video GBR signal	Computer signal
Advanced Iris	●	●	●	●
Lamp Control	●	●	●	●
Contrast	●	●	●	●
Brightness	●	●	●	●
Color	● (except for B & W)	●	●	—
Hue	● (NTSC <sub>3.58</sub> / NTSC <sub>4.43</sub> only, except for B & W)	●	●	—
Color Temp.	●	●	●	●
Sharpness	●	●	●	—
NR	●	● (preset memory numbers 3, 4, 7, 8, 9 only)	● (preset memory numbers 3, 4, 7, 8, 9 only)	—
MPEG NR	●	●	●	●
Film Mode	●	● (preset memory numbers 3, 4, 7, 8, 9 only)	● (preset memory numbers 3, 4, 7, 8, 9 only)	—
Black Level Adj.* <sup>1</sup>	●	●	●	—
Gamma Correction * <sup>1</sup>	●	●	●	●
x.v.Color	●	●	—	—
Color Space	●	●	●	●
RCP	●	●	●	●

● : Adjustable/can be set

— : Not adjustable/cannot be set

## Screen menu

Item	Input signal			
	Video signal	Component signal	Video GBR signal	Computer signal
Wide Mode	●	●	●	● * <sup>3</sup>
Over Scan	–	●	●	–
Screen Area * <sup>2</sup>	–	● (preset memory numbers 7, 8, 9, 12, 13, 14 only)	● (preset memory numbers 7, 8, 9, 12, 13, 14 only)	–
V Center * <sup>4</sup>	●	●	●	●
Vertical Size * <sup>4</sup>	●	●	●	–
APA	–	–	–	● * <sup>5</sup>
Phase	–	–	–	● * <sup>5</sup>
Pitch	–	–	–	● * <sup>5</sup>
Shift	–	● * <sup>5</sup>	● * <sup>5</sup>	●

● : Adjustable/can be set

– : Not adjustable/cannot be set

\*<sup>1</sup>: The setting can be made only when “x.v.Color” is set to “Off”.



\*<sup>2</sup>: The setting can be made only when “Over Scan” is set to “On” and “Wide Mode” is set to “Full” in the Screen  menu.

\*<sup>3</sup>: If the input signal is from a computer, the setting cannot be made when the aspect ratio is 16:9 or wider.

\*<sup>4</sup>: The setting can be made only when “Zoom” is selected in “Wide Mode”.

\*<sup>5</sup>: The setting can be made only for analog signal.

### Note

When connecting a cable such as an HDMI cable, etc., check the type of the signal in the Information  menu ( page 52) and Digital signal ( page 68), and check items that are adjustable/can be set.

# Ceiling Installation

Use the PSS-H10 Projector Suspension Support when you install the projector on a ceiling. The projection distances for ceiling installation are shown below.

- L': Distance between the screen and the installation hole at the ceiling side of the ceiling mount unit (front side)
- y': Distance between the ceiling and the center of the screen such that the picture will not be truncated or blocked

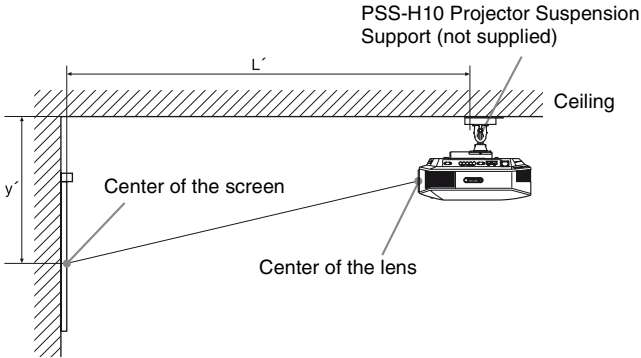

### When using the 16:9 aspect ratio screen size

Screen Size SS (inches)		40	60	80	100	120	150	200	250	300
(mm)		1016	1524	2032	2540	3048	3810	5080	6350	7620
L'	(minimum)	1385 (54 <sup>17</sup> / <sub>32</sub> )	2008 (79 <sup>1</sup> / <sub>16</sub> )	2632 (103 <sup>5</sup> / <sub>8</sub> )	3256 (128 <sup>5</sup> / <sub>32</sub> )	3879 (152 <sup>23</sup> / <sub>32</sub> )	4814 (189 <sup>17</sup> / <sub>32</sub> )	6373 (250 <sup>29</sup> / <sub>32</sub> )	7932 (312 <sup>9</sup> / <sub>32</sub> )	9491 (373 <sup>21</sup> / <sub>32</sub> )
	(maximum)	2013 (79 <sup>9</sup> / <sub>32</sub> )	2955 (116 <sup>5</sup> / <sub>16</sub> )	3896 (153 <sup>3</sup> / <sub>8</sub> )	4837 (190 <sup>7</sup> / <sub>16</sub> )	5779 (227 <sup>1</sup> / <sub>2</sub> )	7190 (283 <sup>3</sup> / <sub>32</sub> )	9544 (375 <sup>3</sup> / <sub>4</sub> )	11897 (468 <sup>3</sup> / <sub>8</sub> )	14250 (561 <sup>1</sup> / <sub>32</sub> )
y'	(minimum)	249 (9 <sup>7</sup> / <sub>8</sub> )	374 (14 <sup>3</sup> / <sub>4</sub> )	498 (19 <sup>5</sup> / <sub>8</sub> )	623 (24 <sup>5</sup> / <sub>8</sub> )	747 (29 <sup>1</sup> / <sub>2</sub> )	934 (36 <sup>7</sup> / <sub>8</sub> )	1245 (49 <sup>1</sup> / <sub>8</sub> )	1557 (61 <sup>3</sup> / <sub>8</sub> )	1868 (73 <sup>5</sup> / <sub>8</sub> )
	(maximum)	592 (23 <sup>3</sup> / <sub>8</sub> )	754 (29 <sup>3</sup> / <sub>4</sub> )	916 (36 <sup>1</sup> / <sub>8</sub> )	1078 (42 <sup>1</sup> / <sub>2</sub> )	1240 (48 <sup>7</sup> / <sub>8</sub> )	1483 (58 <sup>1</sup> / <sub>2</sub> )	1887 (74 <sup>3</sup> / <sub>8</sub> )	2292 (90 <sup>1</sup> / <sub>4</sub> )	2697 (106 <sup>1</sup> / <sub>4</sub> )

Unit: mm (inches)

To calculate the installation positions

$$L' \text{ (minimum)} = 31.1781 (1 \frac{7}{32}) \times SS + 137.7 (5 \frac{13}{32})$$

$$L' \text{ (maximum)} = 47.0644 (1 \frac{27}{32}) \times SS + 130.8 (5 \frac{5}{32})$$

$$y' \text{ (minimum)} = 6.2263 (1 \frac{1}{4}) \times SS$$

$$y' \text{ (maximum)} = 8.0942 (5 \frac{1}{16}) \times SS + 268.5 (10 \frac{9}{16})$$

### When using the 4:3 aspect ratio screen size

Screen Size SS (inches)		40	60	80	100	120	150	200	250	300
(mm)		1016	1524	2032	2540	3048	3810	5080	6350	7620
L'	(minimum)	1664 (65 <sup>1</sup> / <sub>2</sub> )	2427 (95 <sup>9</sup> / <sub>16</sub> )	3190 (125 <sup>19</sup> / <sub>32</sub> )	3953 (155 <sup>21</sup> / <sub>32</sub> )	4717 (185 <sup>11</sup> / <sub>16</sub> )	5861 (230 <sup>3</sup> / <sub>4</sub> )	7769 (305 <sup>7</sup> / <sub>8</sub> )	9677 (380 <sup>31</sup> / <sub>32</sub> )	11585 (456 <sup>3</sup> / <sub>32</sub> )
	(maximum)	2435 (95 <sup>27</sup> / <sub>32</sub> )	3587 (141 <sup>7</sup> / <sub>32</sub> )	4739 (186 <sup>9</sup> / <sub>16</sub> )	5891 (231 <sup>29</sup> / <sub>32</sub> )	7043 (277 <sup>9</sup> / <sub>32</sub> )	8771 (345 <sup>5</sup> / <sub>16</sub> )	11651 (458 <sup>11</sup> / <sub>16</sub> )	14531 (572 <sup>1</sup> / <sub>16</sub> )	17411 (685 <sup>15</sup> / <sub>32</sub> )
y'	(minimum)	305 (12 <sup>1</sup> / <sub>8</sub> )	457 (18)	610 (24 <sup>1</sup> / <sub>8</sub> )	762 (30)	914 (36)	1143 (45)	1524 (60)	1905 (75)	2286 (90)
	(maximum)	665 (26 <sup>1</sup> / <sub>4</sub> )	863 (34)	1061 (41 <sup>7</sup> / <sub>8</sub> )	1259 (49 <sup>5</sup> / <sub>8</sub> )	1457 (57 <sup>3</sup> / <sub>8</sub> )	1754 (69 <sup>1</sup> / <sub>8</sub> )	2250 (88 <sup>5</sup> / <sub>8</sub> )	2745 (108 <sup>1</sup> / <sub>8</sub> )	3240 (127 <sup>5</sup> / <sub>8</sub> )

Unit: mm (inches)

To calculate the installation positions

$$L' \text{ (minimum)} = 38.1569 (1 \frac{1}{2}) \times SS + 137.7 (5 \frac{13}{32})$$

$$L' \text{ (maximum)} = 57.5992 (2 \frac{9}{32}) \times SS + 130.8 (5 \frac{5}{32})$$

$$y' \text{ (minimum)} = 7.62 (5 \frac{1}{16}) \times SS$$

$$y' \text{ (maximum)} = 9.906 (3 \frac{3}{8}) \times SS + 268.5 (10 \frac{9}{16})$$



## Attaching the PSS-H10 projector suspension support

For details on installation on a ceiling, refer to the Installation manual for Dealers of the PSS-H10. Make sure to consult with a qualified Sony personnel for installation.

The installation measurements are shown below when installing the projector on a ceiling using the PSS-H10.

### Top view

Install the projector so that the center of the lens is parallel to the center of the screen.

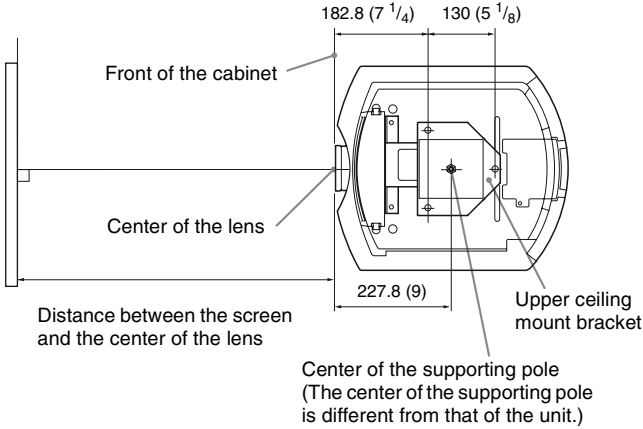

### Front view

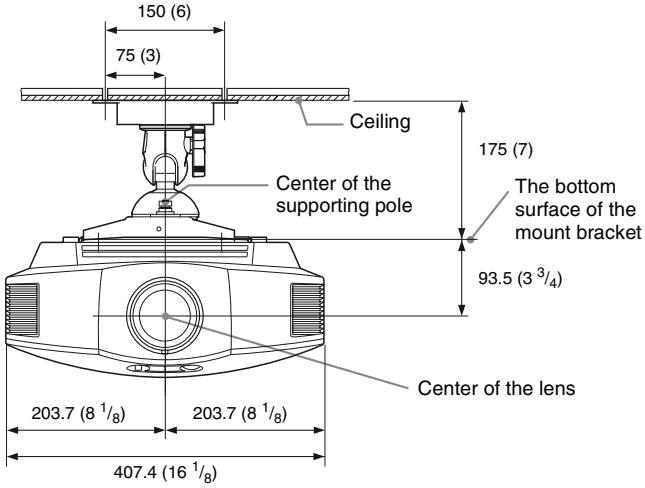

### Side view

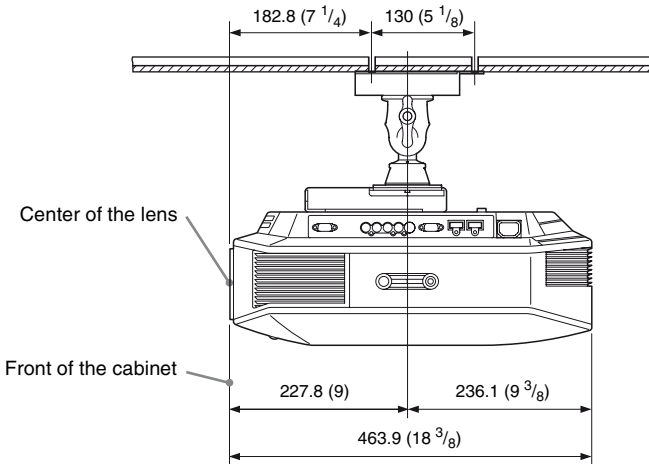

# Index

## A

Adjust Signal	
APA .....	46
Phase .....	46
Pitch .....	46
Shift .....	46
Adjuster .....	25
Adjusting	
picture position .....	22
picture quality .....	33
Advanced Iris .....	42
APA .....	36, 46
Auto Input Search .....	49

## B

Background .....	49
Black Level Adj. ....	43
Blanking .....	50
Brightness .....	42

## C

Ceiling Installation .....	71
Cinema Black Pro .....	42
Color Space .....	43
Color System .....	48
Color Temp. ....	42
Connecting	
Computer .....	21
Video equipment .....	18
Contrast .....	42
Control for HDMI .....	49
Cooling Setting .....	47

## E

Expert Setting .....	43
----------------------	----

## F

fH .....	52
FREEZE .....	36
fV .....	52

## G

Gamma Correction .....	43
------------------------	----

## H

HDMI .....	19
Hue .....	42

## I

Image Flip .....	50
Input-A Signal Sel. ....	48

## L

Lamp Control .....	42
Lamp Timer .....	52
Language .....	47
Location of Controls	
Front/Right side .....	8
Rear/Bottom .....	9

## M

Menu	
Advanced Picture .....	44
Function .....	49
Information .....	52
Installation .....	50
Picture .....	41
Screen .....	45
Setup .....	47
Messages	
Caution .....	58
Warning .....	58
MPEG NR .....	43

## N

NR .....	43
----------	----

## O

Over Scan .....	46
-----------------	----

## P

Panel Alignment .....	51
PIC MUTING .....	36
Picture Mode	
CINEMA .....	32
Cinema .....	41
DYNAMIC .....	32
Dynamic .....	41
STANDARD .....	32
Standard .....	41
USER .....	32
User .....	41
Precautions .....	7

Preset Memory .....	53
Preset Signals .....	66

## **R**

RCP .....	44
Remote control	
inserting the batteries .....	11
location of controls .....	10
Reset	
resettable items .....	40
resetting the items .....	40

## **S**

Screen Area .....	46
Selecting the menu language .....	26
Sharpness .....	42
Specifications .....	64
Standby Mode .....	47
Status .....	47
Supplied accessories .....	11

## **T**

Troubleshooting .....	55
-----------------------	----

## **V**

V Keystone .....	50
------------------	----

## **W**

WIDE MODE .....	30
Wide Mode	
Full .....	45
Full 1 .....	45
Full 2 .....	45
Normal .....	45
Wide Zoom .....	45
Zoom .....	45

## **X**

x.v.Color .....	43, 54
-----------------	--------









<http://www.sony.net/>



Printed on 70% or more recycled paper.

Sony Corporation Printed in Japan