

**HIGH BRIGHTNESS BUSINESS PROJECTOR
EB- L25000U**

EPSON
EXCEED YOUR VISION

**SPELLBINDING PROJECTIONS AS TRUE
TO LIFE AS NATURE'S GREATEST SHOW.**



Presenting the world's first-ever¹ 25,000-lumen 3LCD projector with 4K quality lens. The Epson EB-L25000U delivers spectacular image quality with outstanding levels of colour brightness, perfect for outdoor and large venues. Extremely reliable with superior heat resistance and 20,000 hours of maintenance-free use². Immensely flexible with 360° rotation, adjustable tilt and large variety of lenses to suit any venue or application. Get ready to shine!

¹ As at Aug 2016

² Approximate time until brightness decreases 50% from first usage. Measured by acceleration test assuming use of 0.04 - 0.20 mg/m³ of particulate matter. Time varies depending on usage conditions and environments.



ENGINEERED FOR BUSINESS

Brightest Show

Breathtaking projections of the most spectacular colours.

Next Level Quality



WUXGA – Beyond Full HD Resolution

With WUXGA resolution (1,920 x 1,200 pixels), you enjoy a sharp, clear display of Full HD video (1,920 x 1,080 pixels) images down to the smallest details even on large-screen projections for an incredible dynamic viewing experience.



Well-balanced Whites

The laser light source produces nicely balanced RGB colour for brilliant white highlights that bring a refreshing vibrancy to your images.

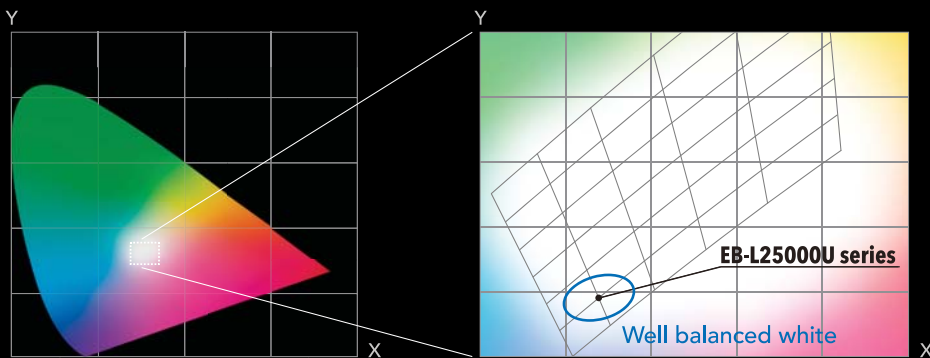

Cleaner Highlights

Epson's advanced optical engine splits white light into blue and yellow beams and precisely adjusts and recombines them to create appealing whites.

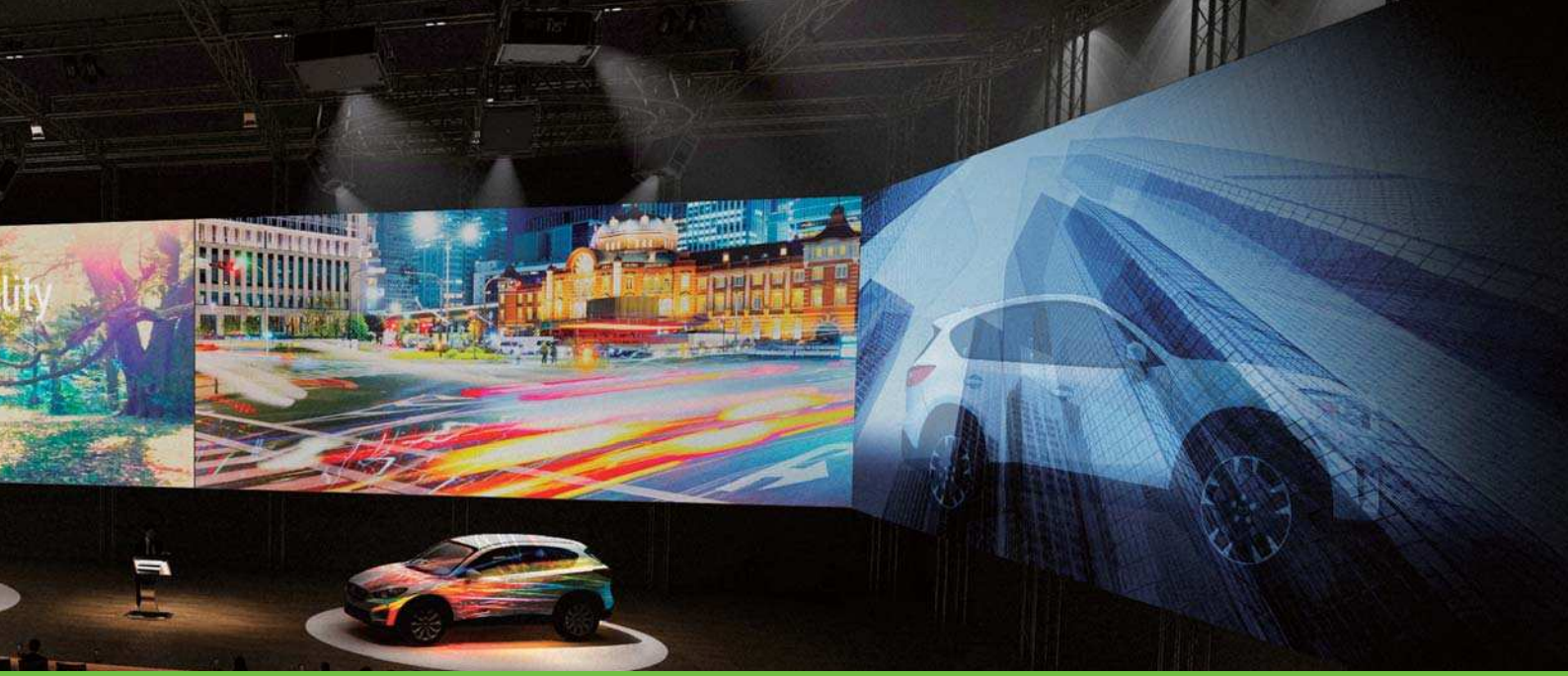

High-definition Images with 4K Lens and Enhancement Technology

4K enhancement technology shifts each pixel diagonally by 0.5 pixels to double the resolution to 3840 x 2160, surpassing full HD image quality to give you unbelievable sharpness, clarity and detail on all your presentations.

By reengineering the internal structure, colour bleeding is kept to an absolute minimum to deliver 4K resolution throughout the entire zoom range.

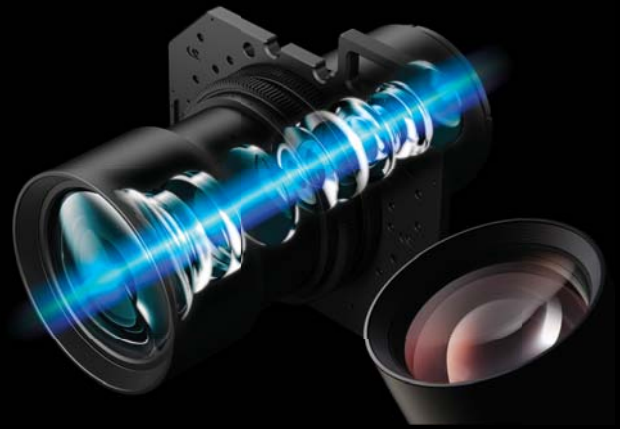
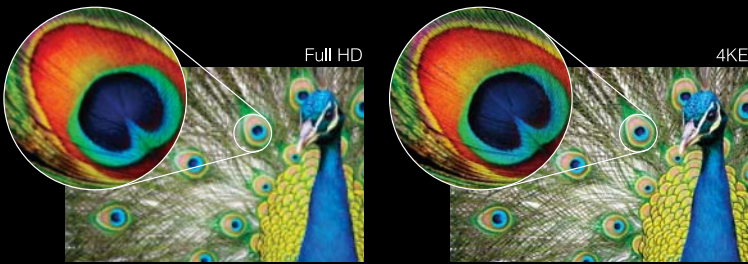
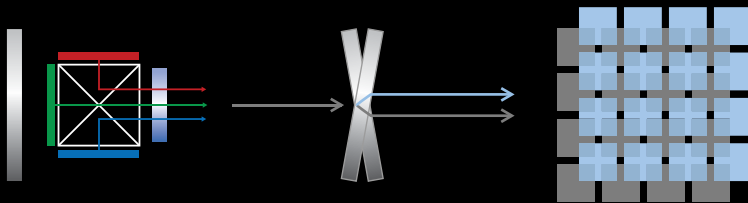

High Contrast Ratio

Enjoy richer contrast with Epson's newly-developed laser optical engine system. And combined together with the vibrant and realistic colours from the 3LCD panels, you enjoy more lifelike projections.

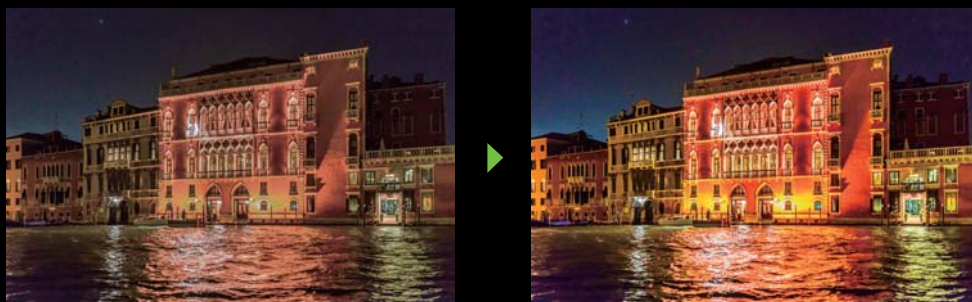

Brightest Show

Breathtaking projections of the most spectacular colours.

Absolute Black

Laser technology dims the light source in real time according to the input video signal to deliver absolute black during full-black screens.



Frame Interpolation

Enjoy clearer, sharper playback even on fast-moving subjects with Epson's Frame Interpolation Technology. This unique function effectively eliminates motion blurring by inserting intermediate frames between images to create smoother motion transition.

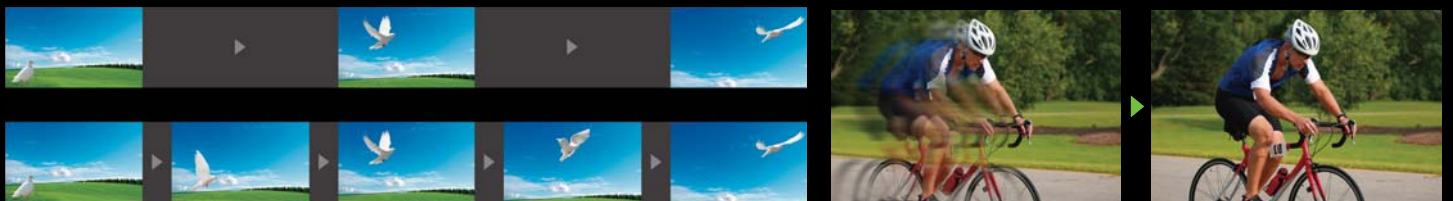

Super Resolution with Detail Enhancement

Improve perceived image resolution with the "super resolution" technology. And with Epson's "detail enhancement", you enjoy rich textures for further enhancement in image quality, allowing you to select your preferred image characteristics for different scenes and content.



Without Super-resolution technology

With Super-resolution technology

* Simulated images

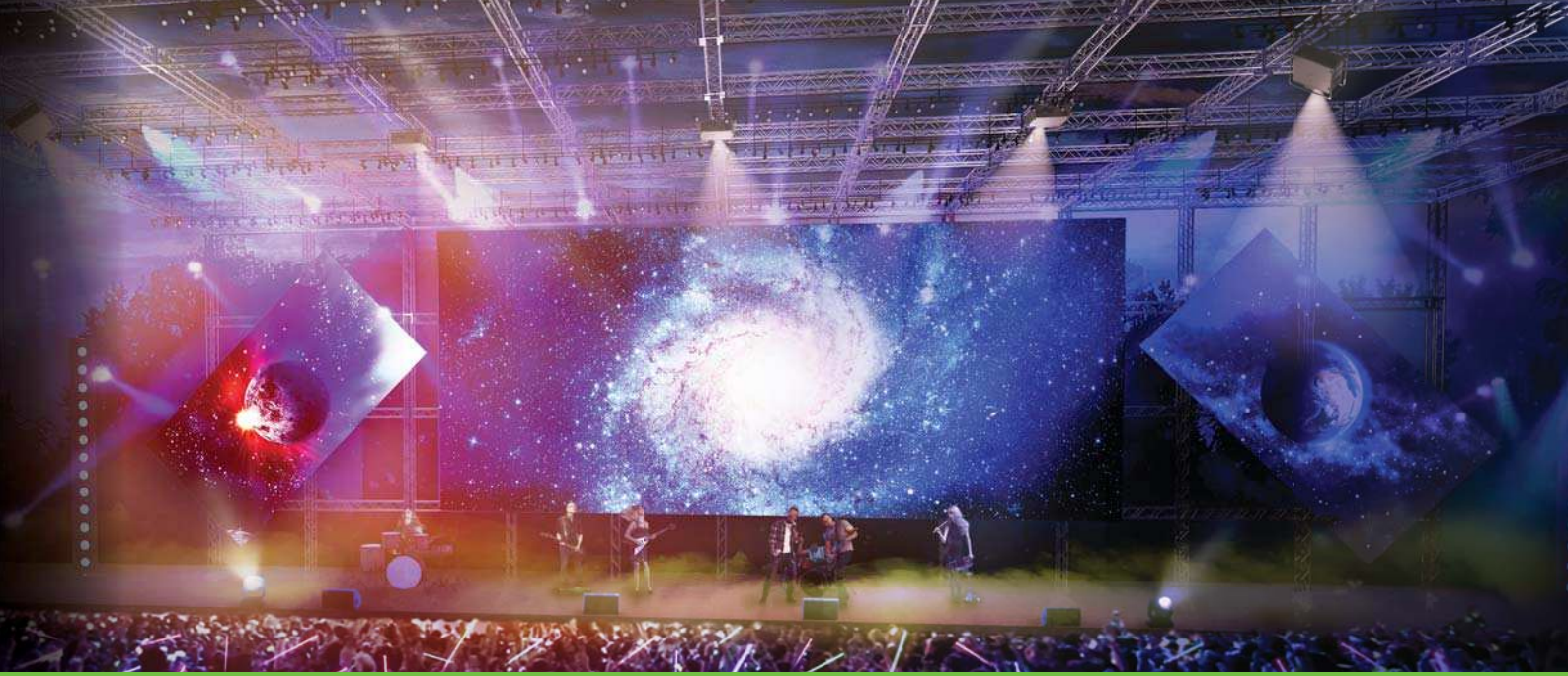

Advanced Colour Adjustment

With the colour adjustment function, you can easily adjust the hue, saturation and brightness for each component of RGBCMY to match your preferences.

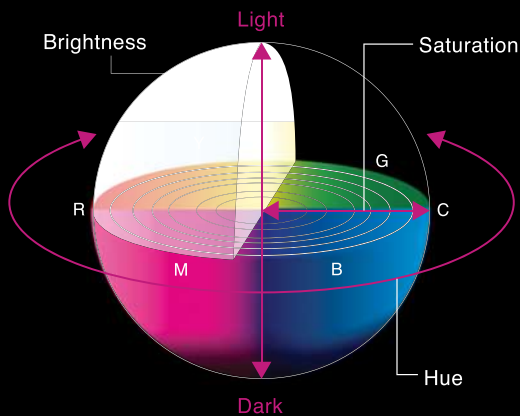

Fine-tuning Brightness

The EB-L2500U provides precise brightness adjustment in increments of 1%. This combined with the Constant Brightness mode maintains brightness at a given value to match the venue or subject to deliver astonishing picture quality.

Custom mode with constant brightness

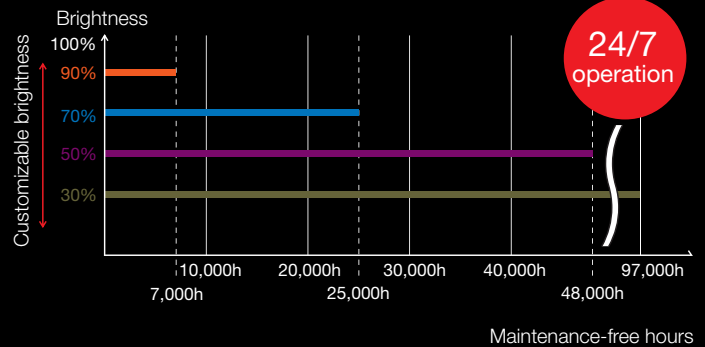

Auto Colour Adjustment

The built-in camera detects screens that have become unevenly coloured over time, allowing the projector to automatically correct colour. It also detects subtle colour inconsistencies between multiple projectors. This function can be programmed to check colour manually or automatically at regular intervals to deliver stable image quality with minimum maintenance.

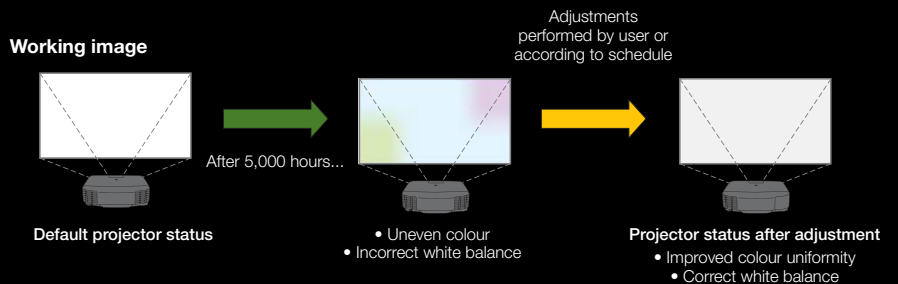

Working image when using multiple projectors

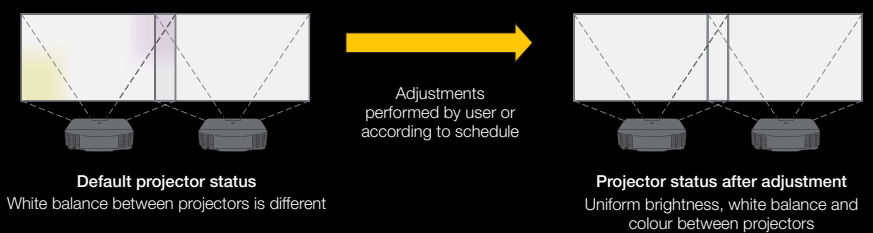

Built-in camera

Reliable Performance

Long-lasting projections that go on and on.

Revolutionary Laser Light Source



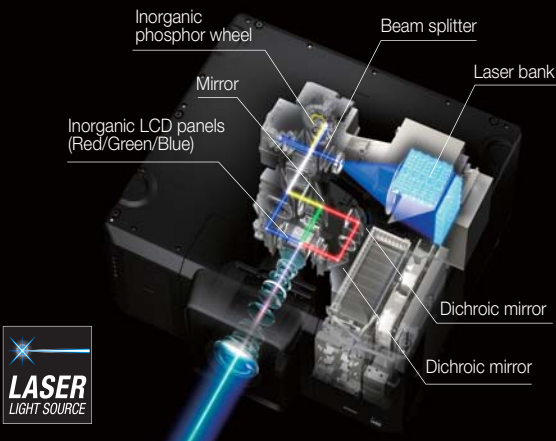

Blue light from the laser is projected through a beam splitter, which divides the light into two beams. One beam passes through a phosphor wheel, turning it yellow, while the other beam remains blue. The two beams are then recombined into white light and separated into red, green and blue through dichroic mirrors. Each of the three colours passes through LCD panels, producing three individual images, which are transmitted through a prism and combined into the final full-colour image.



Inorganic LCD Panels and Phosphor Wheel for Outstanding Reliability

Made of inorganic material, Epson's newly developed phosphor wheel offers superior light and heat resistance to deliver excellent reliability. By combining this with our inorganic LCD panels, we create laser projectors that project bright, vibrant images for extremely long periods.

Organic vs. Inorganic

	Inorganic (Glass, iron, aluminum, etc.)	Organic (Paper, wood, plastic, etc.)
☀️ Light-resistance	YES 	NO 
🔥 Heat-resistance	YES 	NO 

Unlike organic substances, inorganic substances do not contain carbon.

20,000 Hours of Maintenance-free Use

Engineered with inorganic LCD panels and an inorganic phosphor wheel, this newly designed laser light source delivers 20,000 hours* of maintenance-free use. And with the advanced electrostatic filter having an equally long-lasting life, you enjoy peace of mind in using this highly reliable laser projector.

Maintenance period of laser and lamp

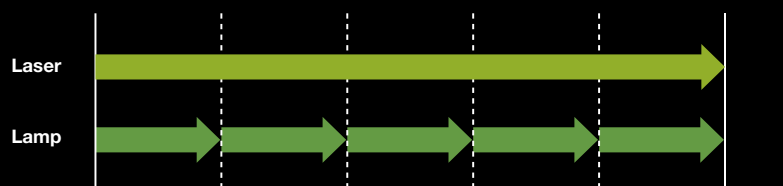

* Approximate time until brightness decreases 50% from first usage. Measured by acceleration test assuming use of 0.04 - 0.20 mg/m³ of particulate matter. Time varies depending on usage conditions and environments.



Fully Sealed Optical Engine

Key optical components including the inorganic panel, inorganic phosphor wheel and laser bank are housed in a sealed structure to prevent external dust contamination. This means brightness deterioration due to dust is significantly reduced so you can use your projector with confidence even in a smoky environment.

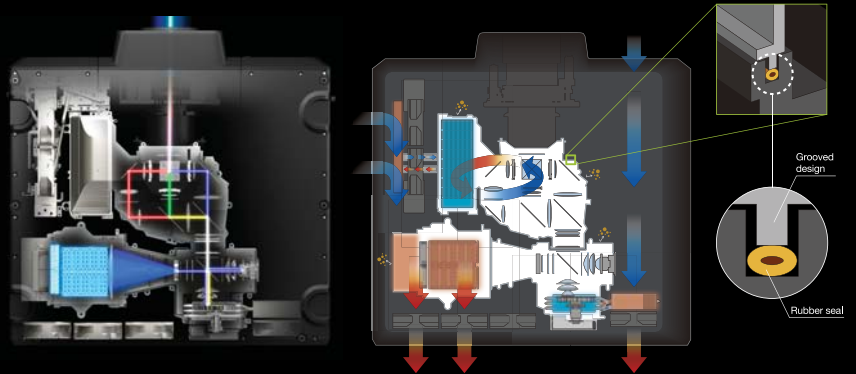

Worry-free Projection

With multiple laser diodes to rely on, the screen won't go black even if one diode goes out. This eliminates the worry of the projector light burning out during mission-critical presentations.

Laser



The projector keeps working even when one light diode goes out.

Lamp

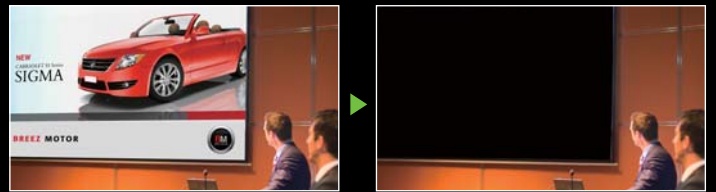

The screen goes black when the lamp burns out.

Durable and Compact Body

By redesigning the internal structure and adopting a pipe frame and baseplate structure, the durability of the casing is greatly improved to deliver a compact, lightweight design for easy installation.



Status Monitor

The projector body is equipped with an LCD monitor, allowing you to quickly check signal, voltage and network information.



Power Supply Log

Monitor and log up to 30 drops in voltage for a detailed record and prevent unexpected shutdowns.

Shine Everywhere

Limitless placement possibilities at any venue for spectacular projections that wow.

Powered Lens with Stepping Motor

The powered lens with stepping motor offers limitless possibilities in projector placement. Covering a wide range of angles, the motorised lens shift gives you a great deal of flexibility when installing the projector. The newly adopted stepping motor lets you make highly precise adjustments when employing edge blending, stacking and other techniques. Adjustments can also be made via remote control or over a network, enhancing usability even for ceiling-mounted projectors.

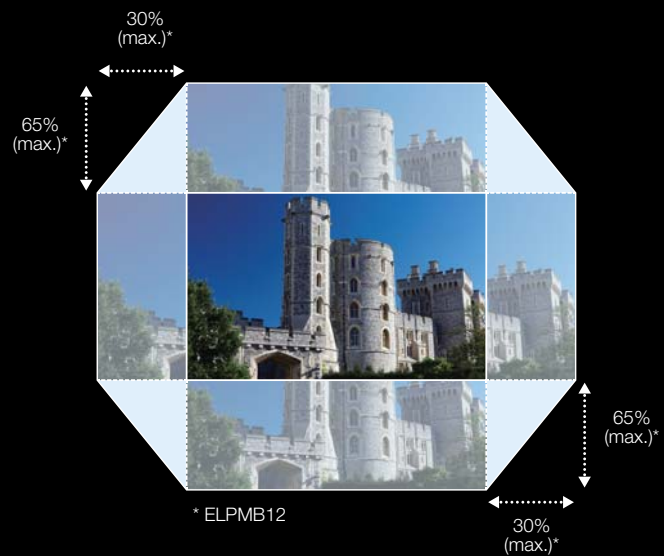

Lens Position Memory

With storage for up to 10 settings in the projector memory, including shift positions, focus and projection sizes, you can easily and quickly adjust the projector according to the aspect ratio of content simply by using either the remote controller or command control.

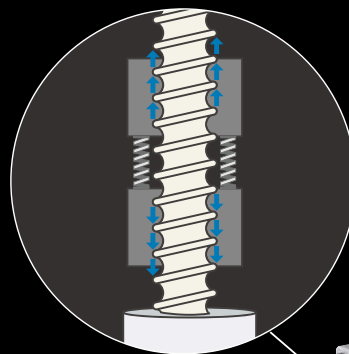

Wider Lens Shift Range

The extremely wide-ranging lens shift was realised through a change in design and careful consideration of the lens and optical engine. Coupled with an improved stepping motor, the range shift mechanism allows more precise adjustment for limitless possibilities in projector placement.

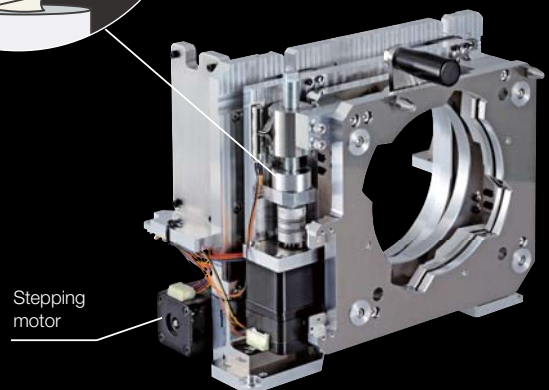

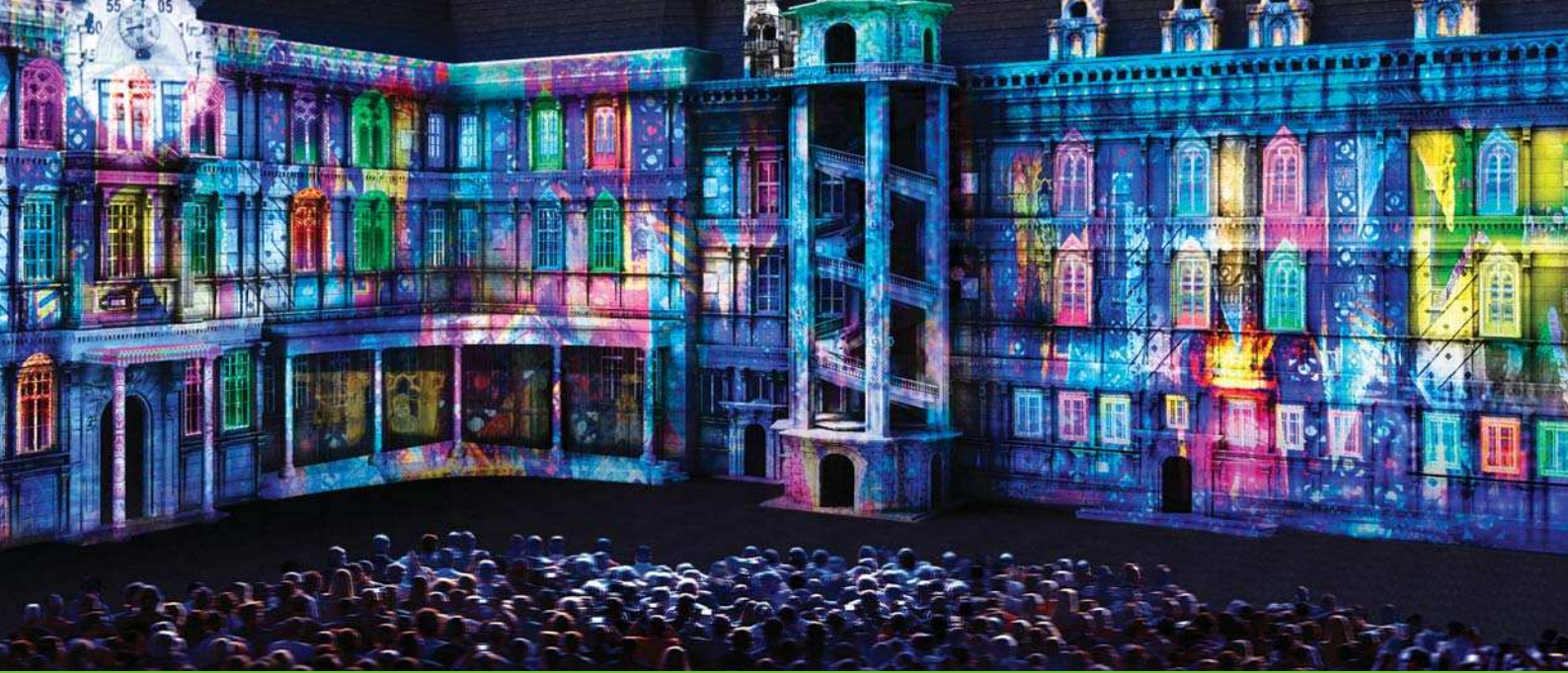

Extensive Lens Options

The Epson EB-L25000U offers an extensive line-up of optional lenses to fit any venue or subject. And with 4K compatibility on all our lenses, you enjoy outstanding resolution regardless of your lens selection.

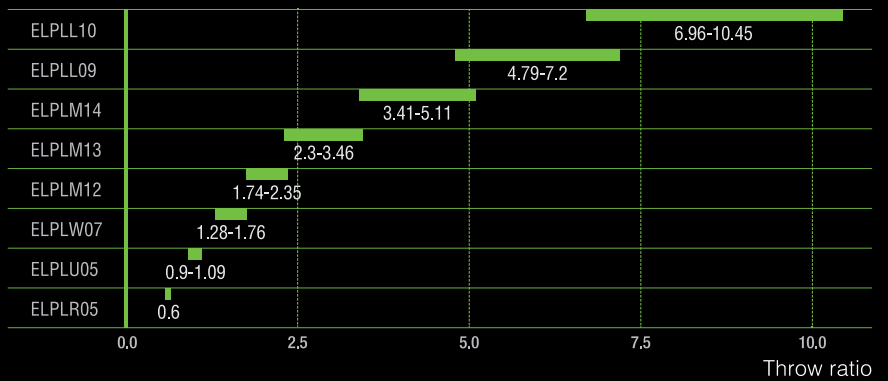

Multi-directional Projection

The EB-L25000U can be rotated 360° in any direction — horizontally, vertically and rotationally — without any loss in image brightness, making it ideal for a wide range of applications, including projecting onto ceilings and floors.

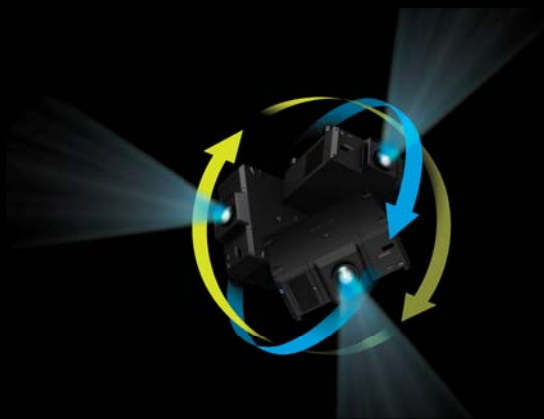

Borderless Multi-projection

With a variety of functions available for multi-projector installations, you can adjust the brightness, colour and position of overlapping areas for seamless, beautiful displays.

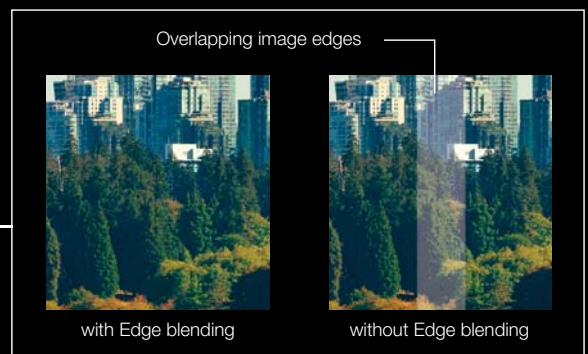
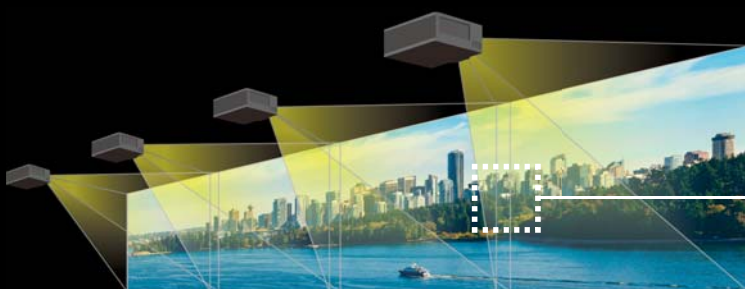

Shine Everywhere

Eye-catching, seamless, unified projections even on non-flat surfaces.

Projection on Wide Curved and Corner Spaces

Fit your projection images nicely even on non-flat surfaces. Create stunning projection images on wide curved surfaces and corner walls, ideal for advertisements and marketing promotions.

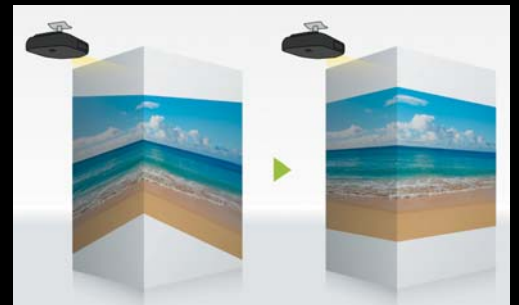

Blanking

With full adjustability on all edges, you can easily adjust the blanking width for oversized images or mask noise at the edges of the screen, even for images from a videocassette recorder.

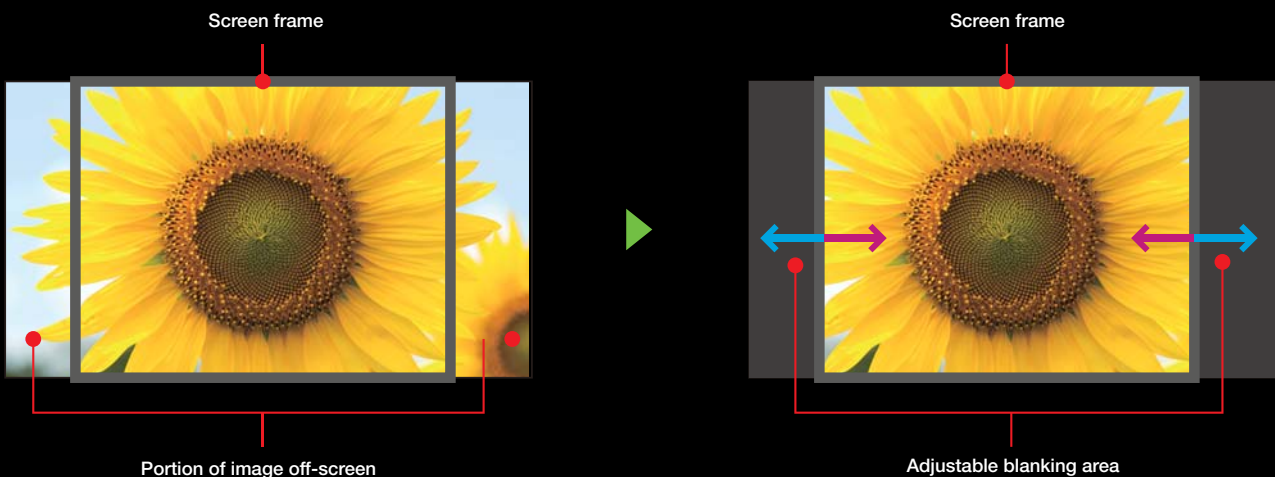



Point Correction

Easily correct single-projector distortion or multi-projector misalignment directly on the screen. Quickly fine-tune the images by adjusting point by point from right to left, top to bottom, using a projected maximum 17 x 17 matrix.



Black Level

Experience uniform black levels in overlapping areas of images even when using multiple projectors.



Auto-scaling

Say goodbye to the complicated scaling of images from multiple projectors. With auto-scaling, simply select the screen layout from the pre-set menu and your projector will automatically set the slice area, scaling and edge-blend position for seamless projections.



Advanced Edge Blending

Precisely adjust edge blending to combine multiple edges for a seamless, unified look. This function allows you to fine-tune the start position and edge width of the blend as well as the area of the black level in the blend. It also prevents the main subject from being overlapped. As a tip, you can reduce the size of the overlapping areas to decrease the time it takes to combine multiple images.

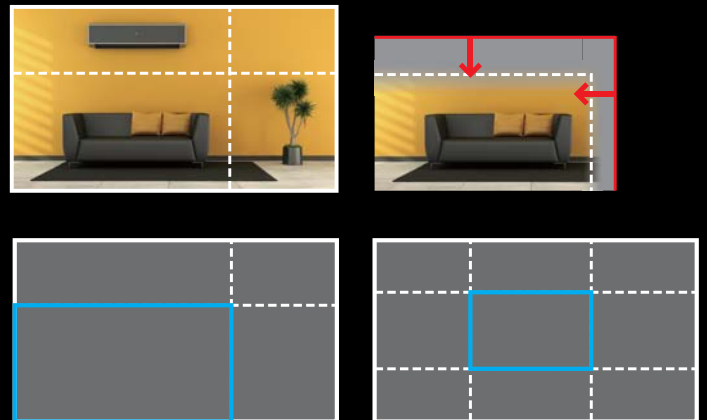

Shine Everywhere

Easily control and broadcast to multiple screens for dynamic and impressive presentations.

Split Screen

Project two different images from a single projector for a more effective presentation. In video conferences, for example, images of presentation materials and remote participants can be shown simultaneously. What's more with WUXGA resolution, you'll enjoy crisp, clear images for presentations that are brimming with impact.



Web Control with Smart Device Support

Use a computer web browser or smart device to adjust your projector settings. The newly designed OSD Control Pad function allows you to control the OSD menu and even view a representation of the lens-condition from your smart device.



Extended Connectivity

Equipped with a diverse range of input terminals, the Epson LB-L25000U supports a host of transmission outputs including 3G-SDI and HDBaseT for long-distance transmissions.

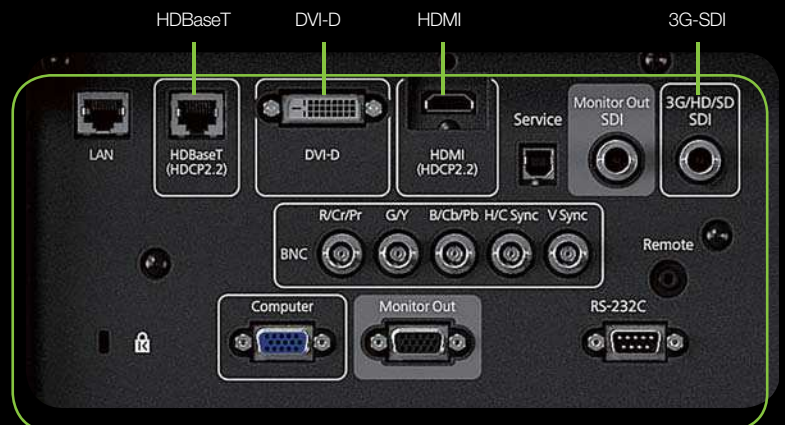



Easy MP Monitor and Message Broadcasting

With Epson's network monitoring and control software, you can see from a single PC which projectors are available and whether they are running efficiently – even across the biggest networks. Configure your projectors and access their serial numbers remotely and receive instant email alerts for pre-defined critical indicators such as non-functioning devices or overheating lamps.

You can also send messages or announcements as JPEG files simultaneously to any number of projectors on a network. This makes the EB-L25000U projector very useful for immediate communication needs or even emergencies.



DMX-ArtNet

The EB-L25000U supports DMX-ArtNet for synchronising lighting effects such as pre-programmed sequences with audio. Features you can control include power, shutter, switchgear, input source, lens drive (shift, focus and zoom) and lens memory settings.



Eco Features

- Uses just 0.5W of power in standby mode
- Projector optics employ lead-free lenses
- Unpainted plastic housing reduces the environment impact
- The flame retardants used in the plastic housing do not contain chlorine or bromine



Better Products for a Better Future™

For more information on Epson's environmental programmes, visit <http://global.epson.com/SR/environment>.

PARTNERS IN PERFECTION

Desktop Document Camera ELPDC21



2.6kg/6.6 lbs
1080p output resolution
2 megapixels with 30 fps
12 x optical zoom
HDMI digital connectivity

HDBaseT Transmitter ELPHD01



HDMI Input
RS232C for control
LAN for Ethernet
Allows Full HD uncompressed signal transmission up to 100 meters

WORKFORCE WF-6091 Printer



Print speeds of up to 34pp/minute
5760dpi resolution
Connectivity via Wi-Fi, Wi-Fi Direct and Epson Connect

MODEL NUMBER	EB-L25000U		
Projection Technology	RGB liquid crystal shutter projection system (3LCD)		
Specifications of Main Parts			
LCD	Size	1.43" (D8, C ² Fine)	
	Native Resolution	WUXGA (1920 x 1200)	
Projection Lens	Type	Power Zoom / Power Focus / Power Shift / Power Distortion	
	F-Number	1.9 - 2.1	
	Focal Length	54.7 - 73.0 mm	
	Zoom Ratio	1 - 1.35	
	Throw Ratio	1.74 - 2.35 (Wide - Tele)	
	Lens Exchange	Yes	
	Lens Shift	Mode	Powered
		Vertical (Up/Down)	±65%
Lamp	Horizontal (Left/Right)	±30%	
	Type	Laser Diode Bank	
	Life (Normal / Eco)	20,000 / 30,000 hours	
Screen Size (Projected Distance)			
Zoom: Wide	100" - 1,000" [3.68 - 37.92 m]		
Zoom: Tele	100" - 1,000" [4.99 - 51.03 m]		
Brightness¹			
White Light Output (Normal / Eco)	25,000lm / 17,500lm		
Colour Light Output	25,000lm		
Contrast Ratio	2,500,000		
Geometric Correction			
Vertical / Horizontal Keystone	±45° / ±30° (Zoom: Tele with Standard Zoom Lens)		
Quick Corner	Yes		
Curve Surface	Yes (Except when in 4K Enhancement mode)		
Point Correction	Yes (Except when in 4K Enhancement mode)		
Corner Wall	Yes (Except when in 4K Enhancement mode)		
Connectivity			
Analog Input	D-Sub 15Pin	1 (Blue)	
	5BNC	1	
Digital Input	DVI-D	1 (Single Link, HDCP 1.4)	
	HDMI	1 (with HDCP 2.2)	
	SDI	1 (SD-SDI, HD-SDI, 3G-SDI)	
	HDBaseT (RX)	1 (RJ-45)	
	Analog Output	D-Sub 15Pin	1
Digital Output	SDI	1 (SD-SDI, HD-SDI, 3G-SDI)	
Others	USB Type A	1 (Optional Wireless LAN, Firmware Update, Copying OSD Settings)	
	USB Type B	1 (Firmware Update and Copying OSD Settings)	
Control I/O	RS-232C	1	
	Remote Control Input	1	
	LAN (RJ-45)	1	
Network	Wired LAN	RJ-45 x 1 [Compliant with Control I/O (Art-Net)]	
	Wireless	Optional (ELPAP10)	
Wireless Specification			
Supported Speed For Each Mode	IEEE 802.11b: 11Mbps ² IEEE 802.11g: 54Mbps ² IEEE 802.11n: 130Mbps ²		
Wireless LAN Security	WPA-PSK (TKIP/AES) / WPA2-PSK (TKIP/AES)		
Operating Temperature			
	0 - 50 °C <-32 - 122 °F> (Below 1,500m / 4,921ft) 0 - 45 °C <-32 - 104 °F> [Above 1,500m / 4,921ft - 3,048m / 10,000ft (with high altitude mode)]		
Operating Altitude			
	0 - 3,048 m <0 - 10,000 ft> (Over 1,500m / 4,921ft : with high altitude mode)		
Direct Power On / Off			
	Yes		
Start-Up Period			
	Less than 8 seconds, Warm-up period: 30 seconds		
Cool Down Period			
	Instant Off		
Air Filter	Type	High Efficiency Filter (with Smoke Filter function)	
	Maintenance Cycle	20,000 hours ³	
Power Supply Voltage			
	100 - 240 V AC ±10%, 50/60 Hz		
Power Consumption (220 - 240V)			
Lamp On (Normal / Eco)	2390W / 1670W		
Standby (Network On / Off)	3.0W / 0.5W		
Dimension Excluding Feet (D X W X H)			
	710 x 790 x 299 mm		
Weight			
	65.6kg (excluide handle and lens)		
Fan Noise (Normal / Eco)			
	49dB / 41dB		

Supplied Accessories

- Power Cable
- Remote Control
- User's Manual CDROM
- HDMI Cable Clamp

Optional Accessories

- Air Filter: ELPAF52
- Wireless LAN Card: ELPAP10
- Remote Control Cable Set (10m x 2): ELPKC28
- HDBaseT Transmitter: ELPHD01
- Handle: ELPMB49

Optional Lenses

- Rear Projection Wide Lens: ELPLR05
- Short Throw Zoom Lens1: ELPLU05
- Short Throw Zoom Lens2: ELPLW07
- Middle Throw Zoom Lens1: ELPLM12
- Middle Throw Zoom Lens2: ELPLM13
- Middle Throw Zoom Lens3: ELPLM14
- Long Throw Zoom Lens1: ELP LL09
- Long Throw Zoom Lens2: ELP LL10

EB-L25000U



©2016 Epson Singapore Pte Ltd. All Rights Reserved. Reproduction in part or in whole, without the written permission from Epson, is strictly prohibited.

EPSON and EXCEED YOUR VISION are registered trademarks of Seiko Epson Corporation.

All other product names and other company names used herein are for identification purposes only and are the trademarks or registered trademarks of their respective owners.

Epson disclaims any and all rights in those marks. Projected images shown herein are simulations. The actual product design and contents may vary. Specifications are subject to change without notice and may vary between countries. Please check with local Epson offices for more information.

Apple, iPad and iPhone are trademarks of Apple Inc., registered in the U.S. and other countries. App Store is a service mark of Apple Inc.

Android is a trademark of Google Inc.

Information correct as at October 2016

¹ Colour brightness (colour light output) and white brightness (white light output) will vary depending on usage conditions. Colour light output measured in accordance with IDMS 15:4; white light output measured in accordance with ISO 21118.

² Maximum speed and range is achievable when used with same enhanced mode technology. Actual data rates, features and performance may vary depending on your computer system, the environment and other factors.

³ When used in the general office environment (the amount of floating dust: 0.04 - 0.2 mg/m³). Based on the Epson's in-house test results.