

User's Guide

Multimedia Projector

EB-L30002U

EB-L30000U

ProSelecta



View :: Compare :: Select - www.ProSelecta.com

Notations Used in This Guide



- **Safety indications**

The documentation and the projector use graphical symbols to show how to use the projector safely.

The indications and their meaning are as follows. Make sure you understand them properly before reading the guide.

 Warning	This symbol indicates information that, if ignored, could possibly result in personal injury or even death due to incorrect handling.
 Caution	This symbol indicates information that, if ignored, could possibly result in personal injury or physical damage due to incorrect handling.

- **General information indications**

Attention	Indicates procedures which may result in damage or injury if sufficient care is not taken.
	Indicates additional information and points which may be useful to know regarding a topic.
	Indicates a page where detailed information regarding a topic can be found.
[Name]	Indicates the name of the buttons on the remote control or the control panel. Example: [Esc] button
Menu Name	Indicates Configuration menu items. Example: Select Brightness from Image . Image - Brightness

Make sure you read the following before you use the projector.

☛ [Safety Instructions](#)

Warning and Cautions on Installation

Warning

- This is a class A product. In a domestic environment this product may cause radio interference in which case the user may be required to take adequate measures.
- Do not use or install the projector where it may be subject to water or rain, or high humidity, such as outdoors, in a bathroom, or shower room, and so on. Otherwise, it could cause a fire or electric shock.
- Do not install in locations where salt damage could occur, or in locations subject to corrosive gas such as sulphuric gas from hot springs. Otherwise, corrosion could cause the projector to fall. It could also cause the projector to malfunction.
- Note the following points when installing on a ceiling (ceiling mount) or in a high location. If installation work is not carried out correctly, the projector could fall down. This may result in injury or accidents.
 - Since special techniques are required to install the projector on a ceiling and to handle the ceiling mount, make sure you contact a professional.
 - Secure the mount with bolts using the handle securing section (6 points) on the top or base of the projector.
 - To prevent the projector from falling, thread sufficiently strong wire rope and so on through the ceiling mount and secure to the ceiling.
- Do not place flammable objects in front of the lens. If you set the schedule to turn on the projector automatically, any flammable objects placed in front of the lens could cause a fire.

Warning

- Do not tie the power cord and other connection cables together. Otherwise, it could cause a fire.
- Only use the specified power-supply voltage. Otherwise, it could cause a fire or electric shock.
- Be careful when handling the power cord. Otherwise, it could cause a fire or electric shock. Note the following when handling the power cord.
 - Do not plug multiple power cords in a single electric outlet.
 - Do not plug in the power cord if there are any foreign substances, such as dust, stuck to it.
 - Make sure you insert the power cord all the way in.
 - Do not plug in or unplug the power cord with wet hands.
 - Do not pull the cord when unplugging the power cord. Make sure you hold it by the plug.
- Do not use a damaged power cord. Otherwise, it could cause a fire or electric shock. Note the following when handling the power cord.
 - Do not alter the power cord.
 - Do not place any heavy objects on the power cord.
 - Do not bend, twist, or pull the power cord forcibly.
 - Do not layout the power cord near a heating device.

Warning

- Do not cover the projector's air intake vent or air exhaust vent. If either of the vents is covered, the internal temperature could rise and cause a fire.
- Make sure you secure the following space around the projector so as not to block the air intake vent and air exhaust vent.

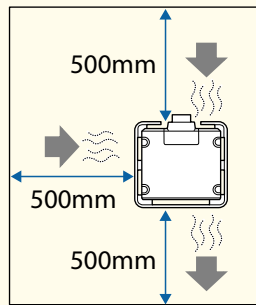

- When setting up multiple projectors, make sure there is a gap of at least 200 mm between the projectors. Also, make sure that the heat from the air exhaust vent does not go into the air intake vent.

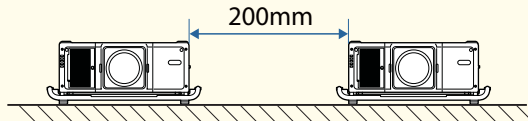

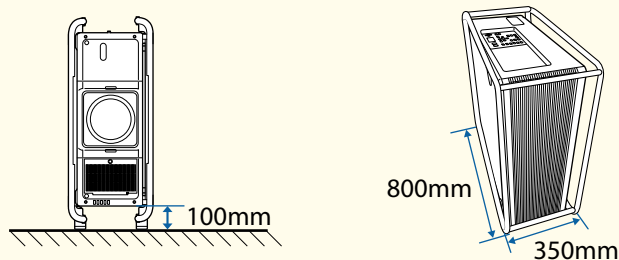

- When installing the projector with the air intake vent facing down, make sure there is a gap of at least 100 mm between the projector and the floor and so on. Make sure there is a space of 800 x 350 mm for the base so that the air intake vent is not blocked.



Caution

Do not place the projector on an unstable surface, such as on an unstable table or tilted surface. Install the projector appropriately to prevent the projector from falling. Otherwise it may cause an injury.

Attention

- Do not install the projector in a location that is subject to vibration or shock.
- Do not install the projector near a high-voltage line or object that generates magnetism. Otherwise the projector may not work correctly.
- Do not use or store the projector in a location that is subject to extreme temperatures. Also, avoid sudden temperature changes.
Make sure you use or store the projector in a place that is within the operating or storage temperature ranges.
 "Projector General Specifications" [p.270](#)
- Do not install the projector in direct sunlight.
If the projector is in direct sunlight, the internal temperature increases, which could cause parts such as the surface of the projection lens or the built-in camera to deteriorate.
- When installing the projector in an environment in which a high-powered laser beam is being used, make sure it is installed so that the laser beam does not hit the surface of the projection lens.
- When using at an altitude that exceeds 1,500 m, set **High Altitude Mode** to **On**.
 **Extended - Operation - High Altitude Mode** [p.147](#)

Attention

- You may need dedicated installation mounts to tilt and install the projector. Contact a specialist and prepare the mount.
 - Plan so that the mount does not fall.
 - Make sure the mount is strong enough to support the projector.
 - When attaching a mount to the projector, secure the mount with bolts using the handle securing section (6 points) on the top or base of the projector.
- Note the following points when installing a projector directly on top of another. This projector can be installed on top of another projector that has the carrying handles attached to the top.
 - Do not stack three or more projectors (you can stack up to two projectors).
 - Install the feet in the indentations on the top at the four corners.
 - Do not remove the feet on the bottom of the projector.
- Except for the projector's parts, do not place anything on the projector.



- The projector can be installed at any angle. There is no vertical or horizontal limit to how the projector can be installed.

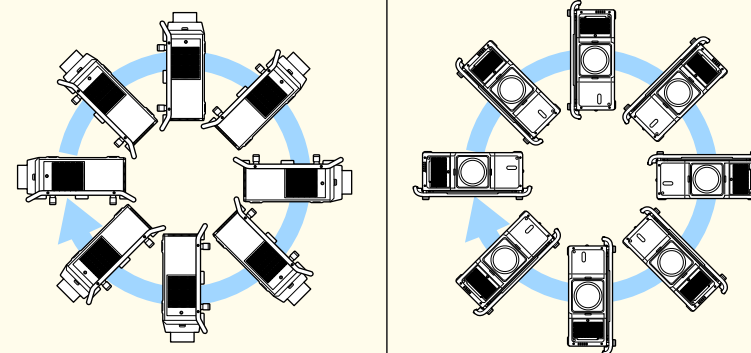

- We recommend setting the focus, zoom, and lens shift at least 20 minutes after you start the projection, because images are not stable right after turning on the projector.
- When using a projector with an air filter on the ceiling side, the air filter will become clogged frequently. Clean the air filter regularly.
 - ☛ "Cleaning the Air Filter and Air Intake Vent" [p.216](#)
- You can install the projector in a portrait orientation by attaching the carrying handles to the top and bottom of the projector. You can remove the feet from the projector and attach them to the carrying handle.

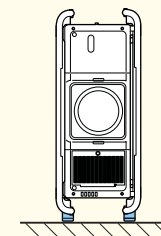
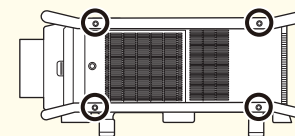

Cautions on Lifting

Caution

- Use the four eye bolts installed on the same surface of the projector to lift it.

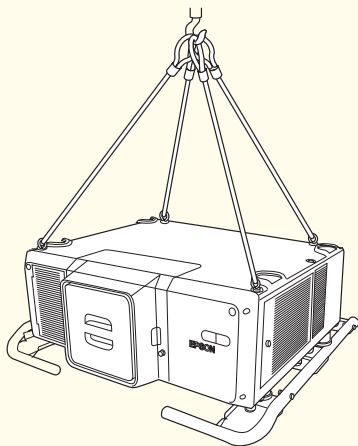

- Only use the eye bolts when temporarily transporting the projector and not for permanent installation. The projector could be damaged or could malfunction.
- Do not lift the projector with the front/back/side of the projector facing up.
- Make sure that the angle when lifting is 60 degrees or more.

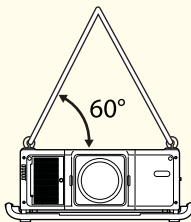

Attention

When attaching directly to the projector

Use four commercially available eye bolts M8 (ankle length 11 to 16 mm) and attach them to the four screw holes for eye bolts.

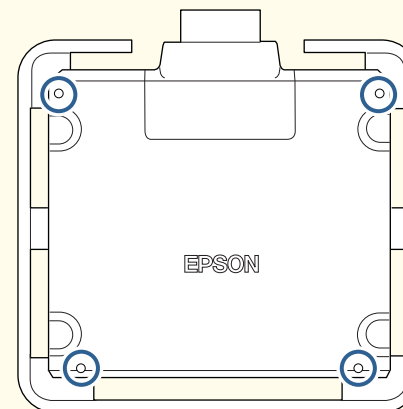

When attaching to the handle

Use four commercially available eye bolts M10 (ankle length 11 mm or more) and attach them to the four screw holes for eye bolts on the handle.

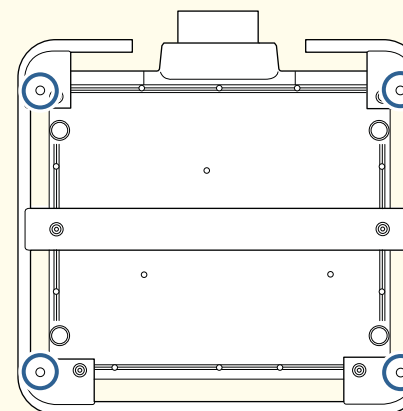

Warning and Cautions on Usage

Warning

- Do not cover the projector's air intake vent or air exhaust vent. If either of the vents is covered, the internal temperature could rise and cause a fire.
- Do not look into the lens while projecting. The powerful light emitted could cause damage to eyesight. Take particular care when there are children present. When turning on the projector at a distance using the remote control, make sure there is no one looking into the lens.
- During projection, do not block the light from the projector with the lens cover (removable) or a book and so on.

If the light from the projector is blocked, the area on which the light shines becomes hot which could cause it to melt, burn, or start a fire. Also, the lens may get hot due to the reflected light which could cause the projector to malfunction. To stop projection, use the Shutter function, or turn off the projector.



- Do not open the projector's case. Never disassemble or remodel the projector. There are high-voltage components inside the projector that could cause fire, electric shock, or an accident.
- If an error occurs, disconnect the power cord from the electrical outlet, and contact your local dealer or the nearest address provided in the Epson Projector Contact List. If you continue using the projector as it is, it could cause an electric shock, fire, or even damage to eyesight.

 [Epson Projector Contact List](#)

Caution

Do not place objects that may become warped or otherwise affected by heat near the air exhaust vent and do not put your face or hands near the vent while projection is in progress.

Attention

- When you purchase the projector, a protective cap is installed in the lens unit installation section. Install the protective cap when you are not using the projector. If dust or dirt enter the projector, projection quality deteriorates and it could cause a malfunction.
- When a high-powered laser beams through the surface of the projection lens or the built-in camera, it can cause a malfunction. If the laser beams through the surface of the projection lens or the built-in camera, block the laser beam with non-permeable or incombustible aluminum foil or metal plates such as iron to protect the projection lens and the built-in camera. You can also use the projector's Shutter function to prevent the LCD panel from being damaged by laser light.
- Try not to touch the lens section with your hand or fingers. If fingerprints or oils are left on the surface of the lens, projection quality deteriorates.
- If you continue to project while the surface of the lens is dirty, projection quality deteriorates. Make sure you clean the lens.
 -  "Cleaning the Lens" [p.216](#)
- Store the projector with the protective cap installed. If the projector is stored without the protective cap, dust and dirt may get inside the projector and cause malfunctions or lower the quality of projection.
- When storing, make sure you remove the batteries from the remote control. If the batteries are left in the remote control for an extended period of time, they may leak.
- When using the projector in smoky environments such as at events and so on, make sure you replace the air filter after approximately 240 hours of use. (This is a guideline when using the projector in an environment with an atmospheric concentration of ondina oil of approximately 0.00000013%. The air filter replacement time may be shorter depending on the operating environment.) Using the projector in a smoky environment may cause the filter's dust collection function to decline and dust may adhere to the inside of the projector or the power supply; this may cause a malfunction to occur.
 -  "Replacing the Air Filter" [p.221](#)



- About the LCD panel

- The LCD panel may contain pixels that are missing or appear bright all the time. This is not a sign of an error.
- If you project a still image or an image that does not move much for a long time, the image may remain as an afterimage. This is due to the properties of the LCD panel and is not a malfunction. You need to run **Refresh Mode** to solve this issue.

☛ **Reset - Refresh Mode** [p.163](#)

- About the light source

The projector uses a laser as the light source. The laser has the following characteristics.

- Depending on the surroundings, the brightness of the light source may decline. The brightness declines a lot when the temperature gets too high.
- The brightness of the light source declines the longer it is used. You can change the relationship between operation time and decline in brightness in **Brightness Settings**.

☛ "Relationship between Brightness Level and light source operation time" [p.76](#)



- About light source calibration

- When **Run Periodically** is set to **On** for Light Source Calibration, every time the usage time reaches 100 hours, calibration starts automatically for the light source when the projector is turned off. However, light source calibration does not start automatically in the following situations.

- Within 20 minutes of turning on the projector
- When using the Shutter function
- Within 20 minutes of releasing the Shutter function
- When the projector is used continuously for over 24 hours
- When using direct shutdown

- When performing Light Source Calibration, the differences in the White Balance and the Brightness Level for the light source are corrected.

☛ **Reset - Light Source Calibration - Run Periodically** [p.163](#)

Warning and Cautions on the Laser

Warning

- Laser warning labels are attached to the projector.

Top

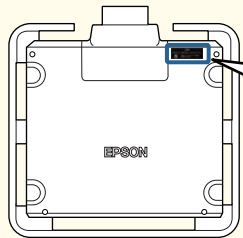

WARNING

⚠️

⚠️

WARNING: Never look into the lens.
AVERTISSEMENT : Ne regardez jamais dans l'objectif.
ADVERTENCIA : No mire nunca a través del objetivo.

Side

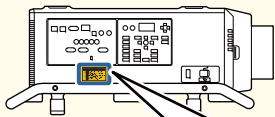

WARNING

⚠️

WARNING: Do not look into the beam. No direct eye exposure to the beam is permitted. RISK IEC/EN62471-5:2015, CLASS 1 LASER PRODUCT IEC/EN60825-1:2014. Hazard Distance: Refer to the manual.

AVERTISSEMENT: Ne pas regarder le faisceau. L'exposition directe des yeux au faisceau est interdite. RISK IEC/EN62471-5:2015, PRODUIT LASER DE CLASSE 1 IEC/EN60825-1:2014. Distance de sécurité: Consultez le manuel.

ADVERTENCIA: No mire a la fuente de luz. No debe permitirse el contacto directo de los ojos con el haz de luz. RISK IEC/EN62471-5:2015, PRODUCTO LASER DE CLASE 1 IEC/EN60825-1:2014. Distancia de seguridad: Consulte el manual de usuarios.

WARNING: Nicht in den Strahl blicken. Keinen direkten Blickkontakt mit dem Strahl zulassen. RISK IEC/EN62471-5:2015, LASER-KLASSE 1 IEC/EN60825-1:2014. Sicherheitsabstand: entnehmen Sie dem Handbuch.

WARNING

⚠️

警告: 不要直视光源。眼睛不要直视激光辐射。不要直视光源。不要直视激光辐射。RISK IEC/EN62471-5:2015, 激光类产品 IEC60825-1:2014/G87247.1 危险距离: 请参考说明书。

警告: 請勿直視光源。禁止眼睛直接對準雷射光束。RISK IEC/EN62471-5:2015, 雷射 (CLASS 1) 雷射產品 IEC60825-1:2014 危險距離: 請參閱手冊。

警告: 必ず直視しないでください。目へのレーザーの直接照射は禁止されています。RISK IEC/EN62471-5:2015, レーザー製品 IEC60825-1:2014/JIS C 8902:2014 危険距離: 取扱説明書を参照してください。

Warning

- Do not open the projector's case. The projector contains a high-powered laser.
- Possibly hazardous optical radiation emitted from this product. Do not look at operating light source. Eye injury may result.

Caution

- This projector is a Class 1 laser product that complies with the IEC/EN60825-1:2014 international standard for lasers.
- Do not disassemble the projector when disposing of it. Dispose according to your local or national laws and regulations.

Hazard Distance according to IEC62471-5:2015

Looking into the lens at distances closer than those indicated here can cause damage to eyesight.

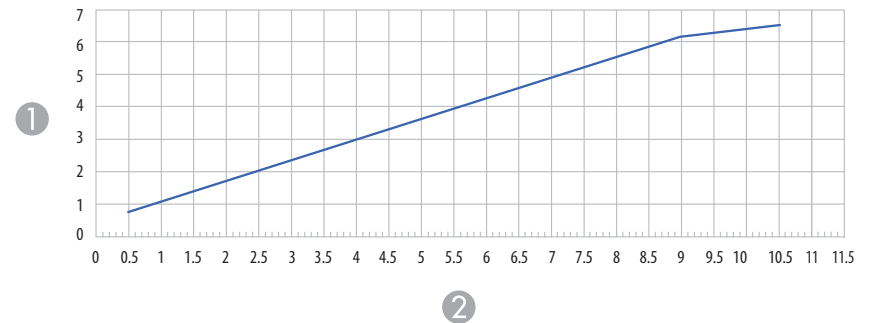

① Hazard distance (Units: m)

② Throw ratio

Notes on Carrying and Transporting

There are many glass parts and precision components inside the projector. To prevent damage due to impacts when carrying and transporting, handle the projector as follows.

Before carrying or transporting, make sure you read the supplied *Transport and Installation Handbook*.

Caution

The projector should not be carried by one person. At least four people are needed to unpack or carry the projector.

Attention

Prepare the following before carrying the projector. Check the *Transport and Installation Handbook* for more information.

- Turn off the power to the projector and disconnect all cables.
- When moving nearby without having to pack-up the projector, install the lens cap on the lens unit.
- When packing up and transporting the projector, remove the lens unit and install the protective cap on the lens unit installation section.
- Enclose the projector securely in packaging material to protect it from shock, and place it into a strong container. Be sure to notify the carrier company that it is precision equipment and that it needs to be kept horizontally during transportation.

Notations Used in This Guide 2

Introduction

Part Names and Functions 17

Front/Top	17
Rear/Side	18
Base	19
Handle	20
Connector Ports	20
Control Panel	22
Remote Control	23
Handy remote control operations	25
Replacing the remote control batteries	26
Remote control operating range	27
Connecting a cable to the remote control	27

Preparing the Projector

Installing the Projector 30

Removing and Attaching the Projector Lens Unit	30
Attaching	30
Lens Calibration	32
Removing	33
Installation Settings	34
Changing the direction of the image (projection mode)	34
Screen Settings	34
Adjusting the position of the image on the projected screen	35
Displaying the Test Pattern	36
Adjusting the Position of the Projected Image (Lens Shift Adjustment)	37
Adjusting the Image Size	39
Correcting the Focus	40
Correcting Distortion (Image Warping)	41
Registering and Loading Lens Adjustment Values	42
ID Settings	43

Set the projector ID	43
Checking the projector ID	44
Setting the remote control ID	44
Setting the Time	44
Other Settings	46
Settings related to basic operations	46
Settings related to display	46

Connecting Equipment 48

Connecting a Computer	48
Connecting Image Sources	50
Connecting to an External Monitor	52
Connecting a LAN Cable	53
Connecting an HDBaseT Transmitter	54
Installing the Wireless LAN Unit	55

Basic Usage

Turning On the Projector 57

Turning Off the Projector 59

Projecting Images 60

Automatically Detecting Input Signals and Changing the Projected Image (Source Search)	60
Switching to the Target Image	61

Adjusting Projected Images 62

Correcting Distortion in the Projected Image	62
H/V-Keystone	63
Quick Corner	64
Curved Surface	65
Corner Wall	69
Point Correction	72
Selecting the Projection Quality (Selecting Color Mode)	74
Setting the Brightness	75
Guide to Estimated Remains	76
Relationship between Brightness Level and light source operation time	76

Setting the Amount of Light of the Projected Image	77
Changing the Aspect Ratio of the Projected Image	78
Changing methods	78
Adjusting the Image	79
Hue, Saturation, and Brightness adjustment	79
Gamma adjustment	80
Adjusting Image Resolution (Image Enhancement)	81
4K Enhancement	81
Image Preset Mode	82
Frame Interpolation	82
Noise Reduction	83
MPEG Noise Reduction	83
Super-resolution	84
Detail Enhancement	84

Useful Functions

Multi-Projection Function	87
Adjustment Procedure	87
Adjusting automatically online	87
Adjusting manually offline	88
Tiling	89
Performing tiling automatically	89
Performing tiling manually	90
Edge Blending	91
Black Level	93
Area Correction	94
Screen Matching	95
Operating conditions for auto adjustment functions	96
Automatically correct the brightness and tint for multiple projectors	96
Color Matching	97
Displaying a Scaled Image	98
Using Tiling Function of Geometry Correction Assist	100
Operating conditions for auto adjustment functions	100
Using the Stacking Function of Geometry Correction Assist	101
Operating conditions for auto adjustment functions	101

Projection Functions 103

Projecting Two Images Simultaneously (Split Screen)	103
Input Sources for Split Screen Projection	103
Operating procedures	103
Restrictions during split screen projection	105
Hiding the Image Temporarily (Shutter)	106
Freezing the Image (Freeze)	107
Saving a User's Logo	107

Memory Function 109

Saving/Loading/Erasing/Resetting the Memory	109
---	-----

Scheduling Function 111

Saving an Event	111
Setting an Event	111
Checking an Event	112
Editing an Event	113

Security Functions 115

Managing Users (Password Protection)	115
Kinds of Password Protection	115
Setting Password Protection	115
Entering the password	116
Restricting Operation	117
Control Panel Lock	117
Lens Lock	118
Remote control button lock	118
Anti-Theft Lock	119
Installing the wire lock	119

Using the Projector on a Network

Wired Network Projection 122

Selecting Wired Network Settings	122
--	-----

Wireless Network Projection 124

Selecting Wireless Network Settings Manually	124
--	-----



Selecting Wireless Network Settings in Windows 126

Selecting Wireless Network Settings in Mac 126

Setting Up Wireless Network Security 127

 Supported Client and CA Certificates 129

Using a QR Code to Connect a Mobile Device 129

Using a USB Key to Connect a Windows Computer 130

Setting a Static IP Address Using the LCD Display 132

Secure HTTP 133

 Importing a Web Server Certificate Using the Menus 133

 Supported Web Server Certificates 134

 Setting a certificate using a Web browser 134

Configuration Menu

Configuration Menu Operations 137

List of Functions 138

 Configuration Menu Table 138

 Network menu 140

 Image Menu 141

 Signal Menu 143

 Settings Menu 145

 Extended Menu 147

 Network Menu 151

 Notes on operating the Network menu 153

 Soft keyboard operations 153

 Basic menu 154

 Wireless LAN menu 154

 Wired LAN menu 158

 Notifications menu 159

 Others menu 160

 Reset menu 161

 Info Menu (Display Only) 161

 Reset Menu 163

Batch Setup 165

Setup Using a USB Flash Drive 166

 Saving settings to the USB flash drive 166

 Reflecting saved settings to other projectors 168

Setup by Connecting the Computer and Projector with a USB Cable 169

 Saving settings to a computer 169

 Reflecting saved settings to other projectors 171

When Setup Fails 172

Troubleshooting

Using the Help 174

Reading the Indicators 175

Understanding the Status Information 182

 Checking the Status 182

 Understanding the screen 183

 Setting the screen display (LCD) 184

 Explanations of the Display Content 185

Problem Solving 200

 Problems Relating to Images 201

 No images appear 201

 Moving images are not displayed 202

 Projection stops automatically 202

 Not supported is displayed 202

 No Signal is displayed 202

 Images are fuzzy, out of focus, or distorted 203

 Interference or distortion appear in images 203

 The image is truncated (large) or small, the aspect is not suitable, or the image has been reversed 204

 Image colors are not right 205

 Images appear dark 206

 Automatic adjustments are not performed correctly 206

 Problems when Projection Starts 208

 The projector does not turn on 208

 Other Problems 209

 There are afterimages (screen burn-in) in the projected image 209

The remote control does not work 209

Cannot control correctly using Art-Net 210

Nothing appears on the external monitor 210

I want to change the language for messages and menus 211

Email is not received even if a problem occurs in the projector 211

The battery that saves your clock settings is running low. is displayed 211

The projector did not turn off correctly. is displayed 211

Detailed logs and error message are not displayed 212

About Event ID 213

Maintenance

Cleaning the Parts 216

Cleaning the Projector 216

Cleaning the Lens 216

Cleaning the Air Filter and Air Intake Vent 216

 Cleaning the air filter 217

 Cleaning the air intake vent 220

Replacing Consumables 221

Replacing the Air Filter 221

 Air filter replacement period 221

 Replacing the air filter 221

Image Maintenance 224

Color Calibration 224

Panel Alignment 224

Color Uniformity 226

Appendix

Monitoring and Controlling 230

Epson Projector Management 230

Changing Settings Using a Web Browser (Epson Web Control) 230

 Displaying the Epson Web Control Screen 230

Basic Control Screen 232

OSD Control Pad Screen 232

Lens Control Screen 233

Status Information Screen 235

Remote Camera Access Screen 235

Using the Mail Notification Function to Report Problems 238

 Reading error notification mail 238

Management Using SNMP 239

ESC/VP21 Commands 239

 Command list 239

 Cable layouts 240

About PJLink 241

About Crestron Connected® 241

 Operating a projector from your computer 242

About Art-Net 246

 Channel definitions 246

Optional Accessories and Consumables 252

Optional Accessories 252

Consumables 252

Screen Size and Projection Distance 253

Projection Distance List 253

 ELPLR05 253

 ELPLU05 254

 ELPLW07 254

 ELPLM12 255

 ELPLM13 256

 ELPLM14 256

 ELPLL09 257

 ELPLL10 258

Adjustment Range for Projected Images 259

H/V-Keystone 259

Curved Surface 259

Corner Wall 261

Supported Monitor Displays 264

Supported Resolutions 264



SDI	268
Specifications	270
Projector General Specifications	270
Appearance	275
General Notes	277
About Notations	277
Trademarks and Copyrights	277
List of Safety Symbols	279
Index	281



Introduction

This chapter explains the names for each part.

Unless otherwise mentioned, the illustrations used in this guide show the projector with the lens unit (ELPLM12) installed.

Front/Top

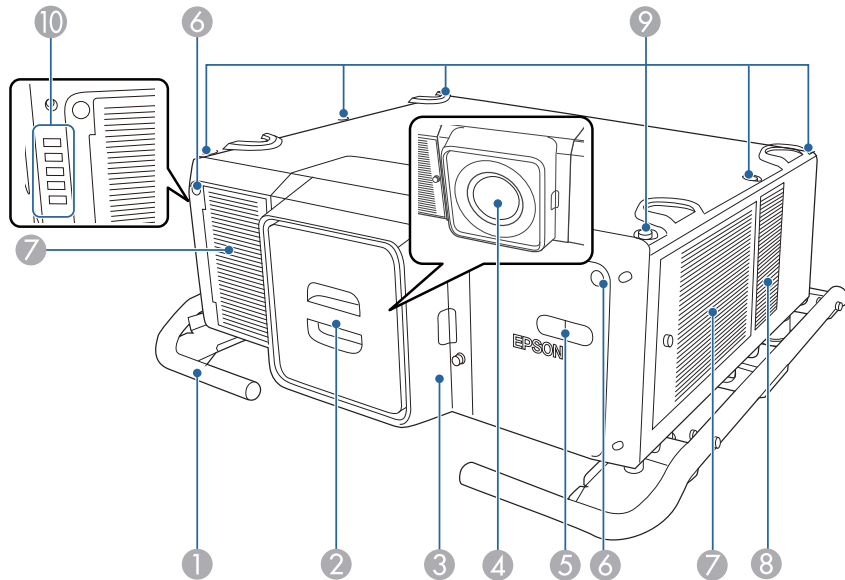

Here, the protective cap is installed.

Name	Function
① Handles	Use the handles on the left and right when carrying the projector.
② Protective cap	Install this when storing or transporting the projector.

Name	Function
③ Lens replacement cover	Remove when attaching or removing the lens.  "Removing and Attaching the Projector Lens Unit" p.30 <div style="border: 1px solid black; padding: 5px; margin-top: 10px;"> <p>⚠ Caution</p> <p>When moving the projector, do not hold the lens replacement cover. The lens replacement cover may be removed and the projector may fall, which could cause an injury.</p> </div>
④ Projection lens	Images are projected through here. <div style="border: 1px solid black; padding: 5px; margin-top: 10px;"> <p>⚠ Warning</p> <p>Do not look into the lens while projecting. This could cause damage to eyesight due to the powerful light emitted.</p> </div> <div style="border: 1px solid black; padding: 5px; margin-top: 10px;"> <p>⚠ Caution</p> <p>When shifting the lens, do not put your hands near the lens unit. Your fingers may get caught between the lens unit and the projector, and cause an injury.</p> </div>
⑤ Built-in camera	This camera scans the image when correcting the projected image automatically. <div style="border: 1px solid black; padding: 5px; margin-top: 10px;"> <p>Attention</p> <p>Exposing the camera to bright light may cause a malfunction to occur.</p> </div>
⑥ Remote receiver	Receives signals from the remote control.

	Name	Function
7	Air intake vent (air filter)	Takes in air to cool the projector internally. Be sure to clean the air filter regularly. ☛ "Cleaning the Air Filter and Air Intake Vent" p.216 ☛ "Replacing the Air Filter" p.221
8	Air intake vent	Takes in air to cool the projector internally. Be sure to clean the air intake vent regularly. ☛ "Cleaning the Air Filter and Air Intake Vent" p.216
9	Handle securing section (6 points)	Installs the optional handle. ☛ "Optional Accessories" p.252 You can also use this for custom installation mounts designed by the customer.
10	Status indicators	The color of the indicators and whether they are flashing or lit indicate the status of the projector. ☛ "Reading the Indicators" p.175

Rear/Side

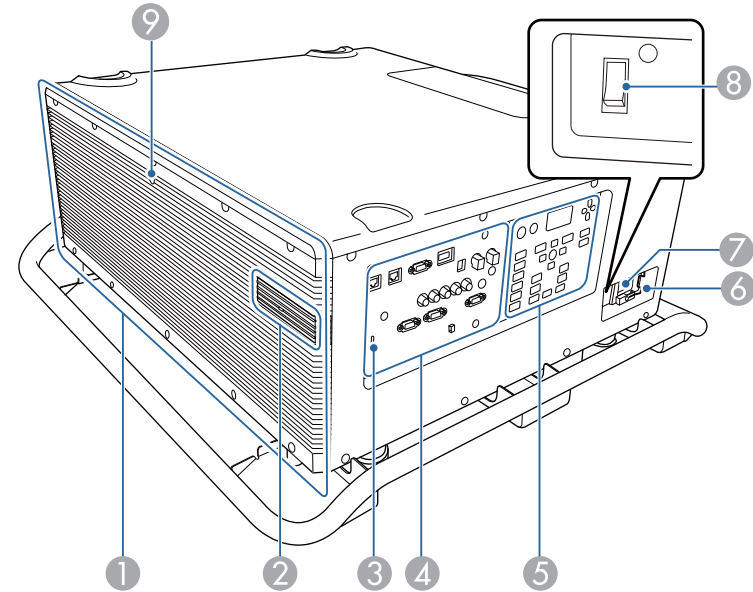

	Name	Function
1	Air exhaust vent	Exhaust vent for air used to cool the projector internally. <div data-bbox="1534 1038 2089 1329" style="border: 1px solid black; padding: 5px;"> <p>⚠ Caution</p> <p>While projecting, do not put your face or hands near the air exhaust vent, and do not place objects that may become warped or damaged by heat near the air exhaust vent. Hot air from the air exhaust vent could cause burns, warping, or accidents to occur.</p> </div>

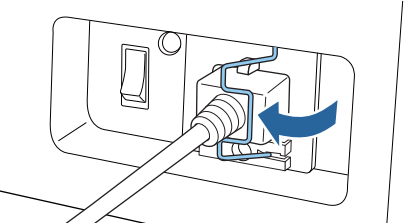
Name	Function
② USB-A port cover (USB-A port)	<ul style="list-style-type: none"> Installs the optional wireless LAN unit. <ul style="list-style-type: none"> "Installing the Wireless LAN Unit" p.55 This is used for batch settings. <ul style="list-style-type: none"> "Batch Setup" p.165 Connects a USB flash drive to save the projector's operation logs. <ul style="list-style-type: none"> Extended - Operation - Log Save Destination p.147 Connects to the power port for the video receiver, network equipment, or optical HDMI cable (for extending). Operations for all equipment are not guaranteed. Check that you can operate your equipment when using this connector. <div style="border: 1px solid black; padding: 5px; margin-top: 10px;"> <p>Attention</p> <p>When using the projector with the cover removed, be careful not to lose the cover.</p> </div>
③ Security slot	<p>The security slot is compatible with the Microsaver Security System manufactured by Kensington.</p> <ul style="list-style-type: none"> "Anti-Theft Lock" p.119
④ Connector ports	<ul style="list-style-type: none"> "Connector Ports" p.20
⑤ Control panel	<ul style="list-style-type: none"> "Control Panel" p.22
⑥ Cable holder	<p>Attach this to the power cord to prevent the cord from falling out.</p> 
⑦ Power inlet	<p>Connects the power cord to the projector.</p>
⑧ Main power switch	<p>Supplies power to the projector.</p>

Name	Function
⑨ Remote receiver	<p>Receives signals from the remote control.</p>

Base

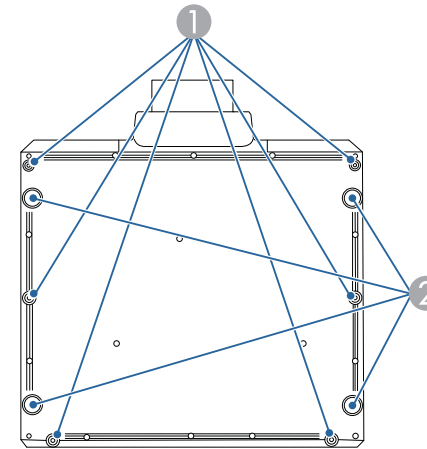

Name	Function
① Handle securing section (6 points)	<p>Installs the handle supplied.</p>
② Feet	<p>You can remove these from the projector and attach them to the handle. The feet are detachable. You can extend the feet by approximately 16 mm before they detach.</p>

Handle

This is attached to the projector at the time of purchase.

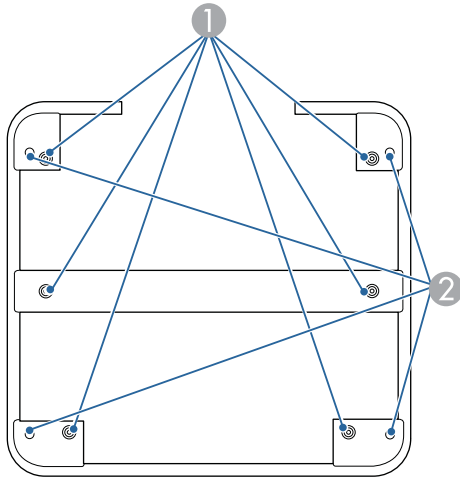

Name	Function
① Screw holes for securing the handle (6 points)	When attaching the handle to the projector, make sure you secure it with the screws.
② Screw holes for eye bolts (4 points)	You can attach a commercially available eye bolt when temporarily transporting the projector. ☛ "Cautions on Lifting" p.6

Connector Ports

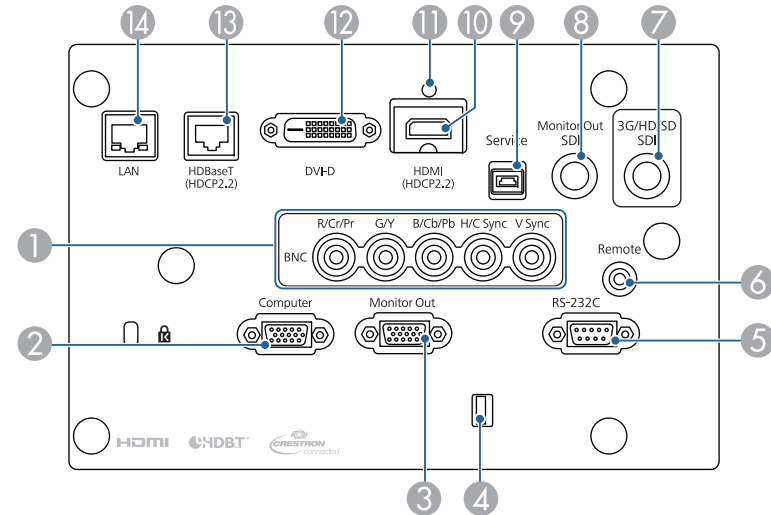

Name	Function
① BNC port	For analog RGB signals from a computer and component video signals from other video sources.
② Computer Port	For analog RGB signals from a computer and component video signals from other video sources.
③ Monitor Out port	Outputs to an external monitor the analog signal from the computer connected to the Computer port or the BNC port. You cannot output signals input from other ports or component video signals.
④ Cable holder	Run a commercially available cable tie to secure cables.
⑤ RS-232C port	When controlling the projector from a computer, connect it to the computer with an RS-232C cable. ☛ "ESC/VP21 Commands" p.239

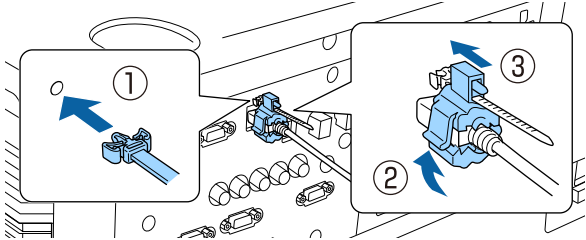
Name	Function
⑥ Remote port	Connects the optional remote control cable set and inputs signals from the remote control. When the remote control cable is plugged into the Remote port, the remote receiver on the projector is disabled. ☛ "Optional Accessories" p.252
⑦ 3G/HD/SD SDI port	Inputs SDI signals from video equipment.
⑧ Monitor Out SDI port	Connects to an external monitor, and outputs SDI signals from video equipment being input to the 3G/HD/SD SDI port.
⑨ Service port	This is used for batch settings. This port is for control use and should not normally be used. ☛ "Batch Setup" p.165
⑩ HDMI port	Inputs video signals from HDMI compatible video equipment and computers.
⑪ Cable holder	Insert the supplied cable clamp here to prevent the HDMI cable from falling out. 
⑫ DVI-D port	Inputs the computer DVI-D signals.
⑬ HDBaseT port	Connects a LAN cable to the optional HDBaseT Transmitter. ☛ "Connecting an HDBaseT Transmitter" p.54 ☛ "Optional Accessories" p.252 The projector supports Art-Net. When using Art-Net to control the projector, set Art-Net to On from the Network menu. ☛ Network - Others - Art-Net p.160

Name	Function
⑭ LAN port	Connects a LAN cable to connect to a network. The projector supports Art-Net. When using Art-Net to control the projector, set Art-Net to On from the Network menu. ☛ Network - Others - Art-Net p.160

Control Panel

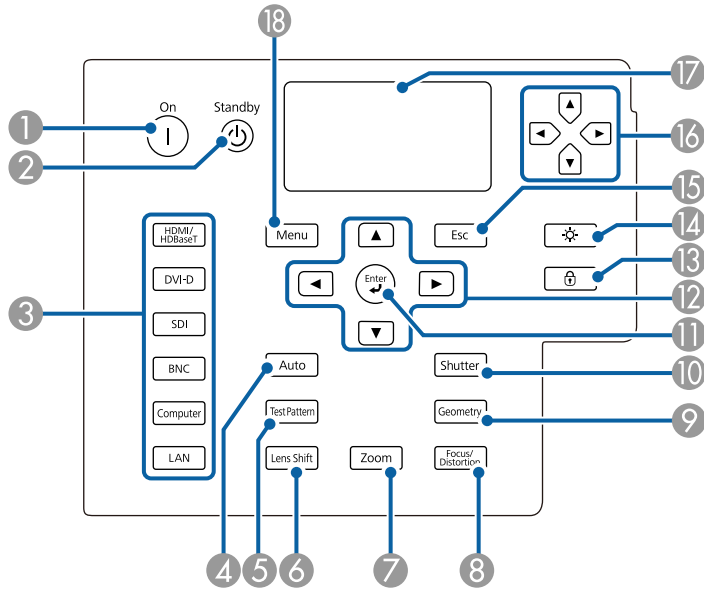

Name	Function
① [①] button	Starts projection when the main power switch is on and the projector is in standby mode.
② [⏻] button	Places the projector in standby mode when the main power switch is on and it is projecting.
③ Change input buttons	Changes to images from each input port. ☛ "Switching to the Target Image" p.61
④ [Auto] button	If pressed while projecting analog RGB signals from the Computer port or the BNC port, you can automatically optimize Tracking, Sync., and Position.
⑤ [Test Pattern] button	Displays a test pattern. ☛ "Displaying the Test Pattern" p.36

Name	Function
⑥ [Lens Shift] button	Press to adjust the lens shift. ☛ "Adjusting the Position of the Projected Image (Lens Shift Adjustment)" p.37 If pressed for more than three seconds, the lens position moves to the home position.
⑦ [Zoom] button	Press to adjust the zoom. ☛ "Adjusting the Image Size" p.39
⑧ [Focus/Distortion] button	Press this to adjust the focus or correct distortion. ☛ "Correcting the Focus" p.40 ☛ "Correcting Distortion (Image Warping)" p.41
⑨ [Geometry] button	Corrects distortion in the projected image. ☛ "Correcting Distortion in the Projected Image" p.62
⑩ [Shutter] button	Press to turn the image on or off temporarily. ☛ "Hiding the Image Temporarily (Shutter)" p.106
⑪ [↵] button	When the Configuration menu or the Help screen is displayed, it accepts and enters the current selection and moves to the next level. ☛ "Configuration Menu Operations" p.137
⑫ [▲][▼][◀][▶] buttons	<ul style="list-style-type: none"> Press to adjust focus, zoom, distortion, and lens shift. <ul style="list-style-type: none"> ☛ "Adjusting the Position of the Projected Image (Lens Shift Adjustment)" p.37 ☛ "Adjusting the Image Size" p.39 ☛ "Correcting the Focus" p.40 If pressed when the Configuration menu or the Help screen is displayed, menu items and setting values are selected. <ul style="list-style-type: none"> ☛ "Configuration Menu Operations" p.137
⑬ [🔒] button	Displays the Control Panel Lock screen allowing you to make settings to lock the control panel buttons. ☛ "Restricting Operation" p.117
⑭ [☀️] button	Press to turn on or off the buttons on the control panel and the LCD display.

Name	Function
15 [Esc] button	<ul style="list-style-type: none"> Stops the current function. If pressed when the Configuration menu is displayed, it returns to the previous menu level. <ul style="list-style-type: none"> "Configuration Menu Operations" p.137
16 [Up][Down][Left][Right] buttons	Select menu items and settings displayed on the LCD display.
17 LCD display	<p>Displays the projector's status by character information.</p> <ul style="list-style-type: none"> "Understanding the Status Information" p.182 <p>Displays the static IP address setting menu.</p> <ul style="list-style-type: none"> "Setting a Static IP Address Using the LCD Display" p.132
18 [Menu] button	<p>Displays and closes the Configuration menu.</p> <ul style="list-style-type: none"> "Configuration Menu Operations" p.137

Remote Control

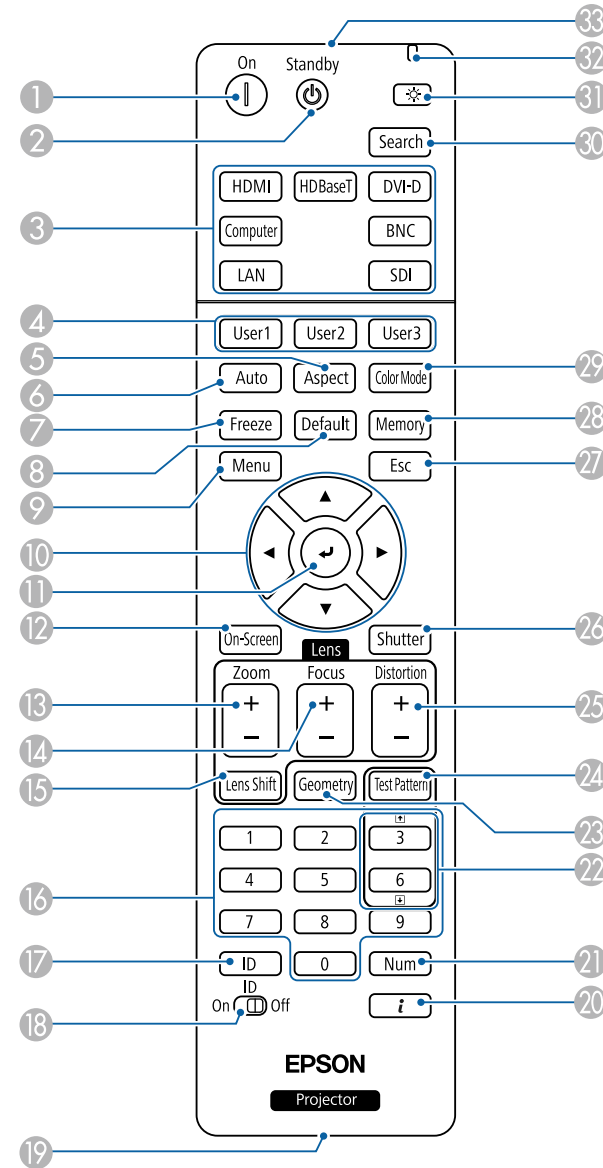

Name	Function
① [⓪] button	Starts projection when the main power switch is on and the projector is in standby mode.
② [Ⓜ] button	Places the projector in standby mode when the main power switch is on and it is projecting.
③ Change input buttons	Changes to images from each input port. ☛ "Switching to the Target Image" p.61
④ [User1] button [User2] button [User3] button	Select any frequently used item from the Configuration menu items, and assign it to any of these buttons. By pressing the button, the assigned menu item selection/adjustment screen is displayed, allowing you to make one-touch settings/adjustments. ☛ "Settings Menu" p.145
⑤ [Aspect] button	Each time the button is pressed, the aspect mode changes. ☛ "Changing the Aspect Ratio of the Projected Image" p.78
⑥ [Auto] button	If pressed while projecting analog RGB signals from the Computer port or the BNC port, you can automatically optimize Tracking, Sync., and Position.
⑦ [Freeze] button	Images are paused or unpaused. ☛ "Freezing the Image (Freeze)" p.107
⑧ [Default] button	Enabled when [Default]: Reset is displayed on the configuration menu guide. The settings being adjusted are returned to their default values. ☛ "Configuration Menu Operations" p.137
⑨ [Menu] button	Displays and closes the Configuration menu. ☛ "Configuration Menu Operations" p.137

Name	Function
⑩ [▲][▼][◀][▶] buttons	<ul style="list-style-type: none"> Press to adjust focus, zoom, distortion, and lens shift. <ul style="list-style-type: none"> ☛ "Adjusting the Position of the Projected Image (Lens Shift Adjustment)" p.37 ☛ "Adjusting the Image Size" p.39 ☛ "Correcting the Focus" p.40 If pressed when the Configuration menu or the Help screen is displayed, menu items and setting values are selected. <ul style="list-style-type: none"> ☛ "Configuration Menu Operations" p.137
⑪ [↵] button	When the Configuration menu or the Help screen is displayed, it accepts and enters the current selection and moves to the next level. ☛ "Configuration Menu Operations" p.137
⑫ [On-Screen] button	Shows or hides the Configuration.
⑬ [Zoom] button	Press to adjust the zoom. ☛ "Adjusting the Image Size" p.39
⑭ [Focus] button	Press to adjust the focus. ☛ "Correcting the Focus" p.40
⑮ [Lens Shift] button	Press to adjust the lens shift. ☛ "Adjusting the Position of the Projected Image (Lens Shift Adjustment)" p.37 If pressed for more than three seconds, the lens position moves to the home position.
⑯ Numeric buttons	<ul style="list-style-type: none"> Enter the Password. <ul style="list-style-type: none"> ☛ "Setting Password Protection" p.115 Use this button to enter numbers in Network settings from the Configuration menu.
⑰ [ID] button	Hold down this button and press the numeric buttons to select the ID for the projector you want to operate using the remote control. ☛ "ID Settings" p.43

Name	Function
18 [ID] switch	Use this switch to enable (On)/disable (Off) ID settings for the remote control. ☛ "ID Settings" p.43
19 Remote port	Connects the optional remote control cable set and outputs signals from the remote control. ☛ "Optional Accessories" p.252 When the remote control cable is plugged into this remote port, the remote control light-emitting is disabled.
20 [i] button	Displays the Info menu from the Configuration menu. ☛ "Info Menu (Display Only)" p.161
21 [Num] button	Hold down this button and press the numeric buttons to enter passwords and numbers. ☛ "Setting Password Protection" p.115
22 [↶] [↷] buttons	<ul style="list-style-type: none"> Changes the test pattern displayed. Moves to the previous or next image file when projecting images from a computer connected via a network.
23 [Geometry] button	Corrects distortion in the projected image. ☛ "Correcting Distortion in the Projected Image" p.62
24 [Test Pattern] button	Displays a test pattern. ☛ "Displaying the Test Pattern" p.36
25 [Distortion] button	Press to correct distortion. ☛ "Correcting Distortion (Image Warping)" p.41
26 [Shutter] button	Press to turn the image on or off temporarily. ☛ "Hiding the Image Temporarily (Shutter)" p.106
27 [Esc] button	<ul style="list-style-type: none"> Stops the current function. If pressed when the Configuration menu is displayed, it moves to the previous level. ☛ "Configuration Menu Operations" p.137

Name	Function
28 [Memory] button	Performs operations and makes settings for the memory function. ☛ "Memory Function" p.109
29 [Color Mode] button	Each time the button is pressed, the Color Mode changes. ☛ "Selecting the Projection Quality (Selecting Color Mode)" p.74
30 [Search] button	Changes to the next input source that is sending an image. ☛ "Automatically Detecting Input Signals and Changing the Projected Image (Source Search)" p.60
31 [☀] button	Illuminates the buttons on the remote control for approximately 15 seconds. This is useful when using the remote control in the dark.
32 Indicator	A light is emitted when outputting remote control signals.
33 Remote control light-emitting area	Outputs remote control signals.

Handy remote control operations

You can perform the following operations by simply pressing one of the buttons on the remote control.

Operation	Set
Reverse the projected image vertically. (Switch the Projection between Front and Front/Ceiling) ☛ "Changing the direction of the image (projection mode)" p.34	Hold down the [Shutter] button for more than five seconds.
Selecting the password security settings. ☛ "Managing Users (Password Protection)" p.115	Hold down the [Freeze] button for more than five seconds. The Password Protection screen is displayed, and you can select various settings.

Operation	Set
Locking or unlocking some of the operation of the buttons on the remote control. ☛ "Remote control button lock" p.118	Hold down the [i] button for more than five seconds.
Initializing the settings for the Remote Receiver in the Configuration menu. (Enables all Remote receivers for this projector.)	Hold down the [Menu] button for more than 15 seconds.
Displaying frequently used Configuration menu items.	Press the [User1], [User2], or [User3] button. You can set the menu item you want to assign to each button in User Button . ☛ Settings - User Button p.145 The following items can be assigned. Light Source Mode, Multi-Projection, Resolution, Display the QR Code, Image Enhancement, Frame Interpolation, Screen Matching, Color Calibration, Help, Split Screen

Replacing the remote control batteries

If delays in the responsiveness of the remote control occur or if it does not operate after it has been used for some time, it probably means that the batteries are becoming flat. When this happens, replace them with new batteries. Have two AA size alkaline or manganese batteries ready. You cannot use other batteries except for the AA size alkaline or manganese.

Attention

Make sure you read the following manual before handling the batteries.

☛ [Safety Instructions](#)

- 1 Remove the battery cover.
While pushing the battery compartment cover catch, lift the cover up.

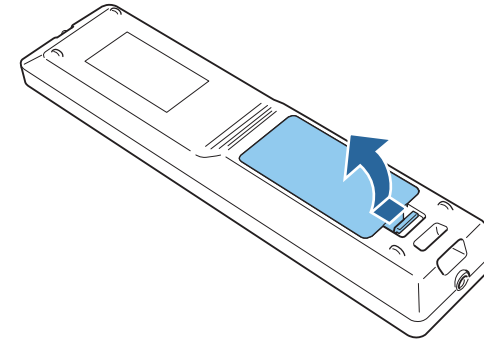

- 2 Replace the old batteries with new batteries.

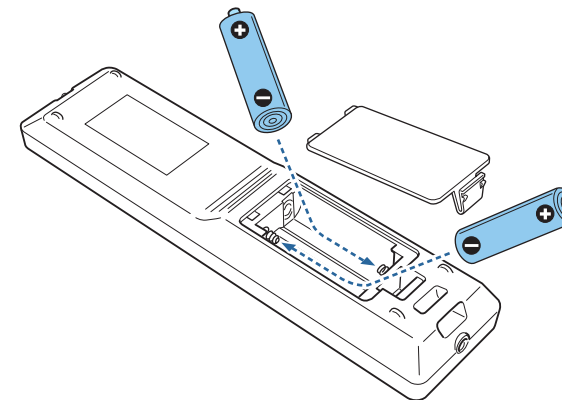

⚠ Caution

Check the positions of the (+) and (-) marks inside the battery holder to ensure the batteries are inserted the correct way.

If the batteries are not used correctly, they could explode or leak causing a fire, injury, or damage to the product.

- 3 Replace the battery cover.
Press the battery compartment cover until it clicks into place.

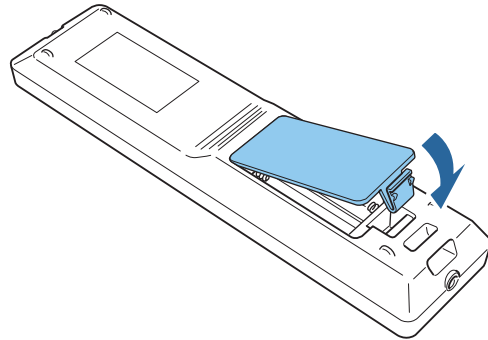

Remote control operating range

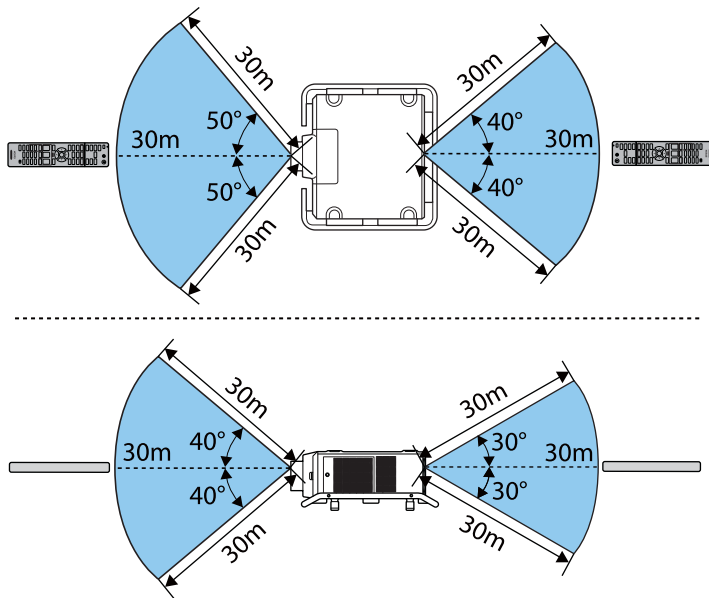

When the handle is installed at the top

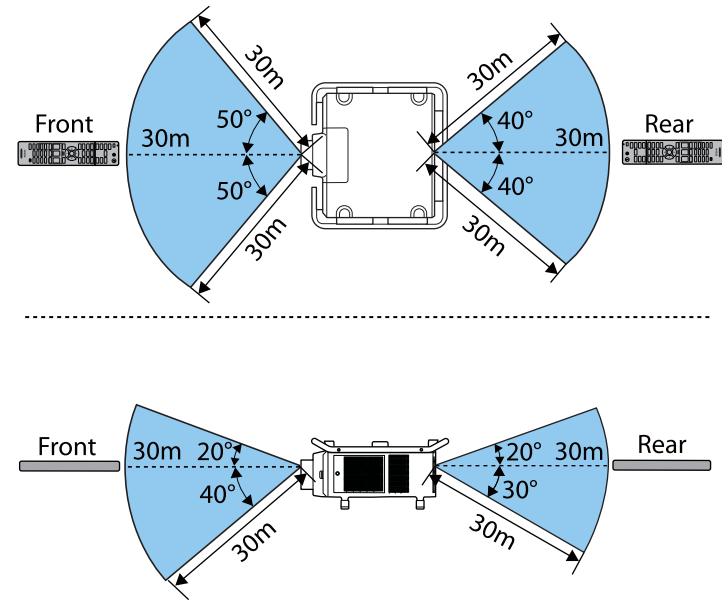

To restrict reception of the operation signals from the remote control, set **Remote Receiver**.
Settings - Remote Receiver [p.145](#)

Connecting a cable to the remote control

You can make operations securely with the optional Remote control cable set when you use multiple units of this projector in the same place or when there are obstacles around the remote receiver.

"Optional Accessories" [p.252](#)

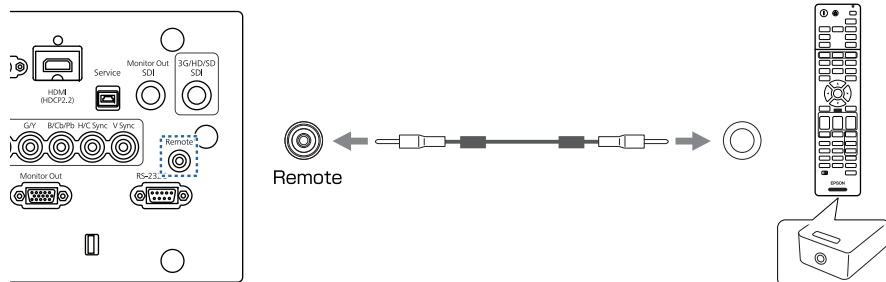

- When the remote control cable is plugged into the Remote port, the remote receiver on the projector is disabled.
- When the remote control cable is plugged into the remote port of the remote control, the remote control indicator does not turn on.
- You can also connect the optional HDBaseT transmitter and remote control with the cable to control the projector.
 - "Connecting an HDBaseT Transmitter" [p.54](#)



Preparing the Projector

This chapter explains how to install the projector and connect projection sources.

Removing and Attaching the Projector Lens Unit

Warning

Make sure you disconnect the power cord from the projector before removing or attaching the lens unit to the projector. Otherwise, it could cause an electric shock.

Attaching

Attention

- Do not attach the lens unit when the projector's lens insertion section is facing up. Dust or dirt could enter the projector.
- Try not to touch the lens section with your hand or fingers. If fingerprints or oils are left on the surface of the lens, projection quality deteriorates.



The projector supports lens with the following model numbers.

ELPLR05/ELPLU05/ELPLW07/ELPLM12/ELPLM13/ELPLM14/
ELPLL09/ELPLL10

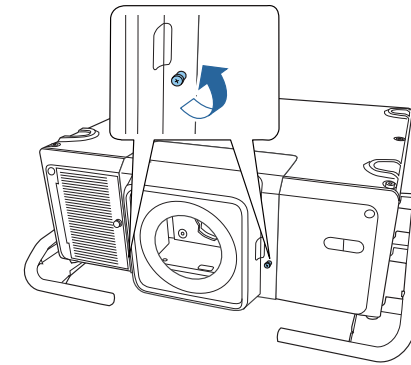

- 2** While pressing the tabs on both sides of the lens replacement cover, pull it towards you to remove it.

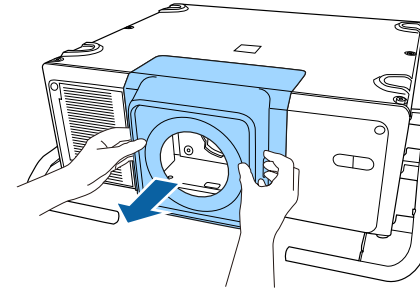

- 3** Turn the lock lever counterclockwise.

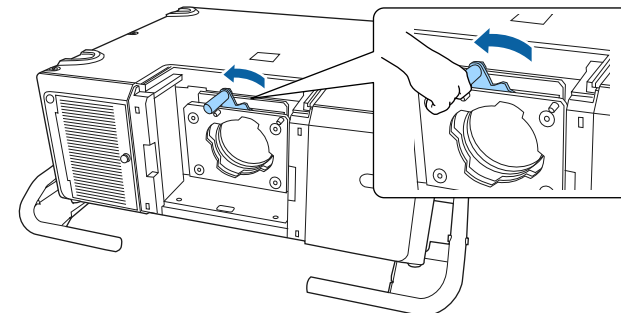

- 1** Loosen the lens cover fixing screws.
Turn the screws by hand.

- 4** Insert the lens unit straight so that the protruding points on the lens fit through the holes (2 points) at the top of the lens unit.

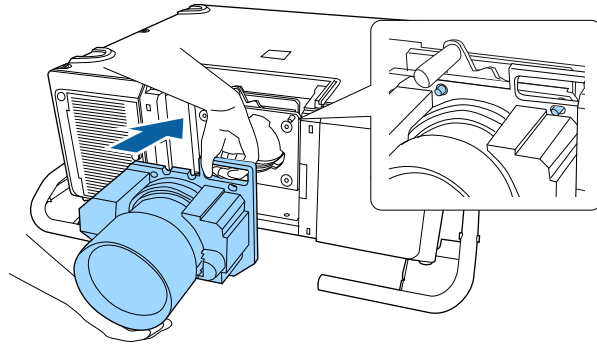

Attention

When attaching the lens unit, do not touch the motor covers shown in the following illustration (2 points). Otherwise, the lens unit may malfunction.

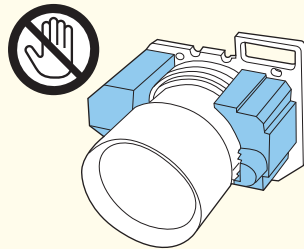

- 5** While holding the lens unit firmly, hold the lock lever and turn it clockwise to lock the lens unit.
Check that the lens cannot be detached.

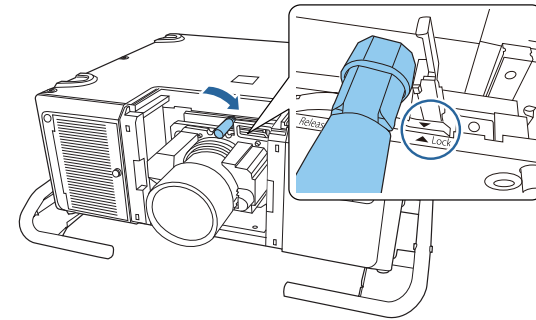

To further secure the lever, tighten the screw. You can turn the screw by hand.

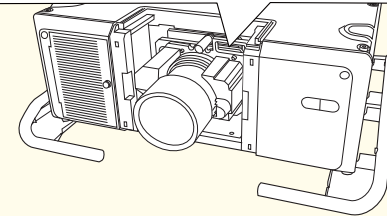
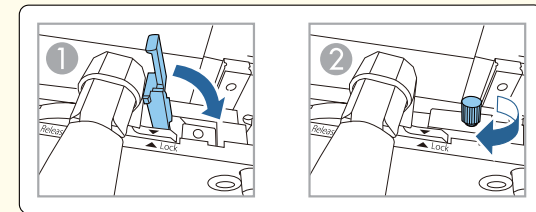

- 6** Attach the lens replacement cover.

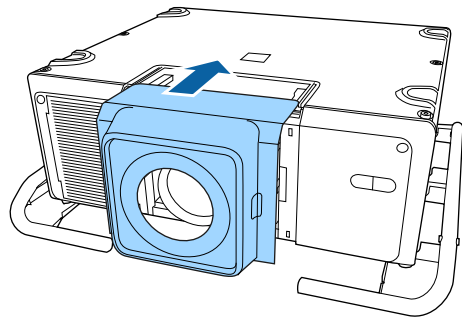

7 Tighten the lens cover fixing screws.

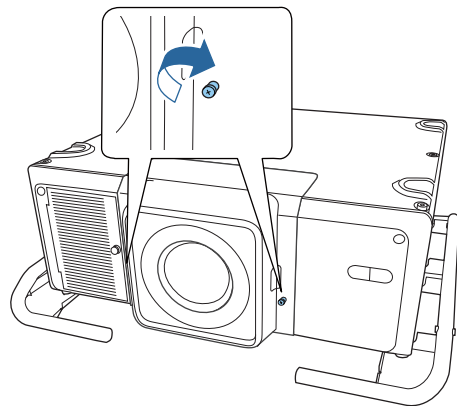

Lens Calibration

After replacing the lens unit, calibrate the lens so that the projector can correctly acquire the lens position and adjustment range.

After attaching a different lens unit from the previous one, a message is displayed when the projector is turned on.

Select **Yes** to calibrate the lens.



Lens calibration takes up to about 3 minutes until it is complete. When the calibration is finished the lens returns to the position before calibration was performed.

Attention

If the message "Lens Calibration failed." is displayed, remove the lens unit and then reinstall it. If the message continues to be displayed, stop using the projector, remove the power plug from the electrical outlet, and contact your local dealer or the nearest address provided in the Epson Projector Contact List.

 [Epson Projector Contact List](#)



- If the projector cannot determine the model number of your lens, you cannot perform lens calibration.
- Use one of the following methods to perform lens calibration.
 - Hold down the [Default] button on the remote control for at least three seconds.
 - Configuration Menu
 -  **Extended - Operation - Lens Calibration p.147**
- If no message is displayed after attaching the lens unit, perform lens calibration from the Configuration menu.
- If you do not calibrate the lens, the following functions may not operate correctly.
 - Lens Shift
 - Memory (Lens Position)
 - Zoom
 - Focus
 - Distortion
- You can check the lens calibration history from the following menu.
 -  **Extended - Operation - Lens Calibration - History p.147**

Removing

Caution

Wait for a while after turning off the projector before removing the lens unit (approximately 30 mins.). Touching the lens unit immediately after projecting or turning off may cause burns.

Attention

If you have used lens shift to move the lens position, move the lens to the home position and then replace the lens unit.

 "Adjusting the Position of the Projected Image (Lens Shift Adjustment)"
[p.37](#)



The projector uses a laser as the light source. As a safety measure, the light source turns off when the lens is removed. Attach the lens, and then press the [I] button to turn it back on.

- 1** Loosen the lens cover fixing screws.
Turn the screws by hand.

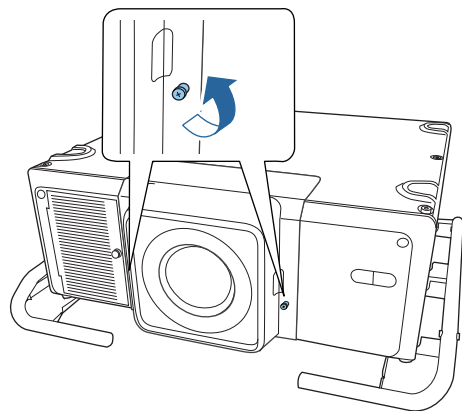

- 2** While pressing the tabs on both sides of the lens replacement cover, pull it towards you to remove it.

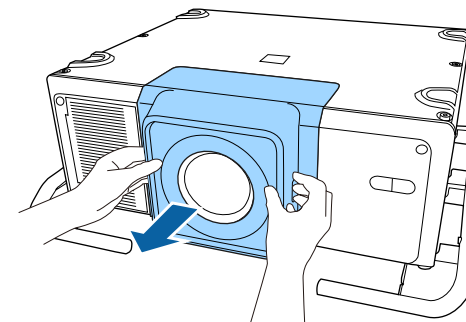

- 3** While holding the lens unit firmly, turn the lock lever counterclockwise until it is unlocked.

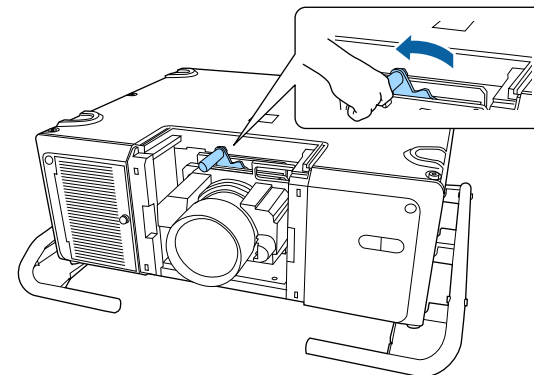



If the lever has been secured with the screw, loosen the screw first.

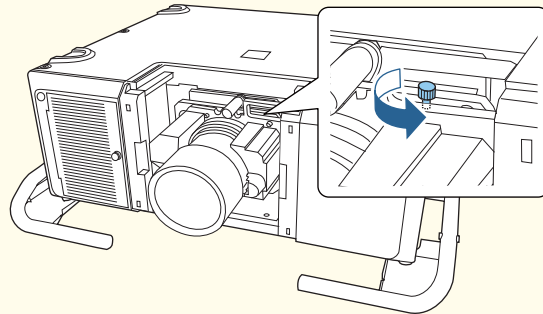

4 Pull the lens unit straight out.

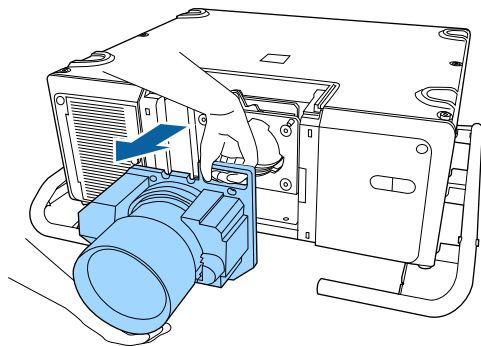

When Front is the standard, the image directions for each projection mode are as follows.

Front (default)



Rear



Front/Ceiling



Rear/Ceiling



- You can change the setting as follows by pressing down the [Shutter] button on the remote control for about five seconds.

Front ↔ Front/Ceiling

Rear ↔ Rear/Ceiling

- To rotate the menu display, set **OSD Rotation** in the Configuration menu.

☛ Extended - Display - OSD Rotation [p.147](#)

Installation Settings

Changing the direction of the image (projection mode)

You can change the direction of the image using **Projection** mode from the Configuration menu.

☛ Extended - Projection [p.147](#)

Screen Settings

Set the Screen Type according to the aspect ratio of the screen being used.

The area where the image is displayed matches the shape of the screen.



The setting for the **Screen Type** at the time of purchase is **16:10**.

- 1** Press the [Menu] button while projecting.
 "Configuration Menu Operations" [p.137](#)
- 2** Select **Display** from **Extended**.
- 3** Select **Screen Type** from **Screen**.
- 4** Select the screen's aspect ratio.

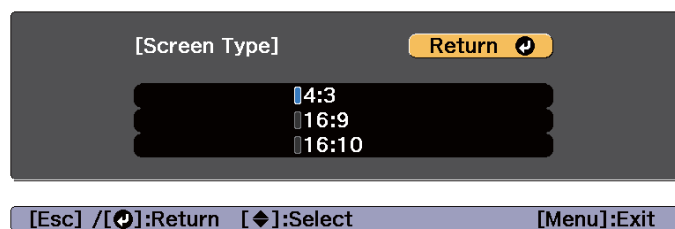

- The shape of the background test pattern changes depending on the setting.
- The **EDID** changes depending on the setting. When a message is displayed, select **Yes**.



- When you change the **Screen Type**, adjust the aspect ratio for the projected image as well.
 "Changing the Aspect Ratio of the Projected Image" [p.78](#)
- The Message Broadcasting function for Epson Projector Management does not support this function.

Adjusting the position of the image on the projected screen

You can adjust the position of the image if there are margins between the edge of the image and the projected screen frame due to the **Screen Type** setting.

Example: When the **Screen Type** is set to **4:3**



You can move the image to the left and right.

- 1** Press the [Menu] button while projecting.
 "Configuration Menu Operations" [p.137](#)
- 2** Select **Display** from **Extended**.
- 3** Select **Screen Position** from **Screen**.
- 4** Use the [**▲**], [**▼**], [**◀**], and [**▶**] buttons to adjust the position of the image.

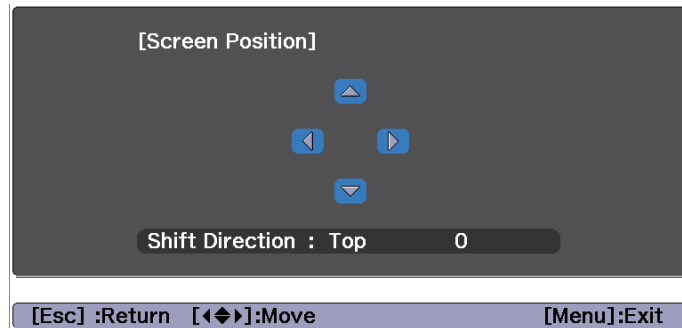

 You can check the current display position by using the background test pattern.

5 Press the [Menu] button to finish making settings.

 When the **Screen Type** is set to **16:10**, the **Screen Position** cannot be adjusted.



Press the [Test Pattern] button again to display the screen for selecting the type of test pattern.

2 You can switch test patterns by pressing the [↑] [↓] buttons on the remote control or the [↵] button on the control panel while a test pattern is displayed.

Using the remote control

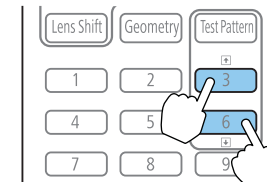

Using the control panel

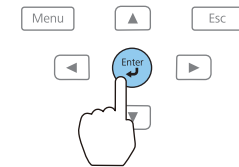

Displaying the Test Pattern

A test pattern can be displayed to adjust the projection status without connecting video equipment.

The shape of a test pattern is according to the setting of **Screen Type**. Set **Screen Type** first.

 "Screen Settings" [p.34](#)

1 Press the [Test Pattern] button of the remote control or the control panel while projecting.

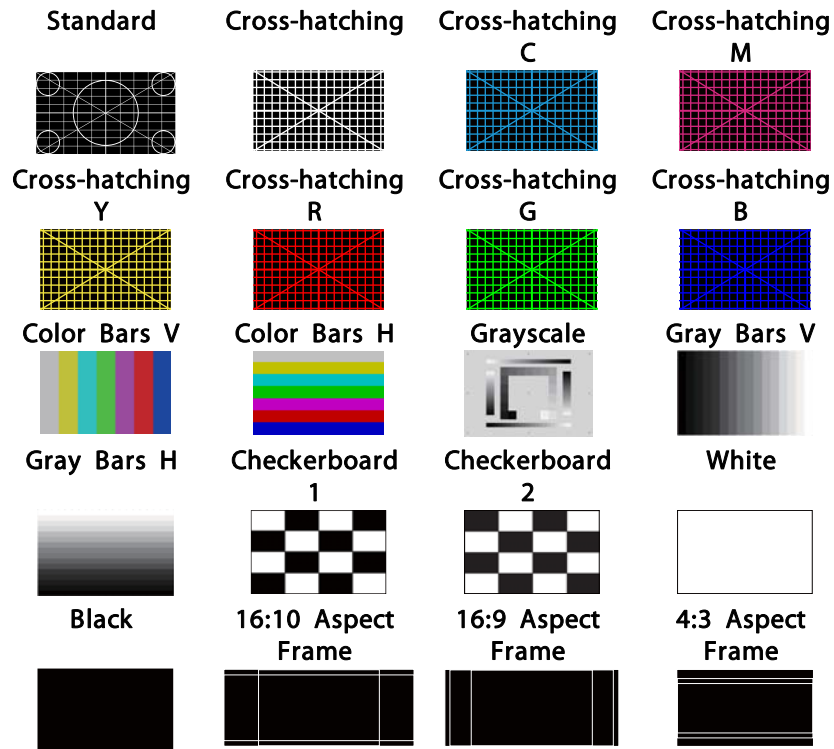

- To set menu items that cannot be set while the test pattern is being displayed or to fine-tune the projected image, project an image from the connected device.
- You can also select a test pattern from the Configuration menu.
 - Settings - Test Pattern p.145

3 Press the [Esc] button to close the test pattern.

Adjusting the Position of the Projected Image (Lens Shift Adjustment)

The lens can be shifted to adjust the position of the projected image, for example, when the projector cannot be installed directly in front of the screen.

The ranges within which the image can be moved are shown below. The position of the projected image cannot be moved to both the horizontal and vertical maximum values.

When using the ELPLR05

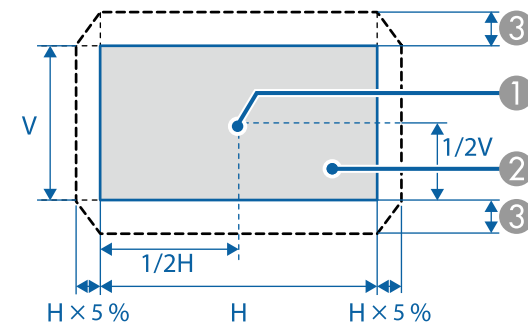

- Center of lens
 - Projected image when the lens position is moved to the home position
 - Maximum motion range: $V \times 15\%$
- * When the horizontal direction is at the maximum value, the image cannot be moved up or down.

When using ELPLU05/ELPLL09/ELPLL10

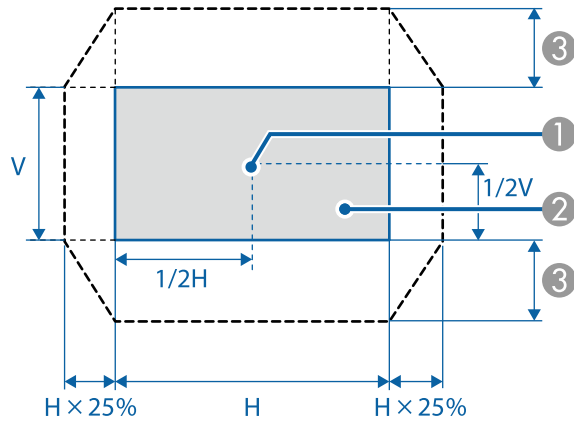

- ① Center of lens
- ② Projected image when the lens position is moved to the home position
- ③ Maximum motion range: $V \times 55\%$ *

* When the horizontal direction is at the maximum value, the image cannot be moved up or down.

When using the ELPLW07/ELPLM12/ELPLM13/ELPLM14

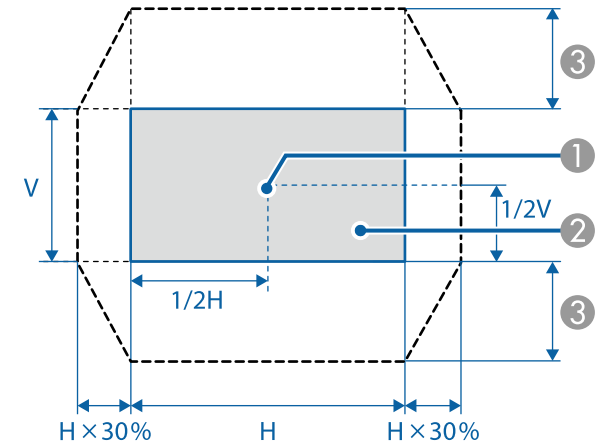

- ① Center of lens
- ② Projected image when the lens position is moved to the home position
- ③ Maximum motion range: $V \times 65\%$ *

* When performing screen matching: $V \times 60\%$ (ELPLM13)

* When the horizontal direction is at the maximum value, the image cannot be moved up or down.



- When adjusting the image height with the vertical lens shift, adjust by moving the image from the bottom to the top. If it is adjusted from the top to the bottom, the image position may move down slightly after adjusting.
- We recommend setting the focus, zoom, and lens shift at least 20 minutes after you start the projection, because images are not stable right after turning on the projector.
- The image will be clearest when the lens position is moved to the home position.
- If you hold down the [Lens Shift] button on the remote control or the control panel for at least three seconds, the lens position moves to the home position.
- If you set **A/V Output** to **Always On**, you can move the lens position to the home position even if the projector is in standby mode.

☛ **Extended - A/V Settings - A/V Output** p.147

1 Press the [Lens Shift] button on the remote control or the control panel.

Using the remote control

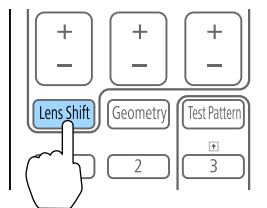

Using the control panel

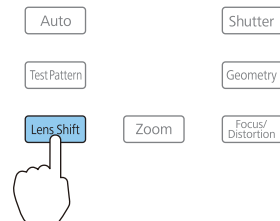

2 Press the [▲][▼][◀][▶] buttons to adjust the position of the projected image.

Using the remote control

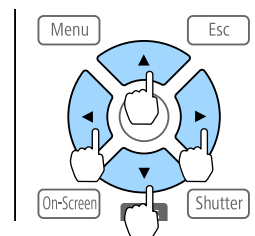

Using the control panel

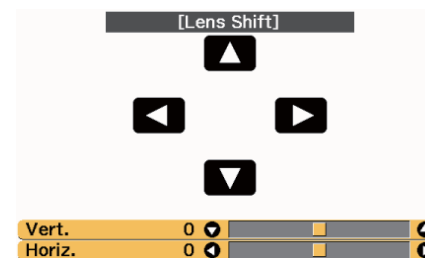
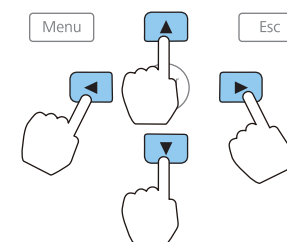

The displayed screen may differ depending on your lens.

3 Press the [Esc] button to finish the adjustment.

Adjusting the Image Size



This is not available for the ELPLR05.

- 1 Press the [Zoom] button on the control panel.

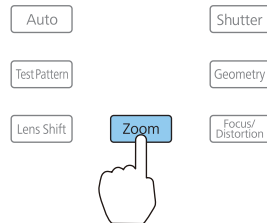

- 2 Press the [◀][▶] buttons to adjust.

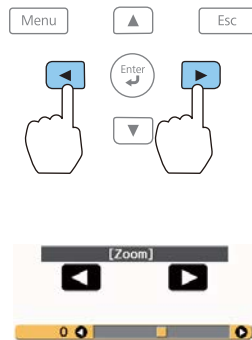

The displayed screen may differ depending on your lens.

- 3 Press the [Esc] button to finish the adjustment.



You can also use the [Zoom] buttons ([+] and [-]) on the remote control to adjust the size of the image.

Correcting the Focus

- 1 Press the [Focus/Distortion] button on the control panel.
Press repeatedly until the focus adjustment screen is displayed.

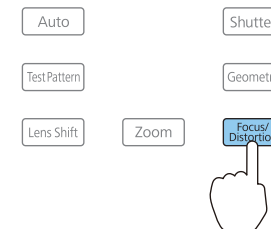

- 2 Press the [◀][▶] buttons to adjust.

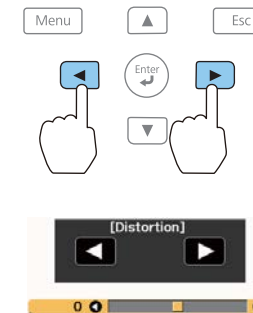

The displayed screen may differ depending on your lens.



When using the following lens, a message prompting you to adjust the distortion (image warping) is displayed. After adjusting the focus, adjust the distortion.

ELPLR05, ELPLU05

☞ "Correcting Distortion (Image Warping)" [p.41](#)

- 3 Press the [Esc] button to finish the adjustment.



- You can also use the [Focus] buttons ([+] and [-]) on the remote control to adjust the focus.
- When projecting from several projectors and there is a difference in brightness, we recommend displaying the grayscale test pattern and adjusting the focus.
- If the focus is not correct even after adjusting the focus, hold down the [Default] button on the remote control for about three seconds to perform lens calibration. When lens calibration is complete, adjust the focus again.

Correcting Distortion (Image Warping)

When using the ELPLR05 or ELPLU05 and focusing at the center of the screen, the surrounding image may warp and be out of focus. Follow the steps below to correct the warping.

- 1** Press the [Focus/Distortion] button on the control panel.
Press repeatedly until the focus adjustment screen is displayed.
- 2** Press the [◀][▶] buttons to focus the image around the center of the lens.

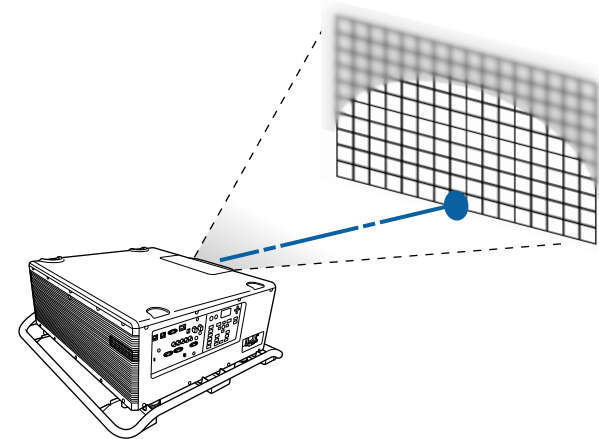

- 3** Press the [Focus/Distortion] button on the control panel again.
Press repeatedly until the distortion adjustment screen is displayed.
- 4** Press the [◀][▶] button to adjust the focus of the surrounding area.

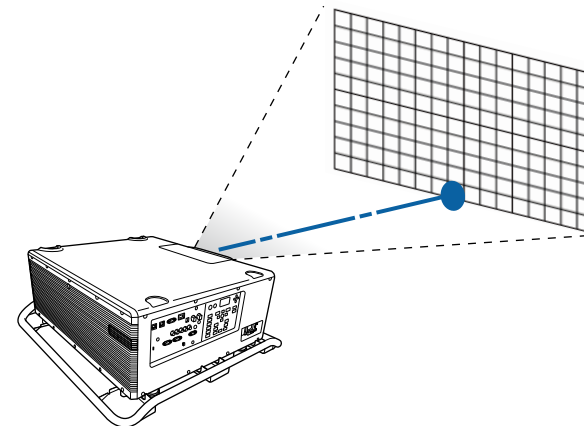

If the center is out of focus after adjusting the surrounding image, repeat steps 1 to 2.



You can also adjust distortion in images using the remote control. After adjusting the focus at the center of the lens using the [Focus] buttons ([+] and [-]), use the [Distortion] buttons ([+] and [-]) to adjust the surrounding image.

Registering and Loading Lens Adjustment Values

You can register a lens position whose lens shift, zoom, focus, and distortion was adjusted in memory, and load it when necessary. You can register up to 10 values.



- If you did not calibrate your lens, a message is displayed when you save a memory. Select **Yes** to calibrate the lens.
 - The lens position when a memory is loaded may not completely match the lens position when the memory was saved.
 - If there is a large discrepancy between the lens position when a memory is loaded and the lens position when the memory was saved, calibrate the lens.
- ☛ **Extended - Operation - Lens Calibration** [p.147](#)

1 Press the [Memory] button while projecting.

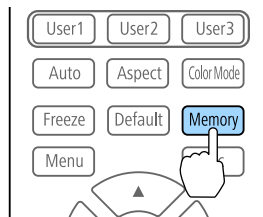

You can also operate from the Configuration menu.

☛ **Settings - Memory** [p.145](#)

2 Select **Lens Position**, and then press the [**↵**] button.

3 Select the function you want to perform, then press the [**↵**] button.

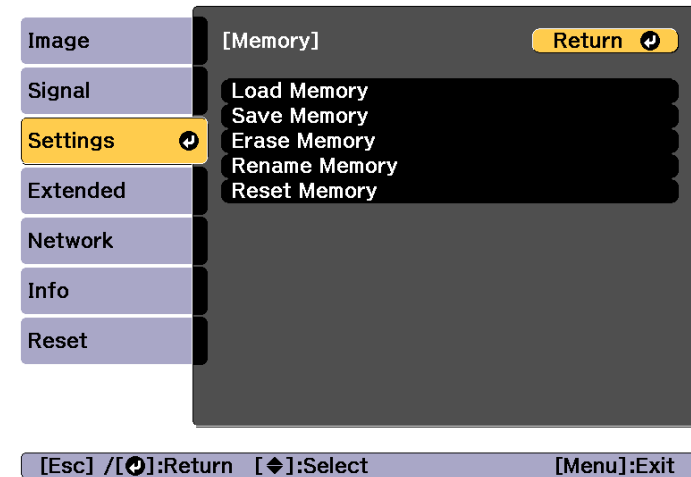

Function	Explanation
Load Memory	Loads the saved memory. When you select a memory name and press the [↵] button, the lens is automatically adjusted according to the settings of the selected memory.
Save Memory	Registers current settings in the memory. When you select a memory name and press the [↵] button, the settings are saved.
Erase Memory	Erases the registered memory. When you select a memory name and press the [↵] button, a message is displayed. Select Yes , and then press the [↵] button to erase the selected memory.

Function	Explanation
Rename Memory	<p>Changes the memory name. Select the memory name you want to change, and then press the [↵] button. Enter the memory name using the soft keyboard.</p> <p>☛ "Soft keyboard operations" p.153</p> <p>When you have finished, move the cursor over Finish, and then press the [↵] button.</p>
Reset Memory	Resets the name and settings of a saved memory.



If the mark on the left of the memory name is turned blue, it means the memory has already been registered. When you select a registered memory, a message is displayed asking you to confirm that you want to overwrite the memory. If you select **Yes**, the previous settings are deleted and the current settings are registered.



- Operation using the remote control is possible only for projectors that are within the operating range of the remote control.
 - ☛ "Remote control operating range" p.27
- IDs are ignored when the projector ID is set to **Off** or the remote control ID is set to **0**.
- If you use Epson Web Control, you can operate a specific projector from a mobile device.
 - ☛ "Changing Settings Using a Web Browser (Epson Web Control)" p.230

ID Settings

When an ID is set for the projector and the remote control, you can use the remote control to operate only the projector with a matching ID. This is very useful when managing multiple projectors. You can set up to 30 IDs.

Set the projector ID

- 1 Press the [Menu] button while projecting.
 - ☛ "Configuration Menu Operations" p.137
- 2 Select **Multi-Projection** from **Extended**.
- 3 Select **Projector ID**, and then press the [↵] button.
- 4 Press the [◀][▶] buttons to select an ID number.

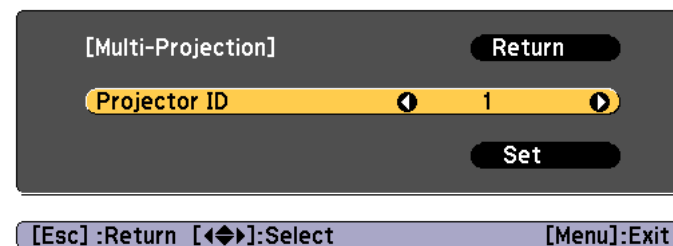

- 5 Select **Set**, and then press the [↵] button.
- 6 Press the [Menu] button to close the Configuration menu.

Checking the projector ID

During projection, press the [i] button while holding down the [ID] button on the remote control.

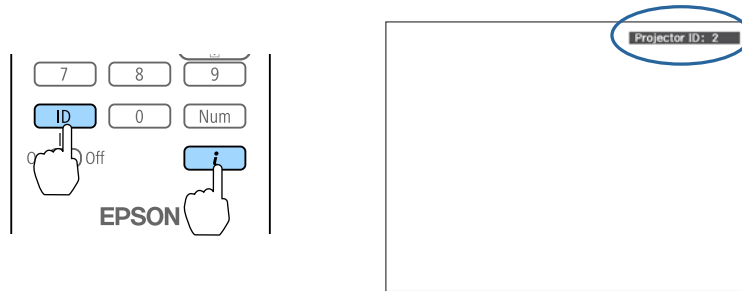

When you press the buttons, the current Projector ID is displayed on the projection screen. It disappears in about three seconds.

Setting the remote control ID

- 1 Set the remote control [ID] switch to On.

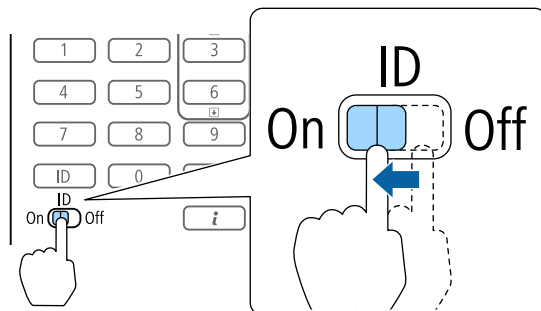

- 2 While holding the [ID] button, press a number button to select a number to match the ID of the projector you want to operate.

☛ "Checking the projector ID" p.44

Enter a two digit number (Example: 01 when the ID is 1).

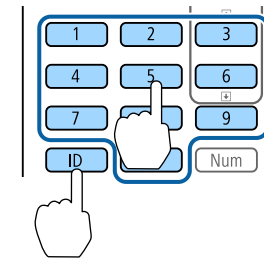

Once this setting has been made, the projector that can be operated by the remote control is limited.



The remote control ID setting is saved in the remote control. Even if the remote control batteries are removed to replace them and so on, the stored ID setting is retained. However, if the batteries are left out for a long time, it is reset to the default value (ID0).

Setting the Time

You can set the time for the projector. The set time is used for the schedule function.

☛ "Scheduling Function" p.111



- When you turn on the projector for the first time, the message "Do you want to set the time?" is displayed. When you select **Yes**, the screen from step 4 is displayed.
- When **Schedule Protection** is set to **On** in **Password Protection**, settings related to the date and time cannot be changed. You can make changes after setting **Schedule Protection** to **Off**.
 "Managing Users (Password Protection)" [p.115](#)

- 1** Press the [Menu] button while projecting.
 "Configuration Menu Operations" [p.137](#)
- 2** Select **Operation** from **Extended**.
- 3** Select **Date & Time**, and then press the [**↵**] button.
- 4** Make settings for the date and time.
 Use the soft keyboard to enter the date and time.
 "Soft keyboard operations" [p.153](#)

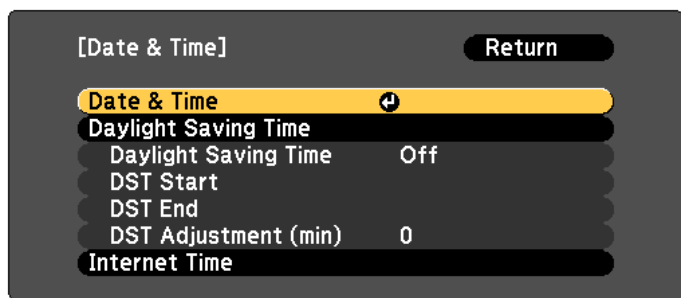

Date & Time

Submenu	Function
Date	Set today's date.
Time	Set the current time.

Submenu	Function
Time Difference (UTC)	Set the time difference from Coordinated Universal Time.
Settings	The settings made in Date & Time are applied.

Daylight Saving Time

Submenu	Function
Daylight Saving Time	Set whether or not (On/Off) to activate the daylight saving time. DST Adjustment (min) adjusts the time difference between the standard time and daylight saving time.
DST Start	Set the date and time to start the daylight saving time.
DST End	Set the date and time to end the daylight saving time.
Settings	The settings made in Daylight Saving Time are applied.

Internet Time

Submenu	Function
Internet Time	Set to On to update the time automatically through an Internet time server.
Internet Time Server	Input the IP address for an Internet time server.
Settings	The settings made in Internet Time are applied.





When changing settings, make sure you select **Set**, and then press the [**↵**] button.





- 5** Press the [Menu] button to finish making settings.

Other Settings

Settings related to basic operations

Purpose	Setting Methods
To start/stop projection by turning on/off the main power switch or plugging in or unplugging the power plug of the projector.	<ul style="list-style-type: none"> When Direct Power On is set to On, the projector can start projecting when power is supplied. (Default value: Off)  Extended - Operation - Direct Power On p.147 The projector can be powered off directly by the breaker because it supports the direct shutdown function.
To disable buzzer beeps generated when the projector is powered on/off.	Set Beep to Off . (Default value: On)  Extended - Operation - Advanced - Beep p.147
Turn off the power by pressing the [⏻] button once.	Set Standby Confirmation to Off . (Default value: On)  Extended - Display - Standby Confirmation p.147

Settings related to display

Purpose	Setting Methods
To change the menu position.	Change the settings of Menu Position .  Extended - Display - Menu Position p.147
To change the menu direction.	Change the settings of OSD Rotation .  Extended - Display - OSD Rotation p.147
To prevent the display of menus, messages, or warnings on the screen.	Press the [On-Screen] button on the remote control to show/hide menus or messages. You can also display hidden settings by holding down the [Menu] button on the control panel or the remote control for three seconds. While menus are hidden, you cannot operate the Configuration menu (except switching the color mode and input source).
To disable the display of the message on the projection screen when switching the source.	Set Messages to Off . (Default value: On)  Extended - Display - Messages p.147 You can confirm warning by the display of the indicator.  "Reading the Indicators" p.175 Dialogs related to operations and behaviors, laser warnings, termination of the Message Broadcasting function for Epson Projector Management, and projector ID are displayed.
To register and save the settings of the projected image.	Set Memory .  "Memory Function" p.109 You can save the following settings. <ul style="list-style-type: none"> Memory: Some settings in the Configuration menu Lens Position: Adjustment values of the lens shift, zoom, focus, and distortion Geometry Correction: Adjustment value of the geometry correction

Purpose	Setting Methods
To change the screen displayed on the background.	<p>Change from Display. You can select from blue, black, and logo. If no logo is registered, the EPSON logo is displayed.</p> <p>Display Background: Set the screen display with no image signal input. (Default value: Blue)</p> <p>☛ Extended - Display - Display Background p.147</p> <p>Startup Screen: Set whether or not (On/Off) to display the user logo when the projector is turned on. (Default value: On)</p> <p>☛ Extended - Display - Startup Screen p.147</p>
To turn off the LCD display or control panel buttons	<p>Set Lighting Time to Off on the LCD display.</p> <p>☛ "Setting the screen display (LCD)" p.184</p>

The port name, location, and connector orientation differ depending on the source being connected.

Connecting a Computer

To project images from a computer, connect the computer using one of the following methods.

- 1 When using a commercially available computer cable**
Connect the computer's display output port to the projector's Computer port.
- 2 When using a commercially available 5BNC cable**
Connect the computer's display output port to the projector's BNC port.
- 3 When using a commercially available HDMI cable**
Connect the HDMI port on the computer to the projector's HDMI port.
- 4 When using a commercially available DVI-D cable**
Connect the DVI-D port on the computer to the projector's DVI-D port.

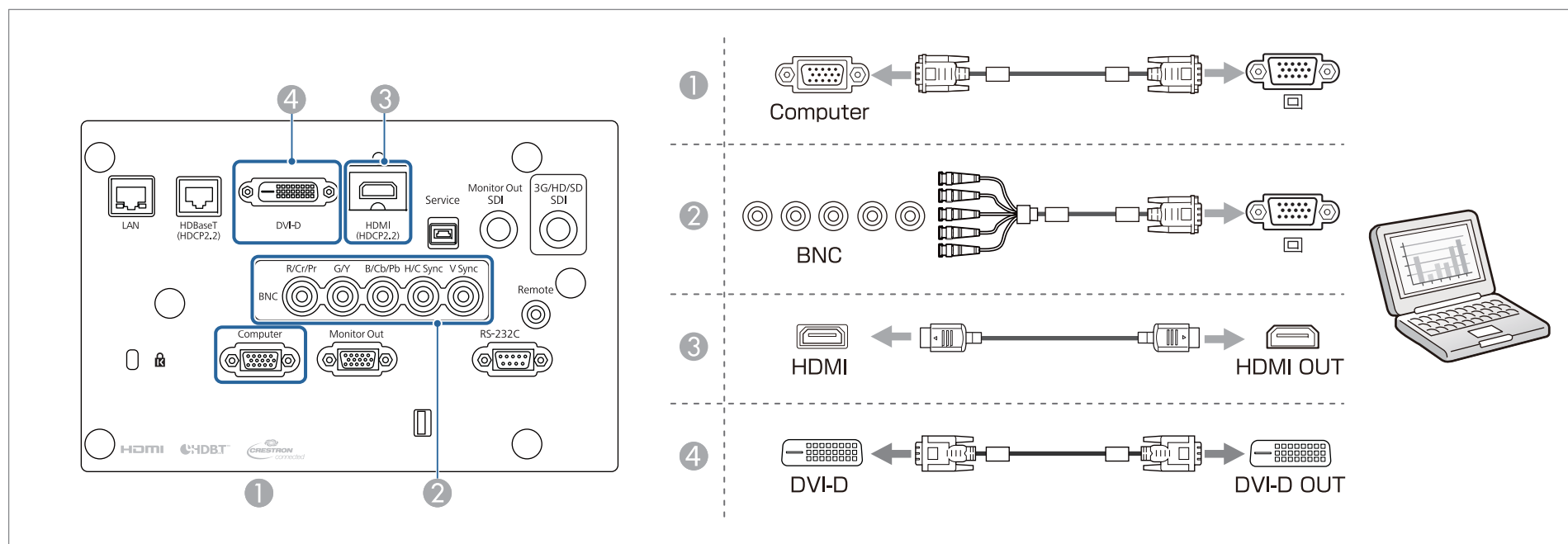



- If the source you want to connect to has an unusually shaped port, use the cable supplied with the device or an optional cable to connect to the projector.
- Make sure the HDMI cable conforms to the HDMI standard. If you use a cable that does not conform to the HDMI standard, images may not be displayed correctly.
- When using the power port for an optical HDMI cable, connect it to the USB-A port.
- Images may not be displayed correctly depending on the length and performance quality of the HDMI cable.
- Make sure the cable you are using is as short as possible. Images may not display correctly when using a long cable.

Connecting Image Sources

To project video images, connect to the projector using one of the following methods.

- ① **When using a commercially available component video cable (D-sub/component converter)**
Connect the component output port on the image source to the projector's Computer port.
- ② **When using a commercially available component video cable (RCA) and a BNC/RCA adapter**
Connect the component output port on the video equipment to the projector's BNC port (R/Cr/Pr, G/Y, B/Cb/Pb).
- ③ **When using a commercially available BNC video cable (SDI input)**
Connect the SDI port on the image source to the projector's 3G/HD/SD SDI port.
- ④ **When using a commercially available HDMI cable**
Connect the HDMI port on the image source to the projector's HDMI port.

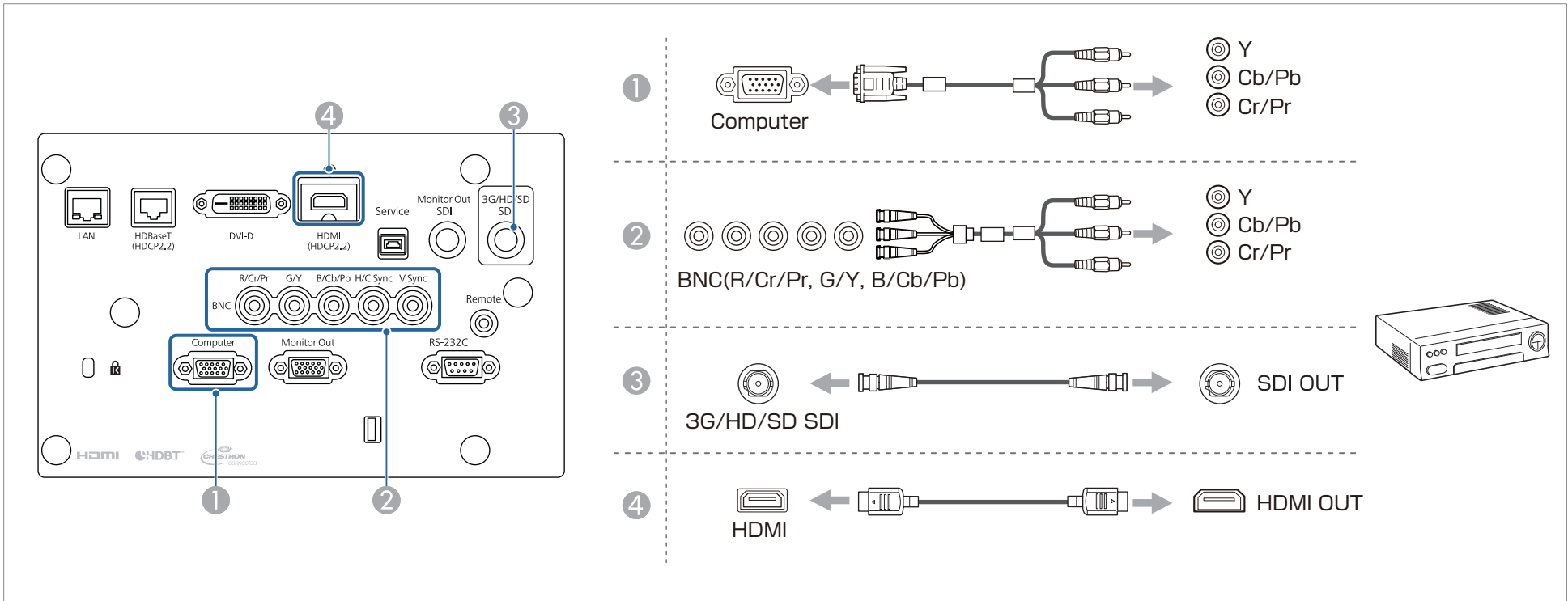

Attention

- If the input source is on when you connect it to the projector, it could cause a malfunction.
- If the orientation or shape of the plug differs, do not try to force it in. The device could be damaged or could malfunction.



- If the source you want to connect to has an unusually shaped port, use the cable supplied with the device or an optional cable to connect to the projector.
- Make sure the HDMI cable conforms to the HDMI standard. If you use a cable that does not conform to the HDMI standard, images may not be displayed correctly.
- When using the power port for an optical HDMI cable, connect it to the USB-A port.
- Images may not be displayed correctly depending on the length and performance quality of the HDMI cable.
- You can set the signal from the 3G/HD/SD SDI port in **SDI Settings**.
-  **Extended - SDI Settings** [p.147](#)
- Make sure the cable you are using is as short as possible. Images may not display correctly when using a long cable.

Connecting to an External Monitor

You can output images to an external monitor.

- ① **When you want to output images from equipment connected to the Computer port or the BNC port**
Connect the D-Sub port on the external monitor to the Monitor Out port on the projector.
- ② **When you want to output images from equipment connected to the 3G/HD/SD SDI port**
Connect the SDI OUT port on the external monitor to the Monitor Out SDI port on the projector.

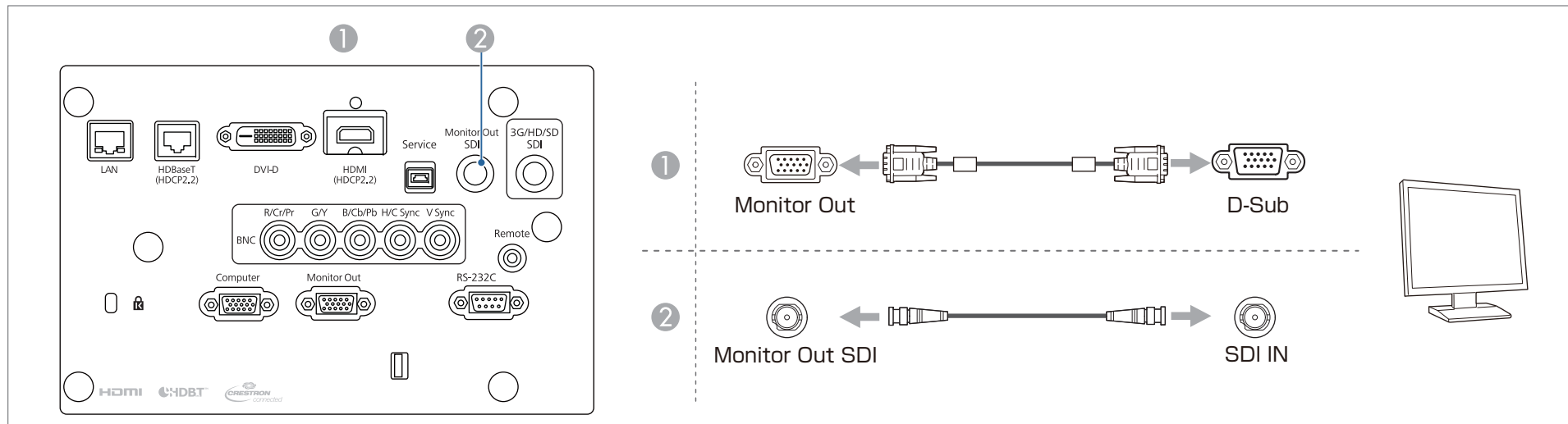

- Make the following settings to output image even when the projector is in standby mode.
Set **A/V Output** to **Always On**.
 - ☛ **Extended - A/V Settings - A/V Output** [p.147](#)
- The Monitor Out port to which external monitors are connected can output analog RGB signals that are being input to the Computer port or the BNC port. You can set which signals to output in **Monitor Out**.
 - ☛ **Extended - A/V Settings - Monitor Out** [p.147](#)

Connecting a LAN Cable

Connect a LAN port on network hubs or other equipment to the projector's LAN port with a commercially available 100BASE-TX or 10BASE-T LAN cable.

By connecting a computer to the projector over a network, you can project images and check the status of the projector.

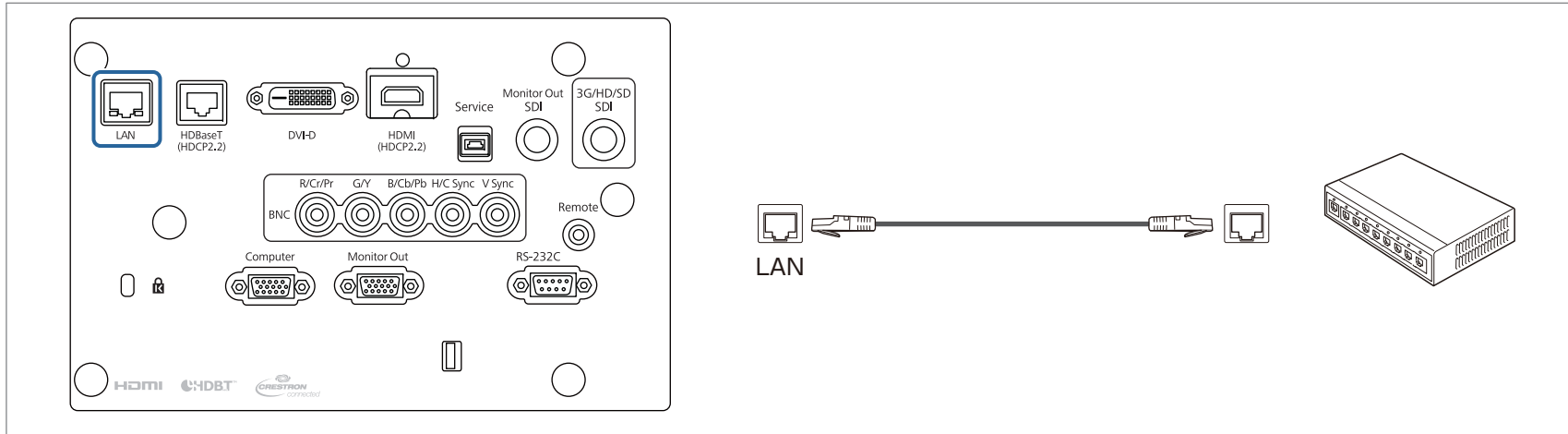

To prevent malfunctions, use a category 5 or higher shielded LAN cable.

Connecting an HDBaseT Transmitter

Connect the optional HDBaseT Transmitter with a commercially available 100BASE-TX LAN cable.

☛ "Optional Accessories" [p.252](#)

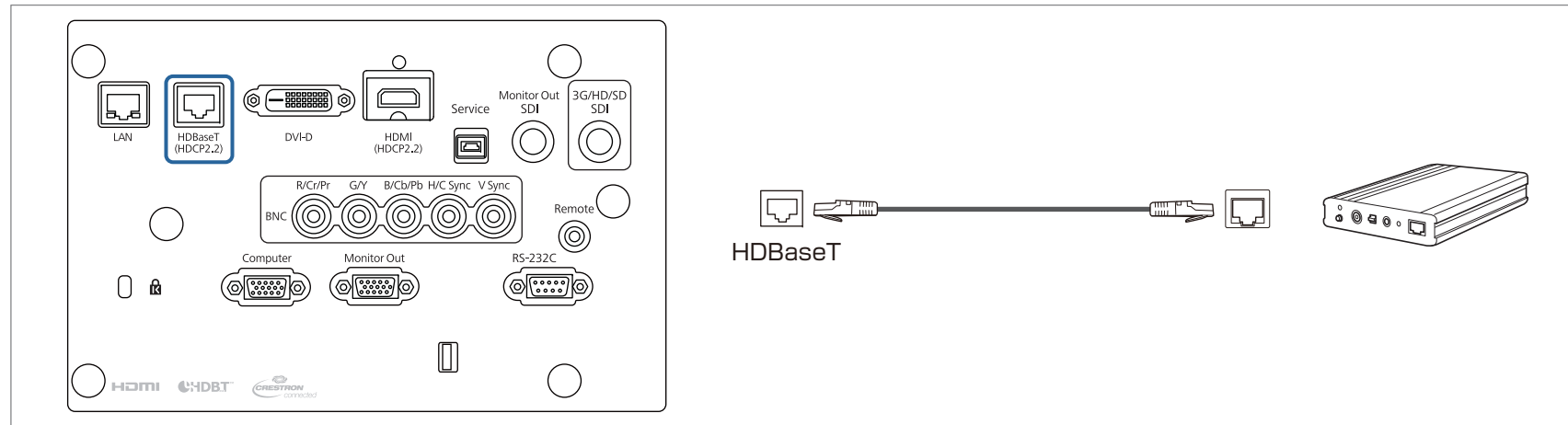

- Make sure you read the User's Guide supplied with the HDBaseT Transmitter carefully before use.
- For the LAN cable, use an HDBaseT Alliance-recommended STP cable (straight) of category 6 or higher. However, operation is not guaranteed for all input/output devices and environments.
- When connecting or disconnecting the LAN cable, make sure you turn off the power for the projector and the HDBaseT Transmitter.
- When performing Ethernet communication or serial communication, or when using the wired remote control via HDBaseT port, set **Control Communications** to **On** from the Configuration menu. The **Standby Mode** is automatically set to **Communication On**.
 - ☛ **Extended - HDBaseT - Control Communications** [p.147](#)

Note that when **Control Communications** is set to **On**, the projector's LAN port, RS-232C port, and Remote port are disabled.
- When using the Extron XTP transmitter or switcher, connect to the projector's HDBaseT port. Set **Extron XTP** to **On** (**Control Communications** is automatically set to **On**, and **Standby Mode** is automatically set to **Communication On**).
 - ☛ **Extended - HDBaseT - Extron XTP** [p.147](#)
- You can check the status of the signal being input to the HDBaseT port in **HDBaseT Signal Level**.
 - ☛ **Info - Projector Info - HDBaseT Signal Level** [p.161](#)

Installing the Wireless LAN Unit

- 1 Remove the screw for the USB-A port cover.

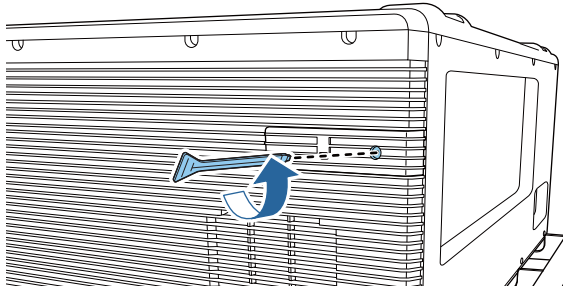

- 2 Remove the USB-A port cover.

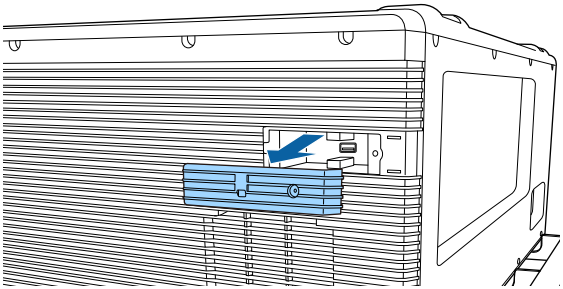

- 3 Install the Wireless LAN unit.

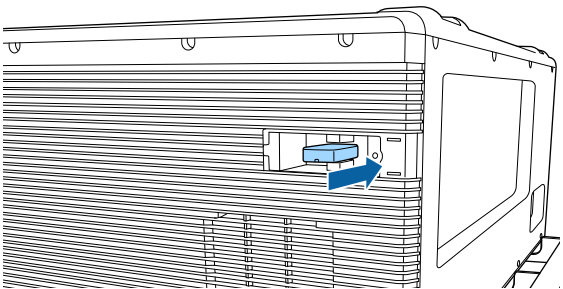

- 4 Replace the USB-A port cover.

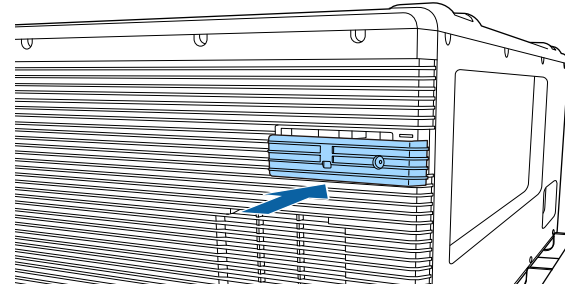

- 5 Secure the screw for the USB-A port cover.

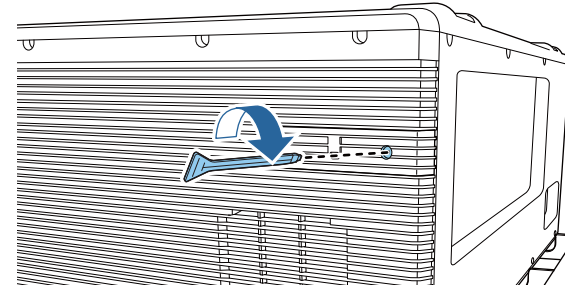

You can make wireless LAN connection settings in the **Wireless LAN** menu from the Configuration menu.

☛ **Network - Network Configuration - Wireless LAN** [p.154](#)



Basic Usage

This chapter explains how to project and adjust images.

Before turning on the projector, connect your computer or video equipment to the projector.

☛ "Connecting Equipment" p.48

Attention

Install the current breaker for 13 A to 20 A to the wiring in the building that supplies electricity to the projector. Do not connect other devices to the wiring where the current breaker is installed, and use the wiring only for the projector.

- 1 Connect the projector to the power outlet using the power cord, and then attach the cable holder.

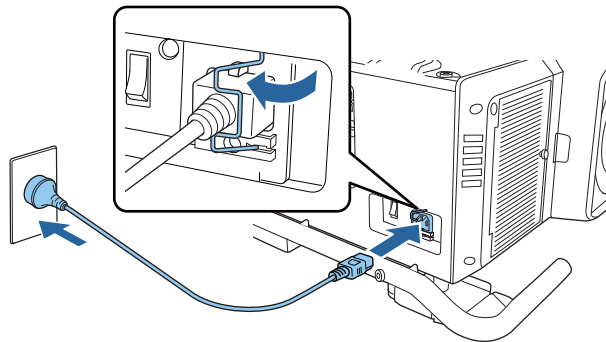

Warning

- There are two types of power cord supplied with the projector, 100 V and 200 V, depending on your country or region. The power cord you need to use may differ depending on your operating environment. Contact a specialist to provide information on handling the power cord.



You can use the 100 V power cord to operate the projector temporarily to determine the installation location. When projecting using the 100 V power cord, the brightness of the projected image is approximately 30% compared to when using a 200 V power cord. Use the 200 V power cord when adjusting the projected image or the lens.

You cannot use the following functions with the 100 V power cord.

- Light Source Mode
- Estimated Remains
- Refresh Mode
- Light Source Calibration

- 2 Turn on the main power switch to supply power to the projector.

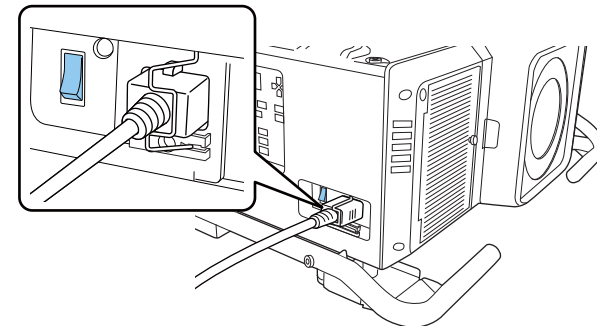

The projector's power indicator turns blue (it is in standby mode). This indicates that the projector is receiving power, but is not yet turned on.

- 3 Press the [ⓘ] button on the control panel or remote control to turn on the projector.

The confirmation buzzer beeps and the status indicator flashes blue as the projector warms up. Once the projector is warmed up, the status indicator stops flashing and turns blue.

If the image is not projected, try the following.

- Turn on the connected computer or video equipment.
- When using a laptop computer, change the screen output of the computer.
- Insert media such as a DVD and play it back.
- Press the [Search] button on the remote control to detect the input source.
- Press the button for the input source that you want to project by using the remote control.

Warning

- Do not look into the projector's lens during projection. Doing so may damage your eyes. Be especially careful if children are present.
- During projection, do not block the light from the projector with a book and so on. If the light from the projector is blocked for a long time, the area on which the light shines becomes hot which could cause it to melt, burn, or start a fire. Also, the lens may get hot due to the reflected light which could cause the projector to malfunction. To stop projection, use the Shutter function, or turn off the projector.



- If **Direct Power On** is set to **On** in the **Extended** menu, the projector automatically turns on when power is supplied to it. When the power cord is plugged in, note that the projector turns on automatically in cases such as recovery from a power outage.
 - ☛ **Extended - Operation - Direct Power On** [p.147](#)
- You can set the shutter status when the projector is turned on in **Shutter** settings from the **Extended** menu.
 - ☛ **Extended - Operation - Shutter Settings - Startup** [p.147](#)



- To ensure a long projector service life, turn off the projector when you are not using it. The light source's operating life varies depending on the Configuration menu settings, environmental conditions, and usage conditions. The brightness of the projected image drops as projection time elapses.
- The projector can be powered off directly by the breaker because it supports the direct shutdown function.
- When the projector is used continuously for more than 24 hours, or when direct shutdown is used regularly, set **Light Source Calibration** using the scheduling function to adjust the light source periodically. You can also make settings from the Configuration menu.
 - ☛ "Scheduling Function" [p.111](#)
 - ☛ **Reset - Light Source Calibration** [p.163](#)

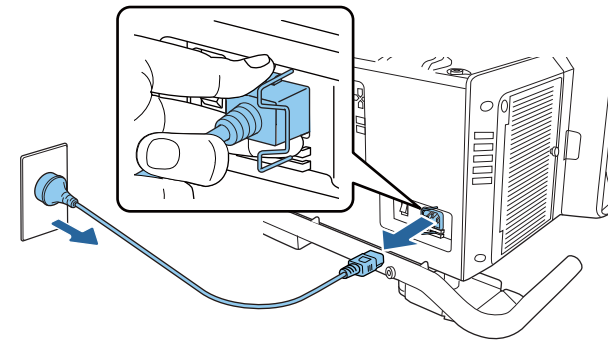

The power cord is shipped according to the power specifications of the country in which it is sold. If there is a lock on the power plug, unplug the power cord while pressing the lock.

- 1** Press the [⏻] button on the control panel or the remote control. The shutdown confirmation screen is displayed.

Power Off?

Yes: Press  button
No : Press any other button

- 2** Press the [⏻] button again. (To cancel, press any other button.) After the buzzer beeps twice, the projected image disappears, and the status indicator turns off.
- 3** Turn off the main power switch. The power indicator turns off.
- 4** Remove the cable holder and unplug the power cord.

Automatically Detecting Input Signals and Changing the Projected Image (Source Search)

Press the [Search] button on the remote control to project images from the port currently receiving an image.

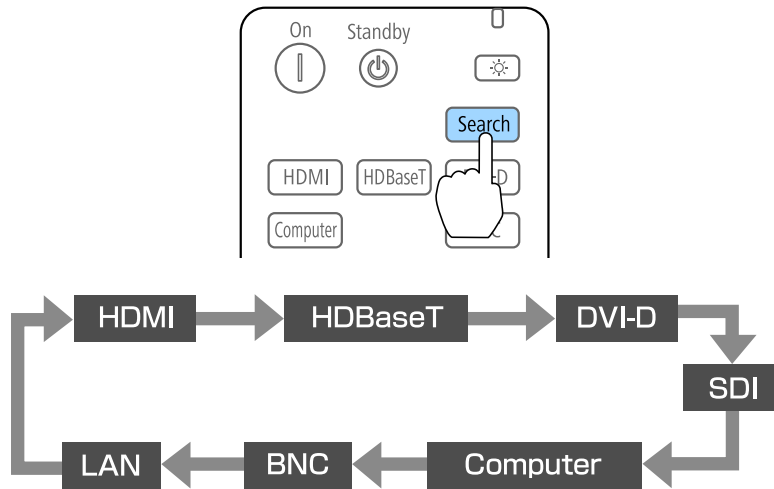

When two or more image sources are connected, repeatedly press the [Search] button until the target image is projected.

When your video equipment is connected, start playback before beginning this operation.



- You can make settings so that images are projected from the same input port the next time the projector is turned on.
 - Extended - Operation - Startup Source Search [p.147](#)
- The following screen is displayed while no image signals are input.

[Source Search]

	Signal Status
HDMI	Off
HDBaseT	Off
DVI-D	Off
SDI	Off
Computer	Off
BNC	Off
LAN	Off

·Input an image signal.
·Press **↵** to select the source.

[↵]:Select [↵]:Enter [Esc]:Exit

Switching to the Target Image

You can change directly to the target image from the remote control or by pressing the following buttons on the control panel.

The following shows the input ports for each button.

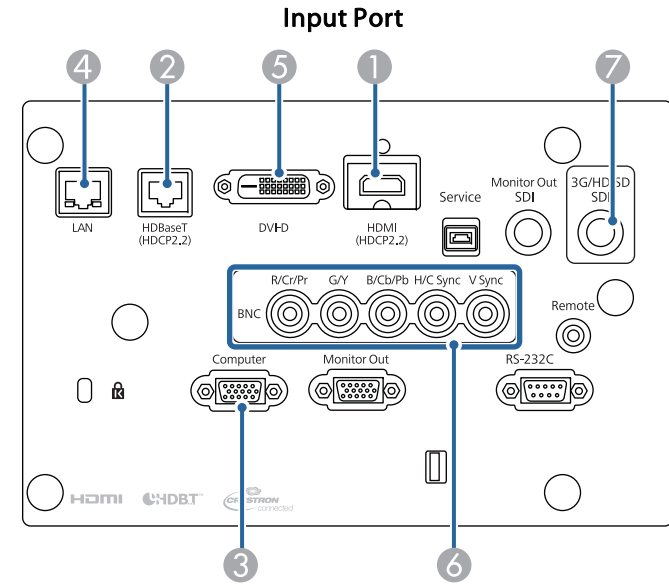
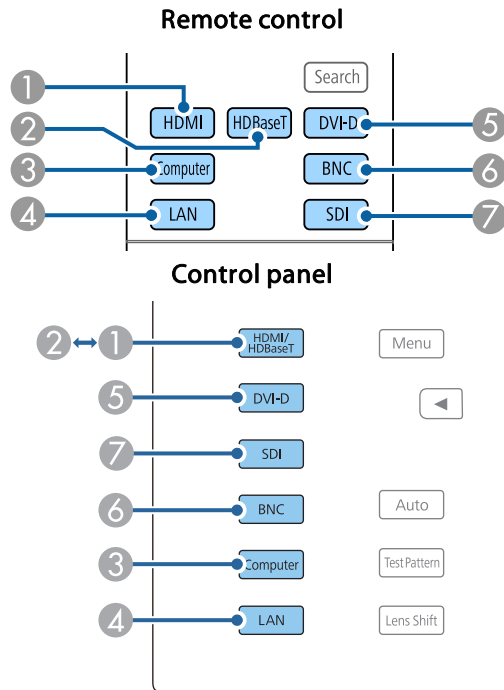

- ④ Changes to images from a computer connected via the network.

Correcting Distortion in the Projected Image

You can correct keystone distortion in projected images using one of the following methods.

- H/V-Keystone

This allows you to correct distortion in the horizontal and vertical directions independently.

☛ "H/V-Keystone" [p.63](#)

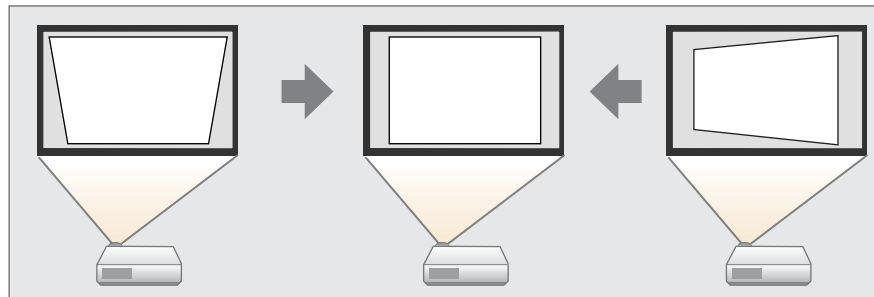

- Quick Corner

Correct the four corners independently.

☛ "Quick Corner" [p.64](#)

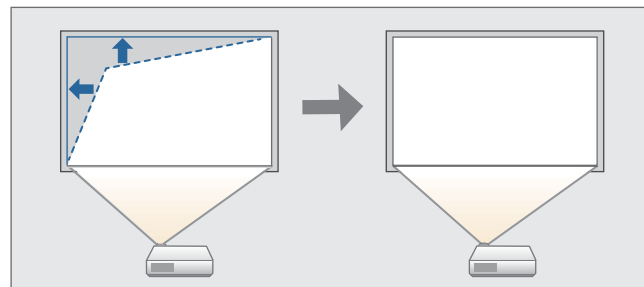

- Curved Surface

Correct distortion that occurs when projecting on a curved surface, and adjust the amount of expansion and contraction.

☛ "Curved Surface" [p.65](#)

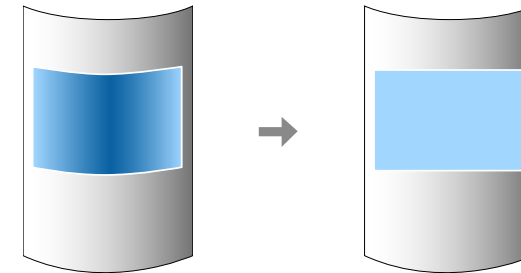

- Corner Wall

This allows you to correct distortion that occurs when projecting on a surface with right angles, such as a square pillar or the corner of a room, and adjust the amount of expansion and contraction.

☛ "Corner Wall" [p.69](#)

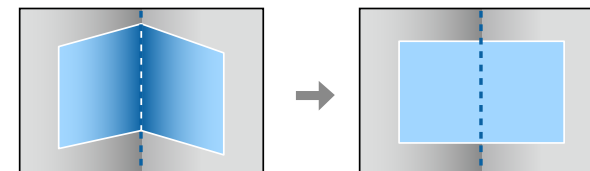

- Point Correction

Corrects slight distortion which occurs partially, or adjusts the image position in an overlapping area when projecting from multiple projectors.

☛ "Point Correction" [p.72](#)

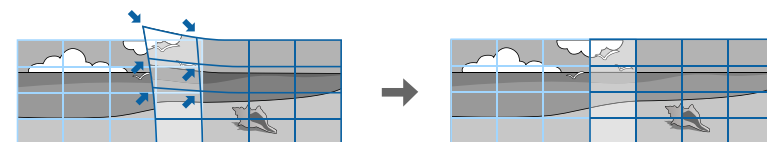



- When you want to re-adjust the projection position and so on, if you want to release the correction status temporarily, set the **Geometry Correction** to **Off**. Even when it is set to **Off**, the correction values are saved.

☛ **Settings - Geometry Correction** [p.145](#)

- You can save the geometry correction settings using **Memory** in **Geometry Correction**, and load them when needed.

☛ "Memory Function" [p.109](#)

- You can also make settings from the Configuration menu.

☛ **Settings - Geometry Correction** [p.145](#)

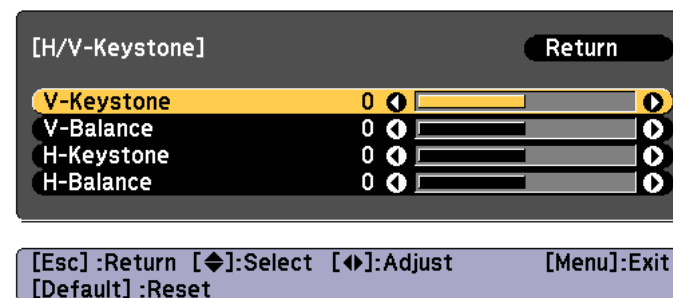

H/V-Keystone

This allows you to correct distortion in the horizontal and vertical directions independently.

Use the following to check the adjustment range for the image.

☛ "H/V-Keystone" [p.259](#)

- 1** Press the [Geometry] button while projecting.
- 2** Select **H/V-Keystone**, and then press the [↵] button.
When the message "If this setting is changed, the image may be distorted." is displayed, press the [↵] button.
- 3** Use the [▲][▼] buttons to select the correction method, and then use the [◀][▶] buttons to make the corrections.

Correct the keystone distortion by using **V-Keystone** and **H-Keystone**.

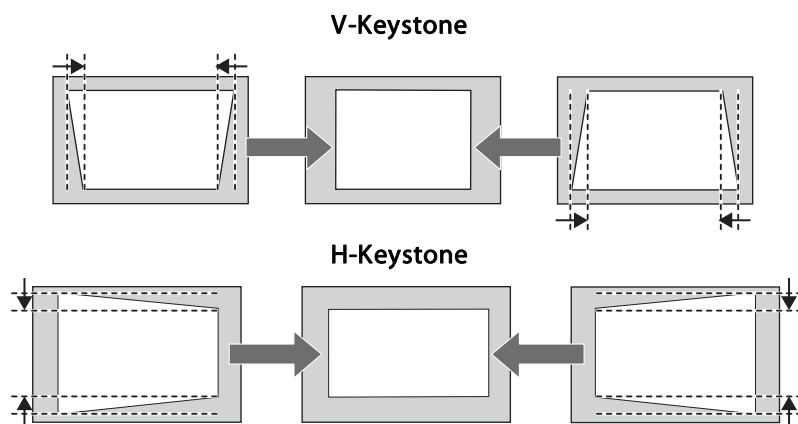

If the image aspect is incorrect, adjust the image balance by using **V-Balance** and **H-Balance**.

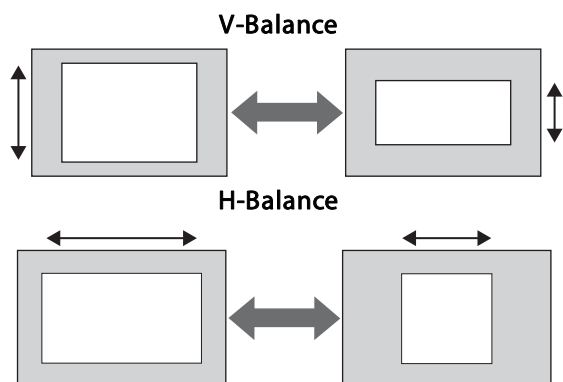

When you correct keystone distortion, the projected image may be reduced.



You cannot combine with other correction methods.

Quick Corner



You can project beyond the edges of the projected screen. However, once you reach the limit of how much correction can be performed, you cannot correct the image any further.

This allows you to correct each of the four corners of the projected image independently.

- 1** Press the [Geometry] button while projecting.
- 2** Select **Quick Corner**, and then press the [↵] button.
When the message "If this setting is changed, the image may be distorted." is displayed, press the [↵] button again.
- 3** Use the [▲], [▼], [◀], and [▶] buttons to select the corner you want to adjust, and then press the [↵] button.

- 4** To complete the corrections, press the [Menu] button.

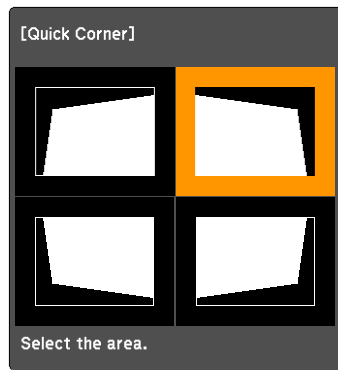

[↔/↔]: Select
 [↵]: Enter
 [Esc] : Return (press for 2 seconds to reset)



If the [Esc] button is pressed for approximately two seconds, the confirm default reset screen is displayed.
 Select **Yes** to reset the result of Quick Corner corrections.

- 4 Use the [▲], [▼], [◀], and [▶] buttons to correct the position of the corner.

When you press the [↵] button, the screen shown in step 3 that allows you to select the area to be corrected is displayed.

If the message "Cannot adjust any further." is displayed while adjusting, you cannot adjust the shape any further in the direction indicated by the gray triangle.

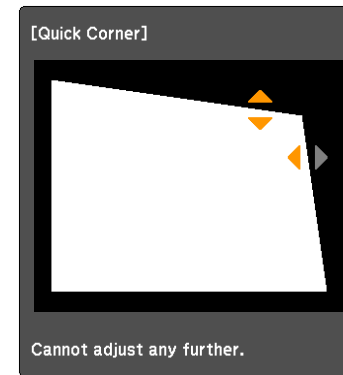

[↔/↔]: Adjust
 [Esc] / [↵]: Return

- 5 Repeat steps 3 and 4 as needed to adjust any remaining corners.
- 6 To complete the corrections, press the [Menu] button.



Point Correction allows you to fine tune the corrected results.
 ➔ "Point Correction" [p.72](#)

Curved Surface

This allows you to correct distortion that occurs when projecting on a curved surface, and adjust the amount of expansion and contraction.

Face the projector directly opposing the screen with the lens position moved to the home position.

➔ "Adjusting the Position of the Projected Image (Lens Shift Adjustment)" [p.37](#)



- Project onto an arc surface with the same radius.
- If a large amount of adjustment is performed, the focus may not be uniform even after making adjustments.
- If **4K Enhancement** is enabled, a message is displayed. Select **Yes** to disable **4K Enhancement**.
 🗨 **Image - Image Enhancement - 4K Enhancement** [p.141](#)
- You can project beyond the edges of the projected screen. However, once you reach the limit of how much correction can be performed, you cannot correct the image any further.

Use the following to check the adjustment range for the image.

🗨 "Curved Surface" [p.259](#)

- 1 Press the [Geometry] button while projecting.
- 2 Select **Curved Surface**, and then press the [↵] button.

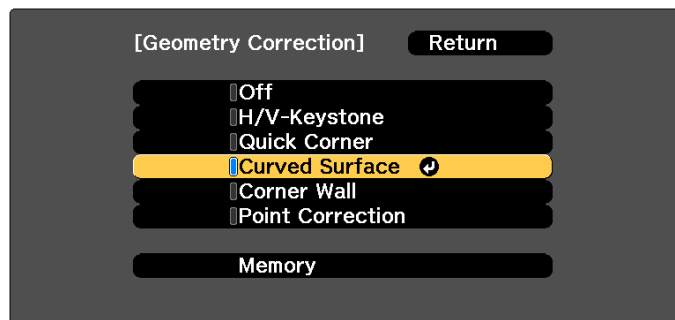

[Esc]:Return [↕]:Select [↵]:Enter [Menu]:Exit

When the message "If this setting is changed, the image may be distorted." is displayed, press the [↵] button.

- 3 Select **Curved Surface**, and then press the [↵] button.

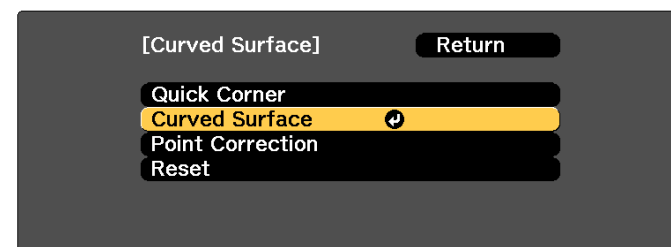

[Esc]:Return [↕]:Select [↵]:Enter [Menu]:Exit

- 4 Select **Correct Shape**, and then press the [↵] button.

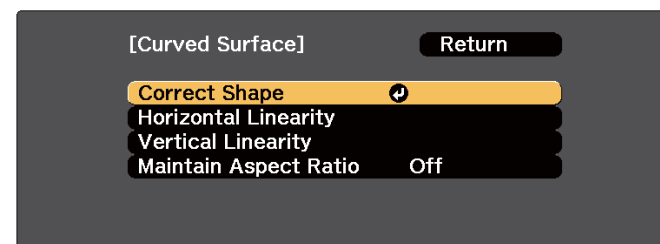

[Esc]:Return [↕]:Select [↵]:Enter [Menu]:Exit

- 5** Use the [▲], [▼], [◀], and [▶] buttons to select the area you want to adjust, and then press the [↵] button.

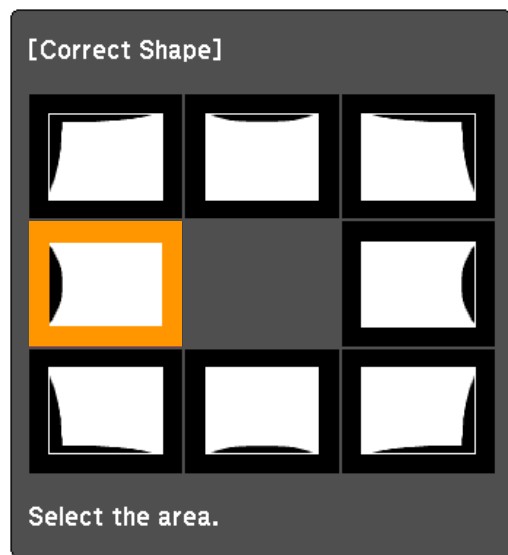

When selecting a corner, you can adjust the two sides next to the corner.



If the [Esc] button is pressed for approximately two seconds, the confirm default reset screen is displayed.

Select **Yes** to reset the result of Curved Surface.

- 6** Use the [▲], [▼], [◀], and [▶] buttons to adjust the shape.

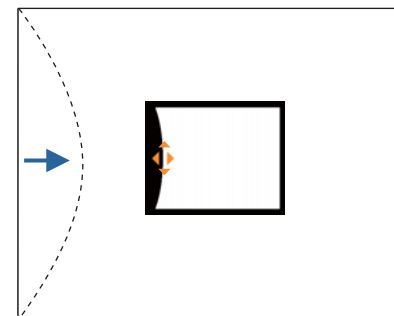

If the triangle in the direction you are adjusting the shape turns gray, as shown in the screenshot below, you cannot adjust the shape any further in that direction.

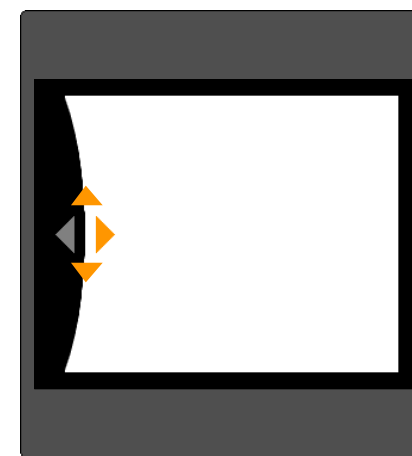

- 7** Press the [Esc] button to return to the previous screen.

- 8** Repeat steps from 5 to 7 as needed to adjust any remaining parts.

If the image expands or contracts, go to the next step and adjust the linearity.

- 9** Press the [Esc] button to return to the screen in step 4. Select **Horizontal Linearity** or **Vertical Linearity**, and then press the [↵] button.

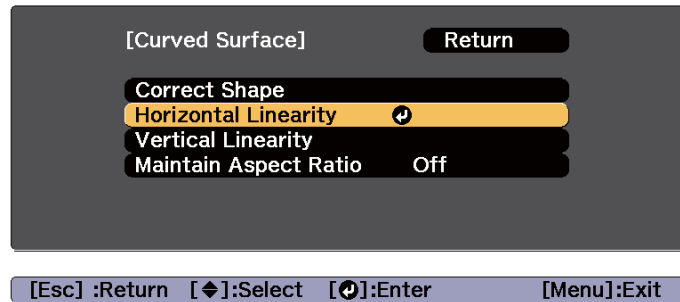

Select **Horizontal Linearity** to adjust the horizontal expansion or contraction, and select **Vertical Linearity** to adjust the vertical expansion or contraction.



To compensate for expansion or contraction while maintaining the aspect ratio, set **Maintain Aspect Ratio** to **On**. You may not be able to perform corrections if you set this to **On** after correction. In this situation, return the corrections to their initial values, or reduce the amount of correction, and then try again.

- 10** Select the standard line for the adjustments, and then press the [↵] button.

Press the [◀][▶] buttons when selecting **Horizontal Linearity**, and the [▲][▼] buttons when selecting **Vertical Linearity**, and then press [↵].

The selected standard line is displayed in flashing orange and white. Changing the standard line resets the previous settings.

- 11** Adjust the linearity.
Correct it so that the distance between lines is equal.
When pressing the [◀] button

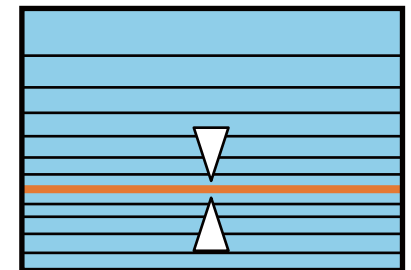
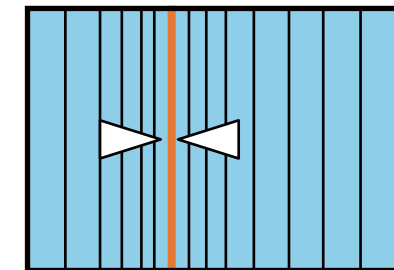

When **Horizontal Linearity** is selected When **Vertical Linearity** is selected

When pressing the [▶] button

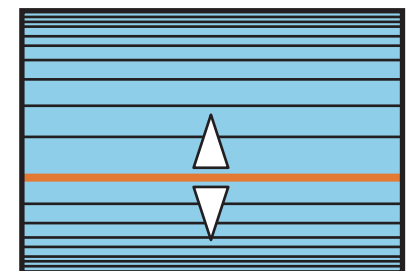
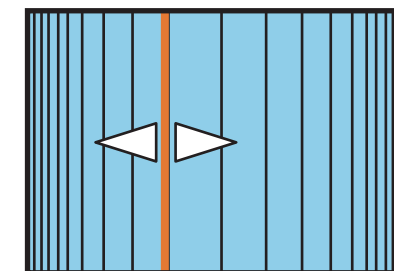

When **Horizontal Linearity** is selected When **Vertical Linearity** is selected

- 12** To complete the corrections, press the [Menu] button.



You can fine tune the corrected results. Use **Quick Corner** to adjust the tilt of the image, and then use **Point Correction** for fine tuning. Select **Quick Corner** or **Point Correction** on the screen from step 3.

☛ "Quick Corner" p.64

☛ "Point Correction" p.72

Corner Wall

This allows you to correct distortion that occurs when projecting on a surface with right angles, such as a square pillar or the corner of a room, and adjust the amount of expansion and contraction.

Face the projector directly opposing the screen with the lens position moved to the home position.

☛ "Adjusting the Position of the Projected Image (Lens Shift Adjustment)" p.37



- Project onto a surface with a right angle.
- If a large amount of adjustment is performed, the focus may not be uniform even after making adjustments.
- If **4K Enhancement** is enabled, a message is displayed. Select **Yes** to disable **4K Enhancement**.
☛ **Image - Image Enhancement - 4K Enhancement** p.141
- You can project beyond the edges of the projected screen. However, once you reach the limit of how much correction can be performed, you cannot correct the image any further.

Use the following to check the adjustment range for the image.

☛ "Corner Wall" p.261

- 1 Press the [Geometry] button while projecting.
- 2 Select **Corner Wall**, and then press the [↵] button.

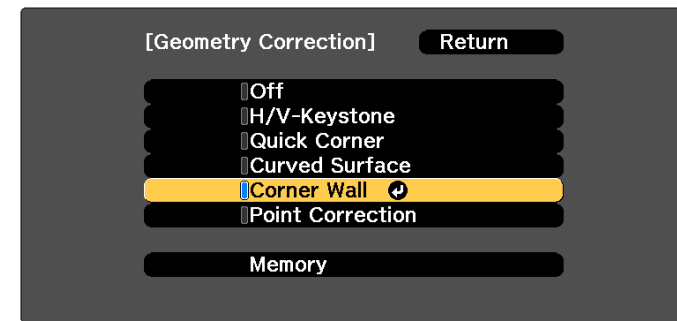

[Esc] :Return [◆]:Select [↵]:Enter [Menu]:Exit

When the message "If this setting is changed, the image may be distorted." is displayed, press the [↵] button again.

- 3 Select **Corner Wall**, and then press the [↵] button.

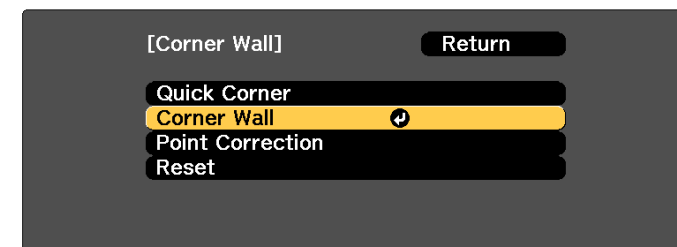

[Esc] :Return [◆]:Select [↵]:Enter [Menu]:Exit

- 4 Select **Corner Type**, and then press the [↵] button.

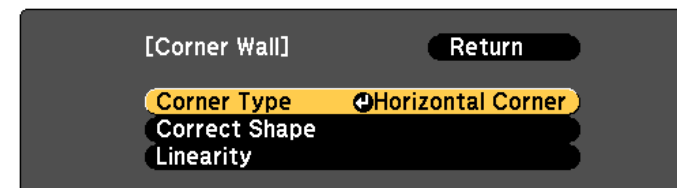

[Esc] :Return [◆]:Select [↵]:Enter [Menu]:Exit

- 5** According to the projection area, select **Horizontal Corner** or **Vertical Corner**, and then press the [**↵**] button.

When the surfaces line up horizontally:

Select **Horizontal Corner**.

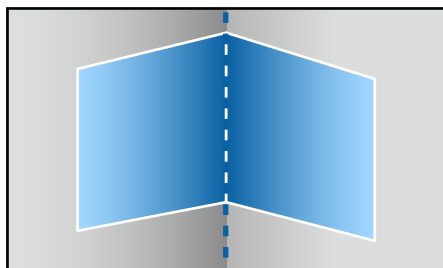

When the surfaces line up vertically:

Select **Vertical Corner**.

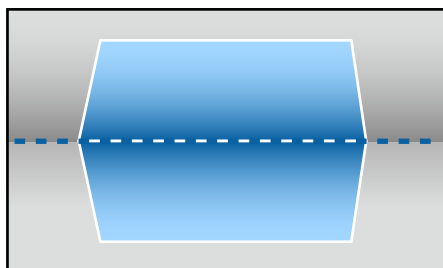

From here on, steps are explained using **Horizontal Corner** as an example.

- 6** Press the [Esc] button to display the screen from step 4. Select **Correct Shape**, and then press the [**↵**] button.

- 7** Adjust the position of the projector and the lens shift so that the line in the center of the screen matches the corner (the point where the two surfaces meet).

☛ "Adjusting the Position of the Projected Image (Lens Shift Adjustment)" [p.37](#)

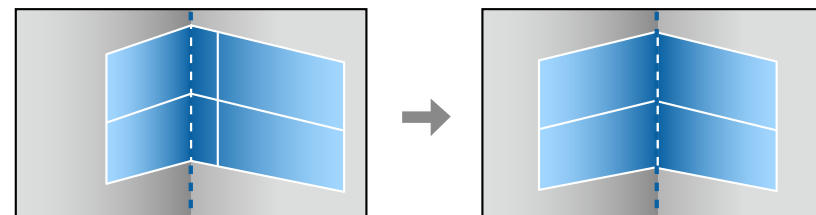

Each time you press the [**↵**] button, you can show or hide the image and the grid.

- 8** Use the [▲], [▼], [◀], and [▶] buttons to select the area you want to adjust, and then press the [↵] button.

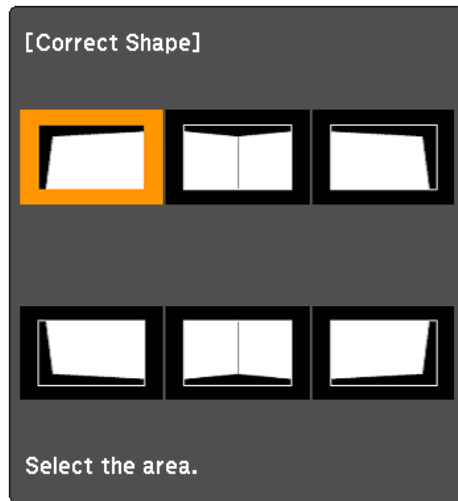

Adjustment tips

When **Horizontal Corner** is selected:

Adjust the upper area based on the lowest point (indicated by the **A** arrow).

Adjust the lower area based on the highest point (indicated by the **B** arrow).

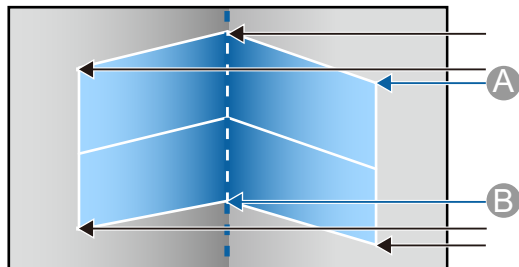

When **Vertical Corner** is selected:

Adjust the left and right based on the point nearest to the vertical line in the center of the screen.



If the [Esc] button is pressed for approximately two seconds, the confirm default reset screen is displayed.

Select **Yes** to reset the result of **Corner Wall**.

- 9** Press the [▲][▼][◀][▶] buttons to adjust the shape. If the message "Cannot adjust any further." is displayed while adjusting, you cannot adjust the shape any further in the direction indicated by the gray triangle.
- 10** Repeat steps 8 and 9 as needed to adjust any remaining parts. If the image expands or contracts, go to the next step and adjust the linearity.
- 11** Press the [Esc] button to display the screen from step 3. Select **Linearity**, and then press the [↵] button.

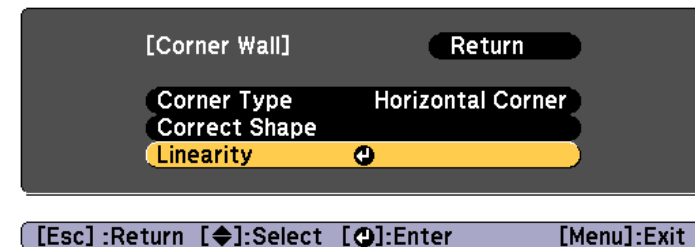

12 Press the [◀][▶] buttons to adjust the linearity.
Correct it so that the distance between lines is equal.

When pressing the [◀] button

When **Horizontal Corner** is selected When **Vertical Corner** is selected

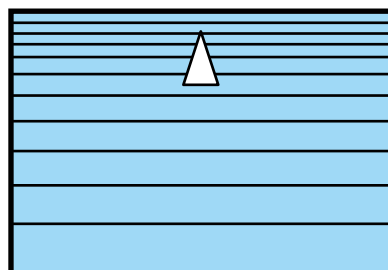
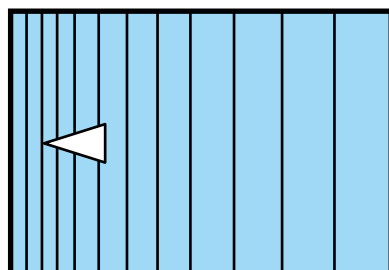

When pressing the [▶] button

When **Horizontal Corner** is selected When **Vertical Corner** is selected

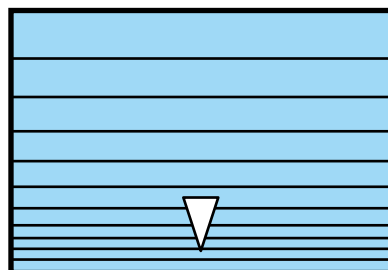
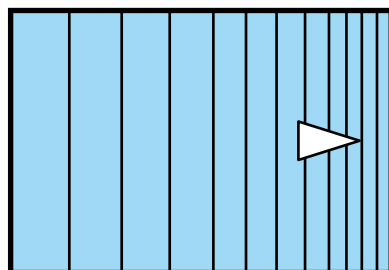

13 To complete the corrections, press the [Menu] button.



You can fine tune the corrected results. Use **Quick Corner** to adjust the tilt of the image, and then use **Point Correction** for fine tuning. Select **Quick Corner** or **Point Correction** on the screen from step 3.

☛ "Quick Corner" p.64

☛ "Point Correction" p.72

Point Correction

Divides the projected image by the grid and corrects the distortion by moving the point of intersection from side to side and up and down.



- You can make corrections by 0.5 pixels in each direction up to a maximum of 32 pixels.
- If **4K Enhancement** is enabled, a message is displayed. Select **Yes** to disable **4K Enhancement**.
☛ **Image - Image Enhancement - 4K Enhancement p.141**
- You can project beyond the edges of the projected screen. However, once you reach the limit of how much correction can be performed, you cannot correct the image any further.

1 Press the [Geometry] button while projecting.

2 Select **Point Correction**, and then press the [↵] button.

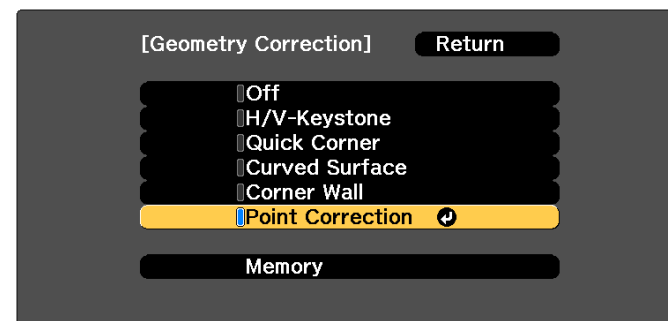

[Esc]:Return [◀]:Select [↵]:Enter [Menu]:Exit

When the message "If this setting is changed, the image may be distorted." is displayed, press the [↵] button again.

3 Select **Point Correction**, and then press the [**↵**] button.

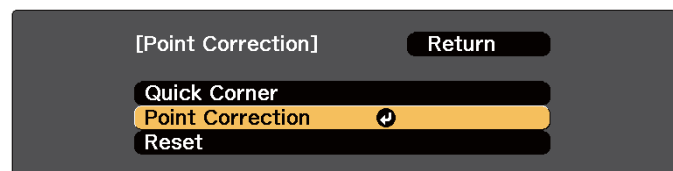

[Esc] :Return [↩]:Select [↵]:Enter [Menu]:Exit

4 Set each item on the following screen.

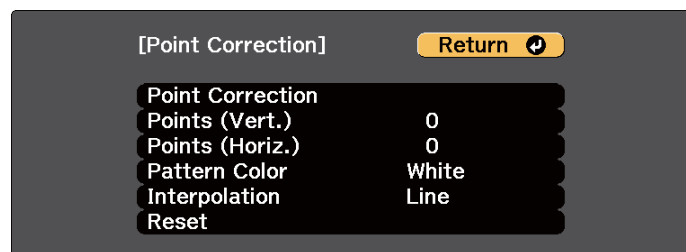

[Esc] / [↵]:Return [↩]:Select [Menu]:Exit

Point Correction	Starts Point Correction.
Points (Vert.)	Sets the number of points in the vertical and horizontal directions. Select the number of points from 3, 5, 9, 17, or 33.
Points (Horiz.)	
Pattern Color	Select the color of the grid when performing corrections.

Interpolation	Select the display format for the lines that connect the points. Line is most suitable when projecting onto a flat surface, and Curve is most suitable when projecting onto an uneven surface.
	 <p>If you have already made corrections using Point Correction, you may not be able to change Interpolation if the amount of correction is too large.</p>
Reset	Resets all corrections for Point Correction to their default values.

5 Select **Point Correction**, and then press the [**↵**] button.

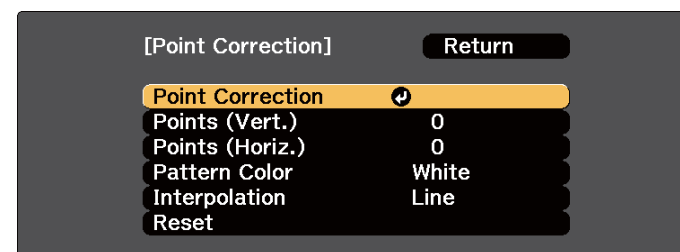

[Esc] :Return [↩]:Select [↵]:Enter [Menu]:Exit

6 Use the [**▲**], [**▼**], [**◀**], and [**▶**] buttons to move to the point you want to correct, and then press the [**↵**] button.

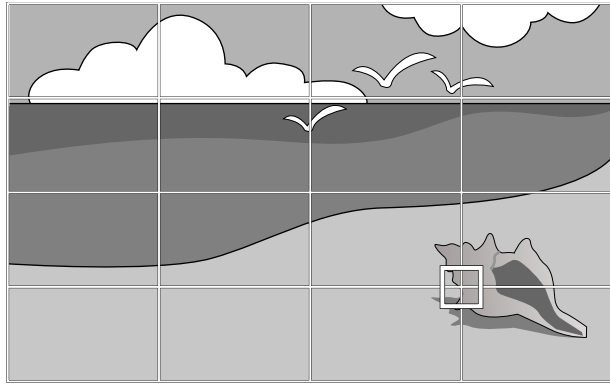

 The **Edge Blending** settings are temporarily disabled while the grid is displayed.

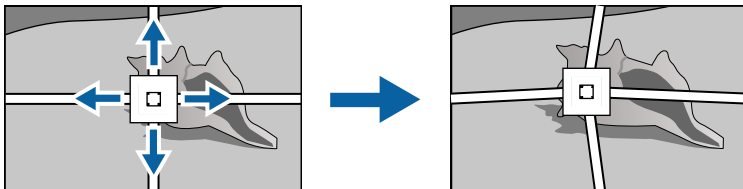

7 Use the [▲], [▼], [◀], and [▶] buttons to correct distortion.



To continue to correct another point, press the [Esc] button to return to the previous screen, then repeat the steps 5 and 6.

-  • Each time you press the [↵] button, you can show or hide the image and the grid.
- Even if you change the number of points during correction, the corrected status is retained.
- Coordinates for pixels that extend beyond the edge of the projected screen are displayed as negative numbers.

8 To complete the corrections, press the [Menu] button.

 You can fine tune the corrected results. Select **Quick Corner** on the screen from step 3 to adjust the tilt of the image.
 "Quick Corner" [p.64](#)

Selecting the Projection Quality (Selecting Color Mode)

You can easily obtain the optimum image quality simply by selecting the setting that best corresponds to your surroundings when projecting. The brightness of the image varies depending on the mode selected.

Mode	Application
Dynamic	This is the brightest mode. Ideal for use in a bright room.
Presentation	The images are vivid and brought to life. Ideal for making presentations or watching a TV program in a bright room.
Natural	Reproduces colors faithfully. Ideal for projecting still pictures such as photos.
Cinema	Gives images a natural tone. Ideal for watching films in a dark room.
BT.709	Produces images that conform to the ITU-R BT.709.
DICOM SIM	This produces images with clear shadows. Ideal for projecting X-ray photographs and other medical images. The projector is not a medical device and cannot be used for medical diagnosis.
Multi-Projection	Minimize the color tone difference between each projected image. Ideal for projecting from multiple projectors.

Each time you press the [Color Mode] button on the remote control, the Color Mode name is displayed on the screen and the Color Mode changes.

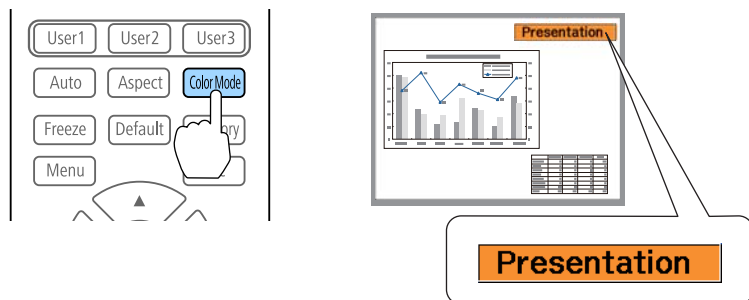

The Color Mode is saved for each input source.



You can set Color Mode from the Configuration menu.

🖱️ **Image - Color Mode** [p.141](#)

Setting the Brightness

Set the brightness for the light source.

- 1** Press the [Menu] button while projecting.
- 2** Select **Brightness Settings** from **Settings**.
- 3** Select **Light Source Mode**, and then press the [↵] button.

- 4** Select the item you want to set, and then press the [↵] button.

Normal: Select this if you do not want to decrease the brightness. This makes the light source operation time approximately 20,000 hours.

Quiet: Select this if you are concerned about the noise made by the fan. This sets the brightness at 70%. This makes the light source operation time approximately 20,000 hours.

Extended: Select this to extend the life expectancy of the light source. This sets the brightness at 70%. This makes the light source operation time approximately 43,000 hours.

Custom: Select this to set the **Brightness Level** manually. When **Custom** is selected, **Constant Brightness** is available.

- 5** When **Light Source Mode** is set to **Custom**, select **Brightness Level**, and then use the [◀][▶] buttons to set the brightness.









When there is a limit to the maximum adjustment value for the brightness level, the maximum value is displayed below **Brightness Level**.

- 6** To maintain a fixed brightness, select **Constant Brightness**, and set it to **On**.



- When **Constant Brightness** is set to **On**, you cannot change the settings for **Light Source Mode** and **Brightness Level**. When you want to change these settings, set **Constant Brightness** to **Off**.
- When **Constant Brightness** is set to **Off**, the value for **Brightness Level** changes depending on the current status of the light source.
- There may be a margin of error in the **Brightness Level**.
- When the projector is used continuously for more than 24 hours, or when direct shutdown is used regularly, set **Light Source Calibration** using the scheduling function. If this is not set, the Constant Brightness function does not work. You can also make settings from the Configuration menu.
 - ☛ "Scheduling Function" p.111
 - ☛ Reset - Light Source Calibration p.163

Display Level	Actual Time Remaining
	10,000 hours or more
	8,000 to 9,999 hours
	6,000 to 7,999 hours
	4,000 to 5,999 hours
	2,000 to 3,999 hours
	0 to 1,999 hours



Estimated Remains displays the amount of time remaining in hours without the minutes remaining.

Guide to Estimated Remains

When **Constant Brightness** is set to **On**, the Estimated Remains is displayed. Estimated Remains indicates the amount of time for which constant brightness can be maintained.

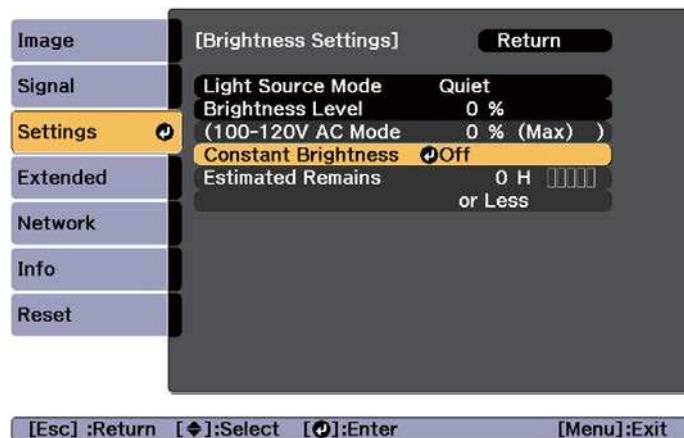

Relationship between Brightness Level and light source operation time

The following shows the relationship between Brightness Level and the light source operation time.

When Constant Brightness is set to Off

- ①: Brightness Level
- ②: Approximate light source operation time until its brightness is reduced by half

①	②
100%	20,000 hours
90%	36,000 hours
80%	41,000 hours
70%	43,000 hours
60%	46,000 hours
50%	57,000 hours
40%	75,000 hours

①	②
30%	103,000 hours

When Constant Brightness is set to On

- ①: Brightness Level
- ②: Standard constant time (Approximate time for which constant brightness of the light source can be maintained)

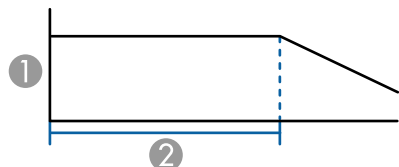
①	②	Illustration
85%	7,000 hours	
80%	15,000 hours	
70%	25,000 hours	
60%	35,000 hours	
50%	47,000 hours	
40%	66,000 hours	
30%	95,000 hours	



- This is an approximate guide only and may change depending on the projector's usage and surroundings.
- The times above are the standard hours when using the projector continuously without changing the **Brightness Level** or **Constant Brightness** settings and are not guaranteed.
- This is an approximate guide only and may change depending on the projector's usage and surroundings. You may need to replace internal parts sooner than the estimated light source operation time.
- When **Constant Brightness** is set to **On**, and the approximate constant time has been exceeded, you may not be able to set a high value for **Brightness Level**.

Setting the Amount of Light of the Projected Image

By automatically setting the luminance according to the brightness of the displayed image, it lets you enjoy deep and rich images. You can also set the light source to turn off automatically.

- 1 Press the [Menu] button while projecting.
- 2 Select **Light Source Control** from **Image**, and then press the [↵] button.
- 3 Select **Light Source Control**, and then press the [↵] button.

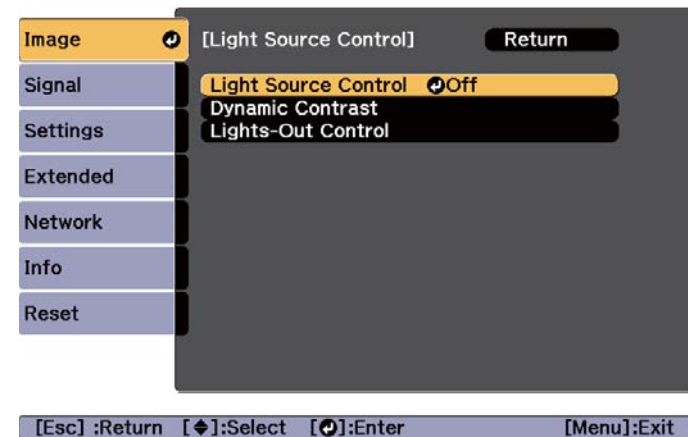

- 4 Select the light source operation according to the image signal, and then press the [↵] button.

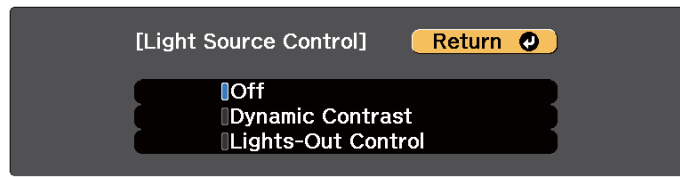

[Esc] / [Return]:Return [Select]:Select [Menu]:Exit

- **Off:** Select if you do not want to control the light source.
- **Dynamic Contrast:** Automatically adjust the amount of light when projecting according to the brightness of the image.
- **Lights-Out Control:** Automatically turns off the light after the set time has elapsed at the specified video level.

5 Press the [Esc] button to return to the previous screen.

6 If you selected **Dynamic Contrast** in step 4, make the following settings in **Dynamic Contrast**.

- **Response Speed:** Select **High Speed** to adjust the amount of light as soon as the scene changes.
- **Black Level:** Set the black level when the brightness level of the image signal is zero. When you select **0%**, the light source turns off.

7 If you selected **Lights-Out Control** in step 4, make the following settings in **Lights-Out Control**.

- **Lights-Out Signal Level:** Set the brightness level for the video signal being controlled. After turning off automatically when exceeding the specified image level, it turns on immediately.
- **Lights-Out Timer:** Set the amount of time before automatically turning off the light source.

8 Press the [Menu] button to finish making settings.

Changing the Aspect Ratio of the Projected Image

You can change the aspect ratio of the projected image to suit the type, the ratio of height and width, and the resolution of the input signals.

Available aspect modes vary depending on the Screen Type currently set.

- Set the **Screen Type** before changing the aspect ratio.
 - ☛ "Screen Settings" p.34
- This cannot be changed when **Scale Mode** is set to **Zoom Display**.
 - ☛ Signal - Scale - Scale Mode p.143

Changing methods

Each time you press the [Aspect] button on the remote control, the aspect mode name is displayed on the screen and the aspect ratio changes.

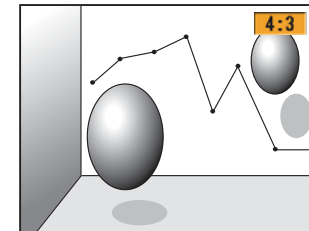
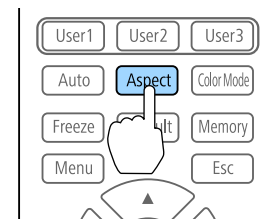

Aspect Mode	Explanation
Auto	Projects in an appropriate aspect ratio based on information from the signal being input.
Normal	Projects while retaining the aspect ratio of the input image.
4:3	Projects at an aspect ratio of 4:3.
16:9	Projects at an aspect ratio of 16:9.
Full	Projects at the full size of the projected screen.

Aspect Mode	Explanation
H-Zoom	Projects by enlarging the input image to the full width of the projected screen while retaining the aspect ratio. Areas that exceed the edges of the projected screen are not projected.
V-Zoom	Projects by enlarging the input image to the full height of the projected screen while retaining the aspect ratio. Areas that exceed the edges of the projected screen are not projected.
Native	Projects to the center of the projected screen at the resolution of the input image. Areas that exceed the edges of the projected screen are not projected.



- The available aspect ratios differ depending on the input signal from the connected device.
- You can also set the aspect ratio from the Configuration menu.
 🖱️ **Signal - Aspect** p.143
- If parts of the computer image are missing, set the **Resolution** setting to **Wide** or **Normal** from the Configuration menu, according to the resolution of the computer.
 🖱️ **Signal - Resolution** p.143

Adjusting the Image

Hue, Saturation, and Brightness adjustment

You can adjust the **Hue** (tint), **Saturation** (vividness), and **Brightness** of the six axes R (red), G (green), B (blue), C (cyan), M (magenta), and Y (yellow) according to your preferences.

- 1 Press the [Menu] button while projecting.

- 2 Select **Advanced** from **Image**, and then press the [↵] button.
- 3 Select **RGBCMY**, and then press the [↵] button.
- 4 Use the [▲][▼] buttons to select the color you want to adjust, and then press the [↵] button.

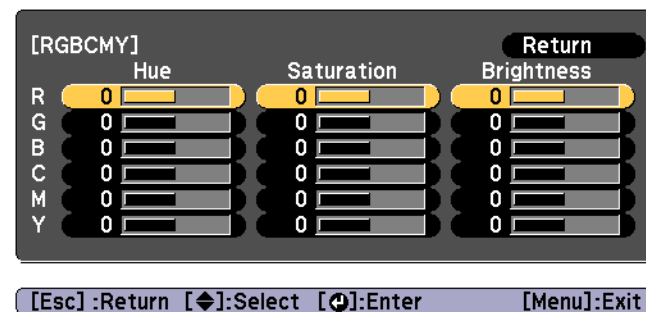

- 5 Use the [▲][▼] buttons to select the item, and then use the [◀][▶] buttons to make the adjustments.

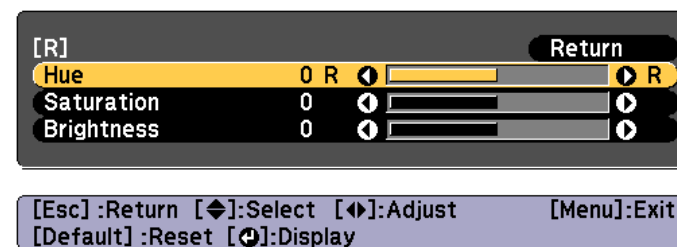

Each time you press the [↵] button, the adjustment screen changes.

- 6 To complete the corrections, press the [Menu] button.

Gamma adjustment

You can adjust differences in the halftone brightness that occurs depending on the connected device.



Adjust by projecting a still picture. Gamma cannot be adjusted correctly by using movies.

- 1 Press the [Menu] button while projecting.
- 2 Select **Advanced** from **Image**, and then press the [↵] button.
- 3 Select **Gamma**, and then press the [↵] button.
- 4 Use the [◀][▶] buttons to adjust the value.

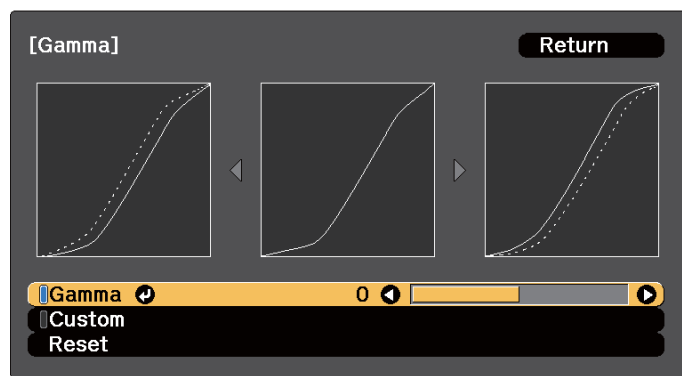

[Esc]:Return [◀▶]:Select [↵]:Set [Menu]:Exit

When a larger value is selected, the dark areas of images become brighter, but the color saturation for lighter areas may become weaker.

When a smaller value is selected, you can reduce the overall brightness of the image to make the image sharper.

If you select **DICOM SIM** from **Color Mode** on the **Image** menu, select the adjustment value according to the projection size.

- If the projection size is 300 inches or less, select a small value.
- If the projection size is 300 inches or more, select a large value.



Medical images may not be reproduced correctly according to your installation environment and screen specifications.

- 5 To make detailed adjustments, select **Custom**, and then press the [↵] button.
- 6 In the gamma adjustment graph, use the [◀][▶] buttons to select the tone that you want to change. Use the [▲][▼] buttons to adjust the selected tone, and then press the [↵] button.

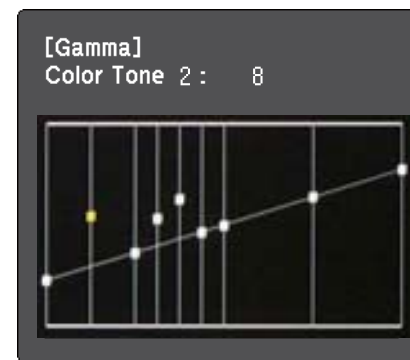

- 7 Press the [Menu] button to finish making adjustments.

Adjusting Image Resolution (Image Enhancement)

You can adjust the resolution of the image using **Image Enhancement** to reproduce a clear image with an emphatic texture and material feel.

- 1 Press the [Menu] button while projecting.
- 2 Select **Image Enhancement** from **Image**, and then press the [↵] button.

The following screen is displayed.

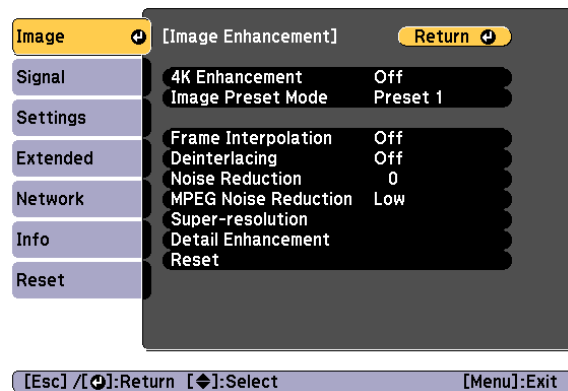

4K Enhancement

4K Enhancement is a function that projects an image at a doubled resolution by diagonally shifting 1 pixel in increments of 0.5 pixels.

A high-resolution image signal is projected in fine detail.



You cannot set 4K Enhancement when **Aspect** is set to **Native**.

- 1 Select **4K Enhancement** from **Image Enhancement**, and then press the [↵] button.
- 2 Select one of the following, and then press the [↵] button.
 - Off:** Disables 4K Enhancement. If a signal that exceeds the panel resolution of this projector is input, the image is displayed according to the panel resolution of this projector.
 - Full HD:** If a signal with a resolution of 1080i/1080p/WUXGA or higher is input, 4K Enhancement is enabled.
 - WUXGA+:** If a signal with a resolution that exceeds WUXGA is input, 4K Enhancement is enabled. To project a high-resolution movie, you can project a high-definition image by using this setting with **Image Preset Mode**.

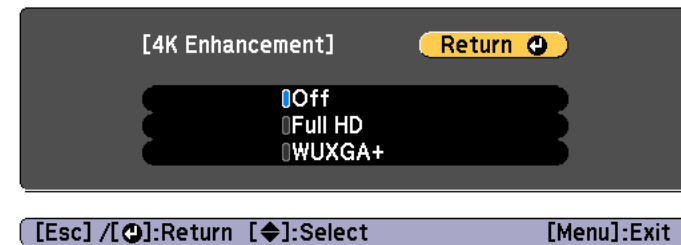

- To project from multiple projectors, select **Off** to unify each image.
- **Off** is ideal for projecting presentation materials from computers and so on.
- If it is set to **Full HD** or **WUXGA+**, the status corrected using the following function is canceled.
Edge Blending, Scale, Curved Surface, Point Correction, Corner Wall
When **4K Enhancement** is set to **Off**, the settings return to the previous state before **4K Enhancement** was enabled.

- 3 Press the [Esc] button to return to the previous screen.

Image Preset Mode

Select the optimal setting according to the projected image from five presets prepared in advance.

The following settings are saved in the presets.

Frame Interpolation, Deinterlacing, Noise Reduction, MPEG Noise Reduction, Super-resolution, Detail Enhancement



- To minimize delays, set **Image Preset Mode** to **Off**.
- When **Image Preset Mode** is set to **Off**, you cannot set the settings saved in the presets.

1 Select **Image Preset Mode** from **Image Enhancement**, and then press the [**↵**] button.

2 Select one of the following, and then press the [**↵**] button.
Preset 1 to Preset 5: The settings saved in advance are applied to the image.

Off: Select this to turn off presets.

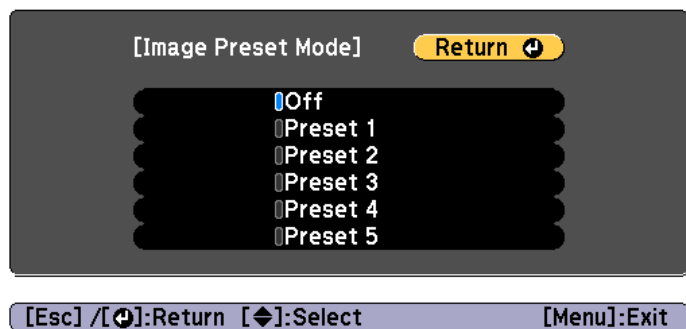

- After selecting **Preset 1** to **Preset 5**, you can fine tune each setting individually. The setting after adjustment will be overwritten.
- The setting after adjustment will be overwritten separately when **4K Enhancement** is enabled and disabled.

3 Press the [**Esc**] button to return to the previous screen.

Frame Interpolation

The current and previous frames are used to create intermediate frames, interpolating to produce smooth-moving images. You can resolve clumsy-moving images, such as frame skipping when projecting a fast moving image.



You cannot set Frame Interpolation in the following situations.

- When **4K Enhancement** is enabled
- When a signal with a horizontal resolution greater than 1920 is being input
- When **Aspect** is set to **V-Zoom**
- When **Scale** is set to **Auto** or **Manual**
- When **Edge Blending** is set to **On**
- When **Image Preset Mode** is set to **Off**

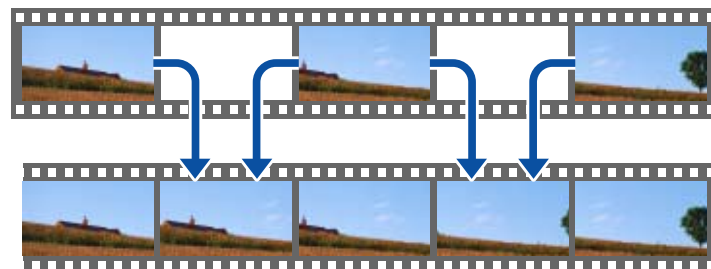

1 Select **Frame Interpolation** from **Image Enhancement**, and then press the [**↵**] button.

2 Select the level of interpolation from **Low**, **Normal** or **High**. Set to **Off** if noise occurs after setting them.

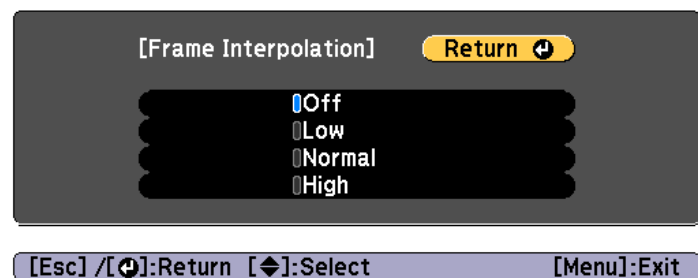

3 Press the [Menu] button to finish making settings.

Noise Reduction

You can smooth out rough images for softer image quality when inputting progressive signals or progressive interlace signals.



You cannot set Noise Reduction in the following situations.

- When **4K Enhancement** is enabled
- When a signal with a horizontal resolution greater than 1920 is being input
- When **Image Preset Mode** is set to **Off**

1 Select **Noise Reduction** from **Image Enhancement**, and then press the [**↵**] button.

2 Use the [**◀**][**▶**] buttons to adjust the value.

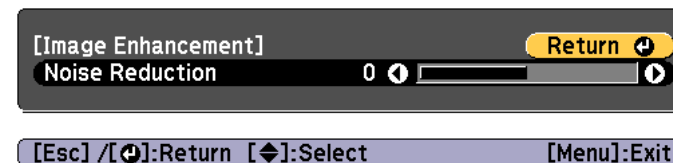

3 Press the [Esc] button to return to the previous screen.

MPEG Noise Reduction

You can reduce dot and block noise that occurs in outlines when projecting MPEG movies.



You cannot set MPEG Noise Reduction in the following situations.

- When **4K Enhancement** is enabled
- When a signal with a horizontal resolution greater than 1920 is being input
- When **Image Preset Mode** is set to **Off**

1 Select **MPEG Noise Reduction** from **Image Enhancement**, and then press the [**↵**] button.

- 2 Select a level to reduce noise from **Low**, **Normal**, or **High**, and then press the [↵] button.

If **Off** is selected, **MPEG Noise Reduction** is disabled.

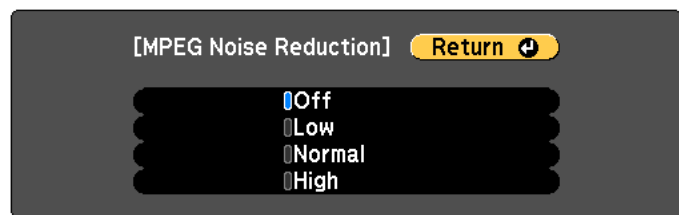

- 3 Press the [Esc] button to return to the previous screen.

Super-resolution

To display a crisp image, you can reduce the blurring that is created on the edge when the resolution of the image signal is scaled up and projected.

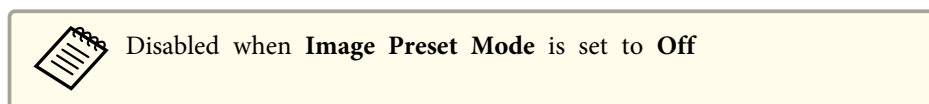

- 1 Select **Super-resolution** from **Image Enhancement**, and then press the [↵] button.

- 2 Use the [▲][▼] buttons to select the item, and then use the [◀][▶] buttons to make the adjustments.

Fine Line Adjust: If this parameter is set to a positive value, details such as hair or fabric patterns will be enhanced.

Soft Focus Detail: If this parameter is set to a positive value, the outline, background, and the other main parts of the objects in the image will be enhanced to show them clearly.

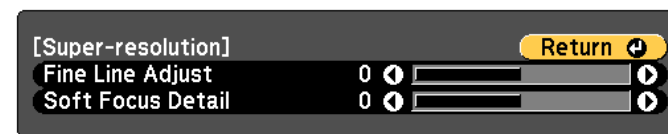

- 3 Press the [Esc] button to return to the previous screen.

Detail Enhancement

You can enhance the contrast in detailed areas of an image to create a more emphatic texture and material feel.

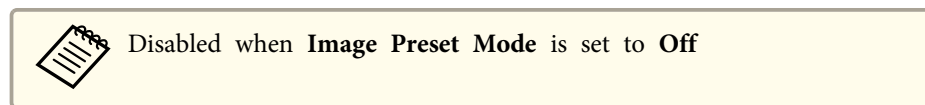

- 1 Select **Detail Enhancement** from **Image Enhancement**, and then press the [↵] button.

- 2** Use the [▲][▼] buttons to select the item, and then use the [◀][▶] buttons to make the adjustments.

Strength: The larger the value, the more the contrast is enhanced.

Range: The larger the value, the wider the range of detail enhancement becomes.

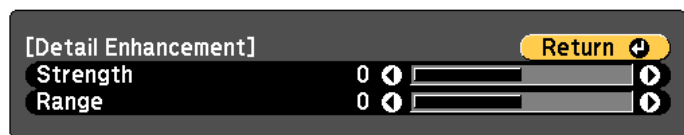

[Esc] / [◀]:Return [▶]:Select [Menu]:Exit



Depending on the image, a highlight may be noticeable at the border between colors. If this bothers you, set a smaller value.

- 3** Press the [Esc] button to return to the previous screen.



Useful Functions

This section describes the Multi-Projection, Split Screen, Memory, Schedule, and Security functions.

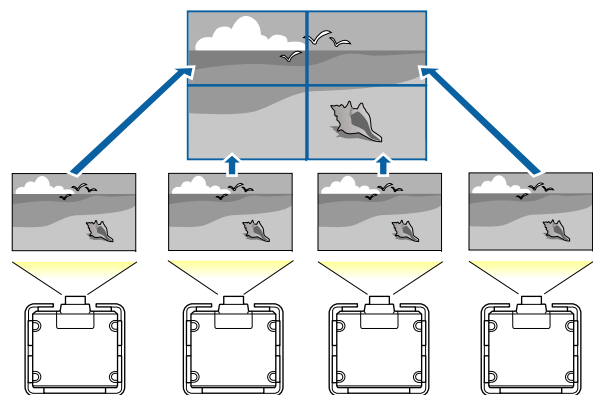

You can setup up to 15 projectors to project one large and wide image. You can adjust the difference of brightness and color tone between each projected image to create a seamless screen.



- Set **4K Enhancement** to **Off**.
- We recommend setting the focus, zoom, and lens shift at least 20 minutes after you start the projection, because images are not stable right after turning on the projector.
- If the values for **Geometry Correction** are large, the image position adjustment for overlapping images becomes difficult.
- The Test Pattern can be displayed to adjust the projection status without connecting video equipment.
 - ☛ "Displaying the Test Pattern" [p.36](#)
- If you project a dot by dot image that can be projected without being enlarged or reduced, you can make adjustments precisely.
- When **Run Periodically** is set to **On** in Light Source Calibration, calibration is automatically performed, and colors adjusted using multi-projection may change. Set this to **Off** to maintain the projected image as it is.
 - ☛ **Reset - Light Source Calibration - Run Periodically** [p.163](#)
- If you perform Screen Matching regularly, make sure you execute Screen Matching after performing Light Source Calibration. If there are still differences in the color, set **Run Periodically** to **Off** in **Light Source Calibration**.

Adjustment Procedure

Adjusting automatically online

The arrangement for all projectors (Tiling) and adjustments for the images (Edge Blending) are performed automatically using the projector set as the master projector.

You can automatically correct distortion and overlapping areas in multiple projected images by using the tiling assist function in Epson Projector Professional Tool, and automatically correct images projected in a stack.

☛ "Using Tiling Function of Geometry Correction Assist" [p.100](#)

- ☛ "Using the Stacking Function of Geometry Correction Assist" [p.101](#)

Advance preparation

- (1) Connect to the network
 - Connect all projectors to a network hub using LAN cables.
 - Set the DHCP to **On** for all projectors, or check that IP addresses have been assigned.
 - ☛ **Network - Network Configuration - Wired LAN - IP Settings** [p.158](#)
- (2) Set an ID for the master projector and the remote control.
 - ☛ "Set the projector ID" [p.43](#)
- (3) Set **Sleep Mode** to **Off**
 - ☛ **Extended - Operation - Sleep Mode** [p.147](#)

Adjusting projected images individually

- (1) Unify the size of the images
 - ☛ "Adjusting the Image Size" [p.39](#)
- (2) Adjust the orientation and position of the image
 - ☛ "Installation Settings" [p.34](#)
 - ☛ "Adjusting the Position of the Projected Image (Lens Shift Adjustment)" [p.37](#)
- (3) Fine tune the focus and distortion of the image
 - ☛ "Correcting the Focus" [p.40](#)
 - ☛ "Point Correction" [p.72](#)

Combining multiple projected images

- (1) Set the arrangement of the images.
 - ☛ "Performing tiling automatically" [p.89](#)
- (2) Adjust the edges of the images
 - ☛ "Edge Blending" [p.91](#)
 - ☛ "Black Level" [p.93](#)

- (3) Unify the brightness and tint of the images
 - ☛ "Screen Matching" [p.95](#)
- (4) Splice the images to create one, large image
 - ☛ "Displaying a Scaled Image" [p.98](#)

Adjusting manually offline

Adjust the images from all projectors manually.

Advance preparation



- Set an ID for all projectors and the remote controls.
- ☛ "Set the projector ID" [p.43](#)

Adjusting projected images individually

- (1) Unify the size of the images
 - ☛ "Adjusting the Image Size" [p.39](#)
- (2) Adjust the orientation and position of the image
 - ☛ "Installation Settings" [p.34](#)
 - ☛ "Adjusting the Position of the Projected Image (Lens Shift Adjustment)" [p.37](#)
- (3) Fine tune the focus and distortion of the image
 - ☛ "Correcting the Focus" [p.40](#)
 - ☛ "Point Correction" [p.72](#)

Combining multiple projected images

- (1) Set the arrangement of the images.
 - ☛ "Performing tiling manually" [p.90](#)
- (2) Adjust the edges of the images
 - ☛ "Edge Blending" [p.91](#)
 - ☛ "Black Level" [p.93](#)



- (3) Unify the brightness and tint of the images
 "Color Matching" p.97
- (4) Splice the images to create one, large image
 "Displaying a Scaled Image" p.98

Tiling

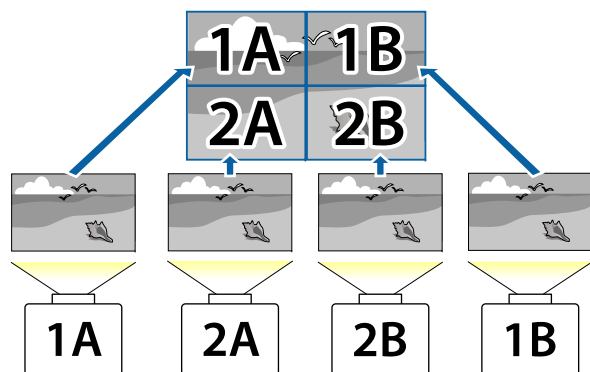
When using multiple projectors to create one large image, assign a projection position to each projector.



Before performing tiling, adjust the projected image so that it is a rectangle. Also, adjust the size and focus of the images.

-  "Adjusting the Image Size" p.39
-  "Correcting the Focus" p.40

Performing tiling automatically

Automatically sets the arrangement for the projectors being used. You can make settings by operating only the master projector.



Location setup is performed using the camera built into the front of the projector. Do not block the camera or the projected images.

- 1** Press the [Menu] button while projecting.
- 2** Select **Multi-Projection** from **Extended**, and then press the [↵] button.
- 3** Select **Projector Grouping**, and then press the [↵] button.
- 4** Select the projectors that will be used for tiling, and then press the [↵] button.

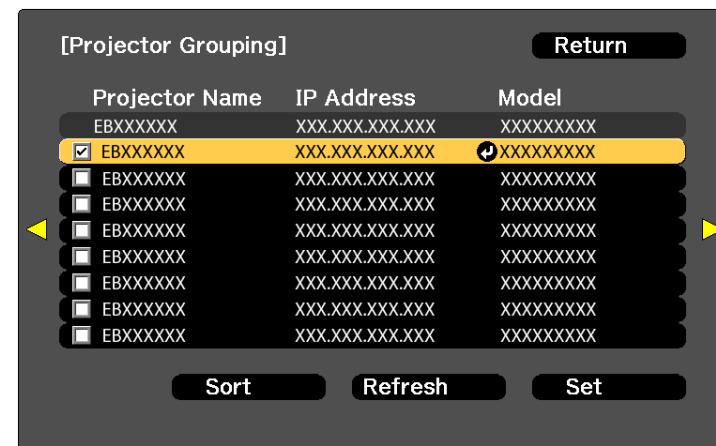

[Esc]:Return [↵]:Select [⏏]:Set [Menu]:Exit

- (1) Select the projectors you want to use to enter a checkmark. Select **Refresh** to update the list. Select **Sort** to sort the projector order.
- (2) Select **Set**, and then press the [↵] button.

- 5** Select **Tiling**, and then press the [↵] button.

- 6** Select **Tiling**. Select **Auto**, and then press the [Esc] button.

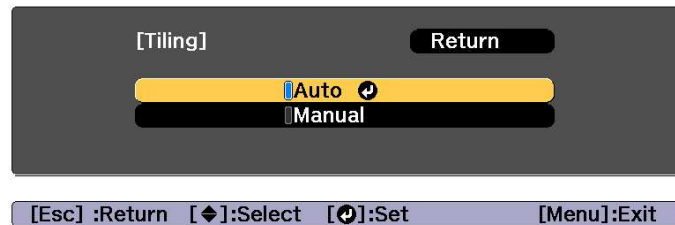

- 7** Select **Location Setup**, and then press the [↵] button.

The image is positioned automatically.

When the message "Assign IDs to projectors that have been located. Do you want to continue?" is displayed, select **Yes**.

When setup is complete, the following screen is displayed.

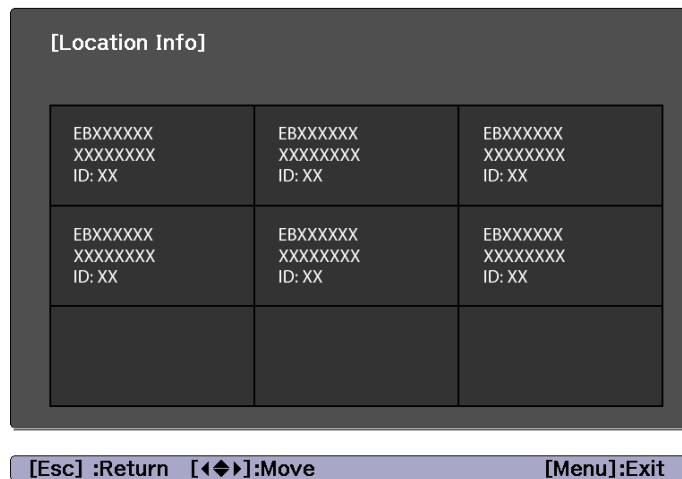

If the image is not located correctly, select **Manual** in step 6, and then follow the steps below to locate the image manually.

- (1) Set **Row** and **Column** in **Layout**.
- (2) Select **Set**, and then press the [↵] button.
- (3) Select the projector in **Location Setup**, and then press the [↵] button.
- (4) Select the position you want to locate, and then press the [↵] button.
- (5) Repeat steps (3) and (4) to reposition the location of all projectors.
- (6) Select **Set**, and then press the [↵] button.

- 8** Input the image signal to display the image.

☛ "Automatically Detecting Input Signals and Changing the Projected Image (Source Search)" [p.60](#)

When tiling is complete, adjust any positional gaps and the tint of the projected images.

☛ "Adjusting projected images individually" [p.88](#)



- After tiling is complete, do not change the IP addresses or projector names of the projectors. Otherwise the image will not be adjusted automatically.
- After tiling is complete, you can set each projector with one remote control. Select the projector ID for the projector you want to set with the remote control. You can check the projector ID in **Tiling - Location Info**.
 - ☛ "Setting the remote control ID" [p.44](#)

Performing tiling manually

Manually arrange the images being projected for each projector.

- 1** Press the [Menu] button while projecting.
- 2** Select **Multi-Projection** from **Extended**, and then press the [↵] button.
- 3** Select **Tiling**, and then press the [↵] button.
- 4** Select **Layout**, and then press the [↵] button.
 - (1) Set the number of projectors in **Row** and **Column**.
 - (2) Select **Set**, and then press the [↵] button.
- 5** Repeat steps 1 to 4 for each projector to be used for tiling.
- 6** Select **Location Setup**, and then press the [↵] button.
 - (1) Set the positions of the projected images in **Row Order** and **Column Order**.
Row Order: Place screens from top to bottom in the order of **1, 2, 3**.
Column Order: Place screens from left to right in the order of **A, B, C**.

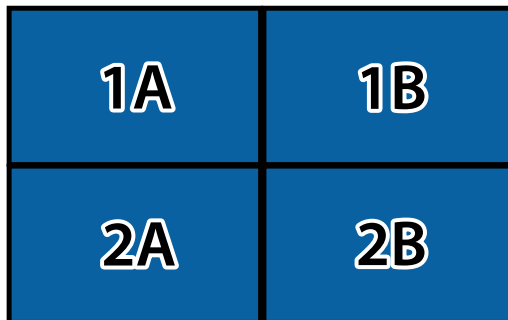

- (2) Select **Set**, and then press the [↵] button.

- 7** Repeat step 6 for each projector.

- 8** Input the image signal to display the image.
 - ☛ "Automatically Detecting Input Signals and Changing the Projected Image (Source Search)" [p.60](#)

When tiling is complete, adjust any positional gaps and the tint of the projected images.

- ☛ "Adjusting projected images individually" [p.88](#)

Edge Blending

You can fine tune the overlapping areas to make seamless screen.

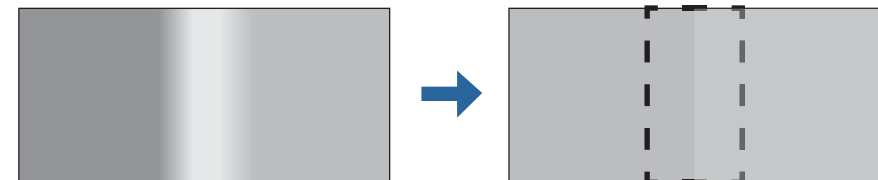

Before performing edge blending to raise the precision of adjustments, press the [Color Mode] button on the remote control, and then set **Color Mode** to **Multi-Projection**.

- 1** Press the [Menu] button while projecting.
- 2** Select **Multi-Projection** from **Extended**.
- 3** Select **Edge Blending**, and then press the [↵] button.
The following screen is displayed.

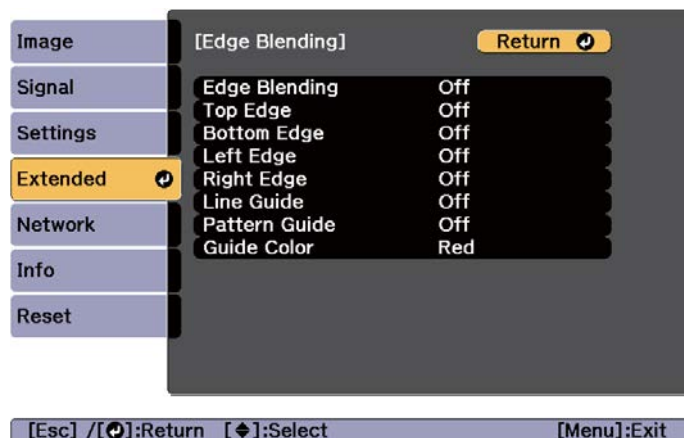

Submenu	Function
Edge Blending	Set to On to activate Edge Blending. Set to Off when not projecting from multiple projectors.
Top Edge/Bottom Edge/Left Edge/Right Edge	<p>Blending: Set to On to activate Edge Blending towards your settings, and the blend range will be shaded.</p> <p>Blend Start Position: Displays blending start position as a red line, and adjusts at the level of one pixel.</p> <p>Blend Range: Adjusts the range to be shaded. Adjustment is possible at the level of one pixel. The maximum range is 45% of the resolution.</p> <p>Blend Curve: Adjusts how to apply shading.</p>
Line Guide	Set to On to display a guide on the Edge Blending setting range.
Pattern Guide	Set to On to display a lattice pattern to match the position of the Edge Blending setting range.
Guide Color	Select a combination of guide colors from the six provided.

- 4** Turn on Edge Blending.
- (1) Select **Edge Blending**, and then press the [**↵**] button.
 - (2) Select **On**, and then press the [**↵**] button.
 - (3) Press the [Esc] button.

- 5** Set **Guide Display** to **On**.
- (1) Select **Guide Display**, and then press the [**↵**] button.
 - (2) Select **On**, and then press the [**↵**] button.
 - (3) Press the [Esc] button.



If the guide is not clear, you can change the color of the guide in **Guide Color**.

- 6** Set **Pattern Guide** to **On**.
- (1) Select **Pattern Guide**, and then press the [**↵**] button.
 - (2) Select **On**, and then press the [**↵**] button.
 - (3) Press the [Esc] button.

- 7** Set **Top Edge**, **Bottom Edge**, **Left Edge**, or **Right Edge** according to the parts of the image that are overlapped. The following shows how to set screen (1) as an example.

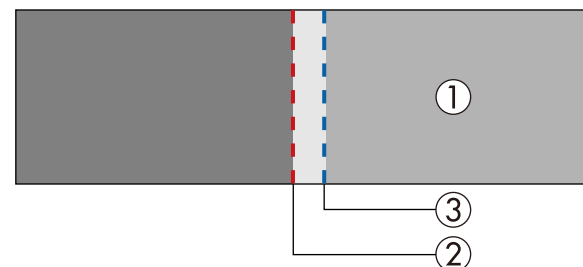

In the example above, you need to adjust the **Left Edge** because you can see the overlapping areas on the left side of the image (1).

- (1) Select **Left Edge**, and then press the [**↵**] button.
- (2) Select **Blending**, and then press the [**↵**] button.
- (3) Select **On**, and then press the [**↵**] button.
- (4) Press the [Esc] button.
- (5) In **Blend Start Position**, align the blending start position with the edge (2) of the image.
- (6) Press the [Esc] button.
- (7) In **Blend Range**, adjust the range (3) to be shaded.
The value for when the overlapped range and the guide are in the same position is the best.
- (8) In **Blend Curve**, adjust how to apply shading.
- (9) Press the [Esc] button.

- 8** After the settings are complete, set **Line Guide** and **Pattern Guide** to **Off** to finish.

Black Level

When a black image is displayed, only areas where the images overlap stand out. The black level function allows you to match the brightness and tone for areas where the images do not overlap with areas where the images overlap, to make the difference less noticeable.

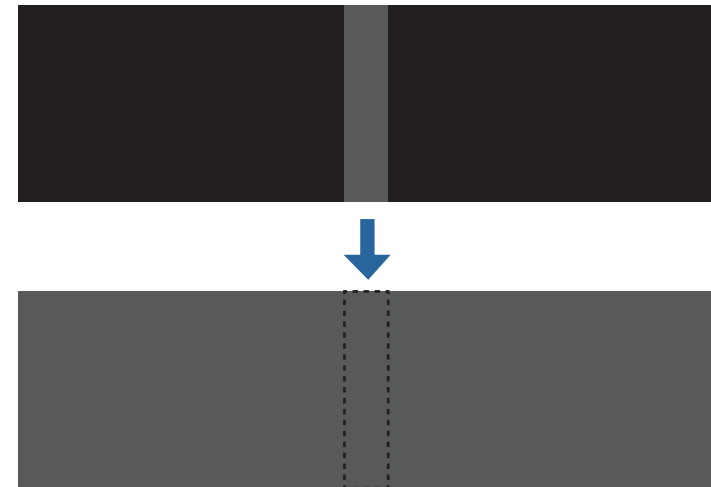

- You cannot perform **Black Level** when **Edge Blending** is set to Off or no edge position has been selected.
- You cannot adjust the Black Level when a test pattern is displayed.
- If the **Geometry Correction** value is large, you may not be able to adjust correctly.
- The brightness and tone may differ in areas where the images overlap as well as in other areas even after performing black level adjustment.
- When auto adjustment starts for Screen Matching, the settings for Color Adjustment are automatically adjusted.
 - ☛ "Automatically correct the brightness and tint for multiple projectors" [p.96](#)

- 1** Select **Black Level** from **Multi-Projection**, and then press the [**↵**] button.
- 2** Select **Color Adjustment**, and then press the [**↵**] button.
The areas are displayed based on the settings for **Top Edge/Bottom Edge/Right Edge/Left Edge**.

- 3** Select the area you want to adjust, and then press the [**↵**] button.

The selected area is displayed in orange.

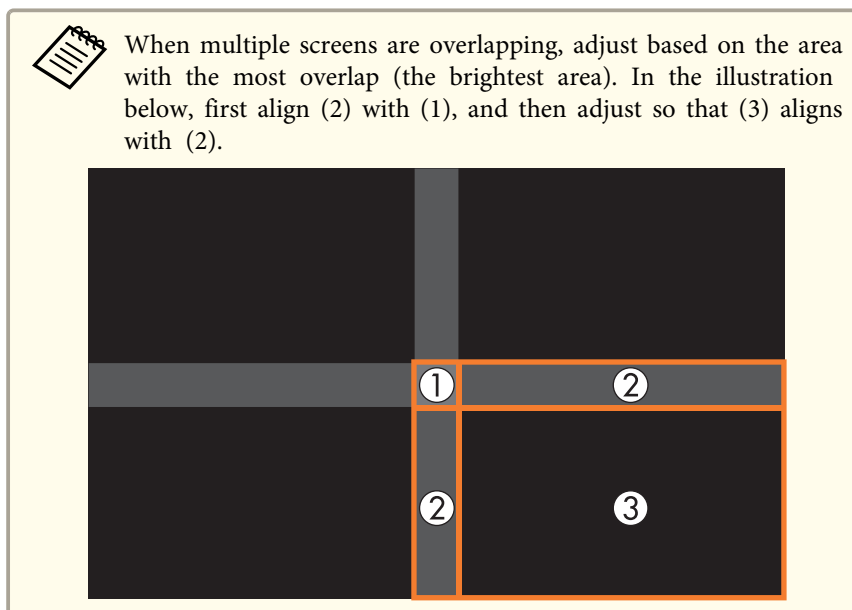

- 4** Adjust the black tone and brightness.



- 5** Repeat steps 3 and 4 as needed to adjust any remaining parts.

- 6** To complete the adjustment, press the [Menu] button.

Area Correction

If there are areas where the color does not match after adjusting the Black Level, adjust individually in **Area Correction**.



- 1** Select **Black Level** from **Area Correction**, and then press the [**↵**] button.
- 2** Select **Start Adjustments**, and then press the [**↵**] button.
Boundary lines that indicate areas where images overlap are displayed.
The boundary lines are displayed based on the settings for **Top Edge/Bottom Edge/Right Edge/Left Edge**.
- 3** Use the [**▲**][**▼**][**◀**][**▶**] buttons to select a boundary line of the area you want to adjust.

The selected line is displayed in orange.



- 4 Press the [**↵**] button to confirm the selection.
- 5 Use the [**▲**][**▼**][**◀**][**▶**] buttons to adjust the boundary line positions, and then press the [**↵**] button.
- 6 Press the [**▲**][**▼**][**◀**][**▶**] buttons to select the point you want to move, and then press the [**↵**] button.

The selected point is displayed in orange.

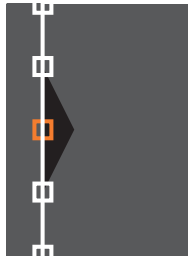

- 7 Press the [**▲**][**▼**][**◀**][**▶**] buttons to move the point.
To continue to move another point, press the [Esc] button to return to step 6, and then repeat steps 6 and 7.
To adjust another boundary line, press the [Esc] button until the screen for selecting a boundary line from step 3 is displayed.



To return **Black Level** to its default value, press the [Esc] button to return to the screen from step 1, select [Reset], and then press the [**↵**] button.

- 8 To complete the adjustment, press the [Menu] button.

Screen Matching

Adjust the tint and brightness for multiple projectors.

When projectors are connected to a network, the tint and brightness for multiple projectors are automatically adjusted based on the darkest projector.

When projectors are not connected to a network, or if auto adjustment does not work, you can adjust the tint and brightness for all projectors manually.



- We recommend performing Screen Matching at least 20 minutes after turning on the projector or canceling the shutter function.
- To increase the accuracy of adjustments, we recommend darkening the room while projecting images and then making adjustments.
- Perform the following on the master projector before starting adjustments.
 - Set the **Color Mode** to **Multi-Projection** with the remote control's [Color Mode] button.
 - Press the [Shutter] button on the remote control to release the shutter.
 - Adjust the following items on the Image menu as necessary.
Brightness, Contrast, Color Saturation, Tint, White Balance, Advanced
☛ "Image Menu" [p.141](#)
 - Set the brightness of the projected image.
☛ "Setting the Brightness" [p.75](#)



- When a particularly dark projector is included in the group, the brightness is automatically adjusted according to the dark projector. Use the following method to select the master projector.
 - When you want the image to be as bright as possible:
Set the **Light Source Mode** for all projectors to **Normal** or **Custom - Brightness Level - 100%**. For the master projector, select a projector whose color and brightness you want to use as the standard.
 - When you want to match to a specific brightness:
Set the projector with the darkest projected image as the master projector, and then use **Light Source Mode - Custom - Brightness Level** to adjust it so that it has a specific brightness.
☛ **Settings - Brightness Settings - Light Source Mode, Brightness Level** [p.143](#)
- When there are large differences in the brightness for each projector due to aging light sources, perform Screen Matching again.
- See the following if Screen Matching does not work correctly.
☛ "Automatic adjustments are not performed correctly" [p.206](#)



- Auto adjustment is not available when using the following lenses. ELPLR05, ELPLL09, and ELPLL10
- After auto adjustment, lens shift may not work for some lenses.
☛ "Adjusting the Position of the Projected Image (Lens Shift Adjustment)" [p.37](#)

Automatically correct the brightness and tint for multiple projectors

The brightness and tint for the arranged images are adjusted automatically based on the darkest projector.



- Check the following before starting auto adjustment.
 - The projector is connected to the network
 - The **Location Setup** for the projector has already been set
 - The **Brightness Level** is set to the maximum for all projectors
☛ **Settings - Brightness Settings - Light Source Mode, Brightness Level** [p.145](#)
- Auto adjustment is performed using the camera built into the front of the projector. Do not block the camera or the projected images.
- The time necessary for auto adjustment varies according to the location and number of projectors and can take up to approximately 17 minutes.
- Settings are auto adjusted for Brightness Settings, Black Level (**Color Adjustment** only), and Blend Curve.
- After making automatic adjustments, Color Uniformity and Color Matching are returned to their defaults.
- After performing auto adjustment, Light Source Control is set to Off.
- You can schedule this from **Schedule Settings**.

Operating conditions for auto adjustment functions

The auto adjustment functions for Screen Matching are enabled when the following conditions are met.

- The screen surface is flat and not skewed or warped
- Using a matte white diffusion screen
- The projection size for each projector is 100 to 300 inches
- The projected image after tiling is rectangular
- There are no gaps between projected images (or part of the images overlap)
- The projector is setup parallel to the projection surface
- The blend width for edge blending is 15 to 45%
- All projectors have the following model numbers
 - EB-L30002U/EB-L30000U

- 1 Select **Screen Matching** from **Multi-Projection**, and then press the [**↵**] button.
- 2 Select **Start Auto Adjustment**, and then press the [**↵**] button.

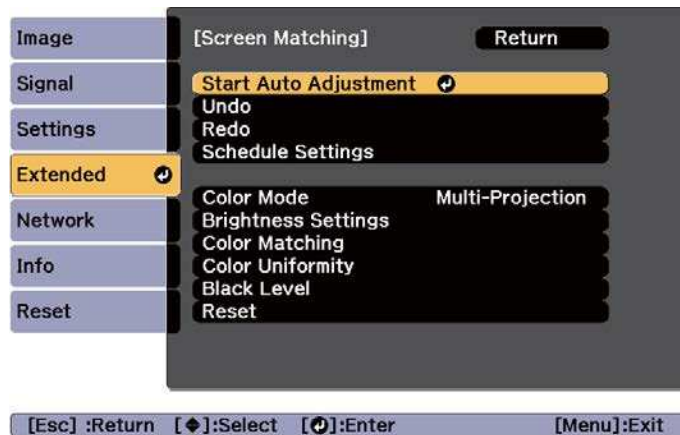

When a message is displayed, select **Yes**. The adjustment pattern is displayed, and adjustment starts. If the projected image is displayed before the adjusting, the procedure is complete.



- See the following if an error occurs.
 - ☛ "Automatic adjustments are not performed correctly" [p.206](#)
- To return to the status before auto adjustment, select **Undo**. When you select **Redo** after selecting **Undo**, it returns the image to the status after auto adjustment.
- If the amount of blend width or lens shift is too large, blend curve may not be corrected properly. Adjust the **Blend Curve** manually.
 - ☛ "Edge Blending" [p.91](#)
- To return **Screen Matching** to its default value, select **Reset**.

Color Matching

You can fine tune the color balance and brightness from black to white for each color tone.

When the projectors are not connected to a network, or if you want to adjust manually after the automatic adjustments, perform the following steps on all projectors.



We recommend that you reset the following settings on the **Image** menu to display the adjustment screen at the appropriate brightness and color.

- Brightness
- Contrast
- Color Saturation
- Tint
- White Balance (Color Temp., G-M Correction, Offset R, Offset G, Offset B, Gain R, Gain G, Gain B)
- Gamma
- RGBCMY

- 1 Select **Screen Matching** from **Multi-Projection**, and then press the [**↵**] button.
- 2 Select **Color Matching**, and then press the [**↵**] button.

The following screen is displayed.

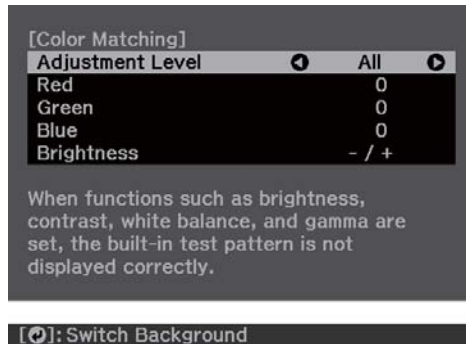

Half of the overlapped area is displayed in black so that it is easy to check the edge of the image.

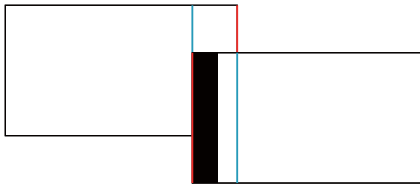

Adjustment Level: There are eight levels from **All**, white, through gray, and up to black. When you select **All**, you can adjust the color for each color in Adjustment Level 2 to 8 at the same time. (Once the red, blue, and green values are at their maximum or minimum position at any level, you cannot make any further adjustments.) Select Adjustment Level 1 to 8 to adjust each level individually.

Red, Green, Blue: Adjusts the tone for each color.

Brightness: Adjusts the image brightness.



Whenever the [↵] button is pressed, the screen changes between the projected image and the adjustment screen.

- 3 Select **Adjustment Level**, and then use the [◀][▶] buttons to set the adjustment level.

- 4 Select **Red**, **Green**, or **Blue**, and then press the [◀][▶] buttons to adjust the color tone.
- 5 Select **Brightness**, and then use the [◀][▶] buttons to adjust the brightness.
- 6 Return to step 2 and adjust each level.
- 7 Press the [Esc] button to return to the previous screen.

Displaying a Scaled Image

A section of the image is cropped and displayed. This allows you to create one large image by combining images projected from multiple projectors.

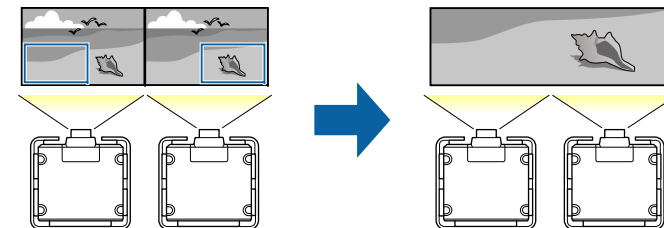

- 1 Project the image, and then press the [Menu] button.
- 2 Select **Multi-Projection** from **Extended**.



You can also perform the same operation from **Scale** in **Signal**.

- 3 Select **Scale**, and then press the [↵] button.

4 Turn on **Scale**.

(1) Select **Scale**, and then press the [**↵**] button.

(2) Select **Auto** or **Manual**, and then press the [**↵**] button.

Auto: Automatically adjusts the clipped area according to the adjustment values in Edge Blending and Tiling. After selecting **Auto**, you can then select **Manual** to fine tune adjustments from step 6 onwards.

Manual: Allows you to adjust the clipped area manually.

(3) Press the [Esc] button to return to the previous screen.



If auto adjustment does not work for the clipped image, adjust the aspect ratio, and then select **Auto**.

☞ "Changing the Aspect Ratio of the Projected Image" [p.78](#)

5 Set **Scale Mode**.

(1) Select **Scale Mode**, and then press the [**↵**] button.

(2) Select **Zoom Display** or **Full Display**, and then press the [**↵**] button.

Zoom Display: Adjusts according to the image currently displayed.

Enlarge



Move



Full Display: Adjusts according to the projector's panel size (the maximum area in which an image can be displayed).

Enlarge



Move



(3) Press the [Esc] button to return to the previous screen.

6 Adjust the scale.

Select the adjustment method with the [▲][▼] buttons, then adjust using the [◀][▶] buttons. (Minimum magnification of 0.5 to maximum magnification of 10)

-+: Enlarges or reduces an image horizontally and vertically at the same time.

Scale Vertically: Enlarges or reduces an image vertically.

Scale Horizontally: Enlarges or reduces an image horizontally.

7 The image is clipped and adjusted.

- (1) Select **Clip Adjustment**, and then press the [↵] button.
If you select **Clip Range**, the range and coordinates of the image that the projector will project is displayed.
- (2) Use the [▲], [▼], [◀], and [▶] buttons to scroll the image.
Adjust the coordinates and size of each image while viewing the screen.
- (3) Press the [Menu] button to finish making settings.



You can check the displayed area after clipping for the entire image from **Clip Range**.

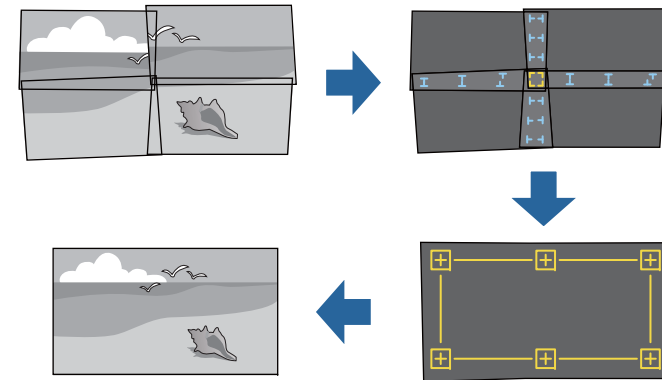

You can run this feature from Epson Projector Professional Tool (version 1.20 or later). Download the software from the following Web site.

<http://www.epson.com>

Operating conditions for auto adjustment functions

The tiling function of geometry correction assist works under the following conditions.

- The screen surface is flat and not skewed or warped
- Using a matte white diffusion screen
- The illuminance ratio of the screen when projecting an all-white screen and when projecting an all-black screen is 8:1 or more
- The projection size for each projector is 100 to 500 inches
(When projecting onto a screen surface with an illuminance of 40 lux or lower with the **Light Source Mode** set to **Normal**)
- The projected image after tiling is rectangular
- Parts of all projected images are overlapping
- The projector is setup parallel to the projection surface
- The blend width for edge blending is 15 to 43%

Using Tiling Function of Geometry Correction Assist

By using the projector's built-in camera and the Edge Blending feature, you can create a seamless image by automatically adjusting the pixel position in overlapping areas of the image.

- All of the projectors support the tiling function of geometry correction assist
- All of the projectors have the same panel resolution
- All of the projectors are projecting with the Projection mode set to Front or Front/Ceiling
- The stacking function of geometry correction assist is not being used



- We recommend performing auto adjustment at least 20 minutes after turning on the projector or canceling the shutter function.
- To increase the accuracy of adjustments, we recommend darkening the room while projecting images and then making adjustments.
- Auto adjustment is not available when using the following lenses. ELPLR05, ELPLL09, and ELPLL10
- Check the following before starting auto adjustment.
 - The projector is connected to the network
 - The projector has been configured in Epson Projector Professional Tool
- Auto adjustment is performed using the camera built into the front of the projector. Do not block the camera or the projected images.
- The time necessary for auto adjustment varies according to the location and number of projectors and can take up to approximately 6 minutes.
- The settings for Point Correction and Black Level are corrected automatically.

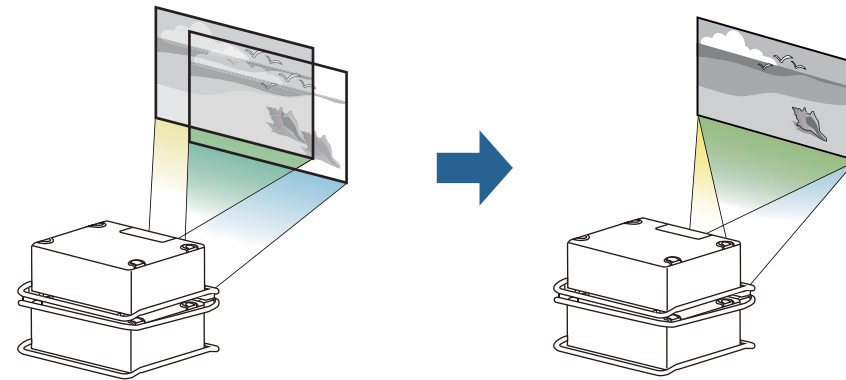

You can run this feature from Epson Projector Professional Tool (version 1.31 or later). Download the software from the following Web site.

<http://www.epson.com>

Operating conditions for auto adjustment functions

The stacking function of geometry correction assist works under the following conditions.

- The screen surface is flat and not skewed or warped
- Using a matte white diffusion screen
- The illuminance ratio of the screen when projecting an all-white screen and when projecting an all-black screen is 8:1 or more
- The projection size is 100 to 500 inches
(When projecting onto a screen surface with an illuminance of 40 lux or lower with the **Light Source Mode** set to **Normal**)
- The screen gain is 0.9 to 1.1
- The projected image after stacking is rectangular
- The projector is setup parallel to the projection surface

Using the Stacking Function of Geometry Correction Assist

By using the projector's built-in camera, you can overlap images from up to six projectors to project one, bright image.

- All of the projectors support the stacking function of geometry correction assist
- All of the projectors have the same panel resolution
- All of the projectors are projecting with the Projection mode set to Front or Front/Ceiling
- The projection size for all of the projectors is larger than the projection size after stacking
- The tiling function of geometry correction assist is not being used



- We recommend performing auto adjustment at least 20 minutes after turning on the projector or canceling the shutter function.
- To increase the accuracy of adjustments, we recommend darkening the room while projecting images and then making adjustments.
- Auto adjustment is not available when using the following lenses. ELPLR05, ELPLL09, and ELPLL10
- Check the following before starting auto adjustment.
 - The projector is connected to the network
 - The projector has been configured in Epson Projector Professional Tool
- Auto adjustment is performed using the camera built into the front of the projector. Do not block the camera or the projected images.
- The time necessary for auto adjustment varies according to the location and number of projectors and can take up to approximately 10 minutes.
- Point Correction is performed automatically.

Projecting Two Images Simultaneously (Split Screen)

You can simultaneously project images from two sources on the right and left of the screen.

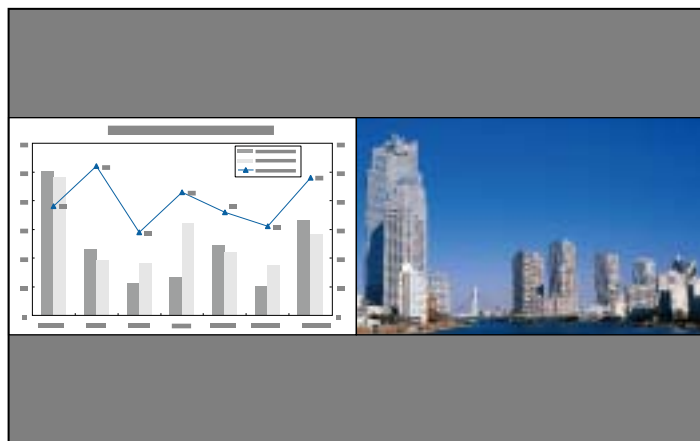

Input Sources for Split Screen Projection

The combinations of input sources that can be projected on a split screen are listed below.

Left Screen	Right Screen						
	HDMI	HDBa-seT	DVI-D	SDI	Com-puter	BNC	LAN
HDMI	-	✓	✓	✓	✓	✓	✓
HDBaseT	✓	-	✓	✓	✓	✓	✓
DVI-D	✓	✓	-	✓	✓	✓	✓
SDI	✓	✓	✓	-	-	-	-
Computer	✓	✓	✓	-	-	-	-
BNC	✓	✓	✓	-	-	-	-
LAN	✓	✓	✓	-	-	-	-



- Signals with a horizontal resolution that exceeds 1920 are not supported.
- If **4K Enhancement** is enabled, a message is displayed. Select **Yes** to disable **4K Enhancement**.
 **Image - Image Enhancement - 4K Enhancement** [p.141](#)

Operating procedures

Projecting on a split screen

- 1** Press the [Menu] button while projecting.
- 2** Select **Split Screen** from **Settings**.
The currently selected input source is projected on the left of the screen.

- Press the [Menu] button.
The Split Screen Setup screen is displayed.

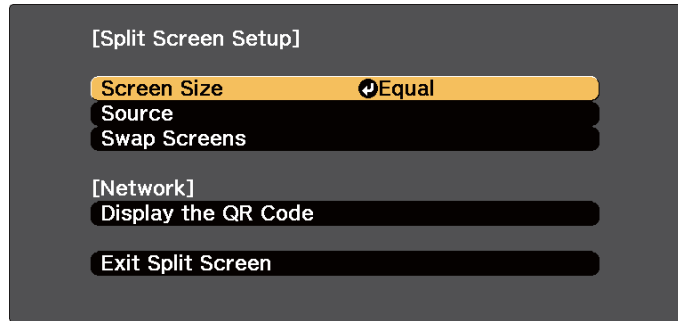

[↩]:Select [↵]:Enter [Menu]:Exit

- Select **Source**, and then press the [↵] button.
- Select each input source for **Left** and **Right**.

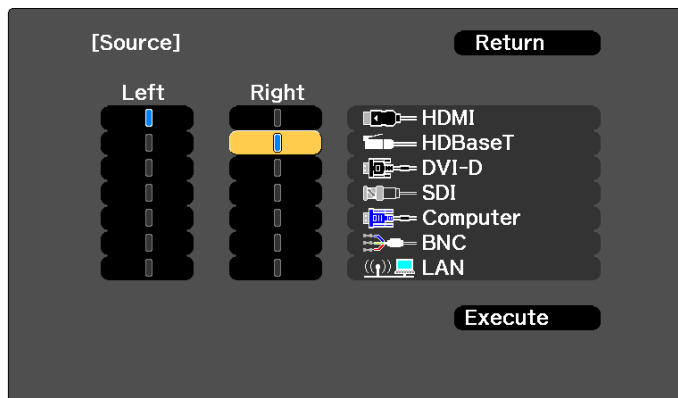

[Esc]:Return [↩]:Select [↵]:Set [Menu]:Exit



You can perform the same operations using the following procedure.

- "Automatically Detecting Input Signals and Changing the Projected Image (Source Search)" [p.60](#)
- "Switching to the Target Image" [p.61](#)

- Select **Execute**, and then press the [↵] button.

To switch the source during split screen projection, start the procedure from step 2.

Switching the left and right screens

Use the following procedure to switch the projected images displayed on the left and right screens.

- Press the [Menu] button during split screen projection.
- Select **Swap Screens**, and then press the [↵] button.
The projected images on the left and right are swapped.

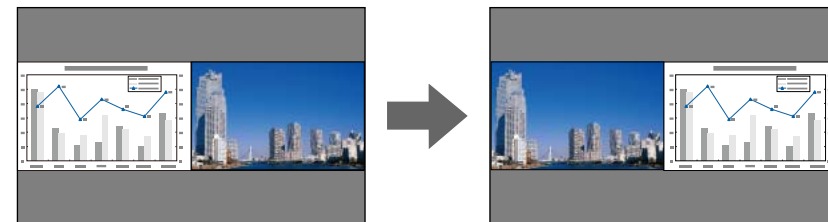

Switching the left and right image sizes

- Press the [Menu] button during split screen projection.
- Select the **Screen Size**, and then press the [↵] button.

- 3** Select the screen size you want to display, and then press the [↵] button.

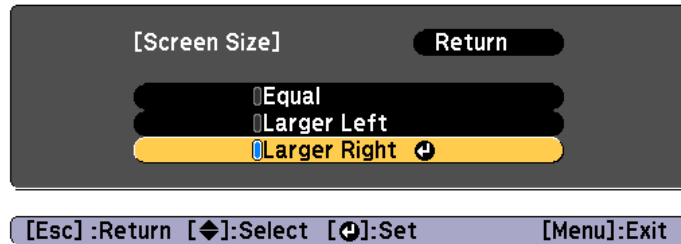

The projected images will appear as shown below after setting the screen size.

Equal

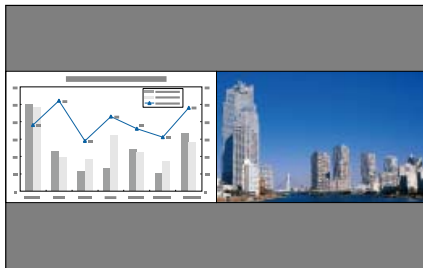

Larger Left

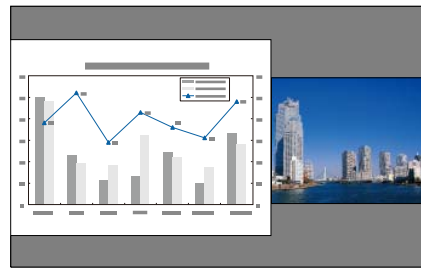

Larger Right

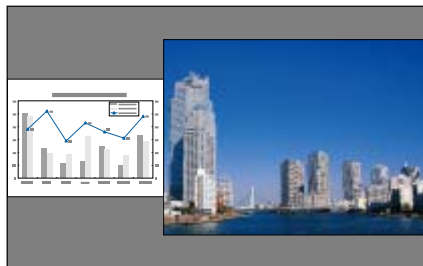

- You cannot enlarge both the left screen and right screen images at the same time.
- When one image is enlarged, the other image is reduced.
- Depending on the video signals that are input, the images on the left and right may not appear to be the same size even if **Equal** is set.

Ending the split screen

Perform one of the following operations to end split screen.

- Press the [Esc] button.
- Select **Exit Split Screen** on the Split Screen Setup screen.  [p.103](#)

Restrictions during split screen projection

Operating restrictions

The following operations cannot be performed during split screen projection.

- Setting the configuration menu
- Changing the aspect mode
- Using the [User1], [User2], or [User3] button on the remote control
- Help can be displayed only when image signals are not input or when an error or warning notification is displayed.
- The user's logo is not displayed.

Restriction relating to images

- For the image on the right screen, the default values for the **Image** menu are applied. Adjustments that affect the entire projected image such as **Color Mode** and **Color Temp.** are applied for both left and right images.

- **Deinterlacing, Noise Reduction, and MPEG Noise Reduction** are only enabled for the left screen.

Hiding the Image Temporarily (Shutter)



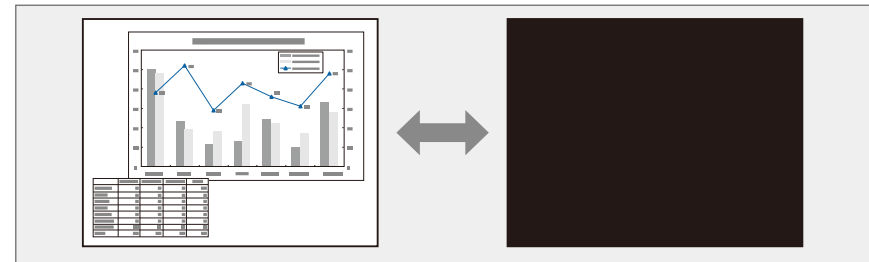

When using Shutter, the mechanical shutter closes and projection stops.

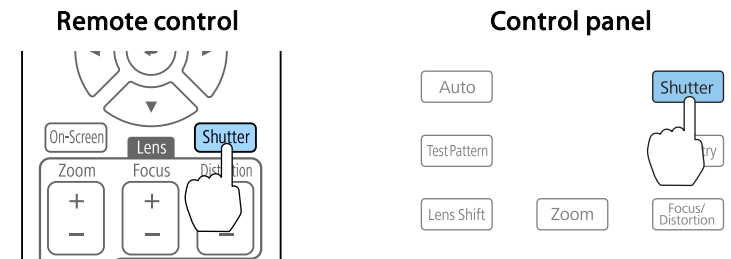

Each time you press the [Shutter] button, the Shutter function turns on or off.





- The light source remains on when using Shutter.
- If you want to fade out or fade in when turning the video on or off, set the desired number of seconds in **Fade-out** and **Fade-in**.
 **Extended - Operation - Shutter Settings - Fade-out, Fade-in** p.147
- When the shutter function is activated and no operations are performed for about two hours, the projector turns off automatically. If you do not want to turn off the power, set **Shutter Timer** to **Off**.
 **Extended - Operation - Shutter Settings - Shutter Timer** p.147
- When **Shutter Release** is set to **Shutter** in the configuration menu, the following operations can be performed while the shutter function is still activated.
 - Change the source with the change input buttons on the remote control.
 - Control the projector from a computer using communication commands.
 **Extended - Operation - Shutter Settings - Shutter Release** p.147
 The shutter function is only released by pressing the [Shutter] button, or by sending a command to release the shutter function.
- You can set the shutter status when the projector is turned on or standing by.
 **Extended - Operation - Shutter Settings - Startup, Standby** p.147
- When projecting moving images, the images continue to be played back while the Shutter function is activated. It is not possible to resume projection from the point where the Shutter function was activated.

Freezing the Image (Freeze)

When Freeze is activated on moving images, the frozen image continues to project on the screen, so you can project a moving image one frame at a time like a still photo. Also, you can perform operations such as changing between files during presentations from a computer without projecting any images if the Freeze function is activated beforehand.

Each time you press the [Freeze] button on the remote control, Freeze turns on or off.

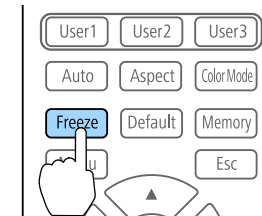

- When projecting moving images, the images continue to be played back while the screen is frozen. It is not possible to resume projection from the point where the screen was frozen.
- If the [Freeze] button is pressed while the Configuration menu or the Help screen is displayed, the menu or the Help screen that is displayed is closed.

Saving a User's Logo

You can save the image that is currently being projected as a User's Logo.



- When **User's Logo Protection** from **Password Protection** is set to **On**, a message is displayed and the User's Logo cannot be changed. Perform operations after setting **User's Logo Protection** to **Off**.
 - ☛ "Managing Users (Password Protection)" [p.115](#)
- If you use the batch setup function to copy menu settings between multiple projectors, the User's Logo is also copied. Do not set images that you do not want to share across multiple projectors as the User's Logo.

1 Project the image you want to save as the User's Logo, and then press the [Menu] button.

☛ "Configuration Menu Operations" [p.137](#)

2 Select **User's Logo** from **Extended**.



When you select **User's Logo**, settings such as Geometry Correction, Aspect, Scale, and Screen Type are temporarily disabled.

3 Select **Start Setting**, and then press the [↵] button.

The confirmation screen is displayed.

4 Select **Yes**, and then press the [↵] button.

5 When the message "Save this image as the User's Logo?" is displayed, select **Yes**.

The image is saved. After the image has been saved, the message "Completed." is displayed.



Select **Reset** to delete the image you registered and return to the default settings.

The settings for the image currently displayed and values for geometry correction are saved as a memory, allowing you to load them when necessary.

Saving/Loading/Erasing/Resetting the Memory

- 1 Press the [Memory] button while projecting.

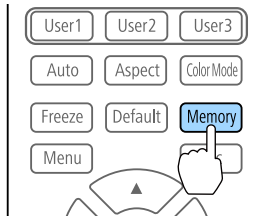

You can also operate from the Configuration menu.

☛ Settings - Memory [p.145](#)

- 2 Select a memory type, and then press the [↵] button.

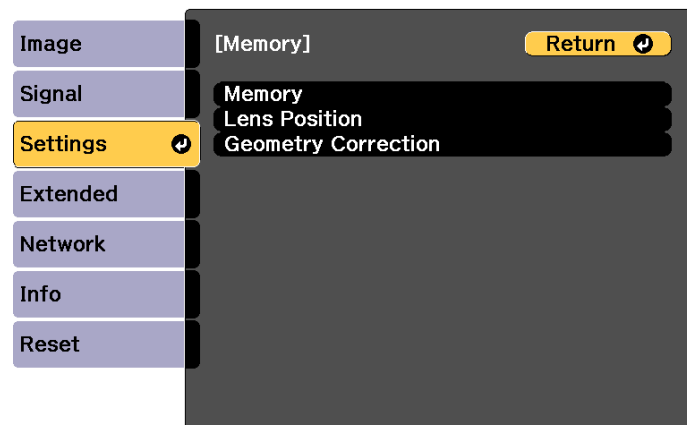

[Esc] / [⏪]:Return [⏩]:Select [Menu]:Exit

Memory: Settings for the following menu items are saved in the memory. You can register up to 10 values.

Top Menu	Submenu
Image	All setting items
Signal	Overscan Video Range Scale
Settings	Brightness Settings
Extended	Edge Blending Black Level Color Matching

Lens Position: Registers the position of the lens adjusted using lens shift, zoom, focus, and distortion. You can register up to 10 values.
☛ "Registering and Loading Lens Adjustment Values" [p.42](#)

Geometry Correction: Adjustment value of the geometry correction is saved. You can register up to 3 values.



If the projector cannot determine the model number of your lens, you cannot save or load memories for **Lens Position** and **Geometry Correction**.

- 3 Select the function you want to perform, then press the [↵] button.

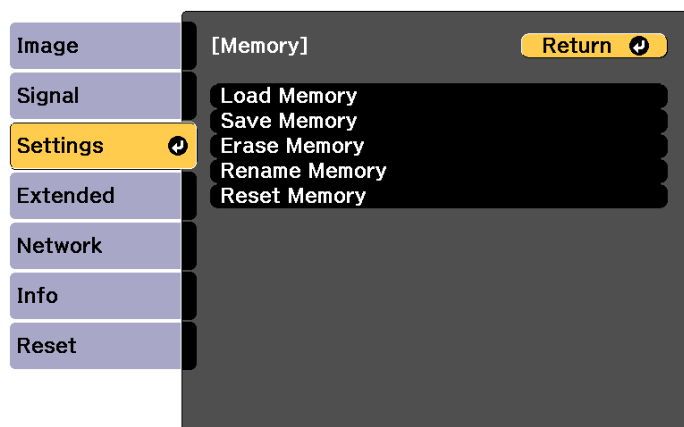

[Esc] / [Return]:Return [Left Arrow]:Select [Menu]:Exit

Function	Explanation
Load Memory	Loads the saved memory. When you select a memory and press the [Left Arrow] button, the settings applied to the current image are replaced with the settings from the memory.
Save Memory	Registers current settings in the memory. When you select a memory name and press the [Left Arrow] button, the settings are saved.
Erase Memory	Erases the registered memory. When you select a memory name and press the [Left Arrow] button, a message is displayed. Select Yes , and then press the [Left Arrow] button to erase the selected memory.
Rename Memory	Changes the memory name. Select the memory name you want to change, and then press the [Left Arrow] button. Enter the memory name using the soft keyboard. ☛ "Soft keyboard operations" p.153 When you have finished, move the cursor over Finish , and then press the [Left Arrow] button.

Function	Explanation
Reset Memory	Resets the name and settings of a saved memory. To reset all memories saved in Memory , Lens Position , and Geometry Correction , use Reset All Memories . ☛ Reset - Reset All Memories p.163



If the mark on the left of the memory name is turned blue, it means the memory has already been registered. When you select a registered memory, a message is displayed asking you to confirm that you want to overwrite the memory. If you select **Yes**, the previous settings are deleted and the current settings are registered.

You can schedule turning the projector power on/off and switching the input source, as events in the schedule. Registered events are executed automatically at the specified time on the specified dates or weekly. You can register up to 30 events in **Schedule**, and one event in **Extended Schedule**.

Saving an Event

Setting an Event

- 1 Press the [Menu] button while projecting.
☞ "Configuration Menu Operations" [p.137](#)
- 2 Select **Schedule Settings** from **Extended**.
- 3 Select **Add New** from **Schedule** or **Extended Schedule**.

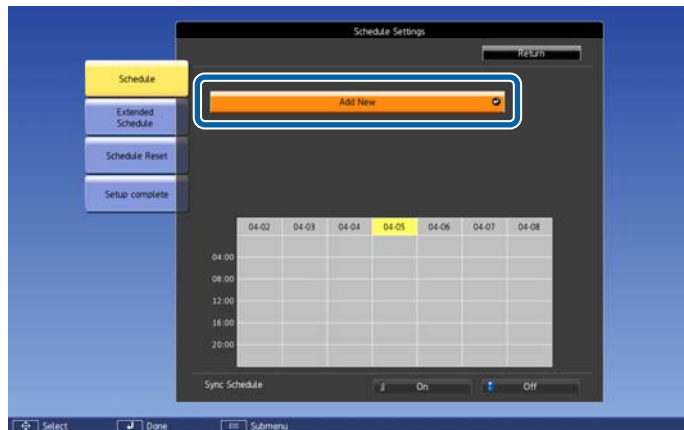

- 4 Set the schedule.

Submenu Name	Function
Event Settings	Select an operation of the projector when the event is executed. Select No Change for items that you do not want to change when the event occurs. You can set the following item operations. <p>Schedule</p> <ul style="list-style-type: none"> • Power • Source • Light Source Mode • Shutter • Light Source Calibration • Refresh Mode <p>Extended Schedule</p> <ul style="list-style-type: none"> • Color Calibration • Screen Matching
Date / Time Settings	Set the date, day of the week, and time to execute the event. You can set up to four weeks later. Use the soft keyboard to enter the date and time. <p>☞ "Soft keyboard operations" p.153</p>

- 5 Select **Save**, and then press the [↩] button.
To register additional events, repeat steps 3 to 5.



Make sure you perform Screen Matching after executing Light Source Calibration.

- 6 When you have set Light Source Calibration or Screen Matching events and you want to apply this schedule to other projectors with tiling settings, set **Sync Schedule** to **On**.
- 7 Select **Setup complete**, and then select **Yes** to finish saving.



- Light source calibration does not start automatically when the projector is used continuously for more than 24 hours, or when direct shutdown is used regularly. Set **Light Source Calibration** to enable this function after every 100 hours of usage.
- When **Light Source Calibration** is enabled, turn on the projector at least 20 minutes before the event.
- You cannot register a schedule in which Schedule events conflict with an Extended Schedule event.
- You cannot set other events before the following times.
 - Five minutes before or after executing a Color Calibration event.
 - Five minutes before and 30 minutes after executing a Screen Matching event.







Checking an Event

This section explains how to check a Schedule event.

- 1** Press the [Menu] button while projecting.
- 2** Select **Schedule Settings** from **Extended**.

- Press the [◀][▶] buttons to highlight the date you want to check. The details of the events registered on the selected date are displayed. The indicator turns on when an event is saved.



-  (Blue): Enabled event
-  (Gray): Disabled event
- : Regular event
-  (Aqua): Single event
-  (Orange): Regular event
-  (Green): Communication monitoring On/Off
-  (Gray): Disabled event

Editing an Event

- Press the [Menu] button while projecting.
 "Configuration Menu Operations" p.137
- Select **Schedule Settings** from **Extended**.

- Use the [◀][▶] buttons to highlight the date containing the event you want to edit.

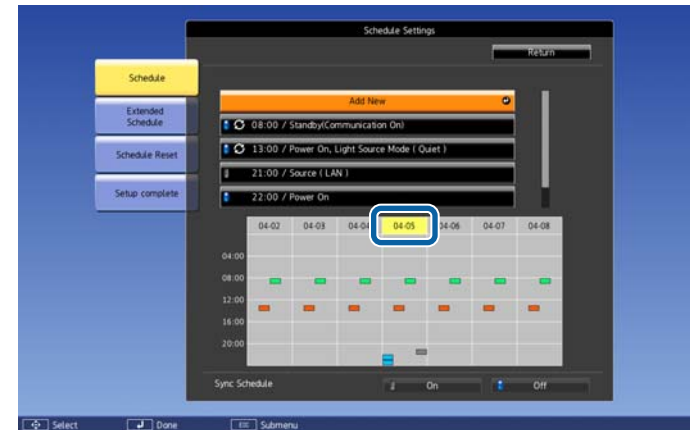

- Highlight the event you want to edit, and then press the [Esc] button.

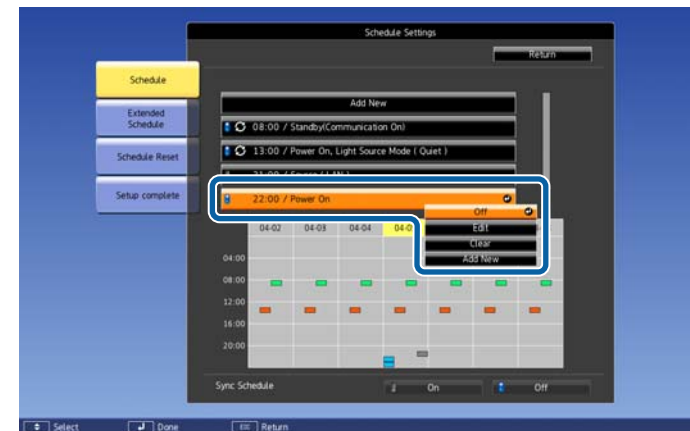

5 Edit the event.

Submenu Name	Function
On/Off	Enable or disable the selected event.
Edit	Edits the content of the selected event. Select Save , and then press the [↵] button to complete the editing.
Clear	Deletes the selected event.
Add New	Saves a new event. Select Save , and then press the [↵] button to complete registering.

6 Select **Setup complete**, and then select **Yes** to finish editing.



To delete all registered events, select **Schedule Reset**, and then select **Yes**. Select **Setup complete**, and then select **Yes** to delete the events.

The projector has the following enhanced security functions.

- **Password Protection**
You can limit who can use the projector.
- **Control Panel Lock/Remote Control Button Lock**
You can prevent people changing the settings on the projector without permission.
☛ "Restricting Operation" [p.117](#)
- **Anti-Theft Lock**
The projector is equipped with the following anti-theft security device.
☛ "Anti-Theft Lock" [p.119](#)

Managing Users (Password Protection)

When Password Protection is activated, people who do not know the password cannot use the projector to project images even if the projector power is on. Furthermore, the user's logo that is displayed when you turn on the projector cannot be changed. This acts as an anti-theft function as the projector cannot be used even if it is stolen. At the time of purchase, Password Protection is not activated.

Kinds of Password Protection

The following four kinds of Password Protect settings can be made according to how the projector is being used.

- **Power On Protection**
When **Power On Protection** is **On**, you need to enter a preset password after the projector is plugged in and turned on (this also applies to Direct Power On). If the correct password is not entered, projection does not start.

- **User's Logo Protection**

Even if someone tries to change the User's Logo set by the owner of the projector, it cannot be changed. When **User's Logo Protection** is set to **On**, the following setting changes for the User's Logo are prohibited.

- Capturing a User's Logo
- Setting **Display Background** or **Startup Screen** from **Display Extended - Display** [p.147](#)

- **Network Protection**

When **Network Protection** is set to **On**, changing the settings for **Network** is prohibited.

- ☛ "Network Menu" [p.151](#)

- **Schedule Protection**

When **Schedule Protection** is set to **On**, changing settings for the projector's system time or schedules is prohibited.

- **Remote Camera Access**

When **Remote Camera Access** is set to **On**, changing the settings for **Remote Camera Access** menu in the **Network** menu can be prohibited. The default is **On**.

Setting Password Protection

Use the following procedure to set Password Protect.

- 1** During projection, hold down the [Freeze] button on the remote control for about five seconds.

The Password Protection setting menu is displayed.

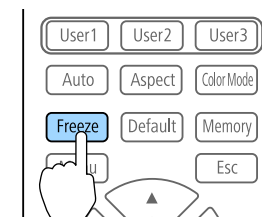



If Password Protection is already activated, you must enter the password.
If the password is entered correctly, the Password Protection setting menu is displayed.

☞ "Entering the password" p.116

- 2 Select the type of Password Protect you want to set, and then press the [**↵**] button.

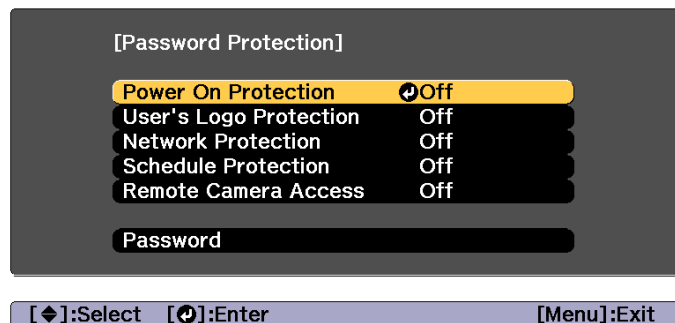

- 3 Select **On**, and then press the [**↵**] button.
Press the [Esc] button to return to the screen in step 2.

- 4 Set the password.
 - (1) Select **Password**, and then press the [**↵**] button.
 - (2) When the message "Change the password?" is displayed, select **Yes** and then press the [**↵**] button. The default password is set to "0000". Change this to your own desired password. If you select **No**, the screen displayed in step 2 is displayed again.
 - (3) While holding down the [Num] button, enter a four digit number using the numeric buttons. The number entered is displayed as "* * * *". When you enter the fourth digit, the confirmation screen is displayed.

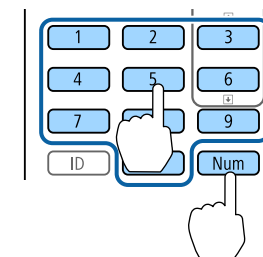

- (4) Re-enter the password.
When the message "Password accepted." is displayed.
If you enter the password incorrectly, a message is displayed prompting you to re-enter the password.

Entering the password

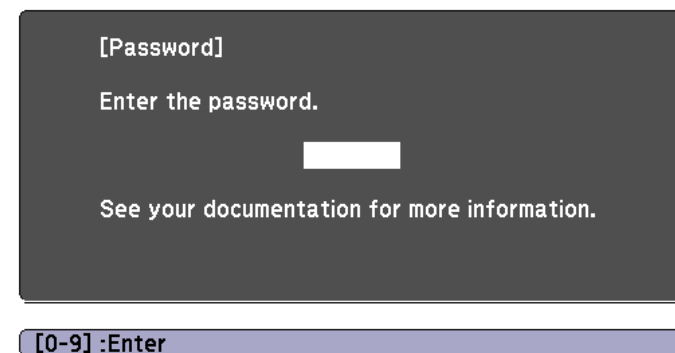

When the password entry screen is displayed, enter the password using the remote control.

While holding down the [Num] button, enter the password by pressing the numeric buttons.



When you enter the correct password, Password Protect is temporarily released.

Attention

- If an incorrect password is entered three times in succession, the message "The projector's operation will be locked." is displayed for approximately five minutes, and then the projector switches to standby mode. If this happens, disconnect the power plug from the electrical outlet and then reinsert it and turn the projector's power back on. The projector displays the password entry screen again so that you can enter the correct password.
- If you have forgotten the password, make a note of the "Request Code: xxxxx" number that appears on the screen and contact the nearest address provided in the Epson Projector Contact List.
 [Epson Projector Contact List](#)
- If you continue to repeat the above operation and input the wrong password thirty times in succession, the following message is displayed and the projector does not accept any more password entries. "The projector's operation will be locked. Contact your nearest Epson service center."
 [Epson Projector Contact List](#)

Restricting Operation

The following three kinds of operation restriction functions are available with the projector.

- **Control Panel Lock**
This is useful at events or shows when you want to deactivate all buttons during projection or at schools when you want to limit button operation.
- **Lens Lock**
This function deactivates all buttons on the remote control related to the lens operation to prevent improper lens adjustment after it is properly adjusted.
- **Remote control button lock**
This function deactivates buttons except for main buttons needed for basic remote control operation, to prevent mistakes in operations.

Control Panel Lock

Perform one of the following to lock the operation buttons on the control panel. Even if the control panel is locked, you can still use the remote control as usual.

- **Full Lock**
All of the buttons on the control panel are locked. You cannot perform any operations from the control panel, including turning the power on or off.
- **Partial Lock**
All of the buttons on the control panel, except for the [⏻] button, are locked.

- 1** Press the [🔒] button on the control panel during projection to display the Control Panel Lock screen.



You can also make settings in **Control Panel Lock** from the configuration menu.

 [Settings - Lock Setting - Control Panel Lock p.145](#)

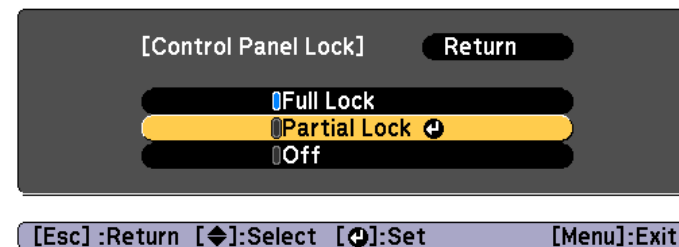

- 2** Select either **Full Lock** or **Partial Lock** according to your purpose.



- 3** Select **Yes** when the confirmation message is displayed.
The control panel buttons are locked according to the setting you chose.



You can release the control panel lock by one of the following two methods.

- Use the remote control to set **Control Panel Lock** to **Off** from the configuration menu.
 - ☛ **Settings - Lock Setting - Control Panel Lock** [p.145](#)
- Press and hold down the [] button or the [] button on the control panel for about seven seconds, a message is displayed and the lock is released.

Lens Lock

This function locks the following buttons on the remote control related to the lens operation.

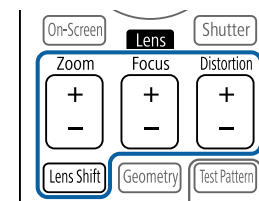



Set the **Lens Lock** to **On** in the Configuration menu.

- ☛ **Settings - Lock Setting - Lens Lock** [p.145](#)

Remote control button lock

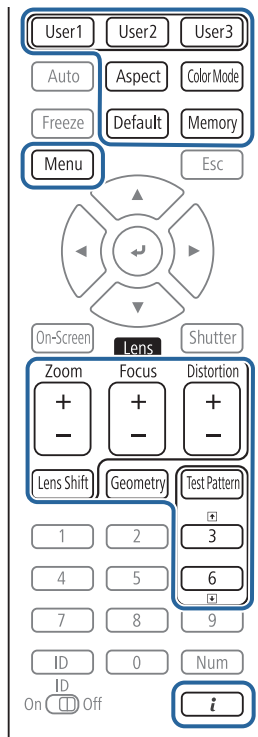
This function locks the following buttons on the remote control.



 Even if the remote control button lock is on, the following operations are possible.

- Resetting default for the Remote Receiver setting
- Releasing the remote control button lock

Anti-Theft Lock

The projector is equipped with the following types of anti-theft security devices.

- Security slot
The security slot is compatible with the Microsaver Security System manufactured by Kensington.
See the following for more details on the Microsaver Security System.
<http://www.kensington.com/>
- Handles
A commercially available theft-prevention wire lock can be passed through the installation point to secure the projector to a desk or pillar.

Each time the [i] button is pressed for approximately 5 seconds, the remote control button lock turns on or off.

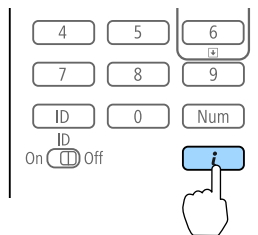

Installing the wire lock

Pass an anti-theft wire lock through the installation point.
See the documentation supplied with the wire lock for locking instructions.

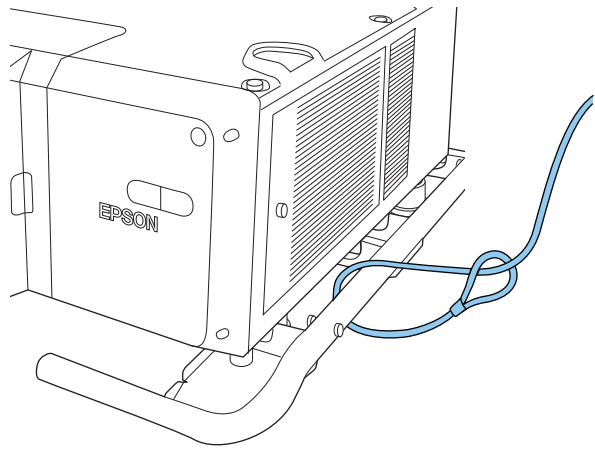



Using the Projector on a Network

Follow the instructions in these sections to set up your projector for use on a network.

You can send images to your projector through a wired network. To do this, connect the projector to your network, and then set up your projector and computer for network projection.

After connecting and setting up the projector, install Epson iProjection from the EPSON Projector Software CD-ROM (if available) or Web site.

Epson iProjection software sets up your computer for network projection. It also allows you to hold interactive meetings by projecting user's computer screens over a network. See the "Epson iProjection Operation Guide (Windows/Mac)" for instructions.

Selecting Wired Network Settings

Before you can project from computers on your network, you need to select network settings on the projector.



Make sure you already connected the projector to your wired network using the LAN port.

☛ "Connecting a LAN Cable" [p.53](#)

- 1 Press the [Menu] button on the control panel or remote control.
- 2 Select the **Network** menu and press [Enter].
- 3 Select **Network Configuration** and press [Enter].

- 4 Select the **Basic** menu and press [Enter].

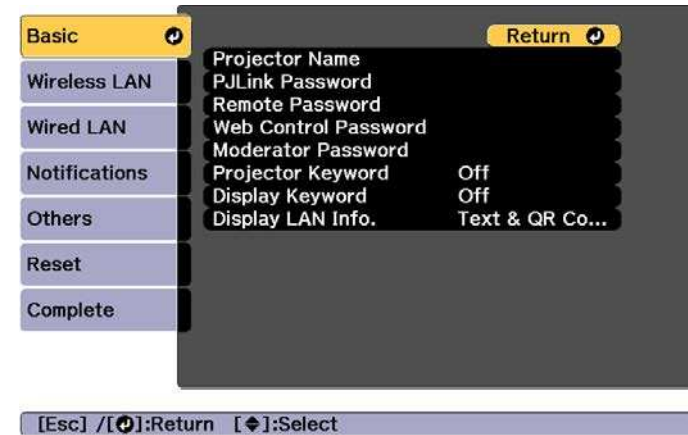

- 5 Select the basic options as necessary.
☛ "Basic menu" [p.154](#)



Use the displayed keyboard to enter the name, passwords and keyword. Press [▲][▼][◀][▶] buttons on the remote control to highlight characters and press [Enter] to select them.

- 6 Select the **Wired LAN** menu and press [Enter].

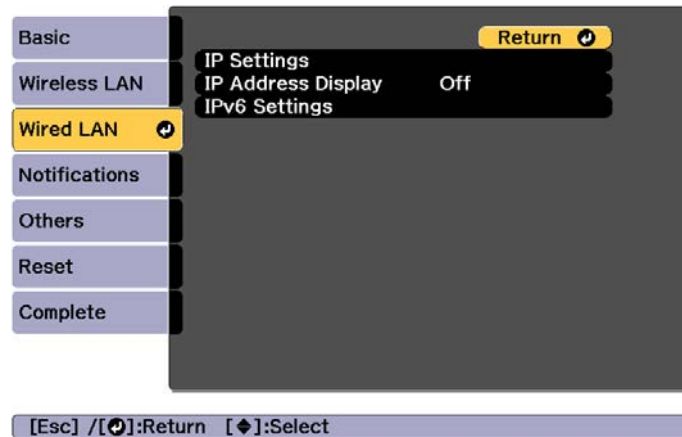

7 Assign the IP settings for your network as necessary.

- If your network assigns addresses automatically, select **IP Settings** to set the **DHCP** setting to **On**.
- If you must set addresses manually, select **IP Settings** to set the **DHCP** setting to **Off**, and then enter the projector's **IP Address**, **Subnet Mask**, and **Gateway Address** as necessary.
- If you want to connect the projector to the network using IPv6, select **IPv6 Settings**.
 ☞ "Wired LAN menu" [p.158](#)



Press the [▲][▼][◀][▶] buttons on the remote control, and then select the number you want to enter on the soft keyboard displayed. Press the [Enter] button to confirm.

8 To prevent the IP address from being displayed on the LAN standby screen, set the **IP Address Display** setting to **Off**.

9 If you have finished making settings, select **Setup complete**. Follow the on-screen instructions to save the settings and close the menu.

10 Press the [LAN] button on the remote control.

The wired network settings complete when you see the correct IP address on the LAN standby screen.

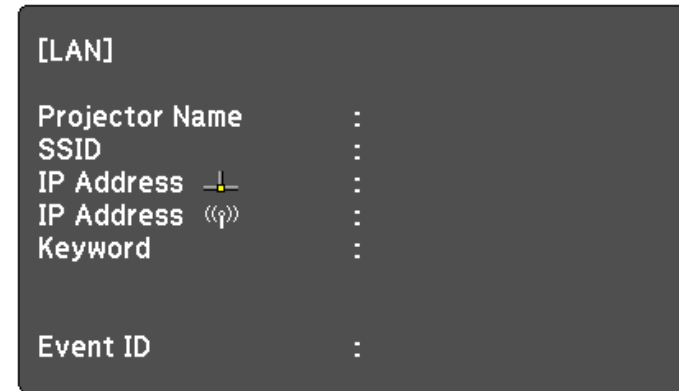

You can send images to your projector through a wireless network.

To do this, you must install the Epson 802.11b/g/n wireless LAN module, and then set up your projector and computer for wireless projection.

☛ "Installing the Wireless LAN Unit" [p.55](#)

You can connect the projector to your wireless network by configuring the connection manually using the projector's **Network** menus.

Set the projector's time before configuring the Network menu. If the time is not set, the wireless LAN may not be configured correctly.

☛ "Setting the Time" [p.44](#)

After installing the wireless LAN module and setting up the projector, install the network software from the EPSON Projector Software CD-ROM (if available) or download the software, as necessary. Use the following software and documentation to set up and control wireless projection:

- Epson iProjection (Windows/Mac) software allows you to hold interactive meetings by projecting the computer screens of users over a network. See the "Epson iProjection Operation Guide (Windows/Mac)" for instructions.
- Epson iProjection (iOS/Android) app allows you to project from iOS or Android mobile devices.
You can download Epson iProjection (iOS/Android) for free from the App Store or Google Play. Any fees incurred when communicating with the App Store or Google Play are the responsibility of the customer.
- Epson iProjection (Chromebook) allows you to project images from a Chromebook.
You can download Epson iProjection (Chromebook) for free from the Chrome Web Store. Any fees incurred when communicating with the Chrome Web Store are the responsibility of the customer.

Selecting Wireless Network Settings Manually

Before you can project from your wireless network, you need to select network settings for the projector.

- 1** Press the [Menu] button on the control panel or remote control.
- 2** Select the **Network** menu and press [Enter].
- 3** Set **Wireless Mode** to **Wireless LAN On**.

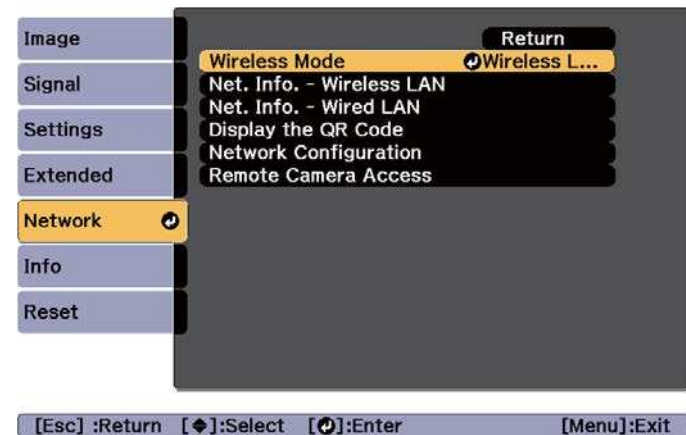

- 4** Select **Network Configuration** and press [Enter].

- 5** Select the **Basic** menu and press [Enter].

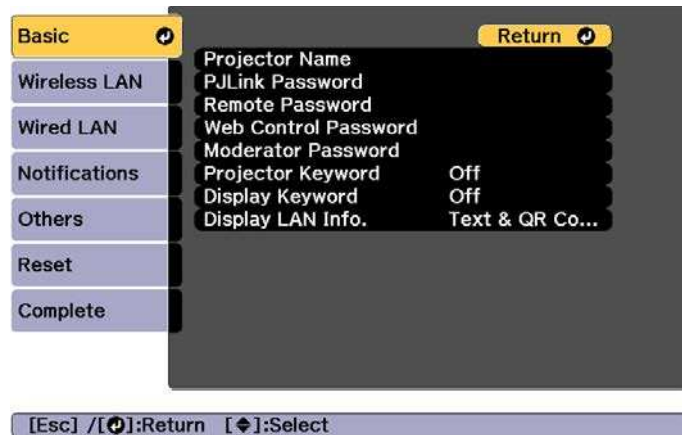

- 6** Select the basic options as necessary.

☛ "Basic menu" p.154



Use the displayed keyboard to enter the name and password. Press [▲][▼][◀][▶] buttons on the remote control to highlight characters and press [Enter] to select them.

- 7** Select the **Wireless LAN** menu and press [Enter].

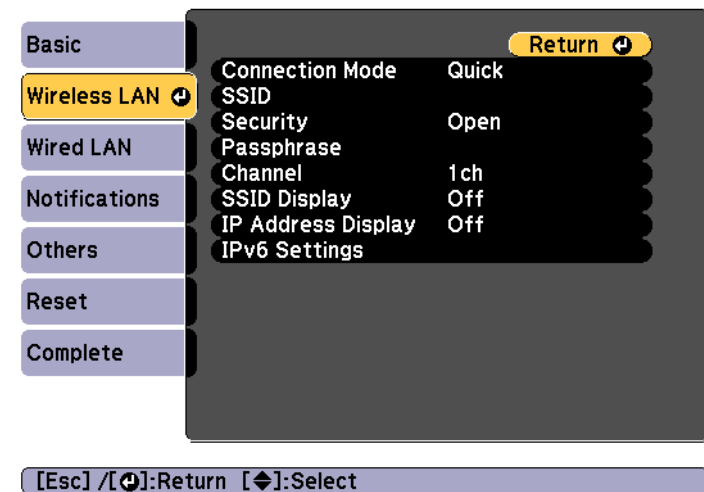

- 8** Select the **Connection Mode** setting.

- **Quick:** Lets you connect to multiple smartphones, tablets, or computers directly using wireless communication.
- **Advanced:** Lets you connect to a smartphone, tablet, or computer over a wireless LAN access point.

- 9** If you selected the **Advanced** connection mode, select **Search Access Point** to select the access point you want to connect to.



If you need to assign the SSID manually, select **SSID** to enter the SSID.

- 10** For the **Advanced** connection mode, assign the IP settings for your network as necessary.

- If your network assigns addresses automatically, select **IP Settings** to set the **DHCP** setting to **On**.

- If you must set addresses manually, select **IP Settings** to set the **DHCP** setting to **Off**, and then enter the projector's **IP Address**, **Subnet Mask**, and **Gateway Address** as necessary.
- If you want to connect the projector to the network using IPv6, select **IPv6 Settings**.

☛ "Wireless LAN menu" [p.154](#)

- 11** To prevent the SSID or IP address from being displayed on the LAN standby screen, set the **SSID Display** setting or the **IP Address Display** setting to **Off**.
- 12** If you have finished making settings, select **Setup complete**. Follow the on-screen instructions to save the settings and close the menu.
- 13** Press the [LAN] button on the remote control.
The wired network settings complete when you see the correct IP address on the LAN standby screen.

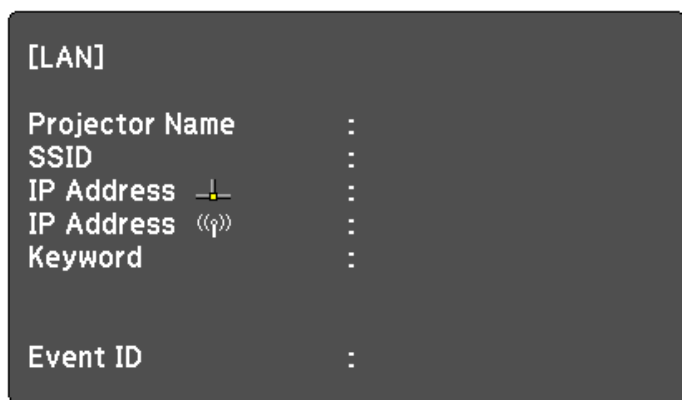

When you have finished making wireless settings for your projector, you need to select the wireless network on your computer. Then start the network software to send images to your projector through a wireless network.

Selecting Wireless Network Settings in Windows

Before connecting to the projector, select the correct wireless network on your computer.

- 1** To access your wireless utility software, double-click the network icon on the Windows taskbar.
- 2** When connecting in Advanced connection mode, select the network name (SSID) of the network the projector is connecting to.
- 3** Click **Connect**.

Selecting Wireless Network Settings in Mac

Before connecting to the projector, select the correct wireless network on your computer.

- 1** Click the AirPort icon on the menu bar at the top of the screen.
- 2** When connecting in Advanced connection mode, make sure AirPort is turned on and select the network name (SSID) of the network the projector is connecting to.

Setting Up Wireless Network Security

You can set up security for your projector to use on a wireless network. Set up one of the following security options to match the settings used on your network:

- WPA2-PSK security
- WPA2-EAP security *
- WPA/WPA2-PSK security *
- WPA/WPA2-EAP security *

* Only available for the Advanced connection mode.



Contact your network administrator for guidance on entering the correct information.

- 1 Save the certificate in a format supported by the projector in the root directory of the USB storage device.
 - ☛ "Supported Client and CA Certificates" [p.129](#)
- 2 Press the [Menu] button on the control panel or remote control.
- 3 Select the **Network** menu and press [Enter].
- 4 Select **Network Configuration** and press [Enter].
- 5 Select the **Wireless LAN** menu and press [Enter].

- 6 Select the **Security** setting and press [Enter].

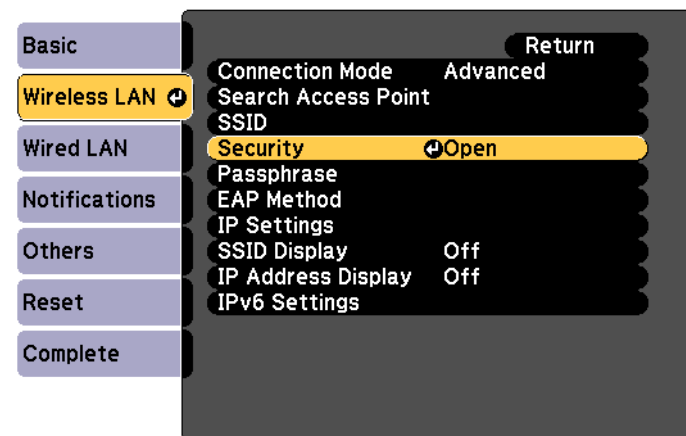

[Esc] :Return [↔]:Select [↵]:Enter

- 7 Select the security settings to match your network settings.
 - WPA2-PSK, WPA/WPA2-PSK:
Select **Setup complete**. Follow the on-screen instructions to save the settings and close the menu.
 - WPA2-EAP, WPA/WPA2-EAP:
Select **EAP Method** and press [Enter].
- 8 Select the protocol for authentication as the **EAP Type** setting.
- 9 To import your certificate, select the certificate type and press [Enter].
 - **Client Certificate** for the **PEAP-TLS** or **EAP-TLS** type
 - **CA certificate** for the **PEAP**, **PEAP-TLS**, **EAP-TLS**, or **EAP-FAST** type



You can also register the digital certificates from your Web browser. However, be sure to register just once or the certificate may not install correctly.

☛ "Setting a certificate using a Web browser" [p.134](#)

- 10** Select **Register** and press [Enter].
- 11** Connect the USB flash drive to the USB-A port on the projector.
If the wireless LAN module is already installed in the projector, remove it.
☛ "Installing the Wireless LAN Unit" [p.55](#)
- 12** Press [Enter] to display the certificate list.
- 13** Select the certificate to import using the displayed list.
A message is displayed prompting you to enter the password for the certificate.
- 14** Enter a password and press [Enter].
The certificate is imported and a completion message appears.

- 15** Select your EAP settings as necessary.

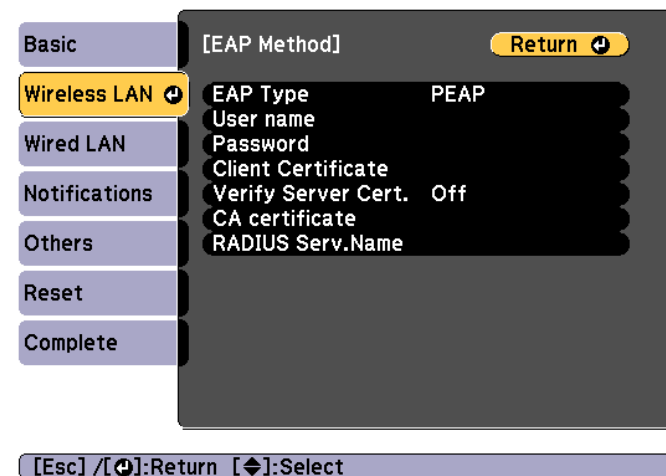

Basic	[EAP Method]	Return ↵
Wireless LAN ⬇	EAP Type	PEAP
	User name	
	Password	
	Client Certificate	
Wired LAN	Verify Server Cert.	Off
Notifications	CA certificate	
Others	RADIUS Serv.Name	
Reset		
Complete		

[Esc]/[Return]:Return [Down Arrow]:Select

- **User name:** Enter the user name. You can enter up to 64 single-byte alphanumeric characters. When entering more than 32 characters, use your Web browser to enter the text. When importing a client certificate, the name the certificate was issued to is automatically set.
- **Password:** Enter the password used for authentication in **PEAP**, **EAP-FAST**, and **LEAP**. You can enter up to 64 single-byte alphanumeric characters. When entering more than 32 characters, use your Web browser to enter the text.
- **Verify Server Cert.:** Lets you select whether or not to verify the server certificate when a CA certificate has been set.
- **RADIUS Serv.Name:** Lets you enter the server name to be verified.

- 16** If you have finished making settings, select **Setup complete**. Follow the on-screen instructions to save the settings and close the menu.

Supported Client and CA Certificates

You can register these types of digital certificates.

Client Certificate (PEAP-TLS/EAP-TLS)

Item	Explanation
Format	PKCS#12
Extension	PFX, P12
Encryption	RSA
Hashes	MD5/SHA-1/SHA-256/SHA-384/SHA-512
Key length	512/1024/2048/4096 bit
Password *	You need to setup a password. Up to 32 single-byte alphanumeric characters

CA Certificate (PEAP/PEAP-TLS/EAP-TLS/EAP-FAST)

Item	Explanation
Format	X509v3
Extension	DER/CER/PEM
Encryption	RSA
Hashes	MD5/SHA-1/SHA-256/SHA-384/SHA-512
Key length	512/1024/2048/4096 bit
Encoding	BASE64/Binary

* You can set a password using up to 64 alphanumeric characters. When entering more than 32 characters, use your Web browser to enter the text.

 "Changing Settings Using a Web Browser (Epson Web Control)"
p.230

Using a QR Code to Connect a Mobile Device

After making the wireless network settings for your projector, you can display a QR code on the screen and use it to connect a mobile device using the Epson iProjection (iOS/Android) app.



- Make sure you have installed the latest version of Epson iProjection on your device (Epson iProjection V1.3.0 or later supports this feature).
- You can download Epson iProjection for free from the App Store or Google Play. Any fees incurred when communicating with the App Store or Google Play are the responsibility of the customer.
- When using Epson iProjection in Quick, we recommend making security settings.

1 Press the [LAN] button on the remote control or select **Display the QR Code** in the projector's **Network** menu.

The QR code is displayed on the projected surface.



- If you do not see the QR code, set the **Display LAN Info.** setting to **Text & QR Code** in the projector's Network menu.
 **Network - Network Configuration - Display LAN Info.** p.151
- To hide the QR code, press the [Esc] button.
- When the QR code is hidden, press the [Enter] button to display the code.

2 Start Epson iProjection on your mobile device.

3 Read the projected QR code using Epson iProjection to connect it to the projector.



To correctly read the QR code, make sure you face the screen squarely and closely enough so that the projected code fits into the guide of the mobile device's QR code reader. If you are too far from the screen, the code may not be read.

When a connection is established, select **Contents** menu from , and then select the file you want to project.

Using a USB Key to Connect a Windows Computer

You can set up your USB flash drive as a USB key to quickly connect the projector to a wireless LAN supported Windows computer. The USB key allows you to automatically select a computer's wireless LAN settings and project images wirelessly.

- 1** Set up the USB key using Epson iProjection (Windows).
See the "Epson iProjection Operation Guide (Windows/Mac)" for instructions.
- 2** Make sure the wireless LAN module is installed.
- 3** Turn on the projector.
- 4** Press the [LAN] button on the remote control.
The LAN standby screen is displayed. Verify that an SSID and IP address are displayed.
- 5** Remove the wireless LAN module from the projector and insert the USB key into the same port used for the wireless LAN module.
 "Installing the Wireless LAN Unit" [p.55](#)
You see a projected message that the network information update is complete.
- 6** Remove the USB key.
Reinsert the wireless LAN module into the projector.
- 7** Connect the USB key to a USB port on your computer.
- 8** Follow the on-screen instructions to install the necessary application.



- If the Windows Firewall message is displayed, click **Yes** to disable the firewall.
- You need administrator authority to install the software.
- If it is not installed automatically, double-click **MPPLaunch.exe** in the USB key.

After a few minutes, your computer image is displayed by the projector. If it does not appear, press the [LAN] button on your projector's remote control or restart your computer.

9 Run your presentation.

10 When you have finished projecting wirelessly, select the **Safely Remove Hardware** option in the Windows taskbar, and then remove the USB key from your computer.



You may need to restart your computer to reactivate your wireless LAN connection.

By using the projector's LCD display while it is in standby mode, you can manually set a fixed IP address without projecting any information from the projector.



Make the following settings to set a fixed IP address when the projector is in standby mode.

- Set **A/V Output** to **Always On**.
☛ **Extended - A/V Settings - A/V Output** p.147
- Set **Standby Mode** to **Communication On**.
☛ **Extended - Standby Mode** p.147

- 1** Connect the projector with a wired LAN, and then turn on the main power switch.
- 2** Hold down the [LAN] button on the control panel for at least three seconds.
The static IP address setting menu is displayed on the LCD display.

Start
IP Setting



Press the [Esc] button to cancel the settings.

- 3** On the control panel or the remote control, press the buttons in the order [↵], [▼] to select **OFF**, then press the [↵] button.

DHCP
 ON
 OFF

- 4** On the control panel or the remote control, use the [▲][▼] buttons to change the values, use the [◀][▶] buttons to move the input position and set the IP address, and then press the [↵] button.

IP Address
192.168.100.100



You can also make settings by pressing the numeric buttons on the remote control.

- 5** Continue to set the subnet mask and gateway address if necessary, and then press the [↵] button on the confirmation screen.

Finish
IP Setting

- 6** Press the [↵] button to return to the status information screen.

You can use the HTTPS protocol to increase security between the projector and a Web browser communicating with it. To do this, you create a server certificate, install it on the projector, and turn on the **Secure HTTP** setting in the projector menus to verify the reliability of the Web browser.

☛ **Network - Network Configuration - Others - Secure HTTP** [p.151](#)

Even if you do not install a server certificate, the projector automatically creates a self-signed certificate and allows communication. However, because the self-signed certificate cannot verify reliability from a Web browser, you see a warning about the server's reliability when you access the projector from a Web browser. This warning does not prevent communication.

Importing a Web Server Certificate Using the Menus

You can create your Web server certificate, and import it using the projector menus and a USB flash drive.



You can also register the digital certificates from your Web browser. However, be sure to register just once or the certificate may not install correctly.

☛ "Setting a certificate using a Web browser" [p.134](#)

- 1** Save the certificate in a format supported by the projector in the root directory of the USB storage device.
☛ "Supported Web Server Certificates" [p.134](#)
- 2** Press the [Menu] button on the control panel or remote control.
- 3** Select the **Network** menu and press [Enter].
- 4** Select **Network Configuration** and press [Enter].

- 5** Select the **Others** menu and press [Enter].

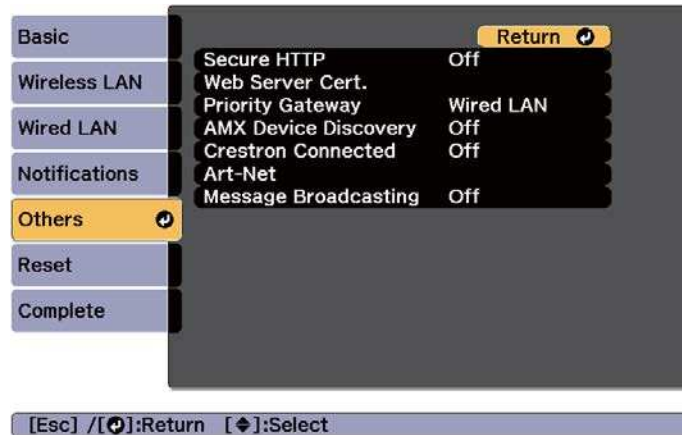

- 6** Select **On** as the **Secure HTTP** setting.
- 7** Select **Web Server Cert.** and press [Enter].
- 8** Select **Register** and press [Enter].
- 9** Connect the USB flash drive to the USB-A port on the projector.
If the wireless LAN module is already installed in the projector, remove it.
☛ "Installing the Wireless LAN Unit" p.55
- 10** Press [Enter] to display the certificate list.
- 11** Select the certificate to import using the displayed list.
A message is displayed prompting you to enter the password for the certificate.
- 12** Enter a password and press [Enter].
The certificate is imported and a completion message appears.

Supported Web Server Certificates

You can register these types of digital certificates.

Web Server Certificate (Secure HTTP)

Item	Explanation
Format	PKCS#12
Extension	PFX, P12
Encryption	RSA
Hashes	MD5/SHA-1/SHA-256/SHA-384/SHA-512
Key length	512/1024/2048/4096 bit
Common Name	Network Host Name
Organization	Optional
Password *	You need to setup a password. Up to 32 single-byte alphanumeric characters

* You can set a password using up to 64 alphanumeric characters. When entering more than 32 characters, use your Web browser to enter the text.

☛ "Setting a certificate using a Web browser" p.134

Setting a certificate using a Web browser

You can use an electronic certificate as the projector's security settings.



You can install the electronic certificate from the projector's Network menu. However, be sure to register just once or the certificate may not install correctly.

☛ "Setting Up Wireless Network Security" p.127

- 1** Prepare a certificate that is supported by the projector.

- 2 Make sure the projector is turned on.
- 3 Launch the Web browser on the computer or mobile device connected to the network.
- 4 Enter the IP address of the projector in the address input box of the browser to connect to the Epson Web Control screen.

The Epson Web Control screen is displayed.

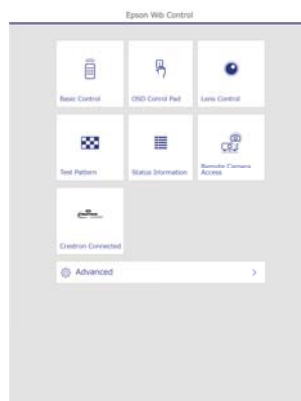

- 5 Select **Advanced**.



You need to login to display the Advanced screen. When the login screen is displayed, enter your user name and password. (User name is **EPSONWEB**; default password is **admin**.)

- 6 Select **Certificate** from **Network**.
- 7 Select the certificate you want to register.
- 8 Enter the password in the **Password** box, and then click **Send**.
- 9 When the settings are complete, click **Apply**.



Configuration Menu

This chapter explains how to use the Configuration menu and its functions.

This section explains how to use the Configuration menu.

Although steps are explained using the remote control as an example, you can perform the same operations from the control panel. Check the guide under the menu for the available buttons and their operations.



If you operate the menus while projecting, the last menu screen you used is displayed. Hold down the [Esc] button to display the top level menu screen. When you turn off the projector, menu operations return to the opening screen.

1 Display the Configuration menu screen.

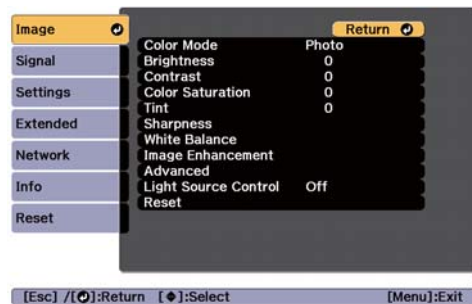
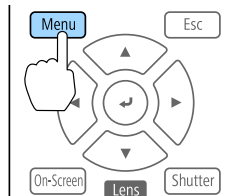

2 Select a top menu item.

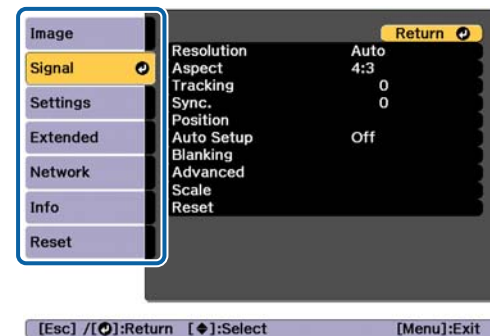
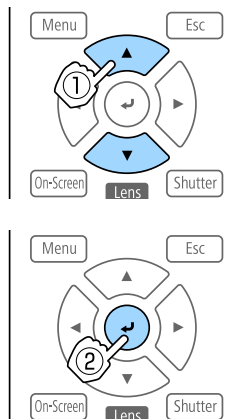

3 Select a submenu item.

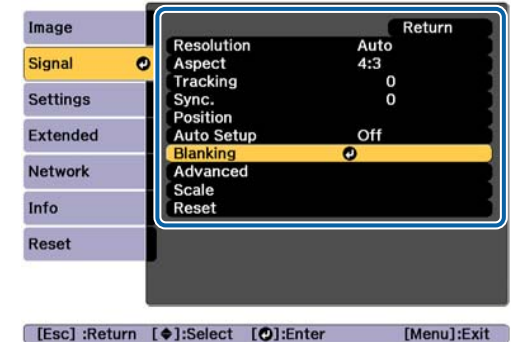
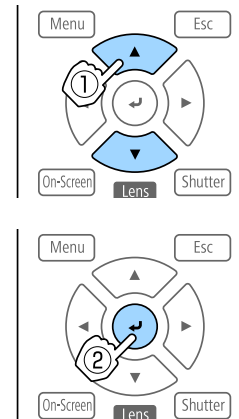

4 Change settings.

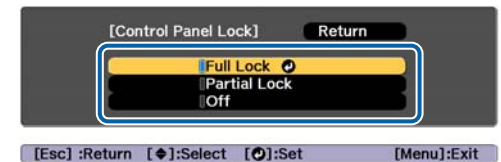
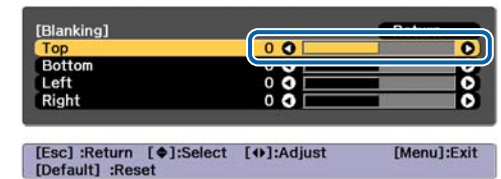
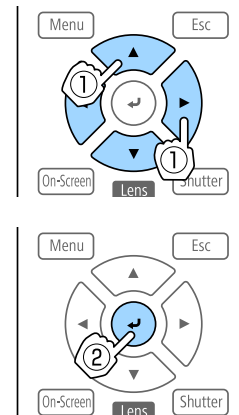



When "[Default]: Reset" is displayed on the guide under the menu, pressing the [Default] button on the remote control returns the settings being adjusted to their default values.

5 Press the [Menu] button to finish making settings.



Configuration Menu Table

Settable items vary depending on the model being used and the image signal and source being projected.

Top Menu Name	Submenu Name	Items or Setting Values
Image menu  p.141	Color Mode	Dynamic, Presentation, Natural, Cinema, BT.709, DICOM SIM, Multi-Projection
	Brightness	0 to 100
	Contrast	0 to 100
	Color Saturation	0 to 100
	Tint	0 to 100
	Sharpness	Standard, Thin Line Enhancement, Thick Line Enhancement
	White Balance	Color Temp., G-M Correction, Offset R, Offset G, Offset B, Gain R, Gain G, Gain B
	Image Enhancement	4K Enhancement, Image Preset Mode, Frame Interpolation, Deinterlacing, Noise Reduction, MPEG Noise Reduction, Super-resolution, Detail Enhancement, Reset
	Advanced	Gamma, RGBCMY
Signal menu  p.143	Resolution	Auto, Wide, Normal, and Manual
	Aspect	Auto, Normal, 4:3, 16:9, Full, H-Zoom, V-Zoom, Native
	Tracking	-
	Sync.	0 to 31



Top Menu Name	Submenu Name	Items or Setting Values
	Position	-128 to 127
	Auto Setup	On, Off
	Overscan	Auto, Off, 4%, and 8%
	Blanking	Top, Bottom, Left, and Right
	Color Space	Auto, BT.709, BT.2020
	Dynamic Range	Dynamic Range, Signal Status, HDR10 Setting, HLG Setting
	Advanced	Video Range, Input Signal, BNC Sync Termination, EDID, DDC Buffer
	Scale	Scale, Scale Mode, Scale Vertically, Scale Horizontally, Clip Adjustment, Clip Range
Settings menu  p.145	Geometry Correction	Off, H/V-Keystone, Quick Corner, Curved Surface, Corner Wall, Point Correction, Memory
	Split Screen	-
	Lock Setting	Control Panel Lock, Lens Lock
	Brightness Settings	Light Source Mode, Brightness Level, Constant Brightness, Estimated Remains
	Remote Receiver	Front/Rear, Front, Rear, and Off
	User Button	User Button 1, User Button 2, and User Button 3



Top Menu Name	Submenu Name	Items or Setting Values
	Test Pattern	Standard, Cross-hatching, Cross-hatching R, Cross-hatching G, Cross-hatching B, Cross-hatching C, Cross-hatching M, Cross-hatching Y, Color Bars V, Color Bars H, Grayscale, Gray Bars V, Gray Bars H, Checkerboard 1, Checkerboard 2, White, Black, Aspect Frame
	Memory	Memory, Lens Position, Geometry Correction
Extended menu  p.147	Display	Menu Position, Message Position, Messages, Display Background, Startup Screen, Standby Confirmation, Air Filter Notice, Screen, Panel Alignment, Color Uniformity, OSD Rotation
	User's Logo	Start Setting, Reset
	Projection	Front, Front/Ceiling, Rear, and Rear/Ceiling
	Operation	Direct Power On, Sleep Mode, Sleep Mode Timer, High Altitude Mode, Startup Source Search, Shutter Settings, Advanced, Date & Time, Lens Calibration
	A/V Settings	A/V Output, Monitor Out
	Standby Mode	Communication On and Communication Off
	HDBaseT	Control Communications, Extron XTP
	SDI Settings	Link Type, Manual Settings

Top Menu Name	Submenu Name	Items or Setting Values
	Color Calibration	Color Calibration, Start Auto Adjustment, Undo, Redo, Color Uniformity, Reset
	Multi-Projection	Projector ID, Projector Grouping, Tiling, Geometry Correction, Edge Blending, Black Level, Scale, Reset, Screen Matching
	Schedule Settings	-
	Language	27 languages
Info menu  p.161	Projector Info	Operation Hours, Source, Input Signal, Resolution, Refresh Rate, Sync Info, Color Format, Status, Serial Number, Lens Type, Event ID, HDBaseT Signal Level
	Light Source Info	Light Source Hours, Estimated Remains
	Version	Main, Video2, Sub, Sub2, HDMI, HDBaseT, HDBaseT2, SDI, Status Monitor, AC Monitor
	Status Information	Status Information, Source, Signal Information, Network Wired, Network Wireless, Maintenance, Version
	Voltage Warning Info	-
	Temp Warning Info	-
	Power On/Off History	-
	Reset menu  p.163	Reset All Memories
Refresh Mode		Timer, Messages, Start
Light Source Calibration		Run Now, Run Periodically, Schedule Settings, Last Run
Reset All Config		-

Top Menu Name	Submenu Name	Items or Setting Values
	Reset All (Factory Default)	Reset All (User Default), Reset All (Factory Default), User Default Setting, Password

Network menu

Top Menu Name	Submenu Name	Items or Setting Values
Basic menu  p.154	Projector Name	-
	PJLink Password	-
	Remote Password	-
	Web Control Password	-
	Moderator Password	-
	Projector Keyword	On, Off
	Display Keyword	On, Off
	Display LAN Info.	Text & QR Code, Text
Wireless LAN menu  p.154	Connection Mode	Quick, Advanced
	Search Access Point	-
	SSID	-
	Security	Open, WPA2-PSK, WPA/WPA2-PSK, WPA2-EAP, WPA/WPA2-EAP
	Passphrase	-
	EAP Method	EAP Type, User name, Password, Client Certificate, Verify Server Cert., CA certificate, RADIUS Serv.Name
	Channel	1ch, 6ch, and 11ch

Top Menu Name	Submenu Name	Items or Setting Values
	IP Settings	DHCP, IP Address, Subnet Mask, Gateway Address
	SSID Display	On, Off
	IP Address Display	On, Off
	IPv6 Settings	IPv6, Auto Configuration, Use Temporary Address
Wired LAN menu  p.158	IP Settings	DHCP, IP Address, Subnet Mask, Gateway Address
	IP Address Display	On, Off
	IPv6 Settings	IPv6, Auto Configuration, Use Temporary Address
Notifications menu  p.160	Mail Notification	On, Off
	SMTP Server	-
	Port Number	-
	From	-
	Address 1 Setting, Address 2 Setting, Address 3 Setting	Email Address, No Signal, System Error, Laser Error, High Temp Error, Air Filter Error, Laser Warning, High Temp Warning, Air Filter Warning, Shutter Warning, Air Filter Notice, Constant Bright. End
	SNMP	On, Off
	Trap IP Address 1, Trap IP Address 2	-
	Community Name	-

Top Menu Name	Submenu Name	Items or Setting Values
	PJLink Notification	On, Off
	Notified IP Address	-
Others menu  p.160	Secure HTTP	On, Off
	Web Server Cert.	-
	Priority Gateway	Wired LAN, Wireless LAN
	AMX Device Discovery	On, Off
	Crestron Connected	On, Off
	Art-Net	Art-Net, Net, Sub-Net, Universe, Start Channel, Channel Information
	Message Broadcasting	On, Off

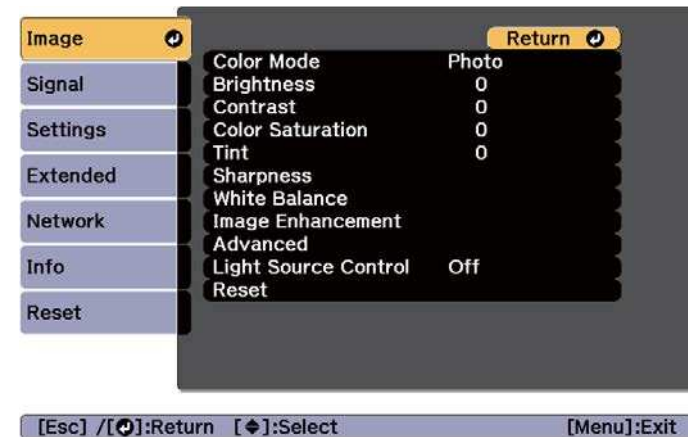





Image Menu

Settable items vary depending on the image signal and source currently being projected. Setting details are saved for each color mode.

 "Automatically Detecting Input Signals and Changing the Projected Image (Source Search)" p.60

Submenu	Function
Color Mode	You can select the quality of the image to suit your surroundings. The settings are saved for each input source.  "Selecting the Projection Quality (Selecting Color Mode)" p.74
Brightness	Adjusts the image brightness.
Contrast	Adjusts the difference between light and shade in the images.
Color Saturation	Adjusts the color saturation for the images.
Tint	You can adjust the image tint.
Sharpness	Standard: You can adjust the image sharpness. Thin Line Enhancement: If this parameter is set to a positive value, details such as hair or fabric patterns will be enhanced. Thick Line Enhancement: If this parameter is set to a positive value, the outline, background, and the other main parts of the objects in the image will be enhanced to show them clearly.

Submenu	Function
White Balance	<p>Color Temp.: You can adjust the overall tint of the image within a range from 3200K to 10000K. The image is tinted blue when a high value is selected and tinted red when a low value is selected. When Color Mode is set to Dynamic, the set Color Temp. may differ from the actual Color Temp. of the light from the projector. Use this menu as a guide.</p> <p>G-M Correction: The color tone is tinted red when set to a negative value, and tinted green when set to a positive value.</p> <p>Offset R/Offset G/Offset B/Gain R/Gain G/Gain B: You can adjust the offset and gain of each color R (red), G (green), and B (blue) individually.</p>

Submenu	Function
Image Enhancement	<p>You can adjust the image resolution.  "Adjusting Image Resolution (Image Enhancement)" p.81</p> <p>4K Enhancement: You can project at a doubled resolution.</p> <p>Image Preset Mode: You can select the optimal setting according to the projected image from five presets prepared in advance.</p> <p>Frame Interpolation: You can play fast moving images smoothly by producing intermediate frames between the original frames.</p> <p>Deinterlacing: (Only when the input signal is 480i, 576i, or 1080i) You can convert interlace signals into progressive signals. (IP conversion)</p> <p>Off is ideal for images with a large amount of movement, Video for general video images, and Film/Auto for movie films, computer graphics, and animation.</p> <p>Noise Reduction: You can smooth out the roughness in progressive images.</p> <p>MPEG Noise Reduction: You can reduce dot and block noise that occurs in outlines when projecting MPEG movies.</p> <p>Super-resolution: To display a crisp image, you can reduce the blurring that is created on the edge when the resolution of the image signal is scaled up and projected.</p> <p>Detail Enhancement: You can enhance the contrast of details in an image.</p> <p>Reset: You can reset all adjustment values for Image Enhancement to their default values.</p>
Advanced	<p>You can make adjustments by choosing the following items.</p> <p>Gamma: You can adjust the coloring by selecting one of the gamma correction values, or referring to the projected graph.</p> <p>RGBCMY: You can adjust the hue, saturation, and brightness of each color R (red), G (green), B (blue), C (cyan), M (magenta), Y (yellow) individually.</p>

Submenu	Function
Light Source Control	<p>Light Source Control: Select the light source operations according to the image signal.</p> <p>☛ "Setting the Amount of Light of the Projected Image" p.77</p> <p>Dynamic Contrast: (This can be set only if Light Source Control is set to Dynamic Contrast) Automatically adjusts the amount of light when projecting according to the brightness of the image.</p> <p>Lights-Out Control: (This can be set only if Light Source Control is set to Lights-Out Control) Automatically turns off the light after the set time has elapsed at the specified video level.</p>
Reset	<p>You can reset all adjustment values for the Image menu to their default settings except for Color Mode. See the following to return all menu items to their default settings.</p> <p>☛ "Reset Menu" p.163</p>

Submenu	Function
Resolution*1	<p>(Only available when an analog RGB computer signal is being input.)</p> <p>Set to Auto to automatically identify the resolution of the input signal. If images are not projected correctly when set to Auto, for example if some of the image is missing, set to Wide for wide screens, or set to Normal for 4:3 or 5:4 screens depending on the connected computer.</p> <p>Manual allows you to specify the resolution. This is ideal when connected computer is fixed.</p>
Aspect*2	<p>You can set the Aspect Ratio for projected images.</p> <p>☛ "Changing the Aspect Ratio of the Projected Image" p.78</p>
Tracking*2	<p>(Only available when an analog RGB computer signal is being input.)</p> <p>You can adjust computer images when vertical stripes appear in the images.</p>
Sync.*2	<p>(Only available when an analog RGB computer signal is being input.)</p> <p>You can adjust computer images when flickering, fuzziness, or interference appear in the images.</p>
Position*2	<p>You can adjust the display position up, down, left, and right when a part of the image is missing so that the whole image is projected.</p>
Auto Setup*1	<p>(Only available when an analog RGB computer signal is being input.)</p> <p>Set to On to automatically adjust Tracking, Sync., and Position to the optimum state when the input signal changes.</p>
Overscan*2	<p>Changes the output image ratio (the range of the projected image). You can set the cropping range to 4% or 8%. When set to Auto, this is automatically adjusted according to the input signal.</p>

Signal Menu

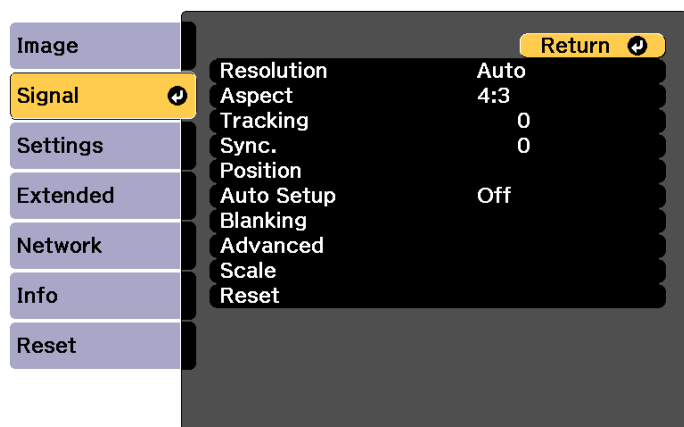

Settable items vary depending on the image signal and source currently being projected.



[Esc] / [Return]:Return [Enter]:Select [Menu]:Exit

Submenu	Function
Blanking*2	You can hide images in the set area. Use the [◀][▶] buttons to adjust the area. You can adjust by using a combination of Top , Bottom , Left , and Right . You can hide up to half of the projected image in each direction (except for one pixel).
Color Space*1*3	(Displayed when the current source is HDMI, DVI-D, HDBaseT, or SDI) Sets the color space conversion method. When Auto is selected, the conversion method is set automatically. Select BT.709 or BT.2020 if necessary.
Dynamic Range*1*3	(Displayed when the current source is HDMI, DVI-D, HDBaseT, or SDI) Make settings for the dynamic range. Dynamic Range: Range is selected automatically when receiving HDR (High Dynamic Range) signals. You can set this when the HDR information is not recorded correctly in the video signal. When Auto is selected, one of SDR, HDR10, or HLG is selected. Signal Status: Displays the selected range. HDR10 Setting: (This can only be set if Signal Status is HDR10) Set the PQ curve for the HDR PQ (Perceptual Quantizer) signal. HLG Setting: (This can only be set if Signal Status is HLG) Set the HLG curve for the HDR HLG (Hybrid Log Gamma) signal.

Submenu	Function
Advanced*1	<p>You can set by choosing the following items.</p> <p>Video Range: Select the video range for the input signal from the HDMI port, DVI-D port, HDBaseT port, or 3G/HD/SD SDI port. If the brightness range is 16 to 235, select Limited (16-235), if it is 0 to 255, select Full (0-255).</p> <p>Input Signal: Select an input signal from the Computer port or BNC port. If set to Auto, the input signal is set automatically according to the connected equipment. If colors do not appear correctly when set to Auto, select the appropriate signal according to the connected equipment.</p> <p>BNC Sync Termination: Set the end process for signals from the BNC in port. This should usually be set to Off. Set to On when analog (75Ω) termination such as for switchers is necessary.</p> <p>EDID: (Displayed when the current source is HDMI, DVI-D, or HDBaseT) Make settings related to EDID. Even in setups with multiple displays with different resolutions, you can switch the EDID of the current source and unify the EDID across the displays by setting the same EDID as the standard display.</p> <ul style="list-style-type: none"> • Preset EDID: Select the optimal setting from the presets prepared in advance. Change the preset settings for Resolution, Refresh Rate, and Color Depth if necessary. Select Set, and then press the [↵] button. • Resolution: Select from the resolutions displayed. • Refresh Rate: Select from the refresh rates displayed. • Color Depth: Select the maximum color depth limit supported by the projector. When you select 12bit, the projected images support signals up to 12 bits. • Reset: You can reset all adjustment values for EDID to their default values. <p>DDC Buffer: (Displayed when the current source is HDMI or DVI-D) Setting this to On can sometimes improve images that are not displayed correctly from devices connected using an HDMI or DVI extension cable.</p>

Submenu	Function
Scale*2	When using multiple projectors to project one image, adjust the range of the image displayed by each projector.  "Displaying a Scaled Image" p.98
Reset	You can reset all adjustment values on the Signal menu to their default settings, except for Input Signal . See the following to return all menu items to their default settings.  "Reset Menu" p.163





*1 The settings are saved for each input source.

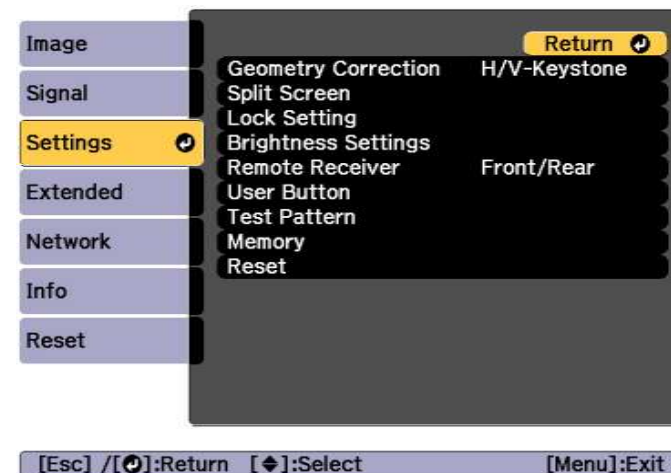

*2 The settings are saved for each input source according to the video signal.

*3 This cannot be set when **Color Mode** is set to **BT.709** or **DICOM SIM**.

Settings Menu



Submenu	Function
Geometry Correction	<p>You can correct distortion.</p> <p> "Correcting Distortion in the Projected Image" p.62</p> <ul style="list-style-type: none"> • Off: Temporarily cancels the geometry correction. • H/V-Keystone: Adjust V-Keystone, V-Balance, H-Keystone, and H-Balance to correct vertical and horizontal keystone distortion. • Quick Corner: Select and correct the four corners of the projected image. • Curved Surface: Corrects distortion that occurs when projecting on a curved surface. • Corner Wall: Corrects distortion that occurs when projecting on a surface with right angles. • Point Correction: Divides the projected image into a grid and corrects the distortion by moving the selected point of intersection from side to side and up and down. • Memory: You can save the adjustment value of the geometry correction and load it when needed.  "Memory Function" p.109
Split Screen	<p>You can split the screen into two screens.</p> <p> "Projecting Two Images Simultaneously (Split Screen)" p.103</p>
Lock Setting	<p>Control Panel Lock: You can use this to restrict operation of the projector's control panel.  "Control Panel Lock" p.117</p> <p>Lens Lock: When set to On, [Lens Shift], [Zoom], [Focus], and [Distortion] button operations on the remote control are disabled.  "Lens Lock" p.118</p>

Submenu	Function
Brightness Settings	<p>Light Source Mode: Set the brightness for the light source.</p> <ul style="list-style-type: none"> • Normal: Select this if you do not want to decrease the brightness. This makes the light source operation time approximately 20,000 hours. • Quiet: Select this if you are concerned about the noise made by the fan. This sets the brightness at 70%. This makes the light source operation time approximately 20,000 hours. • Extended: Select this to extend the life expectancy of the light source. This sets the brightness at 70%. This makes the light source operation time approximately 43,000 hours. • Custom: Select this to set the brightness level within a range of 30 to 100%. <p>Brightness Level: (Only available when Light Source Mode is set to Custom) Sets the brightness for the light source.</p> <p>Constant Brightness: (Only available when Light Source Mode is set to Custom) When set to On, the brightness of the light source set in Brightness Level is maintained as it is. When Constant Brightness is set to On, you cannot change the settings for Light Source Mode and Brightness Level.  "Setting the Brightness" p.75</p> <p>Estimated Remains: When Constant Brightness is set to On, this indicates the amount of time for which constant brightness can be maintained.  "Guide to Estimated Remains" p.76</p>
Remote Receiver	<p>You can limit the reception of the operation signal from the remote control.</p> <p>When set to Off, you cannot perform any operations from the remote control. If you want to make operations from the remote control, hold down the [Menu] button on the remote control for at least 15 seconds to reset the setting to its default value.</p>
User Button	<p>Select the items in the Configuration menu that you want to assign to the [User1], [User2], and [User3] buttons on the remote control. The following items can be assigned.</p> <p>Light Source Mode, Multi-Projection, Resolution, Display the QR Code, Image Enhancement, Frame Interpolation, Screen Matching, Color Calibration, Help, Split Screen</p>

Submenu	Function
Test Pattern	You can display a test pattern to adjust the projection without connecting other equipment when you set up the projector. ☛ "Displaying the Test Pattern" p.36
Memory	Perform operations and make settings for the memory function. ☛ "Memory Function" p.109
Reset	You can reset all adjustment values on the Settings menu to their default settings, except for User Button . See the following to return all menu items to their default settings. ☛ "Reset Menu" p.163

Extended Menu

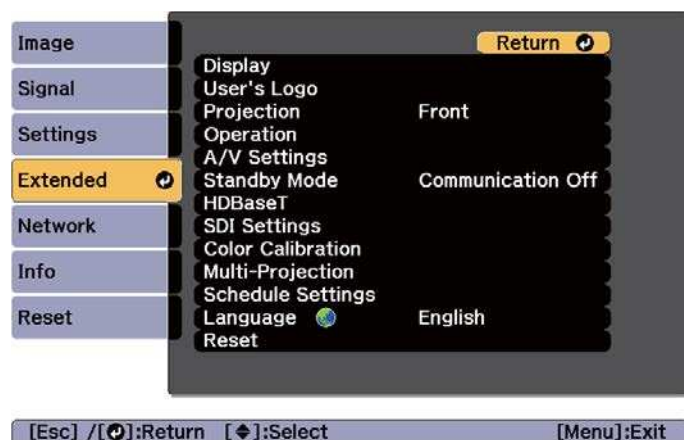





Submenu	Function
Display	You can make settings related to the projector's display. Menu Position: Select the position to display the menu on the projected screen. Message Position: Select the position to display the message on the projected screen. Messages: When set to Off , the following items will not be displayed. Item names when the Source, Color Mode, or Aspect is changed, messages when no signal is being input, and warnings such as High Temp Warning. Display Background*: You can set the screen background to Black , Blue , or Logo when no image signal is available. Startup Screen*: Set to On to display the User's Logo when you start projecting. Standby Confirmation: If it is set to Off , you can turn off the power simply by pressing the [On] button once. Air Filter Notice: You can set whether or not (On/Off) to enable Air Filter Notice. When this is set to On and a clog in the air filter is detected, the message is displayed on the screen. Screen: (This is unavailable when projecting images from a computer over a network.) Set the aspect ratio and position of the projected screen according to the screen being used. ☛ "Screen Settings" p.34 Panel Alignment: Corrects color misalignments (red and blue) in the screen. ☛ "Panel Alignment" p.224 Color Uniformity: Adjusts the color tone balance for the whole screen. ☛ "Color Uniformity" p.226 OSD Rotation: Rotates the menu direction by 90 degrees.
User's Logo *	You can change the user's logo that is displayed as a background during Display Background, Shutter, and so on. ☛ "Saving a User's Logo" p.107



Submenu	Function
Projection	<p>Select from one of the following projection methods depending on how the projector is installed.</p> <p>Front, Front/Ceiling, Rear, Rear/Ceiling</p> <p>You can change the setting as follows by pressing down the [Shutter] button for about five seconds.</p> <p>Front ↔ Front/Ceiling</p> <p>Rear ↔ Rear/Ceiling</p>

Submenu	Function
Operation	<p>Direct Power On: Set to On to turn on the projector simply by supplying power.</p> <p>When the power cord is plugged in and the main power switch is turned on, note that the projector turns on automatically in cases such as a power outage being restored.</p> <p>Sleep Mode: When set to On, this automatically stops projection when no image signal is being input and no operations are carried out.</p> <p>Sleep Mode Timer: When Sleep Mode is set to On, you can set the time before the projector automatically turns off within a range of 1 to 30 minutes.</p> <p>High Altitude Mode: Set this to On if you are using the projector above an altitude of 1,500 meters.</p> <p>Startup Source Search: Set to On to automatically detect an image signal from another source and project the image when there is no image signal from the current source.</p> <p>Shutter Settings: Make settings related to the shutter.</p> <ul style="list-style-type: none"> • Fade-in: Specify the number of seconds for fade-in when displaying an image. • Fade-out: Specify the number of seconds for fade-out when hiding an image. • Shutter Timer: When it is set to On, if no operations are performed for about 2 hours after shutter is activated, the projector turns off automatically. • Shutter Release: If it is set to Shutter, it is only released by pressing the [Shutter] button (or by sending a command to release the shutter function). When set to Any Button, the shutter function is released when any operation is performed on the projector. ☛ "Hiding the Image Temporarily (Shutter)" p.106 • Startup: Set the shutter status when the projector is turned on. • Standby: Set the shutter status when the projector is in standby mode. When Last Used is selected, the current

Submenu	Function
	<p>shutter status is maintained when the projector is turned off.</p> <p>Advanced: The following items can be set.</p> <ul style="list-style-type: none"> • Beep: When this is set to On, the confirmation buzzer beeps to notify you that the power turns on or off, or cooling down is finished. • Indicators: When set to Off, the projector's indicators are turned off, except for abnormality or warning. • Log Save Destination: Set where you want to save the operation logs for the projector. Select USB and Internal Memory to save the logs to the USB flash drive connected to the projector's USB-A port. Logs are saved as text files (.log) on the USB flash drive. The following logs are saved. <ul style="list-style-type: none"> - Error information - Laser information - Temperature logs - Operation logs - Input signal identification logs • Batch Setup Range: Select All to copy all of the menu settings using the batch setting function. Select Limited if you do not want to copy the following settings. <ul style="list-style-type: none"> - EDID from the Signal menu - All items except for the Notifications menu and the Others menu from the Network menu • AC Voltage Monitoring: When this is set to On, and the projector is turned off by any method (including direct shutdown) except for pressing the power button, an AC Voltage Warning dialog is displayed the next time the

Submenu	Function
	<p>projector is turned on. Set this to Off if you use direct shutdown regularly.</p> <p>Date & Time: Make system time settings for the projector.  "Setting the Time" p.44</p> <p>Lens Calibration: Select Start to perform lens calibration. You can check if lens calibration has been performed from History.</p>
<p>A/V Settings</p>	<p>A/V Output: Set this to Always On if you want to output images to an external device even when the projector is in standby status.</p> <p>Monitor Out: Select the image source output to an external monitor connected to the Monitor Out port when the projector is in standby status. When set to Auto, analog RGB signals from the Computer port or the BNC port are output depending on which source was selected when the projector was turned off.</p>
<p>Standby Mode</p>	<p>This is only enabled when A/V Output is set to While Projecting, and Control Communications and Extron XTP are set to Off. If you set Communication On, you can perform the following operations even if the projector is in standby mode.</p> <ul style="list-style-type: none"> • Monitor and control the projector over a network. • Communication from the HDBaseT port is enabled. • Set the IP address on the LCD display. <div style="border: 1px solid black; padding: 5px; margin-top: 10px;">  When monitoring or controlling the projector using wireless LAN, set Connection Mode to Advanced.  Network - Wireless LAN - Connection Mode p.154 </div>

Submenu	Function
HDBaseT	<p>Control Communications: (This cannot be set when Extron XTP is set to On.) When set to On, Ethernet communication, serial communication, and the wired remote control through the HDBaseT Transmitter connected to the HDBaseT port are all enabled.</p> <p>Extron XTP: Set to On when you connect the Extron XTP transmitter or switcher to the HDBaseT port. See the following Extron Web site for more details on the XTP system. http://www.extron.com/</p> <div style="border: 1px solid black; padding: 5px; margin-top: 10px;">  <ul style="list-style-type: none"> • When Control Communications or Extron XTP is set to On, Standby Mode is automatically set to Communication On. • When Control Communications or Extron XTP is On, the projector's LAN port, RS-232 port, and Remote port are disabled. • When Extron XTP is set to On, the fan may rotate in standby mode but this is not abnormal. </div>

Submenu	Function
SDI Settings	<p>Set the signal from the 3G/HD/SD SDI port.</p> <p>SDI: When Single (Auto) is selected as the Link Type, the payload ID for the input signal is read and the image is displayed automatically. When you know the type of input signal, select Single (Manual) and set the same signal as the input signal used in Manual Settings to fix it to the same signal as the input signal.</p> <p>For Manual Settings, set the following items, select Set, and then press the [↵] button. Not all combinations of items in Manual Settings are supported.</p> <ul style="list-style-type: none"> • SDI Type: Select from the SDI types displayed. • Resolution: Select from the resolutions displayed. • Refresh Rate: Select from the refresh rates displayed. • Color Sampling: Select from the color samplings displayed. • Color Depth: Select from the color depths displayed.
Color Calibration	<p>Color Calibration: Enables/disables the color calibration function.</p> <p>Start Auto Adjustment: Automatically adjusts the color tone for the whole screen.  "Color Calibration" p.224</p> <p>Undo: Undoes the auto adjustment.</p> <p>Redo: Redoes the auto adjustment.</p> <p>Color Uniformity: Adjusts the color tone balance for the whole screen.  "Color Uniformity" p.226</p> <p>Reset: You can reset all adjustment values for Color Calibration to their default values.</p>

Submenu	Function
Multi-Projection	<p>Make settings when projecting from multiple projectors.</p> <ul style="list-style-type: none"> ☛ "Multi-Projection Function" p.87 <p>Projector ID: Set the ID from 1 to 30. Off indicates that no ID is set.</p> <ul style="list-style-type: none"> ☛ "ID Settings" p.43 <p>Projector Grouping: When using multiple projectors to project one image, select the projectors being used.</p> <p>Tiling: Set the number of split screens and positions of each projected image.</p> <ul style="list-style-type: none"> ☛ "Tiling" p.89 <p>Geometry Correction: Corrects distortion in the projected image.</p> <ul style="list-style-type: none"> ☛ "Correcting Distortion in the Projected Image" p.62 <p>Edge Blending: Corrects a border between multiple images to create a seamless screen.</p> <ul style="list-style-type: none"> ☛ "Edge Blending" p.91 <p>Black Level: Adjusts the differences in brightness and tone for areas where images overlap and areas where the images do not overlap.</p> <ul style="list-style-type: none"> ☛ "Black Level" p.93 <p>Scale: When using multiple projectors to project one image, adjust the range of the image displayed by each projector.</p> <ul style="list-style-type: none"> ☛ "Displaying a Scaled Image" p.98 <p>Reset: You can reset all adjustment values for the Multi-Projection menu to their default settings.</p> <p>Screen Matching: Adjusts the tint and brightness for each projector.</p> <ul style="list-style-type: none"> ☛ "Screen Matching" p.95
Schedule Settings	<p>You can set the projector's schedule so that it performs a specific operation at a pre-scheduled time.</p> <ul style="list-style-type: none"> ☛ "Scheduling Function" p.111
Language	<p>You can set the language for messages and menus.</p>

Submenu	Function
Reset	<p>You can reset all adjustment values for the Extended menu to their default settings. However, the following items are not reset.</p> <p>Screen, Panel Alignment, Color Uniformity, Projection, High Altitude Mode, Startup Source Search, Shutter Release, Date & Time, Lens Calibration, A/V Settings, Standby Mode, HDBaseT, Color Calibration, Multi-Projection, and Language</p> <p>See the following to return all menu items to their default settings.</p> <ul style="list-style-type: none"> ☛ "Reset Menu" p.163

* When **User's Logo Protection** is set to **On** in **Password Protection**, you cannot change settings related to user's logo. You can make changes after setting **User's Logo Protection** to **Off**.

- ☛ "Managing Users (Password Protection)" [p.115](#)

Network Menu

When **Network Protection** is set to **On** in **Password Protection**, a message is displayed and the network settings cannot be changed. Set **Network Protection** to **Off** and then configure the network.

☛ "Setting Password Protection" p.115

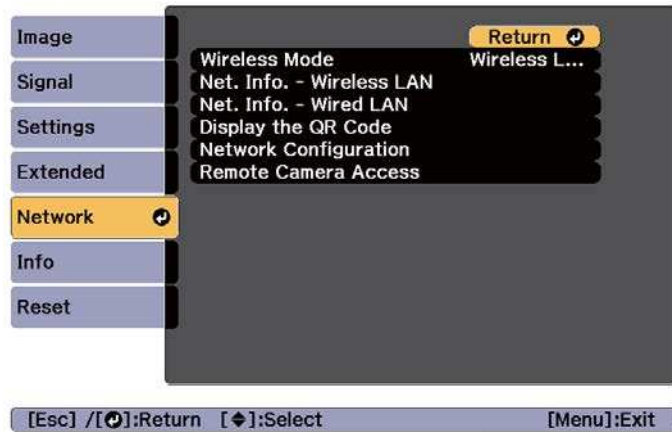

Submenu	Function
Wireless Mode	Set this to Wireless LAN On when connecting the projector and a computer via a wireless LAN. If you do not want to connect via wireless LAN, turn it Off to prevent unauthorized access by others.

Submenu	Function
Net. Info. - Wireless LAN	<p>Displays the following network setting status information.</p> <ul style="list-style-type: none"> • Connection Mode • Wireless LAN system • Antenna Level • Projector Name • SSID • DHCP • IP Address • Subnet Mask • Gateway Address • MAC Address • Region Code <p>When IPv6 is selected, the following information is displayed.</p> <ul style="list-style-type: none"> • IPv6 Address (Manual): IPv6 Address, Prefix Length, Gateway Address • IPv6 Address (Auto): Temporary Address, Link-local Address, Stateless Address, Stateful Address
Net. Info. - Wired LAN	<p>Displays the following network setting status information.</p> <ul style="list-style-type: none"> • Projector Name • DHCP • IP Address • Subnet Mask • Gateway Address • MAC Address • IPv6 Address (Manual): IPv6 Address, Prefix Length, Gateway Address • IPv6 Address (Auto): Temporary Address, Link-local Address, Stateless Address, Stateful Address
Display the QR Code	When connecting iOS or Android devices using Epson iProjection, read the QR code displayed.

Submenu	Function
Network Configuration	The following menus are available for setting Network items. Basic, Wireless LAN, Wired LAN, Notifications, Others, Reset
Remote Camera Access	Set this to On to check the projected image from a remote location. You can also set a password when shooting images using remote camera access from Epson Web Control. ☛ "Checking the projected image from a remote location" p.236

Notes on operating the Network menu

Selecting from the top menu and sub menus, and changing selected items is the same as making operations from the Configuration menu.

When done, make sure you go to the **Complete** menu, and select **Yes**, **No**, or **Cancel**. When you select **Yes** or **No**, you are returned to the Configuration menu.



Yes: Saves the settings and exits the Network menu.

No: Does not save the settings and exits the Network menu.

Cancel: Continues displaying the Network menu.

Soft keyboard operations

The Network menu contains items that require input of alphanumeric characters during setup. In this case, the following software keyboard is displayed. Use [▲][▼][◀][▶] buttons to move the cursor to the desired key, and then press the [↵] button to enter the selected character. Enter figures by holding down the [Num] button on the remote control, and pressing the numeric buttons. After inputting, press **Finish** on the keyboard to confirm your input. Press **Cancel** on the keyboard to cancel your input.



- Each time the **CAPS** key is selected and the [↵] button is pressed, it sets and changes between upper case and lower case letters.
- Each time the **SYM1/2** key is selected and the [↵] button is pressed, it sets and changes the symbol keys for the section enclosed by the frame.

The following types of character can be entered.

Numbers	0123456789
Letters	ABCDEFGHIJKLMNOPQRSTUVWXYZ abcdefghijklmnopqrstuvwxyz
Symbols	!"#\$%&'()*+,-./:;<=>?[¥]^_`{ }~

Basic menu

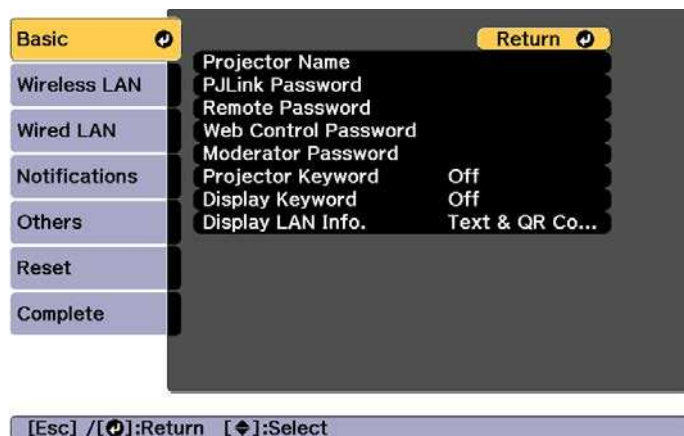

Submenu	Function
Projector Name	Enter the projector name used to identify the projector over a network. When editing, you can enter up to 16 single-byte alphanumeric characters. (" * + , / : ; < = > ? [¥] ` and spaces cannot be used.)
PJLink Password	Set a password to use when you access the projector using compatible PJLink software. You can enter up to 32 single-byte alphanumeric characters. (Spaces and symbols other than @ cannot be used.) ☛ "About PJLink" p.241
Remote Password	Set a password for authentication to use Basic Control in Epson Web Control. You can enter up to 8 single-byte alphanumeric characters. (* : and spaces cannot be used.) The default user name is "EPSONREMOTE" and the default password is "guest". ☛ "Changing Settings Using a Web Browser (Epson Web Control)" p.230

Submenu	Function
Web Control Password	Set a password for authentication to use when making settings and controlling the projector using Web Control in Epson Web Control. You can enter up to eight single-byte alphanumeric characters (* : and spaces cannot be used). The default user name is "EPSONWEB" and the default password is "admin". ☛ "Changing Settings Using a Web Browser (Epson Web Control)" p.230
Moderator Password	Enter the four digit authentication password for using Epson iProjection when connecting to the projector as a moderator. (There is no default password.)
Projector Keyword	Set this to On to enable a security password to prevent other users from accidentally projecting images. When projecting images from a computer or mobile device, you need to enter the keyword displayed on the projection screen in Epson iProjection.
Display Keyword	When this is set to On and when connecting to the projector using Epson iProjection, the projector keyword is displayed on the projection screen. This is only enabled when Projector Keyword is set to On .
Display LAN Info.	Set the display format for the projector's network information. If you display the QR code, you can connect to a network just by reading the QR code in Epson iProjection. Text & QR Code is set by default.

Wireless LAN menu

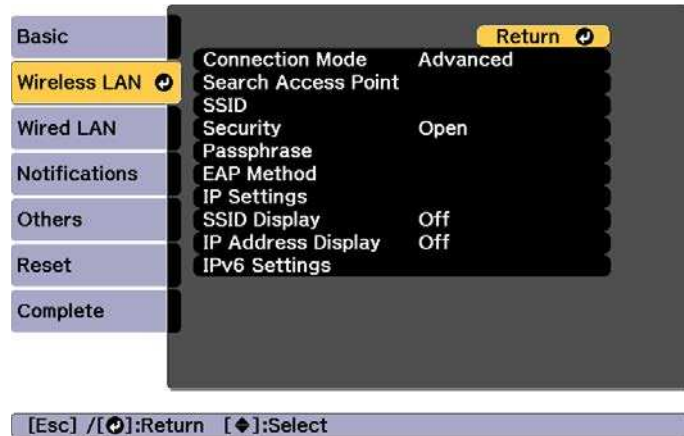

To connect the projector to a computer using a wireless LAN, install the Wireless LAN unit (ELPAP10).

☛ "Installing the Wireless LAN Unit" p.55



Submenu	Function
Connection Mode	Set the connection mode to use when connecting the projector and a computer via a wireless LAN. Quick: Lets you directly connect to a smartphone, tablet, or computer via a wireless LAN. Advanced: Lets you connect to a smartphone, tablet, or computer over a wireless LAN access point. The connection is established in infrastructure mode.
Search Access Point	When Connection Mode is set to Advanced , you can search for surrounding access points, and set the SSID to be connected from those access points. Depending on the access point settings, they may not be displayed in the list. ☛ "Search Access Point screen" p.157
SSID	Enter an SSID. When an SSID is provided for the wireless LAN system in which the projector participates, enter the SSID. You can enter up to 32 single-byte alphanumeric characters.

Submenu	Function
Security	Select the security type according to the wireless LAN settings. Open: Security is not set. WPA2-PSK: Communication is performed using WPA2 security. Uses AES method for encryption. When establishing a connection from a computer to the projector, enter the value set in the passphrase. WPA/WPA2-PSK*: Connects in WPA personal mode. Encryption method is selected automatically according to the access point settings. Set a passphrase which is the same for the access point. WPA2-EAP*: Communication is performed using WPA2 security. Uses AES method for encryption. WPA/WPA2-EAP*: Connects in WPA enterprise mode. Encryption method is selected automatically according to the access point settings.
Passphrase	Enter a passphrase used to connect to the network when Security is set to WPA2-PSK or WPA/WPA2-PSK . You can enter at least 8 and up to 63 single-byte alphanumeric characters. You can enter up to 32 characters on the Configuration menu. When entering more than 32 characters, use your Web browser to enter the text. ☛ "Changing Settings Using a Web Browser (Epson Web Control)" p.230 When Connection Mode is set to Quick , the initial passphrase is set.

Submenu	Function
EAP Method	<p>Set protocols for WPA2-EAP and WPA/WPA2-EAP authentication.</p> <p>EAP Type: Select the certification protocol.</p> <ul style="list-style-type: none"> • PEAP: Authentication protocol widely used in Windows Server. • PEAP-TLS: Authentication protocol used in Windows Server. Select when using a client certificate. • EAP-TLS: Authentication protocol widely used to use a client certificate. • EAP-FAST, LEAP: Select this when these authentication protocols are used. <p>User name: Enter a user name to be used for authentication. You can enter up to 64 single-byte alphanumeric characters.</p> <p>You can enter up to 32 characters on the Configuration menu. When entering more than 32 characters, use your Web browser to enter the text.</p> <p> "Changing Settings Using a Web Browser (Epson Web Control)" p.230</p> <p>If you also need to enter a domain name, add the domain name before the user name separated by a backslash (domain name\user name).</p> <p>Password: Enter the password used for authentication in PEAP, EAP-FAST, and LEAP. You can enter up to 64 single-byte alphanumeric characters. You can enter up to 32 characters on the Configuration menu. When entering more than 32 characters, use your Web browser to enter the text.</p> <p> "Changing Settings Using a Web Browser (Epson Web Control)" p.230</p> <p>When the password is entered and Finish is selected, the value is set and displayed as an asterisk (*).</p> <p>Client Certificate: Imports client certificates for use in PEAP-TLS and EAP-TLS.</p>

Submenu	Function
	<p>Verify Server Cert.: Set to On to perform verification for the certificate of the certification server. To verify a server certificate, you need to set CA certificate.</p> <p>CA certificate: Imports CA certificates for use in PEAP, PEAP-TLS, EAP-TLS, and EAP-FAST.</p> <p>RADIUS Serv.Name: Specify the name of the certification server. You can enter up to 32 single-byte alphanumeric characters.</p>
Channel	You can select the channels used to connect in Quick mode. If interference from other signals occurs, use a different channel.
IP Settings*	<p>Perform network settings.</p> <p>DHCP: Set to On to configure the network using DHCP. If this is set to On, you cannot set any more addresses.</p> <p>IP Address: Enter the IP address assigned to the projector. You can enter a number from 0 to 255 in each field of the address. However, the following IP addresses cannot be used.</p> <p>0.0.0.0, 127.x.x.x, 224.0.0.0 to 255.255.255.255 (where x is a number from 0 to 255)</p> <p>Subnet Mask: Enter the projector's subnet mask. You can enter a number from 0 to 255 in each field of the address. However, the following subnet masks cannot be used.</p> <p>0.0.0.0, 255.255.255.255</p> <p>Gateway Address: Enter the IP address for the gateway for the projector. You can enter a number from 0 to 255 in each field of the address. However, the following Gateway Address cannot be used.</p> <p>0.0.0.0, 127.x.x.x, 224.0.0.0 to 255.255.255.255 (where x is a number from 0 to 255)</p>
SSID Display	To prevent the SSID from being displayed on the LAN Standby screen, set this to Off .
IP Address Display	To prevent the IP address from being displayed on the LAN Standby screen, set this to Off .

Submenu	Function
IPv6 Settings	<p>Perform settings to use the IPv6 protocols.</p> <div style="border: 1px solid black; padding: 5px; margin: 10px 0;">  <ul style="list-style-type: none"> The following functions support IPv6 protocols. <ul style="list-style-type: none"> Epson Web Control PJLink When setting the IPv6 address manually, make settings in Advanced from Epson Web Control. <ul style="list-style-type: none"> "Changing Settings Using a Web Browser (Epson Web Control)" p.230 </div> <p>IPv6: Set this to On when using IPv6 protocols. Make sure one link local address is set when using IPv6. This is composed of the interface ID created from fe80:: and the projector's MAC address.</p> <p>Auto Configuration: Set this to On to automatically acquire an IPv6 address from RA (Router Advertisement). The address is composed as shown below.</p> <ul style="list-style-type: none"> Stateless Address (0 to 6): Created automatically by combining the prefix acquired from the RA (Router Advertisement) and the interface ID created from the projector's MAC address. Stateful Address (0 to 1): Created automatically from the DHCP server using DHCPv6. <p>Use Temporary Address: Set this to On to temporarily validate the IPv6 address (0 to 1) when Auto Configuration is On.</p>

* This can only be selected when Connection Mode is set to **Advanced**.

Type of security

When the optional wireless LAN unit is attached and being used in Advanced connection mode, it is strongly recommended that you set security.

WPA is an encryption standard that improves the security for wireless networks. The projector supports TKIP and AES encryption methods.

WPA also includes user authentication functions. WPA authentication provides two methods: using an authentication server, or authenticating between a computer and an access point without using a server. This projector supports the latter method, without a server.





For setting details, follow the instructions from your network administrator.

Search Access Point screen

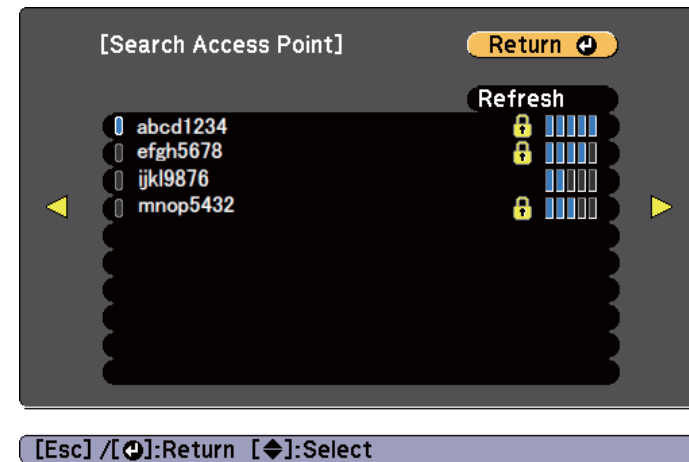
Detected access points are displayed in a list.



Submenu	Function
Refresh	Searches for the access point again.
	Indicates an already set access point.

Submenu	Function
	<p>Indicates the access points where security is set.</p> <p>If you select an access point where security has not been set, the Wireless LAN menu is displayed.</p> <p>If you select an access point where security has been set, the Security menu is displayed. Select a type of security according to the security settings for the access point.</p>

Wired LAN menu

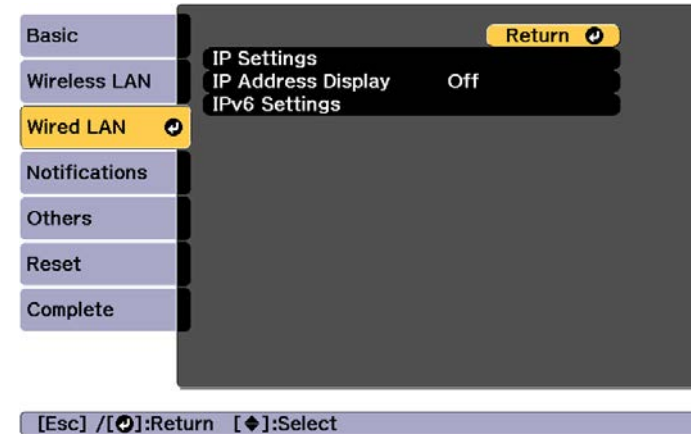

Submenu	Function
IP Settings	<p>You can make settings related to the following addresses.</p> <p>DHCP: Set to On to configure the network using DHCP. If this is set to On, you cannot set any more addresses.</p> <p>IP Address: Enter the IP address assigned to the projector. You can enter a number from 0 to 255 in each field of the address. However, the following IP addresses cannot be used. 0.0.0.0, 127.x.x.x, 224.0.0.0 to 255.255.255.255 (where x is a number from 0 to 255)</p> <p>Subnet Mask: Enter the projector's subnet mask. You can enter a number from 0 to 255 in each field of the address. However, the following subnet masks cannot be used. 0.0.0.0, 255.255.255.255</p> <p>Gateway Address: Enter the IP address for the gateway for the projector. You can enter a number from 0 to 255 in each field of the address. However, the following Gateway Address cannot be used. 0.0.0.0, 127.x.x.x, 224.0.0.0 to 255.255.255.255 (where x is a number from 0 to 255)</p>

Submenu	Function
IP Address Display	To prevent the IP address from being displayed on the LAN Standby screen, set this to Off .
IPv6 Settings	<p>Perform settings to use the IPv6 protocols.</p> <div style="border: 1px solid black; padding: 5px; margin: 10px 0;"> <ul style="list-style-type: none"> • The following functions support IPv6 protocols. <ul style="list-style-type: none"> - Epson Web Control - PjLink • When setting the IPv6 address manually, make settings in Advanced from Epson Web Control. <ul style="list-style-type: none"> ☛ "Changing Settings Using a Web Browser (Epson Web Control)" p.230 </div> <p>IPv6: Set this to On when using IPv6 protocols. Make sure one link local address is set when using IPv6. This is composed of the interface ID created from fe80:: and the projector's MAC address.</p> <p>Auto Configuration: Set this to On to automatically acquire an IPv6 address from RA (Router Advertisement). The address is composed as shown below.</p> <ul style="list-style-type: none"> • Stateless Address (0 to 6): Created automatically by combining the prefix acquired from the RA (Router Advertisement) and the interface ID created from the projector's MAC address. • Stateful Address (0 to 1): Created automatically from the DHCP server using DHCPv6. <p>Use Temporary Address: Set this to On to temporarily validate the IPv6 address (0 to 1) when Auto Configuration is On.</p>

Notifications menu

When this is set, you receive an email notification if a problem or warning occurs in the projector.

☛ "Reading error notification mail" [p.238](#)

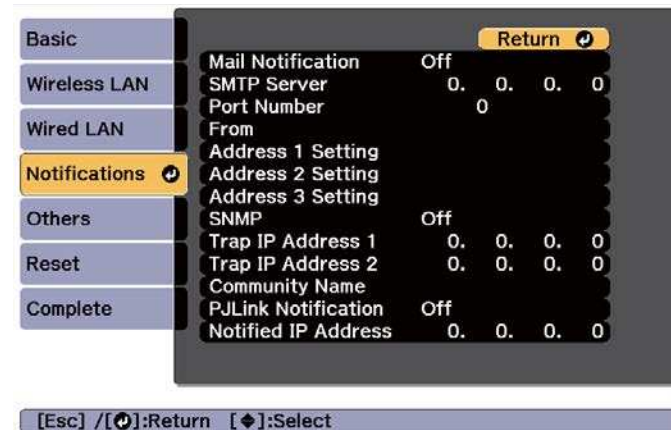



Submenu	Function
Mail Notification	Set to On to send an email to the preset addresses when a problem or warning occurs with a projector.
SMTP Server	You can input the IP Address for the SMTP server for the projector. You can enter a number from 0 to 255 in each field of the address. However, the following IP addresses cannot be used. 127.x.x.x, 224.0.0.0 to 255.255.255.255 (where x is a number from 0 to 255)
Port Number	You can input the port number for the SMTP server. The default value is 25. You can input numbers between 1 to 65535.
From	Enter the email address of the sender. You can enter up to 64 single-byte alphanumeric characters. You can enter up to 32 characters on the Configuration menu. When entering more than 32 characters, use your Web browser to enter the text. (" () , ; < > [\] and spaces cannot be used.) ☛ "Changing Settings Using a Web Browser (Epson Web Control)" p.230

Submenu	Function
Address 1 Setting/ Address 2 Setting/ Address 3 Setting	Set the destination email addresses for the notification email, and the notification content. You can register up to three destinations. You can enter up to 64 single-byte alphanumeric characters. You can enter up to 32 characters on the Configuration menu. When entering more than 32 characters, use your Web browser to enter the text. ("(", ":", "> [\] and spaces cannot be used.) ☛ "Changing Settings Using a Web Browser (Epson Web Control)" p.230
SNMP	Set to On to monitor the projector using SNMP. To monitor the projector, you need to install the SNMP manager program on your computer. SNMP should be managed by a network administrator. The default value is Off .
Trap IP Address 1/Trap IP Address 2	You can register up to two IP addresses for the SNMP trap notification destination. You can enter a number from 0 to 255 in each field of the address. However, the following IP addresses cannot be used. 127.x.x.x, 224.0.0.0 to 255.255.255.255 (where x is a number from 0 to 255)
Community Name	Set the community name of SNMP. You can enter up to 32 single-byte alphanumeric characters. (Spaces and symbols other than @ cannot be used.)
PJLink Notification	Set this to On to use the PJLink notification function.
Notified IP Address	Enter the IP address to receive the projector's operating status when the PJLink notification function is enabled. You can enter a number from 0 to 255 in each field of the address. However, the following IP addresses cannot be used. 127.x.x.x, 224.0.0.0 to 255.255.255.255 (where x is a number from 0 to 255)

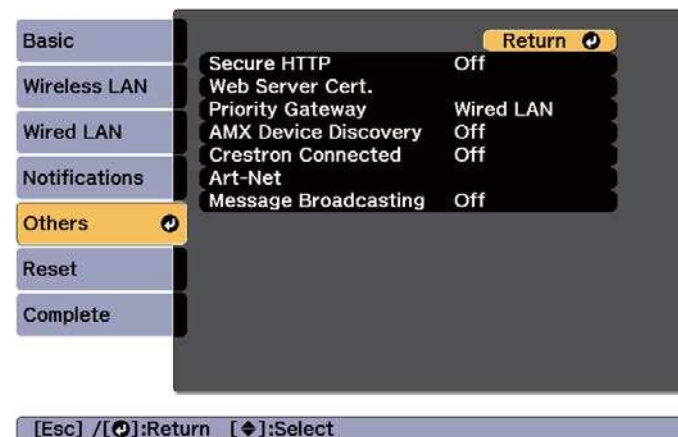
Others menu



Submenu	Function
Secure HTTP	To strengthen security, communication between the projector and computer in Epson Web Control is encrypted. When setting security with Epson Web Control, we recommend setting this to On .
Web Server Cert.	Imports the Web server certificate used in Secure HTTP.
Priority Gateway	For the priority gateway, select either Wired or Wireless .
AMX Device Discovery	When you want to allow the projector to be detected by AMX Device Discovery, set this to On . Set this to Off if you are not connected to an environment controlled by a controller from AMX or AMX Device Discovery.
Crestron Connected	Set this to On only when monitoring or controlling the projector over the network using Crestron Connected®. Otherwise, set this to Off . ☛ "About Crestron Connected®" p.241 Changes in projector settings take effect upon restarting. When this is set to On , you cannot use the Message Broadcasting feature in Epson Projector Management.

Submenu	Function
Art-Net	<p>Art-Net: Set this to On to control the projector using Art-Net.  "About Art-Net" p.246</p> <p>Net/Sub-Net/Universe: Sets the projector's Net/Sub-Net/Universe.</p> <p>Start Channel: Sets the start channel that handles Art-Net.  "Channel definitions" p.246</p> <p>Channel Information: Displays the settings for each Art-Net channel.</p>
Message Broadcasting	<p>Set this to On to receive information sent by the Message Broadcasting feature in the Epson Projector Management software.</p> <p>Download software and User's Guides from the following Web site. http://www.epson.com</p>

Reset menu

Resets all of the network settings.

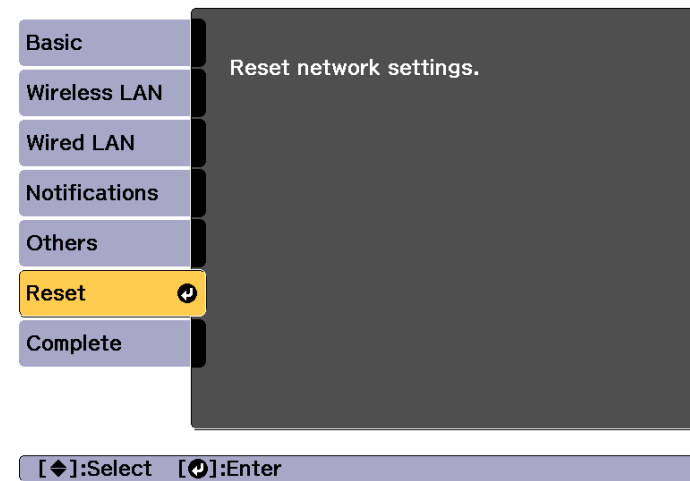

Submenu	Function
Reset network settings.	To reset all of the Network settings, select Yes.

Info Menu (Display Only)

Lets you check the status of the image signals being projected and the status of the projector. Items that can be displayed vary depending on the source currently being projected.

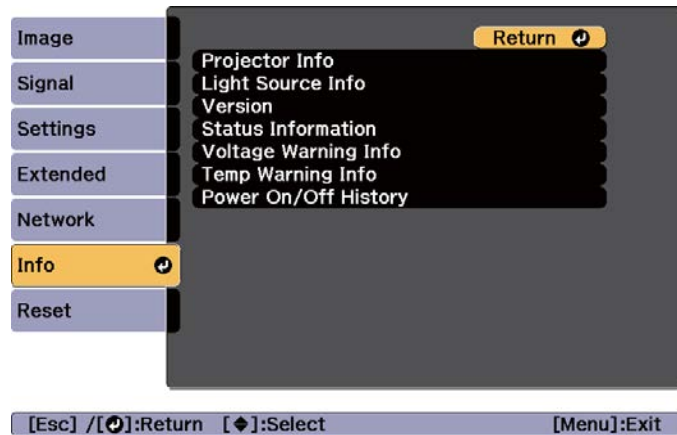



Submenu	Function	
Projector Info	Operation Hours	Displays the operation time after turning on the projector.
	Source	You can display the source name for the connected equipment currently being projected.
	Input Signal	You can display the content of Input Signal set in the Signal menu according to the source.
	Resolution	You can display the resolution.
	Refresh Rate	You can display the Refresh Rate.
	Sync Info	You can display the image signal information. This information may be needed if service is required.
	Color Format	Displays color space and dynamic range information.
	Status	This is information about errors that have occurred on the projector. This information may be needed if service is required.
	Serial Number	Displays the projector's serial number.

Submenu	Function	
	Lens Type	Displays the model number of your lens.
	Event ID	When problems occur when the projector and computer are connected through the network, information on the problem is displayed using an Event ID. See the following page for information on interpreting the Event ID. ☛ "About Event ID" p.213
	HDBaseT Signal Level	Displays the level for the image signal being input from the HDBaseT port. When this is displayed in yellow, the strength of the signal level is reduced. We recommend the following signal levels. <ul style="list-style-type: none"> • 1080p: 16 dB or more • 4K: 18dB or more
Light Source Info	Light Source Hours	Displays the operating time for the light source according to the light source mode.
	Estimated Remains	When Constant Brightness is set to On , this displays the amount of time for which the brightness of the light source can be maintained.
Version	Main Video2 Sub Sub2 HDMI HDBaseT HDBaseT2 SDI Status Monitor AC Monitor	Displays the versions of the projector's software and the devices connected to the projector.
Status Information	Displays the projector's status. ☛ "Understanding the Status Information" p.182	

Submenu	Function
Voltage Warning Info	Displays a warning regarding the power voltage.
Temp Warning Info	Displays a high temperature warning. When you select Detail when a Warning or Error is displayed, you can check detailed logs for before and after the error was detected.
Power On/Off History	Displays the power on/off logs.

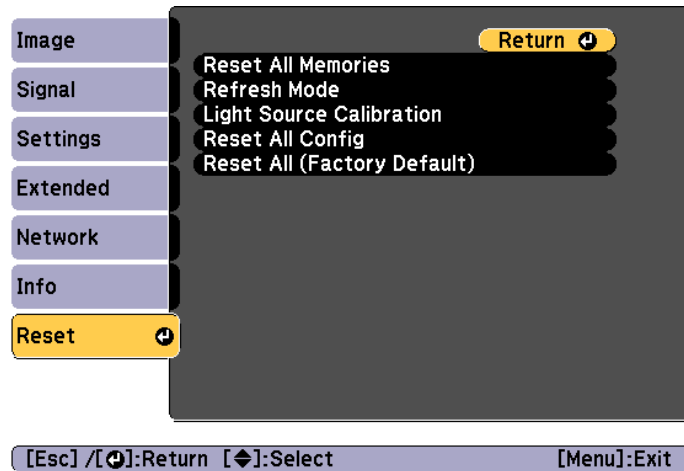
Reset Menu



Submenu	Function
Reset All Memories	Resets all names and settings saved in Memory , Lens Position , and Geometry Correction .  "Memory Function" p.109

Submenu	Function
Refresh Mode	<p>Make settings related to the Refresh Mode.</p> <ul style="list-style-type: none"> • Timer: Select when to run Refresh Mode. • Messages: Select whether or not to display messages during refresh operations. • Start: Removes any afterimages (screen burn-in) that remain in the projected image. The projector turns off once the set time has elapsed. When you press any button on the remote control, a message is displayed asking if you want to continue using Refresh Mode. When you press any button on the control panel, Refresh Mode is canceled.
Light Source Calibration	<p>Make settings related to Light Source Calibration. When performing Light Source Calibration, the difference between the white balance and the brightness level for the light source is corrected. We recommend running this function periodically.</p> <ul style="list-style-type: none"> • Run Now: Starts Light Source Calibration. This cannot be started in the following cases. <ul style="list-style-type: none"> - Within 20 minutes of turning on the projector. - If the surrounding temperature gets too high, and the brightness has been automatically dimmed. • Run Periodically: When this is set to On, Light Source Calibration is performed every 100 hours of use. When Off is selected to maintain the projected image that has been adjusted using Multi-Projection, perform corrections using Run Now or set the scheduling function to perform Light Source Calibration periodically. • Schedule Settings: Displays the schedule settings screen. Set Light Source Calibration to run periodically. • Last Run: Displays the last date and time Light Source Calibration was performed.

Submenu	Function
Reset All Config	<p>You can reset all items in the Configuration menu to their default settings.</p> <p>The following items are not reset to their defaults: Input Signal, Memory, User's Logo, all items for Network menus, Language, Date & Time, Panel Alignment, Color Uniformity, Lens Calibration, Color Calibration, Projector Grouping, Screen Matching, Color Matching, Light Source Info, Operation Hours, and User Default Setting.</p>
Reset All (Factory Default)	<p>Reset All (User Default): Returns each setting to the User Default Setting. You need to enter a password to perform a reset.</p> <p>Reset All (Factory Default): Resets all of the projector's settings. However, Date & Time, Operation Hours, Light Source Info, Password Protection items and their passwords are not reset. You need to enter a password to perform a reset.</p> <p>User Default Setting: Set the default settings for the following items.</p> <ul style="list-style-type: none"> • Light Source Mode • Brightness Level • Constant Brightness • A/V Output • Standby Mode • Standby Confirmation • Messages • Beep • Sleep Mode • Shutter Timer • Shutter Release • Color Mode • Wireless Mode • Wired LAN DHCP <p>Password: Set the password required to perform Reset All (User Default) or Reset All (Factory Default). The default password is set to "0000". Change this to your own desired password.</p>

Once the Configuration menu content has been set for one projector, you can use it to perform batch setup for multiple projectors (batch setup function). The batch setup function is only for projectors with the same model number.

Use one of the following methods.

- Setup using a USB flash drive.
- Setup by connecting the computer and projector with a USB cable.
- Set through Epson Projector Management.

This manual explains the USB flash drive and the USB cable methods.



- The content for Light Source Info and Status Information from the Info menu is not reflected by the batch setup function.
- Perform batch setup before adjusting the projected image. Adjustment values for the projected image, such as Geometry Correction are reflected by the batch setup function. If batch setup is performed after adjusting the projected image, the adjustments you made may change.
- By using the batch setup function, the registered User's Logo is set for the other projectors. Do not register confidential information and so on as the User's Logo.
- If you do not want to copy the following settings, set **Batch Setup Range** to **Limited**.
 - **EDID** from the **Signal** menu
 - **Network** menu (except for the **Notifications** menu and the **Others** menu)
 - ☛ **Extended - Operation - Advanced - Batch Setup Range** p.147
- Items for which Password Protection is set are not copied.



Caution

Performing batch setup is the customer's responsibility. If batch setup fails due to a power failure, communication error, and so on, the customer is responsible for any repair costs incurred.

Setup Using a USB Flash Drive

This section explains how to perform batch setup using a USB flash drive.



- Use a FAT format USB flash drive.
- The batch setup function cannot be used by USB flash drives that incorporate security functions. Use a USB flash drive that does not incorporate security functions.
- The batch setup function cannot be used by USB card readers or USB hard disks.

Saving settings to the USB flash drive

- 1 Turn off the main power switch while the power cord is connected to the projector, and check that all of the projector's indicators turn off.
- 2 Connect the USB flash drive to the projector's USB-A port.
 - ☛ "Installing the Wireless LAN Unit" [p.55](#)

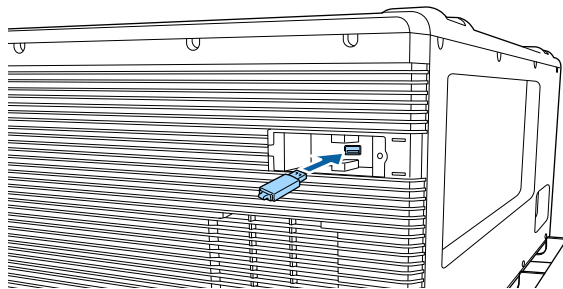

- Connect the USB flash drive directly to the projector. If the USB flash drive is connected to the projector through a USB hub, the settings may not be saved correctly.
- Connect an empty USB flash drive. If the USB flash drive contains data other than the batch setup file, the settings may not be saved correctly.
- If you have saved a batch setup file from another projector to the USB flash drive, delete the file or change the file name. The batch setup function cannot overwrite a batch setup file.
- The file name for the batch setup file is PJCONFDATA.bin. If you need to change the file name, add text after PJCONFDATA. If you change the file name in any other way, the projector may not be able to recognize the file correctly.
- You can only use single-byte characters for the file name.

- 3 While holding down the [Esc] button, turn on the main power switch.

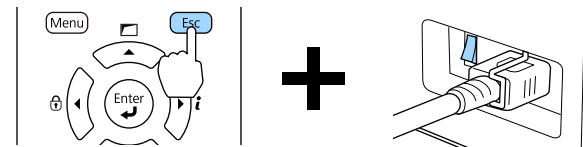

When the projector's indicators turn on as follows, release the [Esc] button.

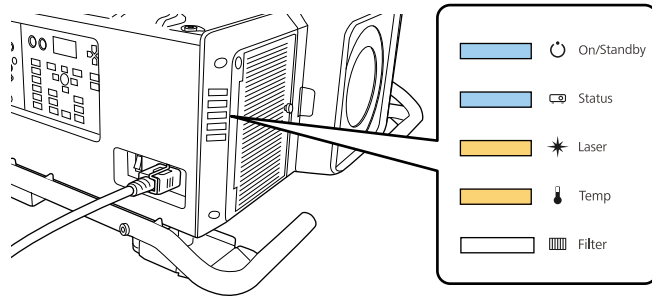

Power	Status	Laser	Temp
Blue - On	Blue - On	Orange - On	Orange - On

When all of the indicators start flashing, the batch setup file is being written.

⚠ Caution

- Do not disconnect the power cord from the projector or turn off the main power switch while the file is being written. If power is not being supplied, the projector may not startup correctly.
- Do not disconnect the USB flash drive from the projector while the file is being written. If the USB flash drive is disconnected, the projector may not start correctly.

When writing completes normally, the projector enters standby status.

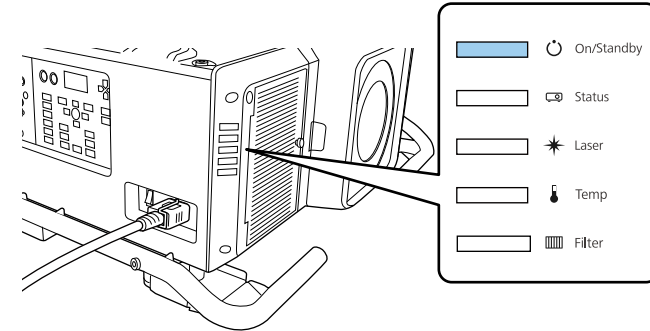

Power
Blue - On

When the projector is in standby status, remove the USB flash drive.

Reflecting saved settings to other projectors

- 1** Turn off the main power switch while the power cord is connected to the projector, and check that all of the projector's indicators turn off.
- 2** Connect the USB flash drive on which the settings are saved to the projector's USB-A port.

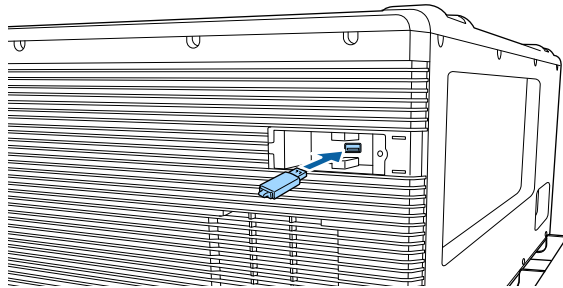

- When the USB flash drive contains 1 to 3 types of batch setup files, the file is reflected to the projector with the same model number. If there are multiple files for a projector with the same model number, the settings may not be reflected correctly.
- When there are four or more types of batch setup files on the USB flash drive, the settings may not be reflected correctly.
- Do not store any data except for the batch setup file on the USB flash drive. If the USB flash drive contains data other than the batch setup file, the settings may not be reflected correctly.

- 3** While holding down the [Menu] button, turn on the main power switch.

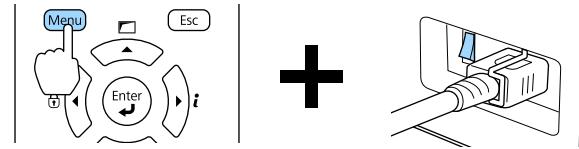

When the projector's indicators turn on as follows, release the [Menu] button.

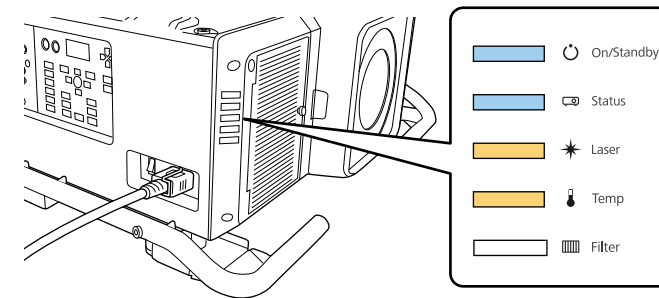

Power	Status	Laser	Temp
Blue - On	Blue - On	Orange - On	Orange - On

The indicators remain on for about 75 seconds.

When all of the indicators start flashing, the settings are being written.

Caution

- Do not disconnect the power cord from the projector or turn off the main power switch while the settings are being written. If power is not being supplied, the projector may not startup correctly.
- Do not disconnect the USB flash drive from the projector while the settings are being written. If the USB flash drive is disconnected, the projector may not start correctly.

- 4** When writing completes normally, the projector enters standby status.

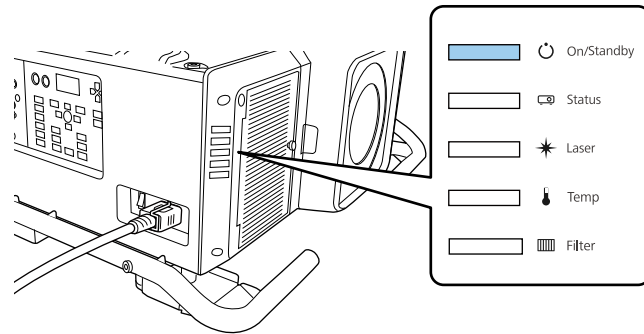

Power
Blue - On

When the projector is in standby status, remove the USB flash drive.

Setup by Connecting the Computer and Projector with a USB Cable



The following operating systems support the batch setup function.

- Windows Vista or later
- OS X 10.7.x or later

Saving settings to a computer

- 1** Turn off the main power switch while the power cord is connected to the projector, and check that all of the projector's indicators turn off.
- 2** Connect the computer's USB port to the projector's Service port with a USB cable.

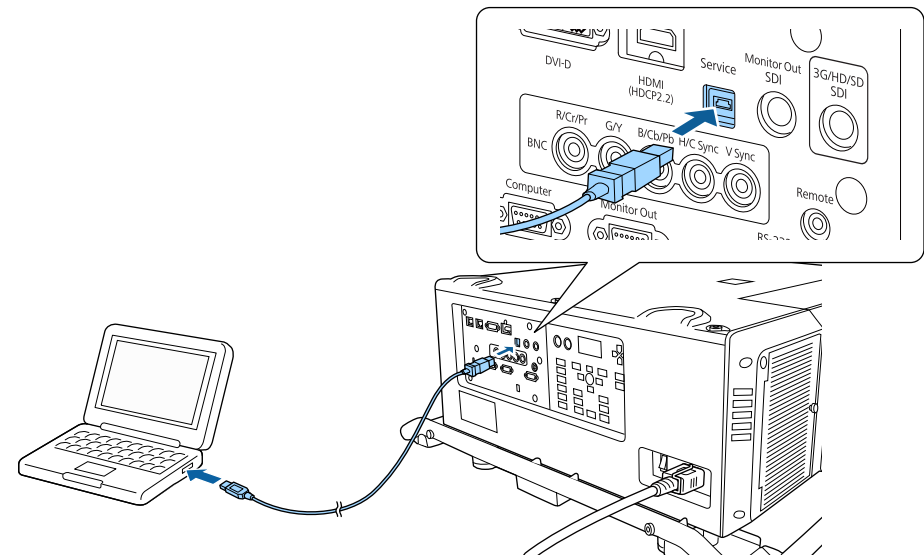

- 3** While holding down the [Esc] button, turn on the main power switch.

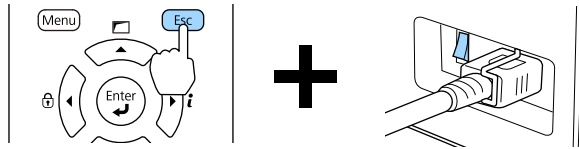

When the projector's indicators turn on as follows, release the [Esc] button.

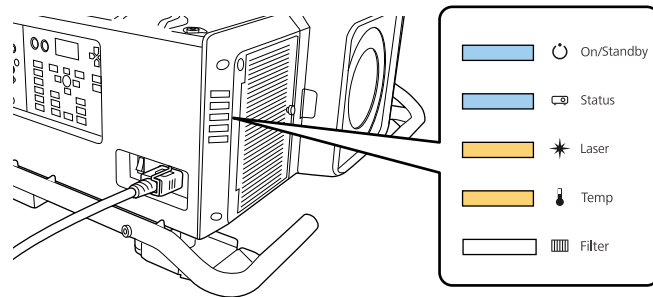

Power	Status	Laser	Temp
Blue - On	Blue - On	Orange - On	Orange - On

The projector is recognized as a removable disk by the computer.

- 4** Open the removable disk, and save the batch setup file (PJCONFDATA.bin) to the computer.



If you need to change the name of the batch setup file, add text after PJCONFDATA. If you change the file name, the projector may not be able to recognize the file correctly.

- 5** Perform "Remove USB device" on your computer, and then disconnect the USB cable.



When using Mac, perform "Remove EPSON_PJ".

The projector enters standby status.

Reflecting saved settings to other projectors

- 1** Turn off the main power switch while the power cord is connected to the projector, and check that all of the projector's indicators turn off.
- 2** Connect the computer's USB port to the projector's Service port with a USB cable.

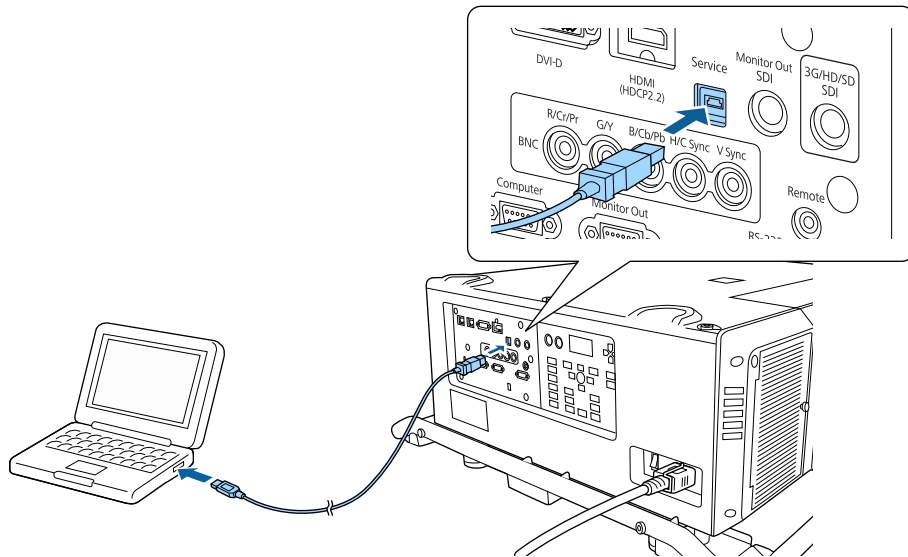

- 3** While holding down the [Menu] button, turn on the main power switch.

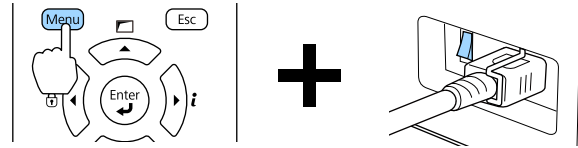

When the projector's indicators turn on as follows, release the [Menu] button.

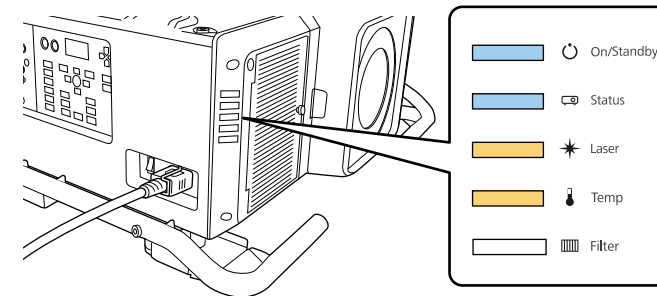

Power	Status	Laser	Temp
Blue - On	Blue - On	Orange - On	Orange - On

The projector is recognized as a removable disk by the computer.

- 4** Copy the batch setup file (PJCONFDATA.bin) that you saved to your computer to the top level folder of the removable disk.



Do not copy any files or folders other than the batch setup file to the removable disk.

- 5** Perform "Remove USB device" on your computer, and then disconnect the USB cable.



When using Mac, perform "Remove EPSON_PJ".

When all of the indicators start flashing, the settings are being written.



Caution

Do not disconnect the power cord from the projector or turn off the main power switch while the settings are being written. If power is not being supplied, the projector may not startup correctly.

When writing completes normally, the projector enters standby status.

When Setup Fails

The Indicators notify you if an error occurs. Check the status of the projector's Indicators and follow the instructions described in the table here.

Status of the Indicators	Remedy
<p>Laser: Orange - flashing fast Temp: Orange - flashing fast</p>	<p>The batch setup file may be corrupt, or the USB flash drive may not be connected correctly. Disconnect the USB flash drive, unplug and then plug in the projector's power cord, and then try again.</p>
<p>Power: Blue - flashing fast Status: Blue - flashing fast Laser: Orange - flashing fast Temp: Orange - flashing fast</p>	<p>Writing the settings may have failed and an error may have occurred in the projector's firmware. Stop using the projector, remove the power plug from the electrical outlet, and contact your local dealer or the nearest address provided in the Epson Projector Contact List. Epson Projector Contact List</p>



Troubleshooting

This chapter explains how to identify problems and what to do if a problem is found.

If a problem occurs with the projector, you can display the Help screen to assist you. You can also set the projector to an appropriate state by answering the questions.



Before displaying the help screen, assign **Help** to a **User Button**.
 ➔ **Settings - User Button p.145**

- 1 Press the [User] button to which **Help** was assigned.
 The Help screen is displayed.

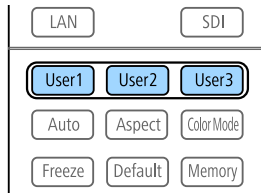

- 2 Select a menu item.

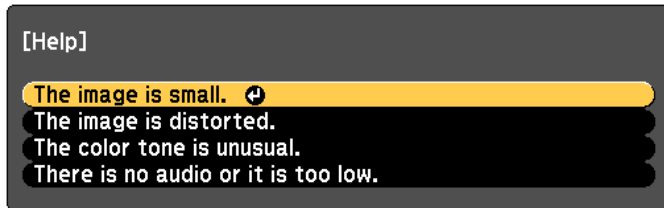

[↕]:Select [↵]:Enter [Menu]:Exit

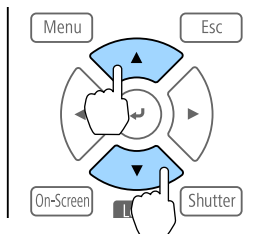

- 3 Confirm the selection.

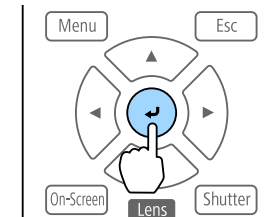

Questions and solutions are displayed as shown on the screen below.
 Press the [Menu] button to exit Help.

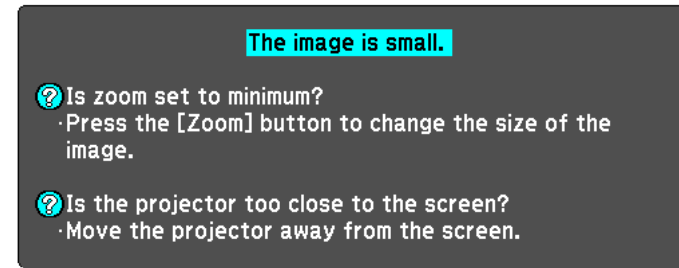

[Esc]:Return [Help]:Exit



See the following if the Help function does not provide a solution to the problem.
 ➔ "Reading the Indicators" p.175



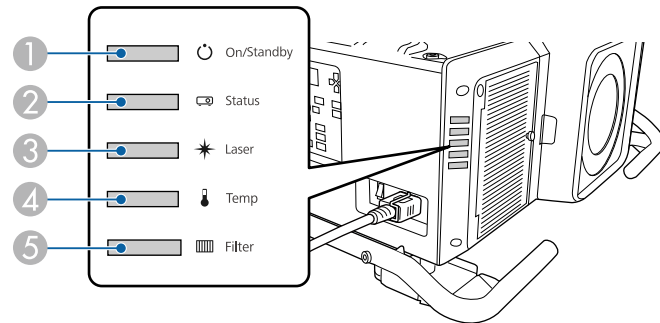







This projector has the following five indicators to indicate the projector's status.





























- ① Power indicator
Indicates the projector's status.
- ② Status indicator
Indicates the projector's status.
- ③ Laser indicator
Indicates the light source status.
- ④ Temp indicator
Indicates the internal temperature status. This is normally turned off.
- ⑤ Filter indicator
Indicates the air filter status. This is normally turned off.





















The following indicator status are used during regular operation.





















"Status varies" indicates that the indicators turn on, off, or flash depending on the status of the projector.

























Indicator					Projector's Status	Explanation
Power	Status	Laser	Temp	Filter		
 Blue - On	 Off	 Off	 Off	 Off	Standby condition	Power is being supplied to the projector. In this status, you can start projecting by pressing the [Ⓜ] button on the remote control or control panel. (Sometimes, when the power cord is unplugged, the power indicator remains lit for a short period, but this is not a fault.)
					Network monitoring status	The projector is being monitored and controlled over a network (when Standby Mode is set to Communication On). If the power cord is disconnected and then reconnected in this status, the power indicator flashes blue.
 Blue - On	 Blue - Flashing	 Status varies	 Off	 Off	Warm-up status	This is the status immediately after turning on the projector. Warm-up takes approximately 30 seconds after the light source turns on. The [Ⓜ] button is disabled during warm-up.















Indicator					Projector's Status	Explanation
Power	Status	Laser	Temp	Filter		
 Blue - On	 Blue - On	 Status varies	 Off	 Off	Projecting	The projector is projecting.
 Blue - On	 Blue - Flashing	 Off	 Off	 Off	Cool down status	This is the status immediately after turning off the power. In this status, all buttons are disabled.
 Blue - Flashing	 Off	 Off	 Off	 Off	Preparing Network monitoring	Preparing to monitor and control this projector over a network. During network monitoring preparation, all button operations are disabled.
 Blue - On	 Blue - On	 Blue - Flashing	 Off	 Off	Shutter is active	The Shutter function is activated.
 Status varies	 Blue - Flashing	 Orange - Flashing	 Status varies	 Status varies	Refresh Mode activated	Refresh Mode is active.  Reset - Refresh Mode p.163

When an error has occurred in the projector, the error status is indicated by the indicator's color and combination of flashing or lit. Refer to the following table to see what the indicators mean and how to remedy problems that they indicate.

Indicator					Cause	Remedy or Status	LCD Display
Power	Status	Laser	Temp	Filter			
 Off	 Blue - Flashing	 Orange - Flashing	 Off	 Off	Internal Error	Stop using the projector, remove the power plug from the electrical outlet, and contact your local dealer or the nearest address provided in the Epson Projector Contact List.  Epson Projector Contact List	Internal Error xx
 Off	 Blue - Flashing	 Off	 Orange - Flashing	 Off	Fan Error Sensor Error Pump Error	Stop using the projector, remove the power plug from the electrical outlet, and contact your local dealer or the nearest address provided in the Epson Projector Contact List.  Epson Projector Contact List	Fan Error xx Sensor Error xx Pump Error
 Off	 Blue - Flashing	 Off	 Orange - On	 Off	High Temp Error (Overheating)	<p>The light source turns off automatically and projection stops. Wait for about five minutes. After about five minutes, the projector switches to standby mode, so check the following four points.</p> <ul style="list-style-type: none"> • Check that the air filter, air exhaust vent, and air intake vent are clear, and that the projector is not positioned against a wall. • Check if the air intake temperature is too high. • If the air filter is clogged, remove the power cord from the electrical outlet, and then clean or replace them. <ul style="list-style-type: none">  "Cleaning the Air Filter and Air Intake Vent" p.216  "Replacing the Air Filter" p.221 • Use the projector in an environment that is not too hot. <p>If the error continues after checking the points above, stop using the projector, remove the power plug from the electrical outlet, and contact your local dealer or the nearest address provided in the Epson Projector Contact List.  Epson Projector Contact List</p> <p>When using at an altitude of 1500 m or more, set High Altitude Mode to On.  Extended - Operation - High Altitude Mode p.147</p>	Temp Error xx

Indicator					Cause	Remedy or Status	LCD Display
Power	Status	Laser	Temp	Filter			
Off	 Blue - Flashing	 Orange - On	Off	Off	Laser Error Retardation Plate Error	Stop using the projector, remove the power plug from the electrical outlet, and contact your local dealer or the nearest address provided in the Epson Projector Contact List.  Epson Projector Contact List	Laser Error
Off	 Blue - Flashing	Off	Off	 Orange - On	Filter Airflow Error	Check the following two points. <ul style="list-style-type: none"> • Check that the air filter and air exhaust vent are clear, and that the projector is not positioned against a wall. • If the air filter is clogged, turn off the power, remove the power cord from the electrical outlet, and then clean or replace them.  "Cleaning the Air Filter and Air Intake Vent" p.216  "Replacing the Air Filter" p.221 After checking, connect the power cord to the electrical outlet. If the error continues after checking the points above, stop using the projector, remove the power plug from the electrical outlet, and contact your local dealer or the nearest address provided in the Epson Projector Contact List.  Epson Projector Contact List	Airflow Error
Off	 Blue - Flashing	 Orange - On	 Orange - On	Off	Lens Shift Error Supply Voltage Error	Stop using the projector, remove the power plug from the electrical outlet, and contact your local dealer or the nearest address provided in the Epson Projector Contact List.  Epson Projector Contact List	Lens Shift Err Power Error
Off	 Blue - Flashing	 Orange - On	 Orange - On	Off	Lens Error No Lens	Install the lens unit. If the lens unit is already installed, remove it and then reinstall it. If the error continues after checking the points above, stop using the projector, remove the power plug from the electrical outlet, and contact your local dealer or the nearest address provided in the Epson Projector Contact List.  Epson Projector Contact List	Lens Error
Off	 Blue - Flashing	 Orange - Flashing	 Orange - Flashing	Off	Shutter Error	Stop using the projector, remove the power plug from the electrical outlet, and contact your local dealer or the nearest address provided in the Epson Projector Contact List.  Epson Projector Contact List	Shutter Error

Indicator					Cause	Remedy or Status	LCD Display
Power	Status	Laser	Temp	Filter			
 Blue - Flashing	 Status varies	 Status varies	 Orange - Flashing	 Status varies	High Temp Warning	This is not an error. However, if the temperature rises too high again, projection stops automatically. Check the following four points. <ul style="list-style-type: none"> • Check that the air filter, air exhaust vent, and air intake vent are clear, and that the projector is not positioned against a wall. • Check if the air intake temperature is too high. • If the air filter is clogged, turn off the power, remove the power cord from the electrical outlet, and then clean or replace them. <ul style="list-style-type: none"> ☛ "Cleaning the Air Filter and Air Intake Vent" p.216 ☛ "Replacing the Air Filter" p.221 • Use the projector in an environment that is not too hot. 	Temp Warning Temp Warning FE
 Blue - Flashing	 Status varies	 Orange - Flashing	 Status varies	 Status varies	Laser Warning	After displaying the warning, an error occurs and projection stops automatically. Stop using the projector, remove the power plug from the electrical outlet, and contact your local dealer or the nearest address provided in the Epson Projector Contact List. <ul style="list-style-type: none"> ☛ Epson Projector Contact List 	Laser Warning
 Blue - Flashing	 Status varies	 Orange - Flashing	 Status varies	 Status varies	Lens Warning	An unsupported lens is attached. Use a supported lens. <ul style="list-style-type: none"> ☛ "Optional Accessories and Consumables" p.252 	Lens Error
 Blue - Flashing	 Status varies	 Orange - Flashing	 Status varies	 Status varies	Power Warning	The power voltage was not measured correctly, so the brightness of the light source has been dimmed. Contact your local dealer or the nearest address provided in the Epson Projector Contact List. <ul style="list-style-type: none"> ☛ Epson Projector Contact List 	Power Warning
 Blue - Flashing	 Status varies	 Orange - Flashing	 Orange - Flashing	 Status varies	Shutter Warning	After displaying the warning, an error occurs and projection stops automatically. Stop using the projector, remove the power plug from the electrical outlet, and contact your local dealer or the nearest address provided in the Epson Projector Contact List. <ul style="list-style-type: none"> ☛ Epson Projector Contact List 	Shutter Warning

Indicator					Cause	Remedy or Status	LCD Display
Power	Status	Laser	Temp	Filter			
 Blue - Flashing	 Status varies	 Status varies	 Status varies	 Orange - On	Low Air Flow	This is not an error. However, projection stops automatically if the airflow falls any further. The message "The air filter is clogged. Clean or replace the air filter." is displayed. Check the following two points. <ul style="list-style-type: none"> • Check that the air filter and air exhaust vent are clear, and that the projector is not positioned against a wall. • If the air filter is clogged, turn off the power, remove the power cord from the electrical outlet, and then clean or replace them. <ul style="list-style-type: none"> ☛ "Cleaning the Air Filter and Air Intake Vent" p.216 ☛ "Replacing the Air Filter" p.221 If the error continues after checking the points above, stop using the projector, remove the power plug from the electrical outlet, and contact your local dealer or the nearest address provided in the Epson Projector Contact List. ☛ Epson Projector Contact List	Airflow Decline
 Status varies	 Status varies	 Status varies	 Status varies	 Orange - Flashing	Air Filter Notice	"Time to clean the air filter. Clean or replace the air filter." is displayed. Turn off the projector's power, unplug the power cord from the electrical outlet, and then clean the air filter. ☛ "Cleaning the Air Filter and Air Intake Vent" p.216 The indicators or messages regarding air filter notice are displayed only when Air Filter Notice is set to On in the Configuration menu. ☛ Extended - Display - Air Filter Notice p.147	Clean Filter
 Status varies	 Status varies	 Orange - Flashing	 Status varies	 Status varies	Constant Brightness End	Ends the Constant Brightness mode in Brightness Settings . ☛ "Setting the Brightness" p.75	ConstBRT Expired



- See the following if the projector is not operating properly, even though the indicators are all showing normal.
 - ☛ "Problem Solving" [p.200](#)
- If the indicators are in a state not shown in this table, stop using the projector, remove the power plug from the electrical outlet, and contact your local dealer or the nearest address provided in the Epson Projector Contact List.
 - ☛ [Epson Projector Contact List](#)

The LCD on the control panel indicates the projector's status. Also, you can check the detailed status or error history of this projector by using the buttons on the control panel.



Make the following settings to use the LCD display when the projector is in standby mode.

Set **Standby Mode** to **Communication On**.

☛ **Extended - Standby Mode** [p.147](#)

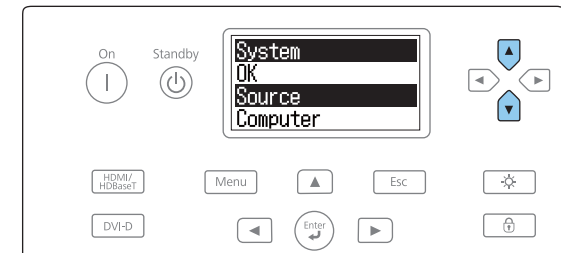

The LCD display turns on in the following situations.

- When one button is pressed on the control panel
- When an error or a warning occurs
- When adjusting the zoom, focus, or lens shift
- When checking the projector ID

☛ "Checking the projector ID" [p.44](#)

If you do not want to turn on the LCD display, set **Lighting Time** to **Off**.

☛ "Setting the screen display (LCD)" [p.184](#)

Checking the Status

To display the status, press the [] button on the control panel.

There are eight display categories for the status, and each time you press the [][] buttons, the category switches in the following order.

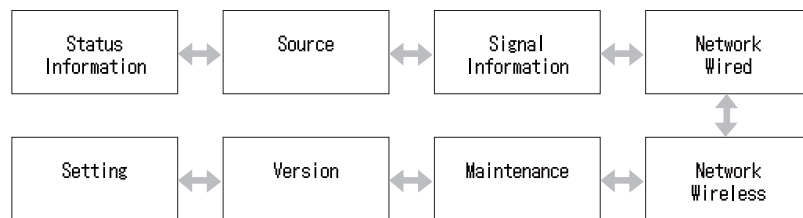
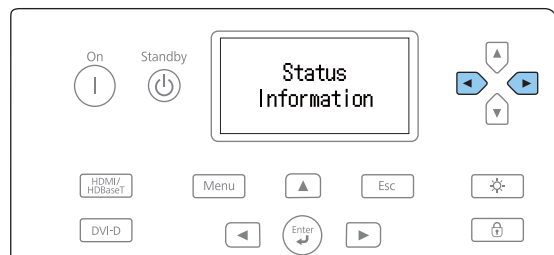

You can check the items and information of each category by using the [][] buttons.

Understanding the screen

Normal display

Each display category contains the following information.

- Status Information : Operating status of the projector
- Source : Input signal information
- Signal Information : Input digital signal information
- Network Wired : Wired LAN settings
- Network Wireless : Wireless LAN settings
- Maintenance : Operating time for the projector and light source
- Version : Projector's firmware version

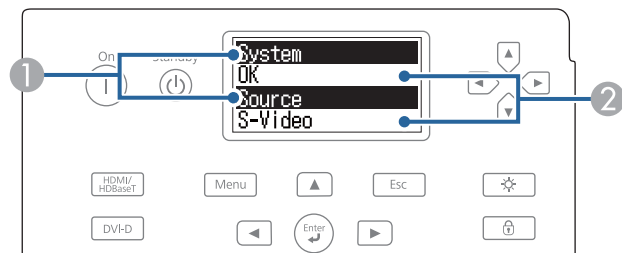

①	Displays the item name. ☛ "Explanations of the Display Content" p.185
②	Information about the items.

Display when error or warning occurs

When a problem has occurred in the projector, the following is displayed.

When an error occurs



When a warning occurs

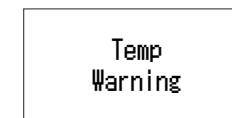

If the problem is cleared, or one of the [Up][Down][Left][Right] buttons is pressed, the display returns to normal.

See the following for more information on the error or warning contents and remedies.

☛ "Reading the Indicators" p.175

Setting the screen display (LCD)

You can adjust the contrast and the lighting time for the back light.

- 1 Press the [◀][▶] buttons to select **Setting**.

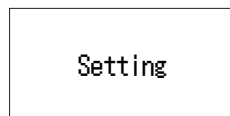

- 2 Press the [↑] button to display the following screen.

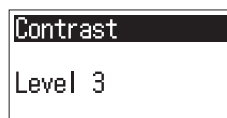

- 3 Press the [◀][▶] buttons to adjust the contrast.

- 4 Press the [↓] button to display the following screen.



- 5 Press the [◀][▶] buttons to set the lighting time for the back light.

The default is set to **30sec** (30 seconds). You can set from **Off** (light is off), **10-60sec**, **30min** (30 minutes), and **Always** (Always On).

Explanations of the Display Content

Items displayed vary depending on the model being used and the image signal and source being projected.

Category	Item	Status Display	Explanation	
Status Information	System	Displays the projector's status. See the following for more information on how to remedy the errors and warnings. ☛ "Reading the Indicators" p.175		
		OK	The projector is in normal status.	
		Warm-Up	The projector is warming up.	
		Standby	The projector is in standby status.	
		Cool Down	The projector is in cool down status.	
		Temp Error 09	A high temp error has occurred. (Air intake)	
		Temp Error 0C		A high temp error has occurred. (Power)
		Temp Error 1D		
		Temp Error 23		
		Temp Error 31		
		Temp Error 32		
		Temp Error 33		
		Temp Error 34		
		Temp Error 35		
		Temp Error 36		
		Temp Error 37		
		Temp Error 45		
		Temp Error 46		
Temp Error 47				
Temp Error 48				
Temp Error 49				

Category	Item	Status Display	Explanation
Status Information	System	Temp Error 12	A high temp error has occurred. (Light source)
		Temp Error 3E	
		Temp Error 3F	
		Temp Error 40	
		Temp Error 41	
		Temp Error 44	
		Temp Error 54	
		Temp Error 2A	A high temp error has occurred. (LCD panel)
		Temp Error 2B	
		Temp Error 2C	
		Temp Error 39	A high temp error has occurred. (Pump)
		Temp Error 3A	
		Temp Error 3C	
		Temp Error 3D	
		Temp Error 42	A high temp error has occurred. (Air exhaust)
		Temp Error 43	
		Temp Error 4A	A high temp error has occurred. (Light source power)
		Temp Error 4B	
		Temp Error 4C	
		Temp Error 4D	
		Temp Error 4E	
		Fan Error 04	A fan error has occurred. (Optical unit)
		Fan Error 05	
		Fan Error 18	
Fan Error 2D			

Category	Item	Status Display	Explanation
Status Information	System	Fan Error 14	A fan error has occurred. (Power)
		Fan Error 17	
		Fan Error 22	A fan error has occurred. (Light source)
		Fan Error 23	
		Fan Error 2E	
		Fan Error 2F	
		Fan Error 25	A fan error has occurred. (Pump)
		Fan Error 26	
		Fan Error 27	
		Fan Error 28	
		Fan Error 29	A fan error has occurred. (LCD panel)
		Fan Error 2A	
		Fan Error 2B	
		Sensor Error 09	A sensor error has occurred. (Air intake)
		Sensor Error 0C	A sensor error has occurred. (Power)
		Sensor Error 1D	
		Sensor Error 23	
		Sensor Error 31	
		Sensor Error 32	
		Sensor Error 33	
		Sensor Error 34	
		Sensor Error 35	
		Sensor Error 36	
		Sensor Error 37	
Sensor Error 45			
Sensor Error 46			

Category	Item	Status Display	Explanation
Status Information	System	Sensor Error 47	A sensor error has occurred. (Power)
		Sensor Error 48	
		Sensor Error 49	
		Sensor Error 4A	
		Sensor Error 4B	
		Sensor Error 4C	
		Sensor Error 4D	
		Sensor Error 4E	
		Sensor Error 12	A sensor error has occurred. (Light source)
		Sensor Error 3E	
		Sensor Error 3F	
		Sensor Error 40	
		Sensor Error 41	
		Sensor Error 44	
		Sensor Error 54	
		Sensor Error 2A	A sensor error has occurred. (Optical unit)
		Sensor Error 2B	
		Sensor Error 2C	
		Sensor Error 39	A sensor error has occurred. (Pump)
		Sensor Error 3A	
		Sensor Error 3C	
		Sensor Error 3D	
		Sensor Error 42	A sensor error has occurred. (Air exhaust)
		Sensor Error 43	

Category	Item	Status Display	Explanation
Status Information	System	Internal Error 01	An internal error has occurred. (Circuit board)
		Internal Error 02	
		Internal Error 03	
		Internal Error 04	
		Internal Error 05	
		Internal Error 06	
		Internal Error 07	
		Internal Error 08	
		Internal Error 09	
		Internal Error 0A	
		Internal Error 0B	
		Internal Error 0C	
		Internal Error 0D	An internal error has occurred. (Built-in camera)
		Internal Error 0E	
		Internal Error 0F	An internal error has occurred. (Optical unit)
		Internal Error 10	
		Internal Error 11	
		Airflow Error	A filter airflow error has occurred.
		Shutter Error	A shutter error has occurred.
		Pump Error	A pump error has occurred.
		Temp Warning	A high temp warning has occurred.
		Internal Warning	A warning about the internal system has occurred.
		Shutter Warning	A shutter warning has occurred.
Airflow Decline	A low air flow error has occurred.		
Clean Filter	An air filter notice has occurred.		
Lens Shift Err	A lens shift error has occurred.		



Category	Item	Status Display	Explanation
		Lens Error	A lens error has occurred.
		Power Error	A supply voltage error has occurred.



Category	Item	Status Display	Explanation
Status Information	System	Laser Error 01	A laser error has occurred. (Light source)
		Laser Error 02	
		Laser Error 03	
		Laser Error 04	
		Laser Error 05	
		Laser Error 16	
		Laser Error 17	
		Retardation Err	
		Laser Error 0B	A laser error has occurred. (Light source driver)
		Laser Error 0C	
		Laser Error 0D	
		Laser Error 0E	
		Laser Error 0F	
		Laser Error 15	
		Laser Warning	A laser warning has occurred.
		Temp Error FE	A laser error has occurred because the laser temperature is too high.
		Temp Warning FE	A laser warning has occurred because the laser temperature is too high.

Category	Item	Status Display	Explanation
Status Information Source	Last Warn/Err	–	Displays the most recent warnings and errors for the status displayed in the System.
	Source	HDMI	Displays the source name for the connected equipment currently being projected.
		HDBaseT	
		DVI-D	
		SDI	
		Computer	
		BNC	
		LAN	
	On-Screen Display	On	Displays the settings for the On-Screen Display. When set to Off , the menus or messages are not displayed on the projected images.
		Off	
	Shutter	Open	Displays the projector's Shutter function status.
		Open	
		Close	
Shutter Startup	Last Used	Displays the settings for Startup . ☛ Extended - Operation - Shutter Settings - Startup p.147	
	Open		
	Close		
Shutter Standby	Open	Displays the settings for Standby . ☛ Extended - Operation - Shutter Settings - Standby p.147	
	Close		
Intake Air Temp	–	Displays the air intake temperature. When you press the [↔][↔] buttons for five seconds, the Warning/Error screen is displayed. Press the [↔] button twice to display the Temp Log screen. Press the [↔][↔] buttons for five seconds to return to the Status Information screen.	
Internal Temp Lv	–	Displays the projector's internal temperature.	

Category	Item	Status Display	Explanation
	AC Voltage	–	<p>Monitors the status of the input voltage, and displays a warning or an error when a momentary voltage drop occurs.</p> <p>When you press the [↔][↔] buttons for five seconds, the Warning/Error screen is displayed. Press the [↔] button to display the Voltage Log screen.</p> <p>The Voltage Log screen displays the latest 30 logs.</p> <p>When you press the button while Warning or Error is displayed, you can check detailed logs before and after the error was detected.</p> <p>Example: 175V: Indicates that the voltage is 175 V. B50V: Indicates that the voltage is less than 50 V. ---V: Indicates that the voltage log cannot be measured. Press the [↔][↔] buttons for five seconds to return to the Status Information screen.</p> <p>Check the following if logs are not displayed correctly.</p> <p>🔊 "Detailed logs and error message are not displayed" p.212</p>
		<Warning1>	<p>Voltage drops (when operating at 200 V): If the input voltage is less than 180 V for more than 1000 msec, logs (120) are displayed for approximately one second* before and after the issue occurred.</p> <p>Voltage drops (when operating at 100 V): If the input voltage is less than 89 V for more than 1000 msec, logs (120) are displayed for approximately one second* before and after the issue occurred.</p> <p>* The number of seconds varies according to the power supply frequency (50 Hz/60 Hz).</p>
		<Warning2>	<p>Voltage drops (when operating at 200 V): If the input voltage is less than 160 V for more than 500 msec, logs (120) are displayed for approximately one second* before and after the issue occurred.</p> <p>* The number of seconds varies according to the power supply frequency (50 Hz/60 Hz).</p>
		<Warning3>	<p>Power flicker: If the input voltage drops below 85 V for more than 40 msec, and the voltage returns within 60 msec, logs for approximately one second before the power flicker was detected (60 logs) and for approximately 0.1 seconds after (6 logs) are displayed.</p>
		<Error>	<p>Power cut: If the input voltage drops below 85 V for more than 60 msec, the projector is automatically disconnected from the power supply. Logs for approximately one second before the event was detected (60 logs) are displayed.</p> <p>When direct shutdown is enabled, an <Error> is generated when a direct shutdown is performed, however this is not an actual error.</p>



Category	Item	Status Display	Explanation
	Laser Status	On	Displays the operating status of the light source.
		Off	
	Source	HDMI	Displays the source name for the connected equipment currently being projected.
		HDBaseT	
		DVI-D	
		SDI	
		Computer	
		BNC	
		LAN	
	Resolution	-	Displays the resolution of the current input signal. No Signal: No signals are being input. Not Supported: The projector does not support the current input signal.

Category	Item	Status Display	Explanation	
Source	Color Space	–	Displays the color space of the current input signal.	
	H-Frequency	–	Displays the horizontal frequency of the current input signal.	
	V-Frequency	–	Displays the vertical frequency of the current input signal.	
	Sync Polarity	H:Posi / V:Posi	H:Posi / V:Nega H:Nega / V:Posi H:Nega / V:Nega	Displays the Sync polarity.
		H:Posi / V:Nega		
		H:Nega / V:Posi		
		H:Nega / V:Nega		
	Sync Mode	Composite Sync	Composite Sync Separate Sync Sync On Green	Displays the sync type.
		Separate Sync		
		Sync On Green		
	Detected Mode	–	Displays the discriminant resolution of the current input signal.	
	Transport	Interlace	Interlace Progressive	Displays the scanning method.
		Progressive		
	Video Range	Auto(Limited)	Auto(Limited) Auto(Full) Limited(16-235) Full(0-255)	Displays the video level of the projector.
Auto(Full)				
Limited(16-235)				
Full(0-255)				



Items displayed for source vary depending on the model being used and the image signal and source being projected.

Category	Item	Status Display	Explanation
Signal Information	5V Detect	Detected	Displays the detection results of 5V signals.
		Not Detect	
	TMDS Clock	–	Displays the TMDS frequency of the current input signal.
	H-Frequency	–	Displays the horizontal frequency of the current input signal.
	V-Frequency	–	Displays the vertical frequency of the current input signal.
	DetChg 5CFHMP123	–	Displays the factors of signal changes.
	Stable Time	–	Displays the operating time since the input source is determined.
	HDCP Status	Non-HDCP	Displays the HDCP status.
		Passed	
		Failed	
	HDCP Ri	–	Displays the type for HDCP.
	HDCP AKSV	–	
	HDCP An	–	
	HDCP Ver	–	Displays the HDCP version.
	AVI VIC	–	Displays the VIC information (AVI) of the current input signal.
	AVI Checksum	OK	Displays the checksum result for AVI.
		NG	
	AVI Sampling Str	–	Displays color sampling for AVI.
	Signal Mode	HDMI	Displays the signal mode.
		DVI	
	Color Space	–	Displays the color space conversion method.
	HDR Mode	–	Displays the HDR mode.
	EDID Mode	–	Displays the EDID mode.
HDBaseT Level	–	You can display the image signal information from the HDBaseT port.	
SDI Link Mode	–	Displays the linking type for SDI.	
Sync Detect	–	Displays the results of signal detection for each 3G/HD/SD SDI port.	

Category	Item	Status Display	Explanation
	PayloadID Detect	–	Displays the results of SDI payload ID detection.
	Resolution	–	Displays the resolution.
	Refresh Rate	–	Displays the refresh rate for SDI.
	Color Sampling	–	Displays the color sampling.
	Pixel Depth	–	Displays the color depth for SDI.
	SDI Type	–	Displays the type of SDI.
	Division Type	–	Displays the split transmission method for SDI.
	3G Mapping Level	–	Displays the mapping level for 3G-SDI.
	Stream No. CH1/2	–	This information is displayed when there are multiple SDI ports. This is not available for this projector.
	Stream No. CH3/4	–	



Items displayed for Signal Information vary depending on the model being used and the image signal and source being projected.











Category	Item	Status Display	Explanation
Network Wired	Projector Name	–	Displays the projector name used to identify the projector when connected to a network.
	Connection Mode	HDBaseT	Displays the connection path for LAN.
		LAN	
	DHCP	On	Displays the DHCP settings.
		Off	
	IP Display	On	Displays the IP address display settings.
		Off	
IP Address	–	Displays the IP address.	
MAC Address	–	Displays the MAC address.	
Network Wireless	Projector Name	–	Displays the projector name used to identify the projector when connected to a network.
	Connection Mode	Quick	Displays the connection mode to use when connecting the projector and a computer over a wireless LAN.
		Advanced	
	SSID Display	On	Displays the SSID display settings.
		Off	
	IP Display	On	Displays the IP address display settings.
		Off	
	SSID	–	Displays the SSID.
	IP Address	–	Displays the IP address.
	DHCP	On	Displays the DHCP settings.
Off			
MAC Address	–	Displays the MAC address.	
Security	–	Displays the security settings.	
Antenna Level	LEVEL 0-5	Displays the reception status for Wi-Fi.	



Category	Item	Status Display	Explanation
Maintenance	Operation Time	–	Displays the total operation time of the projector.
	Laser Op.Time	–	Displays the laser operating time for each setting in Light Source Mode.
Version	Serial No.	–	Displays the projector's serial number.
	Main	–	Displays the projector's firmware version information.
	Video2	–	
	Sub	–	
	Sub2	–	
	HDBaseT	–	
	Status Monitor	–	

If any of the following problems occur and the indicators do not offer a solution, refer to the pages given for each problem.

Problems Relating to Images









<ul style="list-style-type: none"> • No images appear Projection does not start, the projection area is completely black, or the projection area is completely blue. 	 p.201
<ul style="list-style-type: none"> • Moving images are not displayed Videos played back on a computer are black or no image is projected, or the video is not played back on the computer. 	 p.202
<ul style="list-style-type: none"> • Projection stops automatically 	 p.202
<ul style="list-style-type: none"> • The message "Not supported" is displayed 	 p.202
<ul style="list-style-type: none"> • "No Signal" is displayed 	 p.202
<ul style="list-style-type: none"> • Images are fuzzy, out of focus, or distorted 	 p.203
<ul style="list-style-type: none"> • Interference or distortion appear in images 	 p.203
<ul style="list-style-type: none"> • The image is truncated (large) or small, the aspect ratio is not suitable, or the image has been reversed Only part of the image is displayed, the height and width ratios of the image are not correct, or the image may appear reversed from top to bottom or left to right. 	 p.204
<ul style="list-style-type: none"> • Image colors are not right The whole image appears purplish or greenish, images are black & white, or colors appear dull. 	 p.205
<ul style="list-style-type: none"> • Images appear dark 	 p.206
<ul style="list-style-type: none"> • Automatic adjustments are not performed correctly 	 p.206

Problems when Projection Starts

<ul style="list-style-type: none"> • The projector does not turn on 	 p.208
---	---

Other Problems

<ul style="list-style-type: none"> • There are afterimages (screen burn-in) in the projected image 	 p.209
--	---

<ul style="list-style-type: none"> • The remote control does not work 	 p.209
<ul style="list-style-type: none"> • Cannot control correctly using Art-Net 	 p.210
<ul style="list-style-type: none"> • Nothing appears on the external monitor 	 p.210
<ul style="list-style-type: none"> • I want to change the language for messages and menus 	 p.211
<ul style="list-style-type: none"> • Email is not received even if a problem occurs in the projector 	 p.211
<ul style="list-style-type: none"> • "The battery that saves your clock settings is running low." is displayed 	 p.211
<ul style="list-style-type: none"> • "The projector did not turn off correctly." is displayed 	 p.211
<ul style="list-style-type: none"> • "Detailed logs and error message are not displayed." is displayed 	 p.212

Problems Relating to Images

No images appear

Check	Remedy
Is the main power switch set to Off?	Turn on the main power switch to supply power to the projector.
Did you press the [ⓘ] button on the remote control or control panel?	Press the [ⓘ] button to turn on the power.
Are the indicators switched off?	The power cord is not connected correctly or power is not being supplied. Connect the projector's power cord correctly. Check that your electrical outlet or power source is functioning correctly.
Is Shutter active?	Press the [Shutter] button to release the Shutter function. ☛ "Hiding the Image Temporarily (Shutter)" p.106
Are the Configuration menu settings correct?	Reset all of the settings. ☛ Reset - Reset All Config p.163
Is the image to be projected completely black? (Only when projecting computer images)	Some input images, such as screen savers, may be completely black.
Is Windows Media Center displayed in full screen? (Only during network connection)	When Windows Media Center is displayed at full screen, you cannot project using a network connection. Reduce the screen size.
Is an application using the Windows DirectX function displayed? (Only during network connection)	Applications using the Windows DirectX function may not display images correctly.
Are you using any other image display equipment with the projector?	Other image display equipment may have a different resolution. Change the EDID setting on the Signal menu. ☛ Signal - Advanced - EDID p.143
Is the signal from the 3G/HD/SD SDI port set correctly?	Check the SDI Settings from the Configuration menu. ☛ Extended - SDI Settings p.147
Is the EDID set correctly?	Disconnect the cable for the image currently being projected from the projector, and then make EDID settings again. ☛ Signal - Advanced - EDID p.143

Moving images are not displayed

Check	Remedy
Is the computer's image signal being output to the LCD and the monitor? (Only when projecting images from a laptop computer or a computer with a built-in LCD screen)	Change the image signal from the computer to external output only. Check your computer's documentation, or contact the computer's manufacturer.
Are the contents of the moving image you are trying to project copyright protected?	The projector may not be able to project copyright protected moving images that are being played back on a computer. For more details, see the user's guide supplied with the player.

Projection stops automatically

Check	Remedy
Is Sleep Mode set to On ?	Press the [ⓘ] button to turn on the power. If you do not want to use Sleep Mode, change the setting to Off . 🖱️ Extended - Operation - Sleep Mode p.147

"Not supported" is displayed

Check	Remedy
Do the image signal resolution and the refresh rate correspond to the mode? (Only when projecting computer images)	Refer to the computer's documentation for how to change the image signal resolution and the refresh rate output from the computer. 🖱️ "Supported Monitor Displays" p.264

"No Signal" is displayed

Check	Remedy
Are the cables connected correctly?	Check that all the cables required for projection are securely connected. Check that no cables are disconnected and that there are no poor contacts in the cables.
Is the correct port selected?	Change the image by pressing the [Search] button. 🖱️ "Automatically Detecting Input Signals and Changing the Projected Image (Source Search)" p.60
Is the power for the computer or video source turned on?	Turn the power on for the equipment.

Check	Remedy
<p>Are the image signals being output to the projector? (Only when projecting images from a laptop computer or a computer with a built-in LCD screen)</p>	<p>If the image signals are only being output to the computer's LCD monitor or to the accessory monitor, you need to change the output to an external destination as well as the computer's own monitor. For some computer models, when the image signals are output externally, they no longer appear on the LCD monitor or accessory monitor.</p> <p>If the connection is made while the power of the projector or computer is already turned on, the Fn key (Function key) that changes the computer's image signal to external output may not work. Turn the power for the computer and the projector off and then back on again.</p> <p>☛ Computer's documentation and so on</p>

Images are fuzzy, out of focus, or distorted

Check	Remedy
<p>Is the focus adjusted correctly?</p>	<p>Make sure that at least 20 minutes has passed after the projection starts, and press the [Focus] button on the remote control to adjust the focus.</p> <p>☛ "Correcting the Focus" p.40</p>
<p>Is the projector at the correct distance?</p>	<p>Is it projecting outside of the recommended projection distance range? Setup within the recommended range.</p> <p>☛ "Screen Size and Projection Distance" p.253</p>
<p>Has condensation formed on the lens?</p>	<p>If the projector is suddenly taken from a cold environment to a warm environment, or if sudden ambient temperature changes occur, condensation may form on the surface of the lens, and this may cause the images to appear fuzzy. Set the projector up in the room about one hour before it is used. If condensation forms on the lens, turn the projector off and wait for the condensation to disappear.</p>

Interference or distortion appear in images

Check	Remedy
<p>Are the cables connected correctly?</p>	<p>Check that all the cables required for projection are securely connected.</p> <p>☛ "Connecting Equipment" p.48</p>
<p>Is the correct resolution selected? (Only when projecting computer images)</p>	<p>Set the computer so that the signals being output are compatible with the projector.</p> <p>☛ "Supported Monitor Displays" p.264</p> <p>☛ Computer's documentation and so on</p>

Check	Remedy
Is the Sync./Tracking adjusted correctly? (Only when projecting computer images)	Press the [Auto] button to perform automatic adjustment. If the images are not adjusted correctly even after performing automatic adjustment, you can also make adjustments from the Configuration menu. ☛ Signal - Tracking, Sync. p.143
Is the Resolution set to anything other than Auto ? (Only when projecting on a split screen)	The image may be collapsed if the Resolution on the Configuration menu and the resolution of the projected image are not the same. If the image is collapsed, set the Resolution to Auto . ☛ Signal - Resolution p.143

The image is truncated (large) or small, the aspect is not suitable, or the image has been reversed

Check	Remedy
Have the Screen been set correctly?	Make the appropriate Screen for the screen being used. ☛ "Screen Settings" p.34
Is the aspect adjusted correctly?	Press the [Aspect] button to select an aspect suitable for the input source. ☛ "Changing the Aspect Ratio of the Projected Image" p.78
Is a wide panel computer image being projected? (Only when projecting computer images)	Change the setting according to the signal for the connected equipment. ☛ Signal - Resolution p.143
Is Scale turned on?	Set Scale to Off on the configuration menu. ☛ Signal - Scale - Scale p.143
Is the display range restricted by Blanking ?	Appropriately set Blanking in the configuration menu. ☛ Signal - Blanking p.143
Is the image position adjusted correctly?	(Only when projecting analog RGB signals input from the Computer port) Press the [Auto] button to adjust the display position. You can also adjust the position from the Configuration menu. ☛ Signal - Position p.143
Is the computer set for dual display? (Only when projecting computer images)	If dual display is activated in the Display Properties of the computer's Control Panel, only about half of the image on the computer screen is projected. To display the entire image on the computer screen, turn off the dual display setting. ☛ Computer video driver's documentation

Check	Remedy
Is the correct resolution selected? (Only when projecting computer images)	Set the computer so that the signals being output are compatible with the projector. <ul style="list-style-type: none"> ☛ "Supported Monitor Displays" p.264 ☛ Computer's documentation and so on
Is the image direction correct?	Make the correct settings in Projection from the Configuration menu. <ul style="list-style-type: none"> ☛ "Installation Settings" p.34

Image colors are not right

Check	Remedy
Do the input signal settings match the signals from the connected device?	Change the setting according to the signal for the connected equipment. <ul style="list-style-type: none"> ☛ Signal - Advanced - Input Signal p.143
Is the image brightness adjusted correctly?	Adjust the Brightness setting from the Configuration menu. <ul style="list-style-type: none"> ☛ Image - Brightness p.141
Are the cables connected correctly?	Check that all the cables required for projection are securely connected. Check that no cables are disconnected and that there are no poor contacts in the cables. <ul style="list-style-type: none"> ☛ "Connecting Equipment" p.48
Is the Contrast adjusted correctly?	Adjust the Contrast setting from the Configuration menu. <ul style="list-style-type: none"> ☛ Image - Contrast p.141
Is the color adjustment set correctly?	Adjust the Gamma or RGBCMY setting from the Configuration menu. <ul style="list-style-type: none"> ☛ Image - Advanced p.141 ☛ "Adjusting the Image" p.79
Are the color saturation and tint adjusted correctly?	Adjust the Color Saturation and Tint settings from the Configuration menu. <ul style="list-style-type: none"> ☛ Image - Color Saturation, Tint p.141
Is the brightness of the room appropriate?	If the room is darker than when the auto adjustment was performed, the tint of the projected images may not be displayed correctly. Make the room darker and then perform auto adjustment again. <ul style="list-style-type: none"> ☛ "Screen Matching" p.95 ☛ "Color Calibration" p.224

Check	Remedy
Are you projecting from multiple projectors at the same time?	<p>Make sure that Light Source Calibration from the Reset menu is set correctly for all of the projectors. If Light Source Calibration is only executed for some of the projectors, there may be differences between the White Balance or the Brightness Level.</p> <p>If you perform Screen Matching regularly, make sure you execute Screen Matching after performing Light Source Calibration. If there are still differences in the color, set Light Source Calibration to Off.</p>

Images appear dark

Check	Remedy
Is the image brightness set correctly?	<p>Check the Brightness and Brightness Settings values from the Configuration menu.</p> <ul style="list-style-type: none"> ☛ Image - Brightness p.141 ☛ Settings - Brightness Settings p.145
Is the Contrast adjusted correctly?	<p>Adjust the Contrast setting from the Configuration menu.</p> <ul style="list-style-type: none"> ☛ Image - Contrast p.141
Is only one projector being used?	<p>Check if the following item is set to dark.</p> <ul style="list-style-type: none"> ☛ Extended - Multi-Projection - Screen Matching - Brightness Settings p.147
Is the HDR adjusted correctly?	<p>Adjust HDR10 Setting and HLG Setting from the Configuration menu.</p> <ul style="list-style-type: none"> ☛ Signal - Dynamic Range - HDR10 Setting, HLG Setting p.143
Is the video level adjusted correctly?	<p>Check the Video Range from the Configuration menu.</p> <ul style="list-style-type: none"> ☛ Signal - Dynamic Range - Advanced - Video Range p.143

Automatic adjustments are not performed correctly

Check	Remedy
Have at least 20 minutes passed since the power was turned on? (Error Code: 0101)	Auto adjustment does not work correctly until the temperature of the projector is stable. Perform auto adjustment 20 minutes after turning on the projector or canceling Shutter.
Is the cover of the built-in camera or the projection lens clean? (Error Code: 0101)	Make sure that the cover of the built-in camera or the projection lens is clean. Clean them if they are dirty.
Is the built-in camera or the screen obstructed during calibration? (Error Code: 0102)	Auto adjustment is performed using the camera built into the front of the projector. Do not block the camera or the projected images.

Check	Remedy
Are you using a lens that does not support specific operations?	Auto adjustment is not available when using the following lenses. ELPLR05, ELPLL09, and ELPLL10
Is an analog signal being input?	When inputting an analog signal, the color and brightness of the input image changes, and the results of adjustment may not be applied correctly.
Is the screen warped or distorted? (Error Code: 0102)	Use a flat screen with no warping or distortion.
Is the projector installed at an angle to the projection surface? (Error Code: 0102)	Install the projector so that it is parallel to the projection surface.
Has the image been corrected using Geometry Correction? (Error Code: 0102)	If the angle of projection onto the screen is too large, auto correction may not work correctly for images corrected using Geometry Correction. Set Geometry Correction to Off or reduce the correction range. ☛ Settings - Geometry Correction p.145
Is the brightness of the surroundings appropriate? (Error Code: 0101)	If a powerful spotlight or natural light shines into the area during auto adjustment, the brightness of the surroundings changes and auto adjustment does not operate correctly. Make sure the brightness of the surroundings does not change.
Is the projected image being hidden by ambient light? (Error Code: 0102)	If the projected image is hidden by ambient light, automatic correction does not work properly. Adjust the ambient light so that the projected image is visible.
Are the colors in the projected image poor? (Error Code: 0101)	Adjust the tint and the white balance of the projected image. ☛ Image - Tint, White Balance p.141
Is the blending width appropriate? (Error Code: 0102)	If the blending width in Edge Blending exceeds the following range, auto correction may not work properly. Check the blending width. <ul style="list-style-type: none"> • Screen Matching 15 to 45% • Geometry correction assist (tiling and stacking functions): 15 to 43% ☛ Extended - Multi-Projection - Edge Blending p.147
Is the amount of lens shift too large? (Error Code: 0102)	Reduce the amount of lens shift. ☛ "Adjusting the Position of the Projected Image (Lens Shift Adjustment)" p.37
Is the message "An error occurred during auto adjustment." displayed?	The following items explain the error codes displayed in the message. <ul style="list-style-type: none"> • During Screen Matching: 0101 Measurement value error; 0102 Measurement failure; 0103 Switch camera failure • During Color Matching: 0201 Measurement value error; 0202 Measurement failure; 0203 Switch camera failure For more details, contact your local dealer or the nearest address provided in the Epson Projector Contact List. ☛ Epson Projector Contact List
Are you projecting with a projector other than the EB-L30002U/ EB-L30000U? (Error Code: 0104, 0105)	You cannot perform screen matching with projectors other than the EB-L30002U/ EB-L30000U.

Problems when Projection Starts

The projector does not turn on

Check	Remedy
Is the main power switch set to Off?	Turn on the main power switch to supply power to the projector.
Did you press the [⏻] button on the remote control or control panel?	Press the [⏻] button to turn on the power.
Are the indicators switched off?	The power cord is not connected correctly or power is not being supplied. Disconnect and then reconnect the power cord. Check that your electrical outlet or power source is functioning correctly.
Do the indicators turn on and off when the power cord is touched?	There is probably a poor contact in the power cable, or the power cable may be defective. Reinsert the power cable. If this does not solve the problem, stop using the projector, disconnect the power cable from the electrical outlet, and contact your local dealer or the nearest address provided in the Epson Projector Contact List. ☛ Epson Projector Contact List
Is the Control Panel Lock set to Full Lock ?	Press the [⏻] button on the remote control. If you do not want to use Control Panel Lock , change the setting to Off . ☛ "Control Panel Lock" p.117
Is the correct setting for the remote receiver selected?	Check the Remote Receiver from the Configuration menu. ☛ Settings - Remote Receiver p.145
Was the power cord plugged back in or was the breaker turned on immediately after direct shutdown?	If the operation described in the column on the left is performed when Direct Power On is set to On , the power may not turn back on. Press the [⏻] button to turn on the power.
Is the [ID] switch on the remote control set to On?	When the switch is set to On, you can use the remote control to operate only a projector with a matching ID. Set the [ID] switch to Off. ☛ "Setting the remote control ID" p.44

Other Problems

There are afterimages (screen burn-in) in the projected image

Check	Remedy
Have you been projecting a still image or an image that does not move much for a long time?	You can remove afterimages (screen burn-in) from the projected image by using Refresh Mode. Select Start from Refresh Mode in the Reset menu. ☛ Reset - Refresh Mode p.163

The remote control does not work

Check	Remedy
Is the remote control light-emitting area pointing towards the remote receiver on the projector during operation?	Point the remote control towards the remote receiver. ☛ "Remote control operating range" p.27
Is the remote control too far from the projector?	Check the operating range. ☛ "Remote control operating range" p.27
Is direct sunlight or strong light from fluorescent lamps shining onto the remote receiver?	Set the projector up in a location where strong light does not shine onto the remote receiver.
Is the correct setting for the Remote Receiver selected?	Check the Remote Receiver from the Configuration menu. ☛ Settings - Remote Receiver p.145
Are the batteries dead or have the batteries been inserted correctly?	Make sure the batteries are inserted correctly or replace the batteries with new ones if necessary. ☛ "Replacing the remote control batteries" p.26
Are the remote control ID and the projector ID matched?	Make sure the ID for the projector you want to operate and the ID for the remote control match. To operate all projectors by remote control regardless of the ID setting, set the [ID] switch on the remote control to Off. ☛ "ID Settings" p.43
Is the optional remote control cable connected to the projector's Remote port?	When the remote control cable is connected, the projector's remote receiver is disabled. When not using the remote control cable set, disconnect it from the Remote port.
Is Control Communications or Extron XTP set to On ?	The Remote port is disabled. When using the optional remote control cable set, set Control Communications or Extron XTP to Off . ☛ Extended - HDBaseT p.147

Check	Remedy
Is the remote control button lock set?	When the remote control button lock is set, buttons except for those needed for basic remote control operations are deactivated. Hold down the [i] button to cancel the remote control button lock. ☛ "Remote control button lock" p.118

Cannot control correctly using Art-Net

Check	Remedy
While controlling the projector using Art-Net, did you operate the projector using the remote control or control panel?	While controlling the projector using Art-Net and performing operations from the remote control or control panel, settings made by the DMX controller or application software may not be applied to the projector correctly. When you want to apply all the channel controls to the projector, set Channel 13 to "Cannot control", then set it back to "Can control". ☛ "About Art-Net" p.246



Nothing appears on the external monitor

Check	Remedy
Is the external monitor connected to the correct port?	The port to which the external monitor should be connected varies depending on the port to which the image you want to display is being input. <ul style="list-style-type: none"> • When inputting an image signal to the Computer port or the BNC port, connect to the Monitor Out port. • When inputting an image signal to the 3G/HD/SD SDI port, connect to the Monitor Out SDI port.
Are you projecting a split screen?	Only RGB signals projected on the left screen from the Computer port or the BNC port can be displayed on an external monitor. ☛ "Projecting Two Images Simultaneously (Split Screen)" p.103
Is the projector in standby status?	Check that A/V Output and Monitor Out from the Configuration menu are set correctly. ☛ Extended - A/V Settings p.147

I want to change the language for messages and menus

Check	Remedy
Change the Language setting.	Adjust the Language setting from the Configuration menu.  Extended - Language p.147

Email is not received even if a problem occurs in the projector

Check	Remedy
Is Standby Mode set to Communication On ?	To use the Mail Notification function when the projector is in standby, set Communication On in Standby Mode from the Configuration menu.  Extended - Standby Mode p.147
Is power being supplied to the projector?	Check that your electrical outlet or power source is functioning correctly.
Is the Mail Notification function set correctly in the Configuration menu?	An error notification email is sent according to the Notifications settings in the Configuration menu. Check if it is set correctly.  "Notifications menu" p.159

"The battery that saves your clock settings is running low." is displayed

Check	Remedy
The internal power supply that saves your clock settings is running low.	Contact your local dealer or the nearest address provided in the Epson Projector Contact List.  Epson Projector Contact List

"The projector did not turn off correctly." is displayed

Check	Remedy
Is direct shutdown enabled or did the voltage drop due to a sudden blackout?	Check detailed logs on the LCD display.  "Understanding the Status Information" p.182







Detailed logs and error message are not displayed

Check	Remedy
Depending on the environment, errors and warnings may not be displayed when turning on the projector after a sudden voltage drop, blackout, or power cut.	Wait for at least 10 seconds after turning off the main power switch or unplugging the power cable. Next, turn the main power switch back on or plug in the power cable. If the projector turns on, check the LCD display.

Check the numbers and then apply the following countermeasures. If you cannot resolve the problem, contact your network administrator, or contact your local dealer or the nearest address provided in the Epson Projector Contact List.

 [Epson Projector Contact List](#)

Event ID	Cause	Remedy
0432 0435	Failed to start the network software.	Restart the projector.
0434 0481 0482 0485	Network communication is unstable.	Check the network communication status, and reconnect after waiting for a while.
0433	Cannot play transferred images.	Restart the network software.
0484	Communication was disconnected from the computer.	
0483 04FE	The network software ended unexpectedly.	Check the status of network communications. Restart the projector.
0479 04FF	A system error occurred in the projector.	Restart the projector.
0891	Cannot find an access point with the same SSID.	Set the computer, the access point, and the projector to the same SSID.
0892	The WPA/WPA2 authentication type does not match.	Check that the wireless LAN security settings are correct.
0893	The TKIP/AES encryption types do not match.	 Network - Wireless LAN p.154
0894	Communication was disconnected because the projector connected to an unauthorized access point.	Contact your network administrator for more information.
0898	Failed to acquire DHCP.	Check that the DHCP server is operating correctly. If you are not using DHCP, turn off the DHCP setting.  Network - Wireless LAN p.154 , Wired LAN p.158
0899	Other communication errors	If restarting the projector or network software does not solve the problem, contact your local dealer or the nearest address provided in the Epson Projector Contact List.  Epson Projector Contact List
089A	The EAP authentication type is not the same.	Check that the wireless LAN security settings are correct. Also, check if the certificate is installed correctly.  Network - Wireless LAN p.154
089B	EAP server authentication failed.	
089C	EAP client authentication failed.	



Event ID	Cause	Remedy
089D	Key exchange failed.	
0920	The internal power supply that saves your clock settings is running low.	Contact your local dealer or the nearest address provided in the Epson Projector Contact List.  Epson Projector Contact List



Maintenance

This chapter provides information on maintenance procedures to ensure the best level of performance from the projector for a long time to come.

You should clean the projector if it becomes dirty or if the quality of projected images starts to deteriorate.

Caution

When cleaning, turn off the main power switch, and then unplug the power cord from the electric outlet. Otherwise, it could cause an electric shock.

Attention

We recommend cleaning the inside of the projector once a year. If the inside of the projector is not cleaned for a long time, dust collects which could cause a fire or electric shock.

Cleaning the Projector

Clean the projector's surface by wiping it gently with a soft cloth.

If the projector is particularly dirty, moisten the cloth with water containing a small amount of neutral detergent, and then firmly wring the cloth dry before using it to wipe the projector's surface.

Attention

Do not use volatile substances such as wax, alcohol, or thinner to clean the projector's surface. The quality of the case may change or become discolored.

Cleaning the Lens

Clean any dirt on the lens by wiping it off gently with a soft cloth.

Warning

Do not use sprays that contain flammable gas to remove dust and lint from the lens. The projector may catch fire due to the high internal temperature.

Use a vacuum cleaner or a hand-held air blower to remove any dust and lint attached to the lens.

Attention

Do not rub the lens with harsh materials or subject the lens to shocks, as it can easily become damaged.

Cleaning the Air Filter and Air Intake Vent

When the following message is displayed and the filter indicator flashes orange, clean the air filter and the air intake vent.

"Time to clean the air filter. Clean or replace the air filter."

"The projector is overheating. Make sure nothing is blocking the air vent, and clean or replace the air filter."

The message "The air filter is clogged. Clean or replace the air filter."

Warning

Do not use sprays that contain flammable gas to remove dust and lint from the filter.

The projector may catch fire due to the high internal temperature. Use a vacuum cleaner or a hand-held air blower to remove any dust and lint attached to the air filter and so on.

Attention

- If dust collects on the air filter, it can cause the internal temperature of the projector to rise, and this can lead to problems with operation and shorten the optical engine's service life. Clean the air filter immediately when the message is displayed.
- Do not rinse the air filter in water. Do not use detergents or solvents.
- When using a brush for cleaning, use one with long soft bristles, and brush it lightly. If it is brushed too strongly, dust will be ground into the air filter and cannot be removed.



When using a projector with an air filter on the ceiling side, the air filter will become clogged frequently.

Cleaning the air filter

This projector has one air filter on the front and two on the sides (see the following illustration). This explanation uses the air filter on the front as an example.

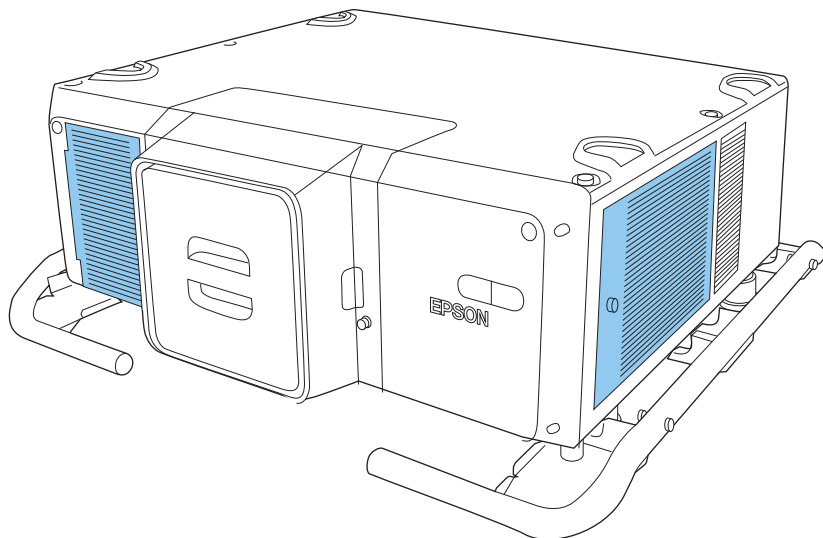

- 1** After you turn off the projector's power and the confirmation buzzer beeps, disconnect the power cord.
- 2** Remove the air filter cover screw.

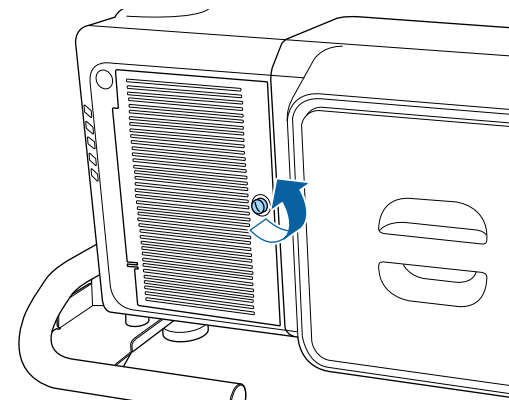

- 3** Open the air filter cover.

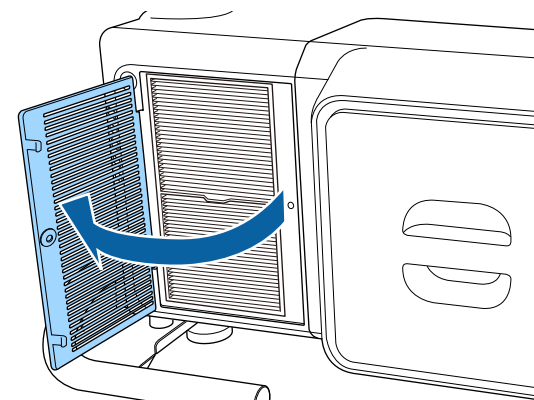



The method for opening the air filter cover differs for the front and the side. The air filter cover at the side is attached to a cord to prevent it from falling.

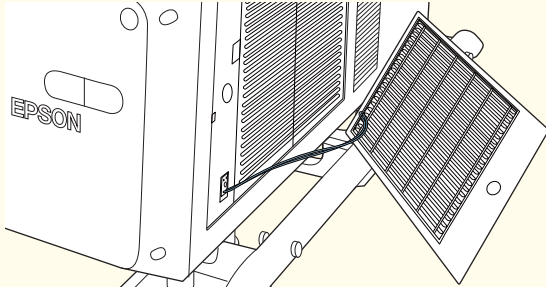

- 4** Remove the air filter.
Grip the tab of the air filter, and pull it straight out.

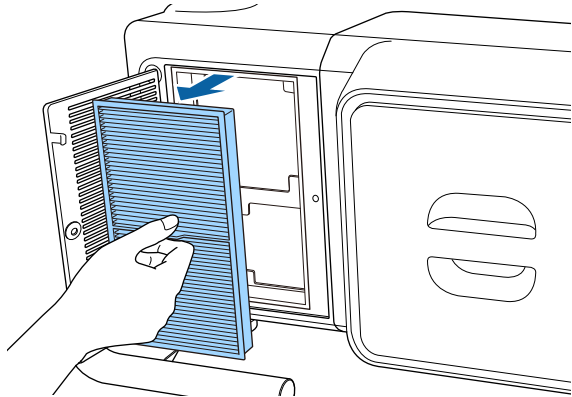

- 5** With the front (the side with tabs) of the air filter facing down, tap the air filter four or five times to shake off the dust.
Turn it over and tap the other side in the same way.

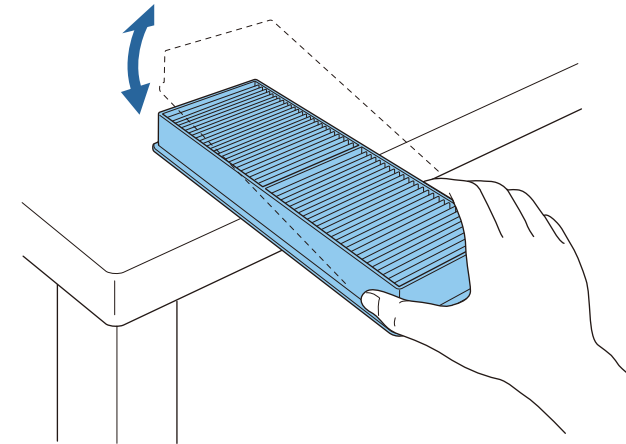

Attention

If the air filter is hit too hard, it may become unusable due to deformities and cracks.

- 6** Remove any dust remaining on the air filter by using a vacuum cleaner from the front side.

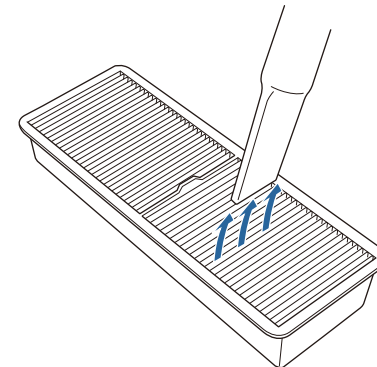

- 7** Replace the air filter.
Press until it clicks into place.

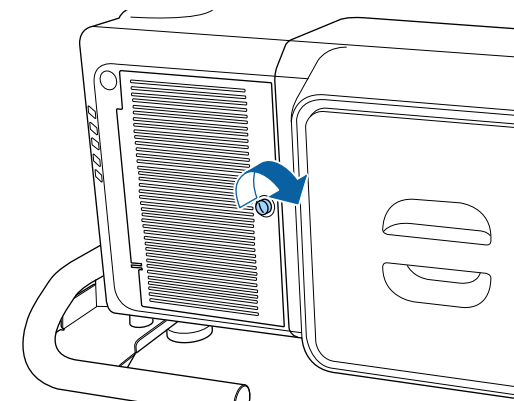
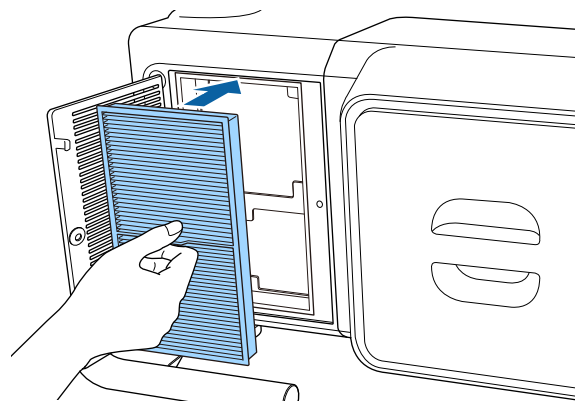

8 Close the air filter cover.

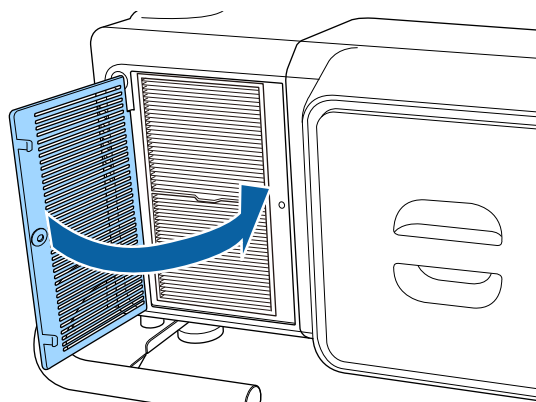

9 Tighten the air filter cover screw.

- If a message is frequently displayed, even after cleaning, it is time to replace the air filter. Replace it with a new air filter.
 - "Replacing the Air Filter" [p.221](#)
- It is recommended that you clean the air filter every 20,000 hours. Clean it more often than this if using the projector in a particularly dusty environment.
- The indicators or messages regarding Air Filter Notice are displayed only when **Air Filter Notice** is set to **On** from the Configuration menu.
 - **Extended - Display - Air Filter Notice** [p.147](#)

Cleaning the air intake vent

Clean off any dust that adheres to the air intake vent on the side of the projector.

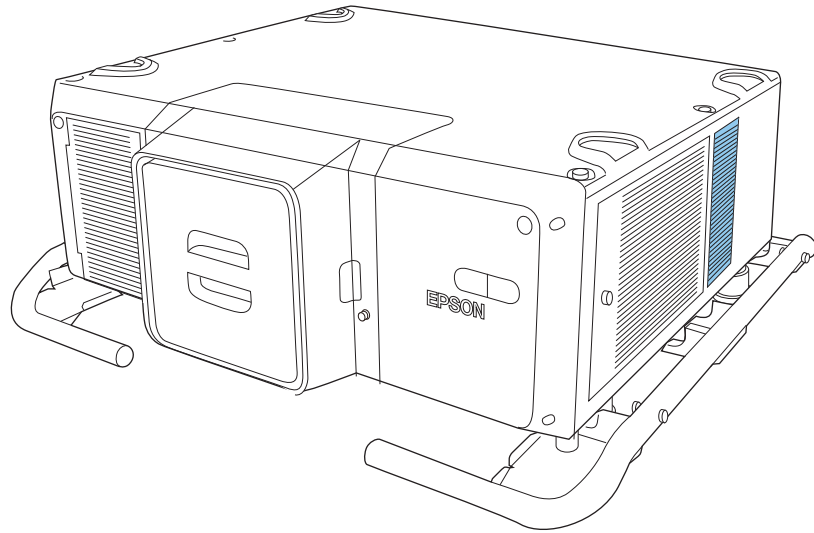

- 1** After you turn off the projector's power and the confirmation buzzer beeps, disconnect the power cord.
- 2** Use a vacuum cleaner or a soft brush to carefully remove the dust.

This section explains how to replace the air filter.

Replacing the Air Filter

Air filter replacement period

If the message is displayed frequently even though the air filter has been cleaned, replace the air filter.

Attention

When using the projector in smoky environments such as at events and so on, make sure you replace the air filter after approximately 240 hours of use. (This is a guideline when using the projector in an environment with an atmospheric concentration of ondina oil of approximately 0.00000013%. The air filter replacement time may be shorter depending on the operating environment.)

Using the projector in a smoky environment may cause the filter's dust collection function to decline and dust may adhere to the inside of the projector or the power supply; this may cause a malfunction to occur.

Replacing the air filter

This projector has one air filter on the front and two on the sides. This explanation uses the air filter on the front as an example.

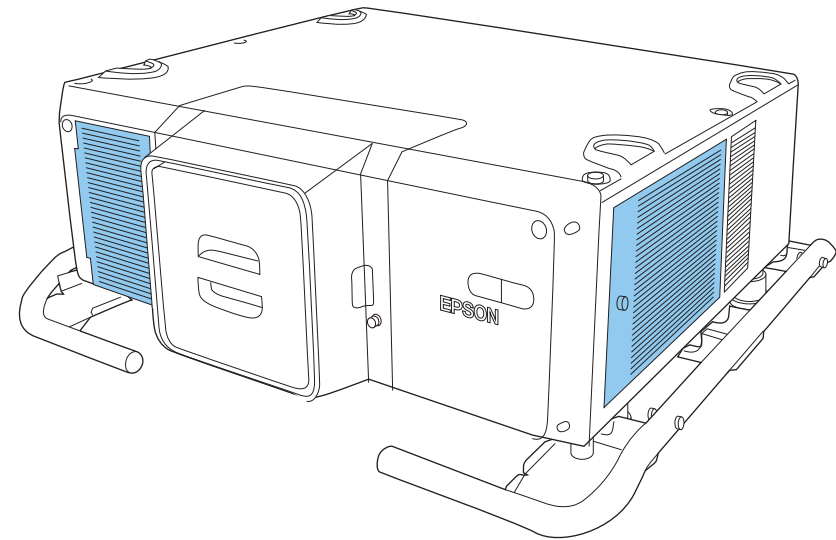

1 After you turn off the projector's power and the confirmation buzzer beeps, disconnect the power cord.

2 Remove the air filter cover screw.

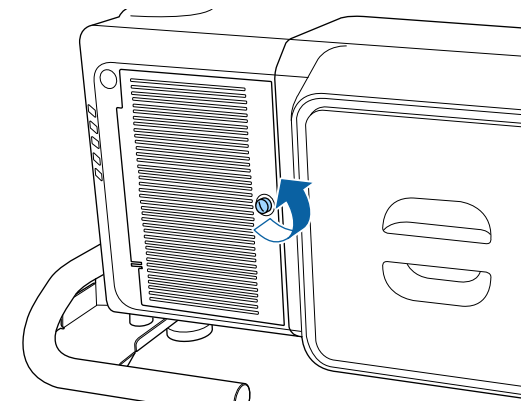

3 Open the air filter cover.

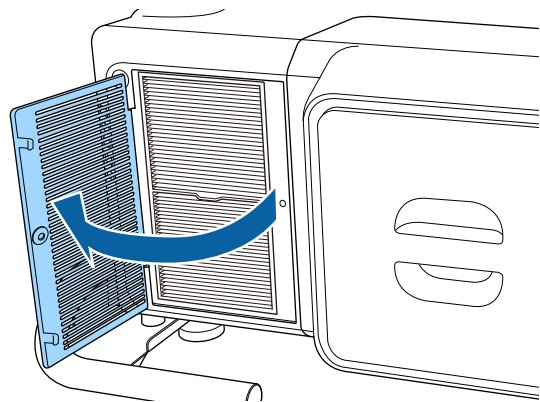

The method for opening the air filter cover differs for the front and the side. The air filter cover at the side is attached to a cord to prevent it from falling.

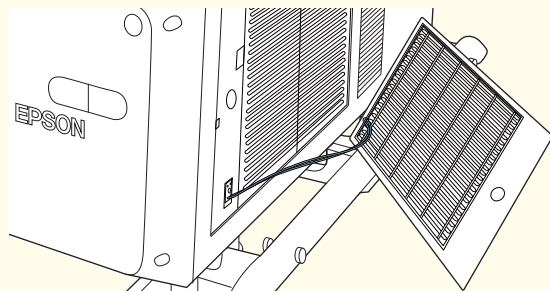

- 4** Remove the air filter.
Grip the tab of the air filter, and pull it straight out.

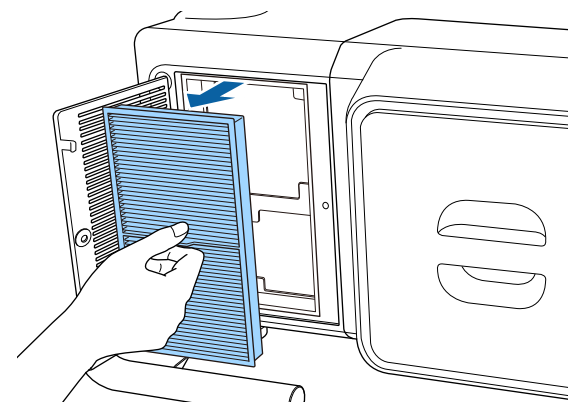

- 5** Install the new air filter.
Press until it clicks into place.

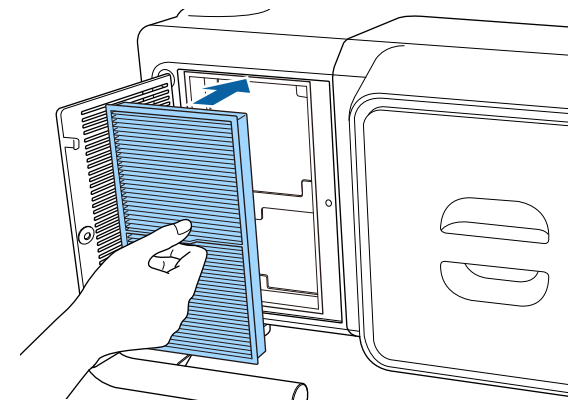

- 6** Close the air filter cover.

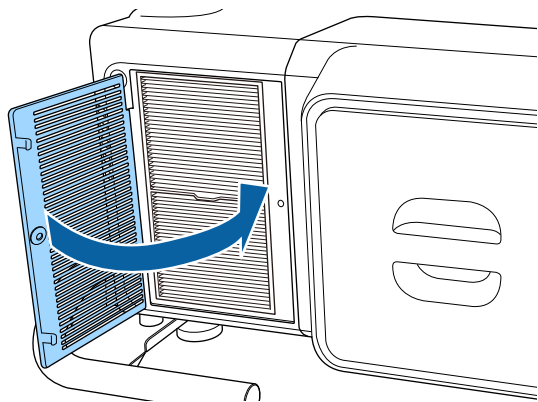

7 Tighten the air filter cover screw.

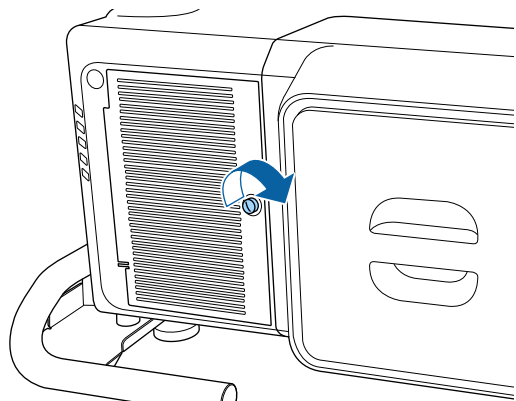

Dispose of used air filters properly in accordance with your local regulations.

Material: Polypropylen

Color Calibration

Automatically adjusts aging deterioration of the color tone for the whole screen based on the default color settings. Correction details are saved for each color mode.

Operating conditions for auto adjustment functions

The auto adjustment function for Color Calibration works under the following conditions:

- The screen is flat without any curves or distortions
- Using a matte white diffusion screen
- The projection size is 100 to 300 inches
- The projector is setup parallel to the projection surface
- **Color Calibration** is set to **On**



- Auto adjustment is not available when using the following lenses. ELPLR05, ELPLL09, and ELPLL10
- We recommend performing Color Calibration at least 20 minutes after turning on the projector or canceling the shutter function.
- To increase the accuracy of adjustments, we recommend darkening the room while projecting images and then making adjustments.
- Auto adjustment is performed using the camera built into the front of the projector. Do not block the camera or the projected images.
- Auto adjustment takes approximately one minute and 30 seconds.
- After making automatic adjustments, Color Uniformity and Color Matching are returned to their defaults.
- By using the scheduling function, you can automatically adjust the color for the whole screen at the time you set.
 - ☛ "Scheduling Function" [p.111](#)
- See the following if Color Calibration does not work correctly.
 - ☛ "Automatic adjustments are not performed correctly" [p.206](#)

1 Press the [Menu] button while projecting.

2 Select **Color Calibration** from **Extended**.

3 Select **Start Auto Adjustment**, and then press the [↵] button.

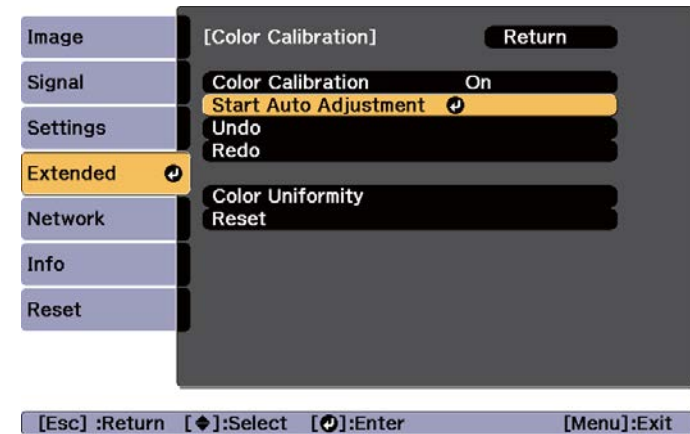

The adjustment pattern is displayed, and adjustment starts. If the projected image is displayed before the adjusting, the procedure is complete.



- See the following if an error occurs.
 - ☛ "Automatic adjustments are not performed correctly" [p.206](#)
- To return to the status before auto adjustment, select **Undo**. When you select **Redo** after selecting **Undo**, it returns the image to the status after auto adjustment.
- To return **Color Calibration** adjustment value to its default value, select **Reset**.

Panel Alignment

Adjusts the pixel color shift for the LCD panel. You can adjust the pixels horizontally and vertically by 0.125 pixel within a range of ± 3 pixel.



- Image quality may decline after performing LCD alignment.
- Images for pixels that extend beyond the edge of the projected screen are not displayed.

- 1 Press the [Menu] button while projecting.
- 2 Select **Display** from **Extended**.
- 3 Select **Panel Alignment**, and then press the [↵] button.

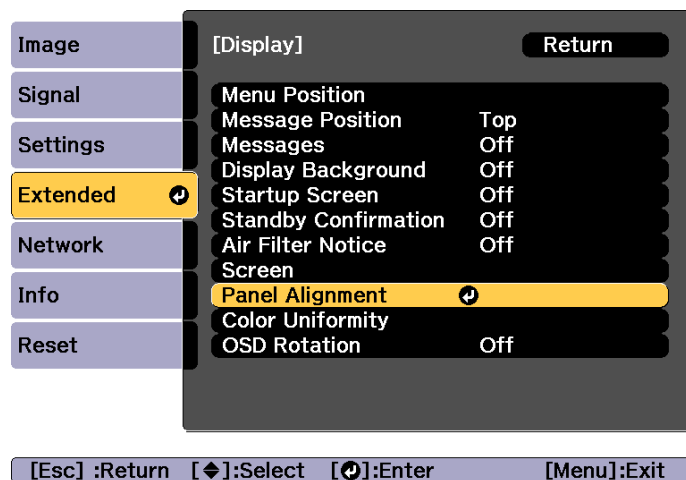

- 4 Enable **Panel Alignment**.

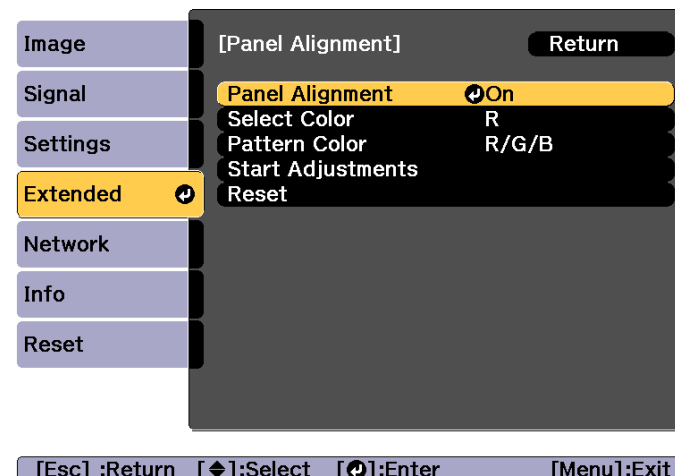

- (1) Select **Panel Alignment**, and then press the [↵] button.
- (2) Select **On**, and then press the [↵] button.
- (3) Press the [Esc] button to return to the previous screen.

- 5 Select the color you want to adjust.

- (1) Select **Select Color**, and then press the [↵] button.
- (2) Select **R** (red) or **B** (blue), and then press the [↵] button.
- (3) Press the [Esc] button to return to the previous screen.

- 6 Select the grid color displayed when making adjustments from **Pattern Color**.

- (1) Select **Pattern Color**, and then press the [↵] button.

- (2) Select a combination of R (red), G (green), and B (blue) for the grid color.

R/G/B: Displays a combination all three colors; red, green and blue. The actual color of the grid is white.

R/G: This is available when **R** is selected from **Select Color**. Displays a combination of two colors; red and green. The actual color of the grid is yellow.

G/B: This is available when **B** is selected from **Select Color**. Displays a combination of two colors; green and blue. The actual color of the grid is cyan.

- (3) Press the [Esc] button to return to the previous screen.

- 7** Select **Start Adjustments**, and then press the [↵] button.

First, select **Shift the whole panel** to adjust the entire LCD panel. When the start confirmation message is displayed, press the [↵] button to start adjustment.



The image may become distorted while adjusting. The image is restored once adjustments are complete.

- 8** Use the [▲], [▼], [◀], and [▶] buttons to make adjustments, and then press the [↵] button.

- 9** To perform more detailed adjustments, select **Adjust the four corners**, and then press the [↵] button to confirm.

- 10** Use the [▲], [▼], [◀], and [▶] buttons to make adjustments, and then press the [↵] button to move to the next adjustment point.

- 11** When you have adjusted all four corners, select **Exit**, and then press the [↵] button.

[Panel Alignment]

Adjustment complete.
To make finer adjustments, you can also select any intersection and then adjust.

Select intersection and adjust

Exit ↵

[◀]:Select [↵]:Enter

[Menu]:Exit

If you feel you still need to make adjustments after correcting all four points, select **Select intersection and adjust** and then continue making adjustments.

Color Uniformity

Adjusts the color tone for the whole screen. Adjustment details are saved for each color mode.



- The color tone may not be uniform even after performing color uniformity.
- We recommend that you reset the following settings on the **Image** menu to display the adjustment screen at the appropriate brightness and color.
 - Brightness
 - Contrast
 - Color Saturation
 - Tint
 - White Balance (Color Temp., G-M Correction, Offset R, Offset G, Offset B, Gain R, Gain G, Gain B)
 - Gamma
 - RGBCMY

- 1 Press the [Menu] button while projecting.
- 2 Select **Display** from **Extended**.
- 3 Select **Color Uniformity**, and then press the [↵] button.
The following screen is displayed.

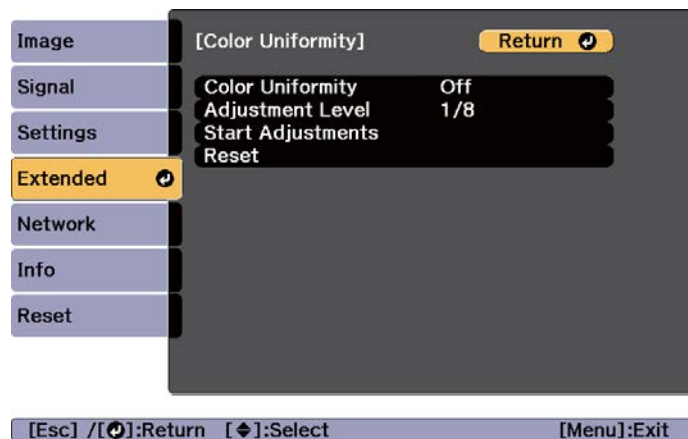

Color Uniformity: Turns color uniformity on or off.

Adjustment Level: There are eight levels from white, through gray, and up to black. You can adjust each level individually.

Start Adjustments: Starts adjusting color uniformity.

Reset: Resets all adjustments and settings for **Color Uniformity** to their default values.



The image may become distorted while adjusting **Color Uniformity**. The image is restored once adjustments are complete.

- 4 Select **Color Uniformity**, and then press the [↵] button.
- 5 Set to **On**, and then press the [Esc] button.

- 6 Select **Adjustment Level**, and then press the [↵] button.
- 7 Use the [◀][▶] buttons to set the adjustment level.
- 8 Press the [Esc] button to return to the previous screen.
- 9 Select **Start Adjustments**, and then press the [↵] button.
- 10 Select the area you want to adjust, and then press the [↵] button.

Adjust the outer areas first, and then adjust the whole screen.

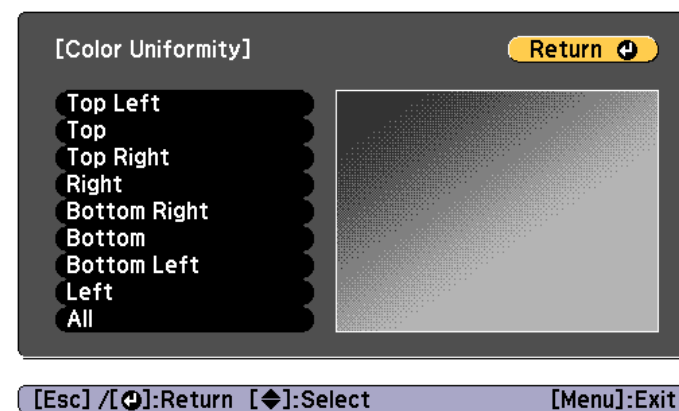

- 11 Use the [▲][▼] buttons to select the color you want to adjust, and then use the [◀][▶] buttons to adjust.
Press the [◀] button to weaken the color tone. Press the [▶] button to strengthen the color tone.

[Color Uniformity]	All
Adjustment Level	1/8
Red	◀ 0 ▶
Green	0
Blue	0

[Default] :Reset [↺]: Switch Background



Whenever the [↺] button is pressed, the screen changes between the projected image and the adjustment screen.

- 12** Return to step 6 and adjust each level.
- 13** To complete the adjustment, press the [Menu] button.



Appendix

Epson Projector Management

Epson Projector Management lets you carry out operations such as checking the status of multiple Epson projectors that are connected to a network at a computer monitor, and controlling the projectors from the computer.

Download the Epson Projector Management software from the following website.

<http://www.epson.com>

Changing Settings Using a Web Browser (Epson Web Control)

By using a Web browser of a computer or mobile device connected to the projector on a network, you can set functions and control the projector. This function allows you to perform setup and control operations remotely.

You can use the following Web browsers.

- Internet Explorer 11.0 or later (except for Metro) (Windows)
- Microsoft Edge (Windows)
- Safari (Mac)
- Chrome (Android)



If you set **Standby Mode** to **Communication On**, you can use the Web browser to make settings and perform control even if the projector is in standby mode (when the power is off).

☛ **Extended - Standby Mode** [p.147](#)

Displaying the Epson Web Control Screen

Use the following procedure to display the Epson Web Control screen.

Make sure your device and projector are ready for the network connection.



If your Web browser is set up to connect via a proxy server, the Epson Web Control screen cannot be displayed. To display Web Control, you need to make settings so that a proxy server is not used for a connection.

- 1** Connect your device to the same network as the connected projector.
The connection method varies depending on the device. See the manual supplied with your device for details. When using a mobile device, check the Wi-Fi settings.
- 2** Start the Web browser on your device.
- 3** Connect by entering the address of the connected projector in the URL field of the Web browser.
The Epson Web Control home screen is displayed.

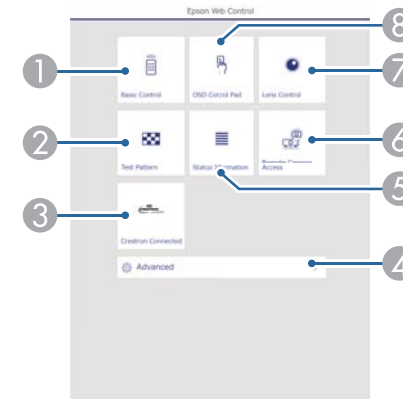

- 1 Basic Control**
☛ "Basic Control Screen" [p.232](#)
- 2 Test Pattern**
☛ "Test Pattern Operation Screen" [p.234](#)

3 Crestron Connected

☛ "About Crestron Connected@" [p.241](#)

4 Advanced

You are moved to the Advanced screen.



When a default **Web Control Password** is set, the Password screen is displayed. Follow the on-screen instructions to change your password.

5 Status Information

☛ "Status Information Screen" [p.235](#)

6 Remote Camera Access

☛ "Remote Camera Access Screen" [p.235](#)

7 Lens Control

☛ "Lens Control Screen" [p.233](#)

8 OSD Control Pad

☛ "OSD Control Pad Screen" [p.232](#)



- When performing the functions from the Epson Web Control screen, you may be prompted to enter the user name and password. When the login screen is displayed, enter your user name and password. (User name is **EPSONWEB**; default password is **admin**.)
- You cannot change the user name. You can change the password in the Network menu from the Configuration menu.
☛ **Network - Basic - Remote Password, Web Control Password** [p.154](#)
- You must enter the user name for Web Control Password even when the password is disabled.
- You can only set the following items from Advanced. Monitor Password (up to 16 single-byte alphanumeric characters)
☛ **Network - Basic - Monitor Password** [p.154](#)
IPv6 Settings (Manual)
☛ **Network - IPv6 Settings** [p.154](#), [p.158](#)
Add HTTP port (for the port number used for Web control, use anything except for 80 (default), 843, 3620, 3621, 3625, 3629, 4352, 4649, 5357, 10000, 10001, 41794)
☛ **Network - Others** [p.160](#)

Basic Control Screen

You can perform basic projector operations.

When the login screen is displayed, enter your user name and password.
(The user name is **EPSONREMOTE**; the default password is **guest**.)

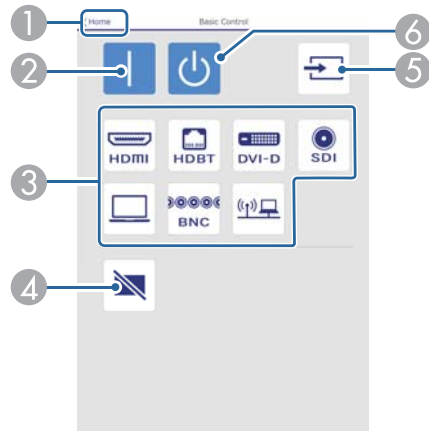

- ① Moves to the Home screen.
- ② Turns the projector on.
- ③ Switches to the target image.
- ④ Press to turn the image on or off temporarily.
- ⑤ Automatically detects the input signal.
- ⑥ Turns the projector off.

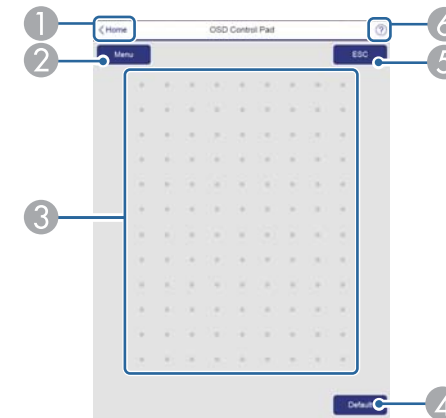

- ① Moves to the Home screen.
- ② Displays and closes the Configuration menu.
- ③ You can operate the Configuration menu using your finger or mouse.
Click to select an item, and tap to confirm the selection.
- ④ Enabled when **Default: Reset** is displayed on the Configuration menu guide. The settings being adjusted are returned to their default values.
- ⑤ Returns to the previous menu level in the Configuration menu.
- ⑥ Displays information on using the OSD Control Pad.

OSD Control Pad Screen

You can operate the Configuration menu of the projector.



Items in the Configuration menu that cannot be set in Epson Web Control are listed below.

- Image menu - Advanced - Gamma - Custom
- Signal menu - Advanced - BNC Sync Termination, EDID, DDC Buffer
- Settings Menu - User Button
- Extended menu - Display - Message Position
- Extended menu - User's Logo
- Extended menu - Operation - Advanced - AC Voltage Monitoring
- Extended menu - Operation - Lens Calibration
- Extended Menu - Language
- Wireless LAN menu - Search Access Point

The settings for items on each menu are the same as the projector's Configuration menu.

☞ "Configuration Menu" [p.136](#)

Lens Control Screen

You can operate the lens of the projector.

Focus/Distortion Operation Screen

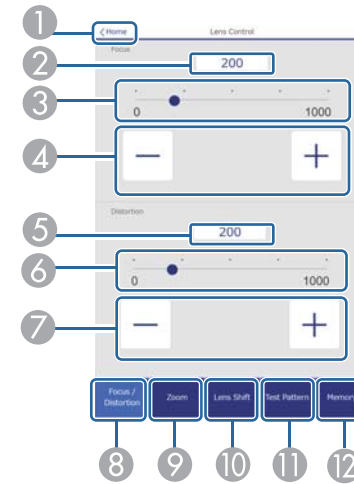

- 1 Moves to the Home screen.
- 2 Displays/enters the focus value.
- 3 Move the slider to adjust the focus.
- 4 Press the buttons to adjust the focus.
- 5 Displays/enters the distortion value.
- 6 Move the slider to adjust image warping.*
- 7 Press the buttons to adjust image warping.*
- 8 Displays the Focus / Distortion operation screen.
- 9 Displays the Zoom operation screen.
- 10 Displays the Lens Shift operation screen.
- 11 Displays the Test Pattern operation screen.
- 12 Displays the Memory operation screen.

* For ELPLR05 and ELPLU05 only.

Zoom Operation Screen

This is not available for the ELPLR05.

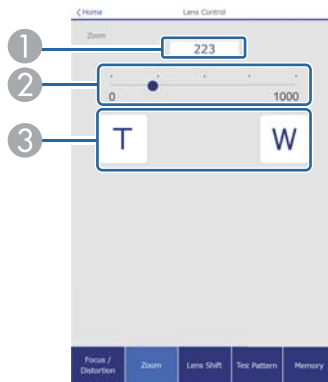

- 1 Displays/enters the zoom value.
- 2 Move the slider to adjust the zoom.
- 3 Press the buttons to adjust the zoom.

Lens Shift Operation Screen

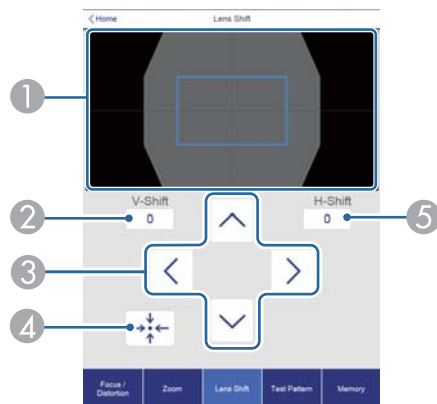

- 1 Displays the position of the image as a blue square. When you move the image position, a red square is displayed at the destination.
- 2 Displays the vertical image position. You can directly specify the position by tapping it and entering a number.
- 3 Moves the image position up, down, left, or right.

- 4 Moves the lens position to the home position if you press the **OK** button in the confirmation screen.
- 5 Displays the horizontal image position. You can directly specify the position by tapping it and entering a number.

Test Pattern Operation Screen

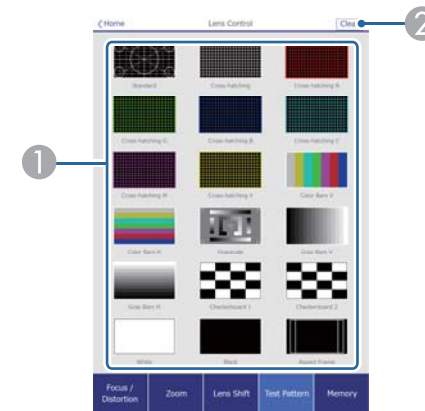

- 1 Displays a test pattern.
- 2 Closes the test pattern.

Memory Operation Screen

See the following for memory function details.

☛ "Memory Function" [p.109](#)

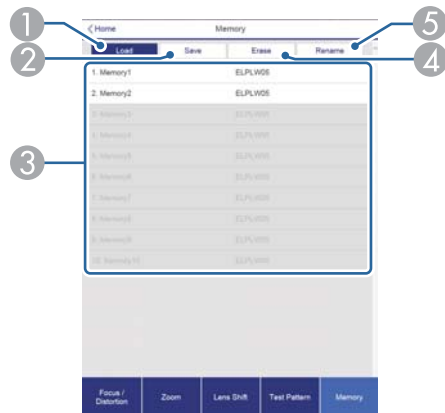

- ① Loads a memory.
- ② Saves a memory.
- ③ Displays a list of memories.
- ④ Erases a memory.
- ⑤ Changes a memory name.



- ① Moves to the Home screen.
- ② Displays the item name.
- ③ Displays the status of each item.
- ④ Selects a category from the following.
Status Information, Source, Signal Information, Network Wired, Network Wireless, Maintenance, Version, Voltage Warning Info

Status Information Screen

You can check the projector's status. See the following for display details.

☛ "Understanding the Status Information" [p.182](#)

Remote Camera Access Screen

You can take a picture of the projected image.

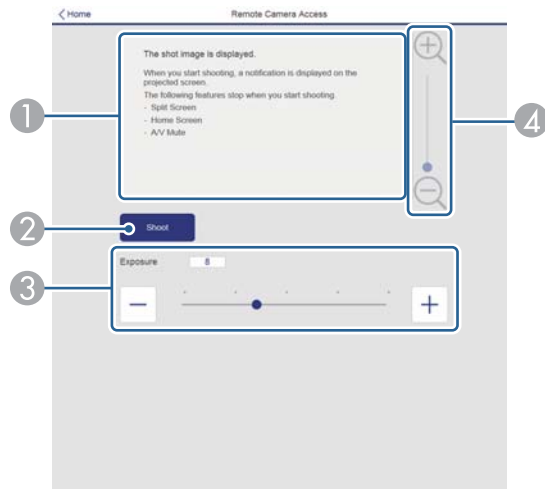

- ① Displays the image you shot.
- ② Press **Shoot** to take a picture of the projected image.
- ③ Adjusts the exposure when shooting.
- ④ Zooms in or zooms out of the image you shot.

Checking the projected image from a remote location

By shooting the projected image from a remote location, you can check it on the device you are using.

- Check that **Secure HTTP** is set to **On** from the **Network - Others** menu.
- This cannot be used when the ELPLR05 is attached.
- The remote camera access function is not available when using the following functions.
 - When using the built-in camera (Tiling, geometry correction assist (tiling and stacking functions), Screen Matching, Color Calibration)
 - Lens Calibration
 - Message Broadcasting function for Epson Projector Management
- The following functions are canceled when using the remote camera access function.
 - Split Screen
 - Shutter
 - On-Screen Display (when the message is hidden)

1 On the Password Protection screen, set **Remote Camera Access** to **Off**.

☞ "Setting Password Protection" p.115

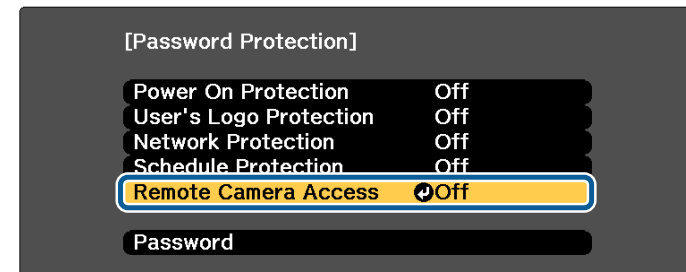

2 Select **Remote Camera Access** from **Network**.

- 3** Select **Password**, and then press the [↵] button.
 You can set up to 32 single-byte alphanumeric characters for the password (* : and spaces cannot be used).

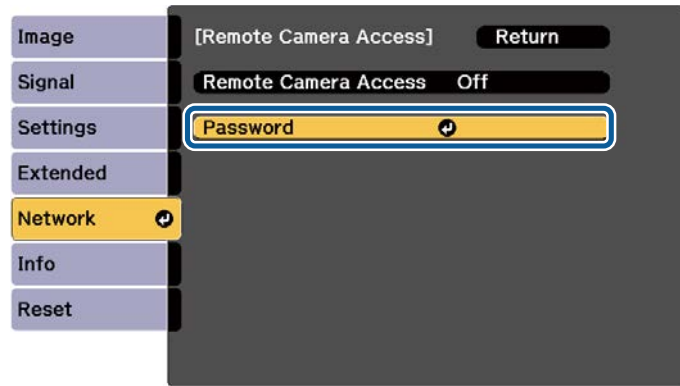

- 4** Set **Remote Camera Access** to **On**.

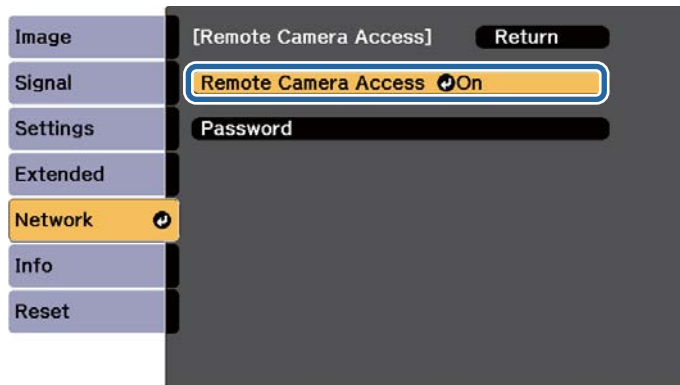

- 5** Launch the Web browser on the computer or mobile device connected to the network.
6 Enter the IP address of the projector in the address input box of the browser to connect to the Epson Web Control screen.

- 7** Select **Remote Camera Access**.
 When the login screen is displayed, enter your user name and password. (User name is **EPSONWEB**; default password is **admin**.)

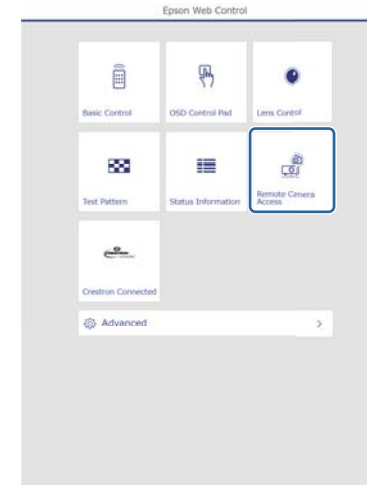

- 8** Press **Shoot**.



- 9** If the password screen is displayed, enter the password you set in step 3 for **Remote Camera Access - Password**, and then press **OK**.

A message is displayed on the projected image, and shooting starts. It takes approximately six seconds to acquire the image.



- Adjust the exposure as necessary. If you make any adjustments, shoot again and check the adjusted image.
- When shooting, you cannot perform any operations except for turning off the projector.
- You cannot shoot warning or caution messages.

Using the Mail Notification Function to Report Problems

When you set Mail Notification, notification messages are sent to the preset email addresses when a problem or warning occurs with a projector. This will enable the operator to be notified of problems with projectors even at locations away from the projectors.

 **Network - Notifications - Mail Notification** [p.159](#)



- Up to a maximum of three notification destinations (addresses) can be registered, and notification messages can be sent to all three destinations at once.
- If a projector develops a critical problem and suddenly stops working, it may not be able to send a message notifying an operator of the problem.
- If you set **Standby Mode** to **Communication On**, you can control the projector even if it is in standby mode (when the power is off).

 **Extended - Standby Mode** [p.147](#)

Reading error notification mail

When the Mail Notification function is set to On and a problem or warning occurs in the projector, the following email will be sent.

Sender: The email address set in **From**

Subject: EPSON Projector

Line 1: The projector name where the problem has occurred

Line 2: The IP address set for the projector where the problem has occurred.

Line 3 and on: Details of the problem

The details of the problem are listed line by line. The main message contents are listed below.

- Clean Air Filter (Air Filter Notice)
- Constant brightness expired (Constant Bright. End)
- Internal error (Internal Error)
- Fan related error (Fan Error)
- Sensor error (Sensor Error)
- Laser error (Laser Error)
- Laser warning (Laser Warning)
- Retardation Plate Error (Retardation Plate Error)
- Internal temperature error (High Temp Error/Overheating)
- High-speed cooling in progress (High Temp Warning)
- Low Air Flow (Low Air Flow)
- Low Air Flow Error (Filter Airflow Error)

- No-signal (No Signal)
No Signal is input to the projector. Check the connection status or check that the power for the signal source is turned on.
- Lens shift error (Lens shift error)
- No lens (No lens)
- Pump Error (Pump Error)
- Shutter Warning (Shutter Warning)
- Shutter Error (Shutter Error)
- Power Err. (Voltage) (Supply Voltage Error)

See the following to deal with problems or warnings.

☛ "Reading the Indicators" [p.175](#)

Management Using SNMP

By setting **SNMP** to **On** in the Configuration menu, notification messages are sent to the specified computer when a problem or warning occurs. This allows you to check for problems with projectors even at locations away from the projectors.

☛ **Network - Notifications - SNMP** [p.159](#)



- SNMP should be managed by a network administrator or someone who is familiar with the network.
- To use the SNMP function to monitor the projector, you need to install the SNMP manager program on your computer.
- The SNMP Agent for this projector complies with version 1 (SNMPv1).
- The managing function using SNMP cannot be used over wireless LAN in Quick connection mode.
- Up to two destination IP addresses can be saved.

ESC/VP21 Commands

You can control the projector from an external device using ESC/VP21.

Command list

When the power ON command is transmitted to the projector, the power turns on and it enters warm-up mode. When the projector's power has turned on, a colon ":" (3Ah) is returned.

When a command is input, the projector executes the command and returns a ":", and then accepts the next command.

If the command being processed terminates abnormally, an error message is output and a ":" is returned.

The main contents are listed below.

Item		Command	
Power ON/OFF	On	PWR ON	
	Off	PWR OFF	
Signal selection	Computer	Auto	SOURCE 1F
		RGB	SOURCE 11
		Component	SOURCE 14
	BNC	Auto	SOURCE BF
		RGB	SOURCE B1
		Component	SOURCE B4
	HDMI		SOURCE 30
	LAN		SOURCE 53
	SDI		SOURCE 60
	DVI-D		SOURCE A0
HDBaseT		SOURCE 80	

Item		Command
Shutter function On/Off	On	MUTE ON
	Off	MUTE OFF

Add a Carriage Return (CR) code (0Dh) to the end of each command and transmit.

For more details, contact your local dealer or the nearest address provided in the Epson Projector Contact List.

 [Epson Projector Contact List](#)

Cable layouts

Serial connection

- Connector shape: D-Sub 9-pin (male)

- Projector input port name: RS-232C

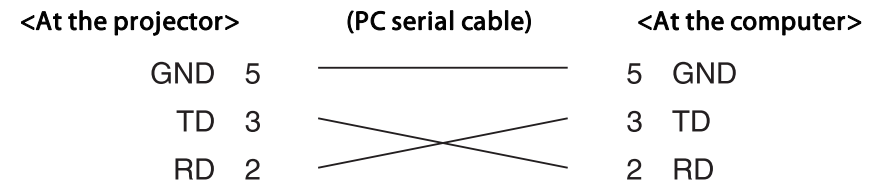
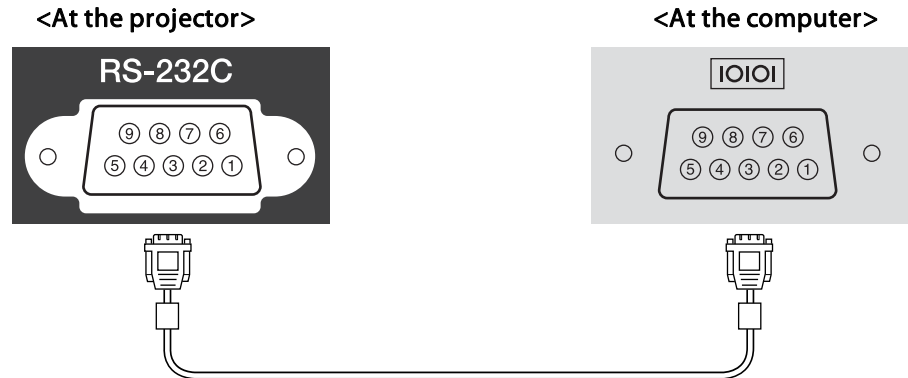

Signal Name	Function
GND	Signal wire ground
TD	Transmit data
RD	Receive data

Communications protocol

- Default baud rate setting: 9600 bps
- Data length: 8 bits
- Parity: None
- Stop-bit: 1 bit
- Flow control: None

About PJLink

PJLink was established by the JBMIA (Japan Business Machine and Information System Industries Association) as a standard protocol for controlling network-compatible projector's as part of their efforts to standardize projector control protocols.

The projector complies with the PJLink Class2 standard established by the JBMIA.

The port number used for the PJLink search function is 4352 (UDP).

You need to make network settings before you can use PJLink. See the following for more information on network settings.

☛ "Network Menu" p.151

It complies with all commands except for the following commands defined by PJLink Class2, and agreement was confirmed by the PJLink standard adaptability verification.

URL: <http://pjlink.jbmia.or.jp/english/>

• Non-compatible commands

	Function	PJLink Command
Mute settings	Image muting set	AVMT 11
	Audio muting set	AVMT 21

• Input ports and corresponding input source number

Input Port Name	Input Source Number
Computer	11
BNC	13
DVI-D	31
HDMI	32

Input Port Name	Input Source Number
SDI	34
LAN	52
HDBaseT	56

- Manufacturer name displayed for "Manufacture name information query"
EPSON
- Model name displayed for "Product name information query"
EPSON L30002U/L30000U

About Crestron Connected®

Crestron Connected® is an integrated control system provided by Crestron®. It can be used to monitor and control multiple devices connected on a network.

The projector supports the control protocol, and can therefore be used in a system built with Crestron Connected®.

Visit the Crestron® Web site for details on Crestron Connected®. (Only English-language displays are supported.)

<https://www.crestron.com/products/line/crestron-connected>

The following provides an overview of Crestron Connected®.

- **Remote operation using a Web browser**
You can operate a projector from your computer just like using a remote control.
- **Monitoring and control with application software**
You can use Crestron RoomView® Express/Crestron Fusion® provided by Crestron® to monitor devices in the system, to communicate with the help desk, and to send emergency messages.

This manual describes how to perform operations on your computer using a Web browser.



- You can only enter single-byte alphanumeric characters and symbols.
- The Message Broadcasting feature for Epson Projector Management is unavailable while using Crestron Connected®.
- If you set **Standby Mode** to **Communication On**, you can control the projector even if it is in standby mode (when the power is off).
☛ **Extended - Standby Mode** [p.147](#)

Operating a projector from your computer

Displaying the operation window

Check the following before carrying out any operations.

- Make sure the computer and projector are connected to the network.
- Set **Crestron Connected** to **On** from the **Network** menu.
☛ **Network - Others - Crestron Connected** [p.160](#)

- 1** Start the Web browser on the computer.
- 2** Enter the IP address of the projector in the address field of the Web browser, and press the Enter key on the keyboard.
The Epson Web Control home screen is displayed.

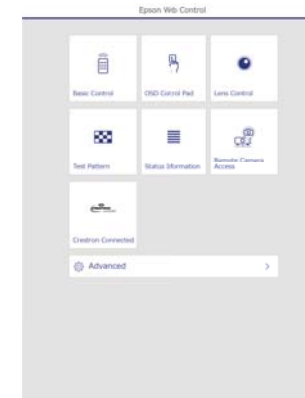

- 3** Press **Crestron Connected**.
The operation window is displayed.

Using the operation window

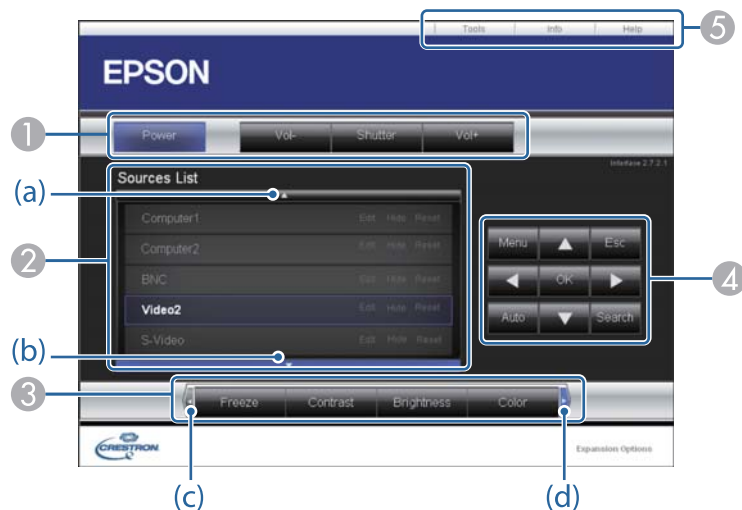

- ① You can perform the following operations when you click the buttons.

Button	Function
Power	Turns the projector power on or off.
Shutter	Press to turn the image on or off temporarily. ☛ "Hiding the Image Temporarily (Shutter)" p.106

- ② Switch to the image from the selected input source. To display input sources that are not shown in Source List, click (a) or (b) to scroll up or down. The current video signal input source is displayed in blue. You can change the source name if necessary.
- ③ You can perform the following operations when you click the buttons. To display buttons that are not shown in Source List, click (c) or (d) to scroll left or right.

Button	Function
Freeze	Images are paused or unpaused. ☛ "Freezing the Image (Freeze)" p.107
Contrast	Adjusts the difference between light and shade in the images.
Brightness	Adjusts the image brightness.
Color	Adjusts the color saturation for the images.
Sharpness	Adjusts the image sharpness.
Zoom	Click the [⊕] button to enlarge the image without changing the projection size. Click the [⊖] button to reduce the image that was enlarged with the [⊕] button.

- ④ The [▲][▼][◀][▶] buttons perform the same operations as the [▲][▼][◀][▶] buttons on the remote control. You can perform the following operations when you click the other buttons.

Button	Function
OK	Performs the same operation as the [↵] button on the remote control. ☛ "Remote Control" p.23
Menu	Displays and closes the Configuration menu.
Auto	If clicked while projecting analog RGB signals from the Computer port, you can automatically optimize Tracking, Sync., and Position.
Search	Changes to the next input source that is sending an image. ☛ "Automatically Detecting Input Signals and Changing the Projected Image (Source Search)" p.60

Button	Function
Esc	Performs the same operation as the [Esc] button on the remote control.  "Remote Control" p.23

5 You can perform the following operations when you click the tabs.

Tab	Function
Help	Displays the Help Desk window. Used to send messages to, and receive messages from, the administrator using Crestron Connected®.
Info	Displays information on the projector that is currently connected.
Tools	Changes settings in the projector that is currently connected. See the next section.

Using the tools window

The following window is displayed when you click the **Tools** tab on the operation window. You can use this window to change settings in the projector that is currently connected.

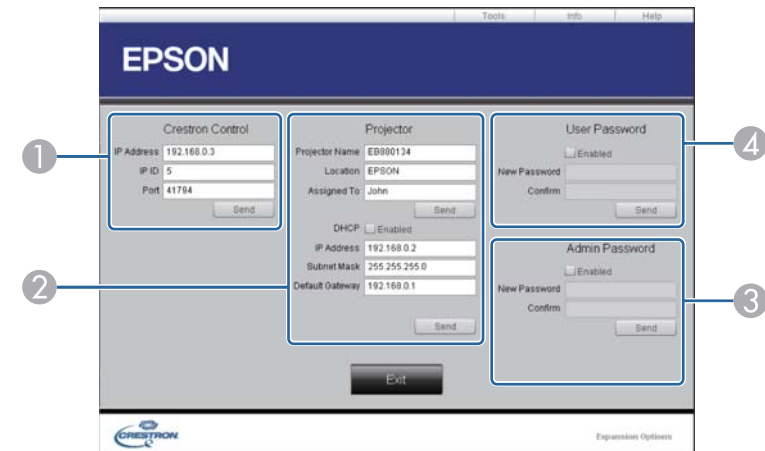

- 1 Crestron Control**
Make settings for Crestron® central controllers.
- 2 Projector**
The following items can be set.

Item	Function
Projector Name	Enter a name to differentiate the projector that is currently connected from other projectors on the network. (The name can contain up to 15 single-byte alphanumeric characters.)
Location	Enter an installation location name for the projector that is currently connected on the network. (The name can contain up to 32 single-byte alphanumeric characters and symbols.)
Assigned To	Enter a user name for the projector. (The name can contain up to 32 single-byte alphanumeric characters and symbols.)



Item	Function
DHCP	Select the Enabled check box to use DHCP. You cannot enter an IP address if DHCP is enabled.
IP Address	Enter the IP address to assign to the currently connected projector.
Subnet Mask	Enter a subnet mask for the currently connected projector.
Default Gateway	Enter the gateway address for the currently connected projector.
Send	Click this button to confirm the changes made to the Projector .

Item	Function
New Password	Enter the new password when changing the password to open the operation window. (The name can contain up to 26 single-byte alphanumeric characters.)
Confirm	Enter the same password as you entered in New Password . If the passwords are not the same, an error is displayed.
Send	Click this button to confirm the changes made to the User Password .

3 Admin Password

Select the **Enabled** check box to require a password to open the Tools window. The following items can be set.

Item	Function
New Password	Enter the new password when changing the password to open the Tools window. (The name can contain up to 26 single-byte alphanumeric characters.)
Confirm	Enter the same password as you entered in New Password . If the passwords are not the same, an error is displayed.
Send	Click this button to confirm the changes made to the Admin Password .

4 User Password

Select the **Enabled** check box to require a password to open the operation window on the computer. The following items can be set.

About Art-Net

Art-Net is an Ethernet communication protocol based on the TCP/IP protocol.

You can control the projector by using a DMX controller or an application system.

Channel definitions

The following explains the channel definitions used when controlling the projector in Art-Net.

First, set Channel 13 to "Can control".

Channel	Function	Operation		Parameters	Default	Operation Content
1	Adjusting light (Dimming)	0% - 100%		0 - 255	0	Sets the image brightness.
2	Shutter control	Shutter	Closed	0 - 63	128	Closes/opens the Shutter.
		Non-operational		64 - 191		
		Shutter	Open	192 - 255		
3	Switch source	Non-operational		0 - 7	0	Changes to the specified source.
		HDMI		8 - 15		
		Non-operational		16 - 23		
		HDBaseT		24 - 31		
		DVI-D		32 - 39		
		Non-operational		40 - 47		
		SDI		48 - 55		
		Computer		56 - 63		
		Non-operational		64 - 71		
		BNC		72 - 79		
		LAN		80 - 87		
		Non-operational		88 - 95		

Channel	Function	Operation		Parameters	Default	Operation Content
		Non-operational		96 - 255		
4	Lens position	Non-operational		0 - 31	0	Moves the lens shift to the home position.
		Move to home position		32 - 63		
		Non-operational		64 - 255		
5	Horizontal lens shift	(+) lens adjustment	Movement - Large	0 - 31	128	Performs horizontal lens shift using the amount of movement specified.
			Movement - Medium	32 - 63		
			Movement - Small	64 - 95		
		Non-operational		96 - 159		
		(-) lens adjustment	Movement - Small	160 - 191		
			Movement - Medium	192 - 223		
			Movement - Large	224 - 255		
6	Vertical lens shift	(+) lens adjustment	Movement - Large	0 - 31	128	Performs vertical lens shift using the amount of movement specified.
			Movement - Medium	32 - 63		
			Movement - Small	64 - 95		
		Non-operational		96 - 159		
		(-) lens adjustment	Movement - Small	160 - 191		
			Movement - Medium	192 - 223		
			Movement - Large	224 - 255		
7	Electronic zoom	(+) lens adjustment	Movement - Large	0 - 31	128	Performs electronic zoom using the amount of movement specified.
			Movement - Medium	32 - 63		
			Movement - Small	64 - 95		

Channel	Function	Operation	Parameters	Default	Operation Content			
		Non-operational	96 - 159					
		(-) lens adjustment	Movement - Small	160 - 191				
			Movement - Medium	192 - 223				
			Movement - Large	224 - 255				
8	Electronic focus	(+) lens adjustment	Movement - Large	0 - 31	128	Performs electronic focus using the amount of movement specified.		
			Movement - Medium	32 - 63				
			Movement - Small	64 - 95				
		Non-operational		96 - 159				
		(-) lens adjustment	Movement - Small	160 - 191				
			Movement - Medium	192 - 223				
			Movement - Large	224 - 255				
9	Electronic distortion	(+) lens adjustment	Movement - Large	0 - 31			128	Performs electronic distortion using the amount of movement specified.
			Movement - Medium	32 - 63				
			Movement - Small	64 - 95				
		Non-operational		96 - 159				
		(-) lens adjustment	Movement - Small	160 - 191				
			Movement - Medium	192 - 223				
			Movement - Large	224 - 255				
10	Load lens memory	Non-operational		0 - 15	0	Loads the specified lens memory.		
		Load lens memory 1		16 - 31				
		Load lens memory 2		32 - 47				

Channel	Function	Operation	Parameters	Default	Operation Content
		Load lens memory 3	48 - 63		
		Load lens memory 4	64 - 79		
		Load lens memory 5	80 - 95		
		Load lens memory 6	96 - 111		
		Load lens memory 7	112 - 127		
		Load lens memory 8	128 - 143		
		Load lens memory 9	144 - 159		
		Load lens memory 10	160 - 175		
		Non-operational	176 - 255		
11	Power control	Power off	0 - 63	128	Turns the projector power on or off.
		Non-operational	64 - 191		
		Power on	192 - 255		
12	Geometry correction	Off	0 - 15	255	Performs geometry correction.
		H/V-Keystone	16 - 31		
		Quick Corner	32 - 47		
		Point Correction	48 - 63		
		Curved Surface	64 - 79		
		Corner Wall	80 - 95		
		Load geometry correction memory 1	96 - 111		Loads a geometry correction memory.
		Load geometry correction memory 2	112 - 127		
		Load geometry correction memory 3	128 - 143		
		Non-operational	144 - 175		
13	Lock	Cannot control	0 - 127	0	Enables/disables Art-Net operations.
		Can control	128 - 255		
14	Fade-in	0.0s	0 - 15	255	Fade-in time setting when the shutter is released



Channel	Function	Operation	Parameters	Default	Operation Content
		0.5s	16 - 31		
		1.0s	32 - 47		
		1.5s	48 - 63		
		2.0s	64 - 79		
		2.5s	80 - 95		
		3.0s	96 - 111		
		3.5s	112 - 127		
		4.0s	128 - 143		
		5.0s	144 - 159		
		7.0s	160 - 175		
		10.0s	176 - 191		
		Non-operational	192 - 255		
15	Fade-out	0.0s	0 - 15	255	Fade-out time setting when the shutter is executed
		0.5s	16 - 31		
		1.0s	32 - 47		
		1.5s	48 - 63		
		2.0s	64 - 79		
		2.5s	80 - 95		
		3.0s	96 - 111		
		3.5s	112 - 127		
		4.0s	128 - 143		
		5.0s	144 - 159		
		7.0s	160 - 175		
		10.0s	176 - 191		
		Non-operational	192 - 255		



While controlling the projector using Art-Net and performing operations from the remote control or control panel, settings made by the DMX controller or application software may not be applied to the projector correctly. If you want to apply control for multiple channels to the projector, set Channel 13 to "Cannot control" before you make any other settings, and then set Channel 13 to "Can control" after setting multiple channels. You can then control the projector without changing the setting for Channel 13.

The following optional accessories and consumables are available. Please purchase these products as and when needed. The following list of optional accessories and consumables is current as of: May 2020. Details of accessories are subject to change without notice and availability may vary depending on the country of purchase.

Optional Accessories

Lens unit

ELPLR05, ELPLU05, ELPLW07, ELPLM12, ELPLM13, ELPLM14, ELPLL09, ELPLL10

See the following for more information on the projection distance for each lens.

👁️ "Screen Size and Projection Distance" [p.253](#)

Computer cable ELPKC02

(1.8 m - for mini D-Sub15-pin/mini D-Sub 15pin)

Computer cable ELPKC09

(3 m - for mini D-Sub15-pin/mini D-Sub 15pin)

Computer cable ELPKC10

(20 m - for mini D-Sub15-pin/mini D-Sub 15pin)

An extension cable for when the computer cable being used is too short.

Remote control cable set ELPKC28

(10 m 2 piece set)

Use this to guarantee operation from the remote control from a distance.

HDBaseT Transmitter ELPHD01

This transmitter performs long distance transmissions for HDMI signals and control signals for one LAN cable. Based on the HDBaseT standard. (HDCP 2.2 is not supported.)

Wireless LAN unit ELPAP10

Use when connecting the projector to a computer wirelessly and projecting.

Handle ELPMB56

Install this on the projector and use it to tilt or carry the projector.

Document Camera ELPDC13, ELPDC21

Use when projecting images such as books, OHP documents, or slides.

Consumables

Air filters ELPAF52

Use as a replacement for used air filters.

Projection Distance List

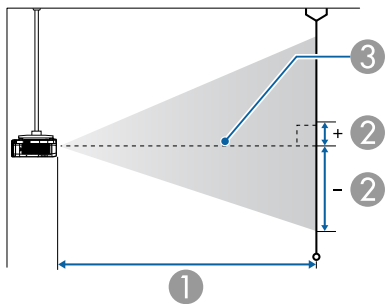
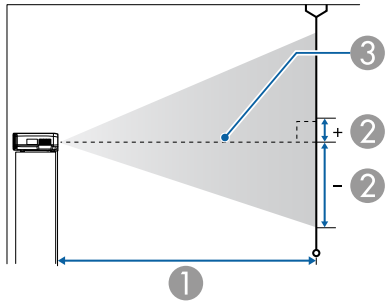

- ① Projection Distance
- ② is the distance from the center of the lens to the base of the screen. This changes depending on the setting for vertical lens shift.
- ③ Center of lens

ELPLR05

Unit: cm

4:3 Screen Size		①	②
		Minimum (Wide) to Maximum (Tele)	Vertical lens shift top to bottom
90"	183x137	128	-92 - -45
100"	203x152	143	-102 - -50

4:3 Screen Size		①	②
		Minimum (Wide) to Maximum (Tele)	Vertical lens shift top to bottom
120"	244x183	174	-123 - -60
150"	305x229	219	-154 - -75
200"	406x305	296	-205 - -100
250"	508x381	373	-256 - -125
883"	1794x1346	1342	-904 - -442

Unit: cm

16:9 Screen Size		①	②
		Minimum (Wide) to Maximum (Tele)	Vertical lens shift top to bottom
100"	221x125	129	-86 - -38
120"	266x149	157	-103 - -46
150"	332x187	198	-129 - -58
200"	443x249	268	-172 - -77
250"	553x311	337	-215 - -96
972"	2152x1210	1341	-836 - -374

- Unit: cm

16:10 Screen Size		①	②
		Minimum (Wide) to Maximum (Tele)	Vertical lens shift top to bottom
100"	215x135	125	-90 - -44
120"	258x162	152	-109 - -53
150"	323x202	193	-136 - -66
200"	431x269	260	-181 - -88
250"	538x337	328	-226 - -110



16:10 Screen Size		①	②
		Minimum (Wide) to Maximum (Tele)	Vertical lens shift top to bottom
1000"	2154x1346	1342	-904 – -442

Unit: cm

16:10 Screen Size		①	②
		Minimum (Wide) to Maximum (Tele)	Vertical lens shift top to bottom
100"	215x135	191 – 232	-142 – +7
120"	258x162	231 – 280	-170 – +8
150"	323x202	290 – 352	-212 – +11
200"	431x269	389 – 472	-283 – +14
250"	538x337	488 – 591	-354 – +18
1000"	2154x1346	1977 – 2387	-1416 – +70

ELPLU05

Unit: cm

4:3 Screen Size		①	②
		Minimum (Wide) to Maximum (Tele)	Vertical lens shift top to bottom
90"	183x137	195 – 237	-144 – +7
100"	203x152	217 – 264	-160 – +8
120"	244x183	262 – 318	-192 – +10
150"	305x229	329 – 399	-214 – +12
200"	406x305	442 – 535	-321 – +16
250"	508x381	554 – 670	-401 – +20
883"	1794x1346	1976 – 2386	-1416 – +70

Unit: cm

16:9 Screen Size		①	②
		Minimum (Wide) to Maximum (Tele)	Vertical lens shift top to bottom
100"	221x125	196 – 239	-139 – +14
120"	266x149	237 – 288	-166 – +17
150"	332x187	298 – 362	-208 – +21
200"	443x249	400 – 485	-277 – +28
250"	553x311	502 – 608	-347 – +35
972"	2152x1210	1975 – 2385	-1348 – +137

ELPLW07

Unit: cm

4:3 Screen Size		①	②
		Minimum (Wide) to Maximum (Tele)	Vertical lens shift top to bottom
90"	183x137	277 – 382	-158 – +21
100"	203x152	309 – 425	-175 – +23
120"	244x183	373 – 513	-211 – +28
150"	305x229	469 – 643	-263 – +35
200"	406x305	629 – 861	-351 – +46
250"	508x381	788 – 1079	-439 – +58
883"	1794x1346	2811 – 3838	-1549 – +203

Unit: cm

16:9 Screen Size		①	②
		Minimum (Wide) to Maximum (Tele)	Vertical lens shift top to bottom
100"	221x125	280 – 385	-152 – +28
120"	266x149	338 – 464	-183 – +33
150"	332x187	425 – 583	-229 – +42
200"	443x249	570 – 781	-305 – +56
250"	553x311	715 – 979	-381 – +70
972"	2152x1210	2809 – 3836	-1481 – +270

4:3 Screen Size		①	②
150"	305x229	634 – 857	-263 – +35
200"	406x305	849 – 1146	-351 – +46
250"	508x381	1065 – 1436	-439 – +58
883"	1794x1346	3793 – 5102	-1549 – +203

Unit: cm

16:10 Screen Size		①	②
		Minimum (Wide) to Maximum (Tele)	Vertical lens shift top to bottom
100"	215x135	272 – 375	-155 – +20
120"	258x162	328 – 452	-186 – +24
150"	323x202	413 – 567	-232 – +30
200"	431x269	554 – 760	-310 – +41
250"	538x337	695 – 952	-387 – +51
1000"	2154x1346	2812 – 3840	-1550 – +203

16:9 Screen Size		①	②
100"	221x125	379 – 514	-152 – +28
120"	266x149	457 – 619	-183 – +33
150"	332x187	574 – 777	-229 – +42
200"	443x249	770 – 1040	-305 – +56
250"	553x311	965 – 1302	-381 – +70
972"	2152x1210	3791 – 5099	-1481 – +270

Unit: cm

ELPLM12

Unit: cm

4:3 Screen Size		①	②
90"	183x137	375 – 509	-158 – +21
100"	203x152	418 – 567	-175 – +23
120"	244x183	504 – 683	-211 – +28

16:10 Screen Size		①	②
100"	215x135	386 – 500	-155 – +20
120"	258x162	444 – 602	-186 – +24
150"	323x202	558 – 755	-232 – +30
200"	431x269	749 – 1011	-310 – +41
250"	538x337	939 – 1267	-387 – +51
1000"	2154x1346	3794 – 5103	-1550 – +203



ELPLM13

Unit: cm

4:3 Screen Size		①	②
		Minimum (Wide) to Maximum (Tele)	Vertical lens shift top to bottom
90"	183x137	491 – 752	-158 – +21
100"	203x152	548 – 838	-175 – +23
120"	244x183	661 – 1009	-211 – +28
150"	305x229	830 – 1265	-263 – +35
200"	406x305	1113 – 1692	-351 – +46
250"	508x381	1396 – 2118	-439 – +58
883"	1794x1346	4973 – 7523	-1549 – +203

Unit: cm

16:9 Screen Size		①	②
		Minimum (Wide) to Maximum (Tele)	Vertical lens shift top to bottom
100"	221x125	496 – 759	-152 – +28
120"	266x149	598 – 914	-183 – +33
150"	332x187	752 – 1147	-229 – +42
200"	443x249	1009 – 1534	-305 – +56
250"	553x311	1265 – 1922	-381 – +70
972"	2152x1210	4970 – 7519	-1481 – +270

Unit: cm

16:10 Screen Size		①	②
		Minimum (Wide) to Maximum (Tele)	Vertical lens shift top to bottom
100"	215x135	482 – 738	-155 – +20

16:10 Screen Size		①	②
		Minimum (Wide) to Maximum (Tele)	Vertical lens shift top to bottom
120"	258x162	582 – 889	-186 – +24
150"	323x202	731 – 1115	-232 – +30
200"	431x269	981 – 1492	-310 – +41
250"	538x337	1231 – 1869	-387 – +51
1000"	2154x1346	4975 – 7526	-1550 – +203

ELPLM14

Unit: cm

4:3 Screen Size		①	②
		Minimum (Wide) to Maximum (Tele)	Vertical lens shift top to bottom
90"	183x137	769 – 1144	-158 – +21
100"	203x152	850 – 1267	-175 – +23
120"	244x183	1012 – 1512	-211 – +28
150"	305x229	1254 – 1880	-263 – +35
200"	406x305	1659 – 2493	-351 – +46
250"	508x381	2063 – 3107	-439 – +58
883"	1794x1346	7183 – 10872	-1549 – +203

Unit: cm

16:9 Screen Size		①	②
		Minimum (Wide) to Maximum (Tele)	Vertical lens shift top to bottom
100"	221x125	775 – 1154	-155 – +20
120"	266x149	922 – 1376	-183 – +24



16:9 Screen Size		①	②
		Minimum (Wide) to Maximum (Tele)	Vertical lens shift top to bottom
150"	332x187	1143 – 1710	-229 – +42
200"	443x249	1510 – 2267	-305 – +56
250"	553x311	1877 – 2824	-381 – +70
972"	2152x1210	7179 – 10876	-1481 – +270

Unit: cm

16:10 Screen Size		①	②
		Minimum (Wide) to Maximum (Tele)	Vertical lens shift top to bottom
100"	215x135	756 – 1123	-155 – +20
120"	258x162	898 – 1340	-186 – +24
150"	323x202	1113 – 1665	-232 – +30
200"	431x269	1470 – 2207	-310 – +41
250"	538x337	1827 – 2749	-387 – +51
1000"	2154x1346	7186 – 10876	-1550 – +203

Unit: cm

ELPLL09

4:3 Screen Size		①	②
		Minimum (Wide) to Maximum (Tele)	Vertical lens shift top to bottom
90"	183x137	1073 – 1602	-144 – +7
100"	203x152	1187 – 1776	-160 – +8
120"	244x183	1416 – 2122	-192 – +10
150"	305x229	1759 – 2642	-241 – +12

4:3 Screen Size		①	②
		Minimum (Wide) to Maximum (Tele)	Vertical lens shift top to bottom
200"	406x305	2330 – 3508	-321 – +16
250"	508x381	2902 – 4373	-401 – +20
883"	1794x1346	10139 – 15337	-1416 – +70

Unit: cm

16:9 Screen Size		①	②
		Minimum (Wide) to Maximum (Tele)	Vertical lens shift top to bottom
100"	221x125	1082 – 1616	-139 – +14
120"	266x149	1289 – 1931	-166 – +17
150"	332x187	1601 – 2402	-208 – +21
200"	443x249	2120 – 3188	-277 – +28
250"	553x311	2639 – 3975	-347 – +35
972"	2152x1210	10133 – 15327	-1348 – +137

Unit: cm

16:10 Screen Size		①	②
		Minimum (Wide) to Maximum (Tele)	Vertical lens shift top to bottom
100"	215x135	1054 – 1574	-142 – +7
120"	258x162	1256 – 1879	-170 – +8
150"	323x202	1559 – 2338	-212 – +11
200"	431x269	2064 – 3103	-283 – +14
250"	538x337	2569 – 3868	-354 – +18
1000"	2154x1346	10142 – 15342	-1416 – +70



ELPLL10

Unit: cm

4:3 Screen Size		①	②
		Minimum (Wide) to Maximum (Tele)	Vertical lens shift top to bottom
90"	183x137	1561 – 2326	-144 – +7
100"	203x152	1727 – 2577	-160 – +8
120"	244x183	2058 – 3079	-192 – +10
150"	305x229	2555 – 3831	-241 – +12
200"	406x305	3383 – 5085	-321 – +16
250"	508x381	4211 – 6339	-401 – +20
883"	1794x1346	14695 – 22217	-1416 – +70

16:10 Screen Size		①	②
		Minimum (Wide) to Maximum (Tele)	Vertical lens shift top to bottom
120"	258x162	1826 – 2727	-170 – +8
150"	323x202	2265 – 3392	-212 – +11
200"	431x269	2997 – 4500	-283 – +14
250"	538x337	3728 – 5608	-354 – +18
1000"	2154x1346	14701 – 22225	-1416 – +70

Unit: cm

16:9 Screen Size		①	②
		Minimum (Wide) to Maximum (Tele)	Vertical lens shift top to bottom
100"	221x125	1574 – 2346	-139 – +14
120"	266x149	1875 – 2801	-166 – +17
150"	332x187	2326 – 3485	-208 – +21
200"	443x249	3078 – 4623	-277 – +28
250"	553x311	3830 – 5762	-347 – +35
972"	2152x1210	14687 – 22204	-1348 – +137

Unit: cm

16:10 Screen Size		①	②
		Minimum (Wide) to Maximum (Tele)	Vertical lens shift top to bottom
100"	215x135	1533 – 2284	-142 – +7

H/V-Keystone

"H/V-Keystone" p.63

Lens type	Vertical	Horizontal
ELPLR05	-35° - 35°	-30° - 30°
ELPLU05	-39° - 39°	-30° - 30°
ELPLW07	-42° - 42°	-30° - 30°
ELPLM12	-45° - 45°	-30° - 30°
ELPLM13	-45° - 45°	-30° - 30°
ELPLM14	-45° - 45°	-30° - 30°
ELPLL09	-45° - 45°	-30° - 30°
ELPLL10	-45° - 45°	-30° - 30°

Curved Surface

"Curved Surface" p.65

The values in the table are the minimum values for R/L in the illustration.
(Approximate value when projecting at maximum zoom.)

Horizontally curved surface (concave)

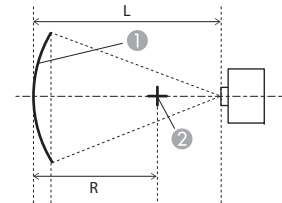

- ① Screen
- ② Center of the circle of which the curved surface is an arc
- L Projection distance
- R Radius of the circle of which the curved surface is an arc

Top view

Lens type	Vertical lens shift: Home position	Vertical lens shift: Top
	 Side view	
ELPLR05	0.47	0.47
ELPLU05	0.38	0.39
ELPLW07	0.31	0.32
ELPLM12	0.25	0.26
ELPLM13	0.20	0.21
ELPLM14	0.15	0.15
ELPLL09	0.11	0.11
ELPLL10	0.08	0.08

Horizontally curved surface (convex)

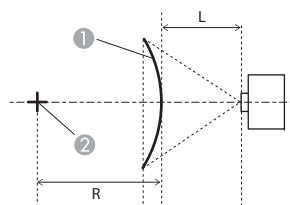

- ① Screen
- ② Center of the circle of which the curved surface is an arc
- L Projection distance
- R Radius of the circle of which the curved surface is an arc

Top view

Vertically curved surface (concave)

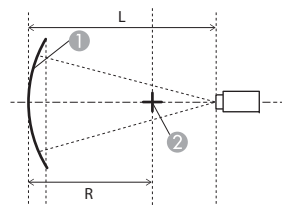

- ① Screen
- ② Center of the circle of which the curved surface is an arc
- L Projection distance
- R Radius of the circle of which the curved surface is an arc

Side view

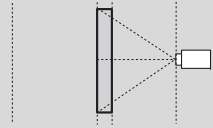
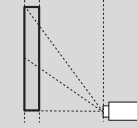
Lens type	Vertical lens shift: Home position	Vertical lens shift: Top
		
	Side view	Side view
ELPLR05	2.63	2.64
ELPLU05	1.24	1.28
ELPLW07	0.71	0.75
ELPLM12	0.45	0.48
ELPLM13	0.32	0.33
ELPLM14	0.19	0.20
ELPLL09	0.14	0.14
ELPLL10	0.10	0.10

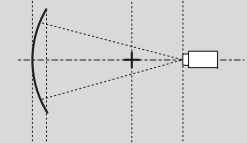
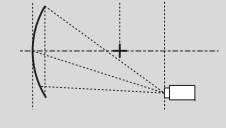
Lens type	Vertical lens shift: Home position	Vertical lens shift: Top
		
	Side view	Side view
ELPLR05	0.38	0.39
ELPLU05	0.30	0.37
ELPLW07	0.23	0.28
ELPLM12	0.18	0.21
ELPLM13	0.14	0.16
ELPLM14	0.11	0.11
ELPLL09	0.08	0.09
ELPLL10	0.07	0.07

Vertically curved surface (convex)

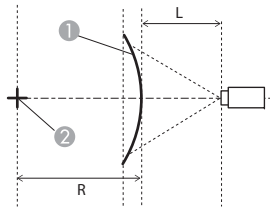

- ① Screen
- ② Center of the circle of which the curved surface is an arc
- L Projection distance
- R Radius of the circle of which the curved surface is an arc

Side view

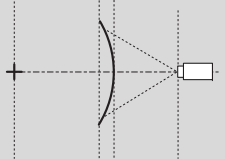
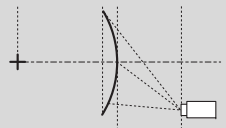
Lens type	Vertical lens shift: Home position	Vertical lens shift: Top
		
	Side view	Side view
ELPLR05	1.24	1.26
ELPLU05	0.63	0.73
ELPLW07	0.37	0.44
ELPLM12	0.24	0.29
ELPLM13	0.17	0.20
ELPLM14	0.12	0.13
ELPLL09	0.09	0.09
ELPLL10	0.06	0.07

Corner Wall

☞ "Corner Wall" p.69

The α in the figure is the maximum angle in which the projector can move. See the table below for detailed values. (Approximate value when projecting at maximum zoom.)

Concave horizontal corner correction (correction to bilateral symmetry by using corners as the center line)

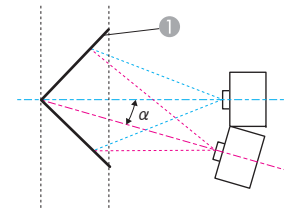

- ① Screen
- α Angle of possible projector motion

Top view

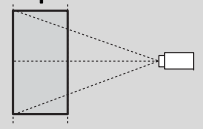
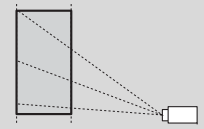
Lens type	Vertical lens shift: Home position	Vertical lens shift: Top
		
	Side view	Side view
ELPLR05	28°	24°
ELPLU05	32°	19°
ELPLW07	32°	22°
ELPLM12	31°	26°
ELPLM13	31°	30°
ELPLM14	30°	29°
ELPLL09	29°	29°
ELPLL10	28°	28°

Convex horizontal corner correction (correction to bilateral symmetry by using corners as the center line)

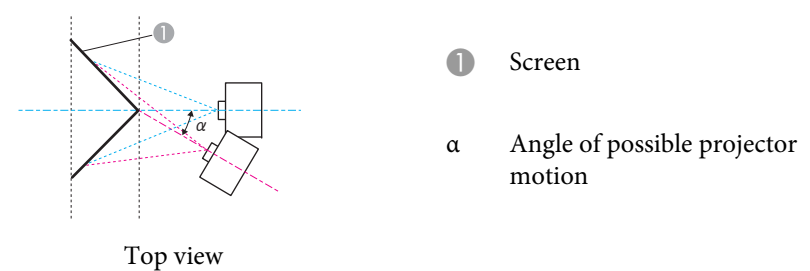

Concave vertical corner correction (correction to horizontal symmetry by using corners as the center line)

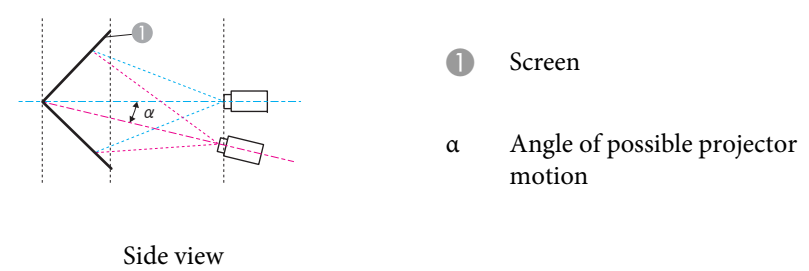

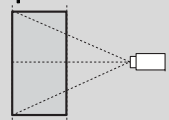
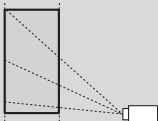
Lens type	Vertical lens shift: Home position  Side view	Vertical lens shift: Top  Side view
ELPLR05	-	-
ELPLU05	7°	6°
ELPLW07	13°	12°
ELPLM12	17°	16°
ELPLM13	19°	19°
ELPLM14	23°	23°
ELPLL09	24°	24°
ELPLL10	26°	26°

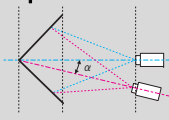
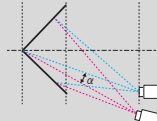
Lens type	Vertical lens shift: Home position  Side view	Vertical lens shift: Top  Side view
ELPLR05	33°	24°
ELPLU05	32°	11°
ELPLW07	31°	13°
ELPLM12	28°	14°
ELPLM13	26°	15°
ELPLM14	24°	18°
ELPLL09	23°	20°
ELPLL10	23°	21°

Convex vertical corner correction (correction to horizontal symmetry by using corners as the center line)

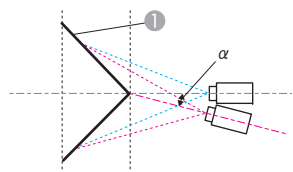

Side view

① Screen

α Angle of possible projector motion

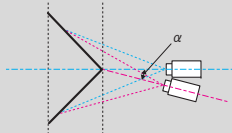
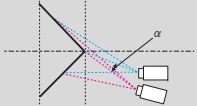
Lens type	Vertical lens shift: Home position  Side view	Vertical lens shift: Top  Side view
ELPLR05	8°	2°
ELPLU05	15°	-
ELPLW07	18°	3°
ELPLM12	21°	9°
ELPLM13	22°	13°
ELPLM14	22°	16°
ELPLL09	22°	19°
ELPLL10	22°	20°



Signal Type	Signal Format	Resolution (Dot)		V Sync (Hz)	Dot Clock (MHz)	Scan Type	Computer/BNC		HDMI/HDBaseT				DVI-D					
							YCb Cr	RGB HV	YCbCr			RGB	YCbCr			RGB		
									4:2:0	4:2:2	4:4:4		4:2:0	4:2:2	4:4:4			
				85	157.000	Progressive		✓										
	WXGA++	1600	900	60	108.000	Progressive		✓				✓					✓	
	SXGA	1152	864	70	94.500	Progressive		✓										
				75	108.000	Progressive		✓										
				85	121.500	Progressive		✓										
		1280	960	60	108.000	Progressive		✓				✓						✓
				75	126.000	Progressive		✓										
				85	148.500	Progressive		✓										
		1280	1024	60	108.000	Progressive		✓				✓						✓
				75	135.000	Progressive		✓										
				85	157.500	Progressive		✓										
	SXGA+	1400	1050	60	121.750	Progressive		✓				✓						✓
				75	156.000	Progressive		✓										
	WSXGA+	1680	1050	60	146.250	Progressive		✓ *2				✓						✓
	UXGA	1600	1200	60	162.000	Progressive		✓				✓						✓
	1920x1080	1920	1080	50	148.500	Progressive		✓				✓						✓
				60	148.500	Progressive		✓					✓					✓
	WUXGA RB*1	1920	1200	60	154.000	Progressive		✓				✓						✓
QXGA	2048	1536	60	267.250	Progressive						✓							
WQHD	2560	1440	60	241.500	Progressive						✓							
WQXGA RB*1	2560	1600	60	268.500	Progressive						✓							
SD	SDTV (480i)	720	480	59.94	13.500	Interlace	✓			✓✓	✓✓	✓✓					✓	

Signal Type	Signal Format	Resolution (Dot)		V Sync (Hz)	Dot Clock (MHz)	Scan Type	Computer/BNC		HDMI/HDBaseT				DVI-D					
									YCbCr	RGB HV	YCbCr			RGB	YCbCr			RGB
							4:2:0	4:2:2			4:4:4	4:2:0	4:2:2		4:4:4			
	SDTV (576i)	720	576	50	13.500	Interlace	✓			✓✓	✓✓	✓✓				✓		
	SDTV (480p)	720	480	59.94	27.000	Progressive	✓	✓		✓✓	✓✓	✓✓				✓		
	SDTV (576p)	720	576	50	27.000	Progressive	✓	✓		✓✓	✓✓	✓✓				✓		
HD	HDTV (720p)	1280	720	50	74.250	Progressive	✓	✓		✓✓	✓✓	✓✓				✓		
				59.94	74.176	Progressive	✓	✓		✓✓	✓✓	✓✓				✓		
				60	74.250	Progressive	✓	✓		✓✓	✓✓	✓✓				✓		
	HDTV (1080i)	1920	1080	50	74.250	Interlace	✓			✓✓	✓✓	✓✓				✓		
				59.94	74.176	Interlace	✓			✓✓	✓✓	✓✓				✓		
				60	74.250	Interlace	✓			✓✓	✓✓	✓✓				✓		
	HDTV (1080p)	1920	1080	23.98	74.176	Progressive				✓✓ *3	✓✓ *3	✓✓ *3				✓		
				24	74.250	Progressive				✓✓ *3	✓✓ *3	✓✓ *3				✓		
				25	74.250	Progressive												
				29.97	74.176	Progressive						✓✓ *3	✓✓ *3	✓✓ *3			✓	
				30	74.250	Progressive						✓✓ *3	✓✓ *3	✓✓ *3			✓	
				50	148.500	Progressive		✓				✓✓ *3	✓✓ *3	✓✓ *3			✓	
59.94				148.352	Progressive		✓				✓✓ *3	✓✓ *3	✓✓ *3			✓		
60	148.500	Progressive		✓				✓✓ *3	✓✓ *3	✓✓ *3			✓					
4K	3840x2160	3840	2160	23.98	296.703	Progressive				✓✓ *3	✓	✓						
				24	297.000	Progressive					✓✓ *3	✓	✓					
				25	297.000	Progressive						✓✓ *3	✓	✓				
				29.97	296.703	Progressive						✓✓ *3	✓	✓				



Signal Type	Signal Format	Resolution (Dot)		V Sync (Hz)	Dot Clock (MHz)	Scan Type	Computer/BNC		HDMI/HDBaseT				DVI-D						
							YCb Cr	RGB HV	YCbCr			RGB	YCbCr			RGB			
									4:2:0	4:2:2	4:4:4		4:2:0	4:2:2	4:4:4				
	4096x2160 SMPTE			30	297.000	Progressive				✓✓*3	✓	✓							
				50	594.000	Progressive			✓										
				59.94	593.407	Progressive			✓										
				60	594.000	Progressive			✓										
			4096	2160	23.98	296.703	Progressive				✓✓*3	✓	✓						
					24	297.000	Progressive				✓✓*3	✓	✓						
					25	297.000	Progressive												
					29.97	296.703	Progressive												
					30	297.000	Progressive												
					50	594.000	Progressive			✓									
					59.94	593.407	Progressive			✓									
					60	594.000	Progressive			✓									

*1 Based on VESA CVT-RB (Reduced Blanking)

*2 Only when **Wide** is selected in **Resolution** from the Signal menu.

*3 Supports HDR (HDR10 and HLG). (Except for 8-bit)

SDI

Mode	Signal Format	Resolution (Dot)		V Sync (Hz)	Dot Clock (MHz)	Scan Type	SDI		
							YCbCr (10bit)	RGB (10bit)	Level
							4:2:2		
SD-SDI	NTSC	720	480	59.94	13.500	Interlace	✓		-
	PAL	720	576	50	13.500	Interlace	✓		-
HD-SDI	-	1280	720	50	74.250	Progressive	✓		-
				59.94	74.176	Progressive	✓		-
				60	74.250	Progressive	✓		-
		1920	1080	50	74.250	Interlace	✓		-
				59.94	74.176	Interlace	✓		-
				60	74.250	Interlace	✓		-
		1920	1080	23.98	74.176	Progressive	✓*		-
				24	74.250	Progressive	✓*		-
				25	74.250	Progressive	✓*		-
				29.97	74.176	Progressive	✓*		-
				30	74.250	Progressive	✓*		-
3G-SDI	-	1920	1080	50	148.500	Interlace		✓	A
				59.94	148.352	Interlace		✓	A
				60	148.500	Interlace		✓	A
		1920	1080	23.98	148.352	Progressive		✓*	A
				24	148.500	Progressive		✓*	A
				25	148.500	Progressive		✓*	A
				29.97	148.352	Progressive		✓*	A

Mode	Signal Format	Resolution (Dot)		V Sync (Hz)	Dot Clock (MHz)	Scan Type	SDI		
							YCbCr (10bit)	RGB (10bit)	Level
							4:2:2		
				30	148.500	Progressive		✓*	A
		1920	1080	50	148.500	Progressive	✓*		A
				59.94	148.352	Progressive	✓*		A
				60	148.500	Progressive	✓*		A

* Supports HDR (HDR10 and HLG).

Projector General Specifications

Product name		EB-L30002U	EB-L30000U
Dimensions		790 (W) x 299 (H) x 710 (D) mm (not including raised section)	
LCD panel size		1.43" Wide	
Display method		Polysilicon TFT active matrix	
Resolution		2,304,000 WUXGA (1920 (W) x 1200 (H) dots) x 3	
Focus adjustment		Automatic	
Zoom adjustment		Automatic (1-1.35)*1	
Lens Shift		Automatic (Maximum vertical direction of approx. 65%, Maximum horizontal direction of approx. 30%) *2	
Light source		Laser diode	
Light source output power		Maximum 40.6 W x 20 (812 W)	
Wavelength		450-460 nm	
Light source life expectancy*3		Approximately 20,000 hours (Light Source Mode: Normal, Quiet) Approximately 30,000 hours (Light Source Mode: Extended)	
Power		100-120V AC±10% 50/60Hz 9.2A 200-240V AC±10% 50/60Hz 12.0A	
Power consumption	110-120V	Rated power consumption: 895W Standby power consumption (Communication On): 2.40W Standby power consumption (Communication Off): 0.25W	
	200 - 240V	Rated power consumption: 2,325W Standby power consumption (Communication On): 2.50W Standby power consumption (Communication Off): 0.39W	
Operating altitude		Altitude 0 to 3,048 m	
Operating Temperature		0 to +50°C*4 (Altitude of 0 to 2,286 m, no condensation) 0 to 0 to +45°C*4 (Altitude of 2,287 to 3,048 m, humidity of 20 to 80%, and no condensation)	
Storage temperature		-10 to +60°C (No condensation)	

Mass	Approx. 63kg (Excluding the handles)	Approx. 63kg (Excluding the handles)
-------------	--------------------------------------	--------------------------------------

*1 The specifications are when ELPLM12 is attached.

*2 ELPLU05/ELPLL09/ELPLL10 has a maximum vertical direction of approx. 55% and a maximum horizontal direction of approx. 25%; ELPLR05 has a maximum vertical direction of approx. 15% and a maximum horizontal direction of approx. 5%.

*3 Approximate time until light source brightness is reduced by half.

(Assuming the projector is used in an atmosphere in which airborne particulate matter is less than 0.04 to 0.2mg/m³. The estimated time varies depending on the projector usage and operating conditions.)

*4 If the surrounding temperature gets too high, the brightness of the light source dims gradually.

(Approximately 40°C at an altitude of 0 to 2,286 m, and approximately 35°C at an altitude of 2,287 to 3,048 m; however, this may vary depending on the surroundings and so on.)

If the maximum operating temperature is exceeded, the projector may turn off automatically.

Connectors (Projector)	Computer Port	1	Mini D-Sub15-pin (female) blue
	Monitor Out port	1	Mini D-Sub15-pin (female) black
	BNC port	1	5BNC (female)
	3G/HD/SD SDI port	1	1BNC (female)
	Monitor Out SDI port	1	1BNC (female)
	LAN port	1	RJ-45
	HDBaseT port	1	RJ-45 HDCP2.2 supported
	RS-232C port	1	Mini D-Sub 9-pin (male)
	Service port*	1	USB connector (Type B) USB 2.0 supported
	USB-A port*	1	USB connector (Type A) (up to 900 mA) USB 2.0 supported
	Remote port	1	Stereo mini jack (3.5Φ)
	HDMI port	1	HDMI HDCP2.2 supported
	DVI-D port	1	DVI-D 24pin Single link HDCP compatible

* USB ports are not guaranteed to operate all devices that support USB.



This product is also designed for IT power distribution system with phase-to-phase voltage 230V.

Supplier's DECLARATION of CONFORMITY

According to 47CFR, Part 2 and 15

Class A digital devices, peripherals & switching power supplies

We: Epson America, Inc.
Located at: 3131 Katella Avenue,
Los Alamitos, CA
Tel: 562-981-3840

Declare under sole responsibility that the product identified herein, complies with 47CFR Part 2 and 15 of the FCC rules as a Class A digital device. Each product marketed, is identical to the representative unit tested and found to be compliant with the standards. Records maintained continue to reflect the equipment being produced can be expected to be within the variation accepted, due to quantity production and testing on a statistical basis as required by 47CFR 2.906. Operation is subject to the following two conditions: (1) this device may not cause harmful interference, and (2) this device must accept any interference received, including interference that may cause undesired operation.

Trade Name: EPSON
Type of Product: LCD Projector
Model: EAI destination: H944A
Other destination: H944C
Options: Product Name: Remote Controller
Model: 2173317 xx (x=0-9)

FCC Compliance Statement For United States Users

This device complies with part 15 of the FCC Rules. Operation is subject to the following two conditions: (1) This device may not cause harmful interference, and (2) this device must accept any interference received, including interference that may cause undesired operation.

This equipment has been tested and found to comply with the limits for a Class A digital device, pursuant to part 15 of the FCC Rules. These limits are designed to provide reasonable protection against harmful interference when the equipment is operated in commercial environment. This equipment generates, uses, and can radiate radio frequency energy and, if not installed and used in accordance with the instruction manual, may cause harmful interference to radio communications. Operation of this equipment in residential area is likely to cause harmful interference in which case the user will be required to correct the interference at this own expense.

WARNING

The connection of a non-shielded equipment interface cable to this equipment will invalidate the FCC Certification or Declaration of this device and may cause interference levels which exceed the limits established by the FCC for this equipment. It is the responsibility of the user to obtain and use a shielded equipment interface cable with this device. If this equipment has more than one interface connector, do not leave cables connected to unused interfaces. Changes or modifications not expressly approved by the manufacturer could void the user's authority to operate the equipment.

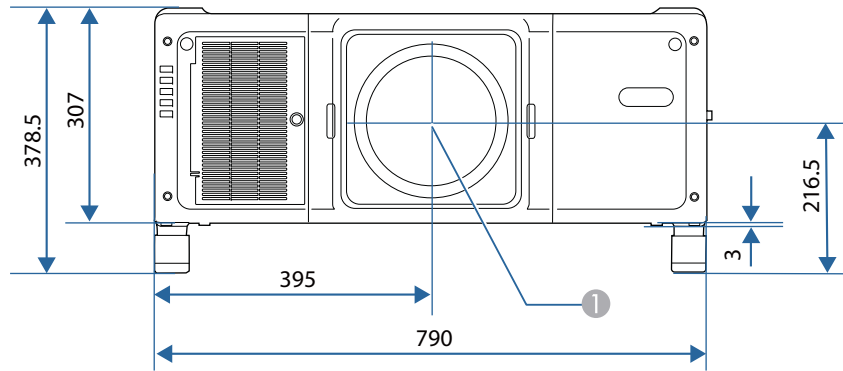

① Center of lens

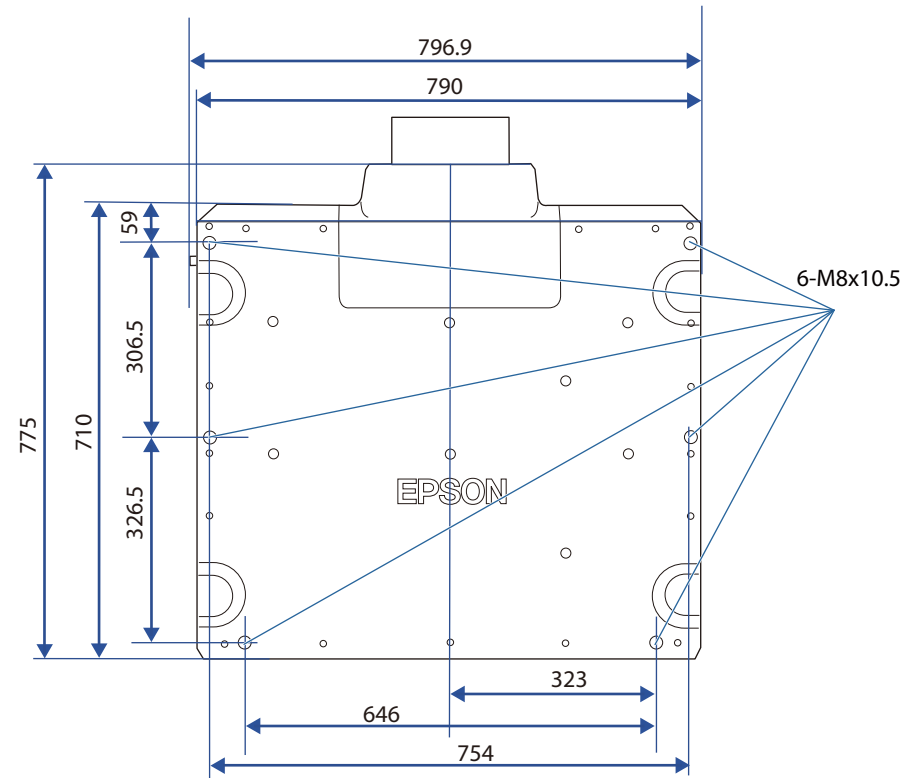

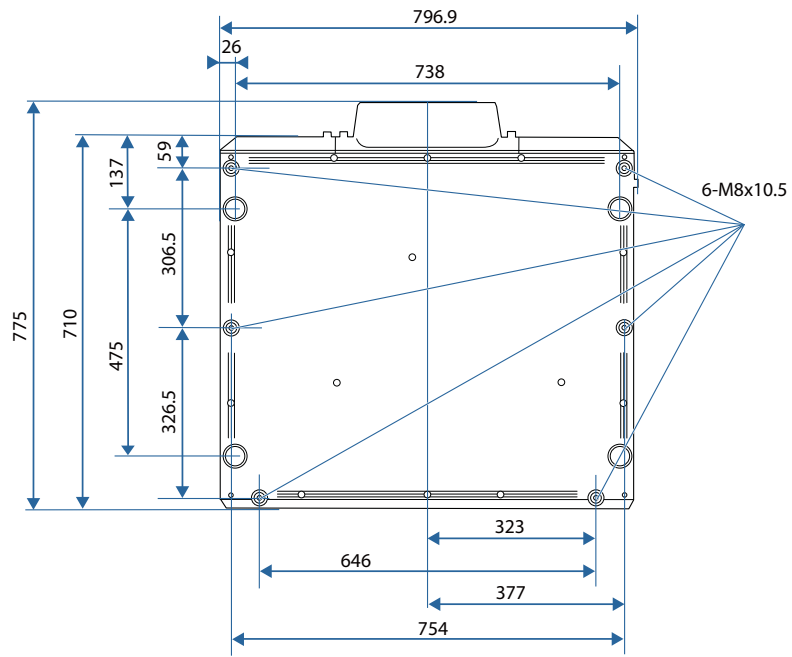

With a handle

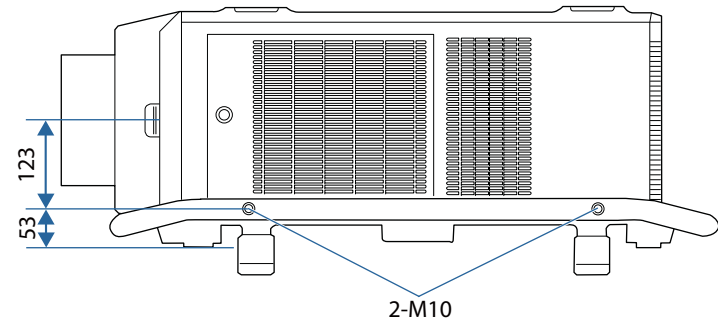
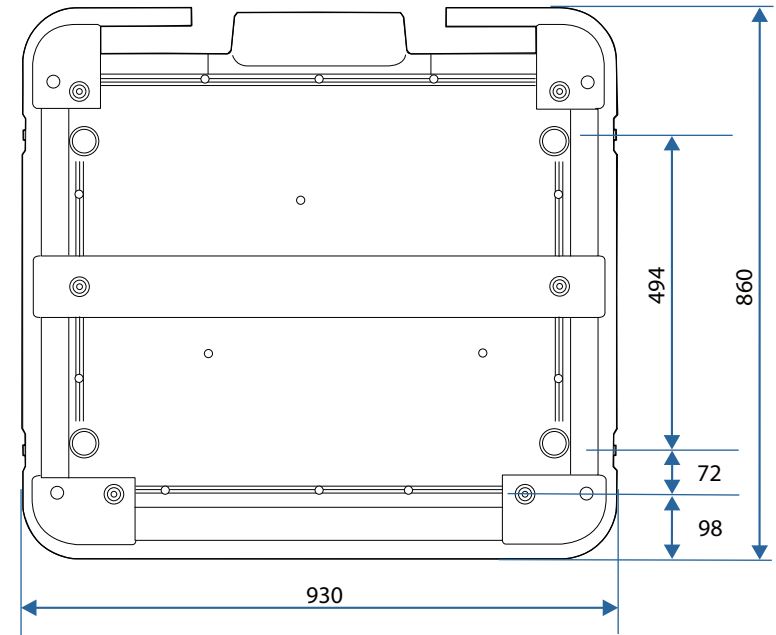

Units: mm

All rights reserved. No part of this publication may be reproduced, stored in a retrieval system, or transmitted in any form or by any means, electronic, mechanical, photocopying, recording, or otherwise, without the prior written permission of Seiko Epson Corporation. No patent liability is assumed with respect to the use of the information contained herein. Neither is any liability assumed for damages resulting from the use of the information contained herein.

Neither Seiko Epson Corporation nor its affiliates shall be liable to the purchaser of this product or third parties for damages, losses, costs, or expenses incurred by the purchaser or third parties as a result of: accident, misuse, or abuse of this product or unauthorized modifications, repairs, or alterations to this product, or (excluding the U.S.) failure to strictly comply with Seiko Epson Corporation's operating and maintenance instructions.

Seiko Epson Corporation shall not be liable against any damages or problems arising from the use of any options or any consumable products other than those designated as Original Epson Products or Epson Approved Products by Seiko Epson Corporation.

The contents of this guide may be changed or updated without further notice.

Illustrations in this guide and the actual projector may differ.

Restriction of Use

When this product is used for applications requiring high reliability/safety such as transportation devices related to aviation, rail, marine, automotive etc.; disaster prevention devices; various safety devices etc; or functional/precision devices etc, you should use this product only after giving consideration to including fail-safes and redundancies into your design to maintain safety and total system reliability. Because this product was not intended for use in applications requiring extremely high reliability/safety such as aerospace equipment, main communication equipment, nuclear power control equipment, or medical equipment related to direct medical care etc, please make your own judgment on this product's suitability after a full evaluation.

About Notations

Microsoft® Windows Vista® operating system
Microsoft® Windows® 7 operating system
Microsoft® Windows® 8 operating system
Microsoft® Windows® 8.1 operating system
Microsoft® Windows® 10 operating system

In this guide, the operating systems above are referred to as "Windows Vista", "Windows 7", "Windows 8", "Windows 8.1", and "Windows 10". Furthermore, these may be referred to as the collective term Windows, and multiple versions of Windows may be referred to as, for example, Windows Vista/7/8/8.1/10, with the Windows notation omitted.

OS X 10.7.x
OS X 10.8.x
OS X 10.9.x
OS X 10.10.x
OS X 10.11.x
macOS 10.12.x

In this guide, the operating systems above are referred to as "OS X 10.7.x", "OS X 10.8.x", "OS X 10.9.x", "OS X 10.10.x", "OS X 10.11.x", and "macOS 10.12.x". Furthermore, the collective term "Mac" is used to refer to them all.

Trademarks and Copyrights

"EPSON" is a registered trademark of Seiko Epson Corporation. "EXCEED YOUR VISION" is a trademark or registered trademark of the Seiko Epson Corporation.

Mac, OS X, and iOS are trademarks of Apple Inc.

Microsoft, Windows, Windows Vista, Microsoft Edge, PowerPoint, and the Windows logo are trademarks or registered trademarks of the Microsoft Corporation in the United States and/or other countries.

App Store is a service mark of Apple Inc.

Android, Chrome, Chromebook, and Google Play are trademarks of Google LLC.

HDMI, the HDMI Logo and High-Definition Multimedia Interface are trademarks or registered trademarks of HDMI Licensing Administrator, Inc. 

PJLink trademark is a trademark applied for registration or is already registered in Japan, the United States of America and other countries and areas.

WPA™ and WPA2™ are registered trademarks of the Wi-Fi Alliance.

"QR Code" is a registered trademark of DENSO WAVE INCORPORATED.

Crestron, Crestron Connected, Crestron RoomView, and Crestron Fusion are registered trademarks of Crestron Electronics, Inc.

Art-Net™ Designed by and Copyright Artistic Licence Holdings Ltd.

Extron and XTP System are trademarks or registered trademarks of RGB Systems, Inc. in the United States and other countries.

HDBaseT™ and the HDBaseT Alliance logo are trademarks of the HDBaseT Alliance.

Other product names used herein are also for identification purposes only and may be trademarks of their respective owners. Epson disclaims any and all rights in those marks.

© 2020 Seiko Epson Corporation

Indication of the manufacturer and the importer in accordance with requirements of EU directive

Manufacturer: SEIKO EPSON CORPORATION

Address: 3-5, Owa 3-chome, Suwa-shi, Nagano-ken 392-8502 Japan

Telephone: 81-266-52-3131

<http://www.epson.com/>









Importer: EPSON EUROPE B.V.









Address: Atlas Arena, Asia Building, Hoogoorddreef 5,1101 BA Amsterdam
Zuidoost The Netherlands











Telephone: 31-20-314-5000

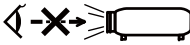

<http://www.epson.com/europe.html>

The following table lists the meaning of the safety symbols labeled on the equipment.

No.	Symbol mark	Approved standards	Meaning
①		IEC60417 No.5007	"ON" (power) To indicate connection to the mains.
②		IEC60417 No.5008	"OFF" (power) To indicate disconnection from the mains.
③		IEC60417 No.5009	Stand-by To identify the switch or switch position by means of which part of the equipment is switched on in order to bring it into the stand-by condition.
④		ISO7000 No.0434B IEC3864-B3.1	Caution To identify general caution when using the product.
⑤		IEC60417 No.5041	Caution, hot surface To indicate that the marked item can be hot and should not be touched without taking care.
⑥		IEC60417 No.6042 ISO3864-B3.6	Caution, risk of electric shock To identify equipment that has risk of electric shock.
⑦		IEC60417 No.5957	For indoor use only To identify electrical equipment designed primarily for indoor use.
⑧		IEC60417 No.5926	Polarity of d.c. power connector To identify the positive and negative connections (the polarity) on a piece of equipment to which a d.c. power supply may be connected.
⑨		---	The same as No. 8

No.	Symbol mark	Approved standards	Meaning
⑩		IEC60417 No.5001B	Battery, general On battery powered equipment. To identify a device for instance a cover for the battery compartment, or the connector terminals.
⑪		IEC60417 No.5002	Positioning of cell To identify the battery holder itself and to identify the positioning of the cell(s) inside the battery holder.
⑫		---	The same as No. 11
⑬		IEC60417 No.5019	Protective earth To identify any terminal which is intended for connection to an external conductor for protection against electric shock in case of a fault, or the terminal of a protective earth electrode.
⑭		IEC60417 No.5017	Earth To identify an earth (ground) terminal in cases where symbol No. 13 is not explicitly required.
⑮		IEC60417 No.5032	Alternating current To indicate on the rating plate that the equipment is suitable for alternating current only; to identify relevant terminals.
⑯		IEC60417 No.5031	Direct current To indicate on the rating plate that the equipment is suitable for direct current only; to identify relevant terminals.
⑰		IEC60417 No.5172	Class II equipment To identify equipment meeting the safety requirements specified for Class II equipment according to IEC 61140.

No.	Symbol mark	Approved standards	Meaning
18		ISO 3864	General prohibition To identify actions or operations that are prohibited.
19		ISO 3864	Contact prohibition To indicate injury that could occur due to touching a specific part of the equipment.
20		---	Never look into the projection lens while the projector is on.
21		---	To indicate that the marked item don't place anything on projector.
22		ISO3864 IEC60825-1	Caution, laser radiation To indicate the equipment has a laser radiation part.
23		ISO 3864	Disassembly prohibition To indicate a risk of injury, such as electric shock, if the equipment is disassembled.
24		IEC60417 No.5266	Standby, partial standby To indicate that part of the equipment is in the ready status.
25		ISO3864 IEC60417 No.5057	Caution, movable parts To indicate that you must keep away from movable parts according to protection standards.
26		IEC 60417-6056	Caution (Moving Fan Blades) As a safety precaution, stay away from the moving fan blades.
27		IEC 60417-6043	Caution (Sharp Corners) To indicate sharp corners that should not be touched.
28		---	To indicate that looking into the lens while projecting is prohibited.

No.	Symbol mark	Approved standards	Meaning
29		ISO7010 No.W027 ISO3864	Warning, light emission (UV, visible light, IR, etc.) When you are close to the light emissions, be careful not to injure your eyes or skin.
30		IEC60417 No.5109	Usage prohibition in residential areas To indicate that this is an electrical device or a device that is not suitable for use in residential areas.

A

A/V settings	149
Air exhaust vent	18
Air filter notice	147
Air filter replacement period	221
AMX Device Discovery	160
Art-Net	161, 246
Aspect	78, 143
Auto	22
Auto setup	143

B

Basic menu	154
Batch setup function	165
Beep	149
Black level	151
BNC port	20
Brightness	141
BT.709	74

C

Ceiling mount	148
Change input	22
Cinema	74
Cleaning	216
Cleaning the air filter and air intake vent	216
Cleaning the projector	216
Color adjustment	142
Color Mode	74, 141
Color saturation	141
Color Uniformity	147, 150
Computer Port	20

Configuration menu	137
Consumables	252
Contrast	141
Control panel	22
Corner wall	69
Crestron Connected	241

D

Date & Time	149
DHCP	156, 158
DICOM SIM	74
Direct Power On	148
Display	147
Display background	147
Document camera	252
Dynamic	74

E

Edge Blending	91, 151
EDID	144
Epson Web Control	230
Esc	23
ESC/VP21	239
Event ID	162
Extended menu	147
Extron XTP	150

F

Filter indicator	175
Focus	22
Freeze	107
Front	148
Full lock	117

G

Gateway Address	156, 158
Geometry	22
Geometry correction	146

H

HDBaseT	150
HDBaseT port	21
HDBaseT signal quality	162
HDMI port	21
Help function	174
High altitude mode	148

I

Image adjustment menu	141
Indicator	175
Info menu	161
Input signal	162
Installation requirements	34
Installation settings	34
IP address	156, 158

K

Keystone distortion	146
---------------------------	-----

L

Language	151
LCD display	23, 182
Lens operation lock	118
Lens replacement cover	30
Lens Shift	22, 37

- M**
- Mail notification 159, 238
 - Memory 147
 - Menu 23, 137
 - Message broadcasting 161
 - Messages 147
 - Monitor Out port 20
 - Multi-Projection 74, 151
 - Multi-Projection function 87
- N**
- Natural 74
 - Network configuration 153
 - Network information 152
 - Network menu 151
 - Notification email address 1/2/3 160
- O**
- Operating temperature 270
 - Operation 148
 - Optional accessories 252
 - Overheating 177
 - Overscan 143
- P**
- Panel alignment 147
 - Part names and functions 17
 - Password protect 115
 - PJLink 241
 - PJLink password 154
 - Port number 159
 - Position 143
 - Power inlet 19
 - Power on protection 115
 - Presentation 74
 - Priority gateway 160
 - Projection 148
 - Projection distance 253
 - Projection lens 30
 - Projector 57, 59
 - Projector ID 43
 - Projector Keyword 154
 - Projector name 154
- Q**
- Quick Corner 146
- R**
- Reading mail 238
 - Rear 148
 - Refresh Rate 162
 - Remote control 23
 - Remote control button lock 118
 - Remote control ID 44
 - Remote port 21
 - Remote receiver 17
 - Replacing batteries 26
 - Replacing the air filter 221
 - Reset all config 164
 - Reset memory 163
 - Reset menu 163
 - Resolution 143, 162
 - Resolutions 264
 - RoomView 242
 - RS-232C port 20

- S**
- Scale 145, 151
 - Schedule 111
 - Schedule settings 151
 - Screen settings 34, 147
 - Screen Size 253
 - Screen size 104
 - Search access point 157
 - Serial number 162
 - Settings menu 145
 - Sharpness 141
 - Shutter 22, 106
 - Signal menu 143
 - SMTP server 159
 - SNMP 239
 - Soft keyboard 153
 - Source 104, 162
 - Source Search 60
 - Specifications 270
 - Split screen 146
 - Split Screen Setup 104
 - Standby mode 149
 - Startup screen 147
 - Status 162
 - Status indicators 18
 - Storage temperature 270
 - Subnet mask 156, 158
 - Supported Monitor Displays 264
 - Swap screens 104
 - Sync info 162
 - Sync. 143

T

Test Pattern 22, 147
Test pattern 36
Tint 141
Tracking 143
Trap IP address 1/2 160

U

User Button 146
User's Logo 107
User's logo protection 115

W

Web browser 230
Web control password 154
White Balance 142
Wired LAN menu 158
Wireless LAN menu 154

Z

Zoom 22