

# SHARP®

## DATA PROJECTOR

### MODEL

# PG-F261X

# PG-F211X

# OPERATION MANUAL

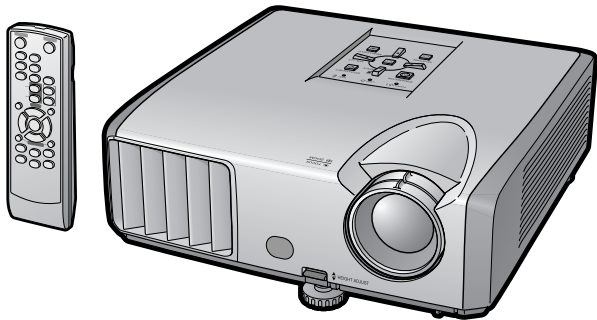

Introduction

Quick Start

Setup

Connections

Basic  
Operation

Useful  
Features

Appendix



## IMPORTANT

- For your assistance in reporting the loss or theft of your Projector, please record the Model and Serial Number located on the bottom of the projector and retain this information.
- Before recycling the packaging, please ensure that you have checked the contents of the carton thoroughly against the list of "Supplied accessories" on page 10.

**Model No.:**

**Serial No.:**

### SPECIAL NOTE FOR USERS IN THE U.K.

The mains lead of this product is fitted with a non-rewireable (moulded) plug incorporating a 10A fuse. Should the fuse need to be replaced, a BSI or ASTA approved BS 1362 fuse marked  or  and of the same rating as above, which is also indicated on the pin face of the plug, must be used.

Always refit the fuse cover after replacing the fuse. Never use the plug without the fuse cover fitted.

In the unlikely event of the socket outlet in your home not being compatible with the plug supplied, cut off the mains plug and fit an appropriate type.

### DANGER:

The fuse from the cut-off plug should be removed and the cut-off plug destroyed immediately and disposed of in a safe manner.

Under no circumstances should the cut-off plug be inserted elsewhere into a 13A socket outlet, as a serious electric shock may occur.

To fit an appropriate plug to the mains lead, follow the instructions below:

### WARNING:

THIS APPARATUS MUST BE EARTHED.

### IMPORTANT:

The wires in this mains lead are coloured in accordance with the following code:

Green-and-yellow : Earth  
Blue : Neutral  
Brown : Live

As the colours of the wires in the mains lead of this apparatus may not correspond with the coloured markings identifying the terminals in your plug proceed as follows:

- The wire which is coloured green-and-yellow must be connected to the terminal in the plug which is marked by the letter E or by the safety earth symbol  or coloured green or green-and-yellow.
- The wire which is coloured blue must be connected to the terminal which is marked with the letter N or coloured black.
- The wire which is coloured brown must be connected to the terminal which is marked with the letter L or coloured red.

IF YOU HAVE ANY DOUBT, CONSULT A QUALIFIED ELECTRICIAN.

The supplied CD-ROM contains operation instructions in English, French, Spanish and Chinese. Carefully read through the operation instructions before operating the projector.

Le CD-ROM fourni contient les instructions de fonctionnement en anglais, français, espagnol et chinois. Veuillez lire attentivement ces instructions avant de faire fonctionner le projecteur.

El CD-ROM suministrado contiene instrucciones de operación en inglés, francés, español y chino. Lea cuidadosamente las instrucciones de operación antes de utilizar el proyector.

附送之CD-ROM光碟中，有用英文、法文、西班牙文和中文所寫的使用說明書。在操作本投影機之前，請務必仔細閱讀整本使用說明書。

Before using the projector, please read this operation manual carefully.

# Introduction

ENGLISH

There are two important reasons for prompt warranty registration of your new SHARP Projector, using the REGISTRATION CARD packed with the projector.

## 1. WARRANTY

This is to assure that you immediately receive the full benefit of the parts, service and labor warranty applicable to your purchase.

## 2. CONSUMER PRODUCT SAFETY ACT

To ensure that you will promptly receive any safety notification of inspection, modification, or recall that SHARP may be required to give under the 1972 Consumer Product Safety Act, PLEASE READ CAREFULLY THE IMPORTANT "LIMITED WARRANTY" CLAUSE.



U.S.A. ONLY

**WARNING:** High brightness light source. Do not stare into the beam of light, or view directly. Be especially careful that children do not stare directly into the beam of light.



**WARNING:** To reduce the risk of fire or electric shock, do not expose this product to rain or moisture.

See bottom of projector.

	<b>CAUTION</b> <b>RISK OF ELECTRIC SHOCK.</b> <b>DO NOT REMOVE SCREWS</b> <b>EXCEPT SPECIFIED USER</b> <b>SERVICE SCREW.</b>	
<b>CAUTION: TO REDUCE THE RISK OF ELECTRIC SHOCK,</b> <b>DO NOT REMOVE COVER.</b> <b>NO USER-SERVICEABLE PARTS EXCEPT LAMP UNIT.</b> <b>REFER SERVICING TO QUALIFIED SERVICE</b> <b>PERSONNEL.</b>		



The lightning flash with arrowhead symbol, within an equilateral triangle, is intended to alert the user to the presence of uninsulated "dangerous voltage" within the product's enclosure that may be of sufficient magnitude to constitute a risk or electric shock to persons.



The exclamation point within a triangle is intended to alert the user to the presence of important operating and maintenance (servicing) instructions in the literature accompanying the product.

**WARNING:** FCC Regulations state that any unauthorized changes or modifications to this equipment not expressly approved by the manufacturer could void the user's authority to operate this equipment.

U.S.A. ONLY

## INFORMATION

This equipment has been tested and found to comply with the limits for a Class A digital device, pursuant to Part 15 of the FCC Rules. These limits are designed to provide reasonable protection against harmful interference when the equipment is operated in a commercial environment. This equipment generates, uses, and can radiate radio frequency energy and, if not installed and used in accordance with the operation manual, may cause harmful interference to radio communications. Operation of this equipment in a residential area is likely to cause harmful interference, in which case the user will be required to correct the interference at his own expense.

U.S.A. ONLY

The enclosed computer cable must be used with the device. The cable is provided to ensure that the device complies with FCC Class A verification.

U.S.A. ONLY

## WARNING:

This is a Class A product. In a domestic environment this product may cause radio interference in which case the user may be required to take adequate measures.

## PRODUCT DISPOSAL

This projector utilizes tin-lead solder, and a pressurized lamp containing a small amount of mercury. Disposal of these materials may be regulated due to environmental considerations. For disposal or recycling information, please contact your local authorities or, if you are located in the United States of America, the Electronic Industries Alliance: [www.eiae.org](http://www.eiae.org).

## Caution Concerning Lamp Replacement

See "Replacing the Lamp" on page 50.

This SHARP projector uses a DLP® chip. This very sophisticated panel contains 786,432 pixels (micromirrors). As with any high technology electronic equipment such as large screen TVs, video systems and video cameras, there are certain acceptable tolerances that the equipment must conform to.

This unit has some inactive pixels within acceptable tolerances which may result in inactive dots on the picture screen. This will not affect the picture quality or the life expectancy of the unit.

Authorized representative responsible for the European Union Community Market

SHARP ELECTRONICS (Europe) GmbH  
Sonninstraße 3, D-20097 Hamburg

E.U. ONLY

# How to Read this Operation Manual

- The specifications are slightly different, depending on the model. However, you can connect and operate all models in the same manner.
- In this operation manual, the illustration and the screen display are simplified for explanation, and may differ slightly from the actual display.

## Using the Menu Screen

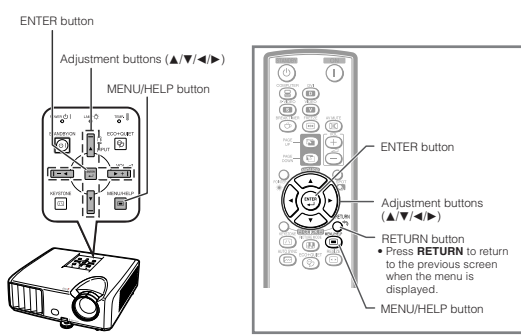

Buttons used in this operation

### Menu Selections (Adjustments)

Example: Adjusting "Bright".  
 • This operation can also be performed by using the buttons on the projector.

- 1 Press **MENU/HELP**.  
 • The "Picture" menu screen for the selected input mode is displayed.
- 2 Press **▶** or **◀** and select "Picture" to adjust.

Example: "Picture" screen menu for COMPUTER (RGB) input

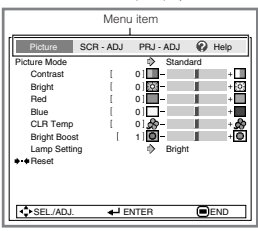

Button used in this step

On-screen display

**Info** .....Indicates safeguards for using the projector.

**Note**.....Indicates additional information for setting up and operating the projector.

## For Future Reference

Maintenance

➔ P. 47

Troubleshooting

➔ PP. 62 and 63

Index

➔ P. 67

# Contents

## Preparing

### Introduction

How to Read this Operation Manual ....	3
Contents .....	4
IMPORTANT SAFEGUARDS .....	6
How to Access the PDF Operation Manuals .....	9
Accessories .....	10
Part Names and Functions .....	11
Inserting the Batteries .....	14
Usable Range .....	15

### Quick Start

Quick Start .....	16
-------------------	----

### Setup

Setting up the Projector .....	18
Setting up the Projector .....	18
Standard Setup (Front Projection) .....	18
Ceiling-mount Setup .....	18
Projection (PRJ) Mode .....	19
Screen Size and Projection Distance ..	20

### Connections

Connecting the Projector to Other Equipment .....	21
Controlling the Projector by a Computer .....	24
Connecting the Power Cord .....	24

## Using

### Basic Operation

Turning the Projector On/Off .....	25
Turning the Projector on .....	25
Turning the Power off (Putting the Projector into Standby Mode) .....	25
Image Projection .....	26
About the Setup Guide .....	26
Adjusting the Projected Image .....	26
Correcting Trapezoidal Distortion .....	28
Switching the Input Mode .....	29
Adjusting the Volume .....	29
Displaying the Black Screen and Turning off the Sound Temporarily ....	29
Resize Mode .....	30

### Useful Features

Operating with the Remote Control ....	32
Displaying and Setting the Break Timer .....	32
Displaying the Pointer .....	32
Using the Spot Function .....	32
Switching the Eco+Quiet Mode .....	32
Auto Sync (Auto Sync Adjustment) ....	33
Freezing a Moving Image .....	33
Selecting the Picture Mode .....	33
Using the Remote Control as the Wireless Computer Mouse .....	34
Menu Items .....	35
Using the Menu Screen .....	37
Menu Selections (Adjustments) .....	37
Picture Adjustment ("Picture" Menu) ..	39
Selecting the Picture Mode .....	39

Adjusting the Image .....	40
Adjusting the Color Temperature .....	40
Progressive .....	40
Lamp Setting .....	40
Adjusting the Projected Image ("SCR - ADJ" Menu) .....	41
Setting the Resize Mode .....	41
Adjusting the Image Position .....	41
Keystone Correction .....	41
Setting the On-screen Display .....	42
Selecting the Background Image .....	42
Selecting the Setup Guide .....	42
Reversing/Inverting Projected Images .....	42
Selecting the On-screen Display Language .....	42
Adjusting the Projector Function ("PRJ - ADJ" Menu) .....	43
Auto Power Off Function .....	43
Auto Restart Function .....	43
STANDBY Mode .....	43
Setting the Confirmation Sound (System Sound) .....	43
Speaker Setting .....	43
Audio Input .....	43
Selecting the Transmission Speed (RS-232C) .....	44
Fan Mode Setting .....	44
Checking the Lamp Life Status .....	44
System Lock Function .....	44
Keylock Function .....	45
Troubleshooting with the "Help" Menu ...	46
Utilizing the "Help" Menu Functions ....	46

## Reference

### Appendix

Maintenance .....	47	Connecting Pin Assignments .....	54
Maintenance Indicators .....	48	RS-232C Specifications and	
Regarding the Lamp .....	50	Command Settings .....	56
Lamp .....	50	Computer Compatibility Chart .....	61
Caution Concerning the Lamp .....	50	Troubleshooting .....	62
Replacing the Lamp .....	50	For SHARP Assistance .....	64
Removing and Installing		Specifications .....	65
the Lamp Unit .....	51	Dimensions .....	66
Resetting the Lamp Timer .....	52	Index .....	67
Storing the Projector .....	53		
How to Use the Storage Case .....	53		

# IMPORTANT SAFEGUARDS

**CAUTION:** Please read all of these instructions before you operate this product and save these instructions for later use.

Electrical energy can perform many useful functions. This product has been engineered and manufactured to assure your personal safety. BUT IMPROPER USE CAN RESULT IN POTENTIAL ELECTRICAL SHOCK OR FIRE HAZARDS. In order not to defeat the safeguards incorporated in this product, observe the following basic rules for its installation, use and servicing.

## 1. Read Instructions

All the safety and operating instructions should be read before the product is operated.

## 2. Retain Instructions

The safety and operating instructions should be retained for future reference.

## 3. Heed Warnings

All warnings on the product and in the operating instructions should be adhered to.

## 4. Follow Instructions

All operating and use instructions should be followed.

## 5. Cleaning

Unplug this product from the wall outlet before cleaning. Do not use liquid cleaners or aerosol cleaners. Use a damp cloth for cleaning.

## 6. Attachments

Do not use attachments not recommended by the product manufacturer as they may cause hazards.

## 7. Water and Moisture

Do not use this product near water—for example, near a bath tub, wash bowl, kitchen sink, or laundry tub; in a wet basement; or near a swimming pool; and the like.

## 8. Accessories

Do not place this product on an unstable cart, stand, tripod, bracket, or table. The product may fall, causing serious injury to a child or adult, and serious damage to the product. Use only with a cart, stand, tripod, bracket, or table recommended by the manufacturer, or sold with the product. Any mounting of the product should follow the manufacturer's instructions, and should use a mounting accessory recommended by the manufacturer.

## 9. Transportation

A product and cart combination should be moved with care. Quick stops, excessive force, and uneven surfaces may cause the product and cart combination to overturn.



## 10. Ventilation

Slots and openings in the cabinet are provided for ventilation to ensure reliable operation of the product and to protect it from overheating, and these openings must not be blocked or covered. The openings should never be blocked by placing the product on a bed, sofa, rug, or other similar surface. This product should not be placed in a built-in installation such as a bookcase or rack unless proper ventilation is provided or the manufacturer's instructions have been adhered to.

## 11. Power Sources

This product should be operated only from the type of power source indicated on the marking label. If you are not sure of the type of power supply to your home, consult your product dealer or local power company. For products intended to operate from battery power, or other sources, refer to the operating instructions.

## 12. Grounding or Polarization

This product is provided with one of the following types of plugs. If the plug should fail to fit into the power outlet, please contact your electrician. Do not defeat the safety purpose of the plug.

- Two-wire type (mains) plug.
- Three-wire grounding type (mains) plug with a grounding terminal.  
This plug will only fit into a grounding type power outlet.

## 13. Power-Cord Protection

Power-supply cords should be routed so that they are not likely to be walked on or pinched by items placed upon or against them, paying particular attention to cords at plugs, convenience receptacles, and the point where they exit from the product.

## 14. Lightning

For added protection for this product during a lightning storm, or when it is left unattended and unused for long periods of time, unplug it from the wall outlet and disconnect the cable system. This will prevent damage to the product due to lightning and power-line surges.



**15. Overloading**

Do not overload wall outlets, extension cords, or integral convenience receptacles as this can result in a risk of fire or electric shock.

**16. Object and Liquid Entry**

Never push objects of any kind into this product through openings as they may touch dangerous voltage points or short-out parts that could result in a fire or electric shock. Never spill liquid of any kind on the product.

**17. Servicing**

Do not attempt to service this product yourself as opening or removing covers may expose you to dangerous voltage or other hazards. Refer all servicing to qualified service personnel.

**18. Damage Requiring Service**

Unplug this product from the wall outlet and refer servicing to qualified service personnel under the following conditions:

- a. When the power-supply cord or plug is damaged.
- b. If liquid has been spilled, or objects have fallen into the product.
- c. If the product has been exposed to rain or water.
- d. If the product does not operate normally by following the operating instructions. Adjust only those controls that are covered by the operating instructions, as an improper adjustment of other controls may result in damage and will often require extensive work by a qualified technician to restore the product to normal operation.
- e. If the product has been dropped or damaged in any way.
- f. When the product exhibits a distinct change in performance, this indicates a need for service.

**19. Replacement Parts**

When replacement parts are required, be sure the service technician has used replacement parts specified by the manufacturer or have the same characteristics as the original part. Unauthorized substitutions may result in fire, electric shock, or other hazards.

**20. Safety Check**

Upon completion of any service or repairs to this product, ask the service technician to perform safety checks to determine that the product is in proper operating condition.

**21. Wall or Ceiling Mounting**

This product should be mounted to a wall or ceiling only as recommended by the manufacturer.

**22. Heat**

This product should be situated away from heat sources such as radiators, heat registers, stoves, or other products (including amplifiers) that produce heat.

- DLP® and the DLP logo are registered trademarks of Texas Instruments.
- Microsoft® and Windows® are registered trademarks of Microsoft Corporation in the United States and/or other countries.
- PC/AT is a registered trademark of International Business Machines Corporation in the United States.
- Adobe® Reader® is a trademark of Adobe Systems Incorporated.
- Macintosh® is a registered trademark of Apple Computer, Inc. in the United States and/or other countries.
- All other company or product names are trademarks or registered trademarks of their respective companies.
- Some IC chips in this product include confidential and/or trade secret property belonging to Texas Instruments. Therefore you may not copy, modify, adapt, translate, distribute, reverse engineer, reverse assemble or discompile the contents thereof.

# Observe the following safeguards when setting up your projector.

## Caution concerning the lamp unit

- Potential hazard of glass particles if lamp ruptures. In case of lamp rupture, contact your nearest Sharp Authorized Projector Dealer or Service Center for replacement. See “Replacing the Lamp” on page 50.

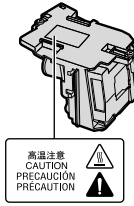

## Caution concerning the setup of the projector

- For minimal servicing and to maintain high image quality, SHARP recommends that this projector be installed in an area free from humidity, dust and cigarette smoke. When the projector is subjected to these environments, the vents and lens must be cleaned more often. As long as the projector is regularly cleaned, use in these environments will not reduce the overall operation life of the unit. Internal cleaning should only be performed by a Sharp Authorized Projector Dealer or Service Center.

## Do not set up the projector in places exposed to direct sunlight or bright light.

- Position the screen so that it is not in direct sunlight or room light. Light falling directly on the screen washes out the colors, making viewing difficult. Close the curtains and dim the lights when setting up the screen in a sunny or bright room.

## Caution regarding placing of the projector

- Place the projector on a level site within the adjustment range (approx. 9 degrees) of the adjustment foot.

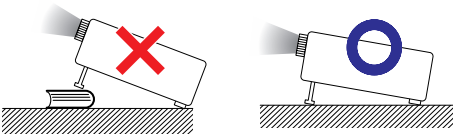

- After the projector is purchased, a faint smell from the vent may appear when the power is first turned on. This is normal and is not a malfunction. It will disappear after the projector is used for a while.

## When using the projector in high-altitude areas such as mountains (at altitudes of approximately 1,500 meters (4,900 feet) or more)

- When you use the projector in high-altitude areas with thin air, set “Fan Mode” to “High”. Neglecting this can affect the longevity of the optical system.

## Warning about placing the projector in a high position

- When placing the projector in a high position, make certain it is carefully secure to avoid personal injury caused by the projector falling down.

## Do not subject the projector to hard impact and/or vibration.

- Protect the lens so as not to hit or damage the surface of the lens.

## Rest your eyes occasionally.

- Continuously watching the screen for long hours will cause eye strain. Take regular breaks to rest your eyes.

## Avoid locations with extremes of temperature.

- The operating temperature of the projector is from 41°F to 95°F (+5°C to +35°C).
- The storage temperature of the projector is from -4°F to 140°F (-20°C to +60°C).

## Do not block the exhaust and intake vents.

- Allow at least 11 <sup>13</sup>/<sub>16</sub> inches (30 cm) of space between the exhaust vent and the nearest wall or obstruction.
- Ensure that the intake vent and the exhaust vent are not obstructed.
- If the cooling fan becomes obstructed, a protection circuit will automatically put the projector into standby mode to prevent overheat damage. This does not indicate a malfunction. (See pages 48 and 49.) Remove the projector power cord from the wall outlet and wait at least 10 minutes. Place the projector where the intake and exhaust vents are not blocked, plug the power cord back in and turn on the projector. This will return the projector to the normal operating condition.

### Caution regarding usage of the projector

- If you are not to use the projector for a long time or before moving the projector, make certain you unplug the power cord from the wall outlet, and disconnect any other cables connected to it.
- If the power cord is unplugged while the cooling fan is running, some parts of the projector may still be hot. Use caution when handling the projector.
- Do not carry the projector by holding the lens.
- When storing the projector, ensure you attach the lens cap to the projector. (See page 11.)
- Do not expose the projector to direct sunlight or place next to heat sources. Doing so may affect the cabinet color or cause deformation of the plastic cover.

### Other connected equipment

- When connecting a computer or other audio-visual equipment to the projector, make the connections AFTER unplugging the power cord of the projector from the AC outlet and turning off the equipment to be connected.
- Please read the operation manuals of the projector and the equipment to be connected for instructions on how to make the connections.

### Using the projector in other countries

- The power supply voltage and the shape of the plug may vary depending on the region or country you are using the projector in. When using the projector overseas, make sure you use an appropriate power cord for the country you are in.

### Temperature monitor function



- If the projector starts to overheat due to setup problems or blockage of the air vents, the  and "TEMP." will illuminate in the lower left corner of the picture. If the temperature continues to rise, the lamp will turn off, the temperature warning indicator on the projector will blink, and after a 60-second cooling-off period the projector will enter standby mode. Refer to "Maintenance Indicators" on page 48 for details.

### Info

- The cooling fan regulates the internal temperature, and its performance is automatically controlled. The sound of the fan may change during projector operation due to changes in the fan speed. This does not indicate malfunction.

## How to Access the PDF Operation Manuals

PDF operation manuals in several languages are included in the CD-ROM. To utilize these manuals, you need to install Adobe® Reader® on your computer (Windows® or Macintosh®).

Please download Adobe® Reader® from the Internet (<http://www.adobe.com>).

### Accessing the PDF Manuals for Windows® (For Macintosh®, skip step ②).

- ① Insert the CD-ROM in the CD-ROM drive.
- ② Double click the "My Computer" icon.
- ③ Double click the "CD-ROM" drive.
- ④ Double click the "MANUALS" folder.
- ⑤ Double click the model (name of the folder) that you want to view.
- ⑥ Double click the language (name of the folder) that you want to view.
- ⑦ Double click the pdf file to access the projector manuals.

### Note

- If the desired pdf file cannot be opened by double clicking the mouse, start Adobe® Reader® first, then specify the desired file using the "File", "Open" menu.

# Accessories

## Supplied accessories



Remote control  
<RRMCGA581WJSA>



Two R-6 batteries  
("AA" size, UM/SUM-3,  
HP-7 or similar)

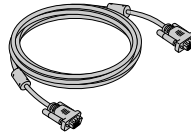

RGB cable  
(10' (3.0 m))  
<QCNWGA045WJPZ>



Lens cap (attached)  
<CCAPHA027WJSA>

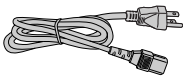

Power cord  
(6' (1.8 m))  
<QACCCA007WJPZ>

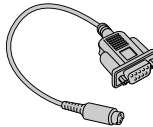

DIN-D-sub RS-232C adaptor  
(5 <sup>57</sup>/<sub>64</sub>" (15 cm))  
<QCNWGA091WJPZ>



Storage case  
<GCASNA021WJSA>

- Operation manual (this manual <TINS-D338WJZZ> and CD-ROM <UDSKAA094WJZZ>)

### Note

- Codes in "< >" are Replacement parts codes.

## Optional accessories

- |  |                                   |
|--|-----------------------------------|
| ■ 3 RCA to mini D-sub 15 pin cable (10' (3.0 m)) | AN-C3CP2                          |
| ■ Remote receiver                                | AN-MR2                            |
| ■ Lamp unit                                      | AN-XR30LP                         |
| ■ Ceiling-mount bracket                          | AN-XRCM30 (for U.S.A.)<br>AN-60KT |
| ■ Extension tube                                 | AN-TK201<br>AN-TK202              |

### Note

- Some of the optional accessories may not be available depending on the region. Please check with your nearest Sharp Authorized Projector Dealer or Service Center.

# Part Names and Functions

Numbers in **■** refer to the main pages in this operation manual where the topic is explained.

## Projector

### Top View

Power indicator **25, 48**

STANDBY/ON button **25**

For turning the power on and putting the projector into standby mode.

ENTER button **37**

For setting items selected or adjusted on the menu.

KEYSTONE button **28**

For entering the Keystone mode.

**25, 48** Lamp indicator

**48** Temperature warning indicator

**32** ECO+QUIET button  
For lowering the noise of the cooling fan and extending the lamp life.

**29** VOL (Volume) buttons (-◀▶+)  
For adjusting the speaker sound level.

**29** INPUT buttons (▲/▼)  
For switching input mode.

**37, 46** MENU/HELP button  
For displaying adjustment and setting screens, and help screen.

**37** Adjustment buttons (▲/▼/◀/▶)  
For selecting menu items.

### Front View

Zoom ring **26**  
For enlarging/reducing the picture.

Remote control sensor **15**

Exhaust vent **47**

HEIGHT ADJUST lever **27**

**47** Intake vent

**43** Speaker

**26** Focus ring  
For adjusting the focus.

Push both sides of the lens cap to attach or remove.

# Part Names and Functions (Continued)

Numbers in    refer to the main pages in this operation manual where the topic is explained.

## Rear View

### Terminals

AUDIO 1 input terminal 23

DVI-I input terminal 21  
Terminal for DVI digital, computer RGB, and component signals. 22

COMPUTER/COMPONENT input terminal 21  
Terminal for computer RGB and component signals. 22

AUDIO OUT terminal 23  
Audio output terminal of equipment connected to the audio input terminal.

MONITOR OUT terminal 23  
(Output terminal for computer RGB, component and DVI analog signals. Shared for COMPUTER/COMPONENT and DVI-I)  
Terminal for connecting a monitor.

Rear adjustment foot 27

22 S-VIDEO input terminal  
Terminal for connecting video equipment with an S-video terminal.

24 RS-232C terminal  
Terminal for controlling the projector using a computer.

34 USB terminal  
Terminal connecting with the USB terminal on the computer for using the supplied remote control as the computer mouse.

23 AUDIO 2 input terminal

22 VIDEO input terminal  
Terminal for connecting video equipment.

24 AC socket  
Connect the supplied power cord.

Kensington Security Standard connector

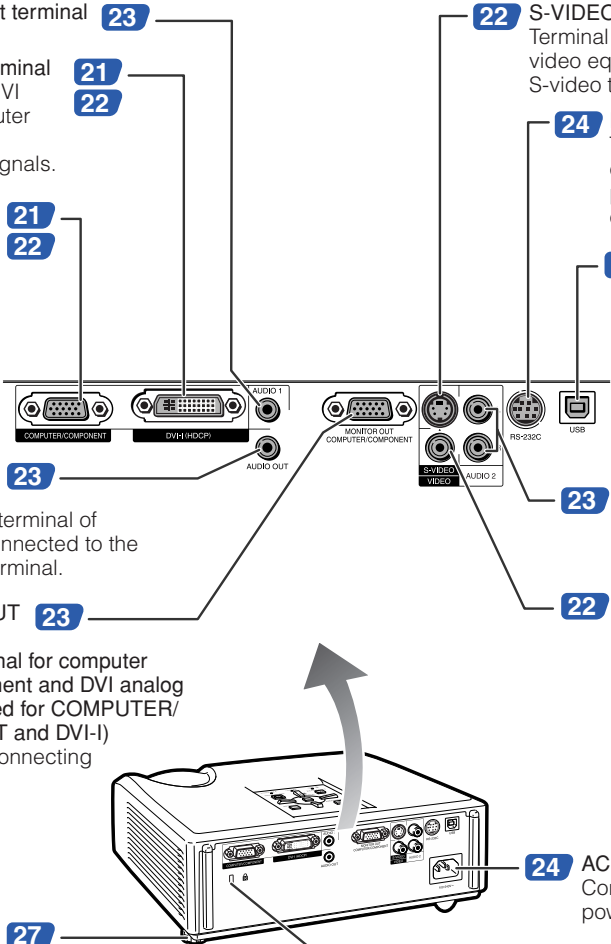

### Using the Kensington Lock

- This projector has a Kensington Security Standard connector for use with a Kensington MicroSaver Security System. Refer to the information that came with the system for instructions on how to use it to secure the projector.

**STANDBY button**

For putting the projector into the standby mode.

**COMPUTER, DVI, S-VIDEO, VIDEO buttons**

For switching to the respective input modes.

**BREAK TIMER button**

For displaying the break time.

**PAGE UP/PAGE DOWN buttons**

Same as the [Page Down] and [Page Up] keys on a computer keyboard, when with the USB connection (using a USB cable or the optional remote receiver).

**POINTER button**

For displaying the pointer.

**MOUSE/Adjustment buttons (▲/▼/◀/▶)**

- For moving the computer cursor when with the USB connection (using a USB cable or the optional remote receiver).
- For selecting and adjusting menu items.

**L-CLICK button**

For the Left click when with the USB connection (using a USB cable or the optional remote receiver).

**KEystone button**

For entering the Keystone Correction mode.

**AUTO SYNC button**

For automatically adjusting images when connected to a computer.

**ECO+QUIET button**

For lowering the noise of the cooling fan and extending the lamp life.

**25****29****32****34****32****34****37****34****28****33****32****25****33****29****29****32****37****34****37****37****46****30****33****ON button**

For turning the power on.

**FREEZE button**

For freezing images.

**AV MUTE button**

For temporarily displaying a black screen and turning off the sound.

**VOL +/- (Volume) buttons**

For adjusting the speaker sound level.

**SPOT button**

For displaying the spotlight.

**ENTER button**

For setting items selected or adjusted on the menu.

**R-CLICK/RETURN button**

- For the Right click when with the USB connection (using a USB cable or the optional remote receiver).
- For returning to the previous menu screen during menu operations.

**MENU/HELP button**

For displaying adjustment and setting screens, and help screen.

**RESIZE button**

For switching the picture size (NORMAL, BORDER, etc.).

**PICTURE MODE button**

For selecting the appropriate picture.

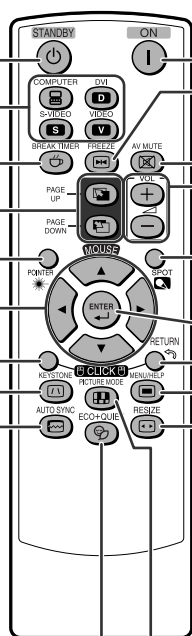

# Part Names and Functions (Continued)

## Inserting the Batteries

- 1** Pull down the tab on the cover and remove the cover towards the direction of the arrow.

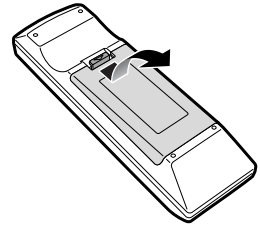

- 2** Insert the batteries.
- Insert the batteries making sure the polarities correctly match the ⊕ and ⊖ marks inside the battery compartment.

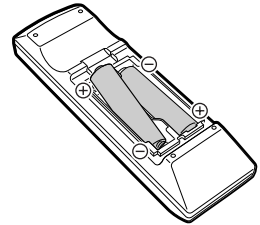

- 3** Insert the lower tab of the cover into the opening, and lower the cover until it clicks in place.

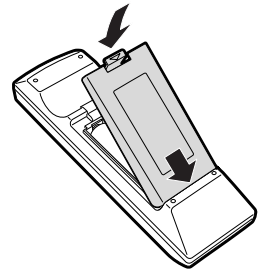

**Incorrect use of the batteries may cause them to leak or explode. Please follow the precautions below.**



### Caution

- Danger of explosion if battery is incorrectly replaced. Replace only with alkaline or manganese batteries.
- Insert the batteries correctly making sure the polarities correctly match the ⊕ and ⊖ marks inside the battery compartment.
- Batteries of different types have different properties, therefore do not mix batteries of different types.
- Do not mix new and old batteries.  
This may shorten the life of new batteries or may cause old batteries to leak.
- Remove the batteries from the remote control once they have run out, as leaving them in can cause them to leak.  
Battery fluid from leaked batteries is harmful to skin, therefore ensure you wipe them first and then remove them using a cloth.
- The batteries included with this projector may run down in a short period, depending on how they are kept. Be sure to replace them as soon as possible with new batteries.
- Remove the batteries from the remote control if you will not be using the remote control for a long time.
- Comply with the rules (ordinance) of each local government when disposing of worn-out batteries.



## Usable Range

The remote control can be used to control the projector within the ranges shown in the illustration.

### Note

- The signal from the remote control can be reflected off a screen for easy operation. However, the effective distance of the signal may differ depending on the screen material.

### When using the remote control

- Ensure that you do not drop it or expose it to moisture or high temperature.
- The remote control may malfunction under a fluorescent lamp. In this case, move the projector away from the fluorescent lamp.

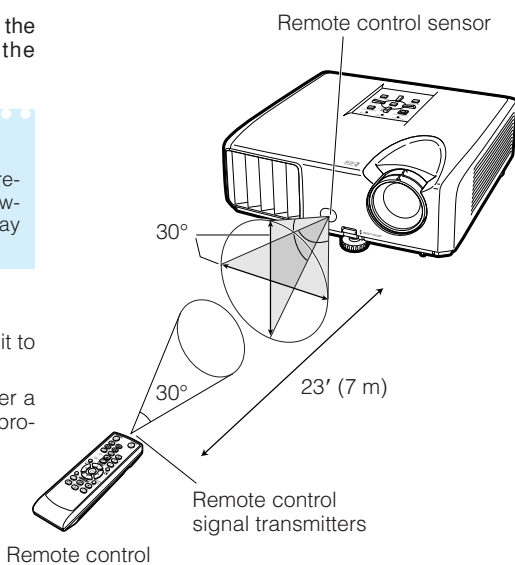

# Quick Start

This section shows the basic operation (projector connecting with the computer). For details, see the page described below for each step.

## Setup and Projection

In this section, connection of the projector and the computer is explained using one example.

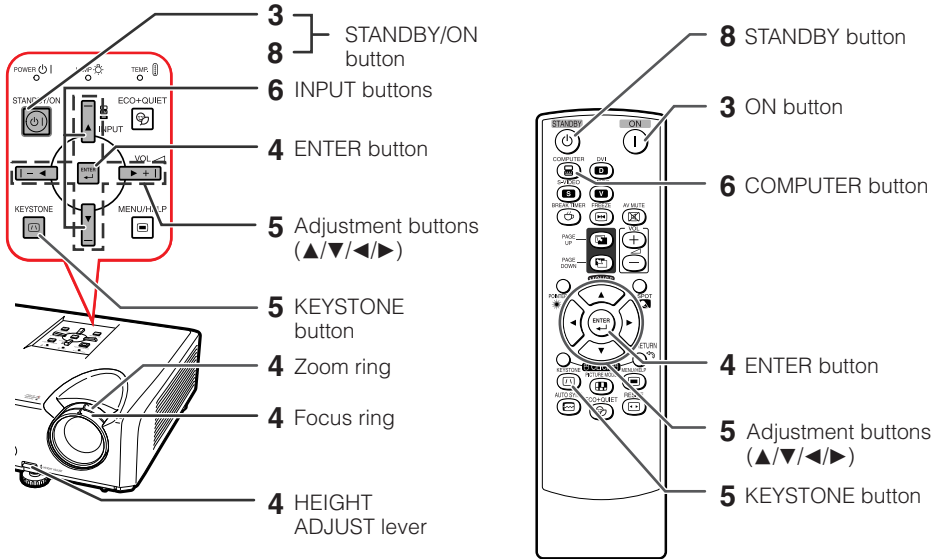

**1. Place the projector facing a wall or a screen**

➔ P. 18

**2. Connect the projector to the computer and plug the power cord into the AC socket of the projector**

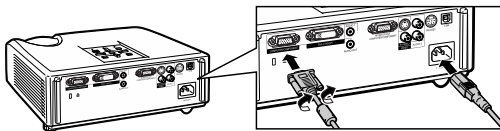

When connecting equipment other than a computer, see pages **22** and **23**.

➔ PP. 21, 24

**3. Remove the lens cap and turn the projector on**

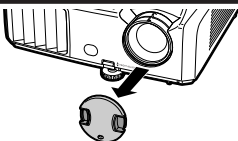

On the projector

On the remote control

STANDBY/ON

ON



➔ P. 25

## 4. Adjust the projected image with the Setup Guide

- 1 After the projector turns on, the Setup Guide appears.  
(When "Setup Guide" is set to "On". See page 42.)
- 2 Follow the steps in the Setup Guide and adjust the focus, picture size, and height (angle).
- 3 After adjusting the focus, height (angle) and picture size, press **ENTER** to finish the Setup Guide.

➔ PP. 26, 27

## 5. Correct trapezoidal distortion

Correcting trapezoidal distortion using Keystone Correction.

On the projector

KEystone

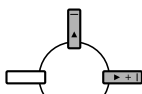

Shrinks upper side.

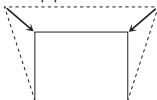

Shrinks lower side.

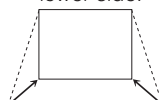

On the remote control

KEystone

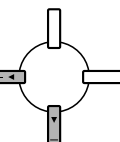

➔ P. 28

## 6. Select the INPUT mode

Select the "COMPUTER" using **INPUT** on the projector or **COMPUTER** on the remote control.

On the projector



On the remote control



INPUT list

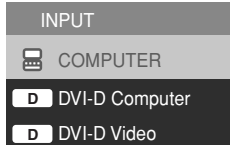

On-screen display (RGB)



- When you press **INPUT** on the projector, the INPUT list appears. Press **▲/▼** to switch the INPUT mode.

➔ P. 29

## 7. Turn the computer on

## 8. Turn the power off

Press **STANDBY/ON** on the projector or **STANDBY** on the remote control, and then press the button again while the confirmation message is displayed to put the projector into standby mode.

On the projector



On the remote control



On-screen display

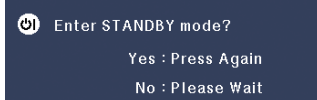

➔ P. 25

# Setting up the Projector

## Setting up the Projector

For optimal image quality, position the projector perpendicular to the screen with the projector's feet flat and level. Doing so will eliminate the need for Keystone correction and provide the best image quality. (See page 28.)

### Standard Setup (Front Projection)

- Place the projector at the required distance from the screen according to the desired picture size. (See page 20.)

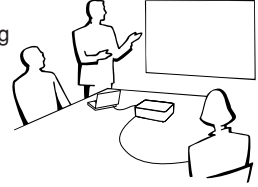

### Example of standard setup

#### Side View

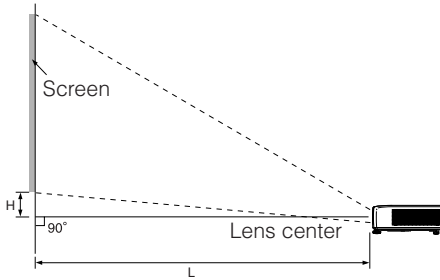

#### Note

- Refer to page 20 for additional information concerning "Screen Size and Projection Distance".

### Ceiling-mount Setup

- It is recommended that you use the optional Sharp ceiling-mount bracket for this installation. Before mounting the projector, contact your nearest Sharp Authorized Projector Dealer or Service Center to obtain the recommended ceiling-mount bracket (sold separately).

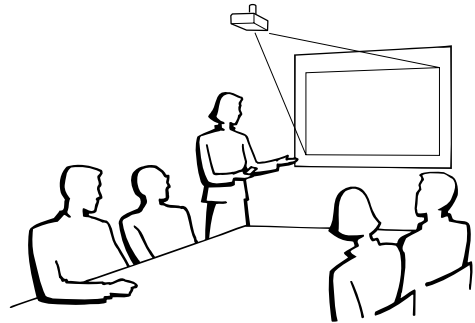

## Projection (PRJ) Mode

The projector can use any of the 4 projection modes shown in the diagram below. Select the mode most appropriate for the projection setting in use. (You can set the PRJ mode in "SCR-ADJ" menu. See page 42.)

- Table mounted, front projection  
[Menu item → "Front"]

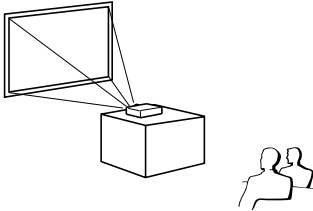

- Ceiling mounted, front projection  
[Menu item → "Ceiling + Front"]

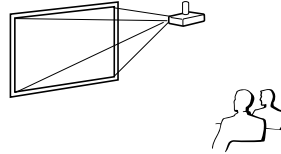

- Table mounted, rear projection  
(with a translucent screen)  
[Menu item → "Rear"]

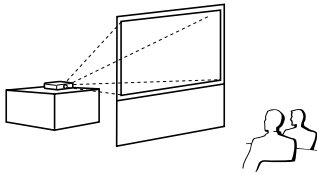

- Ceiling mounted, rear projection  
(with a translucent screen)  
[Menu item → "Ceiling + Rear"]

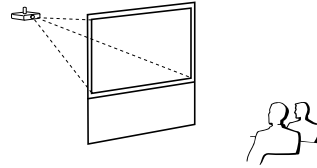

## Indication of the Projection Image Size and Projection Distance

Example: NORMAL Mode (4:3)

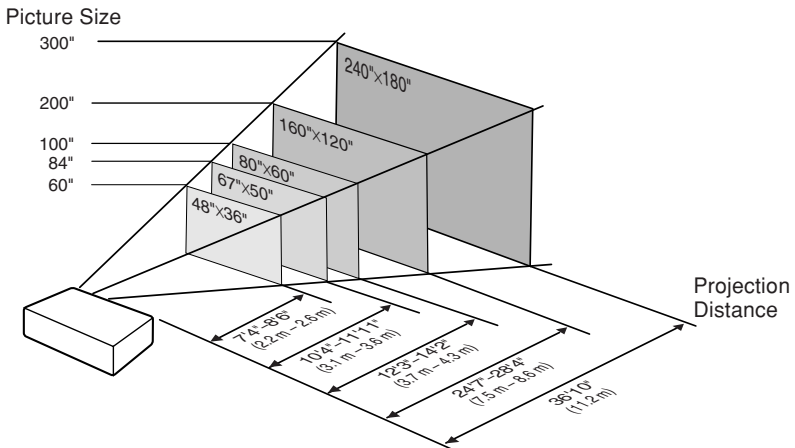

# Setting up the Projector (Continued)

## Screen Size and Projection Distance

### NORMAL Mode (4:3)

Picture (Screen) size			Projection distance [L]		Distance from the lens center to the bottom of the image [H]
Diag. [X]	Width	Height	Minimum [L1]	Maximum [L2]	
300" (762 cm)	610 cm (240")	457 cm (180")	11.2 m (36' 10")	—	19 cm (7 <sup>9</sup> / <sub>16</sub> "
270" (686 cm)	549 cm (216")	411 cm (162")	10.1 m (33' 2")	11.7 m (38' 4")	17 cm (6 <sup>5</sup> / <sub>16</sub> "
250" (635 cm)	508 cm (200")	381 cm (150")	9.4 m (30' 9")	10.8 m (35' 5")	16 cm (6 <sup>19</sup> / <sub>64</sub> "
200" (508 cm)	406 cm (160")	305 cm (120")	7.5 m (24' 7")	8.6 m (28' 4")	13 cm (5 <sup>3</sup> / <sub>64</sub> "
150" (381 cm)	305 cm (120")	229 cm (90")	5.6 m (18' 5")	6.5 m (21' 3")	10 cm (3 <sup>25</sup> / <sub>32</sub> "
100" (254 cm)	203 cm (80")	152 cm (60")	3.7 m (12' 3")	4.3 m (14' 2")	6 cm (2 <sup>39</sup> / <sub>64</sub> "
84" (213 cm)	171 cm (67")	128 cm (50")	3.1 m (10' 4")	3.6 m (11' 11")	5 cm (2 <sup>7</sup> / <sub>64</sub> "
72" (183 cm)	146 cm (58")	110 cm (43")	2.7 m (8' 10")	3.1 m (10' 3")	5 cm (1 <sup>13</sup> / <sub>16</sub> "
60" (152 cm)	122 cm (48")	91 cm (36")	2.2 m (7' 4")	2.6 m (8' 6")	4 cm (1 <sup>33</sup> / <sub>64</sub> "
40" (102 cm)	81 cm (32")	61 cm (24")	1.5 m (4' 11")	1.7 m (5' 8")	3 cm (1 <sup>1</sup> / <sub>64</sub> "

X: Picture size (diag.) (in/cm)

L: Projection distance (m/ft)

L1: Minimum projection distance (m/ft)

L2: Maximum projection distance (m/ft)

H: Distance from the lens center to the bottom of the image (cm/in)

The formula for picture size and projection distance

[m/cm]

L1 (m) = 0.03745X

L2 (m) = 0.04323X

H (cm) = 0.064X

[Feet/inches]

L1 (ft) = 0.03745X / 0.3048

L2 (ft) = 0.04323X / 0.3048

H (in) = 0.064X / 2.54

### STRETCH Mode (16:9)

Picture (Screen) size			Projection distance [L]		Distance from the lens center to the bottom of the image [H]	Adjustable range of image position [S]
Diag. [X]	Width	Height	Minimum [L1]	Maximum [L2]		
250" (635 cm)	553 cm (218")	311 cm (123")	10.2 m (33' 6")	11.8 m (38' 8")	69 cm (27 <sup>19</sup> / <sub>64</sub> "	± 52 cm (± 20 <sup>27</sup> / <sub>64</sub> "
225" (572 cm)	498 cm (196")	280 cm (110")	9.2 m (30' 1")	10.6 m (34' 9")	62 cm (24 <sup>9</sup> / <sub>16</sub> "	± 47 cm (± 18 <sup>25</sup> / <sub>64</sub> "
200" (508 cm)	443 cm (174")	249 cm (98")	8.2 m (26' 9")	9.4 m (30' 11")	55 cm (21 <sup>53</sup> / <sub>64</sub> "	± 42 cm (± 16 <sup>11</sup> / <sub>32</sub> "
150" (381 cm)	332 cm (131")	187 cm (74")	6.1 m (20' 1")	7.1 m (23' 2")	42 cm (16 <sup>3</sup> / <sub>8</sub> "	± 31 cm (± 12 <sup>1</sup> / <sub>4</sub> "
133" (338 cm)	294 cm (116")	166 cm (65")	5.4 m (17' 10")	6.3 m (20' 7")	37 cm (14 <sup>39</sup> / <sub>64</sub> "	± 28 cm (± 10 <sup>7</sup> / <sub>8</sub> "
106" (269 cm)	235 cm (92")	132 cm (52")	4.3 m (14' 2")	5.0 m (16' 5")	29 cm (11 <sup>37</sup> / <sub>64</sub> "	± 22 cm (± 8 <sup>21</sup> / <sub>32</sub> "
100" (254 cm)	221 cm (87")	125 cm (49")	4.1 m (13' 5")	4.7 m (15' 5")	28 cm (10 <sup>59</sup> / <sub>64</sub> "	± 21 cm (± 8 <sup>11</sup> / <sub>64</sub> "
92" (234 cm)	204 cm (80")	115 cm (45")	3.8 m (12' 4")	4.3 m (14' 3")	26 cm (10 <sup>3</sup> / <sub>64</sub> "	± 19 cm (± 7 <sup>39</sup> / <sub>64</sub> "
84" (213 cm)	186 cm (73")	105 cm (41")	3.4 m (11' 3")	4.0 m (13')	23 cm (9 <sup>11</sup> / <sub>64</sub> "	± 17 cm (± 6 <sup>55</sup> / <sub>64</sub> "
72" (183 cm)	159 cm (63")	90 cm (35")	2.9 m (9' 8")	3.4 m (11' 2")	20 cm (7 <sup>55</sup> / <sub>64</sub> "	± 15 cm (± 5 <sup>57</sup> / <sub>64</sub> "
60" (152 cm)	133 cm (52")	75 cm (29")	2.4 m (8')	2.8 m (9' 3")	17 cm (6 <sup>35</sup> / <sub>64</sub> "	± 12 cm (± 4 <sup>29</sup> / <sub>32</sub> "
40" (102 cm)	89 cm (35")	50 cm (20")	1.6 m (5' 4")	1.9 m (6' 2")	11 cm (4 <sup>23</sup> / <sub>64</sub> "	± 8 cm (± 3 <sup>17</sup> / <sub>64</sub> "

X: Picture size (diag.) (in/cm)

L: Projection distance (m/ft)

L1: Minimum projection distance (m/ft)

L2: Maximum projection distance (m/ft)

H: Distance from the lens center to the bottom of the image (cm/in)

S: Adjustable range of image position (cm/in) See page 41.

The formula for picture size and projection distance

[m/cm]

L1 (m) = 0.0408X

L2 (m) = 0.0471X

H (cm) = 0.27727X

S (cm) = ± 0.20754X

[Feet/inches]

L1 (ft) = 0.0408X / 0.3048

L2 (ft) = 0.0471X / 0.3048

H (in) = 0.27727X / 2.54

S (in) = ± 0.20754X / 2.54



#### Note

- Refer to page 18 concerning "Projection distance [L]" and "Distance from the lens center to the bottom of the image [H]".
- Allow a margin of error in the values in the diagrams above.

# Connecting the Projector to Other Equipment

Before connecting, ensure that the power cord of the projector is unplugged from the AC outlet and turn off the equipment to be connected. After making all connections, turn on the projector and then the other pieces of equipment. When connecting a computer, ensure that it is the last equipment to be turned on after all the connections are made.

## IMPORTANT:

Ensure that the appropriate input mode has been selected on the projector before you turn on the connected equipment.

- For more details of connection and cables, refer to the operation manual of the connecting equipment.
- You may need other cables or connectors not listed below.

## Terminals on the Projector

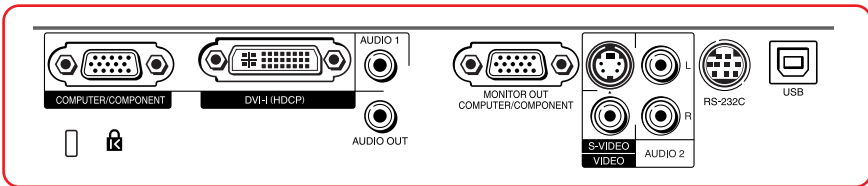











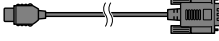

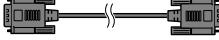

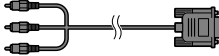
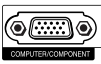

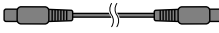
Equipment	Terminal on connected equipment	Cable	Terminal on the projector
	<b>RGB output terminal</b> 	<b>RGB cable (supplied)</b> 	<b>COMPUTER/COMPONENT</b> 
	<b>RGB output terminal</b> 	<b>mini D-sub 15 pin to DVI cable (commercially available)</b> 	<b>DVI-I</b> 
	<b>DVI digital output terminal</b> 	<b>DVI Digital cable (commercially available)</b> 	

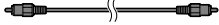
## Note

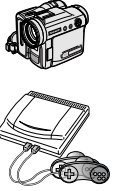
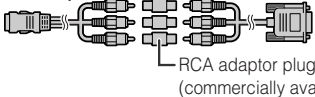
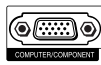
- See page 61 “Computer Compatibility Chart” for a list of computer signals compatible with the projector. Use with computer signals other than those listed may cause some of the functions to not work.
- A Macintosh adaptor may be required for use with some Macintosh computers. Contact your nearest Macintosh Dealer.
- **Depending on the computer you are using, an image may not be projected unless the computer’s external output port is switched on (e.g. Press “Fn” and “F5” keys simultaneously when using a SHARP notebook computer).** Refer to the specific instructions in your computer’s operation manual to enable your computer’s external output port.











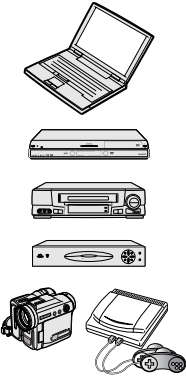

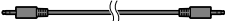
# Connecting the Projector to Other Equipment (Continued)

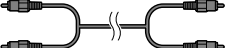
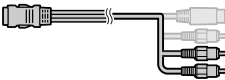
Equipment	Terminal on connected equipment	Cable	Terminal on the projector
	HDMI output terminal 	HDMI to DVI cable (commercially available) 	DVI-I 
	DVI digital output terminal 	DVI Digital cable (commercially available) 	
	Component video output terminal 	3 RCA to mini D-sub 15 pin cable (optional, AN-C3CP2) 	COMPUTER/COMPONENT 
	S-video output terminal 	S-video cable (commercially available) 	S-VIDEO 
	Video output terminal 	Video cable (commercially available) 	VIDEO 
	Component video output terminal	Cables for a camera or a video game/3 RCA to mini D-sub 15 pin cable (optional, AN-C3CP2)  RCA adaptor plug (commercially available)	COMPUTER/COMPONENT 
	S-video output terminal	Cables for a camera or a video game 	S-VIDEO 
	Video output terminal	Cables for a camera or a video game 	VIDEO 

## Note

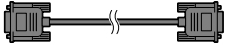
- While the projector is connected to video equipment that has an HDMI output terminal, only the video signal can be input to the projector. (Connect the AUDIO input terminal for audio input.)
- Depending on specifications of video equipment or HDMI to DVI digital cable, the signal transmission may not work properly. (The HDMI specification does not support all connections to video equipment that has HDMI digital output terminal using HDMI to DVI digital cable.)
- For details on compatibility for connection, see support information on DVI connection provided by the video equipment manufacturer.
- When you connect video equipment with a 21-pin RGB output (Euro-scart) to the projector, use a commercially available cable that fits in the projector terminal you want to connect.
- The projector does not support RGBC signals via the Euro-scart.

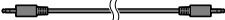

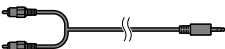
Equipment	Terminal on connected equipment	Cable	Terminal on the projector	
<b>Audio equipment</b> 	<b>ø3.5 mm audio output terminal</b> 	<b>ø3.5 mm stereo or mono audio cable (commercially available or available as Sharp service part QCNWGA038WJPZ)</b> 	<b>AUDIO 1</b> 	
	<b>RCA audio output terminal</b> 	<b>RCA audio cable (commercially available)</b> 	<b>Cables for a camera or a video game</b> 	<b>AUDIO 2</b> 
	<b>Audio output terminal</b>			
<b>Monitor</b> 	<b>RGB input terminal</b> 	<b>RGB cable (supplied or commercially available)</b> 	<b>MONITOR OUT</b> 	
<b>Amplifier</b> 	<b>ø3.5 mm audio input terminal</b>	<b>ø3.5 mm stereo or mono audio cable (commercially available or available as Sharp service part QCNWGA038WJPZ)</b> 	<b>AUDIO OUT</b> 	
	<b>RCA audio input terminal</b>	<b>ø3.5 mm stereo minijack to RCA audio cable (commercially available)</b> 		

 **Note**

- When using the ø3.5 mm mono audio cable, the volume level will be half of when using the ø3.5 mm stereo audio cable.
- You can select "Audio 1" or "Audio 2" for "Audio Input" in the "PRJ-ADJ" menu. (See page 43.)
- RGB signals and Component signals can be output to the monitor.

# Controlling the Projector by a Computer

When the RS-232C terminal on the projector is connected to a computer with a DIN-D-sub RS-232C adaptor and an RS-232C serial control cable (cross type, commercially available), the computer can be used to control the projector and check the status of the projector. See page 56 for details.

## When connecting to a computer using an RS-232C serial control cable and a DIN-D-sub RS-232C adaptor

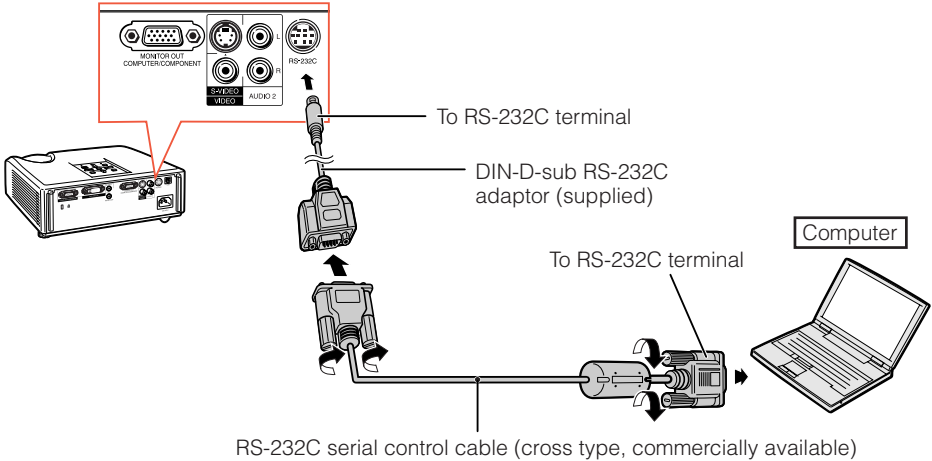

### Note

- The RS-232C function may not operate if your computer terminal is not correctly set up. Refer to the operation manual of the computer for details.
- See page 55 for connection of an RS-232C serial control cable.

### Info

- Do not connect the RS-232C cable to a port other than the RS-232C terminal on the computer. This may damage your computer or projector.
- Do not connect or disconnect an RS-232C serial control cable to or from the computer while it is on. This may damage your computer.

# Connecting the Power Cord

Plug the supplied power cord into the AC socket on the rear of the projector. Then plug into AC outlet.

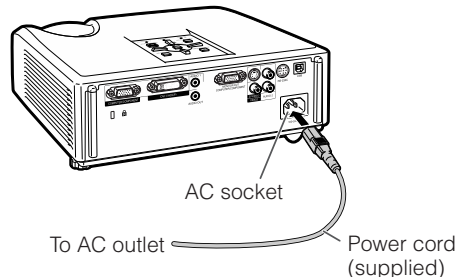

# Turning the Projector On/Off

## Turning the Projector on

Note that the connections to external equipment and power outlet should be done before performing the operations written below. (See pages 21 to 24.)

Remove the lens cap and press **STANDBY/ON** on the projector or **ON** on the remote control.

- The power indicator illuminates green.
- After the lamp indicator illuminates, the projector is ready to start operation.

### Note

#### • About the Lamp Indicator

The lamp indicator illuminates to indicate the status of the lamp.

**Green:** The lamp is on.

**Blinking in green:** The lamp is warming up.

**Red:** The lamp is shut down abnormally or the lamp should be replaced.

- When switching on the projector, a slight flickering of the image may be experienced within the first minute after the lamp has been illuminated. This is normal operation as the lamp's control circuitry is stabilising the lamp output characteristics. It should not be regarded as faulty operation.
- If the projector is put into standby mode and immediately turned on again, the lamp may take some time to start projection.
- When System Lock is set, the keycode input box appears. To cancel the keycode setting, input the keycode that you have already set. See page 44 for details.

## Turning the Power off (Putting the Projector into Standby Mode)

Press **STANDBY/ON** on the projector or **STANDBY** on the remote control, then press that button again while the confirmation message is displayed, to put the projector into standby mode.

- The projector cannot be turned on while cooling.

### Info

#### • When “Auto Restart” is set to “On”:

- If the power cord is unplugged from the outlet or the breaker switch is turned off when the projector is on, then the projector automatically turns on when the power cord is plugged into the AC outlet or the breaker switch is turned on. (See page 43.)
- English is the factory default language. If you want to change the on-screen display to another language, change the language according to the procedure on page 42.

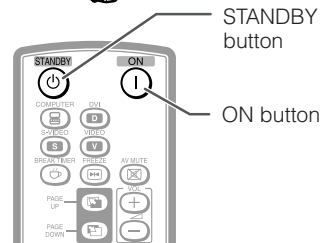
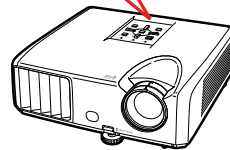
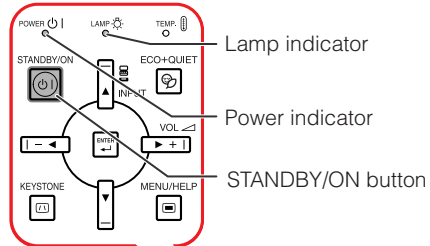

On-screen display (confirmation message)



Enter STANDBY mode?

Yes : Press Again

No : Please Wait

### Info

#### • Direct Power Off function:

- You can unplug the power cord from the AC outlet even if the cooling fan is still running.

# Image Projection

## About the Setup Guide

After turning on the projector, the Setup Guide screen appears to assist you with projector setup.

- Guidance items
- 1 FOCUS
  - 2 HEIGHT ADJUST
  - 3 ZOOM

Press **ENTER** to exit the Setup Guide screen.

Setup Guide screen

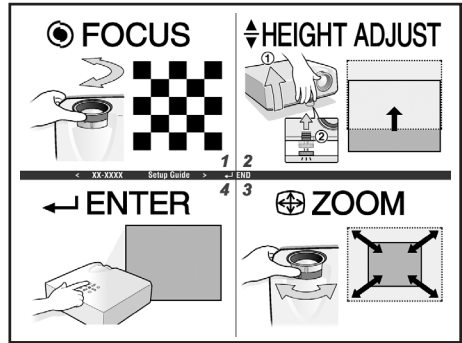

### Note

- The Setup Guide screen automatically highlights the items in the following order:

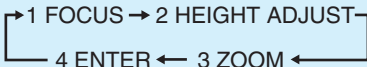

However, you can adjust the focus, height (angle), or zoom regardless of the highlighted item.

- If you do not want to display the Setup Guide for the next time, set "Menu" - "SCR - ADJ" - "Setup Guide" to "Off". (See page 42.)

## Adjusting the Projected Image

### 1 Adjusting the Focus

You can adjust the focus with the focus ring on the projector.

Rotate the focus ring to adjust the focus while watching the projected image.

### 2 Adjusting the Picture Size

You can adjust the picture size using the zoom ring on the projector.

Rotate the zoom ring to enlarge or shrink the picture size.

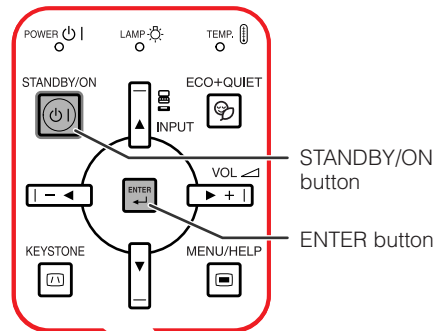

Zoom ring

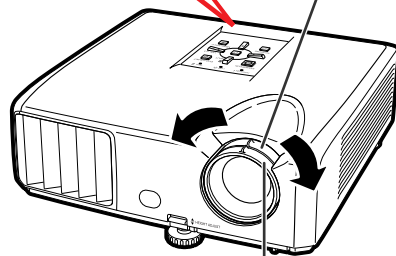

Focus ring

### 3 Adjusting the Height

The height of the projector can be adjusted using the adjustment feet at the front and rear of the projector.

When the screen is above the projector, the projection image can be made higher by adjusting the projector.

**1** Lift the projector to adjust its height while lifting the HEIGHT ADJUST lever.

**2** Remove your hands from the HEIGHT ADJUST lever of the projector after its height has been finely adjusted.

- The angle of projection is adjustable up to approx. 9 degrees from the surface on which the projector is placed.

**3** Use the rear adjustment foot to make the projector level.

- The projector is adjustable  $\pm 2$  degree from the standard position.

#### Note

- When adjusting the height of the projector, trapezoidal distortion occurs. Follow the procedures in Keystone Correction to correct the distortion. (See pages 28 and 41.)

#### Info

- Do not apply too much pressure on the projector when the front adjustment foot comes out.
- When lowering the projector, be careful not to get your fingers caught in the area between the adjustment foot and the projector.
- Hold the projector firmly while lifting or carrying.
- Do not hold by the lens area.

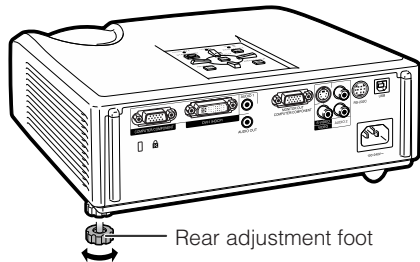
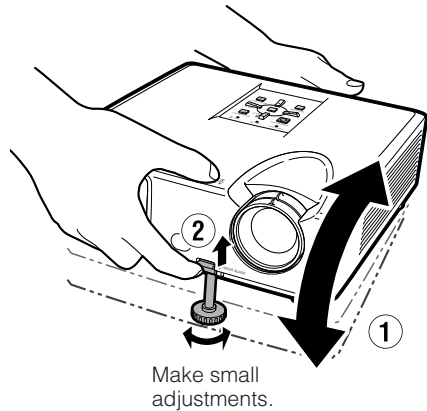
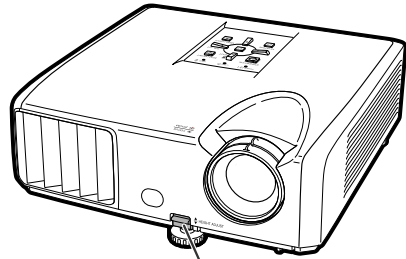

# Image Projection (Continued)

## Correcting Trapezoidal Distortion

When the image is projected either from the top or from the bottom towards the screen at an angle, the image becomes distorted trapezoidally. The function for correcting trapezoidal distortion is called **Keystone Correction**.

### Note

- The Keystone Correction can be adjusted up to an angle of approximately  $\pm 20$  degrees and the screen can also be set up to an angle of approximately  $\pm 20$  degrees (when the resize mode is set to "NORMAL" (see page 30)).

### 1 Press **KEYSTONE** to enter the **Keystone Correction mode**.

- You can also display the on-screen display of the Keystone Correction mode with **KEYSTONE** on the projector.

### 2 Press **▲/▶** or **◀/▼** to adjust the **Keystone Correction**.

- You can also adjust the Keystone Correction using the adjustment buttons on the projector.

### Note

- To return to the default setting, press **RETURN** while the on-screen display of the Keystone Correction mode is on the screen.

### 3 Press **KEYSTONE**.

- The on-screen display of the Keystone Correction mode will disappear.
- You can also use **KEYSTONE** on the projector.

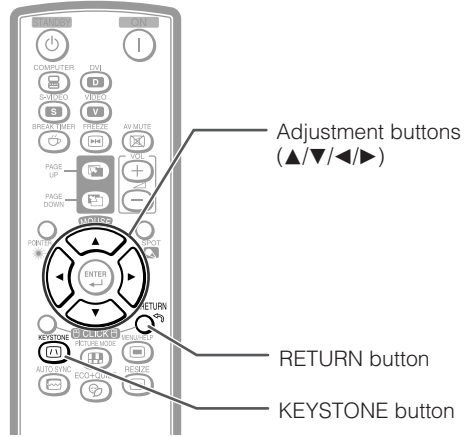

### On-screen display (Keystone Correction mode)

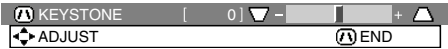

Shrinks upper side.  
(Move the slide bar in the + direction.)

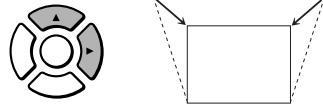

Shrinks lower side.  
(Move the slide bar in the - direction.)

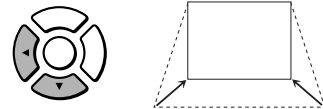

### Info

- While adjusting the image using Keystone Correction, straight lines and the edges of the image may appear jagged.

## Switching the Input Mode

Select the appropriate input mode for the connected equipment.

Press **COMPUTER**, **DVI**, **S-VIDEO** or **VIDEO** on the remote control to select the input mode.

- When you press **INPUT** on the projector or **DVI** on the remote control, the INPUT list appears. Press  $\blacktriangle/\blacktriangledown$  to switch the INPUT mode.

## Adjusting the Volume

Press **VOL +/-** on the remote control or  $\blacktriangle/\blacktriangledown$  on the projector to adjust the volume.

### Note

- Pressing **VOL**  $\blacktriangle/\blacktriangledown$  will lower the volume.
- Pressing **VOL**  $\blacktriangle/\blacktriangledown$  + will raise the volume.
- When the projector is connected to external equipment, the volume level of the external equipment changes in accordance with the volume level of the projector. Set the projector's volume to the lowest level when turning the projector on/off or when changing the input signal.
- When you do not want to output the sound from the projector's speaker while the projector is connected to external equipment, set "Speaker" in "PRJ-ADJ" menu to "Off". (See page 43.)

## Displaying the Black Screen and Turning off the Sound Temporarily

Press **AV MUTE** on the remote control to temporarily display a black screen and turn off the sound.

### Note

- Pressing **AV MUTE** again will turn the projected image back on.

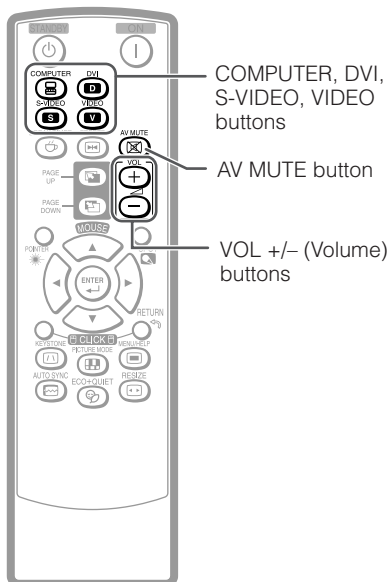

On-screen display



On-screen display



# Image Projection (Continued)

## Resize Mode

This function allows you to modify or customize the resize mode to enhance the input image. Depending on the input signal, you can choose “NORMAL”, “BORDER” or “STRETCH” image.





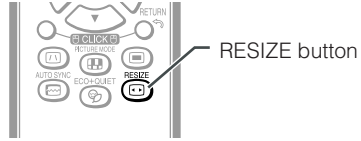

### Press **RESIZE**.

- See page 41 for setting on menu screen.

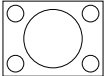
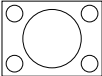

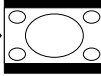
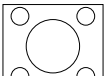
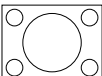
### Computer

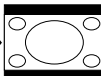
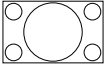
	Main resolution	NORMAL	BORDER	STRETCH
4:3 aspect ratio	SVGA (800 × 600)	1024 × 768	768 × 576	1024 × 576
	XGA (1024 × 768)			
	SXGA (1152 × 864)			
	SXGA + (1400 × 1050)			
Other aspect ratios	SXGA (1280 × 1024)	-	-	
	WXGA (1280 × 768)			

Input Signal		Output screen image		
Computer	Image type	NORMAL	BORDER	STRETCH
Resolution lower than XGA				
XGA	 4:3 aspect ratio			
Resolution higher than XGA				
SXGA (1280×1024)	 5:4 aspect ratio			
WXGA	 16:9 aspect ratio	—	—	











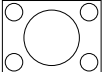

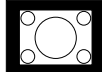
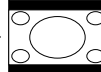
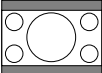
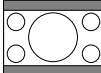
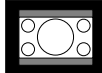
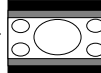
\* Mode for projecting an image with the original aspect ratio without cutting any portions.

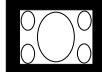
 : Cutout area on which images cannot be projected.

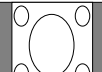
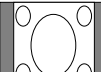

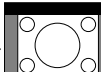
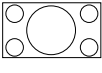
# VIDEO

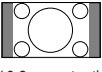
- “STRETCH” is fixed when 540P, 720P, 1035I or 1080I signals are entered.

Input Signal		Output screen image		
DVD / Video	Image type	NORMAL	BORDER	STRETCH
480I, 480P, 576I, 576P, NTSC, PAL, SECAM	 4:3 aspect ratio	* 	* 	
	 Letter box	* 	* 	
	 Squeezed 16:9 image			* 
	 Squeezed 4:3 image			* 
540P, 720P, 1035I, 1080I	 16:9 aspect ratio	—	—	* 
	 16:9 aspect ratio (4:3 aspect ratio in 16:9)	—	—	* 

\* Mode for projecting an image with the original aspect ratio without cutting any portions.

 : Cutout area on which images cannot be projected.

 : Area on which the image is not included in the original signals.

# Operating with the Remote Control

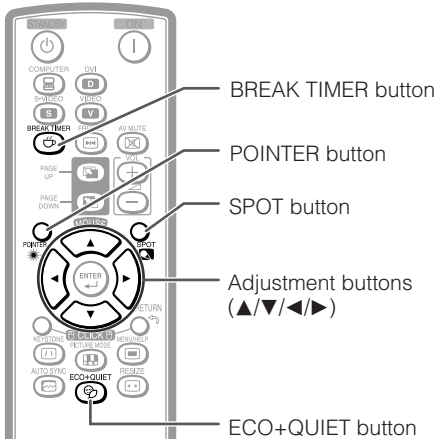

## Displaying and Setting the Break Timer

- 1 Press **BREAK TIMER**.
  - The timer starts to count down from 5 minutes.

On-screen display



- 2 Press ▲/▼/◀/▶ to adjust the length of the break time.
  - **Increases with ▲ or ▶**  
5 minutes → 6 minutes → 60 minutes
  - **Shortens with ◀ or ▼**  
4 minutes → 3 minutes → 1 minute
  - The break time can be set in units of one minute (up to 60 minutes).

Canceling the break timer display function

Press **BREAK TIMER**.

### Note

- Break Timer does not function while the projector is operating the "Auto Sync", "FREEZE" or "AV MUTE" functions.

## Displaying the Pointer

- 1 Press **POINTER** and press ▲/▼/◀/▶ on the remote control to move the pointer.
- 2 Press **POINTER** again.
  - The pointer will disappear.

## Using the Spot Function

- 1 Press **SPOT** and press ▲/▼/◀/▶ on the remote control to move the spot area.
- 2 Press **SPOT** again.
  - The spot area will disappear.

## Switching the Eco+Quiet Mode

Press **ECO+QUIET** on the remote control or on the projector to switch the Eco+Quiet mode between on and off.

- When the Eco+Quiet Mode is set to "ON", the sound of the cooling fan will turn down, the power consumption will decrease, and the lamp life will extend.

### Note

- Refer to "Lamp Setting" on page 40 for details of the Eco+Quiet mode.

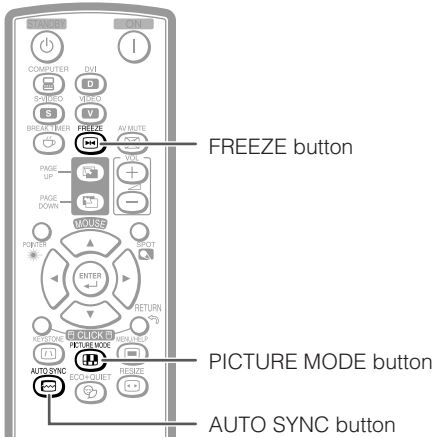

## Selecting the Picture Mode

You can select the appropriate picture mode for the projected image, such as movie or video game.

### Press **PICTURE MODE**.

- When pressing **PICTURE MODE**, the picture mode changes in the following order:

STANDARD → PRESENTATION → MOVIE → GAME → sRGB\*

### Note

- See page 39 for details on the picture mode.

\* "sRGB" is displayed only when RGB signal is input.

## Auto Sync (Auto Sync Adjustment)

Auto Sync function works when detecting input signal after the projector turns on.

Press **AUTO SYNC** to manually adjust with Auto Sync function.

### Note

- When the optimum image cannot be achieved with Auto Sync adjustment, use the help menu for manual adjustments. (See page 46.)

## Freezing a Moving Image

- Press **FREEZE**.
  - The projected image is frozen.
- Press **FREEZE** again to return to the moving image from the currently connected device.

# Operating with the Remote Control (Continued)

## Using the Remote Control as the Wireless Computer Mouse

When connecting the projector and the computer with a USB cable, you can use the remote control as the computer mouse.

If the computer is placed too far away from the projector to be connected via the USB cable, the remote receiver (optional, AN-MR2) makes it possible to operate the projector with the remote control. For details, see the operation manual of the receiver.

### Connecting with a USB cable

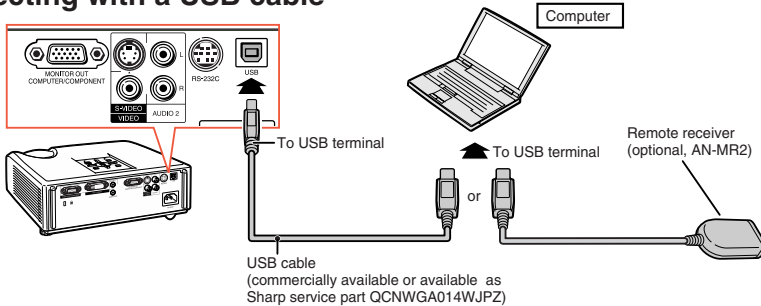

The mouse pointer can be operated in the following way after it is connected.

- **When moving the cursor**  
Press MOUSE/Adjustment buttons (▲/▼/◀/▶).
- **When left-clicking**  
Press **L-CLICK**.
- **When right-clicking**  
Press **R-CLICK**.
- **When your computer supports only a one-click mouse (such as Macintosh)**  
Press **L-CLICK** or **R-CLICK**.  
**L-CLICK** and **R-CLICK** have common function.
- **When using [Page Up] or [Page Down]**  
Same as the [Page Up] and [Page Down] keys on a computer keyboard.  
Press **PAGE UP** or **PAGE DOWN**.

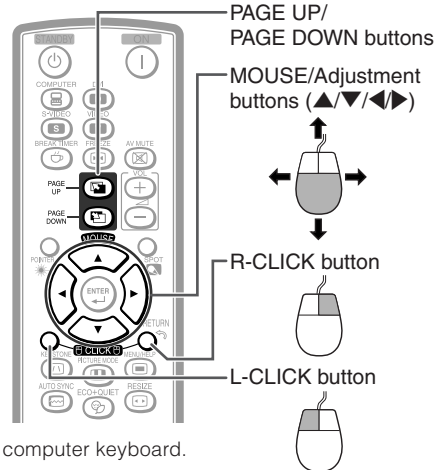

#### Note

- This function only works with the Microsoft® Windows® OS and Mac OS®. However, this function does not work with the following operation systems that do not support USB.
  - Versions earlier than Windows® 95
  - Versions earlier than Windows® NT4.0
  - Versions earlier than Mac OS® 8.5
- You cannot use this function when displaying the menu screen.
- Confirm that the computer recognizes the USB connection.

# Menu Items

The following shows the items that can be set in the projector.

## “Picture” menu

### COMPUTER (RGB), DVI (RGB) input

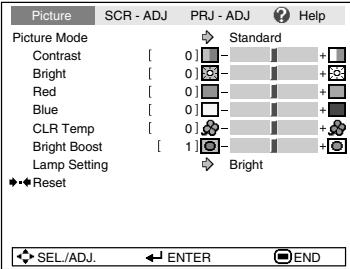

### COMPUTER (Component), DVI (Component), S-VIDEO, VIDEO input

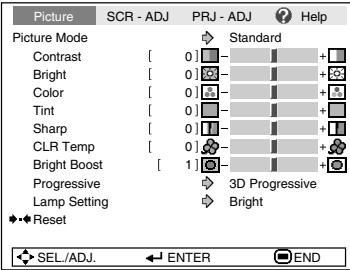

## “Screen adjustment (SCR-ADJ)” menu

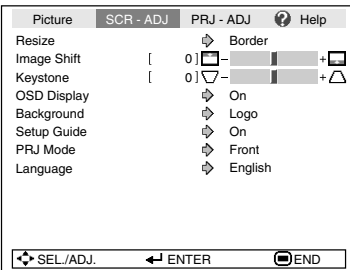

\*1 Items when inputting RGB signal through COMPUTER or DVI.

\*2 Items when inputting component signal through COMPUTER or DVI, or when selecting S-VIDEO or VIDEO.

\*3 “Tone” will appear on the menu screen only when PAL or SECAM signals are input (including when forcibly changed to those input signals). There is basically no need to adjust “Tone”, but you can adjust the picture tone with this adjustment when inputting PAL or SECAM signals.

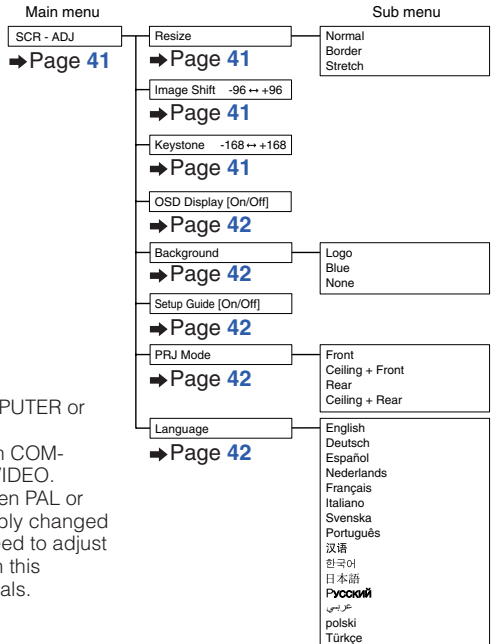
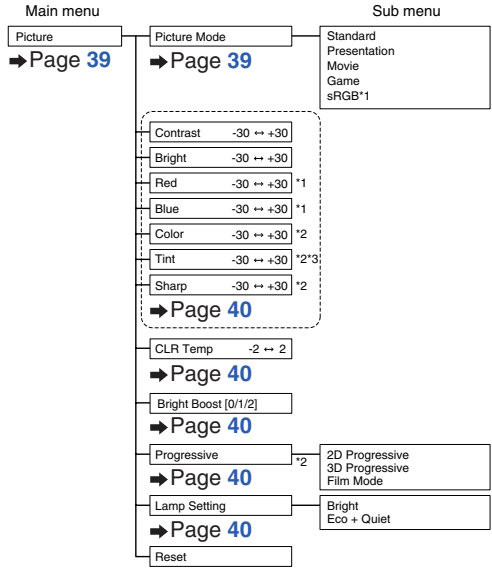

# Menu Items (Continued)

## “Projector adjustment (PRJ-ADJ)” menu

Picture	SCR - ADJ	PRJ - ADJ	Help
Auto Power Off	⇒	On	
Auto Restart	⇒	On	
STANDBY Mode	⇒	Standard	
System Sound	⇒	On	
Speaker	⇒	On	
Audio Input	⇒	Audio 1	
RS-232C	⇒	9600bps	
Fan Mode	⇒	Normal	
System Lock	⇒	Disable	
Lamp Timer(Life) [ 0 ]h [ 0 ]min ( 100% )			
⇐SEL./ADJ.    ← ENTER    END			

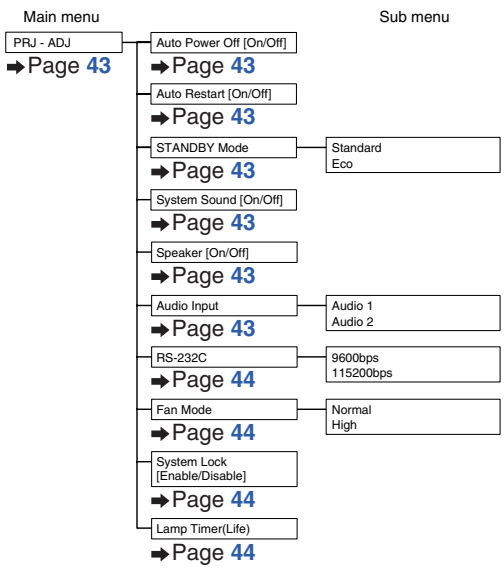

## “Help” menu

Picture	SCR - ADJ	PRJ - ADJ	Help
<ul style="list-style-type: none"> <li>• There is no picture or audio</li> <li>• Vertical stripes or flickering image appear</li> <li>• Data image is not centered</li> <li>• Color is faded or poor</li> <li>• Picture is dark</li> <li>• The image is distorted</li> </ul>			
<ul style="list-style-type: none"> <li>• Reset all adjustments to default settings</li> </ul>			
⇐SEL.    ← ENTER    END			

## The items you can set with the “Help” menu

- “Help” menu → Page 46
- Vertical stripes or flickering image appear
    - Auto Sync
    - Clock
    - Phase
  - Data image is not centered
    - Auto Sync
    - H-Pos
    - V-Pos
  - Color is faded or poor
    - COMPUTER/COMPONENT or DVI input
      - Signal type: Auto/RGB/Component
    - S-VIDEO or VIDEO input
      - Video System: Auto/PAL/SECAM/NTSC3.58/NTSC4.43/PAL-M/PAL-N/PAL-60
    - DVI (Digital) input
      - Dynamic range: Auto/Standard/Enhanced
- \* The selectable items vary depending on the input signal and the selected input mode.

# Using the Menu Screen

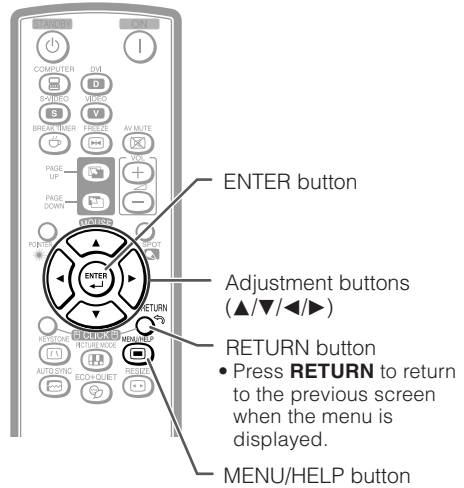
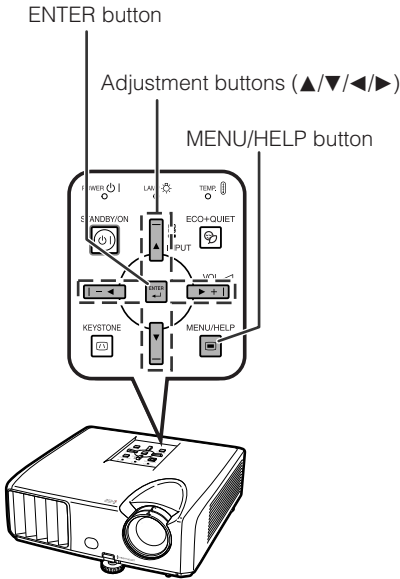

## Menu Selections (Adjustments)

Example: Adjusting “Bright”.

- This operation can also be performed by using the buttons on the projector.

**1 Press MENU/HELP.**

- The “Picture” menu screen for the selected input mode is displayed.

**2 Press ▶ or ◀ and select “Picture” to adjust.**

Example: “Picture” screen menu for COMPUTER (RGB) input

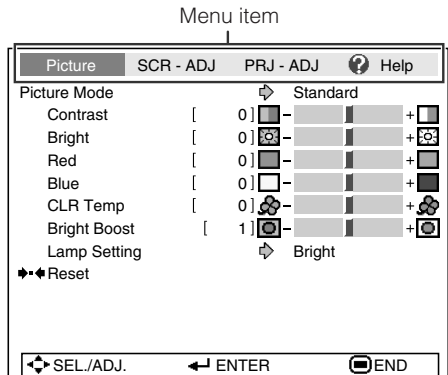

# Using the Menu Screen (Continued)

## 3 Press ▲ or ▼ and select “Bright” to adjust.

- The selected item is highlighted.

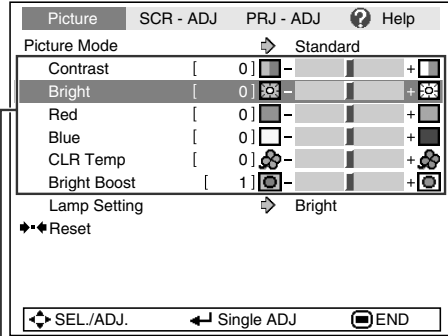

## To adjust the projected image while watching it Press ENTER.

- The selected item (e.g. “Bright”) is displayed by itself at the bottom of the screen.
- When pressing ▲ or ▼, the following item (“Red” after “Bright”) will be displayed.

### Note

- Press **ENTER** again to return to the previous screen.

Items to be adjusted

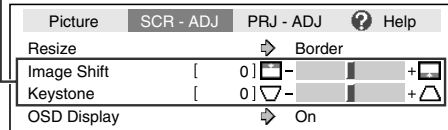

↑ ↓ Press ENTER.

The item displayed by itself

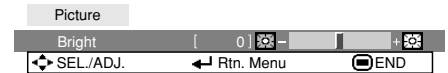

## 4 Press ◀ or ▶ to adjust the item selected.

- The adjustment is stored.

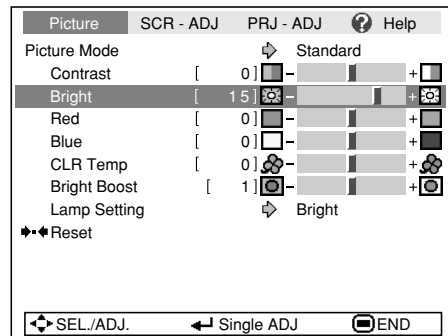

## 5 Press MENU/HELP.

- The menu screen will disappear.

### Note

- Menu buttons do not function while the projector is operating the “Auto Sync”, “Break Timer”, “FREEZE”, or “AV MUTE” functions.



# Picture Adjustment (“Picture” Menu)

Menu operation → Page 37

▶ Example: “Picture” screen menu for COMPUTER (RGB) input

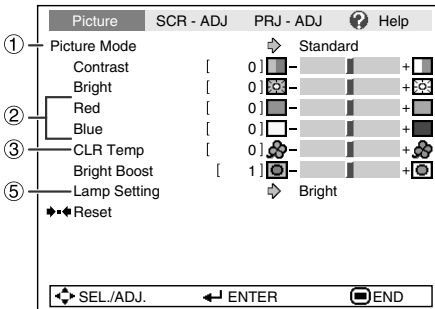

▶ Example: “Picture” screen menu for S-VIDEO input

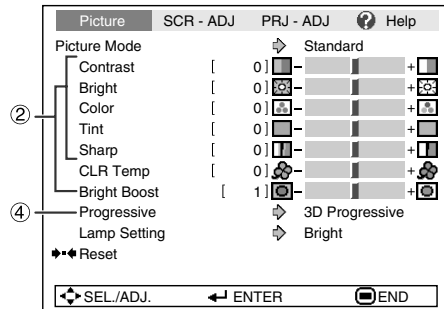

## 1 Selecting the Picture Mode

Selectable items	Description	The default settings of each item when selecting Picture Mode		
		CLR Temp	Bright Boost	Lamp Setting
Standard	For standard image	0	1	Bright
Presentation	Brightens portions of image for more enhanced presentations.	0	2	Bright
Movie	Gives natural tint to the projected image.	-1	0	Eco + Quiet
Game	Gives sharpness to the projected image.	0	1	Bright
*sRGB	For high fidelity reproduction of images from a computer.	-	-	Bright

- “sRGB” is displayed only when RGB signal is input.
- You can set or adjust each item in the “Picture” menu to your preference. Any changes you make are retained in memory.

### Note

- You can also press **PICTURE MODE** on the remote control to select the picture mode. (See page 33.)
- \*sRGB is an international standard of color reproduction regulated by the IEC (International Electrotechnical Commission). As the fixed color area has been decided by the IEC, the images are displayed in a natural tint based on an original image, when “sRGB” is selected. For additional information about the sRGB function, visit “<http://www.srgb.com/>”. You cannot set the items, “Red”, “Blue”, “CLR Temp”, “Bright Boost”, when “sRGB” is selected.

### Info

- When “sRGB” is selected, the projected image may become dark, but this does not indicate a malfunction.

# Picture Adjustment (“Picture” Menu) (Continued)

Menu operation → Page 37

## ② Adjusting the Image

Adjustment items	◀ button	▶ button
Contrast	For less contrast.	For more contrast.
Bright	For less brightness.	For more brightness.
Red*1	For weaker red.	For stronger red.
Blue*1	For weaker blue.	For stronger blue.
Color*2	For less color intensity.	For more color intensity.
Tint*2 *3	For making skin tones purplish.	For making skin tones greenish.
Sharp*2	For less sharpness.	For more sharpness.
Bright Boost*1	For high fidelity color reproduction.	For more vividness.

\*1 Not adjustable/selectable when selecting “sRGB”.

\*2 Not displayed in the RGB input mode.

\*3 “Tone” will appear on the menu screen only when PAL or SECAM signals are input (including when forcibly changed to those input signals). There is basically no need to adjust “Tone”, but you can adjust the picture tone with this adjustment when inputting PAL or SECAM signals.

### Note

- “Bright Boost” and “CLR Temp” cannot be set when “sRGB” is selected.
- To reset all adjustment items, select “Reset” and press **ENTER**.

## ③ Adjusting the Color Temperature

Selectable items	Description
-2 -1 0 1 2	For lower color temperature for warmer, reddish incandescent-like images. ↑↓ For higher color temperature for cooler, bluish, fluorescent-like images.

### Note

- Values on “CLR Temp” are only for general standard purposes.

## ④ Progressive

Selectable items	Description
2D Progressive	Useful to display fast-moving images such as sports.
3D Progressive	Useful to display relatively slow-moving images such as drama and documentary more clearly.
Film Mode	Reproduces the image of film source* clearly. Displays the optimized image of film transformed with three-two pull down (NTSC and PAL60Hz) or two-two pull down (PAL50Hz and SECAM) enhancement to progressive mode images.

\* The film source is a digital video recording with the original encoded as is at 24 frames/second. The projector can convert this film source to progressive video at 60 frames/second with NTSC and PAL60Hz or at 50 frames/second with PAL50Hz and SECAM to play back a high-definition image.

### Note

- In NTSC or PAL60Hz, even if the 3D Progressive mode has been set, the three-two pull down enhancement will be enabled automatically when the film source has been entered.
- When the image is blurred or noisy, switch to the optimal mode.
- When using progressive inputs, inputs are directly displayed so that 2D Progressive, 3D Progressive and Film Mode cannot be selected.

## ⑤ Lamp Setting

Selectable items	Brightness and Power consumption
Eco + Quiet	Approx. 80%
Bright	100%

### Note

- In the Eco + Quiet mode, the fan sound and power consumption are lower than those in the Bright mode. (Projection brightness decreases as shown in the chart.) The lamp life will be approximately 3,000 hours (approximately 2,000 hours in the Bright mode).

# Adjusting the Projected Image (“SCR - ADJ” Menu)

Menu operation → Page 37

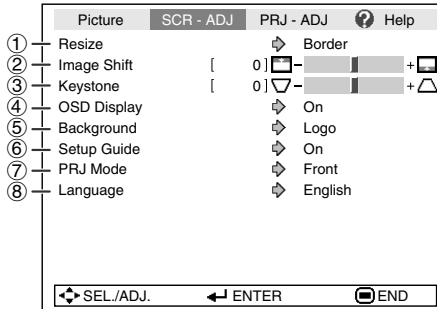

## ① Setting the Resize Mode

### Note

- For details of the Resize mode, see pages 30 and 31.
- You can also press **RESIZE** on the remote control to set the resize mode. (See page 30.)

## ② Adjusting the Image Position

You can move the projected image vertically.

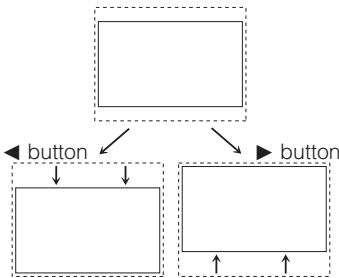

### Note

- You cannot set this item when “Resize” is set to “Normal”.

## ③ Keystone Correction

When the image is projected either from the top or from the bottom towards the screen at an angle, the image becomes distorted trapezoidally. The function for correcting trapezoidal distortion is called Keystone Correction.

Select “Keystone” on the “SCR-ADJ” menu and adjust with the slide bar.

See page 28 for details of Keystone Correction.

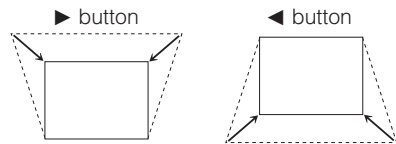

### Note

- The Keystone Correction can be adjusted up to an angle of approximately  $\pm 20$  degrees (when “Resize” is set to “Normal”).
- You can also press **KEYSTONE** on the remote control or on the projector to adjust Keystone Correction.

# Adjusting the Projected Image (“SCR - ADJ” Menu) (Continued)

Menu operation → Page 37

## ④ Setting the On-screen Display

Selectable items	Description
On	All on-screen displays are displayed.
Off	INPUT/VOLUME/AV MUTE/FREEZE/AUTO SYNC/RESIZE/PICTURE MODE/“An invalid button has been pressed.” are not displayed.

## ⑦ Reversing/Inverting Projected Images

Selectable items	Description
Front	Normal image (Projected from the front of the screen)
Ceiling + Front	Inverted image (Projected from the front of the screen with an inverted projector)
Rear	Reversed image (Projected from the rear of the screen or with a mirror)
Ceiling + Rear	Reversed and inverted image (Projected with a mirror)

See page 19 for details of Projection (PRJ) Mode.

## ⑤ Selecting the Background Image

Selectable items	Description
Logo	Sharp logo screen
Blue	Blue screen
None	—

## ⑧ Selecting the On-screen Display Language

The projector can switch the on-screen display language among 15 languages.

- English
- Deutsch
- Español
- Nederlands
- Français
- Italiano
- Svenska
- Português
- 汉语
- 한국어
- 日本語

- ▲
- Русский
- عربي
- polski
- Türkçe

## ⑥ Selecting the Setup Guide

Selectable items	Description
On	Displaying the Setup Guide when turning the projector on.
Off	Not displaying the Setup Guide.

# Adjusting the Projector Function (“PRJ - ADJ” Menu)

Menu operation → Page 37

	Picture	SCR - ADJ	PRJ - ADJ	Help
①	Auto Power Off		➡ On	
②	Auto Restart		➡ On	
③	STANDBY Mode		➡ Standard	
④	System Sound		➡ On	
⑤	Speaker		➡ On	
⑥	Audio Input		➡ Audio 1	
⑦	RS-232C		➡ 9600 bps	
⑧	Fan Mode		➡ Normal	
⑨	System Lock		➡ Disable	
⑩	Lamp Timer(Life) [ 0 ] h [ 0 ] min ( 100% )			

## ① Auto Power Off Function

Selectable items	Description
On	When no input signal is detected for more than 15 minutes, the projector will automatically enter standby mode.
Off	The Auto Power Off function will be disabled.

### Note

- When the Auto Power Off function is set to “On”, 5 minutes before the projector enters standby mode, the message “Enter STANDBY mode in X min.” will appear on the screen to indicate the remaining minutes.

## ② Auto Restart Function

Selectable items	Description
On	If the power cord is unplugged from the outlet or the breaker switch is turned off when the projector is on, then the projector automatically turns on when the power cord is plugged into the AC outlet or the breaker switch is turned on.
Off	The projector does not turn on automatically when the power cord is plugged into the AC outlet or the breaker switch is turned on.

## ③ STANDBY Mode

When set to “Eco”, power consumption is reduced in standby mode.

Selectable items	Description
Eco	The monitor output and RS-232C functions are switched off in standby mode.
Standard	The monitor output and RS-232C functions are activated even if the projector is in standby mode.

## ④ Setting the Confirmation Sound (System Sound)

Selectable items	Description
On	A confirmation sound is made when the projector turns on/off.
Off	No confirmation sound is made.

## ⑤ Speaker Setting

Selectable items	Description
On	The audio signal is output from the internal speaker.
Off	The audio signal is not output from the internal speaker.

## ⑥ Audio Input

This function allows you to select an appropriate combination of audio input terminals for each input mode.

Selectable items	Description
Audio 1	The AUDIO 1 input terminal is used as an audio input terminal.
Audio 2	The AUDIO 2 input terminal is used as an audio input terminal.

# Adjusting the Projector Function (“PRJ - ADJ” Menu) (Continued)

Menu operation → Page 37

## ⑦ Selecting the Transmission Speed (RS-232C)

Make sure that both the projector and computer are set for the same baud rate.

Selectable items	Description
9600bps	Transmission speed is slow.
	
115200bps	Transmission speed is rapid.

## ⑧ Fan Mode Setting

This function changes the fan rotation speed.

Selectable items	Description
Normal	Suitable for normal environments.
High	Select this when using the projector at altitudes of approximately 1,500 meters (4,900 feet) or more.

When “Fan Mode” is set to “High”, the fan rotation speeds up, and the fan noise becomes louder.

## ⑩ Checking the Lamp Life Status

You can confirm the cumulative lamp usage time and the remaining lamp life (percentage).

Lamp usage condition	Remaining lamp life		
	“Life”	100%	5%
Operated exclusively with Lamp Setting set to “Eco +Quiet”	Approx. 3,000 hours	Approx. 150 hours	Approx. 150 hours
Operated exclusively with Lamp Setting set to “Bright”	Approx. 2,000 hours	Approx. 100 hours	Approx. 100 hours

### Note

- It is recommended that the lamp be changed when the remaining lamp life becomes 5%.
- The lamp life may vary depending on the usage condition.

## ⑨ System Lock Function

This function prevents unauthorized use of the projector. Once this function is activated, users must enter the correct keycode each time the projector is turned on. **We suggest you record the keycode in a safe place where only authorized users have access.**

### Info

- If you lose or forget your keycode, contact your nearest Sharp Authorized Projector Dealer or Service Center (see page 64). Even if the product warranty is valid, the keycode reset will incur a charge.

## ■ Setting/Changing the keycode

- 1** Select “System Lock”, then press **ENTER** or **▶**.
- 2** Select “Next”, then press **ENTER**.
  - The screen for entering the keycode appears.
- 3** Press the 4 buttons on the remote control or on the projector to enter the preset keycode in “Old Code”.
  - When setting the keycode for the first time, press **▼** on the projector for four times.

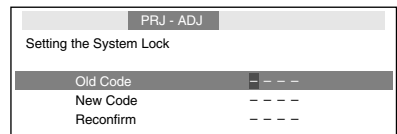

### Note

- If you input a wrong keycode, the cursor returns to the first point of the “Old Code”.
- The preset keycode is 4 **▼** buttons on the projector. When you press the **▼** button four times, the keycord input screen disappears.

**4** Press the 4 buttons on the remote control or on the projector to enter the new keycode in “New Code”.

 **Note**

- You cannot use the following buttons for keycode:
  - STANDBY/ON
  - ON
  - STANDBY
  - ENTER
  - L-CLICK
  - R-CLICK/RETURN
  - MENU/HELP
- System lock function recognizes each button on the remote control or on the projector as an individual button, even if they share the same button name. If you used the buttons on the projector in setting your keycode, the keycode cannot be canceled with the remote control.

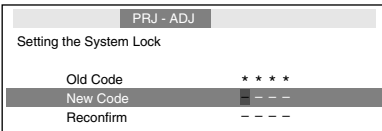

**5** Enter the same keycode in “Reconfirm”.

 **Note**

To cancel the keycode that you have already set

- Press ▼ on the projector for four times in steps 4 and 5 above.

When the System Lock is set

- When System Lock is set, the keycode input screen appears after the power is turned on. When it appears, enter the right keycode to start projection.

Input screen for keycode

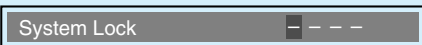

## Keylock Function

### Locking the Operation Buttons on the Projector

Use this function to lock the operation buttons on the projector.

#### Locking the Operation Buttons

Hold down **ENTER** on the projector for about 5 seconds while the projector is being turned on.

On-screen display

Keylock function ON

- The keylock function does not affect the operation with the remote control buttons.
- You cannot use the keylock function while the projector is warming up.

#### Taking the Keylock off

Hold down **ENTER** on the projector for about 5 seconds.

On-screen display

Keylock function OFF

- When the projector is in standby mode, you can release the keylock by holding down **ENTER** and **STANDBY/ON** on the projector simultaneously for about 5 seconds.

 **Info**

- Keylock cannot be set while the projector is: displaying the “Setup Guide” or “Menu” screens, in standby mode, warming up, changing input signals, operating “Auto Sync” function, in “FREEZE” mode or on the “System Lock” screen during warming up.

# Troubleshooting with the “Help” Menu

This function advises you to solve the problems during usage.

## Utilizing the “Help” Menu Functions

Example: When image flickering appears  
Operation to solve image flickering when projecting the computer RGB signal.

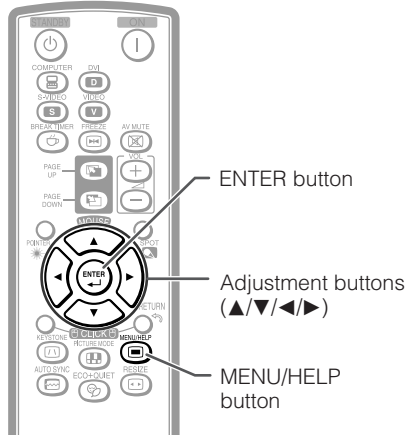

**1** Press **MENU/HELP**.

**2** Press **◀** or **▶** to select “Help”, then press **ENTER**.

**3** Press **▲** or **▼** to select “Vertical stripes or flickering image appears” on Help menu, then press **ENTER**.

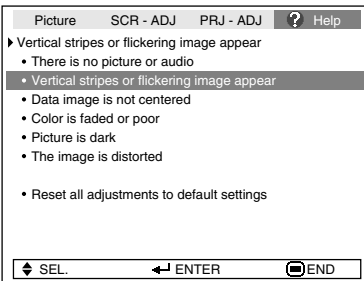

↓ Press **ENTER**.

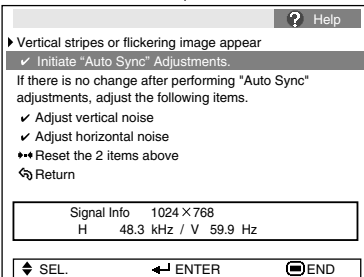

**4** Select “Initiate “Auto Sync” Adjustments”, then press **ENTER**.

**5** If the image is not improved, select “Adjust horizontal noise”, then press **ENTER**.

**6** Press **◀** or **▶** to adjust.

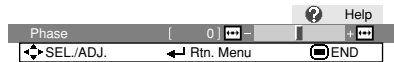

### Note

- You can adjust the items with check marks (✓).
- The items in the “Help” menu change, depending on the input signal or setting that you have selected.
- If the problem is not solved, refer to “Troubleshooting” (see pages 62 and 63).
- When selecting “sRGB” in “Picture Mode”, the item “Color is faded or poor” is not displayed. This means you cannot change input signal types.



# Maintenance

## Cleaning the projector

- Ensure that you have unplugged the power cord before cleaning the projector.
- The cabinet as well as the operation panel is made of plastic. Avoid using benzene or thinner, as these can damage the finish on the cabinet.
- Do not use volatile agents such as insecticides on the projector.  
Do not attach rubber or plastic items to the projector for long periods.  
The effects of some of the agents in the plastic may cause damage to the quality or finish of the projector.
- Wipe off dirt gently with a soft flannel cloth.
- When the dirt is hard to remove, soak a cloth in a mild detergent diluted with water, wring the cloth well and then wipe the projector. Strong cleaning detergents may discolor, warp or damage the coating on the projector. Make sure to test on a small, inconspicuous area on the projector before use.

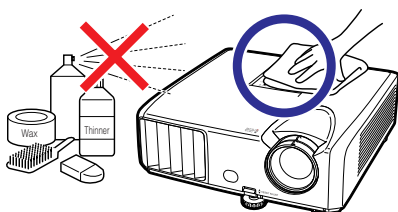

## Cleaning the lens

- Use a commercially available blower or lens cleaning paper (for glasses and camera lenses) for cleaning the lens. Do not use any liquid type cleaning agents, as they may wear off the coating film on the surface of the lens.
- As the surface of the lens can easily get damaged, be careful not to scrape or hit the lens.

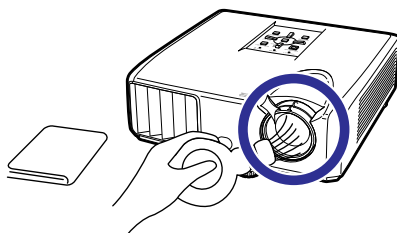

## Cleaning the exhaust and intake vents

- Use a vacuum cleaner to clean dust from the exhaust vent and the intake vent.

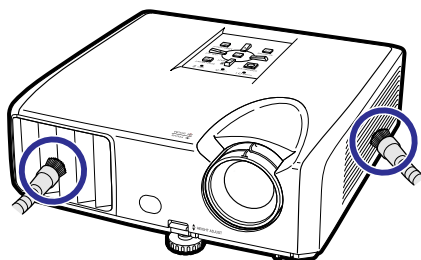

## Info

- If you want to clean the air vents during projector operation, ensure you press **STANDBY/ON** on the projector or **STANDBY** on the remote control and put the projector into standby mode. After the cooling fan has stopped, clean the vents.

# Maintenance Indicators

- The warning lights (power indicator, lamp indicator and temperature warning indicator) on the projector indicate problems inside the projector.
- If a problem occurs, either the temperature warning indicator or the lamp indicator will illuminate red, and the projector will enter standby mode. After the projector has entered standby mode, follow the procedures given below.

## Top View

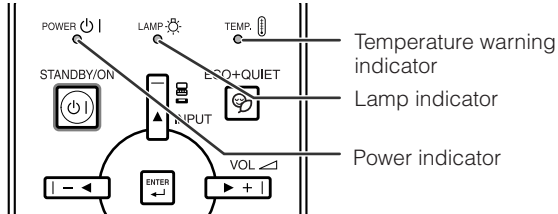

### About the temperature warning indicator



If the temperature inside the projector increases, due to blockage of the air vents, or the setting location, "TEMP." will illuminate in the lower left corner of the picture. If the temperature keeps on rising, the lamp will turn off and the temperature warning indicator will blink, the cooling fan will run, and then the projector will enter standby mode. After "TEMP." appears, ensure you perform the measures described on page 49.

### About the lamp indicator



■ When the remaining lamp life becomes 5% or less, (yellow) and "Change The Lamp" will be displayed on the screen. When the percentage becomes 0%, it will change to (red), the lamp will automatically turn off and then the projector will automatically enter standby mode. At this time, the lamp indicator will illuminate in red.

■ **If you try to turn on the projector a fourth time without replacing the lamp, the projector will not turn on.**

### Indicators on the Projector

Power indicator	Red on	Normal (Standby)
	Green on	Normal (Power on)
	Red blinks	Abnormal (See page 49.)
	Green blinks	Normal (Cooling)
Lamp indicator	Green on	Normal
	Green blinks	The lamp is warming up.
	Red on	The lamp is shut down abnormally or requires to be changed. (See page 49.)
Temperature warning indicator	Off	Normal
	Red on	The internal temperature is abnormally high. (See page 49.)

	Maintenance indicator		Problem	Cause	Possible Solution
	Normal	Abnormal			
Temperature warning indicator	Off	Red on (Standby)	The internal temperature is abnormally high.	<ul style="list-style-type: none"> <li>Blocked air intake</li> </ul>	<ul style="list-style-type: none"> <li>Relocate the projector to an area with proper ventilation. (See page 8.)</li> </ul>
				<ul style="list-style-type: none"> <li>Cooling fan breakdown</li> <li>Internal circuit failure</li> <li>Clogged air intake</li> </ul>	<ul style="list-style-type: none"> <li>Take the projector to your nearest Sharp Authorized Projector Dealer or Service Center (see page 64) for repair.</li> </ul>
Lamp indicator	Green on (Green blinks when the lamp is warming up or turning off.)	Red on	The lamp does not illuminate.	<ul style="list-style-type: none"> <li>The lamp is shut down abnormally.</li> </ul>	<ul style="list-style-type: none"> <li>Disconnect the power cord from the AC outlet, and then connect it again.</li> </ul>
			Time to change the lamp.	<ul style="list-style-type: none"> <li>Remaining lamp life becomes 5% or less.</li> </ul>	<ul style="list-style-type: none"> <li>Carefully replace the lamp. (See page 51.)</li> <li>Take the projector to your nearest Sharp Authorized Projector Dealer or Service Center (see page 64) for repair.</li> <li>Please exercise care when replacing the lamp.</li> <li>Securely install the cover.</li> </ul>
		Red on (Standby)	The lamp does not illuminate.	<ul style="list-style-type: none"> <li>Burnt-out lamp</li> <li>Lamp circuit failure</li> </ul>	
Power indicator	Green on/Red on  Green blinks (Cooling)	Red blinks	The power indicator blinks in red when the projector is on.	<ul style="list-style-type: none"> <li>The lamp unit cover is open.</li> </ul>	<ul style="list-style-type: none"> <li>If the power indicator blinks in red even when the lamp unit cover is securely installed, contact your nearest Sharp Authorized Projector Dealer or Service Center (see page 64) for advice.</li> </ul>

### Info

- If the temperature warning indicator illuminates, and the projector enters standby mode, follow the possible solutions above and then wait until the projector has cooled down completely before plugging in the power cord and turning the power back on. (At least 10 minutes.)
- If the power is turned off for a brief moment due to power outage or some other cause while using the projector, and the power supply recovers immediately after that, the lamp indicator will illuminate in red and the lamp may not be lit. In this case, unplug the power cord from the AC outlet, replace the power cord in the AC outlet and then turn the power on again.
- The cooling fan keeps the internal temperature of the projector constant and this function is controlled automatically. The sound of the cooling fan may change during operation because the fan speed may change and this is not a malfunction.

# Regarding the Lamp

## Lamp

- It is recommended that the lamp (sold separately) be replaced when the remaining lamp life becomes 5% or less, or when you notice a significant deterioration in the picture and color quality. The lamp life (percentage) can be checked with the on-screen display. (See page 44.)
- Purchase a replacement lamp of type AN-XR30LP from your place of purchase, nearest Sharp Authorized Projector Dealer or Service Center.

### IMPORTANT NOTE TO U.S. CUSTOMERS:

The lamp included with this projector is backed by a 90-day parts and labor limited warranty. All service of this projector under warranty, including lamp replacement, must be obtained through a Sharp Authorized Projector Dealer or Service Center. For the name of the nearest Sharp Authorized Projector Dealer or Service Center, please call toll-free: 1-888-GO-SHARP (1-888-467-4277).

**Hg LAMP CONTAINS MERCURY** For State Lamp Disposal Information

[www.lamprecycle.org](http://www.lamprecycle.org) or 1-800-BE-SHARP

U.S.A. ONLY

## Caution Concerning the Lamp

- This projector utilizes a pressurized mercury lamp. A loud sound may indicate lamp failure. Lamp failure can be attributed to numerous sources such as: excessive shock, improper cooling, surface scratches or deterioration of the lamp due to a lapse of usage time.  
The period of time up to failure largely varies depending on the individual lamp and/or the condition and the frequency of use. It is important to note that failure can often result in the bulb cracking.
- When the lamp replacement indicator and on-screen display icon are illuminated, it is recommended that the lamp be replaced with a new one immediately, even if the lamp appears to be operating normally.
- Should the lamp break, there is also a possibility that glass particles may spread inside of the projector. In such a case, it is recommended you contact your nearest Sharp Authorized Projector Dealer or Service Center to assure safe operation.
- Should the lamp break, the glass particles may spread inside the lamp cage or gas contained in the lamp may be vented into the room from the exhaust vent. Because the gas in this lamp includes mercury, ventilate the room well if the lamp breaks and avoid all exposure to the released gas. In case of exposure to the gas, consult a doctor as soon as possible.

## Replacing the Lamp



### Caution

- Do not remove the lamp unit from the projector right after use. The lamp will be very hot and may cause burns or injury.
  - Wait at least one hour after the power cord is disconnected to allow the surface of the lamp unit to fully cool before removing the lamp unit.
  - **Carefully change the lamp by following the instructions described in this section. \* If you wish, you may have the lamp replaced at your nearest Sharp Authorized Projector Dealer or Service Center.**
- \* If the new lamp does not light after replacement, take your projector to the nearest Sharp Authorized Projector Dealer or Service Center for repair.

## Removing and Installing the Lamp Unit

### Warning!

- Do not remove the lamp unit from the projector right after use. The lamp and parts around the lamp will be very hot and may cause burns or injury.

### Info

- Do not touch the glass surface of the lamp unit or the inside of the projector.
- To avoid injury to yourself and damage to the lamp, make sure you carefully follow the steps below.
- Do not loosen other screws except for the lamp unit cover and lamp unit.

- 1 Press **STANDBY/ON** on the projector or **STANDBY** on the remote control to put the projector into standby mode.**

- Wait until the cooling fan stops.

- 2 Disconnect the power cord.**
  - Unplug the power cord from the AC socket.
  - Leave the lamp until it has fully cooled down (about 1 hour).

- 3 Remove the lamp unit cover.**
  - Turn the projector over. Loosen the user service screw (①) that secures the lamp unit cover. Remove the lamp unit cover (②).

Optional  
accessory

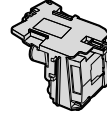

Lamp unit  
AN-XR30LP

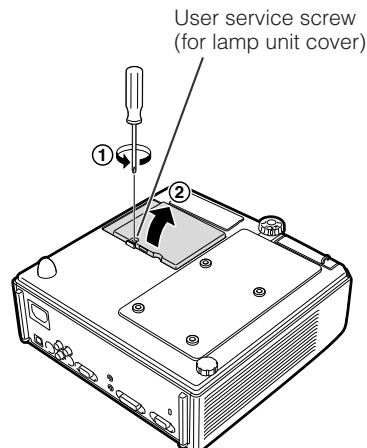
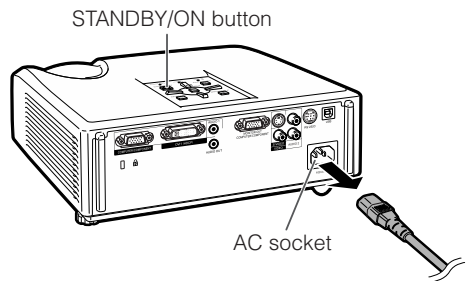

# Regarding the Lamp (Continued)

## 4 Remove the lamp unit.

- Loosen the securing screws from the lamp unit. Hold the lamp unit and pull it in the direction of the arrow. At this time, keep the lamp unit horizontal and do not tilt it.

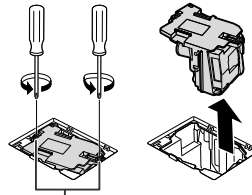

Securing screws

## 5 Insert the new lamp unit.

- Press the lamp unit firmly into the lamp unit compartment. Fasten the securing screws.

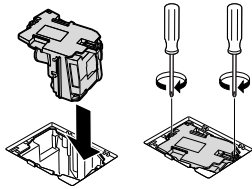

## 6 Replace the lamp unit cover.

- Align the tab on the lamp unit cover (1) and place it while pressing the tab (2) to close it. Then tighten the user service screw (3) to secure the lamp unit cover.

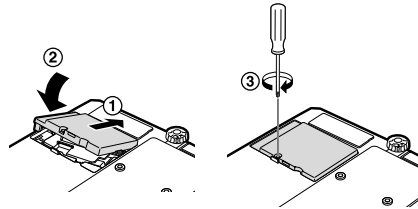

### Info

- If the lamp unit and lamp unit cover are not correctly installed, the power will not turn on, even if the power cord is connected to the projector.

## Resetting the Lamp Timer

Reset the lamp timer after replacing the lamp.

### Info

- Make sure to reset the lamp timer only when replacing the lamp. If you reset the lamp timer and continue to use the same lamp, this may cause the lamp to become damaged or explode.

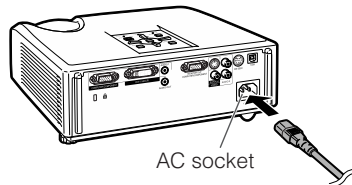

AC socket

## 1 Connect the power cord.

- Plug the power cord into the AC socket of the projector.

## 2 Reset the lamp timer.

- While simultaneously holding down **MENU/HELP**, **ENTER** and **▼** on the projector, press **STANDBY/ON** on the projector.
- "LAMP 0000H" is displayed, indicating that the lamp timer is reset.

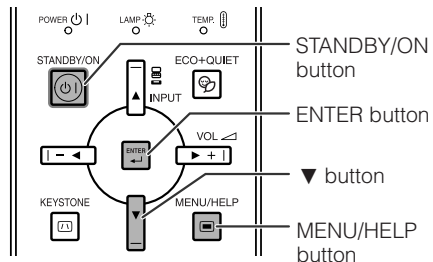

# Storing the Projector

## How to Use the Storage Case

When storing the projector, attach the lens cap to the lens, and place it in the supplied storage case.

**1** Open the cover of the storage case.

**2** Place the projector into the storage case.

### Info

- Ensure the projector has cooled down sufficiently before placing it in the case.
- Ensure the lens cap is attached to the lens for protection.
- **Place the projector into the storage case with the lens facing the handle.**
- Ensure the projector is held in place by using the fixing band.
- Do not expose the storage case to direct sunlight or near heat sources. The storage case may change color or become deformed.

**3** Close the cover of the storage case.

**4** Place the accessories in the front pocket of the storage case.

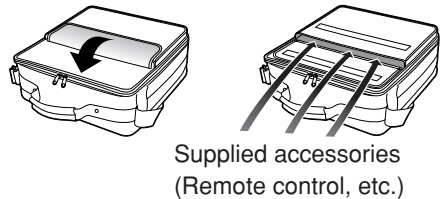
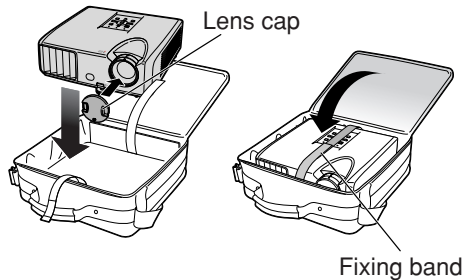
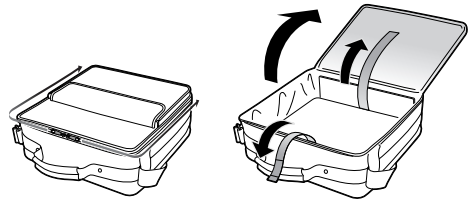

# Connecting Pin Assignments

**COMPUTER/COMPONENT input and COMPUTER/COMPONENT output Terminals:** mini D-sub 15 pin female connector

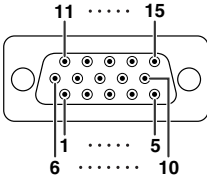

**COMPUTER Input/Output**

- | Pin No. | Signal                            |
|---------|-----------------------------------|
| 1.      | Video input (red)                 |
| 2.      | Video input (green/sync on green) |
| 3.      | Video input (blue)                |
| 4.      | Not connected                     |
| 5.      | Not connected                     |
| 6.      | Earth (red)                       |
| 7.      | Earth (green/sync on green)       |
| 8.      | Earth (blue)                      |
| 9.      | Not connected                     |
| 10.     | GND                               |
| 11.     | Not connected                     |
| 12.     | Bi-directional data               |
| 13.     | Horizontal sync signal: TTL level |
| 14.     | Vertical sync signal: TTL level   |
| 15.     | Data clock                        |

**COMPONENT Input/Output**

- | Pin No. | Signal        |
|---------|---------------|
| 1.      | PR (CR)       |
| 2.      | Y             |
| 3.      | PB (CB)       |
| 4.      | Not connected |
| 5.      | Not connected |
| 6.      | Earth (PR)    |
| 7.      | Earth (Y)     |
| 8.      | Earth (PB)    |
| 9.      | Not connected |
| 10.     | Not connected |
| 11.     | Not connected |
| 12.     | Not connected |
| 13.     | Not connected |
| 14.     | Not connected |
| 15.     | Not connected |

**DVI-I Terminal:** 29 pin connector

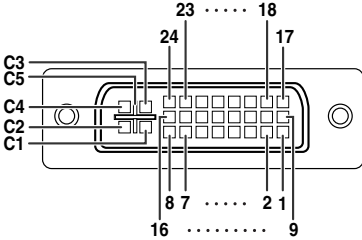

**• DVI Digital Input**

- | Pin No. | Signal                |
|---------|-----------------------|
| 1.      | T.M.D.S data 2-       |
| 2.      | T.M.D.S data 2+       |
| 3.      | T.M.D.S data 2 shield |
| 4.      | Not connected         |
| 5.      | Not connected         |
| 6.      | DDC clock             |
| 7.      | DDC data              |
| 8.      | Not connected         |
| 9.      | T.M.D.S data 1-       |
| 10.     | T.M.D.S data 1+       |
| 11.     | T.M.D.S data 1 shield |
| 12.     | Not connected         |
| 13.     | Not connected         |
| 14.     | +5V power             |
| 15.     | Ground                |

- | Pin No. | Signal                |
|---------|-----------------------|
| 16.     | Hot plug detection    |
| 17.     | T.M.D.S data 0-       |
| 18.     | T.M.D.S data 0+       |
| 19.     | T.M.D.S data 0 shield |
| 20.     | Not connected         |
| 21.     | Not connected         |
| 22.     | T.M.D.S clock shield  |
| 23.     | T.M.D.S clock+        |
| 24.     | T.M.D.S clock-        |
| C1.     | Not connected         |
| C2.     | Not connected         |
| C3.     | Not connected         |
| C4.     | Not connected         |
| C5.     | Ground                |

**• DVI Analog RGB Input**

- | Pin No. | Signal        | Pin No. | Signal                             |
|---------|---------------|---------|------------------------------------|
| 1.      | Not connected | 16.     | Hot plug detection                 |
| 2.      | Not connected | 17.     | Not connected                      |
| 3.      | Not connected | 18.     | Not connected                      |
| 4.      | Not connected | 19.     | Not connected                      |
| 5.      | Not connected | 20.     | Not connected                      |
| 6.      | DDC clock     | 21.     | Not connected                      |
| 7.      | DDC data      | 22.     | Not connected                      |
| 8.      | Vertical sync | 23.     | Not connected                      |
| 9.      | Not connected | 24.     | Not connected                      |
| 10.     | Not connected | C1.     | Analog input Red                   |
| 11.     | Not connected | C2.     | Analog input Green (Sync On Green) |
| 12.     | Not connected | C3.     | Analog input Blue                  |
| 13.     | Not connected | C4.     | Horizontal sync (Composite Sync)   |
| 14.     | +5V power     | C5.     | Ground                             |
| 15.     | Ground        |         |                                    |

**• DVI Analog Component Input**

- | Pin No. | Signal        | Pin No. | Signal             |
|---------|---------------|---------|--------------------|
| 1.      | Not connected | 16.     | Not connected      |
| 2.      | Not connected | 17.     | Not connected      |
| 3.      | Not connected | 18.     | Not connected      |
| 4.      | Not connected | 19.     | Not connected      |
| 5.      | Not connected | 20.     | Not connected      |
| 6.      | Not connected | 21.     | Not connected      |
| 7.      | Not connected | 22.     | Not connected      |
| 8.      | Not connected | 23.     | Not connected      |
| 9.      | Not connected | 24.     | Not connected      |
| 10.     | Not connected | C1.     | Analog input Pr/Cr |
| 11.     | Not connected | C2.     | Analog input Y     |
| 12.     | Not connected | C3.     | Analog input Pb/Cb |
| 13.     | Not connected | C4.     | Not connected      |
| 14.     | Not connected | C5.     | Ground             |
| 15.     | Ground        |         |                    |



**RS-232C Terminal:** mini DIN 9 pin female connector

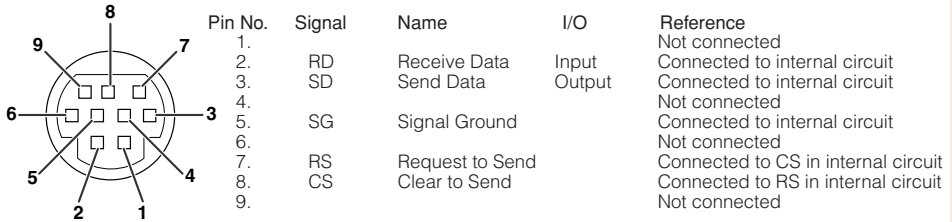

**RS-232C Terminal:** D-sub 9 pin male connector of the DIN-D-sub RS-232C adaptor

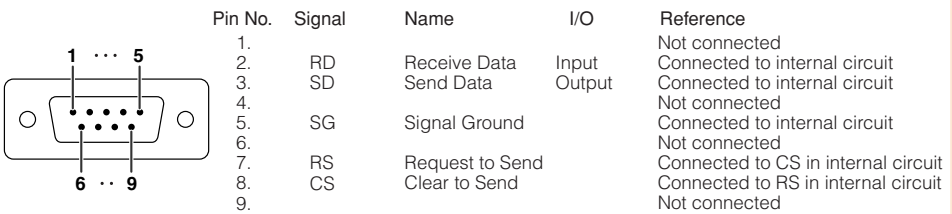

**RS-232C Cable recommended connection:** D-sub 9 pin female connector

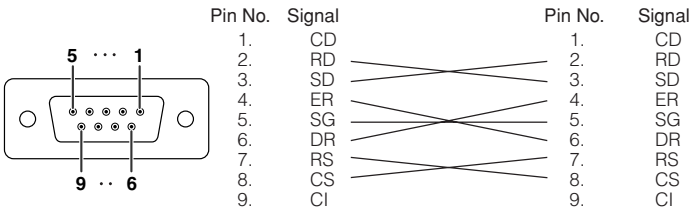

**Note**

- Depending on the controlling device used, it may be necessary to connect Pin 4 and Pin 6 on the controlling device (e.g. computer).



**USB Terminal:** Type B USB connector

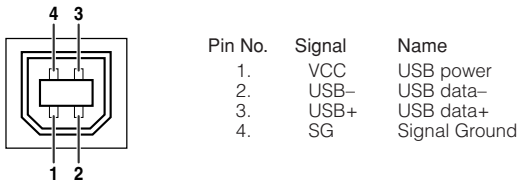

# RS-232C Specifications and Command Settings

## Computer control

A computer can be used to control the projector by connecting an RS-232C serial control cable (cross type, sold separately) to the projector. (See page 24 for connection.)

## Communication conditions

Set the serial port settings of the computer to match that of the table.

Signal format: Conforms to RS-232C standard.

Parity bit: None

Baud rate: \* 9,600 bps/115,200 bps

Stop bit: 1 bit

Data length: 8 bits

Flow control: None

\* Set the projector's baud rate to the same rate as used by the computer.

## Basic format

Commands from the computer are sent in the following order: command, parameter, and return code. After the projector processes the command from the computer, it sends a response code to the computer.

Command format

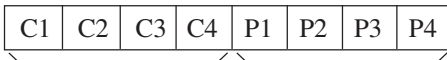

Command 4-digit

Parameter 4-digit

Return code (0DH)

Response code format

Normal response

Problem response (communication error or incorrect command)

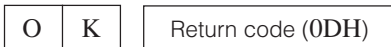

### Info

- When controlling the projector using RS-232C commands from a computer, wait for at least 30 seconds after the power has been turned on, and then transmit the commands.
- After sending an input selection command and then receiving an "OK" response code, the projector may take some time to process the command. Please be aware that commands should be sent at intervals of at least 5 seconds.
- When more than one code is being sent, send each command only after the response code for the previous command from the projector is verified.
- "POWER?????" "TABN \_\_\_ 1" "TLPS \_\_\_ 1" "TPOW \_\_\_ 1" "TLPN \_\_\_ 1" "TLTT \_\_\_ 1" "TLTL \_\_\_ 1" "TNAM \_\_\_ 1" "MNRD \_\_\_ 1" "PJN0 \_\_\_ 1"
  - When the projector receives the special commands shown above:
    - \* The on-screen display will not disappear.
    - \* The "Auto Power Off" timer will not be reset.
  - The special commands are available for applications that require continuous polling.



### Note

- If an underbar (\_) appears in the parameter column, enter a space.
  - If an asterisk (\*) appears in the parameter column, enter a value in the range indicated in brackets under Control Contents.
- \*1 For setting the projector name, send the commands in the order of PJN1, PJN2 and PJN3.  
\*2 This command should be sent only after the "IRGB \_\_\_ 2" command is sent and an "OK" response code is received.  
\*3 The Lamp Timer Reset command is available only in standby mode.

# Commands

Example: When turning on the projector, make the following setting.

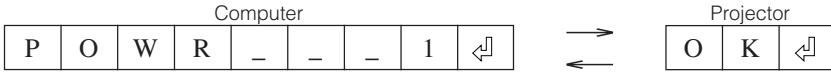

CONTROL CONTENTS		COMMAND	PARAMETER	RETURN		
				Power ON	Standby mode (or 30-second startup time)	
Power	On	P O W R	_ _ _ 1	OK or ERR	OK	
	Off	P O W R	_ _ _ 0	OK	OK or ERR	
	Status	P O W R	? ? ? ?	1	0	
Projector Condition		T A B N	_ _ _ 1	0: Normal 1: Temp High 8: Lamp Life 5% or less 16: Lamp Burn-out 32: Lamp Ignition Failure	0: Normal 1: Temp High 2: Fan Error 4: Lamp Cover Open 8: Lamp Life 5% or less 16: Lamp Burn-out 32: Lamp Ignition Failure 64: Temp Abnormally High	
Lamp	Status	T L P S	_ _ _ 1	0:Off, 1:On, 2:Retry 3:Waiting, 4:Lamp Error	0:Off, 4:Lamp Error	
	Power Status	T P O W	_ _ _ 1	1:On, 2:Cooling	0:Standby	
	Quantity	T L P N	_ _ _ 1	1		
	Usage Time(Hour)	T L T T	_ _ _ 1	0 – 9999(Integer)		
	Usage Time(Minute)	T L T M	_ _ _ 1	0, 15, 30, 45		
	Life(Percentage)	T L T L	_ _ _ 1	0% – 100%(Integer)		
Name	Model Name Check	T N A M	_ _ _ 1	PGF261X / PGF211X		
	Model Name Check	M N R D	_ _ _ 1	PG-F261X / PG-F211X		
	Projector Name Setting 1 (First 4 characters) *1	P J N 1	* * * *	OK or ERR		
	Projector Name Setting 2 (Middle 4 characters) *1	P J N 2	* * * *	OK or ERR		
	Projector Name Setting 3 (Last 4 characters) *1	P J N 3	* * * *	OK or ERR		
	Projector Name Check	P J N 0	_ _ _ 1	Projector Name		
Input Change	Computer	I R G B	_ _ _ 1	OK or ERR	ERR	
	DVI	I R G B	_ _ _ 2	OK or ERR	ERR	
	DVI-D-Computer select *2	I B D S	_ _ _ 1	OK or ERR	ERR	
	DVI-D-Video select *2	I B D S	_ _ _ 2	OK or ERR	ERR	
	DVI-Analog select *2	I B D S	_ _ _ 3	OK or ERR	ERR	
	S-Video	I V E D	_ _ _ 1	OK or ERR	ERR	
	Video	I V E D	_ _ _ 2	OK or ERR	ERR	
	Input RGB Check	I R G B	? ? ? ?	1: Computer, 2: DVI or ERR	ERR	
	Input Video Check	I V E D	? ? ? ?	1: S-Video, 2: Video or ERR	ERR	
	Input Mode Check	I M O D	? ? ? ?	1: RGB, 2: Video	ERR	
	Input Check	I C H K	? ? ? ?	1: Computer 2: DVI 3: S-Video 4: Video	ERR	
	Volume	Volume(0 – 60)	V O L A	_ _ * *	OK or ERR	ERR
		Volume up/down(-10 – +10)	V O U D	_ _ * *	OK or ERR	ERR
Keystone	-168 – +168	K E Y S	* * * *	OK or ERR	ERR	
AV Mute	On	I M B K	_ _ _ 1	OK or ERR	ERR	
	Off	I M B K	_ _ _ 0	OK or ERR	ERR	
Freeze	On	F R E Z	_ _ _ 1	OK or ERR	ERR	
	Off	F R E Z	_ _ _ 0	OK or ERR	ERR	
Auto Sync	Start	A D J S	_ _ _ 1	OK or ERR	ERR	
Resize	Computer	Normal	R A S R	_ _ _ 1	OK or ERR	ERR
		Stretch	R A S R	_ _ _ 2	OK or ERR	ERR
		Border	R A S R	_ _ _ 6	OK or ERR	ERR
	DVI	Normal	R B S R	_ _ _ 1	OK or ERR	ERR
		Stretch	R B S R	_ _ _ 2	OK or ERR	ERR
		Border	R B S R	_ _ _ 6	OK or ERR	ERR

# RS-232C Specifications and Command Settings (Continued)

CONTROL CONTENTS			COMMAND	PARAMETER	RETURN		
					Power ON	Standby mode (or 30-second startup time)	
Resize	S-Video	Normal	R A S V	-- -- 1	OK or ERR	ERR	
		Stretch	R A S V	-- -- 2	OK or ERR	ERR	
		Border	R A S V	-- -- 3	OK or ERR	ERR	
	Video	Normal	R B S V	-- -- 1	OK or ERR	ERR	
		Stretch	R B S V	-- -- 2	OK or ERR	ERR	
		Border	R B S V	-- -- 3	OK or ERR	ERR	
ALL Reset			A L R E	-- -- 1	OK or ERR	ERR	
Computer INPUT							
Computer INPUT	Picture Mode	Standard	R A P S	-- -- 1 0	OK or ERR	ERR	
		Presentation	R A P S	-- -- 1 1	OK or ERR	ERR	
		Movie	R A P S	-- -- 1 2	OK or ERR	ERR	
		Game	R A P S	-- -- 1 3	OK or ERR	ERR	
		sRGB	R A P S	-- -- 1 4	OK or ERR	ERR	
	Contrast	-30 ~ +30	R A P I	-- * * *	OK or ERR	ERR	
	Bright	-30 ~ +30	R A B R	-- * * *	OK or ERR	ERR	
	Red	-30 ~ +30	R A R D	-- * * *	OK or ERR	ERR	
	Blue	-30 ~ +30	R A B E	-- * * *	OK or ERR	ERR	
	Color	-30 ~ +30	R A C O	-- * * *	OK or ERR	ERR	
	Tint	-30 ~ +30	R A T I	-- * * *	OK or ERR	ERR	
	Sharp	-30 ~ +30	R A S H	-- * * *	OK or ERR	ERR	
	CLR Temp	-2 ~ +2	R A C T	-- -- * *	OK or ERR	ERR	
	Bright Boost	0 ~ +2	R A W E	-- -- -- *	OK or ERR	ERR	
	Progressive	2D Progressive	R A I P	-- -- -- 0	OK or ERR	ERR	
		3D Progressive	R A I P	-- -- -- 1	OK or ERR	ERR	
		Film Mode	R A I P	-- -- -- 2	OK or ERR	ERR	
	Picture Reset		R A R E	-- -- -- 1	OK or ERR	ERR	
	Signal Type	Auto	I A S I	-- -- -- 0	OK or ERR	ERR	
		RGB	I A S I	-- -- -- 1	OK or ERR	ERR	
		Component	I A S I	-- -- -- 2	OK or ERR	ERR	
	Audio Input	Audio 1	R A A I	-- -- -- 1	OK or ERR	ERR	
		Audio 2	R A A I	-- -- -- 2	OK or ERR	ERR	
	DVI INPUT						
	DVI INPUT	Picture Mode	Standard	R B P S	-- -- 1 0	OK or ERR	ERR
			Presentation	R B P S	-- -- 1 1	OK or ERR	ERR
			Movie	R B P S	-- -- 1 2	OK or ERR	ERR
Game			R B P S	-- -- 1 3	OK or ERR	ERR	
sRGB			R B P S	-- -- 1 4	OK or ERR	ERR	
Contrast		-30 ~ +30	R B P I	-- * * *	OK or ERR	ERR	
Bright		-30 ~ +30	R B B R	-- * * *	OK or ERR	ERR	
Red		-30 ~ +30	R B R D	-- * * *	OK or ERR	ERR	
Blue		-30 ~ +30	R B B E	-- * * *	OK or ERR	ERR	
Color		-30 ~ +30	R B C O	-- * * *	OK or ERR	ERR	
Tint		-30 ~ +30	R B T I	-- * * *	OK or ERR	ERR	
Sharp		-30 ~ +30	R B S H	-- * * *	OK or ERR	ERR	
CLR Temp		-2 ~ +2	R B C T	-- -- * *	OK or ERR	ERR	
Bright Boost		0 ~ +2	R B W E	-- -- -- *	OK or ERR	ERR	
Progressive		2D Progressive	R B I P	-- -- -- 0	OK or ERR	ERR	
		3D Progressive	R B I P	-- -- -- 1	OK or ERR	ERR	
		Film Mode	R B I P	-- -- -- 2	OK or ERR	ERR	
Picture Reset			R B R E	-- -- -- 1	OK or ERR	ERR	
Signal Type		Auto	I B S I	-- -- -- 0	OK or ERR	ERR	
		RGB	I B S I	-- -- -- 1	OK or ERR	ERR	
		Component	I B S I	-- -- -- 2	OK or ERR	ERR	
Audio Input		Audio 1	R B A I	-- -- -- 1	OK or ERR	ERR	
		Audio 2	R B A I	-- -- -- 2	OK or ERR	ERR	
Dynamic Range		Auto	H M B D	-- -- -- 0	OK or ERR	ERR	
		Standard	H M B D	-- -- -- 1	OK or ERR	ERR	
Enhanced		H M B D	-- -- -- 2	OK or ERR	ERR		

CONTROL CONTENTS			COMMAND	PARAMETER	RETURN	
					Power ON	Standby mode (or 30-second startup time)
S-Video INPUT	Picture Mode	Standard	V A P S	-- 1 0	OK or ERR	ERR
		Presentation	V A P S	-- 1 1	OK or ERR	ERR
		Movie	V A P S	-- 1 2	OK or ERR	ERR
		Game	V A P S	-- 1 3	OK or ERR	ERR
	Contrast	-30 ~ +30	V A P I	-- * * *	OK or ERR	ERR
	Bright	-30 ~ +30	V A B R	-- * * *	OK or ERR	ERR
	Color	-30 ~ +30	V A C O	-- * * *	OK or ERR	ERR
	Tint	-30 ~ +30	V A T I	-- * * *	OK or ERR	ERR
	Sharp	-30 ~ +30	V A S H	-- * * *	OK or ERR	ERR
	CLR Temp	-2 ~ +2	V A C T	-- * * *	OK or ERR	ERR
	Bright Boost	0 ~ +2	V A W E	-- -- *	OK or ERR	ERR
	Progressive	2D Progressive	V A I P	-- -- 0	OK or ERR	ERR
		3D Progressive	V A I P	-- -- 1	OK or ERR	ERR
		Film Mode	V A I P	-- -- 2	OK or ERR	ERR
	Picture Reset		V A R E	-- -- 1	OK or ERR	ERR
Audio Input	Audio 1	V A A I	-- -- 1	OK or ERR	ERR	
	Audio 2	V A A I	-- -- 2	OK or ERR	ERR	
Video INPUT	Picture Mode	Standard	V B P S	-- 1 0	OK or ERR	ERR
		Presentation	V B P S	-- 1 1	OK or ERR	ERR
		Movie	V B P S	-- 1 2	OK or ERR	ERR
		Game	V B P S	-- 1 3	OK or ERR	ERR
	Contrast	-30 ~ +30	V B P I	-- * * *	OK or ERR	ERR
	Bright	-30 ~ +30	V B B R	-- * * *	OK or ERR	ERR
	Color	-30 ~ +30	V B C O	-- * * *	OK or ERR	ERR
	Tint	-30 ~ +30	V B T I	-- * * *	OK or ERR	ERR
	Sharp	-30 ~ +30	V B S H	-- * * *	OK or ERR	ERR
	CLR Temp	-2 ~ +2	V B C T	-- * * *	OK or ERR	ERR
	Bright Boost	0 ~ +2	V B W E	-- -- *	OK or ERR	ERR
	Progressive	2D Progressive	V B I P	-- -- 0	OK or ERR	ERR
		3D Progressive	V B I P	-- -- 1	OK or ERR	ERR
		Film Mode	V B I P	-- -- 2	OK or ERR	ERR
	Picture Reset		V B R E	-- -- 1	OK or ERR	ERR
Audio Input	Audio 1	V B A I	-- -- 1	OK or ERR	ERR	
	Audio 2	V B A I	-- -- 2	OK or ERR	ERR	
Clock	-150 ~ +150	I N C L	* * * *	OK or ERR	ERR	
Phase	-30 ~ +30	I N P H	-- * * *	OK or ERR	ERR	
H-position	-150 ~ +150	I A H P	* * * *	OK or ERR	ERR	
V-position	-60 ~ +60	I A V P	-- * * *	OK or ERR	ERR	
Fine Sync Adjustment	Reset	I A R E	-- -- 1	OK or ERR	ERR	
Image Shift	-96 ~ +96	L N D S	-- * * *	OK or ERR	ERR	
OSD Display	On	I M D I	-- -- 1	OK or ERR	ERR	
	Off	I M D I	-- -- 0	OK or ERR	ERR	
Video System	Auto	M E S Y	-- -- 1	OK or ERR	ERR	
	PAL	M E S Y	-- -- 2	OK or ERR	ERR	
	SECAM	M E S Y	-- -- 3	OK or ERR	ERR	
	NTSC4.43	M E S Y	-- -- 4	OK or ERR	ERR	
	NTSC3.58	M E S Y	-- -- 5	OK or ERR	ERR	
	PAL-M	M E S Y	-- -- 6	OK or ERR	ERR	
	PAL-N	M E S Y	-- -- 7	OK or ERR	ERR	
	PAL-60	M E S Y	-- -- 8	OK or ERR	ERR	
Background	Logo	I M B G	-- -- 1	OK or ERR	ERR	
	Blue	I M B G	-- -- 3	OK or ERR	ERR	
	None	I M B G	-- -- 4	OK or ERR	ERR	
Lamp Setting	Bright	T H M D	-- -- 0	OK or ERR	ERR	
	Eco + Quiet	T H M D	-- -- 1	OK or ERR	ERR	

# RS-232C Specifications and Command Settings (Continued)

CONTROL CONTENTS		COMMAND	PARAMETER	RETURN		
				Power ON	Standby mode (or 30-second startup time)	
Auto Power Off	On	A P O W	_ _ _ 1	OK or ERR	ERR	
	Off	A P O W	_ _ _ 0	OK or ERR	ERR	
Auto Restart	On	A R E S	_ _ _ 1	OK or ERR	ERR	
	Off	A R E S	_ _ _ 0	OK or ERR	ERR	
STANDBY Mode	Standard	M O U T	_ _ _ 1	OK or ERR	ERR	
	Eco	M O U T	_ _ _ 0	OK or ERR	ERR	
PRJ Mode	Reverse	On	I M R E	_ _ _ 1	OK or ERR	
		Off	I M R E	_ _ _ 0	OK or ERR	
	Invert	On	I M I N	_ _ _ 1	OK or ERR	
		Off	I M I N	_ _ _ 0	OK or ERR	
Language	English	M E L A	_ _ _ 1	OK or ERR	ERR	
	Deutsch	M E L A	_ _ _ 2	OK or ERR	ERR	
	Español	M E L A	_ _ _ 3	OK or ERR	ERR	
	Nederlands	M E L A	_ _ _ 4	OK or ERR	ERR	
	Français	M E L A	_ _ _ 5	OK or ERR	ERR	
	Italiano	M E L A	_ _ _ 6	OK or ERR	ERR	
	Svenska	M E L A	_ _ _ 7	OK or ERR	ERR	
	日本語	M E L A	_ _ _ 8	OK or ERR	ERR	
	Português	M E L A	_ _ _ 9	OK or ERR	ERR	
	汉语	M E L A	_ _ _ 1 0	OK or ERR	ERR	
	한국어	M E L A	_ _ _ 1 1	OK or ERR	ERR	
	Русский	M E L A	_ _ _ 1 2	OK or ERR	ERR	
	عربي	M E L A	_ _ _ 1 3	OK or ERR	ERR	
	polski	M E L A	_ _ _ 1 4	OK or ERR	ERR	
	Türkçe	M E L A	_ _ _ 1 5	OK or ERR	ERR	
	Setup Guide	On	S E G U	_ _ _ 1	OK or ERR	ERR
		Off	S E G U	_ _ _ 0	OK or ERR	ERR
System Sound	On	S S N D	_ _ _ 1	OK or ERR	ERR	
	Off	S S N D	_ _ _ 0	OK or ERR	ERR	
Internal Speaker	On	A S P K	_ _ _ 1	OK or ERR	ERR	
	Off	A S P K	_ _ _ 0	OK or ERR	ERR	
RGB Frequency Check	Horizontal	T F R Q	_ _ _ 1	kHz(**** * or ERR)	ERR	
	Vertical	T F R Q	_ _ _ 2	Hz(*** * or ERR)	ERR	
Fan Mode	Normal	H L M D	_ _ _ 0	OK or ERR	ERR	
	High	H L M D	_ _ _ 1	OK or ERR	ERR	
Lamp Timer Reset *3		L P R E	0 0 0 1	ERR	OK or ERR	

# Computer Compatibility Chart

## Computer

- Multiple signal support
  - Horizontal Frequency: 15-70 kHz,
  - Vertical Frequency: 45-85 Hz,
- Pixel Clock: 12-108 MHz
- Sync signal: Compatible with TTL level
- Compatible with sync on green signal

The following is a list of modes that conform to VESA. However, this projector supports other signals that are not VESA standards.

PC/MAC	Resolution	Horizontal Frequency (kHz)	Vertical Frequency (Hz)	VESA Standard	DVI-D Support	Display			
PC	VGA	640 × 350	27.0	60		✓	Upscale		
			31.5	70					
		640 × 400	37.5	85	✓				
			27.0	60					
		720 × 350	31.5	70					
			37.9	85	✓				
	720 × 400	27.0	60						
		31.5	70						
		37.9	85	✓					
		640 × 480	26.2	50					
			31.5	60	✓				
			34.7	70					
	SVGA	800 × 600	37.9	72	✓	✓	True		
			37.5	75	✓				
			43.3	85	✓				
			31.4	50					
			35.1	56	✓				
			37.9	60	✓				
		XGA	1024 × 768	46.6	70			✓	Intelligent Compression
				48.1	72		✓		
				46.9	75		✓		
				53.7	85		✓		
				40.3	50				
				48.4	60		✓		
	WXGA	1280 × 720	56.5	70	✓	✓	Intelligent Compression		
			60.0	75	✓				
			68.7	85	✓				
			45.0	60					
			47.7	60					
			62.7	75					
	SXGA	1152 × 864	47.6	60		✓	Intelligent Compression		
			47.8	60					
			55.0	60					
			66.2	70					
			67.5	75					
			64.0	60	✓				
SXGA+	1400 × 1050	64.0	60		✓	Intelligent Compression			
		64.0	60						
MAC 13"	VGA	640 × 480	34.9	67		Upscale			
MAC 16"	SVGA	832 × 624	49.7	75		True			
MAC 19"	XGA	1024 × 768	60.2	75		Intelligent Compression			
MAC 21"	SXGA	1152 × 870	68.7	75		Intelligent Compression			





### Note

- When this projector receives 640 × 350 VESA format VGA signals, "640 × 400" appears on the screen.
- Optimum image quality will be achieved by matching your computer's output resolution to the projector's native resolution. (1024 x 768)

### DTV

Signal	Horizontal Frequency (kHz)	Vertical Frequency (Hz)	DVI-D Support (Compatible with HDCP)
480I	15.7	60	
480P	31.5	60	✓
540P	33.8	60	
576I	15.6	50	
576P	31.3	50	✓
720P	37.5	50	✓
720P	45.0	60	✓
1035I	33.8	60	✓
1080I	28.1	50	✓
1080I	33.8	60	✓

# Troubleshooting

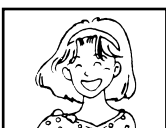
Problem	Check	Page
 <p>No picture and no sound or projector does not start.</p>	<ul style="list-style-type: none"> <li>• Projector power cord is not plugged into the wall outlet. <b>24</b></li> <li>• Power to the external connected devices is off. –</li> <li>• The selected input mode is wrong. <b>29</b></li> <li>• Cables are incorrectly connected to the projector. <b>21–24</b></li> <li>• Remote control battery has run out. <b>14</b></li> <li>• External output has not been set when connecting notebook computer. <b>21</b></li> <li>• The lamp unit cover is not installed correctly. <b>51, 52</b></li> <li>• If the connected DVI digital equipment is turned on before the “DVI-D” input mode is selected on the projector, the image may not be projected properly or may not be displayed at all. Ensure that the appropriate input mode has been selected on the projector before you turn on the connected equipment. <b>21</b></li> </ul>	
 <p>Sound is heard but no picture appears (or picture is dark).</p>	<ul style="list-style-type: none"> <li>• Cables are incorrectly connected to the projector. <b>21–24</b></li> <li>• “Bright” is set to minimum position. <b>40</b></li> <li>• Depending on the computer you are using, an image may not be projected unless the signal output setting of the computer is switched to the external output. Refer to the computer’s operation manual for how to switch its signal output settings. –</li> </ul>	
 <p>Color is faded or poor.</p>	<ul style="list-style-type: none"> <li>• Image adjustments are incorrectly set. <b>40</b></li> <li>• Make adjustments of “Color” and “Tint” in “Picture Mode” and lower the “Bright Boost” value.</li> </ul> <p>(Video Input only)</p> <ul style="list-style-type: none"> <li>• Video input system is incorrectly set. <b>46</b></li> </ul>	
 <p>Picture is blurred; noise appears.</p>	<ul style="list-style-type: none"> <li>• Adjust the focus. <b>26</b></li> <li>• The projection distance exceeds the focus range. <b>20</b></li> <li>• There is fog on the lens. If the projector is carried from a cold room into a warm room, or if it is suddenly heated, condensation may form on the surface of the lens and the image will become blurred. Set up the projector at least one hour before it is to be used. If condensation should form, remove the power cord from the wall outlet and wait for it to clear. –</li> </ul> <p>(Computer Input only)</p> <ul style="list-style-type: none"> <li>• Perform “Fine Sync” Adjustments (“Clock” Adjustment) <b>46</b></li> <li>• Perform “Fine Sync” Adjustments (“Phase” Adjustment) <b>46</b></li> <li>• Noise may appear depending on the computer. –</li> </ul>	
 <p>Picture appears but no sound is heard.</p>	<ul style="list-style-type: none"> <li>• Cables are incorrectly connected to the projector. <b>21–24</b></li> <li>• Volume is set to minimum. <b>29</b></li> <li>• When the projector is connected to an external device and the volume is set to minimum, the sound is not output even if you turn up the volume of the external device.</li> <li>• “Speaker” is set to “Off”. <b>43</b></li> </ul>	
<p>An unusual sound is occasionally heard from the cabinet.</p>	<ul style="list-style-type: none"> <li>• If the picture is normal, the sound is due to cabinet shrinkage caused by room temperature changes. This will not affect operation or performance. –</li> </ul>	



Problem	Check	Page
Maintenance indicator on the projector illuminates or blinks in red.	<ul style="list-style-type: none"> <li>See "Maintenance Indicators".</li> </ul>	<b>48</b>
The projector cannot be turned on or put into the standby mode using <b>STANDBY/ON</b> on the projector.	<ul style="list-style-type: none"> <li>The keylock is set. If the keylock is set to "ON", all the buttons are locked.</li> </ul>	<b>45</b>
Picture is green on COMPUTER (Component)/ DVI (Component).	<ul style="list-style-type: none"> <li>Change the input signal type setting.</li> <li>When you cannot select an input signal type, select "Color is faded or poor" in the "Help" menu, after selecting an item other than "sRGB" in "Picture Mode", and then select an input signal type.</li> </ul>	<b>46</b> <b>39, 46</b>
Picture is pink (no green) on COMPUTER (RGB)/ DVI (RGB).		
Picture is too bright and whitish.	<ul style="list-style-type: none"> <li>Image adjustments are incorrectly set.</li> </ul>	<b>40</b>
The cooling fan becomes noisy.	<ul style="list-style-type: none"> <li>When temperature inside the projector increases, the cooling fan runs faster.</li> </ul>	<b>8, 9</b> <b>47–49</b>
The lamp does not light up even after the projector turns on.	<ul style="list-style-type: none"> <li>The lamp indicator is illuminating in red. Replace the lamp.</li> </ul>	<b>48, 51</b>
The lamp suddenly turns off during projection.		
The image sometimes flickers.	<ul style="list-style-type: none"> <li>Cables are incorrectly connected to the projector or the connected equipment works improperly.</li> <li>Select "Vertical stripes or flickering image appear" in the "Help" menu and make the necessary adjustments.</li> <li>If this happens frequently, replace the lamp.</li> </ul>	<b>21–24</b> <b>46</b> <b>51</b>
The lamp needs much time to turn on.	<ul style="list-style-type: none"> <li>The lamp will eventually need to be changed. While the remaining lamp life draws to a close, replace the lamp.</li> </ul>	<b>51</b>
Picture is dark.		
The remote control cannot be used.	<ul style="list-style-type: none"> <li>Operate the remote control while pointing it at the projector's remote control sensor.</li> <li>The remote control may be too far away from the projector.</li> <li>If direct sunlight or a strong fluorescent lamp is shining on the projector's remote control sensor, place the projector where it will not be affected by strong light.</li> </ul>	<b>15</b>
	<ul style="list-style-type: none"> <li>The batteries may be depleted or inserted incorrectly. Make sure the batteries are inserted correctly or insert new ones.</li> </ul>	<b>14</b>

This unit is equipped with a microprocessor. Its performance could be adversely affected by incorrect operation or interference. If this should happen, unplug the Unit and plug it in again after more than 5 minutes.

# For SHARP Assistance

If you encounter any problems during setup or operation of this projector, first refer to the “Troubleshooting” section on pages 62 and 63. If this operation manual does not answer your question, please contact the SHARP Service departments listed below.

<b>U.S.A.</b>	<b>Sharp Electronics Corporation</b> 1-888-GO-SHARP (1-888-467-4277) lcdsupport@sharpsec.com <a href="http://www.sharpsusa.com">http://www.sharpsusa.com</a>	<b>Benelux</b>	<b>SHARP Electronics Benelux BV</b> 0900-SHARPC (0900-7427723) Nederland 9900-0159 Belgium <a href="http://www.sharp.nl">http://www.sharp.nl</a> <a href="http://www.sharp.be">http://www.sharp.be</a> <a href="http://www.sharp.lu">http://www.sharp.lu</a>
<b>Canada</b>	<b>Sharp Electronics of Canada Ltd.</b> (905) 568-7140 <a href="http://www.sharp.ca">http://www.sharp.ca</a>	<b>Australia</b>	<b>Sharp Corporation of Australia Pty. Ltd.</b> 1300-135-022 <a href="http://www.sharp.net.au">http://www.sharp.net.au</a>
<b>Mexico</b>	<b>Sharp Electronics Corporation Mexico Branch</b> (525) 716-9000 <a href="http://www.sharp.com.mx">http://www.sharp.com.mx</a>	<b>New Zealand</b>	<b>Sharp Corporation of New Zealand</b> (09) 634-2059, (09) 636-6972 <a href="http://www.sharp.net.nz">http://www.sharp.net.nz</a>
<b>Latin America</b>	<b>Sharp Electronics Corp. Latin American Group</b> (305) 264-2277 <a href="mailto:www.servicio@sharpsec.com">www.servicio@sharpsec.com</a> <a href="http://www.siempresharp.com">http://www.siempresharp.com</a>	<b>Singapore</b>	<b>Sharp-Roxy Sales (S) Pte. Ltd.</b> 65-226-6556 <a href="mailto:ckng@srs.global.sharp.co.jp">ckng@srs.global.sharp.co.jp</a> <a href="http://www.sharp.com.sg">http://www.sharp.com.sg</a>
<b>Germany</b>	<b>Sharp Electronics (Europe) GMBH</b> 01805-234675 <a href="http://www.sharp.de">http://www.sharp.de</a>	<b>Hong Kong</b>	<b>Sharp-Roxy (HK) Ltd.</b> (852) 2410-2623 <a href="mailto:dcmktg@srh.global.sharp.co.jp">dcmktg@srh.global.sharp.co.jp</a> <a href="http://www.sharp.com.hk">http://www.sharp.com.hk</a>
<b>U.K.</b>	<b>Sharp Electronics (U.K.) Ltd.</b> 08705 274277 <a href="http://www.sharp.co.uk/customersupport">http://www.sharp.co.uk/customersupport</a>	<b>Taiwan</b>	<b>Sharp Corporation (Taiwan)</b> 0800-025111 <a href="http://www.sharp-scot.com.tw">http://www.sharp-scot.com.tw</a>
<b>Italy</b>	<b>Sharp Electronics (Italy) S.P.A.</b> (39) 02-89595-1 <a href="http://www.sharp.it">http://www.sharp.it</a>	<b>Malaysia</b>	<b>Sharp-Roxy Sales &amp; Service Co.</b> (60) 3-5125678
<b>France</b>	<b>Sharp Electronics France</b> 01 49 90 35 40 <a href="mailto:hotlineced@sef.sharp-eu.com">hotlineced@sef.sharp-eu.com</a> <a href="http://www.sharp.fr">http://www.sharp.fr</a>	<b>U.A.E.</b>	<b>Sharp Middle East Fze</b> 971-4-81-5311 <a href="mailto:helpdesk@smef.global.sharp.co.jp">helpdesk@smef.global.sharp.co.jp</a>
<b>Spain</b>	<b>Sharp Electronica Espana, S.A.</b> 93 5819700 <a href="mailto:sharpdcd@sees.sharp-eu.com">sharpdcd@sees.sharp-eu.com</a> <a href="http://www.sharp.es">http://www.sharp.es</a>	<b>Thailand</b>	<b>Sharp Thebnakorn Co. Ltd.</b> 02-236-0170 <a href="mailto:svc@stcl.global.sharp.co.jp">svc@stcl.global.sharp.co.jp</a> <a href="http://www.sharp-th.com">http://www.sharp-th.com</a>
<b>Switzerland</b>	<b>Sharp Electronics (Schweiz) AG</b> 0041 1 846 63 11 <a href="mailto:cattaneo@sez.sharp-eu.com">cattaneo@sez.sharp-eu.com</a> <a href="http://www.sharp.ch">http://www.sharp.ch</a>	<b>Korea</b>	<b>Sharp Electronics Incorporated of Korea</b> (82) 2-3660-2002 <a href="mailto:lcd@sharp-korea.co.kr">lcd@sharp-korea.co.kr</a> <a href="http://www.sharpkorea.co.kr">http://www.sharpkorea.co.kr</a>
<b>Sweden</b>	<b>Sharp Electronics (Nordic) AB</b> (46) 8 6343600 <a href="mailto:vision.support@sen.sharp-eu.com">vision.support@sen.sharp-eu.com</a> <a href="http://www.sharp.se">http://www.sharp.se</a>	<b>India</b>	<b>Sharp Business Systems (India) Limited</b> (91) 11- 6431313 <a href="mailto:service@sharp-oa.com">service@sharp-oa.com</a>
<b>Austria</b>	<b>Sharp Electronics (Europe) GMBH Branch Office Austria</b> 0043 1 727 19 123 <a href="mailto:pogats@sea.sharp-eu.com">pogats@sea.sharp-eu.com</a> <a href="http://www.sharp.at">http://www.sharp.at</a>		

# Specifications

Model	PG-F261X/PG-F211X	
Display device	0.55" DLP® Chip	
Resolution	XGA (1024 × 768)	
Lens	F number	F 2.5 – 2.6
	Zoom	Manual, ×1.15 (f = 20.4 – 23.5 mm)
	Focus	Manual
Input terminal	DVI-I (Compatible with HDCP)	×1
	RGB/Component (mini D-sub 15 pin)	×1
	S-Video (mini DIN 4 pin)	×1
	Video (RCA)	×1
	Audio (ø3.5 mm stereo minijack)	×1
	Audio (RCA)	×1 (L/R)
Output terminal	RGB/Component (mini D-sub 15 pin)	×1
	Audio (ø3.5 mm stereo minijack)	×1
Control, others	USB (Type B)	×1
	RS-232C (mini DIN 9 pin)	×1
Speaker	2 W (Mono)	
Projection lamp	200 W	
Rated voltage	AC 100 – 240 V	
Rated frequency	50/60 Hz	
Input current	2.9 A	
Power consumption (Standby)	283 W (4.3 W) with AC 100 V	
	270 W (4.4 W) with AC 240 V	
Operation temperature	41°F to 95°F (+5°C to +35°C)	
Cabinet	Plastic	
Dimensions (main body only)	10 <sup>41</sup> / <sub>64</sub> " × 3 <sup>33</sup> / <sub>64</sub> " × 10 <sup>7</sup> / <sub>16</sub> " (270 (W) × 89 (H) × 265 (D) mm)	
Weight (approx.)	6.4 lbs. (2.9 kg)	

*As a part of policy of continuous improvement, SHARP reserves the right to make design and specification changes for product improvement without prior notice. The performance specification figures indicated are nominal values of production units. There may be some deviations from these values in individual units.*



# Dimensions

Units: inches (mm)

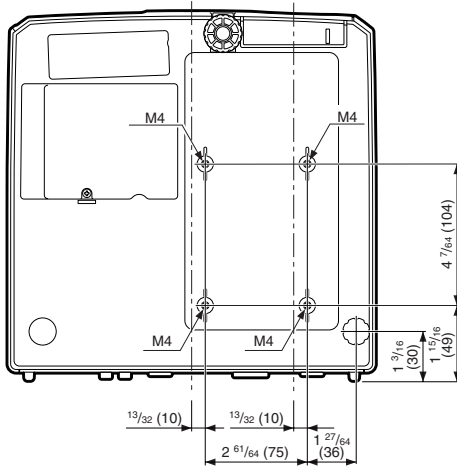
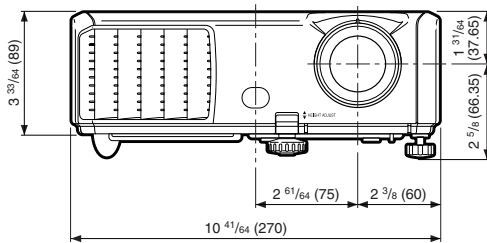
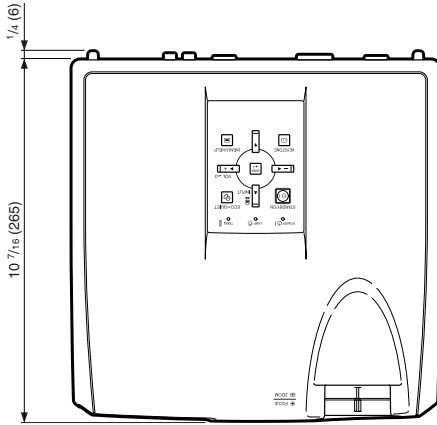

# Index

Accessories .....	10	MENU/HELP button .....	37, 46
AC socket .....	24	MONITOR OUT terminal .....	23
Adjustment buttons .....	37	MOUSE/Adjustment buttons .....	34, 37
Aspect ratio .....	30	NORMAL .....	30, 31
Audio Input .....	43	ON button .....	25
AUDIO 1, 2 terminal .....	23	Optional accessories .....	10
AUDIO OUT terminal .....	23	OSD Display .....	42
Auto Power Off .....	43	PAGE DOWN button .....	34
Auto Restart .....	43	PAGE UP button .....	34
Auto Sync (Auto Sync adjustment) .....	33, 36, 46	PDF .....	9
AUTO SYNC button .....	33	Picture Adjustment .....	39
AV MUTE button .....	29	Picture Mode .....	33, 39
Background .....	42	PICTURE MODE button .....	33
Batteries .....	14	POINTER button .....	32
Blue .....	40	Power cord .....	24
BORDER .....	30, 31	Power indicator .....	48
BREAK TIMER button .....	32	PRJ - ADJ .....	43
Bright .....	40	PRJ Mode .....	19, 42
Bright Boost .....	40	Progressive .....	40
CLR Temp (Color Temperature) .....	40	R-CLICK/RETURN button .....	34, 37
Color .....	40	Rear adjustment foot .....	27
COMPUTER button .....	29	Red .....	40
COMPUTER/COMPONENT input terminal .....	21, 22	Remote control .....	13
Contrast .....	40	Remote control sensor .....	15
DIN-D-sub RS-232C adaptor .....	24	Replacing the lamp .....	50, 51
DVI button .....	29	Resize .....	30, 41
DVI-I input terminal .....	21, 22	RESIZE button .....	30
ECO+QUIET button .....	32	RGB cable .....	21
ENTER button .....	37	RS-232C terminal .....	24
Exhaust vent .....	11, 47	SCR - ADJ .....	41
Fan Mode .....	44	Screen Size and Projection Distance .....	20
Fine Sync .....	46	Setup Guide .....	26, 42
Focus ring .....	26	Sharp .....	40
FREEZE button .....	33	Speaker .....	43
Front adjustment foot .....	27	SPOT button .....	32
HEIGHT ADJUST lever .....	27	STANDBY button .....	25
Help .....	46	STANDBY Mode .....	43
H-Pos .....	36, 46	STANDBY/ON button .....	25
Image shift .....	41	Storage case .....	53
INPUT modes .....	29	STRETCH .....	30, 31
Intake vent .....	11, 47	Supplied accessories .....	10
Kensington Security Standard connector .....	12	S-VIDEO button .....	29
Keycode .....	44	S-VIDEO terminal .....	22
Keylock .....	45	System Lock .....	44
KEYSTONE button .....	28	System Sound .....	43
Keystone Correction .....	28, 41	Temperature warning indicator .....	48
Lamp .....	50	Tint .....	40
Lamp indicator .....	48	USB terminal .....	34
Lamp Setting .....	40	VIDEO button .....	29
Lamp Timer (Life) .....	44	VIDEO terminal .....	22
Lamp unit .....	51	VOL (Volume) buttons .....	29
Language (on-screen display language) .....	42	V-Pos .....	36, 46
L-CLICK button .....	34	Zoom ring .....	26
Lens Cap .....	11		

**SHARP**<sup>®</sup>  
SHARP CORPORATION