

DPX-530

Digital Cinema Projector
Projecteur Cineme Numerique

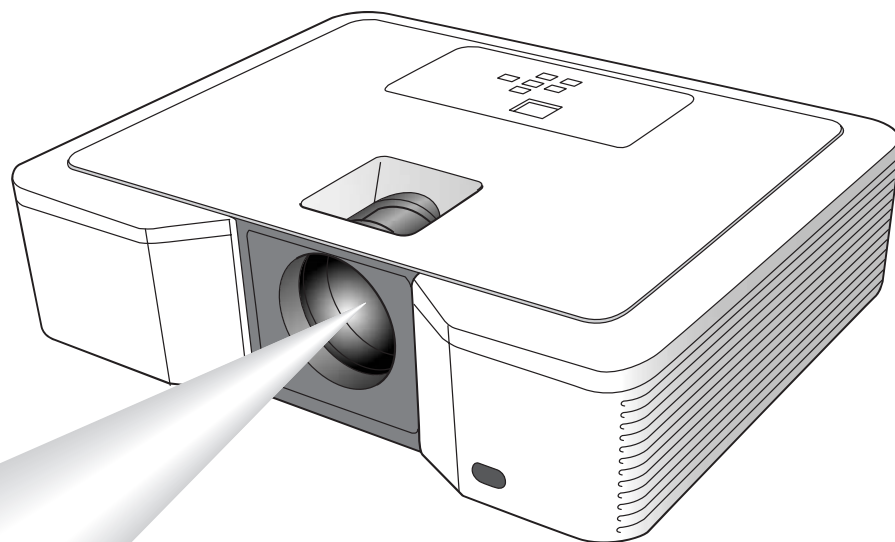

OWNER'S MANUAL
MODE D'EMPLOI
BEDIENUNGSANLEITUNG
BRUKSANVISNING
MANUALE DI ISTRUZIONI
MANUAL DE INSTRUCCIONES
GEBRUIKSAANWIJZING
ИНСТРУКЦИЯ ПО ЭКСПЛУАТАЦИИ

ENGLISH

FRANÇAIS

DEUTSCH

SVENSKA



ITALIANO

ESPAÑOL

NEDERLANDS

РУССКИЙ

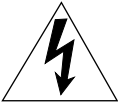
IMPORTANT SAFETY INSTRUCTIONS

	CAUTION RISK OF ELECTRIC SHOCK DO NOT OPEN	
CAUTION: TO REDUCE THE RISK OF ELECTRIC SHOCK, DO NOT REMOVE COVER (OR BACK). NO USER-SERVICEABLE PARTS INSIDE. REFER SERVICING TO QUALIFIED SERVICE PERSONNEL.		

• Explanation of Graphical Symbols

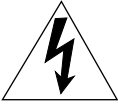

The lightning flash with arrowhead symbol, within an equilateral triangle, is intended to alert you to the presence of uninsulated “dangerous voltage” within the product’s enclosure that may be of sufficient magnitude to constitute a risk of electric shock to persons.



The exclamation point within an equilateral triangle is intended to alert you to the presence of important operating and maintenance (servicing) instructions in the literature accompanying the appliance.

WARNING

TO REDUCE THE RISK OF FIRE OR ELECTRIC SHOCK, DO NOT EXPOSE THIS UNIT TO RAIN OR MOISTURE.

For Canadian customers

To prevent electric shock, match wide blade of plug to wide slot and fully insert.
This Class B digital apparatus complies with Canadian ICES-003.

IMPORTANT!

Please record the serial number of this unit in the space below.
Model:
Serial No.:
The serial number is located on the bottom of the unit.
Retain this Owner’s Manual in a safe place for future reference.

Please read all these instructions regarding your projector and retain them for future reference. Follow all warnings and instructions marked on the projector.

- 1 Read instructions:** All the safety and operating instructions should be read before the appliance is operated.
- 2 Retain instructions:** The safety and operating instructions should be retained for future reference.
- 3 Warnings:** All warnings on the appliance and in the operating instructions should be adhered to.
- 4 Instructions:** All operating instructions must be followed.
- 5 Cleaning:** Unplug this projector from the wall outlet before cleaning it. Do not use liquid aerosol cleaners.
- 6 Attachments and equipment:** Never add any attachments and/or equipment without the approval of the manufacturer as such additions may result in the risk of fire, electric shock or other personal injury.

7 Water and moisture: Do not use this projector near water or in contact with water.

8 Accessories: Do not place this projector on an unstable cart, stand, tripod, bracket or table. Use only with a cart, stand, tripod bracket, or table recommended by the manufacturer or sold with the projector. Any mounting of the appliance should follow the manufacturer’s instructions and should use a mounting accessory recommended by the manufacturer.



An appliance and cart combination should be moved with care. Quick stops, excessive force and uneven surfaces may cause the appliance and cart combination to overturn.

9 Ventilation: Slots and openings in the cabinet are provided for ventilation, ensuring reliable operation of the projector and to protect it from overheating. Do not block these openings or allow them to be blocked by placing the projector on a bed, sofa, rug, or bookcase. Ensure that there is adequate ventilation and that the manufacturer’s instructions have been adhered to.

10 Power sources: This projector should be operated only from the type of power source indicated on the marking label. If you are not sure of the type of power, please consult your appliance dealer or local power company.

11 Power-cable protection: Power-supply cables should be routed so that they are not likely to be walked on or pinched by items placed upon or against them. Pay particular attention to cords at plugs, convenience receptacles, and points where they exit from the appliance.

12 Overloading: Do not overload wall outlets and extension cords as this can result in a fire or electric shock.

13 Objects and liquids: Never push objects of any kind through openings of this projector as they may touch dangerous voltage points or short-out parts that could result in a fire or electric shock. Never spill liquid of any kind on the projector.

14 Servicing: Do not attempt to service this projector yourself. Refer all servicing to qualified service personnel.

15 Damage requiring service: Unplug this projector from the wall outlet and refer servicing to qualified service personnel under the following conditions:

- (a) If the power-supply cable or plug is damaged.
- (b) If liquid has been spilled, or objects have fallen into the projector.
- (c) If the projector does not operate normally after you follow the operating instructions. Adjust only those controls that are covered by the operating instructions. An improper adjustment of other controls may result in damage and may often require extensive work by a qualified technician to restore the projector to its normal operation.
- (d) If the projector has been exposed to rain or water.
- (e) If the projector has been dropped or the cabinet has been damaged.
- (f) If the projector exhibits a distinct change in performance - this indicates a need for service.

16 Replacement parts: When replacement parts are required, be sure that the service technician has used replacement parts specified by the manufacturer or parts having the same characteristics as the original part. Unauthorized substitutions may result in fire, electric shock or other hazards.

17 Safety check: Upon completion of any service or repair to this projector, ask the service technician to perform safety checks determining that the projector is in a safe operating condition.

18 Connection cable: Use the supplied RS-232C and RGB cables with this equipment to keep interference within the limits of an FCC/EN55022 Class B device.

COMPLIANCE INFORMATION STATEMENT

(DECLARATION OF CONFORMITY PROCEDURE)

Responsible Party: Yamaha Electronics Corporation
Address: 6660 Orangethorpe Avenue
Buena Park, CA90620
Telephone: 714-522-9105
Fax: 714-670-0108
Type of Equipment: Projector
Model Name: DPX-530

This device complies with Part 15 of the FCC Rules.

Operation is subject to the following conditions:

- 1) this device may not cause harmful interference, and
- 2) this device must accept any interference received including interference that may cause undesired operation.

See the owner's manual instructions if interference to radio reception is suspected.

FCC INFORMATION (for US customers only)

1. IMPORTANT NOTICE: DO NOT MODIFY THIS UNIT!

This product, when installed as indicated in the instructions contained in this manual, meets FCC requirements.

Modifications not expressly approved by Yamaha may void your authority, granted by the FCC, to use the product.

- 2. IMPORTANT:** When connecting this product to accessories and/or another product use only high quality shielded cables. Cable/s supplied with this product **MUST** be used. Follow all installation instructions. Failure to follow instructions could void your FCC authorization to use this product in the USA.

- 3. NOTE:** This product has been tested and found to comply with the requirements listed in FCC Regulations, Part 15 for Class "B" digital devices. Compliance with these requirements provides a reasonable level of assurance that your use of this product in a residential environment will not result in harmful interference with other electronic devices.

This equipment generates/uses radio frequencies and, if not installed and used according to the instructions found in the users manual, may cause interference harmful to the operation of other electronic devices.

Compliance with FCC regulations does not guarantee that interference will not occur in all installations. If this product is found to be the source of interference, which can be determined by turning the unit "OFF" and "ON", please try to eliminate the problem by using one of the following measures:

Relocate either this product or the device that is being affected by the interference.

Utilize power outlets that are on different branch (circuit breaker or fuse) circuits or install AC line filter/s.

In the case of radio or TV interference, relocate/reorient the antenna. If the antenna lead-in is 300 ohm ribbon lead, change the lead-in to coaxial type cable.

If these corrective measures do not produce satisfactory results, please contact the local retailer authorized to distribute this type of product. If you can not locate the appropriate retailer, please contact Yamaha Electronics Corp., U.S.A. 6660 Orangethorpe Ave, Buena Park, CA 90620.

The above statements apply **ONLY** to those products distributed by Yamaha Corporation of America or its subsidiaries.

Caution: Read this before operating this unit.

Warning

- **This unit must be grounded**
- **Do not use this projector in a computer room**

This projector is not for use in a computer room, as defined in the Standard for the Protection of Electronic Computer/Data Processing Equipment, ANSI/NFPA 75.
- **Unplug immediately if there is something wrong with your projector**

Do not operate if smoke, strange noise or odor comes out of the projector. It might cause fire or electric shock. If this happens, unplug immediately and contact your dealer.
- **Never remove the cabinet**

This projector contains high voltage circuitry. An inadvertent contact may result in an electric shock. Except as specifically explained in the owner's manual, do not attempt to service this product yourself. Contact your dealer when you want to fix, adjust or inspect the projector.
- **Do not modify this projector**

It can lead to fire or electric shock.
- **Do not continue using this projector if you drop or break it**

Unplug the projector and contact your dealer for inspection. It may lead to fire if you continue using it.
- **Do not face the projector lens towards the sun**

It can lead to fire.
- **Use correct voltage**

If you use incorrect voltage, it can lead to fire.
- **Do not place the projector on uneven or unstable surfaces**

Place the projector on a leveled and stable surface only.
- **Do not look into the lens when it is operating**

It may cause serious eye injury.
- **Do not turn off the main power abruptly or unplug the projector during operation**

It can lead to lamp breakage, fire, electric shock or other trouble. Always wait for the fan to turn off before turning the main power off.
- **Avoid all contact with the air exhaust vents and bottom plate**

The air exhaust vents and bottom plate heat up during operation and may cause personal injury or damage to other equipment. Do not touch them, place other equipment in front of the air exhaust vents, or set the projector on a desk which is easily affected by heat.
- **Do not look into the air exhaust vent when the projector is operating**

Heat, dust, etc. may blow out of it and cause injury to your eyes.
- **Do not block the air intake and exhaust vents**

If they are blocked, heat may be generated inside the projector, causing deterioration in the projector quality and/or fire.

This unit is not disconnected from the AC power source as long as it is connected to the wall outlet, even if this unit itself is turned off. This state is called the standby mode. In this state, this unit is designed to consume a very small quantity of power.

Place of installation

For safety reasons, refrain from setting the projector at any place subjected to high temperature and high humidity. Maintain an operating temperature, humidity and setting as specified below:

- Operating temperature: between 41°F (5°C) and 95°F (35°C).
- Operating humidity: between 30 and 90%
- Never put any heat-producing device under the projector. The projector may overheat.
- Do not install the projector near any equipment that produces a strong magnetic field. Also refrain from installing near the projector any cable carrying a large current.
- Do not install the projector in a place that is unstable or subject to vibration; otherwise, it may fall and cause serious injury and/or damage to the unit.
- Do not stand the projector on its side; otherwise, it may fall and cause serious injury and/or damage to the unit.
- Slanting the projector more than 10° right/left or 15° forward/backward may cause serious problems, such as the lamp to explode.
- Do not place the projector near an air conditioning unit or heater to avoid hot air to the vents of the projector.

European compliance notice

This video projector complies with the requirements of the EC Directive 89/336/EEC "EMC Directive" as amended by Directive 92/31/EEC and 93/68/EEC, and 73/23/EEC "Low Voltage Directive" as amended by Directive 93/68/EEC.

For U.K. customers

If the socket outlets in the home are not suitable for the plug supplied with this appliance, it should be cut off and an appropriate 3-pin plug fitted. For details, refer to the instructions described below.

Note

- The plug severed from the mains lead must be destroyed, as a plug with a bared flexible cord is hazardous if engaged in a live socket outlet.

IMPORTANT

THE WIRES IN THIS MAINS LEAD ARE COLOURED IN ACCORDANCE WITH THE FOLLOWING CODE:

GREEN-AND-YELLOW:	EARTH
BLUE:	NEUTRAL
BROWN:	LIVE

As the colours of the wires in the mains lead of this apparatus may not correspond with the coloured markings identifying the terminals in your plug, proceed as follows:

The wire which is coloured GREEN-AND-YELLOW must be connected to the terminal in the plug which is marked by the letter "E" or the safety earth symbol or coloured GREEN or GREEN-AND-YELLOW.

The wire which is coloured BLUE must be connected to the terminal marked with the letter "N" or coloured BLACK.

The wire which is coloured BROWN must be connected to the terminal marked with the letter "L" or coloured RED.

Table of contents

1	Preparation	2	
	Inappropriate places for installation	2	
	Accessory check	3	
	Inserting the batteries into the remote control	4	
2	Controls and functions	5	
	Projector overview	5	
	Remote control overview	6	
	Using the picture quality adjusting buttons	6	
3	Using the remote control	7	
	Operational range	7	
	Reception angle	7	
4	Setting up the projector	8	
	Setting up your projector	8	
	Basic projector setup	8	
	Adjusting the projection angle	8	
	Screen size and projection distance	9	
5	Connections	10	
	Basic home theater system connection	10	
	Connecting to a video player, etc.	11	
	Connecting to a DVD player	11	
	DVI-D connections	12	
	D-SUB connections	12	
	Connecting the projector to a computer	13	
	Plugging in the power cable	13	
6	Projection	14	
	Viewing video images	14	
	To stop projecting:	15	
	KEYSTONE adjustment	15	
	IRIS button	15	
	Setting the aspect ratio	16	
	Changing the settings	16	
	Viewing computer images	17	
	AUTO / AUTO SYNC buttons	18	
	When connected to a notebook computer: ...	18	
	To stop projecting:	18	
7	Menu	19	
	Menu overview	19	
	How to set the menus	20	
	Menu settings	21	
8	Adjusting video images	24	
	Adjusting brightness (CONTRAST and BRIGHTNESS)	24	
	CONTRAST	24	
	BRIGHTNESS	24	
	Enhancing the white level (WHITE ENHANCE)	24	
	Adjusting the white tone (to select COLOR TEMP.)	24	
	Adjusting the white tone (to customize COLOR TEMP.)	24	
	About color temperature	24	
	Adjusting color (SATURATION and HUE)	25	
	SATURATION	25	
	HUE	25	
	Sharpening or softening images (SHARPNESS)	25	
	LPF (Progressive filter)	25	
9	MEMORY function	26	
	MEMORY function	26	
10	Adjusting computer images	26	
	Adjusting computer images	26	
	Simple method to adjust the image position	26	
11	Ceiling installation	27	
	Viewing ceiling mounted projector images	27	
	Dimension Drawings (unit: mm)	27	
12	Replacing the lamp	28	
	Interval of lamp replacement	28	
	Replacing the lamp	29	
	Maintenance	29	
13	Attaching a lens filter and cap	30	
	Attaching a commercially available lens filter ...	30	
	Attaching the lens cap	30	
14	Troubleshooting	31	
	Troubleshooting	31	
15	Indicators	34	
	Normal conditions	34	
	Abnormal condition	34	
16	Specifications	35	
	Projector specifications	35	
	Composite / S-video signal specifications	36	
	Component signal specifications	36	
	Digital RGB signal specifications	36	
	Analog RGB signal specifications	36	

1 Preparation

◆ Inappropriate places for installation

If this unit is not correctly installed in an appropriate place, it may cause fire or failure, or damage the unit itself. Carefully choose the place to install this unit by avoiding the places listed below.

1. Places where the temperature and humidity vary greatly

- Do not install this unit in a place where the temperature and humidity become extremely high or the temperature becomes extremely low.
- This unit must be used within a temperature range of 41°F (5°C) to 95°F (35°C).
- This unit must be used within a humidity range of 30 to 90%

2. Places without adequate ventilation

- Install this unit with at least 30 cm (1 feet) of ventilation space on the top, right and left, and back.
- Do not cover the ventilation slots of this unit. Covering the slots will obstruct heat dissipation.
- Install this unit on the firm surface.
- Do not cover this unit with a tablecloth, etc.
- Make sure there is nothing to get sucked into the ventilation slots so that the temperature of this unit does not become too high.
- If you are going to install the unit in a rack, be sure to leave space for ventilation to prevent exhaust overheating the unit.

3. Places where it gets dusty

- If the filter is blocked with dust, the temperature of this unit may become too high.

4. Places with too much vibration or impact

- Vibration and impact can damage parts of this unit.

5. Places where this unit gets exposed to water or high humidity

- If this unit is exposed to water of high humidity, it may cause a fire or electrical shock.

6. Unstable places

- If this unit is installed on an unstable or an inclined tabletop, it may fall and cause damage to the unit or personal injury.

7. In close proximity to a radio or stereo

- The unit may interfere with reception if placed in close proximity to a radio or television receiver.

8. Uneven surfaces

- Slanting the projector more than 10° right and left or 15° front and rear may cause problems (such as the lamp exploding).

Warning

- To ensure vivid, high contrast images, make sure that no light other than the projector light falls directly on the screen.

◆ Accessory check

The following accessories are provided with this projector. Check to be sure that all of the accessories are packed in the package.

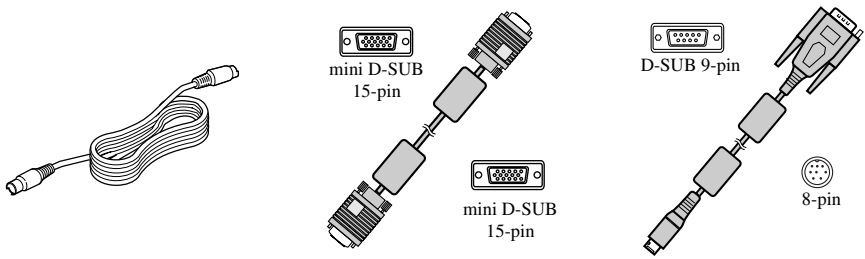
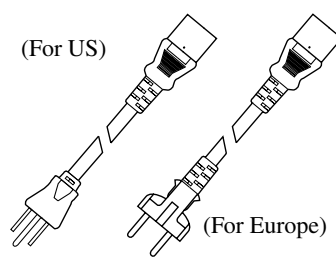
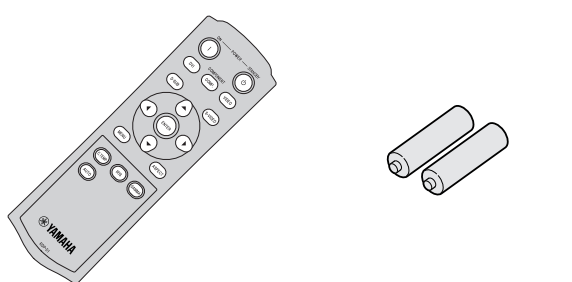
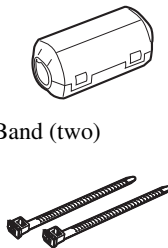
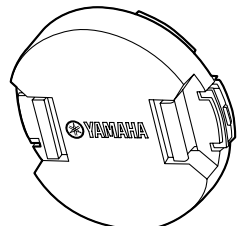
<p>■ Cables</p>  <p>S-video cable (WF76950)</p> <p>RGB cable for PC (WF76940)</p> <p>RS-232C cable (WF76930)</p>		<p>■ Power supply parts</p>  <p>(For US)</p> <p>(For Europe)</p> <p>Power cable</p>
<p>• Used for adjustment by service person.</p>		
<p>■ Remote control parts</p>  <p>Remote control</p> <p>R03 (Size-AAA) battery (two)</p>	<p>■ Ferrite core set</p> <ul style="list-style-type: none"> • Instruction guide • Ferrite core  <ul style="list-style-type: none"> • Band (two) 	<p>■ Others</p> <ul style="list-style-type: none"> • Owner's manual • Lens cap 

Important

- The supplied power cables are to be used exclusively for this product. Never use them for other products.
- The power cables for use in the U.S. and Europe are included with this projector. Use the appropriate one for your country.
- The provided power cable for the U.S. is rated at 120 V. Never connect this cable to any outlet or power supply using other voltages or frequencies than rated. If you use a power supply using other voltage than rated, prepare an appropriate power cable separately.

◆ Inserting the batteries into the remote control

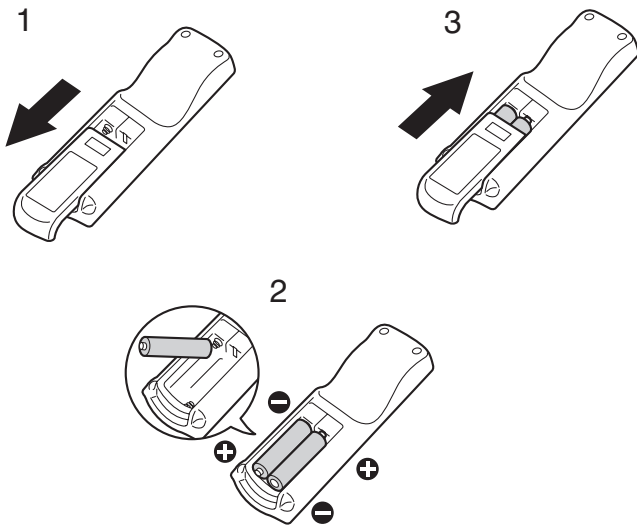

1. Remove the rear lid of the remote control.
2. Check the polarity markings (+, -) of the batteries, and set them correctly, inserting their (-) side first.
 - If the battery is inserted from the (+) side first, inserting the (-) side becomes difficult because the coil spring end hits on the battery side. If the battery is forced to insert in this way, the outer label of the battery may get ripped and cause a short-circuit and heating.
3. Attach the rear lid.

Important

- Use two size-AAA batteries (R03).
- Replace the two batteries with new ones when the remote control is slow to operate.

Caution

- Using the wrong type of battery may cause an explosion.
- Only Carbon-Zinc or Alkaline-Manganese Dioxide type batteries should be used.
- Dispose of used batteries according to your local regulations.
- Batteries may explode if misused. Do not recharge, disassemble, or dispose of in fire.
- Be sure to handle the battery according to the instructions.
- Load the battery with its positive (+) and negative (-) sides correctly oriented as indicated on the remote control.
- Keep batteries out of reach of children and pets.
- Remove the batteries, if the remote control is not used for a long time.
- Do not combine a new battery with an old one.
- If the solution of batteries comes in contact with your skin or clothes, rinse with water. If the solution comes in contact with your eyes, rinse them with water and then consult your doctor.

2 Controls and functions

◆ Projector overview

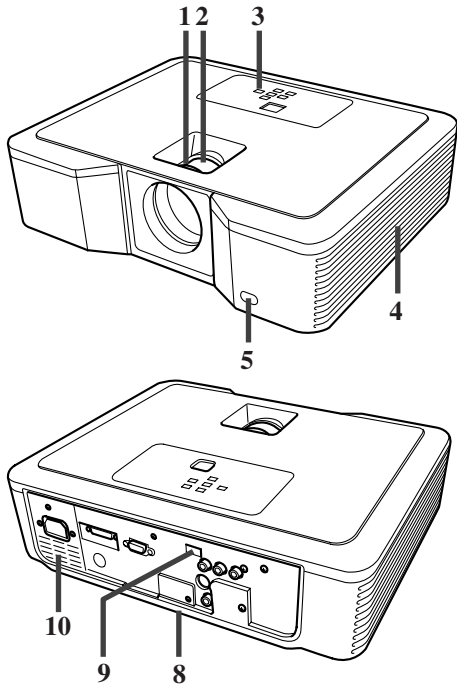

1. FOCUS ring
2. ZOOM ring
3. Control panel
4. Air intake vent
5. Remote control sensor (Front)
6. Air exhaust vent
7. Air intake vent
8. Terminal board
9. Remote control sensor (Rear)
10. Air exhaust vent

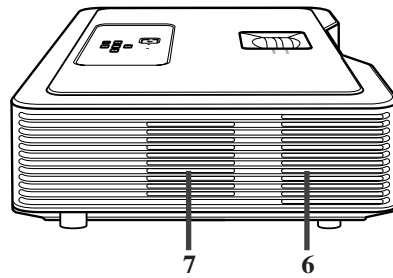

Control area

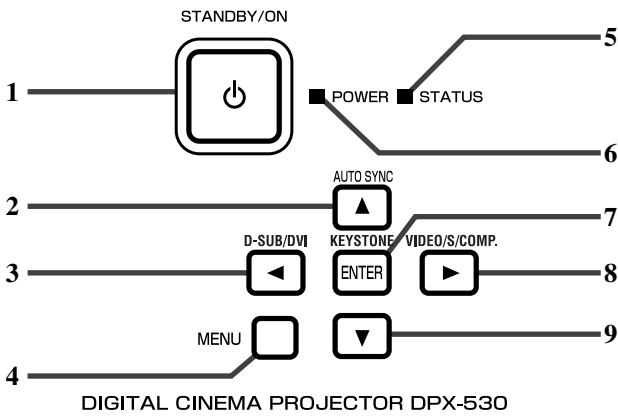

1. STANDBY / ON, button
2. AUTO SYNC, button
3. D-SUB / DVI, button
4. MENU button
5. STATUS indicator
6. POWER indicator
7. KEYSTONE, **ENTER** button
8. VIDEO / S / COMP., button
9. button

Important

- While the menu is on the screen, the KEYSTONE button functions as the ENTER button and the D-SUB / DVI, VIDEO / S / COMP., and AUTO SYNC buttons function as the , , and buttons respectively.

Rear panel

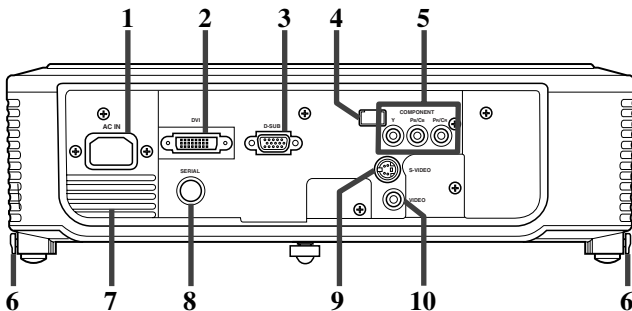

1. AC IN
2. DVI input terminal (DVI-D 24-pin with HDCP)
3. D-SUB input terminal
4. Remote control sensor (Rear)
5. COMPONENT input terminals
6. Foot adjustment buttons (Left/Right)
7. Air exhaust vent
8. SERIAL terminal (8-pin)
 - Used for adjustment by service person.
9. S-VIDEO input terminal
10. VIDEO input terminal

Bottom side

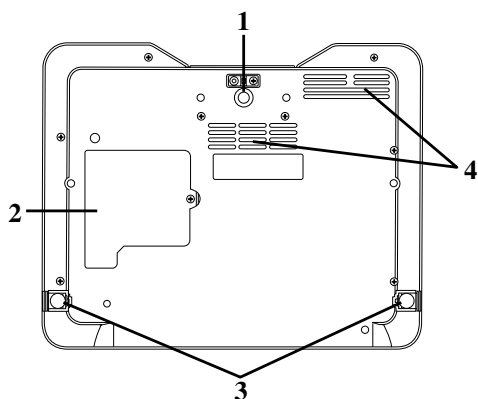

1. Adjustment foot (Front)
2. Lamp cover
3. Adjustment feet (Rear)
4. Air intake vent

Caution

- Do not replace the lamp immediately after using the projector because the lamp will be extremely hot and may cause burns.

◆ Remote control overview

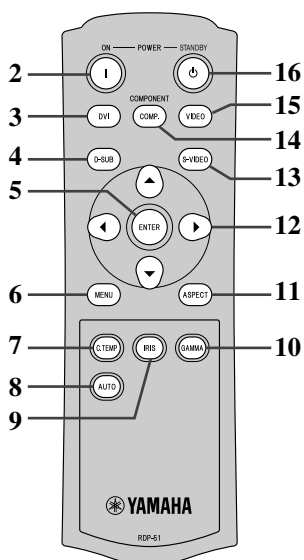
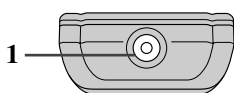

1. IR signal transmitter
2. ON (I) button
3. DVI button
4. D-SUB button
5. ENTER button
6. MENU button
7. C.TEMP (COLOR TEMPERATURE) button*
8. AUTO button
9. IRIS button
10. GAMMA button*
11. ASPECT button
12. Direction buttons
13. S-VIDEO button
14. COMP. (COMPONENT) button
15. VIDEO button
16. STANDBY (⏻) button

* See the below for the picture quality adjusting buttons.

Important

- When you press a button on the remote control, the buttons on the remote control will light up. Wait approximately 6 seconds after releasing the button for the lights to turn off.

Using the picture quality adjusting buttons

When you press either of the picture quality adjusting buttons, the message for adjusting the picture quality appears. Adjust the picture quality by pressing the GAMMA and C. TEMP buttons. The picture quality adjustment can be made alternatively in the IMAGE menu (see page 21).

GAMMA.....Selects one of the preset gamma modes.

C. TEMP (COLOR TEMPERATURE)Selects one of the preset color temperatures.

3 Using the remote control

◆ Operational range

Front of projector

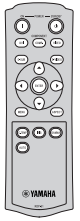
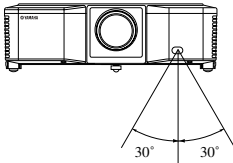

Operate the remote control within a distance of 10 m from the projector, pointing the light beam at the remote control sensor (front or rear) of the projector.

Rear of projector

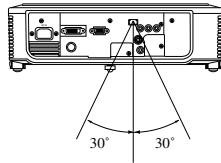

- Keep the remote control sensor out of direct sunlight or fluorescent lamp light.
- Keep the remote control sensor at least 2 m away from fluorescent lamps. Otherwise, the remote control may malfunction.
- If there is an inverter-operated fluorescent lamp near the remote control, the remote control operation may become unstable. On this occasion, stick a commercially available protection sticker on one of the sensors that is closer to the fluorescent lamp.

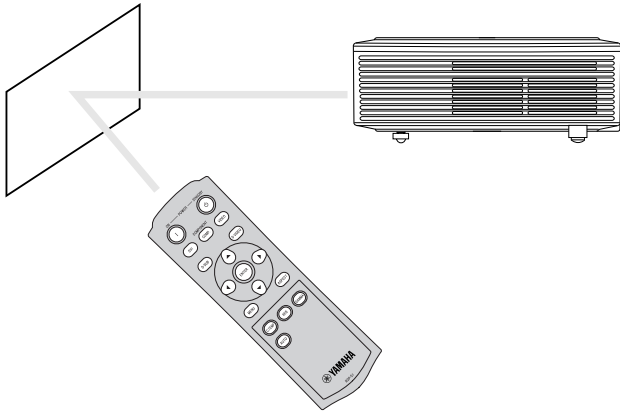

When operating the remote control, keep the distance from the remote control to the projector via the screen within about 5 m. The operable range of the remote control, however, depends on the characteristics of the screen.

◆ Reception angle

Vertical directions

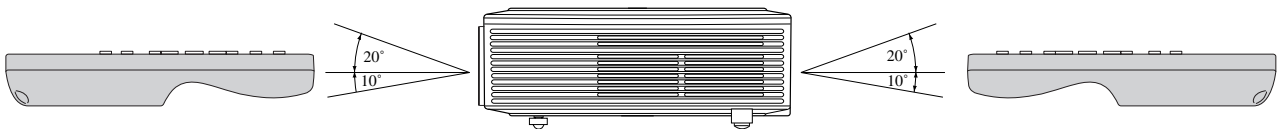

Vertical directions (ceiling mount)

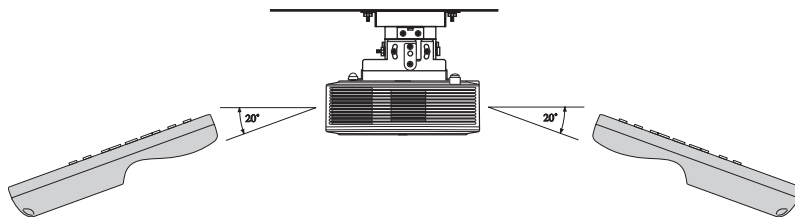

4 Setting up the projector

◆ Setting up your projector

Install the screen perpendicularly to the projector. If the screen can not be installed in such a way, adjust the projection angle of the projector as shown below.

- Install the screen and projector so that the projector's lens is placed at the horizontal position of the screen center.
- Do not install the screen where it is exposed to direct sunlight or lighting. Light directly reflecting on the screen makes the projected images whitish and hard to view.

◆ Basic projector setup

Determine the distance from the screen to the projector according to the size of the images to be projected (see page 9).

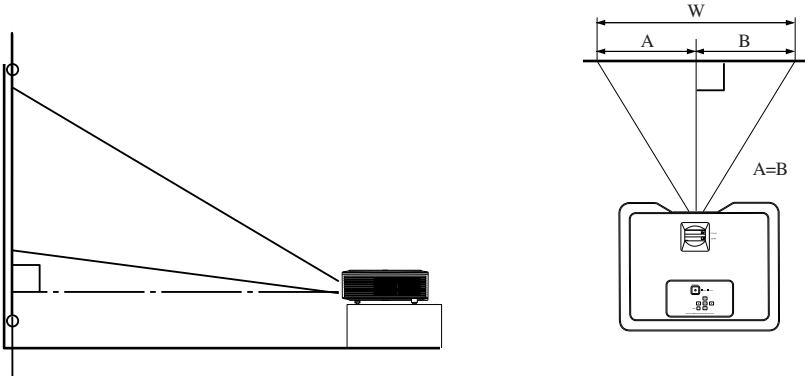

- Do not place this projector on a carpet or blanket because the exhaust vent and the intake vent on the bottom surface will be blocked and the inside of the projector will overheat, causing a breakdown or fire.
- Depending on the installation conditions, warm air that is emitted from the exhaust vents may flow into the intake vent, causing the projector to display “Over Temperature” and then stop projecting images. If this happens, clear the area around the exhaust vent.

◆ Adjusting the projection angle

This projector is provided with three feet for adjusting the projection angle on the bottom surface. Adjust the projection angle depending on the position of the projector.

For the best projection, project images on a flat screen installed at 90 degrees to the floor. If necessary, tilt the projector using the adjustment feet on the bottom of the projector.

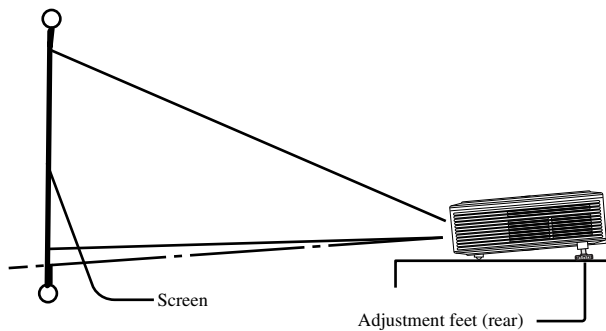

1. Tilt the projector upwards to the appropriate angle.
2. Press the foot adjustment buttons next to the adjustment feet (rear), and the adjustment feet will come out.
3. Release the buttons to lock the adjustment feet (rear) to that position.
4. Rotate the adjustment feet (rear) for fine adjustment.
 - If necessary, rotate the adjustment feet (front) for fine adjustment.

After using the projector

Put the adjustment feet (rear) back into the projector by pressing the foot adjustment buttons.

When projected images are distorted to a trapezoid

When the screen and the projector are not placed perpendicularly to each other, projected images become trapezoidal. If you cannot make the projector and the screen perpendicular to each other by mechanical adjustments, adjust keystone (see page 15).

◆ Screen size and projection distance

Refer to the following diagram to determine the screen size.

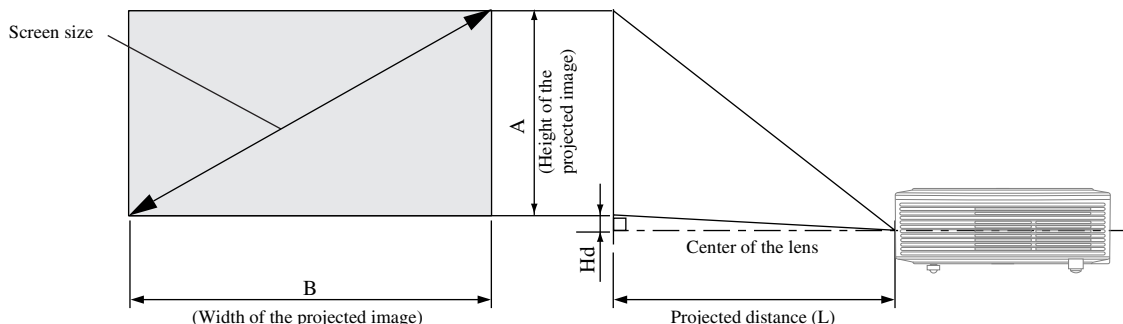

When the aspect ratio of the screen is 4:3, the positional relation between the projected image and the screen is as shown on the right. Refer to the following table for installation.

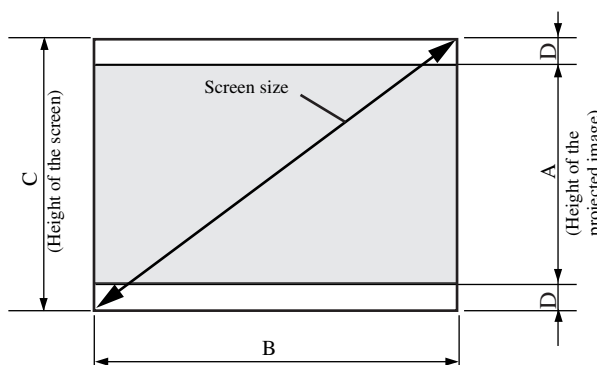

When the aspect ratio of the screen is 16:9

Screen size		Projected distance (L)				Hd					
16:9 Diagonal		Height A		Width B				Min.	Max.		
inch	cm	inch	cm	inch	cm	inch	m	inch	m	inch	cm
40	102	20	50	35	89	55	1.4	67	1.7	6.4	16.2
60	152	29	75	52	133	84	2.1	102	2.6	9.6	24.3
80	203	39	100	70	177	113	2.9	137	3.5	12.7	32.4
100	254	49	125	87	221	142	3.6	171	4.4	15.9	40.5
150	381	74	187	131	332	213	5.4	258	6.6	23.9	60.7
200	508	98	249	174	443	285	7.2	345	8.8	31.9	80.9
250	635	123	311	218	553	357	9.1	-	-	39.8	101.1
275	699	135	342	240	609	393	10.0	-	-	43.8	111.3

- The above figures are approximate and may be slightly different from the actual measurements.

When the aspect ratio of the screen is 4:3

Screen size		Size of the projected image				Blank space (D)		Project distance (L)				Hd					
4:3 Diagonal		Height C		Width B				Height A		Width B				Min.	Max.		
inch	cm	inch	cm	inch	cm	inch	cm	inch	cm	inch	m	inch	m	inch	cm		
40	102	24	61	32	81	18	46	32	81	3.0	8	51	1.3	62	1.6	5.8	14.9
60	152	36	91	48	122	27	69	48	122	4.5	11	77	2.0	94	2.4	8.8	22.3
80	203	48	122	64	163	36	91	64	163	6.0	15	103	2.6	125	3.2	11.7	29.7
100	254	60	152	80	203	45	114	80	203	7.5	19	130	3.3	157	4.0	14.6	37.1
150	381	90	229	120	305	67.5	171	120	305	11.3	29	196	5.0	237	6.0	21.9	55.7
200	508	120	305	160	406	90	229	160	406	15.0	38	262	6.6	316	8.0	29.2	74.3
250	635	150	381	200	508	112.5	286	200	508	188	48	327	8.3	-	-	36.6	92.8
300	762	180	457	240	610	135	343	240	610	22.5	57	393	10.0	-	-	43.9	111.4

- The above figures are approximate and may be slightly different from the actual measurements.

5 Connections

Preparations:

- Make sure that the power of the projector and that of the video equipment are turned off.

◆ Basic home theater system connection

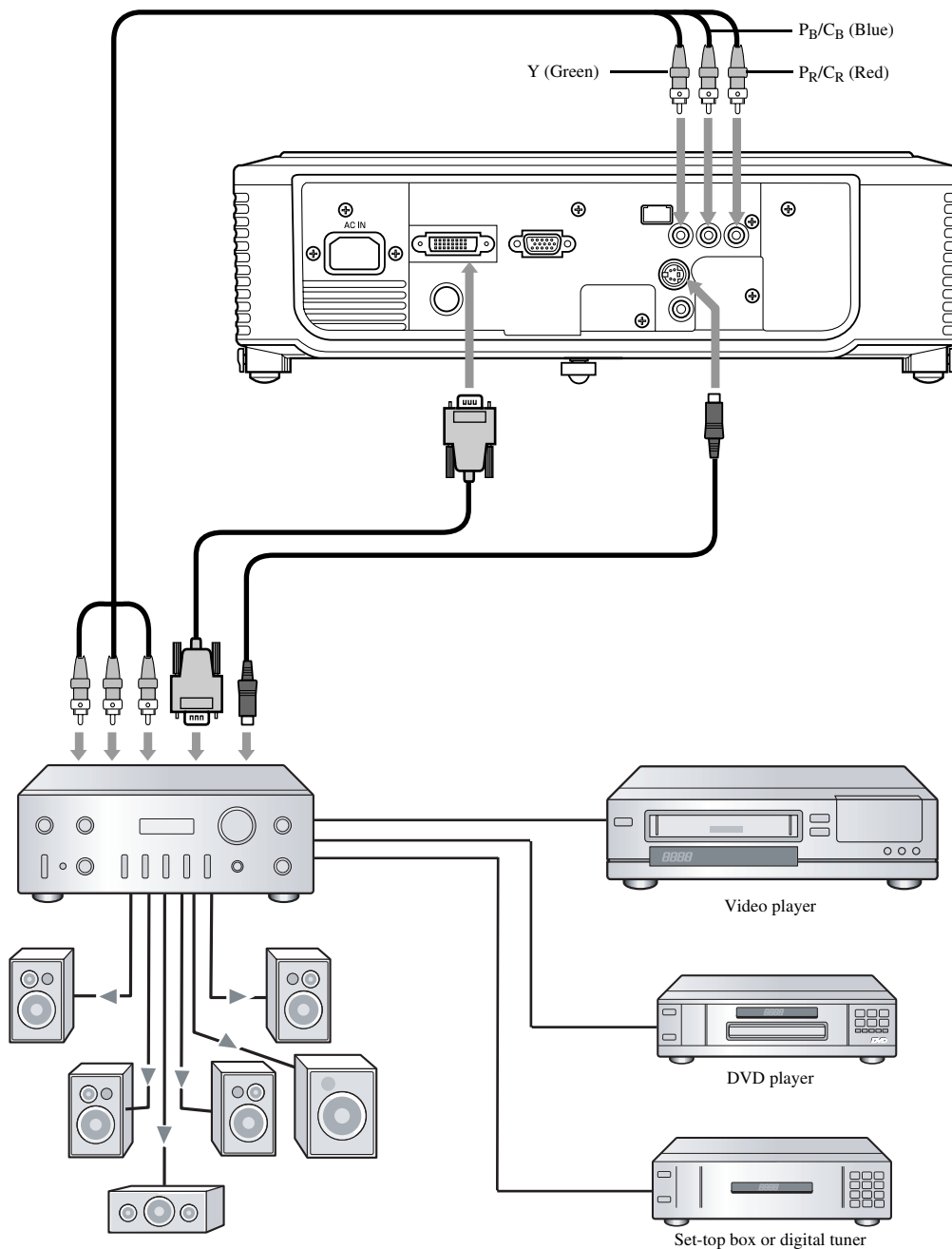

◆ Connecting to a video player, etc.

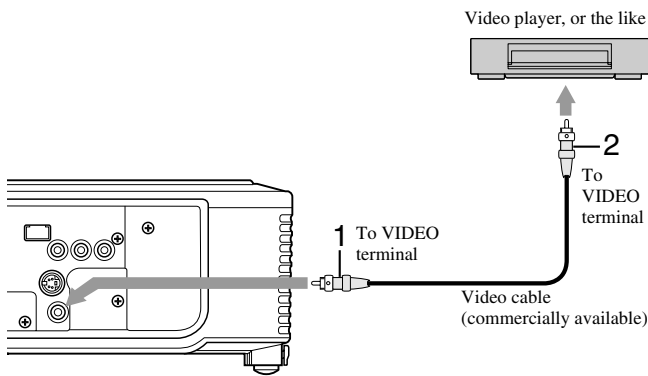

1. Connect one end (yellow) of a commercially available video cable to the VIDEO terminal of this projector.
2. Connect the other end (yellow) of the video cable to the VIDEO terminal of the video equipment.

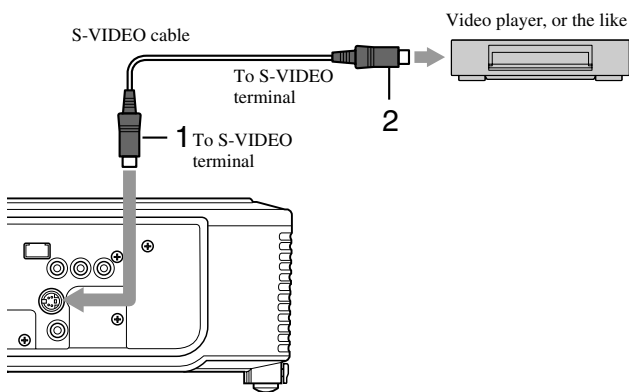

When the video equipment is equipped with the S-video terminal, make the connection as follows.

1. Connect one end of the supplied S-video cable to the S-VIDEO terminal of this projector.
2. Connect the other end of the S-video cable to the S-VIDEO terminal of the video equipment.
 - Read the instruction manual of the equipment to be connected.
 - Contact your dealer for details of connection.

When a TV tuner or VCR is connected:

When you use this projector with a TV tuner or VCR connected, no image may appear or a No Signal message may appear on the screen when you change to a channel that is not being received. In this case, set the channels of the TV tuner or VCR again. To avoid this problem, use the TV tuner or VCR with its channel skip function enabled. (Only channels that are being received will be displayed.)

◆ Connecting to a DVD player

To connect this projector to video equipment that has component video output terminals, such as a DVD player, use the COMPONENT terminals.

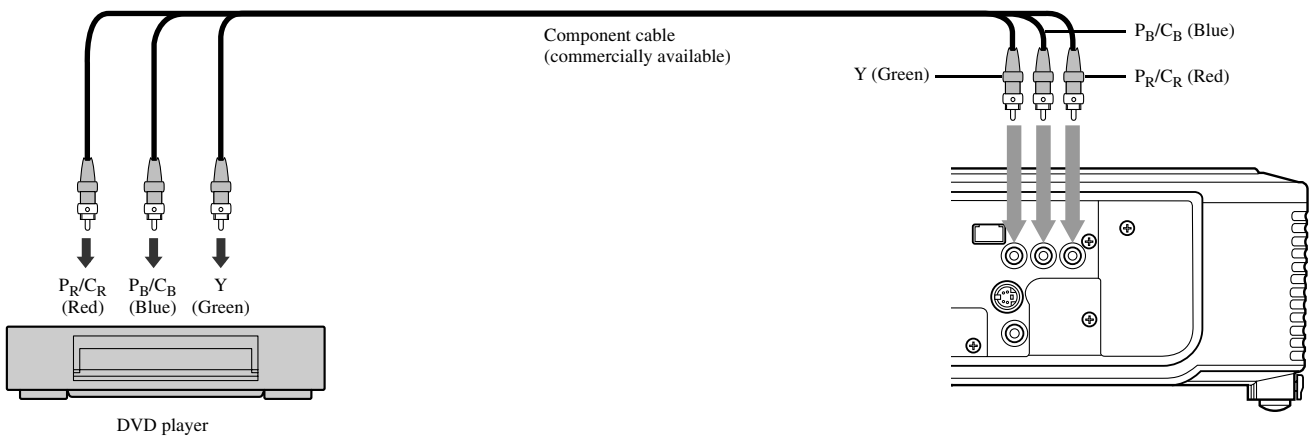

- Images may not be projected correctly depending on the type of DVD player you use.
- It may take some time before an image is displayed on the screen, depending on the type of the input signal; this is not a malfunction.

◆ DVI-D connections

You can project high-quality images by connecting the DVI terminal of this projector to video equipment having a DVI-D output terminal.

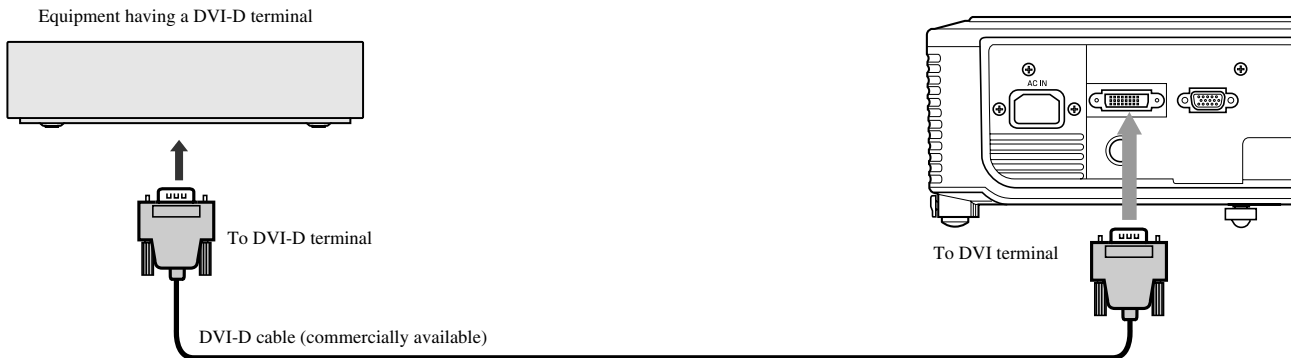

- For connection to the DVI terminal, use a commercially available DVI-D cable.
- Select DVI as the input source.
- Only RGB signals are supported. Component video signals are not supported.

When you connect this projector and a DVI-Digital device (such as a DVD player) via the DVI terminal, black color may appear light and pale, depending on the type of the connected device.

- This depends on the black level setting of the connected device. There are two kinds of methods to digitally transfer image data, in which different black level settings are employed respectively. Therefore, the specifications of the signals output from DVD players differ, depending on the type of the digital data transfer method they use.
- Some DVD players are provided with a function to switch the methods to output DVI-Digital signals. When your DVD player is provided with such function, set it as follows:
NORMAL → EXPAND or ENHANCED
- Refer to the users guide of your DVD player for details.
- When your DVD player does not have such function, set BRIGHTNESS of this projector to -16.

◆ D-SUB connections

You can project high-quality images by connecting the D-SUB terminal of this projector to video equipment having a D-SUB output or BNC terminal.

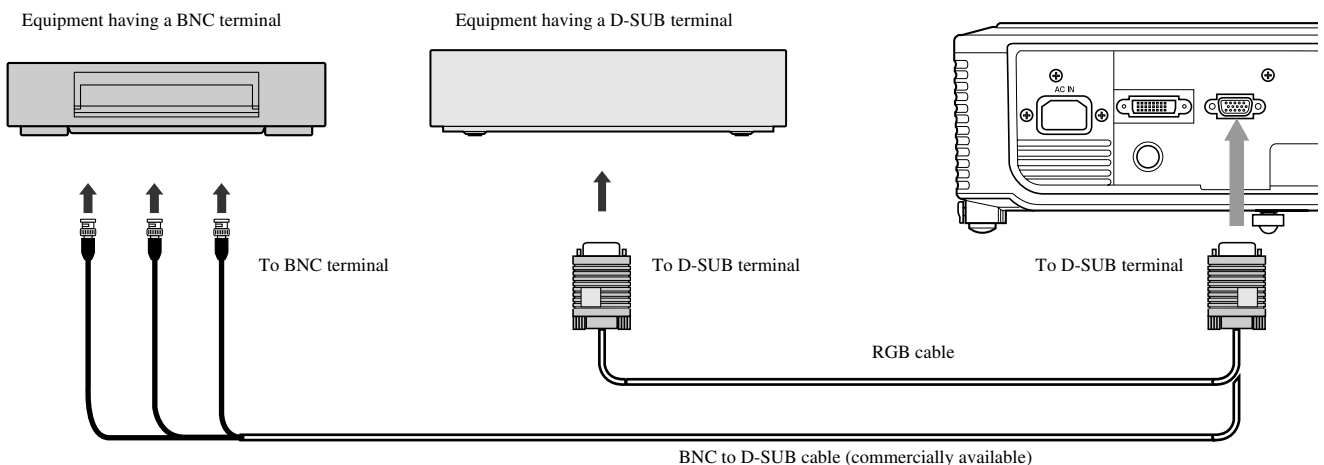

- For a connection from to the D-SUB terminal of this projector, use the supplied RGB cable.
- For video equipment with a BNC terminal, use a commercially available BNC to D-SUB cable to connect to this projector.

◆ Connecting the projector to a computer

Preparation:

- Make sure that the power of the projector and that of the computer are turned off.
- When connecting the projector to a desktop computer, disconnect the RGB cable that is connected to the monitor.

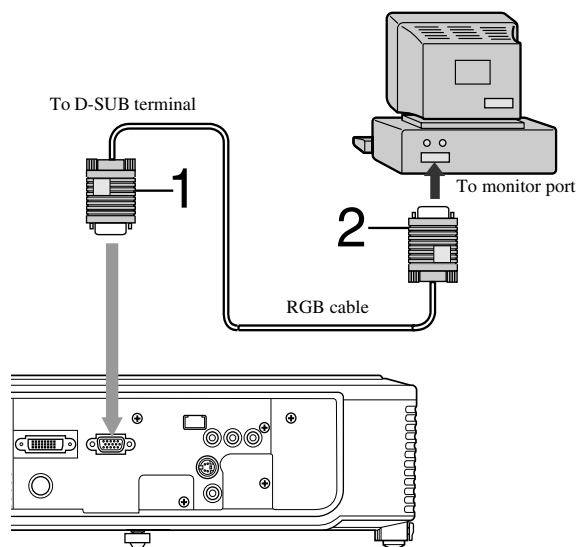

For analog connections:

1. Connect one end of the supplied RGB cable to the D-SUB terminal of this projector.
 2. Connect the other end of the RGB cable to the monitor port of the computer.
- Additional devices, such as a conversion connector and an analog RGB output adapter, are required depending on the type of the computer to be connected.
 - This projector does not support 3-line signals (SYNC-ON-GREEN signals).

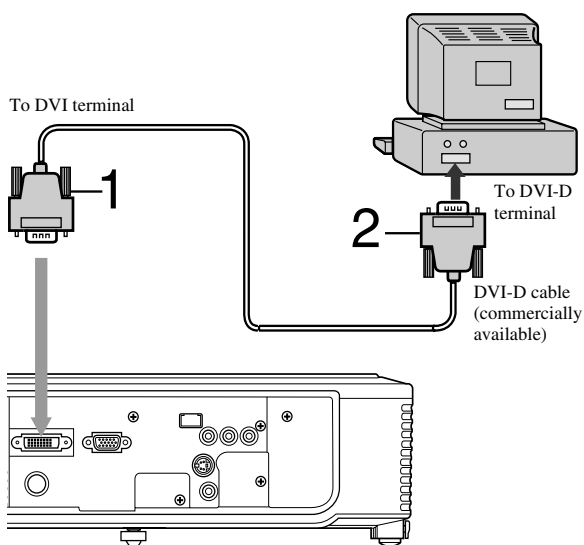

For digital connections:

1. Connect one end of a commercially available DVI-D cable to the DVI terminal of this projector.
 2. Connect the other end of the DVI-D cable to the DVI-D terminal of the computer.
- Additional devices, such as a conversion connector and an analog RGB output adapter, are required depending on the type of the computer to be connected.
 - When viewing images being input from a digital-connected computer, press the DVI button on the remote control.
 - Turn on the power of the projector before that of the computer.
 - Additional devices, such as a conversion connector and an analog RGB output adapter, are required depending on the type of the computer to be connected.
 - Using a long cable may decrease the quality of projected images.
 - Read the instruction manual of the equipment to be connected.
 - Images may not be projected correctly, depending on the type of the connected computer.
 - Contact your dealer for details of connection.

◆ Plugging in the power cable

For US

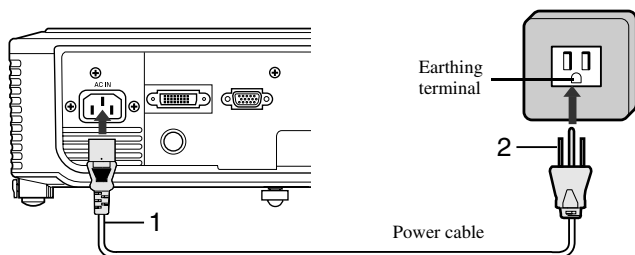

For Europe

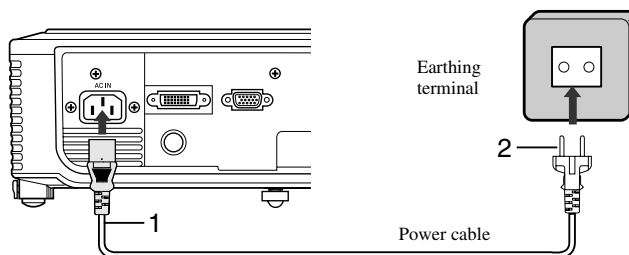

1. Plug the supplied power cable into the power cable inlet of this projector.
 2. Plug the other end of the power cable into a power outlet.
- The power cables for use in the U.S. and Europe are included with this projector. Use the appropriate one for your country.
 - This projector uses the power plug of three-pin grounding type. Do not take away the grounding pin from the power plug. If the power plug doesn't fit your wall outlet, ask an electrician to change the wall outlet.
 - The provided power cable for the U.S. is rated at 120 V. Never connect this cable to any outlet or power supply using other voltages or frequencies than rated. If you use a power supply using other voltage than rated, prepare an appropriate power cable separately.

6 Projection

◆ Viewing video images

Preparation:

- Turn on the power of the connected video equipment.

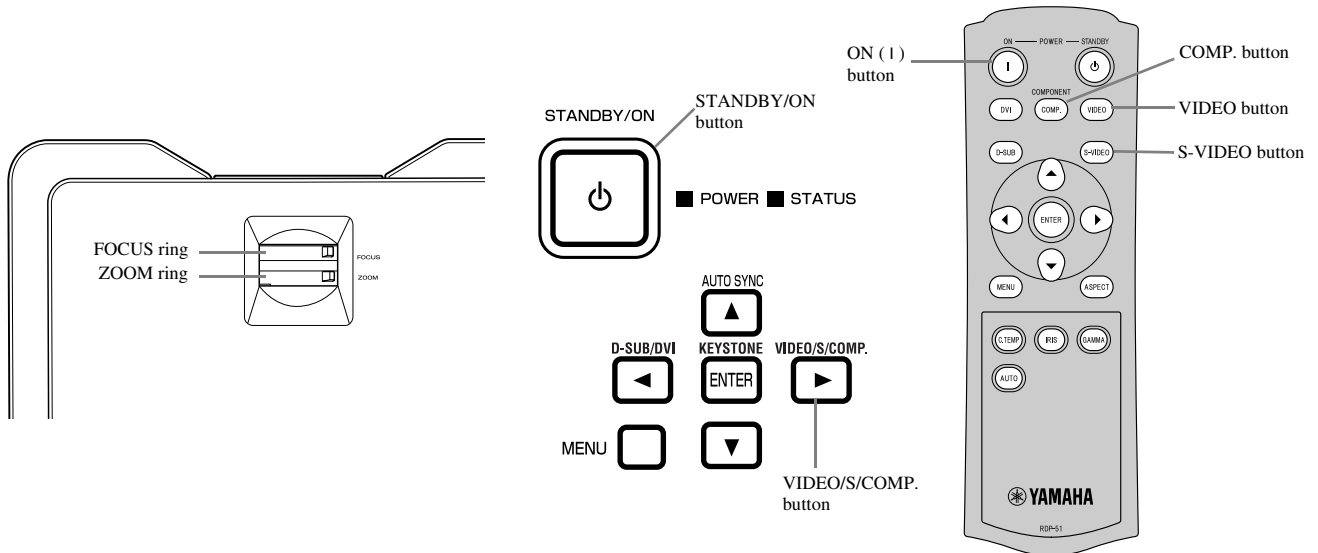

1. Confirm the POWER indicator lights up red.
 - If the projector was turned off before the lamp was cooled down sufficiently last time, the fan may start rotating and the STANDBY/ON button may not work after the power cable is plugged. (The STATUS indicator blinks green.) After the fan stops rotating, press the STANDBY/ON button to turn back on the POWER indicator.
 2. Press the STANDBY/ON button on the projector or ON (I) button on the remote control.
 - It may take about one minute for the lamp to light up.
 - The lamp fails to light up on rare occasions. If this happens, wait for a few minutes and then try again.
 - Do not cover the lens with the lens cap while the lamp is on.
 3. Select an input source.
 - Press the VIDEO / S / COMP. button on the projector or the VIDEO, S-VIDEO or COMP. button on the remote control that is corresponding to the terminal in use.
 - The input source is switched between VIDEO, S-VIDEO and COMPONENT at every press of the VIDEO / S / COMP. button on the projector.
 - There may be a delay before an image is displayed on the screen, depending on the type of the input signal; this is not a malfunction.
 - Some images become easier to view when the setting of aspect ratio is changed (see page 16).
 4. Adjust the position of the projector to keep an appropriate projection distance with which images are projected in their specified sizes.
 5. Adjust the position of the projector so that the projector and the screen are perpendicular to each other (see page 8).
 - When the projector cannot be positioned perpendicularly to the screen, adjust the projection angle (see page 8).
 6. Adjust the size of the projected image by turning the ZOOM ring.
 7. Adjust the focus by turning the FOCUS ring.
- Repeat steps 4 to 7, if necessary.

Important

- When a 4:3 image is continuously displayed for a long time before displaying a 16:9 image, the afterimages of the black bars may appear on the 16:9 image screen. Consult your dealer in this case.
- Do not display a still picture for a long time because the afterimages may persist on the screen.

To stop projecting:

1. Press the STANDBY/ON button on the projector or the STANDBY (⏻) button on the remote control.
 - A confirmation message is displayed.
 - To cancel the procedure, wait a while or press the MENU button.
2. Press the STANDBY/ON button on the projector or the STANDBY (⏻) button on the remote control again.
 - The lamp goes out and the projector goes into a cooling period. In this condition, the POWER indicator turns red and the STATUS indicator blinks green.
3. Wait about one minute for the STATUS indicator to be off and the POWER indicator to be steadily lit in red.
 - During this one minute period, the intake fan and exhaust fan rotate to cool the lamp.
 - Do not unplug the power cable while the STATUS indicator is blinking. Unplugging the power cable immediately after use may cause a breakdown.
 - The fan may make loud sounds during cooling; this is not a malfunction.

KEYSTONE adjustment

With the control area of the projector:

1. Press the KEYSTONE (ENTER) button on the control area of the projector.
2. Equalize the widths at the top and bottom of the screen by pressing the ▲ or ▼ button, viewing the screen.

With the SETUP menu:

(See page 19 for menu setting.)

1. Display the SETUP menu.
2. Select KEYSTONE by pressing the ▲ or ▼ button.
3. Equalize the widths at the top and bottom of the screen by pressing the ◀ or ▶ button, viewing the screen.

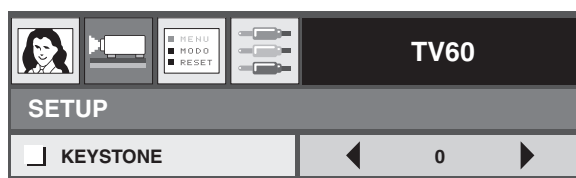

To cancel the menu:

4. Press the MENU button several times.

Important

- When the keystone adjustment is applied, the correct aspect ratio may not be obtained.
- When the keystone adjustment is applied, the resolution lowers. In addition, vertical stripes appear and straight lines bend in images with complicated patterns. To prevent such symptoms, keep the screen and the projector perpendicular to each other as much as possible.
- Though the projected image may be distorted momentarily when you change the setting value of the keystone adjustment, such symptom is not a malfunction.
- Though the projected image may be distorted depending on the setting value of the keystone adjustment and the type of the input signal, such symptom is not a malfunction. In such a case, adjust the setting value within the range where the projected image is not distorted.
- The setting value displayed at the time of the keystone adjustment may vary depending on the type of the input signal.











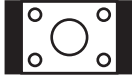



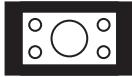



IRIS button

Use to adjust the brightness and contrast of the image depending on the brightness level in the room.

1. Press the IRIS button on the remote control.
2. Adjusts the brightness and contrast of the image by pressing the ▲ or ▼ button, viewing the screen. Every time the ▲ button is pressed, the image becomes brighter and more defined, suitable for TV viewing in a well-lit room. Every time the ▼ button is pressed, the image becomes darker and the contrast is increased, suitable for watching movies in dim lighting.

Setting the aspect ratio

You can change the aspect ratio of the input video signal (or the ratio of width to height of the image). Change the setting according to the type of the input video signal.

	NORMAL	SQUEEZE	ZOOM	THROUGH
Original image size	Projects images with an aspect ratio of 4:3 when the input signal is 4:3 image.	Projects images with an aspect ratio of 16:9.	Projects images in the CinemaScope size or Vista size together with subtitles.	Projects images in their original size as input.
 4:3 image (480i, 576i, 480p, 576p, and PC)			 Available only when the input signal is 480i, 576i, 480p or 576p.	
 4:3 CinemaScope and Vista image			 Available only when the input signal is 480i, 576i, 480p or 576p.	
 Squeezed 4:3 (480i, 576i, 480p, 576p)			 Available only when the input signal is 480i, 576i, 480p or 576p.	
 16:9 image (1080i)			Not available.	Not available.
 16:9 image (720p)			Not available.	Not available.

Bold frames  are recommended modes.

Changing the settings

With the remote control:

- Press the ASPECT button.
 - Every time the ASPECT button is pressed, the aspect mode changes from DEFAULT to NORMAL, to SQUEEZE, to ZOOM, to THROUGH, and back to DEFAULT. DEFAULT is automatically set to either NORMAL or SQUEEZE depending on the input signal.

With the INITIAL menu:

(See page 19 for menu setting.)

- Display the INITIAL menu.
- Select ASPECT by pressing the ▲ or ▼ button.
- Select your desired aspect ratio by pressing the ◀ or ▶ button.

To cancel the menu:

- Press the MENU button.

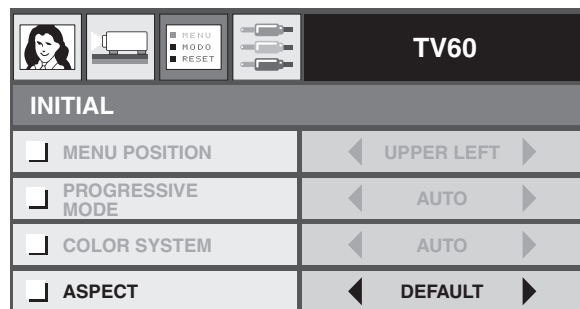

◆ Viewing computer images

Preparation:

- Turn on the power of the connected computer.

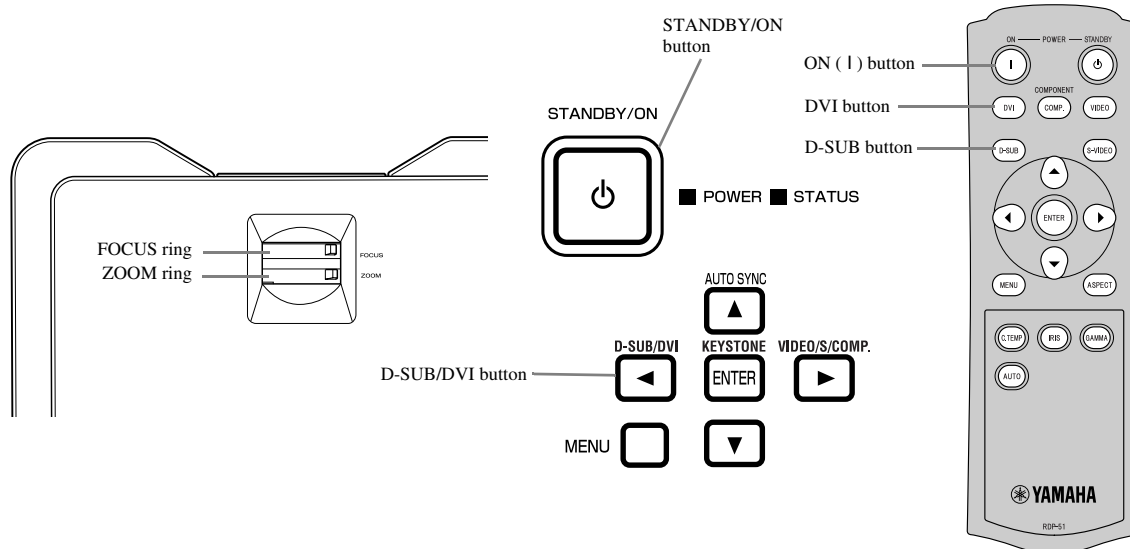

1. Confirm the POWER indicator lights up red.
 - If the projector was turned off before the lamp was cooled down sufficiently last time, the fan may start rotating and the STANDBY/ON button may not work after the power cable is plugged. (The STATUS indicator blinks green.) After the fan stops rotating, press the STANDBY/ON button to turn back on the POWER indicator.
 2. Press the STANDBY/ON button on the projector or ON (I) button on the remote control.
 - It may take about one minute for the lamp to light up.
 - The lamp fails to light up on rare occasions. If this happens, wait for a few minutes and then try again.
 - Do not cover the lens with the lens cap while the lamp is on. Do not strip off the aluminium sheet inside the lens cap.
 3. Select an input source.
 - Press the D-SUB / DVI button on the projector or the D-SUB, DVI button on the remote control that is corresponding to the terminal in use.
 - The input source is switched between D-SUB and DVI at every press of the D-SUB / DVI button on the projector.
 - There may be a delay before an image is displayed on the screen, depending on the type of the input signal; this is not a malfunction.
 - Images may not be projected in the correct position, depending on the type of the input signal. If this happens, press the AUTO SYNC button on the projector or the AUTO button on the remote control (see page 18).
 4. Adjust the position of the projector to keep an appropriate projection distance with which images are projected in their specified sizes.
 5. Adjust the position of the projector so that the projector and the screen are perpendicular to each other (see page 8).
 - When the projector cannot be positioned perpendicularly to the screen, adjust the projection angle (see page 8).
 6. Adjust the size of the projected image by turning the ZOOM ring.
 7. Adjust the focus by turning the FOCUS ring.
- Repeat steps 4 to 7, if necessary.

AUTO / AUTO SYNC buttons

When the image being input from the computer is displaced, carry out the following procedure:

1. When the screen saver has been enabled, disable it.
2. Display a bright image (such as a full-screen display of the Recycle Bin window).
3. Press the AUTO button on the remote control or the AUTO SYNC (▲) button on the projector.
The projector automatically makes optimum positional settings for the input signal.
 - If the image is not projected in the correct position even after you press the AUTO or AUTO SYNC (▲) button several times, change the settings in the SIGNAL menu to put the image in the correct position (see page 26).
 - When you carry out this procedure with a dark image, the image may be displaced.

When connected to a notebook computer:

When the projector is connected to a notebook computer, images may not be projected in some cases. If this happens, set the computer so that it can output signals externally. The setting procedure varies depending on the type of the computer. See the user manual of your computer.

To stop projecting:

1. Press the STANDBY/ON button on the projector or the STANDBY (⏻) button on the remote control.
 - A confirmation message is displayed.
 - To cancel the procedure, wait a while or press the MENU button.
2. Press the STANDBY/ON button on the projector or the STANDBY (⏻) button on the remote control again.
 - The lamp goes out and the projector goes into a cooling period. In this condition, the POWER indicator turns red and the STATUS indicator blinks green.
3. Wait about one minute for the STATUS indicator to be off and the POWER indicator to be steadily lit in red.
 - During this one minute period, the intake fan and exhaust fan rotate to cool the lamp.
 - Do not unplug the power cable while the STATUS indicator is blinking. Unplugging the power cable immediately after use may cause a breakdown.
 - The fan may make loud sounds during cooling; this is not a malfunction.

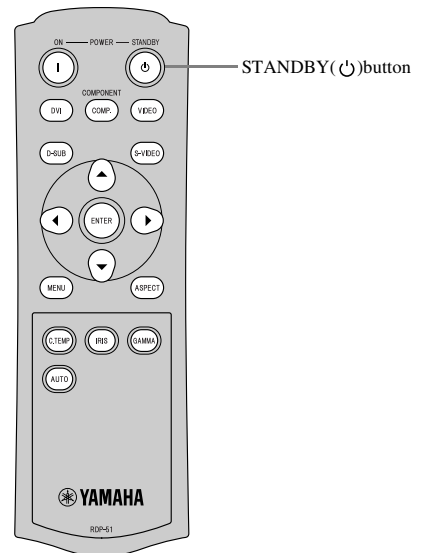
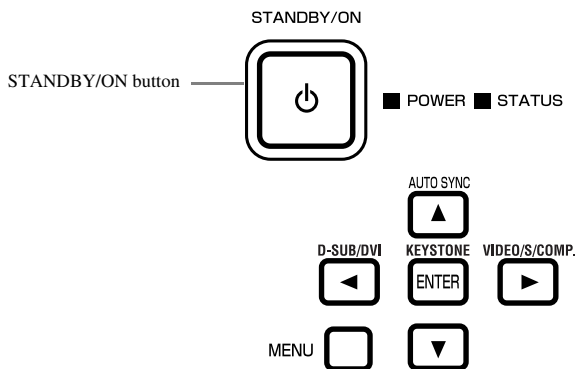

7 Menu

◆ Menu overview

Menus are not displayed when no signal is received by the projector.

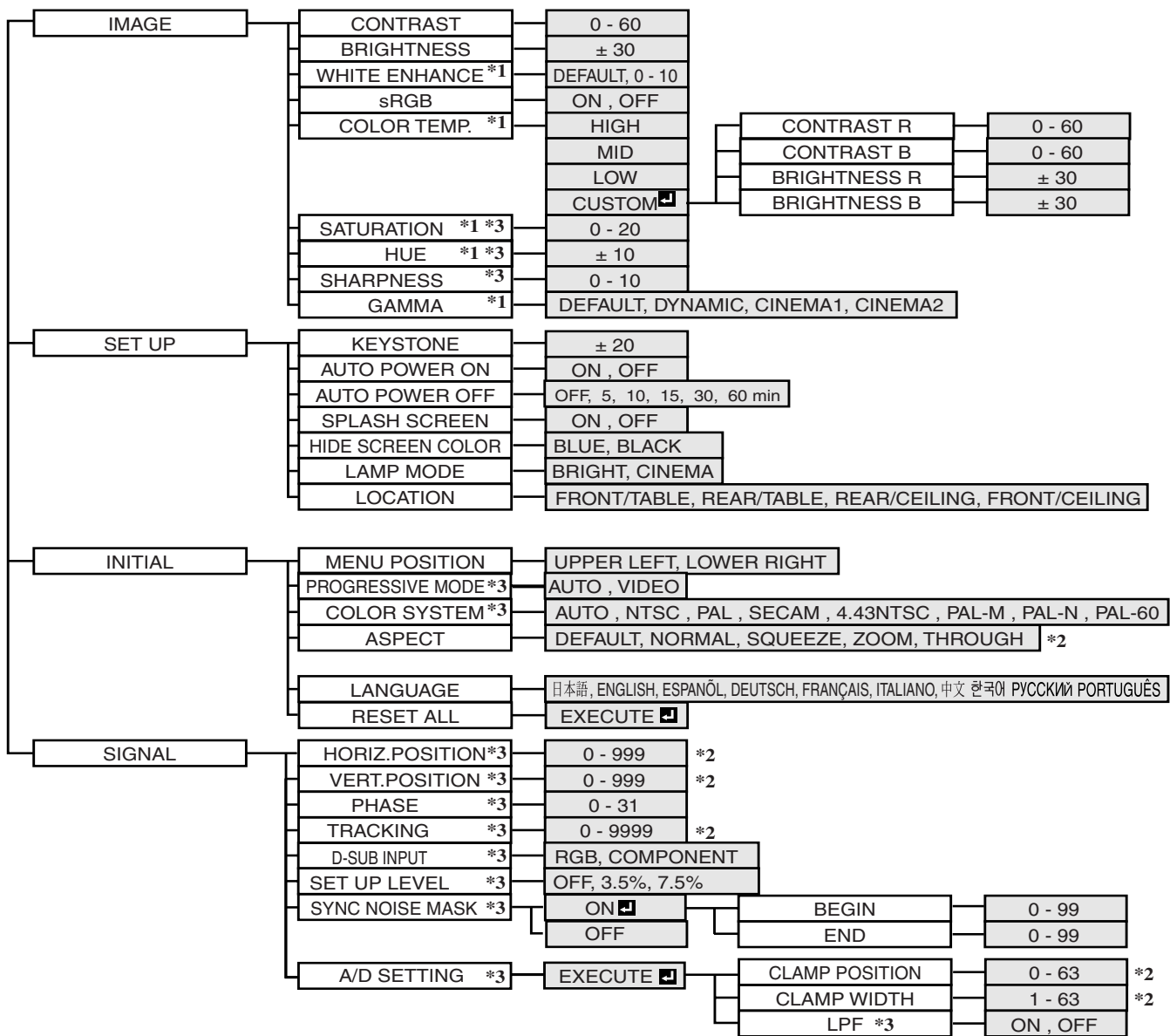

After selecting the items marked with , press the ENTER button.

*1: Not available when sRGB is set to ON.

*2: Setting range differs depending on the input signals.

*3: Refer to the chart below for availability / unavailability.

SATURATION	Unavailable when the input source is DVI or the D-SUB source is an RGB signal.
HUE	Available only when the VIDEO or S-VIDEO source is an NTSC-M or NTSC-4.43 signal.
SHARPNESS	Unavailable when the D-SUB or DVI source is a computer signal.
PROGRESSIVE MODE	Available only when the input signal is TV50, TV60, 480i or 576i.
COLOR SYSTEM	Available only when the input source is VIDEO or S-VIDEO.
HORIZ. POSITION	Unavailable when the DVI source is a computer signal.
VERT. POSITION	Unavailable when the DVI source is a computer signal.
PHASE	Unavailable when the input source is VIDEO, S-VIDEO or DVI.
TRACKING	Available only when the D-SUB source is a computer signal.
D-SUB INPUT	Available only when the input source is D-SUB, except 480i and 576i.
SET UP LEVEL	Unavailable when the D-SUB or DVI source is a computer signal.
SYNC NOISE MASK	Unavailable when the input source is VIDEO, S-VIDEO or DVI.
A/D SETTING	Unavailable when the input source is VIDEO, S-VIDEO or DVI.
LPF	Available only when the COMPONENT or D-SUB source is a 480i, 480p, 576i or 576p signal.

How to set the menus

Following describe how to set AUTO POWER OFF time as an example.

1. Press the MENU button.

- If no signal is input, the menu does not appear.



2. Press the ◀ or ▶ button to select a menu to use.



3. Press the ENTER button (or ▼ button).

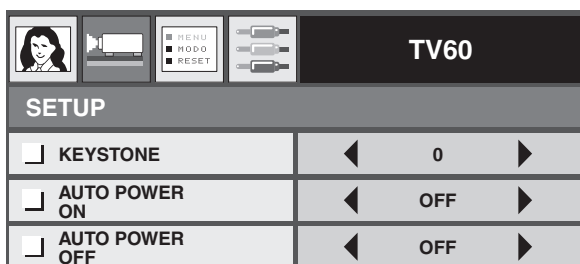

4. Press the ▲ or ▼ button to select an item to adjust.



5. Set the selected item by pressing the ◀ or ▶ button.



To cancel the menu:

6. Press the MENU button several times.

Important

- If the MENU button doesn't function, unplug the power cable from the wall outlet. Wait about 10 minutes, plug the power cable in, and try again.

◆ Menu settings

Set the following items on their relevant menus.

1. IMAGE menu

TV60	
IMAGE	
CONTRAST	◀ 0 ▶
BRIGHTNESS	◀ 0 ▶
WHITE ENHANCE	◀ DEFAULT ▶
sRGB	◀ OFF ▶
COLOR TEMP.	◀ MID ▶
SATURATION	◀ 0 ▶
HUE	◀ 0 ▶
SHARPNESS	◀ 0 ▶
GAMMA	◀ DEFAULT ▶

2.SETUP menu

TV60	
SETUP	
KEYSTONE	◀ 0 ▶
AUTO POWER ON	◀ OFF ▶
AUTO POWER OFF	◀ OFF ▶
SPLASH SCREEN	◀ ON ▶
HIDE SCREEN COLOR	◀ BLUE ▶
LAMP MODE	◀ BRIGHT ▶
LOCATION	◀ FRONT/TABLE ▶

3.INITIAL menu

TV60	
INITIAL	
MENU POSITION	◀ UPPER LEFT ▶
PROGRESSIVE MODE	◀ AUTO ▶
COLOR SYSTEM	◀ AUTO ▶
ASPECT	◀ DEFAULT ▶
LANGUAGE	◀ ENGLISH ▶
RESET ALL	EXECUTE

4.SIGNAL menu

TV60	
SIGNAL	
HORIZ. POSITION	◀ 78 ▶
VERT. POSITION	◀ 22 ▶
PHASE	◀ 0 ▶
TRACKING	◀ 0 ▶
D-SUB INPUT	◀ RGB ▶
SET UP LEVEL	◀ 7.5% ▶
SYNC NOISE MASK	◀ OFF ▶
A/D SETTING	EXECUTE

1. IMAGE menu

ITEM	SETTING	FUNCTION
CONTRAST	0 – 60	Use to adjust the contrast of the projected image (see page 24).
BRIGHTNESS	±30	Use to adjust the brightness of the projected image (see page 24).
WHITE ENHANCE	DEFAULT	The appropriate white enhance value is automatically selected depending on the input signal. Select DEFAULT for normal use.
	0 – 10	Use to adjust the white level of the projected image (see page 24).
sRGB	ON / OFF	Select whether or not to project emphasizing on the color reproducibility.
COLOR TEMP.	HIGH	Select for a high color temperature (see page 25).
	MID	Select for a balanced color temperature (see page 25)
	LOW	Select for a low color temperature (see page 25)
	CUSTOM	Use to customize the color temperature (see page 25)
SATURATION	0 – 20	Use to adjust the color richness of the projected image (see page 24).
HUE	±10	Use to adjust the color tint of the projected image (see page 24).
SHARPNESS	0 – 10	Use to adjust the sharpness of the projected image (see page 24).
GAMMA	DEFAULT	The appropriate gamma mode is automatically selected depending on the input signal. Select DEFAULT for normal use.
	DYNAMIC	Select to secure the contrast even when the room lighting is increased to some extent.
	CINEMA1	Select when watching movies in dim lighting as in a theater.
	CINEMA2	Select to gain the halftone to make the skin color more vibrant even in a dark scene. This mode is suitable for TV viewing.

2. SETUP menu

ITEM	SETTING	FUNCTION
KEYSTONE	±20	Use to correct vertical keystone distortion.
AUTO POWER ON	ON / OFF	When ON is selected, the lamp is automatically lit when the power cable is plugged in the wall outlet. The projector is in the stand-by mode when the lamp is off. Use the remote control to turn on the lamp.
AUTO POWER OFF	OFF / 5 – 60min	Use to set the time elapsed before the projector enters the stand-by mode when there is no signal input from the source.
SPLASH SCREEN	ON / OFF	Select ON to display the splash screen when the power is turned on
HIDE SCREEN COLOR	BLUE / BLACK	Use to change the color of the screen that appears when no signal is received.
LAMP MODE	BRIGHT CINEMA	Select when using the projector in a bright environment. Select to moderate the intensity of the lamp. The operating sound is reduced and the lamp lifetime becomes longer. Frequent switching of the lamp mode may damage the lamp.
LOCATION	FRONT / TABLE REAR / TABLE REAR / CEILING FRONT / CEILING	Select when viewing images from the front with the projector installed on the floor. Select when viewing images projected from behind of the screen with the projector installed on the floor. Select when viewing images projected from behind of the screen with the projector installed on the ceiling. Select when viewing images from the front with the projector installed on the ceiling.

3. INITIAL menu

ITEM	SETTING	FUNCTION
MENU POSITION	2 positions	Use to change the position of the menu.
PROGRESSIVE MODE	AUTO VIDEO	The film mode will be automatically activated when a film source signal is inputted. The film mode will not be activated.
COLOR SYSTEM	8 positions	When AUTO is selected, the appropriate video format is automatically selected depending on the input signal. If the image isn't displayed correctly, select the desired video format manually.
ASPECT	DEFAULT NORMAL SQUEEZE ZOOM THROUGH	The appropriate aspect ratio is automatically selected depending on the input signal. Select DEFAULT for normal use. Select to project images with an aspect ratio of 4:3 when the input signal is 4:3 image. Select to project images with an aspect ratio of 16:9. Select to enlarge and project images of CinemaScope size or Vista size. Select to project images in their original size as input. Not available when the keystone adjustment is applied.
LANGUAGE	10 languages	Use to select the language used in the menus.
RESET ALL	EXECUTE 	Use to reset the settings of the menu (excluding LANGUAGE) to the factory setting values.

4. SIGNAL Menu

ITEM	SETTING	FUNCTION
HORIZ. POSITION	0 – 999	Use to adjust the horizontal position of the projected image.
VERT. POSITION	0 – 999	Use to adjust the vertical position of the projected image.
PHASE	0 – 31	Use to eliminate flickering or blur, if it appears, while viewing the projected image.
TRACKING	0 – 9999	Use to eliminate vertical wide stripes, if it appears, while viewing the projected image.
D-SUB INPUT	RGB	Select this option when connecting the projector to high definition video equipment having R, G, and B output terminals.
	COMPONENT	Select this option when connecting the projector to a DVD player or other device having Y, C _B , and C _R (or Y, P _B , and P _R) component video output terminals.
SET UP LEVEL	OFF	Select to make black lighter.
	3.5% / 7.5% (U.S.)	Select to make black darker. <ul style="list-style-type: none"> When 7.5% is chosen, the brightness is decreased by set-up cancel function for U.S. Choose OFF, when the image is dark.
SYNC NOISE MASK	ON <input checked="" type="checkbox"/> / OFF	Use to adjust the image when flagging occurs near the top of the screen.
	BEGIN	Use to adjust the start of the sync noise mask position.
	END	Use to adjust the end of the sync noise mask position.
A/D SETTING	EXECUTE <input checked="" type="checkbox"/>	Use to adjust the Analog Digital conversion parameters.
	CLAMP POSITION	Use to correct solid white or solid black in the projected image.
	CLAMP WIDTH	
	LPF	Use to whether or not to enable the LPF.

- Horizontal strips may appear on the enlarged projected image; this is not a malfunction.
- When you change the horizontal or vertical position to a large extent, noise may appear.
- The adjustable range of the vertical position varies depending on the type of the input signal. In some cases, the image may stay in the same position even when the setting value is changed; this is not a malfunction.
- D-SUB INPUT will automatically be set to either RGB or COMPONENT depending on the input signal.
- DEFAULT depends on the two signal types below:
 1. Video signals (TV50, TV60, 480i/p, 576i/p, 720p50/60, 1080i50/60)
 2. Computer signals (VGA, XGA, etc.)

Refer to page 36 for a complete listing.

8 Adjusting video images

◆ Adjusting brightness (CONTRAST and BRIGHTNESS)

You can make adjustments for the brightness of the projected image using the menu (see page 21).

1. Display the IMAGE menu.
2. Select CONTRAST or BRIGHTNESS by pressing the ▲ or ▼ button.
3. Adjust the selected item by pressing the ◀ or ▶ button.

To cancel the menu:

4. Press the MENU button

CONTRAST

Select to adjust the contrast of the image. Every time the ▶ button is pressed, the image becomes brighter. Every time the ◀ button is pressed, the image becomes darker.

BRIGHTNESS

Every time the ▶ button is pressed, the image becomes brighter. Every time the ◀ button is pressed, the image becomes darker.

◆ Enhancing the white level (WHITE ENHANCE)

You can adjust the white level of the projected image using the menu (see page 21). Select DEFAULT for normal use.

1. Display the IMAGE menu.
2. Select WHITE ENHANCE by pressing the ▲ or ▼ button.
3. Adjust the selected item by pressing the ◀ or ▶ button.

To cancel the menu:

4. Press the MENU button.

◆ Adjusting the white tone (to select COLOR TEMP.)

You can select a preset color temperature (white tone) using the menu (see page 21).

1. Display the IMAGE menu.
2. Select COLOR TEMP. by pressing the ▲ or ▼ button.
3. Select your desired color temperature by pressing the ◀ or ▶ button.

To cancel the menu:

4. Press the MENU button.

◆ Adjusting the white tone (to customize COLOR TEMP.)

To customize (and store) the color temperature to your preference, carry out the following procedure.

1. Select COLOR TEMP. in the IMAGE menu (see page 21).
2. Press the ◀ or ▶ button to select CUSTOM .
3. Press the ENTER button.
4. Press the ▲ or ▼ button to select the desired item.
5. Press the ◀ or ▶ button to adjust the selected item.
6. Repeat steps 4 and 5 for optimum adjustment results.

To cancel the menu:

7. Press the MENU button.

To enable the stored color temperature:

1. Select CUSTOM by pressing the COLOR TEMP button on the remote control.

About color temperature

There are different kinds of white color. Color temperature is a way to show the differences in white. When its temperature is low, white appears reddish. When the color temperature rises, white appears bluish. This projector adjusts this color temperature by changing the values of the blue and red contrasts.

To raise the color temperature:

Increase the CONTRAST B (blue) and decrease the CONTRAST R (red).

To reduce the color temperature:

Decrease the CONTRAST B (blue) and increase the CONTRAST R (red).

◆ Adjusting color (SATURATION and HUE)

You can adjust the color of the projected image using the menu (see page 21).

1. Display the IMAGE menu.
2. Select SATURATION or HUE by pressing the ▲ or ▼ button.
 - SATURATION is unavailable when the D-SUB source is an RGB signal or DVI is selected as the input source.
 - HUE is available only when the NTSC signal is input.
3. Adjust the selected item by pressing the ◀ or ▶ button.

To cancel the menu:

4. Press the MENU button.

SATURATION

Use to adjust the color richness of the projected image. Every time the ▶ button is pressed, the color becomes richer. Every time the ◀ button is pressed, the color becomes lighter.

- SATURATION is unavailable when the D-SUB source is an RGB signal or DVI is selected as the input source.

HUE

Use to adjust the tint of the projected image. Every time the ▶ button is pressed, the image appears more greenish. Every time the ◀ button is pressed, the image appears more reddish.

- Hue is available only when the NTSC signal is input.

◆ Sharpening or softening images (SHARPNESS)

You can adjust the sharpness of the projected image using the menu (see page 21).

1. Display the IMAGE menu.
2. Select SHARPNESS by pressing the ▲ or ▼ button.
3. Adjust the selected item by pressing the ◀ or ▶ button.

To cancel the menu:

4. Press the MENU button.

◆ LPF (Progressive filter)

You can select whether or not to enable the LPF. This item is normally set to OFF.

Vertical or horizontal streak noise may appear on the projected image, depending on the type of the DVD player you use. In such a case, you can reduce such streak noise by enabling the LPF. However, projected images become softened slightly.

1. Select A/D SETTING in the SIGNAL menu.
2. Press the ▲ or ▼ button to select EXECUTE .
3. Press the ENTER button.
4. Press the ▲ or ▼ button to select LPF.
5. Press the ◀ or ▶ button to choose ON or OFF.

To cancel the menu:

6. Press the MENU button.

EXECUTE	
<input type="checkbox"/> CLAMP POSITION	◀ 0 ▶
<input type="checkbox"/> CLAMP WIDTH	◀ 1 ▶
<input type="checkbox"/> LPF	◀ OFF ▶

9 MEMORY function

◆ MEMORY function

The memory function saves all of the parameters for the IMAGE menu and the SET UP LEVEL in the SIGNAL menu depending on the input terminal.

- CONTRAST
- BRIGHTNESS
- WHITE ENHANCE
- sRGB
- COLOR TEMP.
- SATURATION
- HUE
- SHARPNESS
- GAMMA
- SET UP LEVEL

10 Adjusting computer images

This projector automatically and properly projects video signals supplied from the computer. However, some video signals may not be projected, depending on the type of the computer. In such a case, press the AUTO POSITION button on the projector or the AUTO button on the remote control (see page 18). When the signal is still not projected properly, adjust the projected image using the SIGNAL menu.

◆ Adjusting computer images

Carry out the following procedures according to the symptoms.

Wide strips appear..... Adjust TRACKING in the SIGNAL menu.

The projected image flickers.

The projected image is blurred. Adjust PHASE in the SIGNAL menu.

The projected image is displaced horizontally..... Adjust HORIZ. POSITION in the SIGNAL menu. Every time the ◀ button is pressed, the image moves to the right. Every time the ▶ button is pressed, the image moves to the left.

The projected image is displaced vertically. Adjust VERT. POSITION in the SIGNAL menu. Every time the ◀ button is pressed, the image moves down. Every time the ▶ button is pressed, the image moves up.

1. Display the SIGNAL menu.
2. Press the ▲ or ▼ button to select an item to adjust.
3. Adjust the selected item by pressing the ◀ or ▶ button.

To cancel the menu:

4. Press the MENU button.
 - Do not change the settings of the SIGNAL menu in normal use.

Simple method to adjust the image position

To adjust the horizontal position:

1. Align the left edge of the image with the left side of the screen by adjusting HORIZ. POSITION. Then, align the right edge of the image with the right side of the screen by adjusting TRACKING.
2. Repeat the previous step to complete the adjustment of the horizontal position.

To adjust the vertical position:

3. Align the upper edge of the image with the upper side of the screen by adjusting VERT. POSITION.

11 Ceiling installation

◆ Viewing ceiling mounted projector images

To view images projected by the ceiling mounted projector from the front:

When the projector is installed on the ceiling, the special ceiling mount bracket, which is commercially available, is required. Be sure to ask a certified installation specialist for installation of the projector. Contact your dealer for details.

- Yamaha assumes no responsibilities for any damage caused by use of other manufacturer s ceiling bracket and by inadequate installation conditions even within the warranty period.

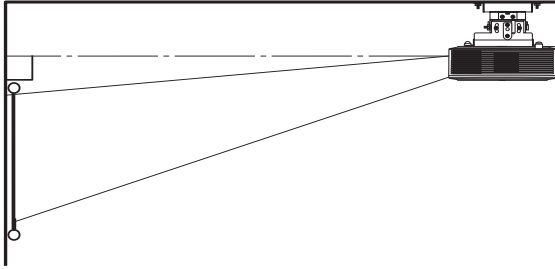

- When installing the projector on the ceiling, set LOCATION in the SETUP menu to FRONT / CEILING.
- Ask your installation specialist to provide a breaker. When you do not use the projector, be sure to shut down the main power by the breaker.
- When the projector is installed on the ceiling, projected images may appear darker than those projected when the projector is installed on the floor. This is not a malfunction.
- Do not install the projector where the exhaust vents are exposed to air emitted by an air conditioning. Such installation may cause a breakdown.
- Do not install the projector near a fire alarm because it emits hot air from its exhaust vents.

Optional part

Ceiling mount bracket PMT-L71 (low ceilings)
 PMT-H75 (high ceilings)

To view images projected on a translucent screen from behind:

Be sure to ask a certified installation specialist for installation of the projector. Contact your dealer for details.

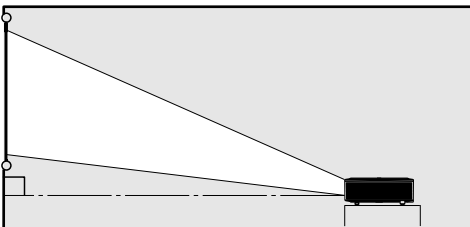

- To view images projected from behind the screen, set LOCATION in the SETUP menu to REAR/TABLE.

◆ Dimension Drawings (unit: mm)

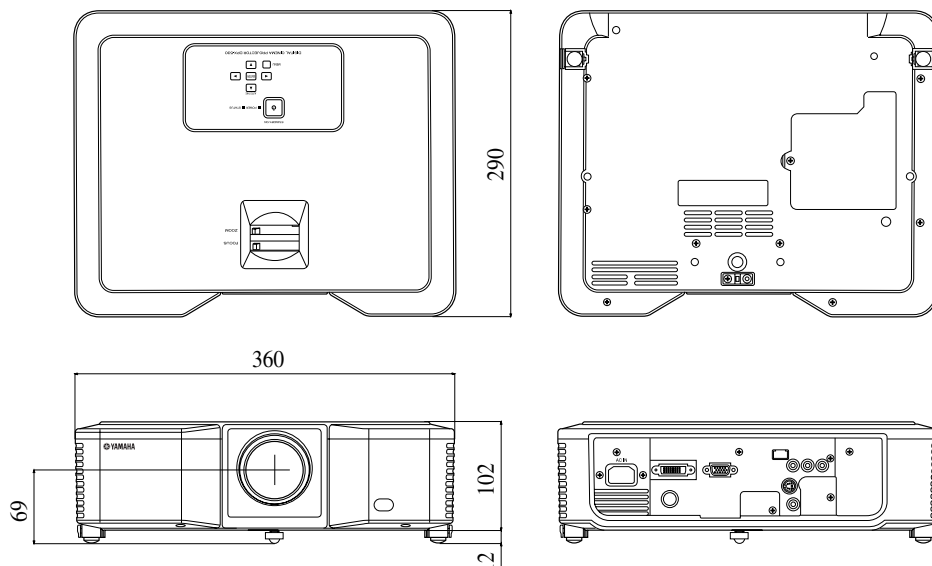

12 Replacing the lamp

This projector is equipped with a lamp to project images. This lamp is a consumable, so it may burn out or its brightness may decrease during use. If this happens, replace the lamp with a new one as soon as possible. Be sure to replace the lamp with a new, commercially available lamp that is exclusive to this projector. Contact your dealer for purchase of the lamp.

Warning

- Be careful not to drop the lamp screws into the projector. Do not put a metal piece or flammable object into the projector. Using the projector with any foreign object present inside may result in electric shock or fire. If you can't remove the foreign object from the inside, contact your dealer for removal.
- Be sure to install the lamp securely. If the lamp is not installed properly, it will not illuminate. Improper installation may also result in fire.
- Do not shake the removed lamp or lift it above your face. You may injure your eye by flying or falling glass fragments.
- Do not replace the lamp immediately after use because the lamp cover is very hot. You may get burned. Turn off the power using the STANDBY/ON button. After the lamp goes out, wait about two minutes until the intake and exhaust fans for cooling the lamp stop rotating. Then unplug the power cable, and wait at least one hour to allow the lamp to cool down enough to the touch.

◆ Interval of lamp replacement

The recommended interval of lamp replacement is about 4000 hours^{*1 *2} of consecutive use. Such interval differs depending on the operating environment and may be shorter than 4000 hours^{*1 *2}. Decrease in luminescence and/or color brightness indicates that the lamp needs to be replaced. When the lamp operation time exceeds 3000 hours^{*1}, the indicator will blink alternately between green and red (while the lamp is lit; when the lamp is not lit, the indicator will be lit red only) and the lamp replacement message will appear on the screen for one minute everytime the lamp is turned on. When the lamp has been used for about 3800 hours^{*1}, the replacement message (LAMP EXCHANGE) will appear on the screen for one minute every 20 hours^{*1} thereafter.

When the lamp operation time exceeds 4000 hours^{*1 *2}, the projector automatically shuts off and can not be used until the lamp is replaced and the lamp operation time is reset.

*1: When LAMP MODE in the SETUP menu is set to CINEMA. When it is set to BRIGHT, this duration will be decreased.

*2: When LAMP MODE is set to BRIGHT, this duration will be decreased to 2000 hours.

Caution

- Do not remove the lamp for any purpose other than replacement. Unnecessary removal of the lamp may result in a breakdown.
- This projector uses a high-pressure mercury lamp as the light source. The high-pressure mercury lamp may explode or fail to illuminate permanently because of an impact, scratch, or deterioration through use. The period of time until explosion or permanent failure to illuminate varies considerably from lamp to lamp, depending on operation conditions. Therefore, the lamp may explode soon after the start of use.
- The possibility of explosion of the lamp increases if you use it beyond its replacement period. When the lamp replacement warning appears, replace it with a new one immediately, even if the lamp is still lighting normally.
- When the high-pressure mercury lamp explodes, glass fragments will scatter inside or outside the lamp box and the gas charged inside the lamp will diffuse inside or outside the projector. The gas inside the lamp contains mercury. Be careful not to breathe it and avoid it from entering your eye or mouth. If you should breathe it or if it should enter your eye or mouth, see a doctor immediately.
- In the event that the high-pressure mercury lamp has exploded, glass fragments may have been scattered inside the projector. Ask your dealer to replace the lamp and to inspect the inside of the projector. When you clean or replace the lamp by yourself, be sure to hold the handle of the lamp. You may get injured by glass fragments.
- Do not replace the lamp with the projector installed on the ceiling. Glass fragments may fall from the projector, entering your eye or mouth and causing injury.
- When placing the projector upside down to replace the lamp or conduct maintenance, be sure that the projector is securely placed before working with it.

Replacement part (Option / Not included)

Spare lamp P JL-625

◆ Replacing the lamp

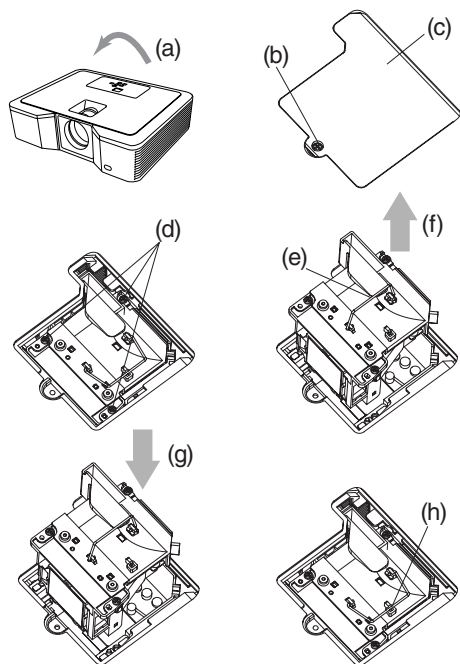

1. Carefully turn the projector upside-down (a).
2. Loosen the screw (b) using a Phillips screwdriver (+), and remove the lamp cover (c).
3. Loosen the lamp screws (d) using a Phillips screwdriver (+).
4. Pull up the handle (e).
5. Pull out the lamp box by the handle while holding the projector (f).
 - Pull the lamp box out of the projector slowly. If it is pulled out quickly, the lamp may break scattering glass fragments.
 - Do not spill liquid on the removed lamp box or place it near any flammable object or where children can reach to prevent fire and injury.
6. Load a new lamp box securely into the projector in the right orientation (g).
7. Put the handle back to the original position (h).
 - Make sure that the handle is locked.
8. Tighten the screws (d) using a Phillips screwdriver (+).
9. Tighten the screw (b) using a Phillips screwdriver (+) to secure the lamp cover.

Reset of the lamp operation time

Plug in the power cable and reset the lamp operation time by pressing and holding the ◀, ▶, and STANDBY/ON buttons on the control panel at the same time.

Important

- Unless these three buttons are pressed at the same time, the lamp operation time isn't reset.
- Make sure that the STATUS indicator is lit twice and the lamp operation time is reset successfully.
- The projector doesn't turn on if the lamp cover isn't attached securely.
- Be sure to reset the lamp operation time whenever you replace the lamp.
- Do not reset the lamp operation time unless you replace the lamp.
- This projector uses a lamp that contains mercury. Disposal of the lamp or the projector with the lamp may be regulated due to environmental considerations.

◆ Maintenance

Caution

- Be sure to turn off the lamp and unplug the power cable from the wall outlet before you perform any maintenance on the projector.

Cleaning of the projector and the ventilation slots

Use a soft cloth to clean the projector and the ventilation grilles. When the grilles become dirty, wipe them with a soft cloth dampened with diluted mild detergent, and then wipe them with a dry cloth.

To protect the surface of the projector from fading or deteriorating:

- Do not spray insecticide on or inside the projector.
- Do not use benzine or thinner to clean it.
- Do not let rubber or plastic materials contact with projector.

Cleaning of the lens

Use a standard lens-cleaning brush or a piece of lens tissue dampened with lens cleaning fluid. The lens surface is fragile. Use only recommended, nonabrasive lens-cleaning materials. Do not touch the lens with your fingers.

13 Attaching a lens filter and cap

◆ Attaching a commercially available lens filter

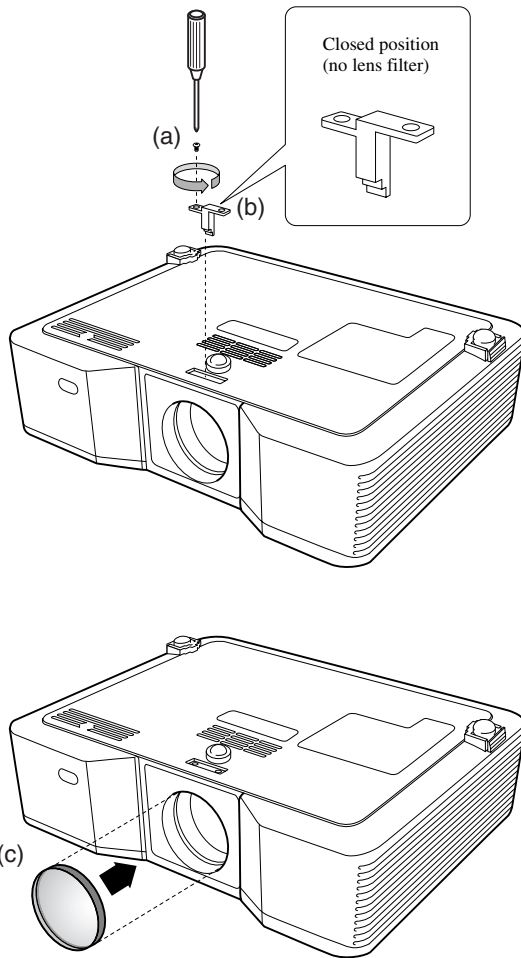

1. Carefully turn the projector upside-down.
2. Loosen the screw (a) using a Phillips screwdriver (+), and remove the stopper (b).
3. Place a lens filter (c).
4. Rotate the stopper 180° and reinsert it into its original location (d).
5. Tighten up the screw (e) using a Phillips screwdriver (+).

Important

- Be sure to use a 67 mm lens filter for this projector.
- Not all 67 mm lens filters are compatible with this projector.

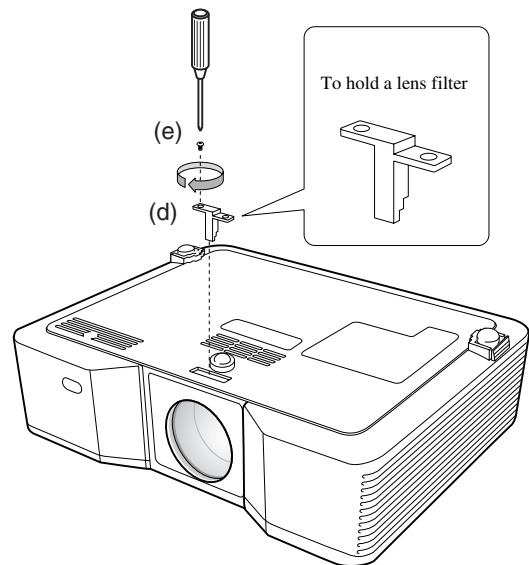

◆ Attaching the lens cap

Attach the supplied lens cap when not using the projector to prevent the lens from becoming dirty or damaged. Insert the lens cap until it is securely placed. (It should make a clicking sound.)

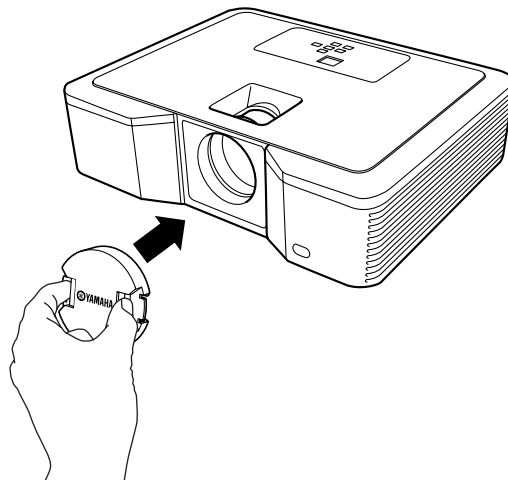

Important































- Do not force the lens cap onto the projector.
- Make sure that the YAMAHA name on the lens cap is aligned parallel to the top and bottom edges of the projector.
- The lens cap can be placed over the lens filter if a lens filter has been installed.

14 Troubleshooting

◆ Troubleshooting

Refer to the chart below when this projector does not function properly. If the problem you are experiencing is not listed below or if the instructions do not help, stop using the projector and contact your dealer.

No image appears on the screen.

Problem	Solution																				
Power can not be turned on.	<ul style="list-style-type: none"> Check whether the indicators are on or off and how they are lightning. <table border="1"> <thead> <tr> <th>POWER</th> <th>STATUS</th> <th>Solution</th> </tr> </thead> <tbody> <tr> <td> Off</td> <td> Off</td> <td> <ul style="list-style-type: none"> Connect the power cable to the projector. Plug the power cable into a wall outlet. </td> </tr> <tr> <td rowspan="4"> Steady red</td> <td> Off</td> <td> <ul style="list-style-type: none"> If any objects are blocking the air intake or exhaust vent, remove them and carry out the following. <ol style="list-style-type: none"> Unplug the power cable from the wall outlet. Make sure that the projector has cooled off. Plug the power cable into the wall outlet. Press the STANDBY/ON button. </td> </tr> <tr> <td> Blinking orange</td> <td> <ul style="list-style-type: none"> If any objects are blocking the air intake or exhaust vent, remove them. Don't expose the air exhaust vents to hot air emitted from a heating appliance. Clean the ventilation grilles. Relocate the projector to a cooler place. </td> </tr> <tr> <td> Blinking green</td> <td> <ul style="list-style-type: none"> After the STATUS indicator stops blinking, press the STANDBY/ON button. If you unplug the power cable while the fan is rotating, the lamp may not turn on about one minute when you plug the power cable next time. The lamp can't turn on again for one minute after it goes out. Press the STANDBY/ON button several times. </td> </tr> <tr> <td> Steady red</td> <td> <ul style="list-style-type: none"> Replace the lamp. (The lamp is at the end of its life.) </td> </tr> <tr> <td rowspan="2"> Blinking red / green</td> <td> Off</td> <td> <ul style="list-style-type: none"> Attach the lamp cover on the bottom. </td> </tr> <tr> <td> Steady or Blinking</td> <td> <ul style="list-style-type: none"> Unplug the power cable from the wall outlet and contact your dealer. </td> </tr> </tbody> </table>	POWER	STATUS	Solution	 Off	 Off	<ul style="list-style-type: none"> Connect the power cable to the projector. Plug the power cable into a wall outlet. 	 Steady red	 Off	<ul style="list-style-type: none"> If any objects are blocking the air intake or exhaust vent, remove them and carry out the following. <ol style="list-style-type: none"> Unplug the power cable from the wall outlet. Make sure that the projector has cooled off. Plug the power cable into the wall outlet. Press the STANDBY/ON button. 	 Blinking orange	<ul style="list-style-type: none"> If any objects are blocking the air intake or exhaust vent, remove them. Don't expose the air exhaust vents to hot air emitted from a heating appliance. Clean the ventilation grilles. Relocate the projector to a cooler place. 	 Blinking green	<ul style="list-style-type: none"> After the STATUS indicator stops blinking, press the STANDBY/ON button. If you unplug the power cable while the fan is rotating, the lamp may not turn on about one minute when you plug the power cable next time. The lamp can't turn on again for one minute after it goes out. Press the STANDBY/ON button several times. 	 Steady red	<ul style="list-style-type: none"> Replace the lamp. (The lamp is at the end of its life.) 	 Blinking red / green	 Off	<ul style="list-style-type: none"> Attach the lamp cover on the bottom. 	 Steady or Blinking	<ul style="list-style-type: none"> Unplug the power cable from the wall outlet and contact your dealer.
POWER	STATUS	Solution																			
 Off	 Off	<ul style="list-style-type: none"> Connect the power cable to the projector. Plug the power cable into a wall outlet. 																			
 Steady red	 Off	<ul style="list-style-type: none"> If any objects are blocking the air intake or exhaust vent, remove them and carry out the following. <ol style="list-style-type: none"> Unplug the power cable from the wall outlet. Make sure that the projector has cooled off. Plug the power cable into the wall outlet. Press the STANDBY/ON button. 																			
	 Blinking orange	<ul style="list-style-type: none"> If any objects are blocking the air intake or exhaust vent, remove them. Don't expose the air exhaust vents to hot air emitted from a heating appliance. Clean the ventilation grilles. Relocate the projector to a cooler place. 																			
	 Blinking green	<ul style="list-style-type: none"> After the STATUS indicator stops blinking, press the STANDBY/ON button. If you unplug the power cable while the fan is rotating, the lamp may not turn on about one minute when you plug the power cable next time. The lamp can't turn on again for one minute after it goes out. Press the STANDBY/ON button several times. 																			
	 Steady red	<ul style="list-style-type: none"> Replace the lamp. (The lamp is at the end of its life.) 																			
 Blinking red / green	 Off	<ul style="list-style-type: none"> Attach the lamp cover on the bottom. 																			
	 Steady or Blinking	<ul style="list-style-type: none"> Unplug the power cable from the wall outlet and contact your dealer. 																			
No image appears on the screen.	<ul style="list-style-type: none"> Check that the lens cap is removed. It may take about one minute for the lamp to light up. The lamp fails to light up on rare occasions. In such a case, wait for a few minutes and then try again. If the projector was turned off before the lamp cooled down completely, the fans may start rotating and the STANDBY/ON button may not function when you plug the power cable into the wall outlet next time. Wait for the fans to stop and press the STANDBY/ON button to turn on the lamp again. Check that the intake vent is clean. Check that the lamp cover is closed (see page 29). Check that the cables connected to the external devices are not broken. If an extension cable is being used, replace it with the supplied cable for troubleshooting purposes. If images are now displayed correctly, add an RGB signal amplifier to the extension cable. 																				
Projected images suddenly disappear.	<ul style="list-style-type: none"> The air intake or exhaust vent may be blocked. (In such cases, the STATUS indicator blinks orange.) → Remove the objects blocking the intake vent and/or exhaust vents and then carry out the following procedure. Wait for the air intake or exhaust fan to stop (or wait for the STATUS indicator to go out.) Unplug the power cable from the wall outlet. Wait about 10 minutes. Plug the power cable into the wall outlet. Press the STANDBY/ON button. When the STATUS indicator is steady red, it is indicating that the lamp should be replaced. Replace the lamp with a new, commercially available lamp. 																				

Problem	Solution
"NO SIGNAL" is displayed.	<ul style="list-style-type: none"> • Turn on the power of the connected device, or check whether there is something wrong with the connected device. • Check whether the external device outputs signals. (Check this especially when the external device is a notebook computer.) • Check that the cable connected to the external device isn't defective. • Check that the projector is connected to the external device using the correct terminals. • Check that the connected device is correctly selected as the input source. • If an extension cord is being used, replace it with the supplied cable and check whether images are projected correctly. If images are now projected correctly, add an RGB signal amplifier to the extension cord.

Images are not displayed correctly.

Problem	Solution
Projected images are shaking. Projected images are displaced.	<ul style="list-style-type: none"> • Check that the signal being output by the external device isn't intermittent. • Connect the cable's plug with the external device's connector firmly. • Press the AUTO button. • Some computers output out-of-spec signals on rare occasion. Adjust the SIGNAL menu (see page 26).
Projected images are distorted.	<ul style="list-style-type: none"> • Adjust the projector and the screen so that they are perpendicular to each other (see page 8).
Projected images are dark.	<ul style="list-style-type: none"> • Adjust BRIGHTNESS and CONTRAST in the IMAGE menu (see page 24). • Replace the lamp (see page 28).
Projected images are blurred.	<ul style="list-style-type: none"> • Adjust the focus (see page 14 and 17). • Clean the lens. • Press the ◀ or ▶ button on the remote control to eliminate flicker. • Adjust TRACKING and PHASE in the SIGNAL menu (see page 26). • Adjust BRIGHTNESS and CONTRAST in the IMAGE menu (see page 24). • Adjust the projector and the screen so that they are perpendicular to each other (see page 8).
White dots are seen on projected images. Black dots are seen on projected images.	<ul style="list-style-type: none"> • This symptom is normal for a DLP projector and is not a malfunction. (A very small number of pixels may stay lit or out, but it is not a malfunction. Pixels of 99.99% or more are effective.)
Rainbow effect is seen on projected images.	<ul style="list-style-type: none"> • This is due to color breaking noise that occurs in a DLP system and is not a malfunction.
Fine streaks are seen on projected images.	<ul style="list-style-type: none"> • This is due to interference with the screen surface and is not a malfunction. Replace the screen or displace the focus a little.
Projected images become wavy.	<ul style="list-style-type: none"> • Connect the plugs of the cables to external devices securely. • Keep the projector away from devices that emit interfering radio waves. • When the keystone adjustment is carried out, the image may not be displayed correctly because of the type of input signal. This isn't a product malfunction. In this case, readjust the keystone so that the amount of keystone correction is as small as possible.
Hue is not appropriate.	<ul style="list-style-type: none"> • Check that the cables connected to the external devices are not broken.
Tint in projected images is incorrect.	<ul style="list-style-type: none"> • Check that D-SUB INPUT in the SIGNAL menu is correctly set (see page 23). • Check that the cable connected to the external device isn't broken.
Only the motion areas in the images supplied from the computer aren't displayed.	<ul style="list-style-type: none"> • This is caused by the computer being used. Contact the manufacturer of your computer.
Projected images are obscured.	<ul style="list-style-type: none"> • Match the output resolution of your computer with the resolution of the projector. For the method to change the output resolution of the computer, contact the manufacturer of your computer (see page 36). • Some images and texts appear obscured during the keystone adjustment. In such cases, use the projector without applying the keystone adjustment (see page 15).

Others

Problem	Solution
The exhaust vents emit warm air.	<ul style="list-style-type: none"> This air comes out after cooling the inside of the projector. It may feel hot, but this is not a malfunction.
The menu can't be used.	<ul style="list-style-type: none"> The microcomputers inside the projector may be wrongly operating because of noise. <ul style="list-style-type: none"> → Press the STANDBY/ON button to turn off the lamp and unplug the power cable from the wall outlet. Wait about 10 minutes, plug the power cable in, and try again.
“TEMPERATURE!!!” is displayed.	<ul style="list-style-type: none"> This indication appears when the ambient temperature rises high. When the ambient temperature stays high, the lamp goes out. <ul style="list-style-type: none"> → Eliminate any causes of the rise in the ambient temperature. This indication appears when the air intake or exhaust vent is blocked. When they are kept blocked, the lamp goes out. <ul style="list-style-type: none"> → Remove the objects blocking the air intake or exhaust vent.
The ☹ mark appears.	<ul style="list-style-type: none"> This mark appears when ineffective operation is carried out. This isn't a product malfunction.
The remote control doesn't function easily or at all.	<ul style="list-style-type: none"> Check that the battery is loaded in the remote control or the battery isn't weak (see page 4). Check that the remote control sensor isn't exposed to direct sunlight or fluorescent light. Use the remote control within its operation range (see page 7). Use the remote control at least 10 cm away from the projector.
Abnormal sound is heard.	<ul style="list-style-type: none"> Because the color wheel spins at a high speed, metallic sounds may be heard in rare occasions. This is not a malfunction.

If the following problem occurs after the lamp is replaced, check the following first.

Problem	Solution
The projector does not turn on.	<ul style="list-style-type: none"> Fit the lamp cover securely (see page 29). Reset the lamp operating time (see page 29).
The STATUS indicator blinks.	<ul style="list-style-type: none"> Reset the lamp operating time (see page 29).

15 Indicators

This projector has two indicators, each of which shows the operation condition of the projector. Refer to Troubleshooting for additional indication signals.

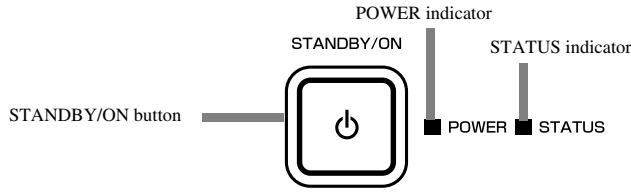

◆ Normal conditions

POWER	STATUS	CONDITION	NOTE
Steady red	Off	Stand-by.	
Steady green	Blinking green	Warming up period (about 1 minute).	The STANDBY/ON button cannot be used until the STATUS indicator is steady green.
Steady green	Steady green	The projector is ready.	
Steady red	Blinking green	Cooling down period (lasts under 2 minutes; normal when shutting down).	Do not unplug the projector until the STATUS indicator is off.

◆ Abnormal conditions

POWER	STATUS	CONDITION	SOLUTION
Steady green or Steady red	Blinking orange	Abnormal temperature <ul style="list-style-type: none"> The ventilation grilles are clogged with dust or dirt. The room temperature is high. 	<ul style="list-style-type: none"> Clean the ventilation grilles. Relocate the projector to a cooler place. Remove any objects blocking the ventilation grilles.
Steady red	Blinking green	Abnormal when it occurs except while shutting down. The protection circuit is working or the lamp is in an abnormal condition.	<ul style="list-style-type: none"> Wait until the STATUS indicator goes out, then press the STANDBY/ON button. If the above solution is not effective, replace the lamp.
Steady green	Blinking green/red	Lamp operation time warning. (Total lamp operation time reached 3000 hours ^{*1} while the power was on.)	Replace the lamp. Change with a new lamp if this problem recurs.
Steady red	Blinking red	Lamp operation time warning. (Total lamp operation time reached 3000 hours ^{*1} while the power was off.)	
Steady red	Steady red	Lamp operation time warning. (Total lamp operation time reached 4000 hours ^{*1, *2} while the power was off.)	
Blinking green/red	Off	The lamp cover isn't closed.	Close the cover correctly.
Blinking green/red	Steady or Blinking	Abnormal.	Contact your dealer.

*1: When LAMP MODE of the SETUP menu is set to CINEMA. When it is set to BRIGHT, this duration will be decreased.

*2: When LAMP MODE is set to BRIGHT, this duration will be decreased to 2000 hours.

◆ Projector specifications

The specifications and outside appearance of the projector are subject to change without prior notice.

Type	DLP™ projector		
Model	DPX-530		
Display Technology	0.65-inch Single chip DMD (Aspect ratio 16:9) Pixel 1024 × 576 = 589824 pixels		
Projection lens	F 2.4 – 2.6 f= 23 – 27.6 mm		
Light-source lamp	250 W		
Image size (Projection distance)	40" min. to 275" max. (Projection distance 1.3 to 10 m)		
Maximum number of display colors	16770000 (full-color display)		
Maximum resolution	Computer signal	Maximum resolution: 1280 x 1024 dots (Analog) / compressed Panel resolution: 1024 × 576 dots	
	Video signal	NTSC / PAL / SECAM / 4.43NTSC / PAL-M / PAL-N / PAL-60	
	Component signal	480i, 480p, 576i, 576p, 720p, 1080i Panel resolution: 1024 × 576 dots	
Input terminal	[Signal type]	[Terminal type]	[Line]
	Analog RGB	D-SUB 15P	1
	Digital RGB	DVI-D	1
	Video input	RCA × 1	1
	S-Video input	S	1
	Component video input	RCA × 3, D-SUB 15P	2
Control terminal/Others	RS-232C (8P): For service person		
Operating temperatures	+41°F (+5°C) to +95°F (+35°C)		
Rated voltage	AC100 - 240V, 50/60Hz		
Power consumption	3.5 A		
Dimensions	360 mm (W) × 102 mm (H) × 290 mm (D) *Not including protrusions.		
Weight	3.9 kg		
Others	S-video input	Luminance signal: V _{p-p} =1.0 V 75Ω (negative sync) Chrominance signals: V _{p-p} =0.286 V 75Ω (burst signal)	
	Video input	V _{p-p} =1.0 V 75Ω (negative sync)	
	Component video input	Y _{C_BC_R} : V _{p-p} =1.0 V 75Ω (Y) (negative sync) V _{p-p} =0.7 V 75Ω (C _B , C _R)	
	Analog RGB input	RGB: V _{p-p} =0.7 V 75Ω (negative sync) HD: TTL-level (negative or positive polarity) VD: TTL-level (negative or positive polarity)	
	Digital RGB input	DVI interface (TMDS single link)	

◆ Composite / S-video signal specifications

Signal mode	Resolution (H × V)	Horizontal frequency (kHz)	Vertical frequency (Hz)	Normal mode (H × V)*1	Through mode (H × V)
TV60	–	15.73	59.94	1024 × 576	–
TV50	–	15.63	50.00	1024 × 576	–

◆ Component signal specifications

Signal mode	Resolution (H × V)	Horizontal frequency (kHz)	Vertical frequency (Hz)	Normal mode (H × V)*1	Through mode (H × V)
480i (525i)	–	15.73	59.94	1024 × 576	–
576i (625i)	–	15.63	50.00	1024 × 576	–
480p (525p)	–	31.47	59.94	1024 × 576	–
576p (625p)	–	31.25	50.00	1024 × 576	–
720p 60 (750p 60)	–	45.00	60.00	1024 × 576	–
720p 50 (750p 50)	–	37.50	50.00	1024 × 576	–
1080i 60 (1125i 60)	–	33.75	60.00	1024 × 576	–
1080i 50 (1125i 50)	–	28.13	50.00	1024 × 576	–

◆ Digital RGB signal specifications

Signal mode	Resolution (H × V)	Horizontal frequency (kHz)	Vertical frequency (Hz)	Normal mode (H × V)*1	Through mode (H × V)
480p (525p)	–	31.47	59.94	1024 × 576	–
576p (625p)	–	31.25	50.00	1024 × 576	–
720p 60 (750p 60)	–	45.00	60.00	1024 × 576	–
720p 50 (750p 50)	–	37.50	50.00	1024 × 576	–
1080i 60 (1125i 60)	–	33.75	60.00	1024 × 576	–
1080i 50 (1125i 50)	–	28.13	50.00	1024 × 576	–
SVGA60	800 × 600	37.88	60.32	768 × 576	–
XGA60	1024 × 768	48.36	60.00	768 × 576	–
SXGA60	1280 × 1024	60.02	63.98	720 × 576	–

◆ Analog RGB signal specifications

Signal mode	Resolution (H × V)	Horizontal frequency (kHz)	Vertical frequency (Hz)	Normal mode (H × V)*1	Through mode (H × V)
480p (525p)	–	31.47	59.94	1024 × 576	–
576p (625p)	–	31.25	50.00	1024 × 576	–
720p 60 (750p 60)	–	45.00	60.00	1024 × 576	–
720p 50 (750p 50)	–	37.50	50.00	1024 × 576	–
1080i 60 (1125i 60)	–	33.75	60.00	1024 × 576	–
1080i 50 (1125i 50)	–	28.13	50.00	1024 × 576	–
PC98	640 × 400	24.82	56.42	924 × 576	640 × 400
CGA70	640 × 400	31.47	70.09	924 × 576	640 × 400
CGA84	640 × 400	37.86	84.13	924 × 576	640 × 400
CGA85	640 × 400	37.86	85.08	924 × 576	640 × 400
VGA60	640 × 480	31.47	59.94	768 × 576	640 × 480
VGA72	640 × 480	37.86	72.81	768 × 576	640 × 480
VGA75	640 × 480	37.50	75.00	768 × 576	640 × 480
VGA85	640 × 480	43.27	85.01	768 × 576	640 × 480
SVGA56	800 × 600	35.16	56.25	768 × 576	–
SVGA60	800 × 600	37.88	60.32	768 × 576	–
SVGA72	800 × 600	48.08	72.19	768 × 576	–
SVGA75	800 × 600	46.88	75.00	768 × 576	–
SVGA85	800 × 600	53.67	85.06	768 × 576	–
XGA43i	1024 × 768	35.52	86.96	768 × 576	–
XGA60	1024 × 768	48.36	60.00	768 × 576	–
XGA70	1024 × 768	56.48	70.07	768 × 576	–
XGA75	1024 × 768	60.02	75.03	768 × 576	–
XGA85	1024 × 768	68.68	85.00	768 × 576	–
MAC13	640 × 480	35.00	66.67	768 × 576	640 × 480
MAC16	832 × 624	49.72	74.55	768 × 576	–
MAC19	1024 × 768	60.24	75.02	768 × 576	–
HP75	1024 × 768	62.94	74.92	768 × 576	–
SXGA60	1280 × 1024	60.02	63.98	720 × 576	–

*1: When ASPECT in the INITIAL menu is set to DEFAULT.

*2: Unavailable with RGB-HV (5 line) sources.

Important

- Some computers aren't compatible with the projector.
- The projector's maximum resolution is 1024 × 576 pixels. It may not display images of higher resolutions than 1024 × 576 correctly.
- If the resolution and frequency of your computer aren't shown on the table, find the compatible resolution and frequency by changing the resolution of your computer.
- Set D-SUB INPUT in the SIGNAL menu to RGB when inputting the HDTV signal as RGB signal.
- In the case of XGA, the right side of the image may not appear. In this case, adjust TRACKING in the SIGNAL menu.
- TV60 and TV50 are equivalent to 480i and 576i respectively. When these signals are input to the VIDEO or S-VIDEO signal, the signal mode is indicated as TV60 or TV50. When they are input to the COMPONENT terminal, the signal mode is indicated as 480i or 576i.
- This projector cannot be connected to other equipment via an RGB-CS (4 line) connection.

Connectors

SERIAL (8-pin)

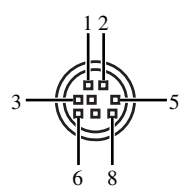

Pin No.	Name	I/O
1	TXD	IN
2	-	-
3	-	-
4	GND	-
5	-	-
6	-	-
7	RXD	OUT
8	-	-

D-SUB (Mini D-SUB 15-pin)

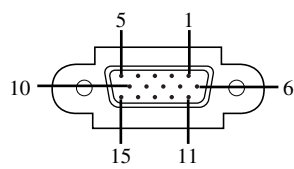

Pin No.	Spec.
1	R(REDF) / CR
2	G(GREEN) / Y
3	B(BLUE) / CB
4	GND
5	GND
6	GND
7	GND
8	GND
9	-
10	GND
11	GND
12	DDC Data
13	HD/CS
14	VD
15	DDC Clock

DVI (DVI-D 24-pin with HDCP)

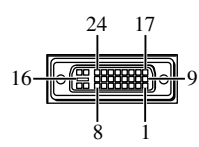

Pin No.	Spec.	Pin No.	Spec.
1	DATA 2-	13	-
2	DATA 2+	14	+5V Power
3	DATA 2 Shield	15	Ground
4	-	16	Hot Plug Detect
5	-	17	DATA 0-
6	DDC Clock	18	DATA 0+
7	DDC Data	19	DATA 0 Shield
8	-	20	-
9	DATA 1-	21	-
10	DATA 1+	22	Clock Shield
11	DATA 1 Shield	23	Clock+
12	-	24	Clock-



© 2005 YAMAHA CORPORATION All rights reserved.

YAMAHA ELECTRONICS CORPORATION, USA 6660 ORANGETHORPE AVE., BUENA PARK, CALIF. 90620, U.S.A.
YAMAHA CANADA MUSIC LTD. 135 MILNER AVE., SCARBOROUGH, ONTARIO M1S 3R1, CANADA
YAMAHA ELECTRONIK EUROPA G.m.b.H. SIEMENSSTR. 22-34, 25462 RELINGEN BEI HAMBURG, GERMANY
YAMAHA ELECTRONIQUE FRANCE S.A. RUE AMBROISE CROIZAT BP70 CROISSY-BEAUBOURG 77312 MARNE-LA-VALLEE CEDEX02, FRANCE
YAMAHA ELECTRONICS (UK) LTD. YAMAHA HOUSE, 200 RICKMANSWORTH ROAD WATFORD, HERTS WD18 7GQ, ENGLAND
YAMAHA SCANDINAVIA A.B. J A WETTERGRENS GATA 1, BOX 30053, 400 43 VÄSTRA FRÖLUNDA, SWEDEN
YAMAHA MUSIC AUSTRALIA PTY, LTD. 17-33 MARKET ST., SOUTH MELBOURNE, 3205 VIC., AUSTRALIA

YAMAHA CORPORATION
Printed in Japan ◀ 871D460B10