

XG-C465X / XG-C435X

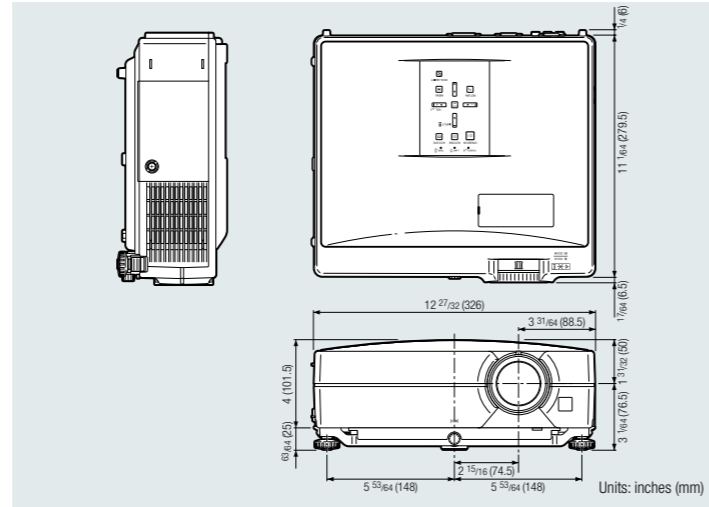

The product pictured is the XG-C465X, which is identical in appearance to the XG-C435X with the exception of the model number indication.

Dimensions (XG-C465X / XG-C435X)



Optional Accessories

Lenses

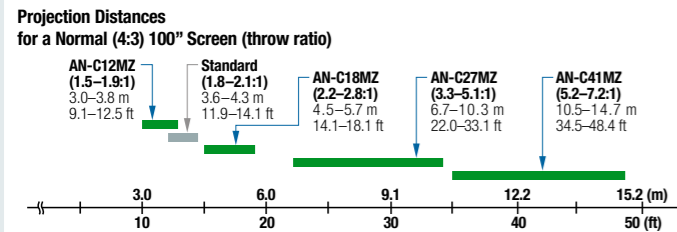
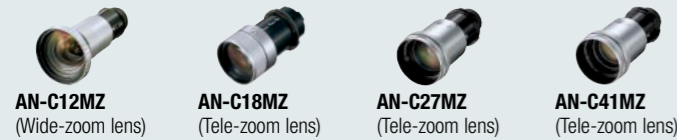

Lamp



USB Remote Receiver



Cable



Ceiling Mounts



Specifications

| Models | XG-C465X | XG-C435X |
|---------------------------------------|--|---|
| Display device | | 0.8" LCD panel x 3 |
| Resolution | | XGA (1,024 x 768) |
| Brightness | 4,500 ANSI lumens | 4,000 ANSI lumens |
| Contrast ratio | 450:1 | 550:1 |
| Lens | F number Zoom Focus | F1.7-1.9 Manual, x1.2 (f=28.0 - 33.6 mm) Manual |
| Picture size | | 40" (102 cm) to 500" (1,270 cm) |
| Projection distance | | 40": 1.4-1.7 m, 100": 3.6-4.3 m, 500": 17.9-21.4 m |
| Input signals | DTV Computer RGB | 1080P / 720P / 576P / 576i / 540P / 480P / 480i NTSC / PAL / SECAM |
| Input terminals | DVI-D (Compatible with HDCP) Computer / Component (mini D-sub 15 pin) S-Video (mini DIN 4 pin) Video (RCA) Audio (ø3.5 mm stereo minijack) Audio (RCA) | x1 x2 x1 x1 x2 x2 (L/R) |
| Output terminals | Computer / Component (mini D-sub 15 pin) Audio (ø3.5 mm stereo minijack) | x1 x1 (variable audio output) |
| Control and communication terminals | LAN (RJ-45) USB (Type B) RS-232C (mini DIN 9 pin) Wired remote (ø3.5 mm stereo minijack) | x1 x1 x1 x1 |
| Horizontal frequency | | 15 - 70 kHz |
| Vertical frequency | | 43 - 85 Hz |
| Speakers | | 2 W (mono) |
| Fan noise | 37 dB (Bright), 31 dB (Eco+Quiet) | 36 dB (Bright), 31 dB (Eco+Quiet) |
| Projection lamp | | 275 W |
| Lamp life | | 3,000 hours (Eco+Quiet) |
| On-screen display languages | | English, German, Spanish, Dutch, French, Italian, Swedish, Portuguese, Simplified Chinese, Korean, Japanese, Russian, Arabic, Polish, Turkish |
| Rated voltage | | AC 100-240 V |
| Rated frequency | | 50/60 Hz |
| Input current | | 3.6 A |
| Power consumption (standby) | | 360 W (6 W) with AC 100 V, 345 W (8 W) with AC 240 V |
| Operation temperature | | 41°F to 95°F (+5°C to +35°C) |
| Cabinet | | Plastic |
| Dimensions (main body only) W x H x D | | 12 27/32" x 4" x 11 1/64" (326 x 101.5 x 279.5 mm) |
| Weight (approx.) | | 10.8 lbs. (4.9 kg) |
| Supplied accessories | Remote control, two R-6 batteries, power cord (6' (1.8 m)), RGB cable (10' (3.0 m)), DIN-D-sub RS-232C adaptor (5 5/16" (15 cm)), lens cap, lens cap strap, storage case, operation manual, CD-ROM | |

Design and specifications are current as of November 2007, but are subject to change without notice.
 *1 Compatible in intelligent compression *2 Analogue RGB signal only
 • Temporary noise may be visible with vertical frequencies above 100 Hz if OSD functions are activated.
 • The lamp life may vary depending on the usage condition.

SHARP

XG-C465X/XG-C435X

True XGA Portable LCD Projectors

High-Brightness, High-Quality Projectors
 with Intuitive Operation and Unique Network System
 to Match Conference Room Applications As Well As
 Provide Mobile Business Possibilities



SHARP

SHARP CORPORATION OSAKA, JAPAN
 URL <http://www.sharp-world.com/>

High Brightness of 4,500 ANSI Lumens in a Compact Portable Projector Providing User-Oriented Operation and Easy Installation

High-Brightness Performance in Such a Compact Body

High Brightness of 4,500 ANSI Lumens (XG-C465X) (4,000 ANSI Lumens (XG-C435X))

Sharp's optoelectronics technology in a three-LCD projection system maximizes light output. This technology provides efficient brightness of 4,500 ANSI lumens (XG-C465X) delivering a bright, easy-to-see image even in large, brightly lit rooms.

Compact and Lightweight Body

Sharp's optical mechanism achieves a body that is compact and lightweight in the class of projectors with this luminance. Together with the recessed lens, which provides extensive protection against accidental damage, the XG-C465X/XG-C435X projectors expand possibilities for portable use.

Compact and Lightweight



Useful Features

Direct Power Off Function

The Direct Power Off function lets users immediately unplug the projector and take it from the location because there is no need to wait for the projector to cool down. Along with Direct Power Off, the Auto Restart function also helps control the power simultaneously for multiple projectors by using the room's primary power switch.

Eco+Quiet Mode Direct Button

Eco+Quiet Mode extends the LCD and lamp life and reduces fan noise. With the Direct Buttons built into both the projector and the remote control, this mode can be conveniently turned on or off at any time.

31dB Low Fan Noise (Eco+Quiet Mode On)

Use of separate cooling systems for each RGB LCD panel achieves low fan noise.

Easy Setting

● Auto Keystone Correction

Automatically adjusts projected images to compensate for distortion.

● New Tilt Leveler

Easily levels tilted images.



Flexible Presentation

● Mouse Control

The computer mouse function enables a projector to be controlled remotely using a built-in USB terminal. In addition, by using an optional AN-MR2 remote IR receiver, a projector can be controlled even when mounted on a desktop or ceiling and regardless of USB cable length.

Easy Operation and Installation

Four Optional Lenses and Easy Replacement System

The projector may be used with four optional interchangeable lenses to meet a wide variety of applications and projection situations. The lenses cover projection distances from 9.11 ft (3.0 m) to 48.4 ft (14.7 m) for a 100" screen.

And, it is amazingly easy to change lenses. Just detach the cover and turn the lever. Anytime you enter a new presentation venue, you can simply relax and quickly change to the lens which best suits your projection conditions such as the room size, projection distance and projected picture size.



Side Access Lamp and Filter

The lamp and filter in the XG-C465X/XG-C435X can be easily replaced while the projector is on a tabletop or when even ceiling mounted.



High Quality Projection

High-Quality Picture Reproduction

The XG-C465X and XG-C435X are truly compatible with XGA (1,024 x 768) and faithfully reproduce the same colour tones, hues and gradations as the original picture on a PC screen. They also reproduce a flicker-less high-quality picture from DVDs*, high-definition broadcasts and education videos in large-screen projection.

* A separate DVD player is needed for viewing DVDs.

SHARP Unique Network System

Web Browser Control

Web browser control enables remote access and management of the projector by utilizing built-in firmware without the need for additional special software.

Remote Access for Control and Adjustment

Projector control functions, including power on, input select, volume, and AV mute, can be controlled and adjusted by a computer even in another room.

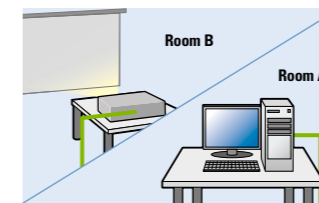

Diagnosis and Auto Email Alert

Email is automatically sent to appointed addresses when detecting an error message, such as the lamp going out, unusual heating or cooling fan breakdown.

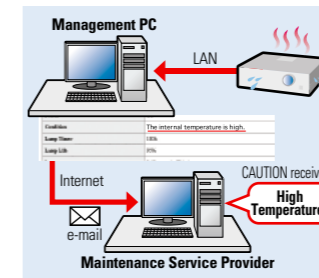

Link to a Specific Website for Service and Support

The projector can be registered to a specific website for maintenance service and support. For example, the projector can send an error message, such as to notify that the lamp is burnt out, to a web address automatically selected. The address accessed for maintenance is also shown on the display.

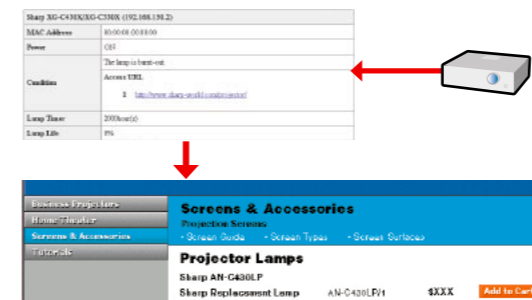

A Wide Variety of Interfaces

Variety of Interfaces

With a DVI digital terminal compatible with conventional players and computers, the XG-C465X and XG-C435X are equipped with various video inputs, including composite inputs and four discrete stereo audio inputs.



Control with Downloadable Display Manager

A greater variety of network projector control options can be used when the Sharp Display Manager* is installed on the main computer.

* Sharp Display Manager can be downloaded from the Sharp Global Home Page for free. Sharp Global Homepage URL: <http://sharp-world.com/projector>

Remote Access for Multiple and Group Projector Control

A management computer can control multiple projectors simultaneously.

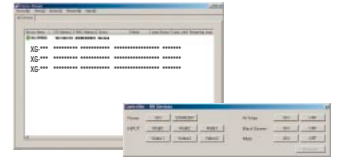

Periodic/Error Diagnosis and Auto Email Alert

The Display Manager sends periodic reports and an error message as well as directly adjusts the projector gamma values and other projector conditions.

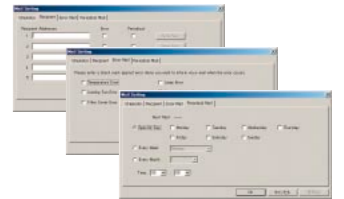

Theft Detection and Message (Network Surveillance System)

A warning message will appear on the screen of a computer when projector cables are disconnected.



PJLink™ Capability

The XG-C465X and XG-C435X are compatible with devices that support PJLink™, enabling systems to be easily built for centralized management and operation using a controller. For additional information about the PJLink™, visit <http://pjlink.jbmia.or.jp/english/>

Control System Compatibility

The XG-C465X and XG-C435X provide superior compatibility with various control systems such as Crestron, AMX and Extron.



Security and Safety (Notevision Security Pack)

Notevision Lockdown Function

The optical unit provides a solid mounting point for ceiling mount hardware, and the joint area is reinforced by a metal plate. A strong mount deters theft.

When a projector is subjected to a force of 7,000 N (714 kgf)



● System Lock Function with Key Code Startup

● Network Surveillance System

● Kensington Lock