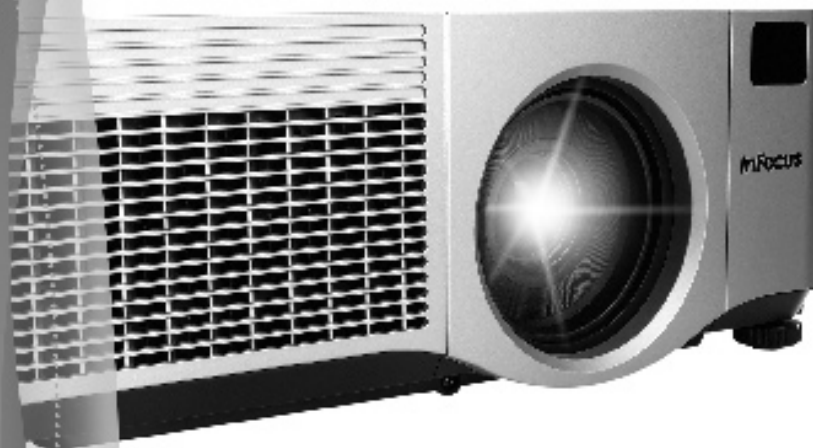


IN5102/IN5104/IN5106

Regulatory models W50, W55

 **InFocus**

## User's Guide



## Declaration of Conformity

Manufacturer: InFocus Corporation, 27500 SW Parkway Ave. Wilsonville, Oregon 97070 USA

European Office: Louis Armstrongweg 110, 1311 RL Almere, The Netherlands  
We declare under our sole responsibility that this projector conform to the following directives and norms:

EMC Directive 2004/108/EC

EMC: EN 55022

EN 55024

EN 61000-3-2

EN 61000-3-3

Low Voltage Directive 2006/95/EC

Safety: IEC 60950-1: 1<sup>st</sup> Edition

## Trademarks

Apple, Macintosh, and PowerBook are trademarks or registered trademarks of Apple Computer, Inc. IBM is a trademark or registered trademark of International Business Machines, Inc. Microsoft, PowerPoint, and Windows are trademarks or registered trademarks of Microsoft Corporation. Adobe and Acrobat are trademarks or registered trademarks of Adobe Systems Incorporated. HDMI, the HDMI logo and High-Definition Multimedia Interface are trademarks or registered trademarks of HDMI Licensing LLC. InFocus, In Focus, and INFOCUS (stylized) are either registered trademarks or trademarks of InFocus Corporation in the United States and other countries.

## FCC Warning

This equipment has been tested and found to comply with the limits for a Class A digital device, pursuant to part 15 of the FCC Rules. These limits are designed to provide reasonable protection against harmful interference when the equipment is operated in a commercial environment. This equipment generates, uses, and can radiate radio frequency energy and, if not installed and used in accordance with the instruction manual, may cause harmful interference to radio communications. Operation of this equipment in a residential area is likely to cause harmful interference in which case the user will be required to correct the interference at his own expense. This device complies with part 15 of the FCC Rules.

Operation is subject to the following two conditions: (1) This device may not cause harmful interference, and (2) this device must accept any interferences received, including interference that may cause undesired operation.

Changes or modifications not expressly approved by InFocus Corporation may void authority to operate the equipment.

## EN 55022 Warning

This is a Class A product. In a domestic environment it may cause radio interference, in which case the user may be required to take adequate measures. The typical use is in a conference room, meeting room or auditorium.

## Canada

This Class A digital apparatus complies with Canadian ICES-003.  
Cet appareil numérique de la classe A est conforme à la norme NMB-003 du Canada.

## Agency Approvals

UL, CUL

Other specific Country Approvals may apply, see please product certification label.

InFocus reserves the right to alter product offerings and specifications at any time without notice.

This document applies to model W50: IN5106, C500, IN5102, C447.

Input ratings: 100-120/220-240Vac, 5.0/2.1A, 50/60Hz

## Battery Safety Information

CAUTION: Risk of explosion if the battery in this projector is replaced with the incorrect type of battery. See page 35 for battery replacement instructions.

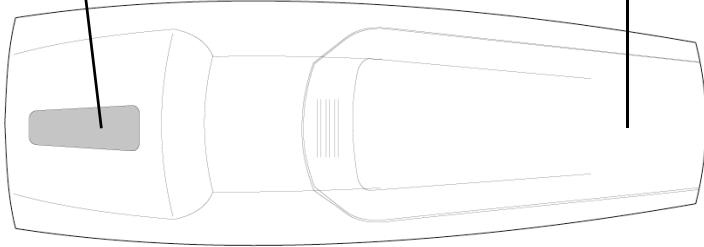
## Remote Control Warning

Laser radiation class II product; wavelength 650nm; maximum output 1mW. Remote control complies with applicable requirements of 21 CFR 1040.10 and 1040.11. Remote control complies with applicable requirements of EN 60825: 1994+A11+A2.

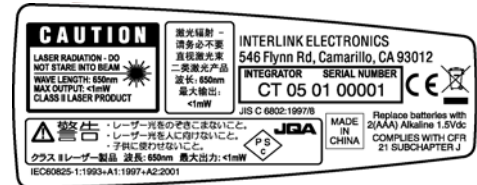
Do not look into laser beam emitted from the front of the remote control



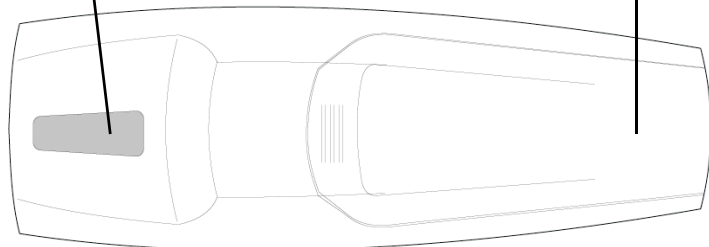
Location of laser beam warning labels on remote



Do not look into laser beam emitted from the front of the remote control



Location of laser beam warning labels on remote



OR this label



Location of laser beam warning labels on remote



OR this label



Location of laser beam warning labels on remote



## Table of Contents

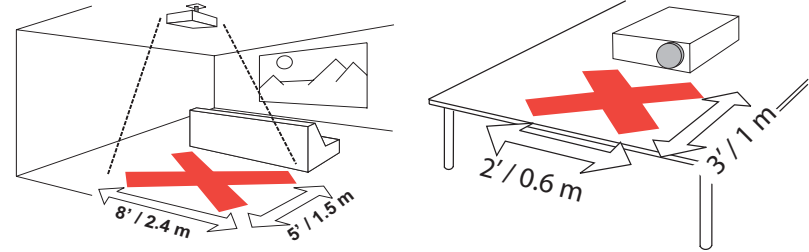
Introduction	5
Included Items	5
Positioning the projector	7
Connecting a computer	8
Required computer connections	8
Displaying a computer image	10
Adjusting the image	11
Connecting a video device	12
Displaying a video image	13
Shutting down the projector	15
Troubleshooting your setup	15
Using the keypad buttons	22
Using the remote control	23
Using the audio	24
Optimizing computer images	25
Presentation features	25
Optimizing video images	26
Customizing the projector	26
Using the menus	27
Picture menu	28
Settings menu	31
Maintenance	35
Cleaning the lens	35
Replacing the clock batteries	35
Replacing the projection lamp	36
Cleaning the dust filter	38
Using the security lock	38
Appendix	39
Projected image size	39
RS-232 commands	42

For complete details on connecting and operating the projector, refer to this User's Guide. Electronic versions of this User's Guide in multiple languages are available on our website.

The website also has technical specifications (an interactive image size calculator, laptop activation commands, connector pin outs, a glossary, the product data sheet), a web store to buy accessories, and a page for online registration. See the inside of the back cover for a list of all relevant web addresses.

### Important Operating Considerations for Safety

- Place the projector in a horizontal position no greater than 8 degrees off axis.
- Locate the projector in a well-ventilated area without any obstructions to intake or exhaust vents. Do not place the projector on a tablecloth or other soft covering that may block the vents.
- Locate the projector at least 4' (1.2 m) away from any heating or cooling vents.
- Use only approved ceiling mounts.
- **Warning:** To prevent eye injury if the projector is ceiling mounted, wear protective eyewear before opening lamp door. A warning sticker is included with the user documentation. Place this sticker on the lamp door if the projector is mounted on the ceiling.
- Only genuine InFocus lamps are tested for use in this projector. InFocus is not liable for the performance, safety or certification of any other lamps. The use of other lamps violates the projector warranty and voids all certification marks on this projector.
- Use only the power cord provided. A surge-protected power strip is recommended.
- Refer to this manual for proper startup and shutdown procedures.
- Hg – Lamp contains mercury. Manage in accordance with local disposal laws. See [www.lamprecycle.org](http://www.lamprecycle.org).
- In the unlikely event of a lamp rupture, particles may exit through the projector vents. When the projector is turned on, keep people, food, and drinks out of the "keep out" area under and around the projector, as indicated by the "X" areas.



Follow these instructions to help ensure image quality and lamp life over the life of the projector. Failure to follow these instructions may affect the warranty. For complete details of the warranty, see the Warranty booklet.

# Introduction

Your new multimedia projector provides three computer, three video, and four audio inputs, one audio output, and RS-232 and Network control. It has XGA 1024x768 resolution. Optional user-changeable short, fixed short, long and ultra long throw lenses make this a flexible product suitable for many different uses. The projector is easy to connect, easy to use, and easy to maintain.

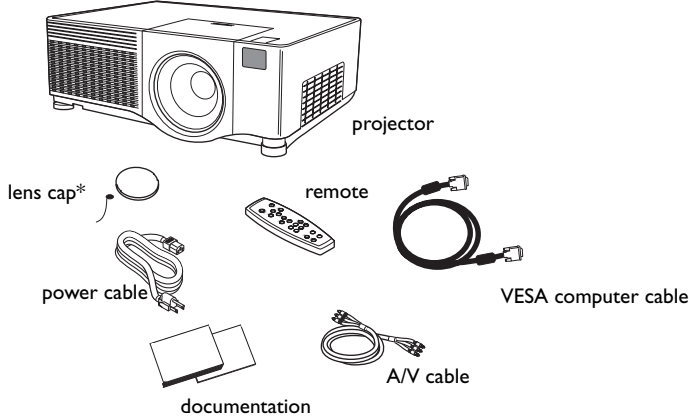
## Product specifications

To read the latest specifications on your multimedia projector, be sure to visit our website. Web address information is located on the back inside cover of this User's Guide.

## Online Registration

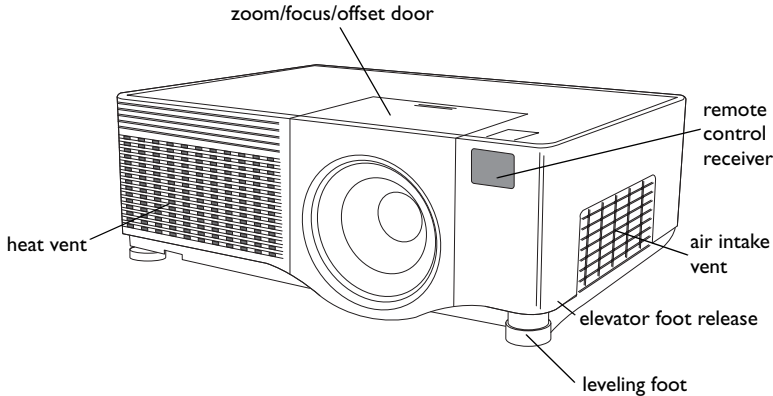
Register your projector on our website to receive product updates, announcements, and registration incentives. See the inside back cover for the web address.

## Included Items

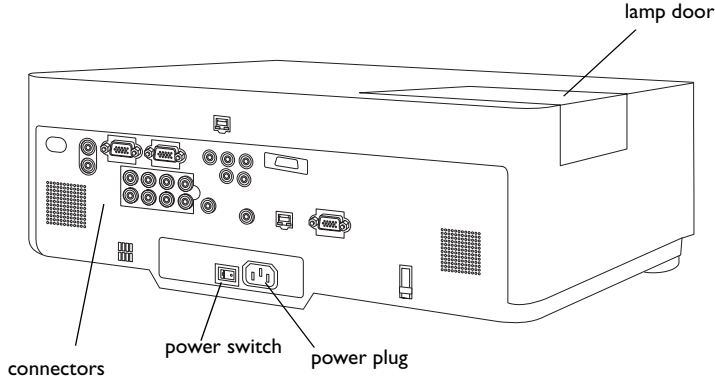


\*the lens cap tether can attach the lens cap to the projector if desired.

## Projector components and features: front



## Projector components and features: back



## Connector Panel

The projector provides three computer and three video connection options:

- one VESA computer
- one HDMI™ (High Definition Multimedia Interface)\*
- one component BNC (G/Y, B/C<sub>B</sub>/P<sub>B</sub>, R/C<sub>R</sub>/P<sub>R</sub>, H, V)
- one component RCA video (Pr, Pb, Y)
- one S-video
- one composite RCA video

The projector provides computer and video connectors for audio support:

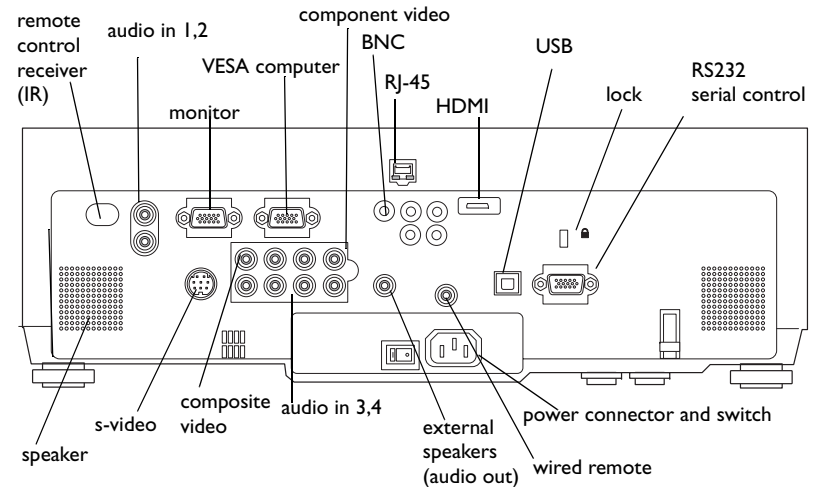
- two composite RCA stereo audio (L, R)
- one audio out
- two audio ins

The projector also provides the following connectors:

- one wired remote
- one monitor out
- RS-232 serial connector (for serial control)
- RJ-45 connector (for networked control)

The RS-232 Command Line Interface (CLI) specifications and commands are available in the Appendix and on our website. See the back inside cover of this User's Guide for website information.

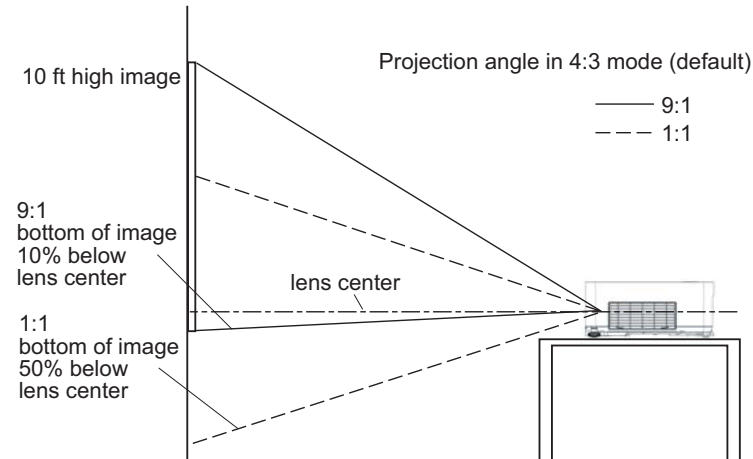
\* HDMI is an industry standard, uncompressed, all-digital audio/video interface that connects between sources, such as set-top boxes, DVD players, and receivers and your projector. To take advantage of HDMI 1.3 you must have a 1.3-compatible source. The HDMI, because it is a digital signal, yields the highest quality image. It is common for these signals to be encrypted with HDCP (high-bandwidth digital-content protection). Your new projector ships standard with decryption codes so you can enjoy these high quality, all digital images.



## Positioning the projector

To determine where to position the projector, consider the size and shape of your screen, the location of your power outlets, and the distance between the projector and the rest of your equipment. Here are some general guidelines:

- Position the projector on a flat surface at a right angle to the screen. The projector (with the standard lens) must be at least 3 feet (0.9m) from the projection screen.
- Position the projector within 10 feet (3m) of your power source and within 6 feet (1.8m) of your video device (unless you purchase extension cables). To ensure adequate cable access, do not place the projector within 6 inches (.15m) of a wall or other object.
- If you are installing the projector on the ceiling, refer to the installation guide that comes with the Ceiling Mount Kit for more information. To turn the image upside down, see "Ceiling" on page 31. We recommend using an authorized ceiling mount. The Ceiling Mount Kit is sold separately; visit our website for more information.
- Position the projector the desired distance from the screen. The distance from the lens of the projector to the screen, the zoom setting, and the video format determine the size of the projected image. For information about image sizes at different distances, see "Projected image size" on page 39.
- For the standard lens that comes with the projector, the image exits at a given angle. However, the lens shift feature makes the image offset variable. The image offset is 90% at a 9:1 ratio when the projector is in 4:3 mode (default mode). This means that if you have an image 10' high, the bottom of the image will be 1' below the center of the lens.
- The image offset is 50% when the lens shift is at a 1:1 ratio. This means that if you have an image 10' high, the bottom of the image will be 5' below the center of the lens.
- For information about the optional lenses image offsets, see "Projected image size" on page 39.





## Connecting a computer

### Required computer connections

Connect one end of the VESA computer cable to the **Computer 2** connector on the projector. Connect the other end to the video port on your computer. If you are using a desktop computer, you first need to disconnect the monitor cable from the computer's video port.

Connect the black power cable to the connector on the back of the projector and to your electrical outlet.

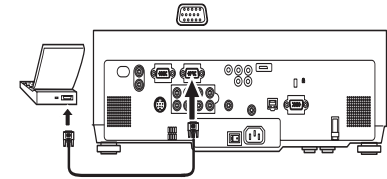
**NOTE:** Always use the power cable that shipped with the projector.

### Optional computer connections

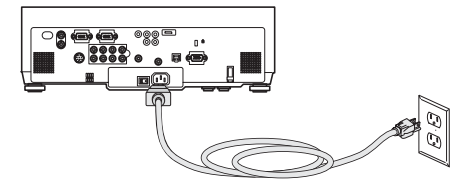
You can also connect to your computer using optional BNC or HDMI cables. Connect the BNC connectors on the BNC cable to the appropriate **Computer 3** connectors on the projector. Connect the other end to the video port on your computer. If you are using a desktop computer, you first need to disconnect the monitor cable from the computer's video port. Or, connect the HDMI cable to the **Computer 1** connector.

To have sound with your presentation, connect the audio cable to your computer and to the corresponding computer **Audio In** connector on the projector. You can assign a particular source to a particular audio in connector, see page 31.

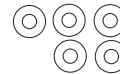
connect computer cable



connect power cable



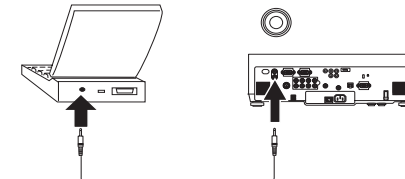
connect BNC cable



connect HDMI cable

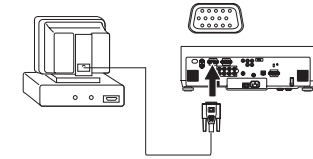


connect audio cable



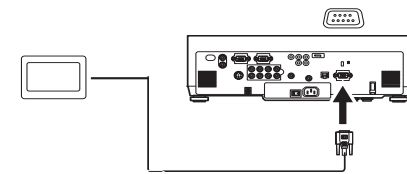
If you are using a desktop computer and want to see the image on your computer screen as well as on the projection screen, plug the monitor cable to the **Monitor out** connector on the projector.

connect monitor cable



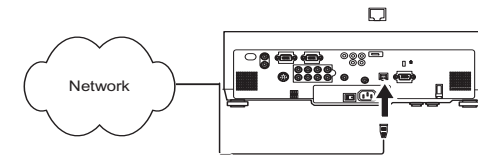
You can control the projector from an LCD control panel, touch screen, or other control device or computer by connecting an RS-232 cable to the projector's **Serial Control** connector. Specific RS-232 commands can be found in the Service and Support section of our website and in the Appendix.

connect RS-232 cable



The projector can be managed by networking software through its **Network** (RJ-45) connector. Detailed instructions on this feature can be found on our website.

connect CAT-5 cable



## Displaying a computer image

Remove the lens cap.

Press the power switch on the back of the projector to the on (I) position. The Power light on the Status Indicator Panel (page 15) lights green.

Press the **Power** button on the top of the projector or the remote.

The Power light blinks green and the fans start to run. When the lamp comes on, the startup screen is displayed and the light is steady green. It can take a minute for the image to achieve full brightness.

**? No startup screen?** Get help on page 16.

Turn on your computer.

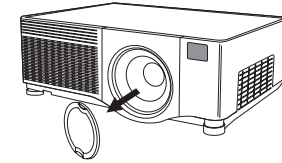
The computer's image should appear on the projection screen. If it doesn't, press the **Source** button on the keypad or remote.

Make sure your laptop's external video port is active.

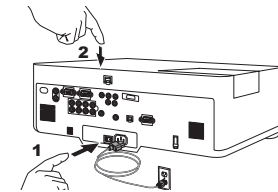
Many laptops do not automatically turn on their external video port when a projector is connected. Usually a key combination like FN + F5 is used to turn the external display on and off. Refer to your computer's documentation to learn your computer's key combination.

**? No computer image?** Get help on page 16.

remove lens cap



press Power switch    press Power button



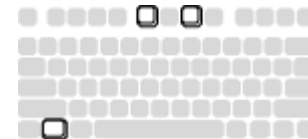
turn on computer



source



activate laptop's external port



## Adjusting the image

Adjust the height of the projector, if necessary, by pressing the release buttons on each side of the projector's front to extend the elevator feet.

Position the projector the desired distance from the screen at a 90 degree angle (perpendicular) to the screen.

See page 39 for a table listing screen sizes and distances.

Adjust the zoom or focus by rotating the **Zoom** or **Focus** rings inside the lens door until the desired image size and focus are produced.

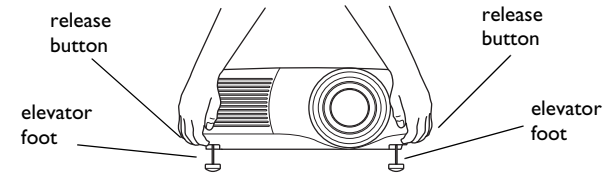
If the image is not on the screen or viewing area, adjust it by using the lens shift dials inside the lens door.

Use the right dial to shift the lens left or right. Use the left dial to shift the lens up or down.

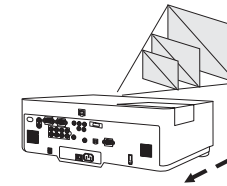
Adjust the Contrast or Brightness in the Picture menu.

See page 27 for help with the menus.

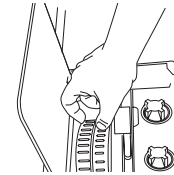
adjust height



adjust distance



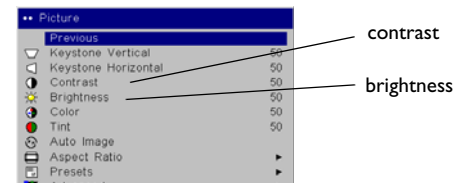
adjust zoom and focus



adjust lens shift



adjust Contrast or Brightness



## Connecting a video device

### Standard video connections

Plug the audio/video (A/V) cable's yellow connector into the video-out connector on the video device. Plug the other yellow connector into the yellow **Video 3** connector on the projector. Plug a white connector into the left audio out connector on the video device and plug a red connector into the right audio out connector on the video device. Plug the remaining white connector into a left **audio in** connector on the projector, and plug the red connector into a right **audio in** connector on the projector. You can assign a particular source to a particular audio in connector, see page 31.

Connect the black power cable to the connector on the back of the projector and to your electrical outlet.

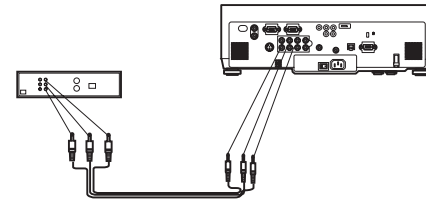
**NOTE:** Always use the power cable that shipped with the projector.

### Optional video connections

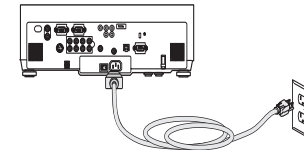
If the video device uses a round, four-prong S-video connector, plug an S-video cable (sold separately) into the S-video connector on the video device and into the **Video 2** connector on the projector. Use the A/V cable's audio connectors as described directly above (the yellow connectors on the A/V cable are not used).

If the video device uses component cable connectors (sold separately), plug the cable's green connectors into the green component-out connector on the video device and into the **Video 1** green component connector (labeled "Y") on the projector. Plug the component cable's blue connectors into the blue component-out connector on the video device and into the blue component connector (labeled "Cb/Pb") on the projector. Plug the component cable's red connectors into the red component-out connector on the video device and into the red component connector (labeled "Cr/Pr") on the projector. Use the A/V cable's audio connectors as described above (the yellow connectors on the A/V cable are not used). **NOTE:** The component connectors can be used for HDTV sources (480i, 480p, 720p, 576i and 1080i formats).

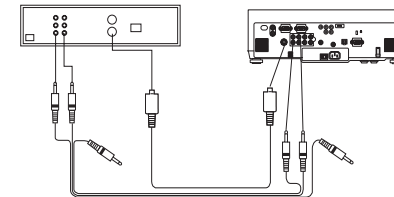
connect A/V cable



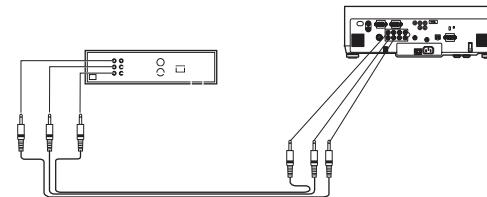
connect power cable



connect S-video and video cables



connect component cables and video cables



## Displaying a video image

Remove the lens cap.

Press the power switch on the back of the projector to the on (I) position. The Power light on the Status Indicator Panel (page 15) lights green.

Press the **Power** button on the top of the projector or the remote.

The Power light blinks green and the fans start to run. When the lamp comes on, the startup screen is displayed and the light is steady green. It can take a minute for the image to achieve full brightness.

**? No startup screen?** Get help on page 16.

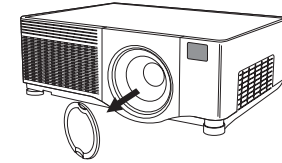
Plug in and turn on the video device.

The video device's image should appear on the projection screen. If it doesn't, press the **Source** button on the keypad or remote.

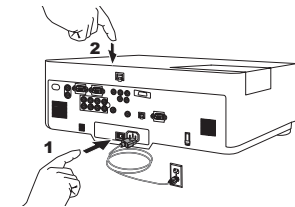
Adjust the height of the projector, if necessary, by pressing the release buttons on each side of the projector's front to extend the elevator feet. Rotate the feet, if necessary, to level the projector.

Position the projector the desired distance from the screen at a 90 degree angle to the screen. See page 39 for a table listing screen sizes and distances to the screen.

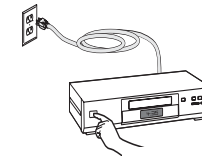
remove lens cap



press Power switch      press Power button



turn on video device



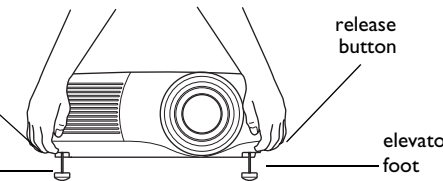
adjust height

release button

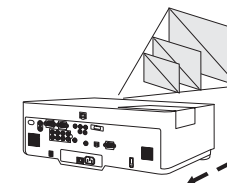
release button

elevator foot

elevator foot

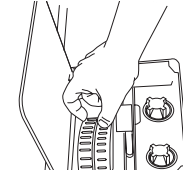


adjust distance



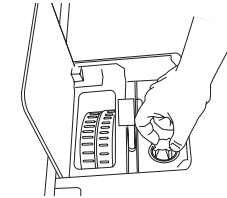
Adjust the zoom or focus by rotating the **Zoom** or **Focus** rings inside the lens door until the desired image size and focus are produced.

adjust Zoom and Focus



If the image is not on the screen or viewing area, adjust it by using the lens shift dials inside the lens door.

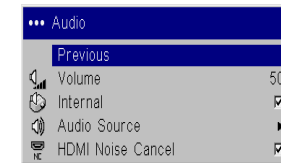
adjust Lens Shift



Use the right dial to shift the lens left or right. Use the left dial to shift the lens up or down.

adjust volume

Adjust the volume in the Audio menu.

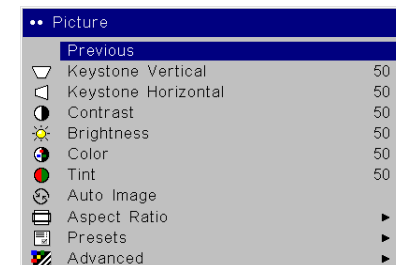


adjust Picture menu

Adjust the **Contrast**, **Brightness**, **Color**, or **Tint** in the Picture menu.



See page 27 for help with the menus.



## Shutting down the projector

The projector automatically blanks the screen after no active source is detected for 5 minutes. This blank screen helps preserve the life of the projector. The image returns when an active source is detected or a remote or keypad button is pressed.

### Screen Save

You can make the blank screen appear after five minutes by turning on Screen Save in the **Settings>System** menu. See page 32.

### Power Save

The projector also has a Power Save feature that automatically turns the lamp off after no signals are detected for 20 minutes. After 10 additional minutes with no signal, the projector powers down. If an active signal is received before the projector powers down, the image is displayed. You must press the Power button to display an image after 30 minutes have passed. When Power Save is enabled, Screen Save is disabled. See page 32.

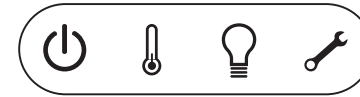
### Turning off the projector

To turn off the projector, press the **power** button and verify that you want to turn the projector off by pressing the power button again within 3 seconds. You can cancel the shutdown by not pressing the **power** button a second time. The lamp turns off and the Power light blinks green for over 1 minute while the fans continue to run to cool the lamp. When the lamp has cooled, the Power light is solid green and the fans stop. Press the power switch on the back of the projector and unplug the power cable to completely power off the projector.






## Troubleshooting your setup

If your image appears correctly on the screen, skip to the next section. If it does not, troubleshoot the setup.

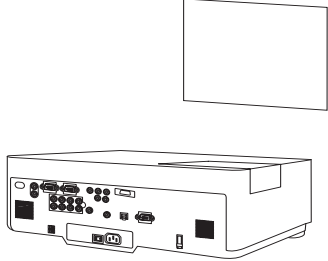
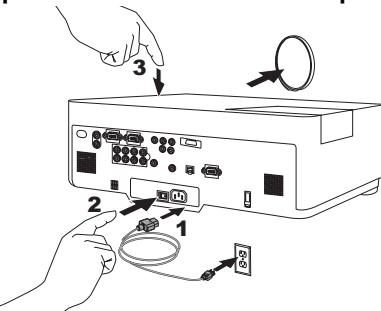
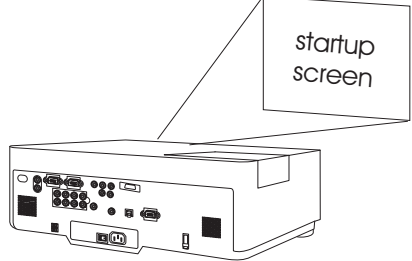
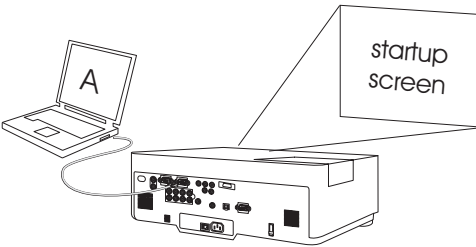

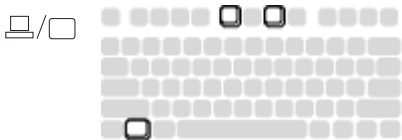
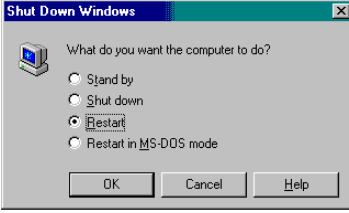
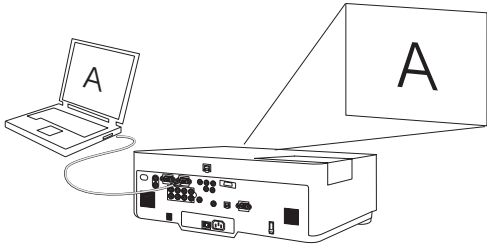
The Status Indicator Panel on top of the projector indicates the state of the projector and can help you troubleshoot.



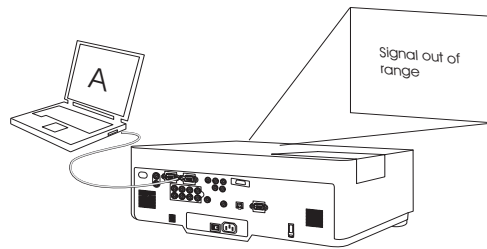
**Table 1: Status indicator light behavior and meaning**

Status Indicator Panel icons	Meaning
Power, solid green 	The power button has been pressed and the software has initialized or the projector has been powered off.
Power, blinking green 	The power button has been pressed and the software is initializing, or the projector is powering down and the fans are running to cool the lamp.
Thermometer 	The projector is too hot. Make sure the vents aren't blocked (see page 20). Turn off the projector and wait one minute, then turn the projector on again. Contact Technical Support if the problem persists.
Lamp 	Turn off the projector and wait one minute, then turn the projector on again. If the lamp light turns on again, replace the lamp and reset the lamp timer.
Wrench/Service 	Turn off the projector and wait one minute, then turn the projector on again. If the service lamp turns on again, service is required. Visit our website to contact Service.

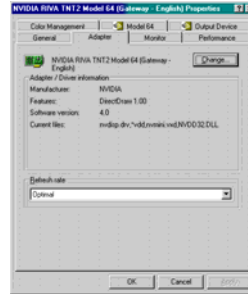


Problem	Solution	Result
<p data-bbox="241 430 451 454"><b>No startup screen</b></p> 	<p data-bbox="850 397 1333 446"><b>Plug power cable in, press power switch and power button. Remove lens cap.</b></p> 	<p data-bbox="1365 430 1533 454"><b>Correct image</b></p> 
<p data-bbox="241 787 787 812"><b>Only startup screen appears/no computer image</b></p> 	<p data-bbox="850 820 1186 876"><b>Press the Source button</b> </p> <p data-bbox="850 852 1186 876"><b>Activate laptop's external port</b></p>  <p data-bbox="840 1055 955 1112"><b>or restart laptop</b></p> 	<p data-bbox="1365 787 1669 812"><b>Computer image projected</b></p> 

No computer image, just the words “Signal out of range”



Adjust computer refresh rate in Control Panel>Display>Settings>Advanced>Adapter (location varies by operating system)



You may also need to set a different resolution on your computer, as shown in the following problem, “Image fuzzy or cropped”

Computer image projected

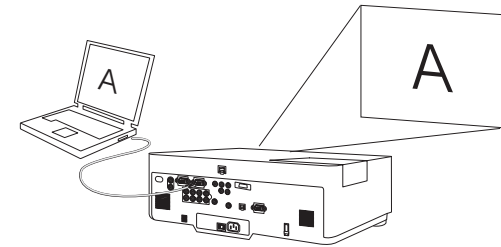
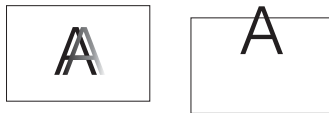


Image fuzzy or cropped



Set your computer’s display resolution to the native resolution of the projector (Start>Settings>Control Panel>Display>Settings tab, select 1024x768)

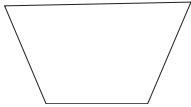
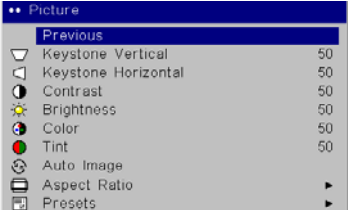


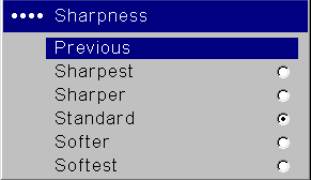


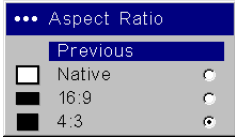

For a laptop, disable laptop monitor or turn-on dual-display mode


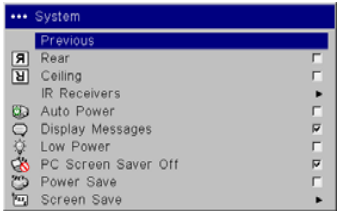


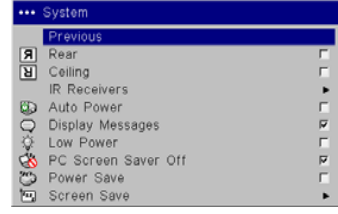


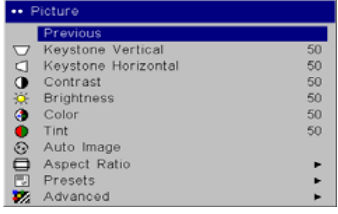



Image clear and not cropped

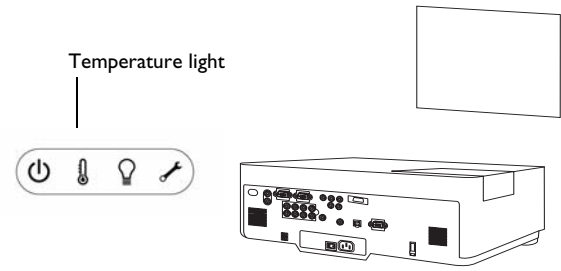


**Projector troubleshooting**

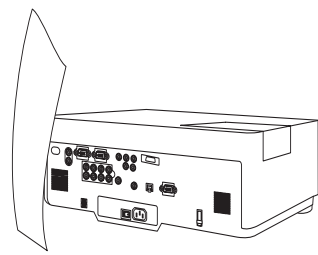
Problem	Solution	Result
<p><b>Image not square</b></p> 	<p><b>Adjust keystone the Picture menu</b></p> 	<p><b>Square image</b></p> 
<p><b>Image not sharp</b></p> 	<p><b>Adjust the focus ring or Sharpness in the Picture&gt;Advanced menu</b></p> 	<p><b>Correct image</b></p> 
<p><b>Image does not fit 16:9 screen</b></p> 	<p><b>Change aspect ratio to 16:9 in Picture&gt;Aspect ratio menu</b></p> 	<p><b>Correct image</b></p> 

<p><b>Image upside down</b></p> 	<p><b>Turn on/off Ceiling in Settings&gt;System menu</b></p> 	<p><b>Correct image</b></p> 
<p><b>Image reversed left to right</b></p> 	<p><b>Turn on/off Rear in Settings&gt;System menu</b></p> 	<p><b>Correct image</b></p> 
<p><b>Projected colors don't match source</b></p> 	<p><b>Adjust color, tint, color temperature, brightness, contrast in the menus</b></p> 	<p><b>Correct image</b></p> 

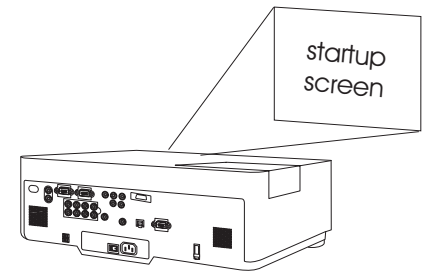
**Lamp won't turn on, Temp light is lit (page 15)**



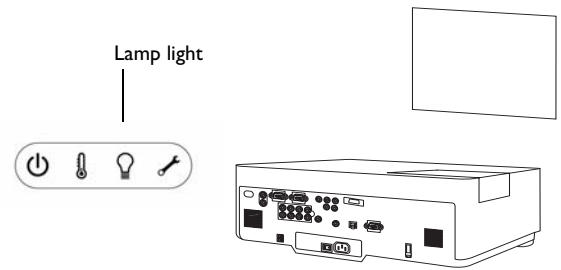
**Make sure vents aren't blocked; allow projector to cool for one minute**



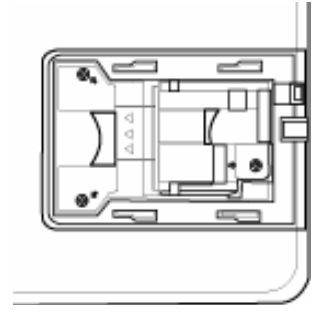
**Unplug projector; wait 20 minutes; plug in projector and turn it on: lamp lights**



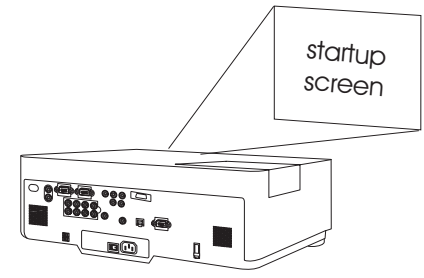
**Lamp won't turn on, Lamp light is lit (page 15)**

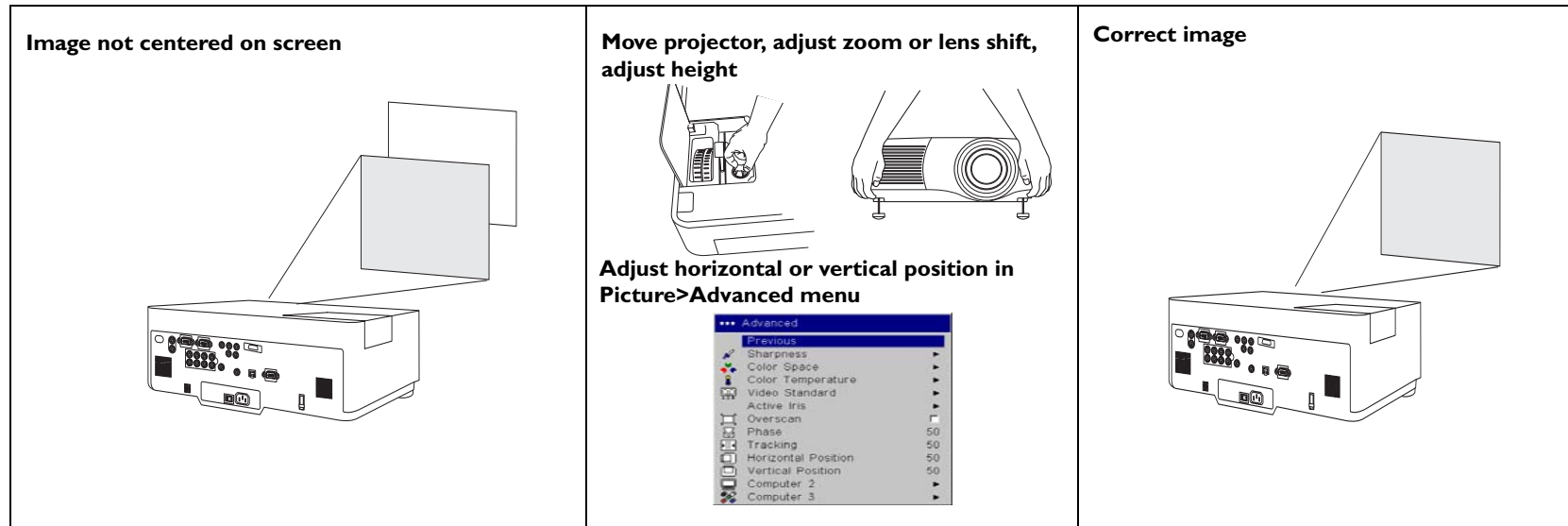


**Lamp may need to be replaced (page 36)**



**Lamp turns on**





**Still having problems?**

If you need assistance, visit our website or call us. See the inside of the back cover for a list of all relevant web addresses.

This product is backed by a limited warranty. An extended warranty plan may be purchased from your dealer. When sending the projector in for repair, we recommend shipping the unit in its original packing material, or having a professional packaging company pack the unit. Please insure your shipment for its full value.

## Using the keypad buttons

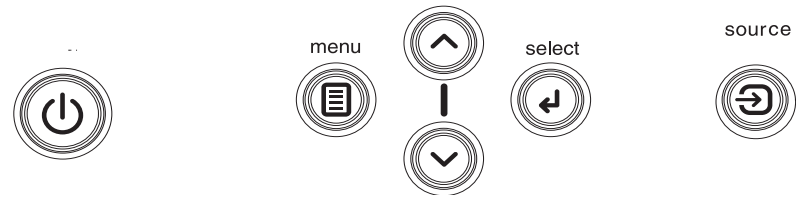
**power**—turns the projector on (page 10) and off (page 15).

**menu**—opens the on-screen menus (page 27).

**up/down arrows**—navigates to and adjusts settings in the menus (page 27).

**select**—confirms choices made in the menus (page 27).

**source**—switches among active sources



## Using the remote control

The remote uses two (2) provided AAA batteries (Hitachi Maxell, part number LR03). They are easily installed by sliding the cover off the remote's back, aligning the + and - ends of the batteries, sliding them into place, and then replacing the cover.

To operate, point the remote at the projection screen or at the projector (not at the computer). The range of optimum operation is about 16 feet (5m). For best results, aim the remote directly at the projector.

To use the laser pointer, press and hold the **Laser** button. The laser turns off when the button is released, or times out after two (2) minutes of continuous operation.

**WARNING:** Do not look into the laser beam emitted from the top of the remote control.

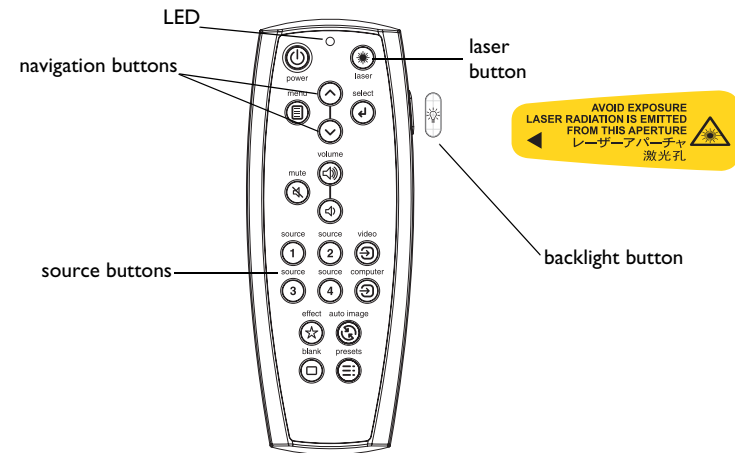
The remote contains four **Source** buttons that allow you to assign a particular input to a specific source. Simply press the numbered Source buttons to travel to whatever four sources you wish to have available.

Press the remote's **Menu** button to open the projector's menu system. Use the arrow buttons to navigate, and the **Select** button to select features and adjust values in the menus.

The remote also has a power button to turn the projector on and off, volume buttons and a mute button to control the sound, a backlight button to light the remote's buttons in the dark, and a video and computer button to switch between those two sources.

Two presentation-specific features are also provided. Use the blank button to display a blank screen instead of the current slide; use the effect button to invoke a user-definable action, such as freeze, PiP, or magnify.

The Auto Image button reacquires the computer image and the Presets button lets you customize the settings for each source. Up to three Preset settings can be customized and saved.



## Troubleshooting the remote

- Make sure the batteries are installed in the proper orientation and are not dead. The LED at the top of the remote lights when any button is pressed when the battery power is adequate.
- Make sure you're pointing the remote at the projector, not the computer, and are within the remote range of 16 feet (5m).



## Using the audio

To play sound from the projector, connect your source to an Audio In connector on the projector.

To adjust the volume, mute, or loudness, use the Audio menu (see page 31).

### Troubleshooting audio

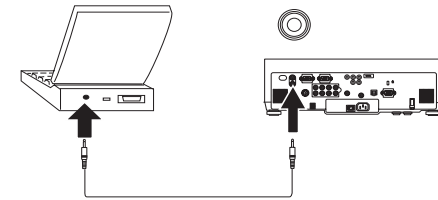
If there is no sound, check the following:

- Make sure the audio cable is connected.
- Make sure mute isn't active.
- Make sure the volume is turned up enough.
- Make sure you are connected to the corresponding **audio in** for your source. By default, **Audio 1** corresponds to **Computer 2**, **Audio 2** corresponds to **Computer 3**, **Audio 3** corresponds to **Video 2** and **3**, and **Audio 4** corresponds to **Video 1**. You can change these assignments, see page 31.
- Adjust the audio source.
- If playing a video, make sure the playback has not been paused.

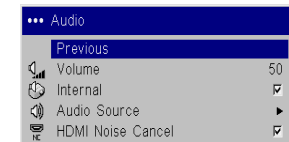
### Connecting external speakers

The projector can be attached to external speakers that have their own power source by plugging a speaker cable into the projector's **Audio Out** connector.

connect audio cable

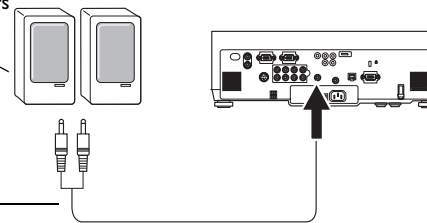


adjust volume



external speakers

speaker cable



## Optimizing computer images

After your computer is connected properly and the computer's image is on the screen, you can optimize the image using the onscreen menus. For general information on using the menus, see page 27.

- Adjust the Keystone, Contrast, or Brightness in the Picture menu.
- Change the Aspect Ratio. Aspect Ratio is the ratio of the image width to image height. TV screens are usually 1.33:1, also known as 4:3. HDTV and most DVDs are 1.78:1, or 16:9. Choose the option that best fits your input source. See page 28 for details.
- Adjust the Color Temperature in the Advanced menu.
- Adjust the Phase, Tracking, or Horizontal or Vertical position in the Advanced menu.
- Once you have optimized the image for a particular source, you can save the settings using Presets. This allows you to quickly recall these settings later. See page 29.

## Presentation features

Several features are provided to make giving presentation easier. The following is an overview, details are found in the menu section on page 27.

- The **Custom** key, available on several optional remotes only, allows you to assign various features to the key. The default effect is Source Info. You can select from Blank, Mute, AV Mute, Aspect Ratio, Source, Auto Image, Freeze, Magnify, Source Info, and Service Info. See page 33 for details.
- The Freeze effect allows you to freeze the displayed image. This is useful if you want to make changes on your computer without your audience seeing them.
- The Startup Logo menu option lets you change the default startup screen to a black, white, blue, or a custom logo screen via Capture New. See page 32.
- Two menu options, Power Save and Screen Save, are provided to automatically shut down the projector after several minutes of inactivity or display a blank screen. This helps preserve lamp life. See page 32.
- A Low Power menu option is also available to help lower the projector's fan sound volume. See page 31.

## Optimizing video images

After the video device is connected properly and the image is on the screen, you can optimize the image using the onscreen menus. For general information on using the menus, see page 27.

- Adjust the Keystone, Contrast, Brightness, Color, or Tint in the Picture menu. See page 28.
- Change the Aspect ratio. Aspect ratio is the ratio of the image width to image height. TV screens are usually 1.33:1, also known as 4:3. HDTV and most DVDs are 1.78:1, or 16:9. Choose the option that best fits your input source. See page 28.
- Select a Sharpness setting. See page 29.
- Adjust the Color Temperature. Select a listed value, or select User and individually adjust the intensity of the red, green, and blue color. See page 29.

## Customizing the projector

You can customize the projector for your specific setup and needs. See page 31 to page 34 for details on these features.

- For rear projection, turn Rear mode on in the **Settings>System** menu.
- For ceiling mounted projection, turn Ceiling mode on in the **Settings>System** menu.
- Specify which source the projector checks first for an active signal during power-up.
- Turn the projector's on-screen display messages on and off.
- Turn on power saving features.
- Specify blank screen colors and startup logos.
- Specify the menu language.
- Control your projector using RS232 commands. See page 9 and page 42.
- Customize the projector for your specific installation using optional long or short throw lenses. See the inside back cover of this User's Guide for ordering information.

## Using the menus

To open the menus, press the menu button on the keypad or remote. (The menus automatically close after 60 seconds if no buttons are pressed.) The Main menu appears. Use the arrow buttons to move up and down to highlight the desired submenu, then press the **Select** button.

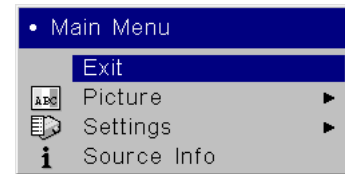
To change a menu setting, highlight it, press **Select**, then use the up and down arrow buttons to adjust the value, select an option using radio buttons, or turn the feature on or off using check boxes. Press **Select** to confirm your changes. Use the arrows to navigate to another setting. When your adjustments are complete, navigate to Previous, then press **Select** to go to the previous menu; press the **Menu** button at any time to close the menus.

Dots appear before the menu name. The number of dots indicate the menu's level, ranging from one (the Main menu) to five (the most nested menus).

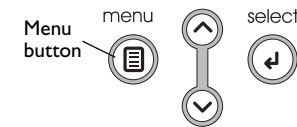
The menus are grouped by usage:

- The Picture menu provides image adjustments.
- The Settings menu provides set-up type adjustments that are not changed often.
- The Source Info menu provides a read-only display of information about the projector and source.

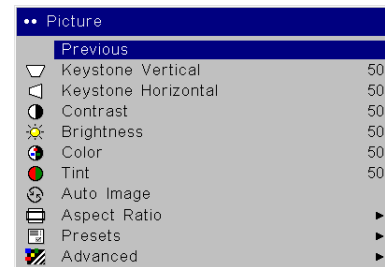
Certain menu items may be grayed out until a particular source is connected. For example, Tint is only available for video sources and will be hidden when a computer source is active. Other menu items may be grayed out when they are not available. For example, Brightness is grayed out until an image is active.



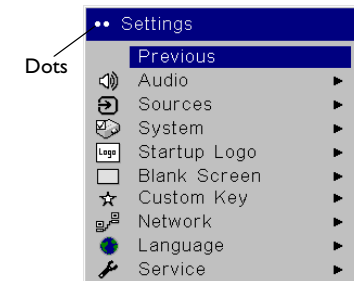
Main menu



Keypad navigation buttons



Picture menu



Settings menu



Source Info menu

## Picture menu

To adjust the following six settings, highlight the setting, press **Select**, use the up and down arrows to adjust the values, then press select to confirm the changes.

**Keystone Vertical:** adjusts the image vertically and makes a squarer image by using an adjustable scale band.

**Keystone Horizontal:** adjusts the image horizontally and makes a squarer image by using an adjustable scale band.

**Contrast:** controls the degree of difference between the lightest and darkest parts of the picture and changes the amount of black and white in the image.

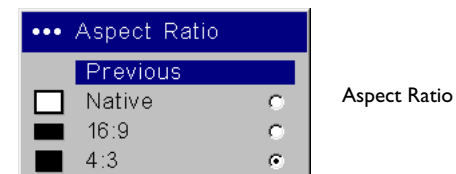
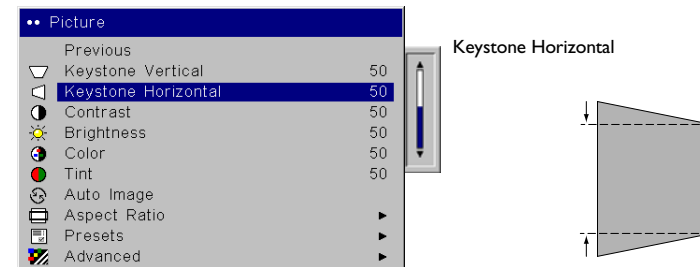
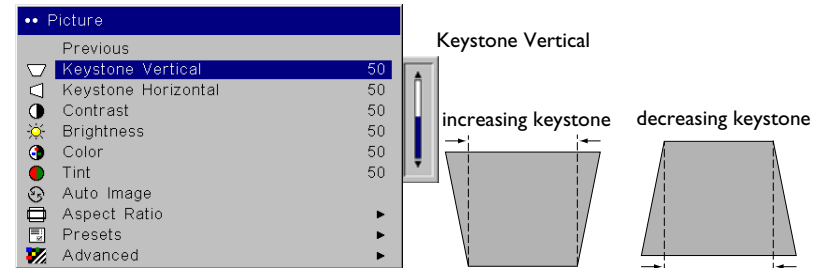
**Brightness:** changes the intensity of the image.

**Color:** (Computer 1 and video sources only) adjusts a video image from black and white to fully saturated color.

**Tint:** (Computer 1 and NTSC video sources only) adjusts the red-green color balance in the image.

**Auto Image:** resynchs the projector to the source.

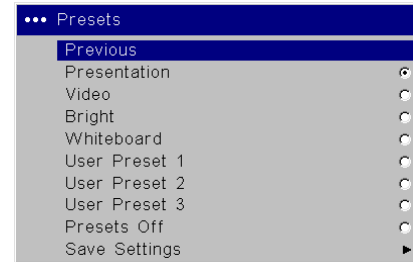
**Aspect Ratio:** Aspect ratio is the ratio of the image width to image height. TV screens are usually 1.33:1, also known as 4:3. HDTV and most DVDs are 1.78:1, or 16:9. The default is 4:3, which displays the input resized up or down to fill the display area.



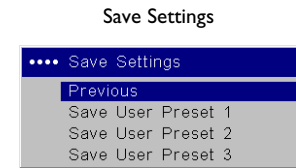
**Presets:** Presets are provided that optimize the projector for displaying computer presentations and video images in different lighting conditions and on different backgrounds.

There are also user-definable presets. To set a preset for the current source, adjust the image, select Save Settings in the Presets menu, then select Save User Presets 1 (or 2 or 3). You can recall these settings in the future by selecting the User 1 preset. If you select User Presets then further adjust the image, Presets Off will automatically be selected in the Preset menu to indicate changes have been made.

To restore the factory default settings, choose Factory Reset in the **Settings>Service** menu.



Presets

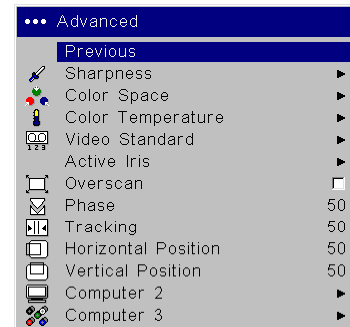


### Advanced settings

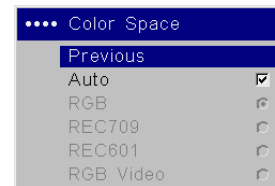
**Sharpness:** changes the clarity of the edges of a video image. Select a sharpness setting.

**Color Space:** This option applies to computer and component video sources (except 480i/576i). It allows you to select a color space that has been specifically tuned for the input signal. When Auto is selected, the projector automatically determines the standard. To choose a different setting, turn off Auto, then choose RGB for computer sources, RGB Video for HDMI computer sources, and either REC709 or REC601 for component video sources.

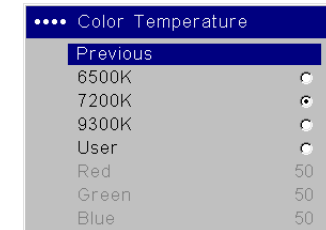
**Color Temperature:** changes the intensity of the colors. Select a listed value, or select User and individually adjust the intensity of the red, green, and blue colors.



Sharpness



Color Space



Color Temperature

**Video Standard:** when set to Auto, the projector attempts to automatically pick the video standard based on the input signal it receives. (The video standard options may vary depending on your region of the world.) If the projector is unable to detect the correct standard, the colors may not look right or the image may appear “torn.” If this happens, manually select a video standard by selecting NTSC, PAL, or SECAM from the Video Standard menu.

**Active Iris:** when on, the projector monitors the image brightness and modifies the light output if the image is dark, which improves black levels. In Presentation mode, it looks at peak brightness, in Theater mode it looks at average brightness.

**Overscan:** (Computer 1 and video sources only) removes noise around the video image.

The following 4 options are for computer sources only:

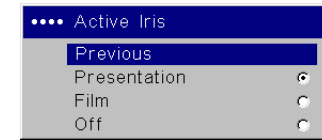
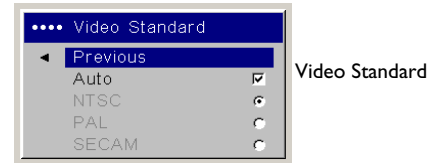
**Phase:** adjusts the horizontal phase of computer 2, 3 and component (except 480i and 576i) sources.

**Tracking:** adjusts the horizontal scan of a computer source (except Computer 1).

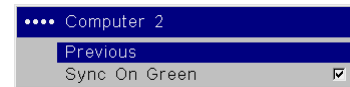
**Horizontal / Vertical Position:** adjusts the position of a computer source (except Computer 1) and Video 1 source (except 480i and 576i).

**Computer 2:** allows you to turn Sync on Green on for this source.

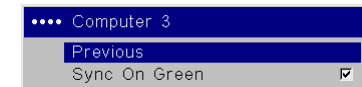
**Computer 3:** allows you to turn Sync on Green on for this source.



Active Iris



Computer 2



Computer 3

## Settings menu

**Audio:** allows adjustments to the volume. Also allows you to turn on and off the Internal speakers and assign a particular source to a specific audio input. If your HDMI source has problems with its audio stream, you can mute it by selecting HDMI Noise Cancel.

**Sources:** allows you to assign a particular input to a specific source key when using the remote. Also allows selection of a default Startup Source and enables or disables Autosource.

**Sources>Power-up Source:** this determines which source the projector checks first for active signal during power-up.

**Sources>Autosource:** When Autosource is not checked, the projector defaults to the source selected in Powerup Source. If no source is found, a blank screen displays. When Autosource is checked, Powerup Source determines which source the projector defaults to at power-up. If no signal is present, the projector checks the sources in order until a source is found or until power down.

**System>Rear:** reverses the image so you can project from behind a translucent screen.

**Ceiling:** turns the image upside down for ceiling-mounted projection.

**WARNING:** To prevent eye injury if the projector is ceiling mounted, wear protective eyewear before opening lamp door. A warning sticker is included with the user documentation. Place this sticker on the lamp door if the projector is mounted on the ceiling.

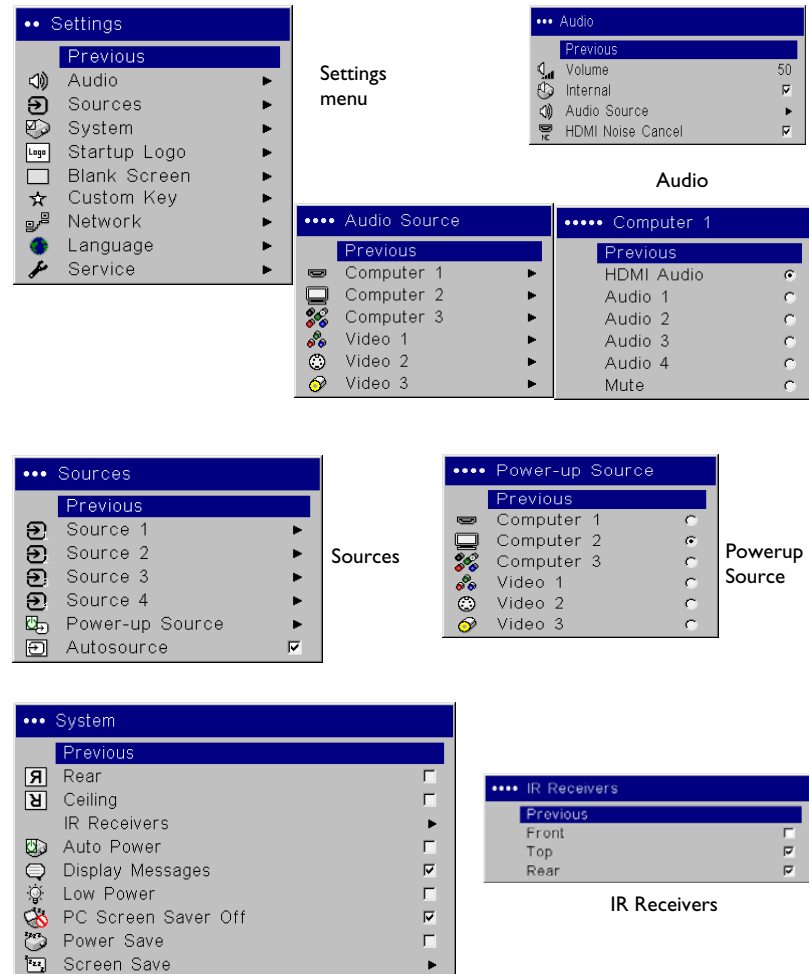
**IR Receivers:** turns individual IR receivers off or on to avoid environmental interference.

**Auto Power:** When Auto Power is checked, the projector automatically goes into the startup state after the projector is powered on. This allows control of ceiling mounted projectors with a wall power switch.

**Display Messages:** displays status messages (such as "Searching") in the lower-left corner of the screen.

**Low Power:** toggles between on and off. Turn it on to lower the light output of the lamp. This also lowers the fan speed, making the projector quieter.

**PC Screen Saver Off:** prevents your notebook computer from going into Screen Save mode. The projector must be connected to the PC via a USB cable for this feature to work.





**Power Save:** automatically turns the lamp off after no signals are detected for 20 minutes. After 10 additional minutes with no signal, the projector powers down. If an active signal is received before the projector powers down, the image will be displayed.

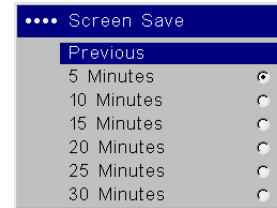
**Screen Save:** automatically blanks the screen after no signals are detected for five minutes. The image returns when an active source is detected or a remote or keypad button is pressed. Screen Save is disabled when Power Save is enabled.

**Startup Logo:** allows you to display a blank Black, White, or Blue screen instead of the default screen when no source is detected at startup. It also allows you to capture and display a custom startup screen.

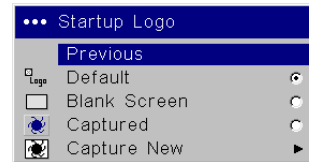
To capture a custom logo, display the image you want to capture on your computer and select the Capture New option. From the **Capture New** menu, use the Capture Position X and Capture Position Y adjustments to frame the logo to be captured. Press Capture Start in the **Capture New** menu. The projector will let you know if the capture was a success or a failure.

The next time you start the projector, the custom logo you captured displays.

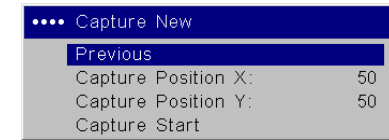
**Blank Screen:** determines what color is displayed when you press the **Blank** button on an optional remote.



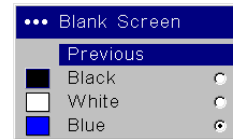
Screen Save



Startup Logo



Capture New



Blank Screen

**Custom Key** (for use with optional remote only): allows you to assign a different function to the **Custom** key on the optional remote to quickly and easily use the effect. Only one effect can be enabled at a time. The default is Source Info; highlight an effect and press **Select** to choose a different one.

**Blank:** shows an empty screen.

**Mute:** turns off all sound.

**AV Mute:** turns off all sound and displays a blank screen.

**Aspect Ratio:** sets the ratio of the image width to image height.

**Source:** cycles through the available sources.

**Auto Image:** causes all sources to be reacquired.

**Freeze:** pauses the projected image.

**Magnify:** allows you to enlarge a section of the projected image.

**Source Info:** displays the Source Info menu.

**Service Info:** displays the Service Info menu.

**Network:** The projector has an RJ45 Ethernet connector that supports network connections and TCP/IP protocols. This will allow for the control and management of the projector over a corporate network. Visit our website for complete details on using the networking functionality. The following fields are accessible when DHCP is not checked and available for manual entry of data.

**IP Address:** Identifies the projector on the network.

**Subnet Mask:** Separates the network address part of the IP address.

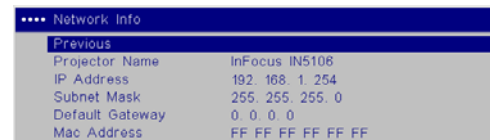
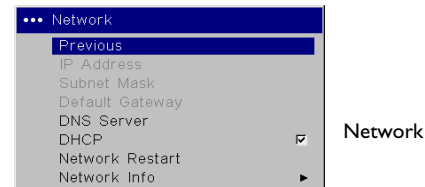
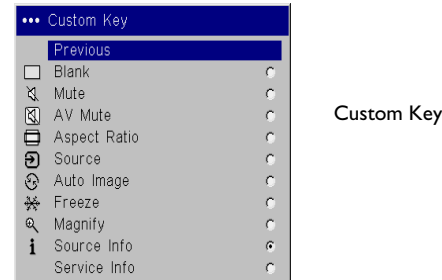
**Default Gateway:** The IP address of the local router.

**DNS Server:** Shows the address of the DNS server.

**DHCP:** Select this to automatically obtain an IP address, Subnet mask, and Default gateway.

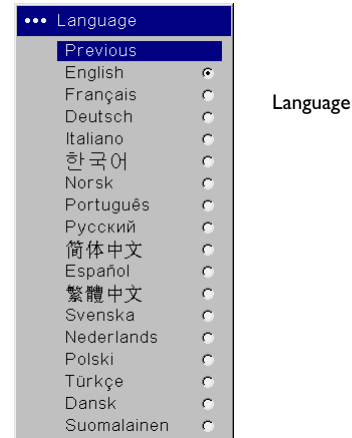
**Network Restart:** Disconnects the projector from the network, gets a new IP address, and reconnects.

**Network Info:** Provides information on the network configuration.



Network Info

**Language:** allows you to select a language for the onscreen display of menus and messages.



**Service:** to use these features, highlight them and press **Select**.

**Factory Reset:** restores all settings (except Lamp and Filter Hours and Network settings) to their default after displaying a confirmation dialog box.

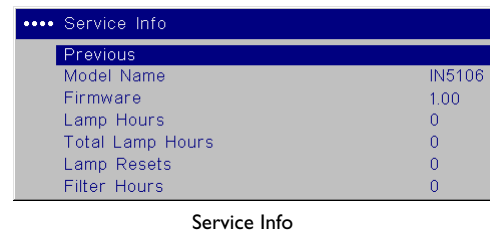
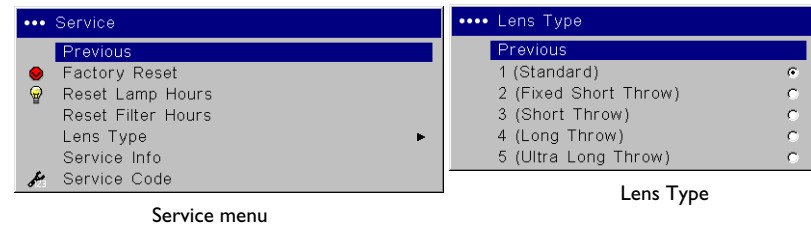
**Reset Lamp Hours:** resets the lamp hours counter in the Service Info menu to zero. Do this only after changing the lamp. It displays a confirmation dialog box.

**Reset Filter Hours:** resets the filter counter in the Service Info menu to zero. Do this only after cleaning the filter. It displays a confirmation dialog box.

**Lens Type:** change this setting only if you purchase an optional lens. The projector customizes its keystone settings based on the lens used. Select your optional lens from the menu. A sticker containing a number between 1 and 5 is attached to the lens to help you identify which type of lens you purchased.

**Service Info:** provides information for service.

**Service Code:** only used by authorized service personnel.



## Maintenance

### Cleaning the lens

- 1 Apply a non-abrasive camera lens cleaner to a soft, dry cloth.  
  
Avoid using an excessive amount of cleaner, and don't apply the cleaner directly to the lens. Abrasive cleaners, solvents or other harsh chemicals might scratch the lens.
- 2 Lightly wipe the cleaning cloth over the lens in a circular motion. If you don't intend to use the projector immediately, replace the lens cap.

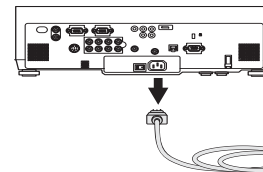
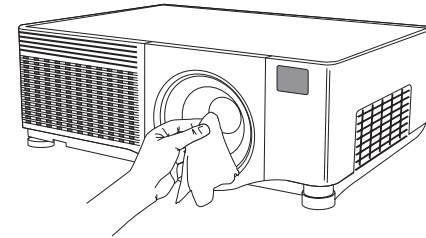
### Replacing the clock batteries

The projector has a lithium Hitachi Maxell battery (part number CR2032) on the bottom that is used to power the clock used for networking applications. Visit our website for complete details on using the networking functionality.

- 1 Turn off the projector and unplug the power cable.
- 2 Wait 45 minutes to allow the projector to cool thoroughly.
- 3 Turn the projector upside down and use a coin to turn the battery cover to the "Open" position.
- 4 Remove the battery and dispose of in an environmentally proper manner.
- 5 Install a new battery with the "+" side facing up.
- 6 Press the battery into place, then replace the battery cover.

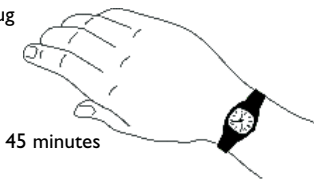
**NOTE:** The clock time will need to be reset in the web browser application after replacing the battery.

clean the lens  
with a soft dry cloth  
and non-abrasive  
cleaner

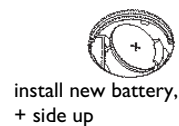


turn off and unplug  
the projector

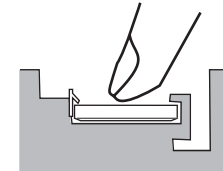
wait 45 minutes



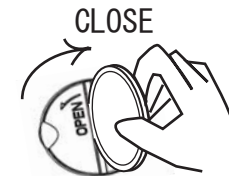
open battery cover



install new battery,  
+ side up



press battery into position



close battery cover

## Replacing the projection lamp

The lamp hour timer in the Service Info menu counts the number of hours the lamp has been in use. Twenty hours before the specified end of the lamp's life, the message "Change lamp" briefly appears on the projected screen.

**NOTE:** You can order new lamp housings from [www.infocus.com](http://www.infocus.com) (in select areas), your retailer or your dealer. Only genuine InFocus lamps are tested for use in this projector. InFocus is not liable for the performance, safety or certification of any other lamps. The use of other lamps violates the projector warranty and voids all certification marks on this projector.

- 1 Turn off the projector and unplug the power cable.
- 2 Wait 45 minutes to allow the projector to cool thoroughly.
- 3 Loosen the lamp cover screw on the right side of the projector (marked by the arrow) then slide and lift the lamp cover off.

### WARNINGS:

- To avoid burns, allow the projector to cool for at least 45 minutes before you replace the lamp.
- Only genuine InFocus lamps are tested with this projector. Use of other lamps may cause electrical shock and fire.
- To prevent eye injury if the projector is ceiling mounted, wear protective eyewear before opening lamp door. A warning sticker is included with the user documentation. Place this sticker on the lamp door if the projector is mounted on the ceiling.
- Do not drop the lamp module. The glass may shatter and cause injury. Do not touch the glass lamp screen. Fingerprints can obscure projection sharpness.
- Be extremely careful when removing the lamp housing. In the unlikely event that the bulb ruptures, small glass fragments may be generated. The lamp housing is designed to contain these fragments, but use caution when removing the lamp housing. Before replacing the lamp, clean

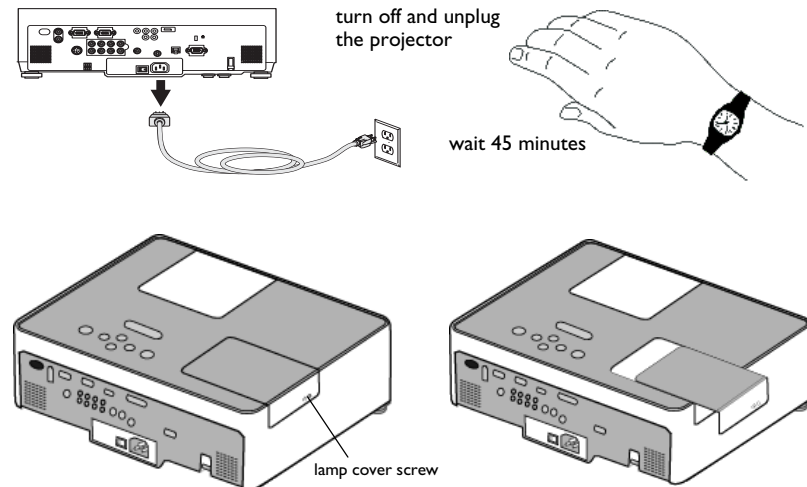
the lamp compartment and dispose of cleaning materials. Wash hands after lamp replacement.

Hg – Lamp contains mercury. Manage in accordance with local disposal laws. See [www.lamprecycle.org](http://www.lamprecycle.org).

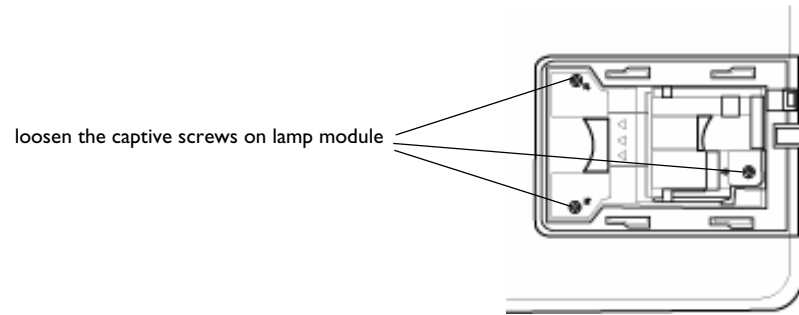


Service Info	
Previous	
Model Name	IN5106
Firmware	1.00
Lamp Hours	0
Total Lamp Hours	0
Lamp Resets	0
Filter Hours	0

lamp hours



4 Loosen the three captive screws (marked by the arrows) on the lamp module. When replacing the lamp, never touch any screws without the arrow mark.

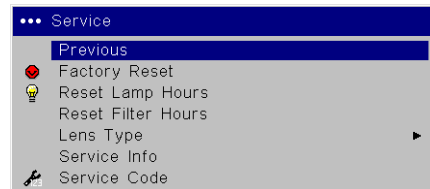
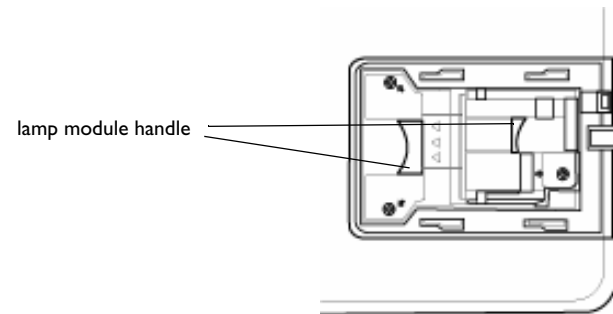


5 Carefully remove the lamp module by grasping and lifting the handle. Dispose of the lamp in an environmentally proper manner.

6 Install the new lamp module, making sure that it is properly seated, and tighten the three captive screws.

7 Replace the cover over the lamp module by sliding it back into place and tightening the screw.

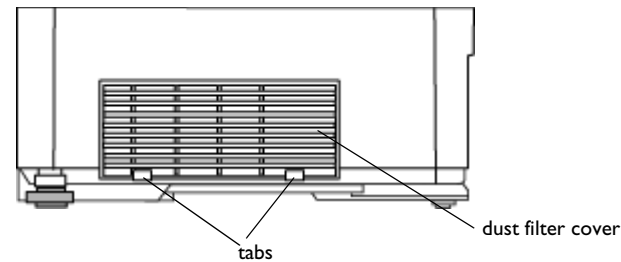
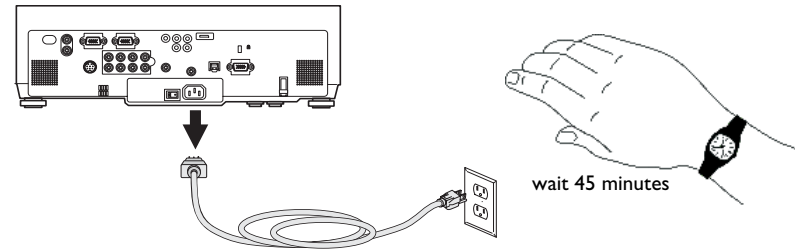
8 Plug in the power cable, press the power switch then press the **Power** button to turn the projector back on. Reset the lamp hour timer by navigating to the **Settings>Service** menu and selecting **Reset Lamp Hours**.



reset lamp hours in Service menu

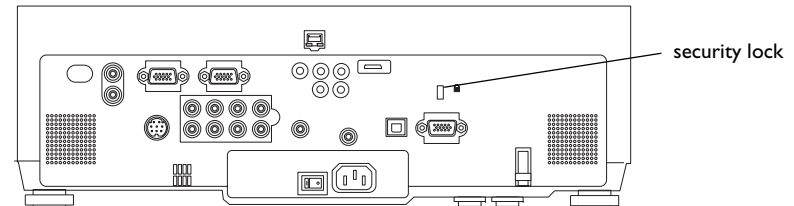
## Cleaning the dust filter

- 1 Turn off the projector and unplug the power cable.
- 2 Wait 45 minutes to allow the projector to cool thoroughly.  
**WARNING:** To avoid burns, allow the projector to cool for at least 45 minutes before you clean or replace the dust filter.
- 3 Remove the dust filter cover on the side of the projector by pressing up on the two tabs at the cover's bottom.
- 4 Pull the tab on the center of the black dust filter bracket and lift it off.
- 5 Clean the filter, cover, and vent using a vacuum set on low power. Replace the filter if it is damaged or too dirty to clean.
- 6 Replace the dust filter and the bracket on the cover, then replace the dust filter cover.
- 7 Reset the filter hour timer by navigating to the **Settings>Service** menu and selecting **Reset Filter Hours**.



## Using the security lock

The projector has a security lock for use with a cable lock system. See the Accessories catalog that came with the projector, or visit our website, for ordering information. Refer to the information that came with the lock for instructions on how to use it.



## Appendix

### Projected image size

**NOTE:** Visit the Service section of our website for interactive image size calculators for the standard and optional lenses.

**Table 2: Projection sizes: Standard lens (1.5 - 1.8:1 throw ratio)**

Distance (feet/m)	Minimum Image		Maximum Image	
	Diagonal Image (feet/m)	Image Width (feet/m)	Diagonal Image (feet/m)	Image Width (feet/m)
Min Distance 3/0.9	2.1/0.66	1.7/0.53	2.6/0.79	2.1/0.63
5/1.5	3.5/1.1	2.8/0.86	4.2/1.3	3.4/1.0
10/3.0	7.0/2.1	5.6	1.7	8.3/2.5
15/4.6	10.4/3.2	8.3/2.5	12.5/3.8	10/3
20/6.1	13.8/4.2	11/3.4	16.6/5.1	13.3/4
25/7.6	17.2/7.6	13.8/4.2	20.7/6.3	16.6/5
Max Distance 30/9.1	20.6/6.3	16.5/5	24.8/7.6	19.8/6.1

The image offset range for the standard lens is 9:1 (90%) to 1:1 (50%).

### Optional lenses

**WARNING:** When replacing the lens, turn off the projector and pull out the power cord from the receptacle. Loosen the screws marked with a triangle to remove the lens.

**NOTE:** You can order optional lenses from [www.infocus.com](http://www.infocus.com) (in select areas), your retailer or your dealer.

**Table 3: Projection sizes: Short Fixed lens (0.8:1 throw ratio)**

Screen Size (inch/m)	Projection Distance (inch/m)
	Minimum
40/1	24/0.6
60/1.5	35/0.9
70/1.8	43/1.1
100/2.5	63/1.6
120/3	75/1.9
150/3.8	94/2.4
200/5.1	130/3.3
250/6.4	161/4.1
300/7.6	193/4.9
350/8.9	224/5.7



**Table 4: Projection sizes: Short Zoom lens (1.2 -2.0:1 throw ratio range)**

Screen Size (inch/m)	Projection Distance (inch/m)	
	Minimum	Maximum
40/1	39/1.0	63/1.6
60/1.5	59/1.5	94/2.4
70/1.8	67/1.7	110/2.8
100/2.5	98/2.5	157/4.0
120/3	118/3.0	189/4.8
150/3.8	150/3.8	240/6.1
200/5.1	197/5.0	319/8.1
250/6.4	248/6.3	402/10.2
300/7.6	299/7.6	480/12.2
350/8.9	350/8.9	559/14.2

**Table 5: Projection sizes: Long Throw lens (1.9 - 3.9:1 throw ratio range)**

Screen Size (inch/m)	Projection Distance (inch/m)	
	Minimum	Maximum
40/1	59/1.5	122/3.1
60/1.5	94/2.4	185/4.7
70/1.8	110/2.8	217/5.5
100/2.5	157/4.0	311/7.9
120/3	189/4.8	374/9.5
150/3.8	236/6.0	467/11.9
200/5.1	319/8.1	630/16.0
250/6.4	402/12.2	787/23.9
300/7.6	480/16.3	945/20.0
400/10.2	642/20.4	1260/40.1
500/12.7	803/20.4	1579/40.1

**Table 6: Projection sizes: Ultra Long Throw lens (3.9 - 7.4:1 throw ratio range)**

<b>Screen Size (inch/m)</b>	<b>Projection Distance (inch/m)</b>	
	<b>Minimum</b>	<b>Maximum</b>
40/1	122/3.1	236/6.0
60/1.5	189/4.8	354/9.0
70/1.8	220/5.6	513/10.5
100/2.5	315/8.0	594/15.1
120/3	382/9.7	717/18.2
150/3.8	476/12.1	898/22.8
200/5.1	638/16.2	1197/30.4
250/6.4	799/24.4	1496/45.6
300/7.6	961/28.5	1795/53.3
400/10.2	1283/32.6	2398/60.9
500/12.7	1602/40.7	3000/76.2

## RS-232 commands

### Communication Configuration

Visit our website for additional RS-232 settings and information.

To control this projector via RS-232, connect a null modem cable and set the control system serial port settings to match the following communication configuration:

RS-232 Port Settings	
Setting	Value
Bits per second	19,200
Data bits	8
Parity	None
Stop bits	1
Flow control	None
Emulation	VT100

### Command Format

All commands consist of 3 alpha characters followed by a request, all enclosed in parentheses. The request can be a read request (indicated by a "?") or a write request (indicated by 1 to 4 ASCII digits).

A read request example:

(AAA?) where  
(starts the command  
AAA denotes the command  
? denotes the read request  
) ends the command

A read command returns the range and the current setting, for example:

Read Command Examples		
Function	Command	Response
Brightness	(BRT?)	(96-160,128)
Volume	(VOL?)	(0-32, 0)
Lamp Hours	(LMP?)	(0-32766, 42)

A write request example:

(AAA####) where  
(starts the command  
AAA denotes the command  
#### denotes the value to be written  
(leading zeros not necessary)  
) ends the command

Some commands have ranges, while others are absolute. If a number greater than the maximum range is received, it is automatically set to the maximum number for that function. If a command is received that is not understood, a "?" is returned. With absolute settings, "0" is off, 1-9999 is on. The one exception is the Power command, where 0 is off and 1 is on.

To assure the projector can process a command, wait 3 seconds before entering the next command.

Write Command Examples		
Function	Command	Response
Brightness	(BRT140)	Sets the brightness to 140
Power	(PWRO)	Turns power off
Power	(PWRI)	Turns power on

### Error Conditions

Not all commands are supported for all projectors. If an unsupported command is issued, the command will be ignored. If a command is received that is not understood, a '?' character will be returned indicating the command was not understood.

### Limitations

The projector cannot respond to commands coming in at a high-rate. Therefore, a delay must occur between commands to ensure that the command gets properly executed. To assure the projector can process a command, wait 3 seconds before entering the next command.

The Step column refers to increasing or decreasing the menu bar position since the On-screen Display is not an exact match of values. For example, Step 2 changes the data by 2 through the CLI (Command Line Interface). The menu bar is up (or down) by 1.

Function	Command	Min	Max	Default	Step
About (Source Info) 0: n/a 1: enable	ABT at W	0	1	n/a	
Active Iris 0: Off 1: Presentation 2: Film	IRI at RW	0	2	1	
Aspect Ratio 0: Native 1: 16:9 2: 4:3	ARZ at RW	0	2	2	
Auto Image 0: n/a 1: enable	AIM at W	0	1	n/a	
Auto Power 0: disable 1: enable	APO at RW	0	1	0	
Auto Source 0: disable 1: enable	ASC at RW	0	1	1	
Blank 0: off 1: on	BLK at RW	0	1	0	

Blank Screen 0: black 1: blue 2: white	BSC at RW	0	2	1	
Blue Gain	BCG at RW	64	192	128	1
Brightness	BRT at RW	96	160	128	1
Ceiling 0: disable 1: enable	CEL at RW	0	1	0	
Color	CLR at RW	96	160	128	1
Color Space 0: Auto 1: RGB 2: REC709 3: REC601 4: RGB Video	CSM at RW	0	4	0	
Color Temp 0: 9300K 1: 6500K 2: 7200K 3: User	TMP at RW	0	3	2 (computer 2,3) 0 (other)	
Contrast	CON at RW	96	160	128	1

Custom Key (Effect) 0: blank 1: mute 2: aspect ratio 3: source 4: auto image 5: freeze 6: zoom 7: Source Info 8: Service Info 15: AV Mute	EFK at RW	0	15	7	
Display Messages 0: disable 1: enable	DMG at RW	0	1	1	
Factory Reset 0: not reset 1: reset	RST at W	0	1	n/a	
Freeze 0: disable 1: enable	FRZ at RW	0	1	0	
Green Gain	GCG at RW	64	192	128	1
Horizontal Keystone	DKH at RW	38	218	128	1
HDMI Noise Cancel	HNC at RW	0	1	1	
Horizontal Position	HPS at RW	def:- 128	def:+1 28	auto	1
Internal Sound Enable 0: disable 1: enable	INT at RW	0	1	1	

IR Receiver front 0: disable 1: enable	IRF at RW	0	1	1	
IR Receiver rear 0: disable 1: enable	IRR at RW	0	1	1	
IR Receiver top 0: disable 1: enable	IRT at RW	0	1	0	
Language 0 = English 1 = French 2 = German 3 = Italian 5 = Korean 6 = Norwegian 7 = Portuguese 8 = Russian 9 = Simplified Chinese 10 = Spanish 11 = Traditional Chinese 12 = Swedish 13 = Dutch 14 = Polish 15 = Turkish 16 = Danish 17 = Finnish	LAN at RW	0	17	0	
Lamp Hours	LMP at R	0	32766	0	1

Lamp Lit 0: not lit 1: lit	LML at R	0	1		
Reset Lamp Hours 0: not reset 1: reset	LRT at W	0	1	n/a	
Number of Lamp Resets	LMR at R	0	32766	0	
Lamp Total On Time (All Bulbs)	LMT at R	0	21474 83646	0	
Time In Hours Last Bulb1 Lasted	LBI at R	0	32766	0	
Time In Hours Last Bulb2 Lasted	LB2 at R	0	32766	0	
Time In Hours Last Bulb3 Lasted	LB3 at R	0	32766	0	
Low Power 0: disable 1: enable	LPE at RW	0	1	0	
Magnify	MAG at RW	0	48	0	1
Magnify Enable 0: disable 1: enable	MGE at RW	0	1	0	
Magnify Position Horizontal	MPH at RW	0	64	32	1
Magnify Position Vertical	MPV at RW	0	64	32	1

Menu 0: disable 1: enable	MNU at RW	0	1	0	
Menu Navigation 0: up 1: down 4: select	NAV at W	0	4	n/a	
Mute 0: disable 1: enable	MTE at RW	0	1	0	
Network Restart 0: not restart 1: restart	NTR at W	0	1	n/a	
NND (PC Screen Saver Off) 0: disable 1: enable	NND at RW	0	1	1	
Overscan 0: disable 1: enable	OVS at RW	0	1	0	
Phase	MSS at RW	0	31	0	1
Power 0: disable 1: enable	PWR at RW	0	1	0	
Power Save 0: disable 1: enable	PSV at RW	0	1	0	

Power-up Source 0: computer 1 1: computer 2 2: computer 3 3: video 1 4: video 2 5: video 3	DSC at RW	0	5	1	
Presets 0: user 1 1: user 2 2: user 3 3: Presets Off 5: presentation 7: video 10: bright 11: whiteboard	PST at RW	0	11	computer 2,3:5 computer 1, video:7	
Rear 0: disable 1: enable	REA at RW	0	1	0	
Red Gain	RCG at RW	64	192	128	1
Reset Filter Hours 0: not reset 1: reset	FRT at W	0	1	n/a	
Save User Presets 1 0: not saved 1: saved	US1 at W	0	1	n/a	
Save User Presets 2 0: not saved 1: saved	US2 at W	0	1	n/a	

Save User Presets 3 0: not saved 1: saved	US3 at W	0	1	n/a	
Screen Save 0: 5 minutes 1: 10 minutes 2: 15 minutes 3: 20 minutes 4: 25 minutes 5: 30 minutes	SSV at RW	0	5	0	
Sharpness 5 = Sharpest 6 = Sharper 7 = Standard 8 = Softer 9 = Softest	SHP at RW	5	9	7 (computer and video 1) 6 (video 2 and 3)	
Source 0: computer 1 1: computer 2 2: computer 3 3: video 1 4: video 2 5: video 3	SRC at RW	0	5	0	
Source 1 0: computer 1 1: computer 2 2: computer 3 3: video 1 4: video 2 5: video 3	SR1 at RW Source 2:SR2 Source 3:SR3 Source 4:SR4	0	5	0 1 3 4	

Audio for Source 0 0: audio 1 1: audio 2 2: audio 3 3: audio 4 4: HDMI Internal 5: mute	SA0 at RW	0	5	4	
Audio for Source 1 0: audio 1 1: audio 2 2: audio 3 3: audio 4 5: mute	SA1 at RW Source 2:SA2 Source 3:SA3 Source 4:SA4 Source 5:SA5	0	5	0 1 3 2 2	
Startup Logo 0: blank screen 1: default 2: captured	DSU at RW	0	2	1	
Sync on Green 0: Sunc on G off 1: Auto	SOG at RW	0	1	1	
Tint	TNT at RW	96	160	128	1
Tracking	MTS at RW	def: -384	def: +384	auto	1
Unit Total Time On	ONL at R	0	21474 83646	0	
Vertical Keystone	DKC at RW	38	218	128	1



Vertical Position	VPS at RW	if def< 128: 0 else: def - 128	def +128	auto	1
Video Standard 0: Auto 1: NTSC 2: PAL 3: SECAM	VSU at RW	0	3	0	
Volume	VOL at RW	0	32	16	1

## INDEX

### Numerics

1024x768 resolution 5

### A

Aspect Ratio 33

audio 24

Audio In connector 8, 12

Auto Image 33

Auto Power 31

Autosource 31

### B

Blank 33

BNC 8

Brightness 11

### C

Capture Position 32

Capture Start 32

cleaning the dust filter 38

cleaning the lens 35

clock batteries 35

Color 14

colors are incorrect 19

component cable connector 12

computer connections

    optional 8

    required 8

computer image

    displaying 10

    optimize 25

connector panel 6

contacting service 21

Contrast 11, 14

custom logo startup screen 32

customer service contact information 21

### D

Default gateway 33

DHCP 33

Display Messages 31

displaying

    computer image 10

    video images 13

dust filter, cleaning 38

### E

elevator foot 11, 13

### F

Factory Reset 34

filter, resetting hours 34

focus 11, 14

Freeze 33

fuzzy image 17

### H

HDMI 6

HDTV sources 12

### I

image

    display computer 10

    display video 13

    size 7

image does not fit screen 18

image not centered 21

image not sharp 18

image not square 18

image reversed 19

image size matrix 39

image upside down 19

IP Address 33

IR Receivers 31

### L

lamp hours, resetting 37

lamp replacement 36

lamp won't turn on 20

Language 34

laptop

    connecting 8

    external video port 10

- lens, cleaning 35
- Low Power 31
- M**
- Magnify 33
- Main menu 27
- menu system 27
- Monitor connector 9
- Mute 33
- N**
- Network 33
- Network connector 9
- Network Info 33
- no computer image 17
- no startup screen 16
- O**
- only startup screen appears 16
- Overscan 30
- P**
- PC Screen Saver Off 31
- Picture menu 28
- power cable 8, 12
- Power Save 32
- Power-up Source 31
- presentation features 25
- projection distance 7
- projector
  - connector panel 6
  - customizing 26
  - height 11, 13
  - positioning 7, 11, 13
  - setting up 7
  - shutdown 15
  - troubleshooting problems 15
- R**
- Rear 31
- remote control 23
- replacing the clock batteries 35
- replacing the lamp 36
- Reset Filter Hours 34

- resetting lamp hours 37
- RS-232
  - cable 9
  - connecting 6
- S**
- screen saver, turning off 31
- security lock 38
- serial connection 6, 9
- Service 34
- Service Code 34
- Service Info 34
- Settings menu 31
- shutting down projector 15
- Source 33
- Source troubleshooting 16
- Sources 31
- Subnet mask 33
- S-video connector 12
- T**
- Tint 14
- troubleshooting 15, 16
- V**
- video connections
  - optional 12
  - standard 12
- Video connector 12
- video image
  - displaying 13
- video images
  - optimizing 26
- Video Standard 30
- volume adjustment 14
- W**
- warranty 21
- X**
- XGA 5
- Z**
- zoom 11, 14