

Canon

MULTIMEDIA PROJECTOR

WUX10

User's Manual



Table of Contents

Safety Instructions

Before Use

Projecting an Image

Useful Functions Available During a Presentation

Setting Up Functions from Menus

Connecting the Projector to Network

Appendix

Index

AISYS
Aspectual Illumination
System

HDMI™
HIGH DEFINITION MULTIMEDIA INTERFACE

ENG

ProSelecta

View :: Compare :: Select - www.ProSelecta.com

Features of WUX10 Multimedia Projector

Thank you for purchasing a Canon projector.

The WUX10 Multimedia Projector (hereinafter referred to as "the projector") is a high-performance projector that is capable of projecting a high-resolution computer screen and high-quality digital image on a large screen.

Major Features

Smooth and Beautiful Imaging Capability

Incorporation of AISYS, Canon's unique optical engine, and the world's first 0.71-inch WUXGA (1920 x 1200 resolution) LCOS (Liquid Crystal On Silicon) panel achieves a high brightness, high contrast, and smooth and beautiful lattice-free image.

Native WUXGA Resolution

Native WUXGA resolution ensures projection of a high-quality image in a wider projection area with a high degree of resolution.

High-powered 1.5X Zoom Lens

1.5X zoom aspheric lens can project a 100-inch image when placed 3 m (9.8') to 4.4 m (14.4') away. (P31)

"Auto Setup Function" for Making Setup a Breeze

The focus and keystone distortion are automatically adjusted for quick and easy setup of projector. (P45)

Equipped with HDMI Input Terminal

Connecting the projector to AV equipment via HDMI terminal allows you to project high quality digital images. (P38)

Network Connectivity

The network connectivity allows you to control and monitor the projector from your computer via the network. (P103-P114)

"Off and Go" Feature

It can be unplugged and packed away immediately. (P62)

* Wait until the cooling fan stops before putting the projector in the carrying bag.

User-Friendly On-Screen Menu

Settings are organized by four tabs. You can easily find settings for each function. (P70-P101)

Compact and Easy-to-use Wireless Remote Control

It comes with a wireless remote control which allows you to control all functions of this projector. (P24)

User's Manual (this document)

This is a User's Manual for the WUX10 Multimedia Projector. This manual provides detailed information on how to use the projector. Read this manual thoroughly to make the most of your projector and ensure safety.

Important Information and Quick Start Guide

First read document. It provides information about projector safety, cautions, quick start guide*, cleaning and replacing the air filter and lamp replacement.

* This guide shows an outline flowchart of the steps to start and stop the projector, as well as the functions available for projecting images.

Symbols of Button Operations

The projector can be operated using buttons on the remote control or the top control of the projector. The remote control allows you to operate all functions of the projector. In this document, the buttons operation is shown as below.

Top control button operation

Remote control button operation

Adjusting the Image Size

Use the **ZOOM** button to adjust the size of the proj. Change the projector installation position if your de adjust it with the zoom function. (P31)

1 Press the **ZOOM** button to pop up a window sho

Remote control

Top control

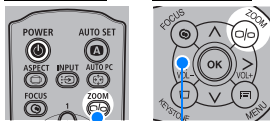

Indicate the buttons to be pressed

Symbols Used in This Manual

Meanings of the following symbols used in this manual are as follows:



A precaution about operation or restriction is given here.

COPYRIGHT NOTICE

Please note that enlarging or reducing the size of an image for commercial purposes or public presentation may infringe on the legally protected copyright or the copyright holder of the original material.

About Trademarks

- Microsoft, Windows, Windows Vista and Internet Explorer are registered trademarks or trademarks of Microsoft Corporation in the United States and/or other countries.
- Macintosh and Mac are registered trademarks of Apple Computer, Inc., registered in the United States and/or other countries.
- HDMI, HDMI logo, and High Definition Multimedia Interface are registered trademarks or trademarks of HDMI Licensing, LLC.

Quick Reference Guide

This Quick Reference Guide will help you find functions that make full use of the projector, are useful in producing an attractive presentation, and so on.

Connecting the Projector

Connecting to the Computer (P35 – P37)
Connecting to AV Equipment (P38 – P41)

Projecting an Image

Starting Projection (P42 – P44)
Selecting an Input Signal (P47 – P48)

Adjusting Image

Adjusting the Image Size and Focus (P51, P52)
Adjusting Keystone Distortion (P53)
Adjusting Aspect Ratio (P55 – P60)
Eliminating Flickers from Computer Screen or
Adjusting Positional Shift (P76)

Adjusting Colors and Image Quality

Projecting an Image on a Greenboard (P80)
Selecting an Image Mode Suitable for the
Projecting Image (P85)
Making Fine Color Adjustments (P88)
Removing Noise (P89)

Producing a Presentation

Blackened Out an Image Temporarily (P64)
Freezing the Picture (P64)
Adjusting the Volume (P65)
Muting the Sound (P65)
Zooming an Image (P66)
Showing the Elapsed Time (P67)

Ceiling Mounted Projection or Projecting
from behind Screen (P81)

Changing Remote Control Channel
(P94)

Resetting Projector Setting

Resetting Password (P97)
Initializing a Network Setting (P100)
Resetting to the Default Setting (P100)

Miscellaneous Functions

Reducing the Lamp Brightness (P91)
Using the Power Saving Mode (P92)
Turning on the Projector by Connecting the
Power Cord (P93)
Disabling the Beep During the Operation (P93)
Disabling Buttons (P94)
Hiding Guide Messages (P95)
Turning Off the Projector LED Lamps (P96)
Setting a Password (P97)

Table of Contents

Features of WUX10 Multimedia Projector	2
Quick Reference Guide	4
Safety Instructions	10
Safety Precautions	11
■ READ AND KEEP THIS OWNER'S MANUAL FOR LATER USE	12
AC Power Cord Requirement	14
Federal Communication Commission Notice	15
Canadian Radio Interference Regulations	15
Precautions on Handling the Batteries in the Remote Controller	16
Lamp Handling Precautions	16
Carrying/Transporting the Projector	17
Installation Precautions	17
Before Use	19
Supplied Accessories	20
■ Installing the Lens Cap	20
■ Putting the Projector in the Carrying Bag	21
Part Names	22
Main Unit of Projector	22
■ Front Side	22
■ Rear Side	22
■ Bottom Side	23
Remote Control	24
Top Control	26
Input Terminals	27
Preparing the Remote Control	28
■ Installing Remote Control Batteries	28
■ Remote Control Operating Range	28
Projecting an Image	29
Steps for Setting Up the Projector and Projecting an Image	30
Setting Up the Projector	31
■ Placing in Front of the Screen	31
■ Placing on a Level Place	32
■ When Pointing the Projector Up	33
Connecting the Projector	34
Connectable Equipment and Input Terminals	34
Connecting the Projector to the Computer	35
■ Connecting to RGB Monitor Output Terminal (analog connection)	35
■ Connecting to DVI Monitor Output Terminal (digital connection)	36
■ Outputting Audio to Speakers	37
Connecting to AV Equipment	38
■ Connecting to Digital Video Output Terminal (digital connection)	38
■ Connecting to Analog Video Output Terminal (analog connection)	39
■ Outputting Audio to Speakers	41

Starting Projection	42
■ When the Language Selection Screen Appears.....	43
■ When the Password Input Screen Appears.....	44
■ When "No signal" Appears.....	44
■ When Notebook Computer Screen Does Not Appear.....	44
■ Adjusting Image.....	44
Changing Notebook Computer Screen Output.....	44
■ Turning On External Monitor Output.....	44
Setting Up the Screen Automatically	45
Auto Setup.....	45
■ Performing the Auto Setup.....	46
Selecting an Input Signal (INPUT)	47
■ Types of Input Signals	47
■ Selecting an Input Signal.....	48
Adjusting Image	49
Setting the Display Resolution of the Computer.....	49
■ Windows Vista.....	49
■ Windows XP.....	49
■ Macintosh OSX.....	49
AUTO PC	50
■ Performing the Auto PC Function.....	50
Adjusting the Image Size.....	51
Adjusting the Focus.....	52
■ Auto focusing.....	52
■ Manual focusing.....	52
Adjusting Keystone Distortion	53
■ Auto adjustment.....	53
■ Manual adjustment.....	53
■ Resetting the Keystone Adjustment.....	54
Selecting Screen Aspect and Aspect.....	55
Selecting Screen Aspect.....	55
■ Moving Image with 16:9 D. Image Shift.....	57
■ Moving Image with 4:3 D. Image Shift.....	58
■ Resetting the Image Shift.....	58
Selecting Aspect Ratio	59
■ Types of Aspect Ratios.....	59
■ How to Select an Aspect Ratio	60
Selecting an Image Mode	61
■ Image modes.....	61
■ How to Select an Image Mode.....	61
Turning Off the Projector	62
Useful Functions Available During a Presentation	63
Useful Functions Available During a Presentation.....	64
Blackened Out an Image Temporarily.....	64
Freezing the Picture	64

Adjusting the Volume	65
Muting the Sound	65
Zooming an Image	66
Showing the Elapsed Time	67
Setting Functions from Menus.....	69
How to Use Menus	70
■ Menu Configuration	70
■ Basic Operation of Menu.....	71
Setting Display Status	73
Selecting an Image Projection Mode	73
Selecting an Input Signal Type (ANALOG PC).....	74
Selecting an Input Signal Type (VIDEO)	74
Selecting an Input Signal Type (COMPONENT)	75
Adjusting Input Signal (ANALOG PC) – Total Dots	75
Adjusting Input Signal (ANALOG PC) – Tracking	76
Adjust Input Signal (ANALOG PC) – Horizontal position	76
Adjust Input Signal (ANALOG PC) – Vertical position	77
Adjust Input Signal (ANALOG PC) – Horizontal pixels	77
Adjust Input Signal (ANALOG PC) – Vertical pixels	78
Selecting HDMI Input Level	78
Select HDMI Over Scan.....	79
Performing Progressive Processing	79
Selecting a Menu Position	80
Correcting the Screen Color	80
Reversing projection	81
Capturing a Logo	82
Selecting the User Logo Display Position	82
No Signal Screen.....	83
Screen When Blank	83
Selecting a Logo at Startup	84
Selecting Aspect Ratio of Screen	84
Setting the Image Quality	85
Selecting an Image Quality	85
Adjusting the Brightness	86
Adjusting the Contrast	86
Adjusting the Sharpness	87
Making a Gamma Correction	87
Making Color Adjustment (HDMI/DIGITAL PC/ANALOG PC)	88
Making Color Adjustment (COMPONENT/VIDEO).....	88
Making Advanced Adjustment (Noise reduction).....	89
Making Advanced Adjustment (Dynamic gamma)	89
Making Advanced Adjustment (Auto fleshtone).....	90

Adjusting Fine Color Adjustment (6-axis color adjust).....	90
Reducing the Lamp Brightness	91
Resetting the Image Settings	91
Setting Various Function.....	92
Setting Auto Setup Function.....	92
Selecting the Power Management Mode	92
Skip the POWER Button Operation.....	93
Enabling/Disabling the Beep	93
Prohibiting the Projector Operation	94
Setting up the Remote Control Channel	94
Selecting a Display Language.....	95
Showing/hiding the Guide Screen	95
Turning on/off LED Illumination.....	96
Extending the Menu Display Time.....	96
Setting a Password	97
Registering a Password	97
Resetting the Lamp Counter	98
■ About the Display of the Lamp Counter.....	98
Turning On/Off the Network Function.....	99
Initializing network settings.....	100
Resetting to the Default Setting.....	100
Checking the Information of the Projector	101
Connecting the Projector to Network.....	103
Setting an IP Address	104
■ Setting IP Address of the Computer	104
■ Resetting the IP Address Setting of the Computer	105
Setting Network.....	106
■ Displaying the Network Configuration Screen	106
■ Setting the Network.....	107
■ Resetting the Network Setting.....	112
■ Error Notification Message.....	113
■ Projector Control	114
Appendix.....	115
Troubleshooting.....	116
WARNING Lamp Flash Patterns.....	116
Symptoms and Solutions.....	117
■ You cannot turn on the projector.	117
■ You cannot project an image from the projector.	117
■ You cannot hear sound.....	118
■ The projected image is blur.	119
■ You cannot project an image appropriately.	119
■ The projector is forced to be turned off.	119
■ You cannot operate the remote control.	120

Maintenance	121
Cleaning the Projector	121
Cleaning and Replacing the Air Filter	122
■ Cleaning the Air Filter	122
■ Replacing the Air Filter	122
Replacing the Lamp	123
■ About the Replacing Lamp.....	123
■ Replacing the Lamp	124
Relationship between Aspect and Screen Aspect	125
When Projecting an Image from a Computer	125
When Projecting an Image from Image Software	127
Supported Computer Signal Types	128
Relationship between Screen Size and Projecting Distance	129
Glossary	130
Specifications	134
■ Projector	134
■ Remote Control.....	134
■ External View	135
■ ANALOG PC-2/COMPONENT IN terminal.....	135
■ Service Port (CONTROL).....	136
Index	137
Menu Configuration	142





Safety Instructions

Before operating this projector, read this manual thoroughly in order to operate the projector properly.

This projector offers many convenient features and functions. Operating the projector properly enables you to manage those features and maintain it in good condition for a long period.

Improper operation may result in not only reducing the product-life, but also malfunctions, fire hazards, or other accidents.

If your projector is not operating correctly, read this manual again, check operations and cable connections, and try the solutions shown in the "Troubleshooting" section at the end of this booklet. If the problem still persists, contact the service center or the dealer where you purchased the projector.

	CAUTION RISK OF ELECTRIC SHOCK DO NOT OPEN	
CAUTION: TO REDUCE THE RISK OF ELECTRIC SHOCK, DO NOT REMOVE COVER (OR BACK). THERE ARE NO USER-SERVICEABLE PARTS INSIDE EXCEPT LAMPS. REFER SERVICING TO QUALIFIED SERVICE PERSONNEL.		
	THIS SYMBOL INDICATES THAT DANGEROUS VOLTAGE CONSTITUTING A RISK OF ELECTRIC SHOCK IS PRESENT WITHIN THIS UNIT.	
	THIS SYMBOL INDICATES THAT THERE ARE IMPORTANT OPERATING AND MAINTENANCE INSTRUCTIONS FOR THIS UNIT IN THE OWNER'S MANUAL.	

CAUTION Not for use in a computer room as defined in the Standard for the Protection of Electronic Computer/Data Processing Equipment, ANSI/NFPA 75.
--

Safety Precautions

WARNING: TO REDUCE THE RISK OF FIRE OR ELECTRIC SHOCK, DO NOT EXPOSE THIS APPLIANCE TO RAIN OR MOISTURE.

- This projector projects intense light from the projection lens. Do not stare directly into the lens if possible, as doing so may result in eye damage. Be especially careful that children do not stare directly into the beam.
- Install the projector in an appropriate position. Installing the projector in an inappropriate position may result in a fire hazard.
- Allow for appropriate space above, beside and behind of the projector cabinet for allowing air circulation and cooling of the projector. Minimum clearances must be maintained. If the projector is to be built into a compartment or similarly space, the minimum distances must be maintained. Do not cover the ventilation slot on the projector. Heat build-up can reduce the service life of your projector, and can also be dangerous.

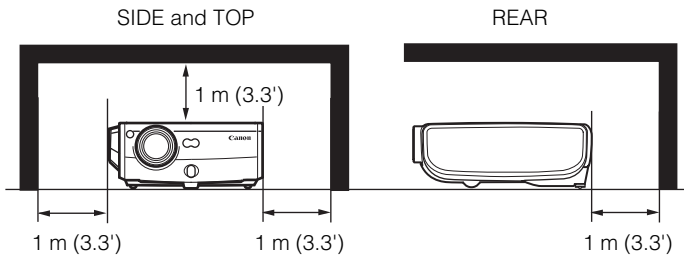

- Do not put any flammable objects or spray cans near the projector, as the hot air exhausted from the ventilation holes may result in an explosion.
- If the projector is not to be used for an extended period of time, unplug it from the power outlet.

■ **READ AND KEEP THIS OWNER'S MANUAL FOR LATER USE.**

All the safety and operating instructions should be read before beginning to operate the product.

Read all of the instructions given here and retain them for later use. Unplug this projector from the AC power supply before cleaning. Do not use liquid or aerosol cleaners on the projector. Use a damp cloth for cleaning.

Follow all warnings and instructions marked on the projector.

For added protection of the projector during a lightning storm, or when it is left unattended or unused for long periods of time, unplug it from the wall outlet. This will prevent damage due to lightning and power surges.

Do not expose this unit to rain or use near water... for example, in a wet basement, near a swimming pool, etc...

Do not use attachments not recommended by the manufacturer as they may result in hazards.

Do not place this projector on an unstable cart, stand, or table. The projector may fall, causing serious injury to a child or adult, and serious damage to the projector. Use only with a cart or stand recommended by the manufacturer, or sold with the projector. Wall or shelf mounting should be carried out in accordance with the manufacturer's directions, and should use a mounting kit approved by the manufacturers.

An appliance and cart combination should be moved with care.

Sudden stops, excessive force, and uneven surfaces may cause the appliance and cart combination to overturn.



Slots and openings in the back and bottom of the cabinet are provided for ventilation, to insure reliable operation of the equipment and to protect it from overheating.

The openings should never be covered with cloth or other materials, and the bottom opening should not be blocked by placing the projector on a bed, sofa, rug, or other similar surface. This projector should never be placed near or over a radiator or heat register.

This projector should not be placed in a built-in installation such as a book case unless proper ventilation is provided.

Never push objects of any kind into this projector through cabinet slots as they may touch dangerous voltage points or short out parts that could result in a fire or electric shock. Never spill liquid of any kind onto the projector.

Do not install the projector near the ventilation duct of air-conditioning equipment.

This projector should be operated using only the type of power source indicated on the marking label. If you are not sure of the type of power supplied, consult your authorized dealer or local power company.

Do not overload wall outlets and extension cords as this can result in fire or electric shock. Do not allow anything to rest on the power cord. Do not locate this projector where the cord may be damaged by people walking on it.

Do not attempt to service this projector yourself as opening or removing covers may expose you to dangerous voltages or other hazards. Refer all servicing to qualified service personnel.

Unplug this projector from the wall outlet and refer servicing to qualified service personnel under the following conditions:

- a. When the power cord or plug is damaged or frayed.
- b. If liquid has been spilled into the projector.
- c. If the projector has been exposed to rain or water.
- d. If the projector does not operate normally after following the operating instructions. Adjust only those controls that are covered in the operating instructions as improper adjustment of other controls may result in damage and will often require extensive work by a qualified technician to restore the projector to normal operating condition.
- e. If the projector has been dropped or the cabinet has been damaged.
- f. When the projector exhibits a distinct change in performance-this indicates a need for servicing.

When replacement parts are required, be sure the service technician uses replacement parts specified by the manufacturer that have the same characteristics as the original parts. Unauthorized substitutions may result in fire, electric shock, or injury.

Upon completion of any service or repairs to this projector, ask the service technician to perform routine safety checks to determine that the projector is in safe operating condition.

AC Power Cord Requirement

The AC Power Cord supplied with this projector meets the requirements for use in the country you purchased it.

AC Power Cord for the United States and Canada:

The AC Power Cord used in the United States and Canada is listed by the Underwriters Laboratories (UL) and certified by the Canadian Standard Association (CSA).

The AC Power Cord has a grounding-type AC line plug. This is a safety feature to ensure the plug fits into the power outlet. Do not try to tamper with this safety feature. Should you be unable to insert the plug into the outlet, contact your electrician.

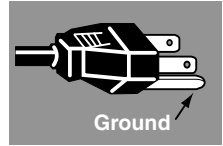

THE SOCKET-OUTLET SHOULD BE INSTALLED NEAR THE EQUIPMENT AND EASILY ACCESSIBLE.

NOTE FOR CUSTOMERS IN THE US

(Hg) LAMP(S) INSIDE THIS PRODUCT CONTAIN MERCURY AND MUST BE RECYCLED OR DISPOSED OF ACCORDING TO LOCAL, STATE OR FEDERAL LAWS.



European Union (and EEA) only.

These symbols indicate that this product is not to be disposed of with your household waste, according to the WEEE Directive (2002/96/EC), the Battery Directive (2006/66/EC) and/or your national laws implementing those Directives. If a chemical symbol is printed beneath the symbol shown above, in accordance with the Battery Directive, this indicates that a heavy metal (Hg = Mercury, Cd = Cadmium, Pb = Lead) is present in this battery or accumulator at a concentration above an applicable threshold specified in the Battery Directive. This product should be handed over to a designated collection point, e.g., on an authorized one-for-one basis when you buy a new similar product or to an authorized collection site for recycling waste electrical and electronic equipment (EEE) and batteries and accumulators. Improper handling of this type of waste could have a possible impact on the environment and human health due to potentially hazardous substances that are generally associated with EEE. Your cooperation in the correct disposal of this product will contribute to the effective usage of natural resources. For more information about the recycling of this product, please contact your local city office, waste authority, approved scheme or your household waste disposal service or visit www.canon-europe.com/environment.



(EEA: Norway, Iceland and Liechtenstein)

Federal Communication Commission Notice

Multimedia Projector, Model: WUX10

This device complies with Part 15 of the FCC Rules. Operation is subject to the following two conditions:

- (1) This device may not cause harmful interference, and
- (2) this device must accept any interference received, including interference that may cause undesired operation.

Note: This equipment has been tested and found to comply with the limits for a Class B digital device, pursuant to Part 15 of the FCC Rules. These limits are designed to provide reasonable protection against harmful interference in a residential installation. This equipment generates, uses and can radiate radio frequency energy and, if not installed and used in accordance with the instructions, may cause harmful interference to radio communications. However, there is no guarantee that interference will not occur in a particular installation. If this equipment does cause harmful interference to radio or television reception, which can be determined by turning the equipment off and on, the user is encouraged to try to correct the interference by one or more of the following measures:

- Reorient or relocate the receiving antenna.
- Increase the separation between the equipment and receiver.
- Connect the equipment into an outlet on a circuit different from that to which the receiver is connected.
- Consult the dealer or an experienced radio/TV technician for help.

The cable with a ferrite core provided with the projector must be used with this equipment in order to comply with Class B limits in Subpart B of Part 15 of the FCC rules.

Use of a shielded cable is required to comply with class B limits in Subpart B of Part 15 of FCC Rules.

Do not make any changes or modifications to the equipment unless otherwise specified in the instructions. If such changes or modifications should be made, you could be required to stop operation of the equipment.

Canon U.S.A., Inc.

One Canon Plaza, Lake Success, NY 11042, U.S.A.

Tel No. (516) 328-5600

Canadian Radio Interference Regulations

This Class B digital apparatus complies with Canadian ICES-003.

Precautions on Handling the Batteries in the Remote Controller



Observe the following precautions when handling the batteries. Failure to do so may cause explosion, heat generation, fire, or leakage of the battery fluid.

- Do not heat or disassemble the batteries, or throw them into fire.
- Do not attempt to recharge the batteries.



Observe the following precautions when handling the batteries. Failure to do so may cause explosion, heat generation, fire or leakage of the battery fluid.

- Remove the batteries when they have been exhausted or not in use for an extended period of time.
- Be sure to replace both batteries at the same time. Do not mix batteries of different types.
- Insert batteries correctly according to the "+" and "-" markings.
- If a fluid from a battery leaks and comes in contact with your skin, rinse the affected skin thoroughly as soon as possible.

Lamp Handling Precautions

This projector uses a high-pressure mercury lamp which must be handled carefully and correctly as mentioned below.

The mercury lamp has the following characteristics.

- A lamp may explode with a loud sound or burn out due to a shock, scratch, or use beyond its expiry date.
- The lamp life may differ from lamp to lamp and according to the usage environment. There is no guarantee that all lamps will last for the same period of time. Some lamps may fail in a shorter period of time than other similar lamps.
- A lamp gradually becomes darker over time.



If a Lamp Explodes

- If a lamp explodes, gas or dust may come out of the exhaust vent. Open windows and doors for ventilation.
- The gas contains toxic mercury. Always keep your face away from the exhaust vent when the projector is operating to avoid inhaling mercury vapors or to prevent it from getting in your eyes or mouth.
- If you inhale the gas or the shards of the broken lamp contact your eyes or mouth, consult a doctor immediately.
- If a lamp explodes, its shards may scatter inside the projector. Ask the Canon service representative to clean and check the inside of the projector and replace the lamp.



If the projector indicates that the lamp should be replaced (i.e., the LAMP REPLACE indicator lights up twice),

- The chances of an explosion increase. Replace the lamp with a new one immediately if such is the case.



Disposal of Waste Lamp

- Dispose of the projector's mercury lamp according to local regulations just like the fluorescent lamps.

Carrying/Transporting the Projector



- This projector is a precision machine. Do not subject the projector to strong shocks or vibrations or turn it down.
- Install the lens cap to protect the lens and put the projector in the carrying bag to protect it from dust and scratches on the surface of it when you carry the projector. For details, see [P21](#).
- Wait until the cooling fan stops before putting the projector in the carrying bag. Do not put the projector in the carrying bag until the cooling fan stops rotating. The projector may be damaged due to the heat.
- Replace the adjustable foot before putting the projector in the carrying bag. The projector may be damaged if you put it in the bag without replacing the adjustable foot.
- The carrying bag is not designed to protect the projector from external shocks. When carrying the projector with it put in the carrying bag, do not give a shock to it, drop it, or place anything on it. The projector may be damaged or malfunctioned.
- Do not transport the projector through a courier or transport service with the carrying bag. Put the projector in an impact-resistant transport case if such is the case.

Installation Precautions



The area around the exhaust vent and the cabinet above the exhaust vent become hot when the projector is operating.

- Do not touch these areas, or you may get burnt. In particular, keep children away from these areas. Do not put anything that may deform or discolor due to heat on the projector.

Hot air is exhausted from the exhaust vent. Observe the following:

- Do not put any metallic object on the projector. It may become hot, resulting in accident or injury.
- Do not put anything such as a plant pot near the exhaust vent.
- Do not put anything near the exhaust vent that may deform or deteriorate due to heat.
- Do not seat anyone near the exhaust vent.





When placing the projector on a castered stand or table, be sure to lock the casters.

- Failure to do so may cause the projector to move or topple, resulting in an injury.

Position the projector in a horizontal position.

- Install the projector correctly. Incorrect installation may cause troubles and accidents.
- Do not tilt the projector more than 20 degrees above and below the horizontal.
- When you want to use your projector pointing up or down, make sure to place the projector straight up or down.
- Do not install the projector vertically.

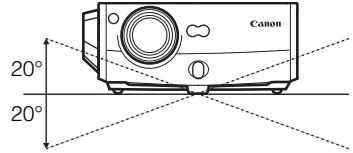

Do Not Use in the Following Environments

- Do not place the projector on an unstable or slanted surface. The projector may fall causing a personal injury.
- Do not place it in an oily, smoky, or damp location (e.g., near a cooking table or a humidifier). It may cause a fire or an electric shock.
- Do not place it near an exhaust outlet of air-conditioning equipment.

Do not install the projector in a humid or dusty location or a position where there is a lot of oily or cigarette smoke. Optical parts such as a lens and mirror may be stained, resulting in poor picture quality.

If the projector is carried from a cold place to a warm place or the room temperature is raised rapidly, condensation may form on the lens and mirror due to the moisture in the atmosphere, resulting in a blurred picture. Wait until condensation evaporates and normal picture is shown.

Do not use the projector in a place subject to either very high or very low temperatures. Doing so may cause malfunction. The ranges of the operating and storage temperatures are as shown below:

Operating temperature: +5°C to +35°C (Humidity: 85% or below)

Storage temperature: -10°C to +60°C (Humidity: 90% or below)

Using the Projector at 2300 Meters or More Above Sea Level

- If you use the projector at 2300 meters or more above sea level, the special configuration is required to cool down the projector properly. Contact your dealer.

Before Use

Table of Contents

Safety Instructions

Before Use

Projecting an Image

Useful Functions Available During a Presentation

Setting Up Functions from Menus

Connecting the Projector to Network

Appendix

Index

Supplied Accessories

Check whether the following accessories are supplied with the projector.

- Remote control
- Batteries (type AAA, two) for remote control
- Computer connection cable (DVI/Mini D-sub, 15-pin) (1.8 m/5.9')

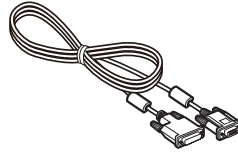
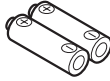
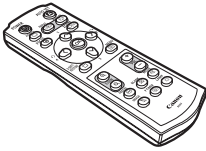

- Power cord (2 m/6.6')

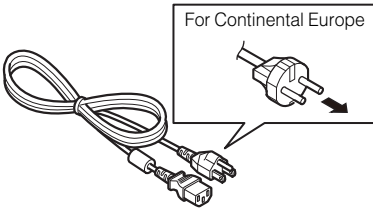

For the U.S.A and Canada

- Component cable (RCA/Mini D-sub, 15-pin) (0.4 m/1.3')

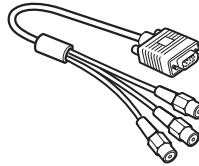

- Lens cap



- Lens cap strap

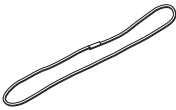

- Carrying bag

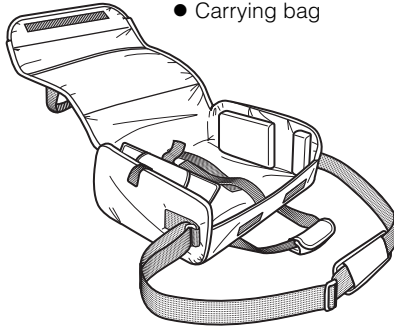

- User's Manual (CD-ROM)
- Warranty card
- Important Information and Quick Start Guide

■ Installing the Lens Cap

As shown in the illustration on the right, put the lens cap strap through the hole on the lens cap, and then through the lens cap strap insertion hole at the bottom of the projector.

- When the projector is not in use, attach the lens cap to protect the lens.

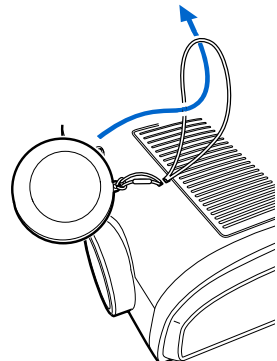

■ Putting the Projector in the Carrying Bag

Store the projector and the accessories in the carrying bag as shown in the illustration below.

The carrying bag is intended to protect the surfaces of the projector from dust or scratches, and is not designed to protect the projector from external shocks.

- User's Manual (CD-ROM)
- Important Information and Quick Start Guide

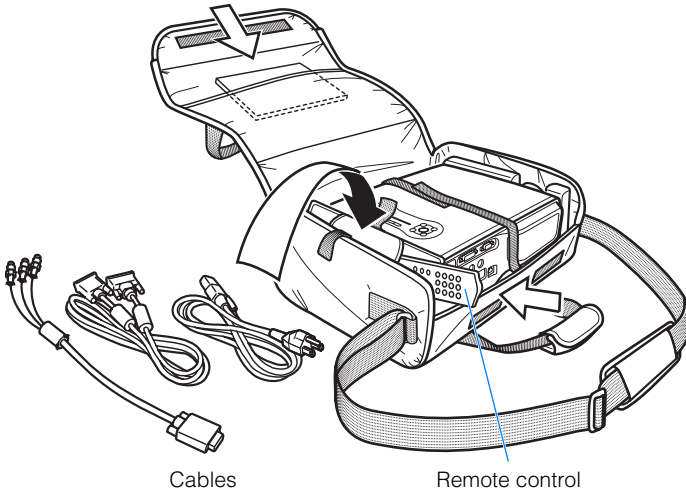

Cables

Remote control



- Wait until the cooling fan stops before putting the projector in the carrying bag. Do not put the projector in the carrying bag until the cooling fan stops rotating. The projector may be damaged due to the heat.
- Attach the lens cap to the lens to protect it and put the projector in the carrying bag. Replace the adjustable foot to prevent the damage on the projector.
- When carrying the projector with it put in the carrying bag, do not give a shock to it, drop it, or place anything on it. The projector may be damaged or malfunctioned.

Part Names

Main Unit of Projector

■Front Side

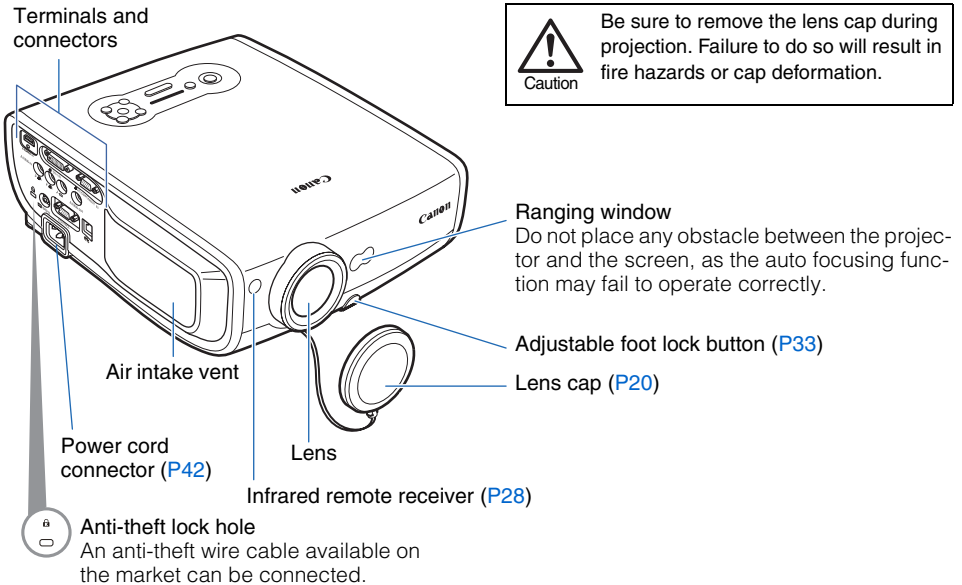

■Rear Side

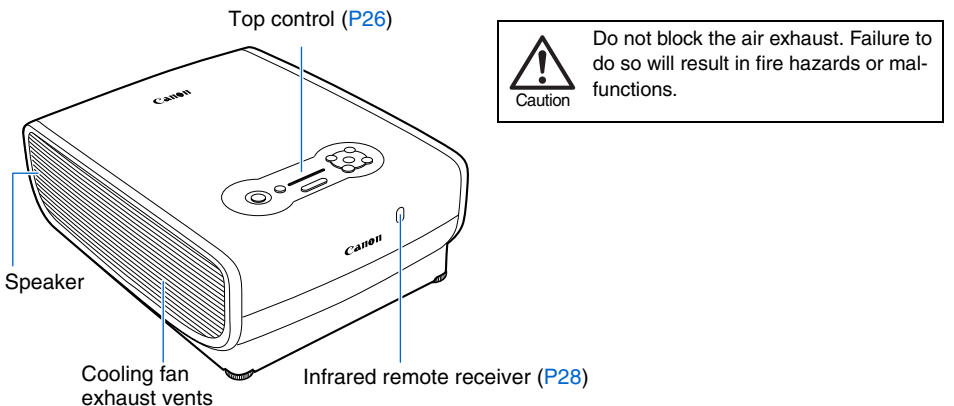

Bottom Side



Do not block the air intake. Failure to do so will result in fire hazards or malfunctions.

Caution

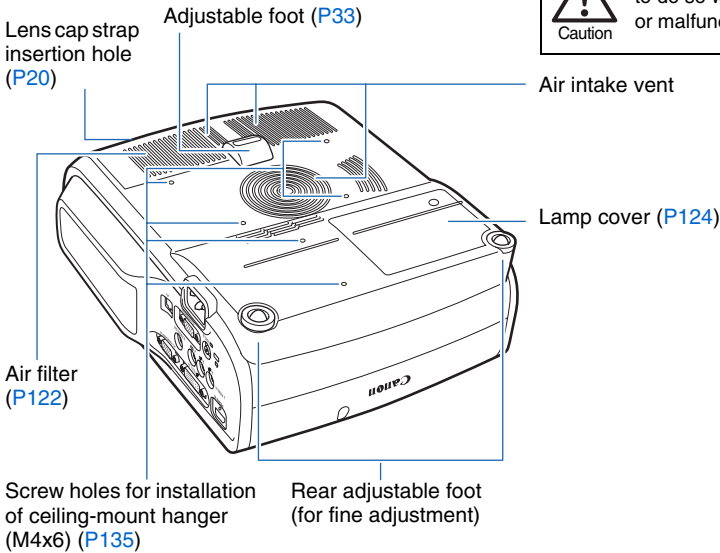

Mounting the Projector on the Ceiling

You can mount the projector on the ceiling. You need an optional ceiling-mount hanger (part number: RS-CL07) and an optional ceiling-mount pipe (part number: RS-CL08 or RS-CL09) when appropriate. Contact the dealer where you purchased the projector for more detailed information.



- Make sure to use the optional ceiling-mount hanger.
- You should never install the ceiling-mount hanger by yourself.
- If you mount the projector on the ceiling, you have to invert the projected image by selecting [Image flip H/V] from the menu. (P81)

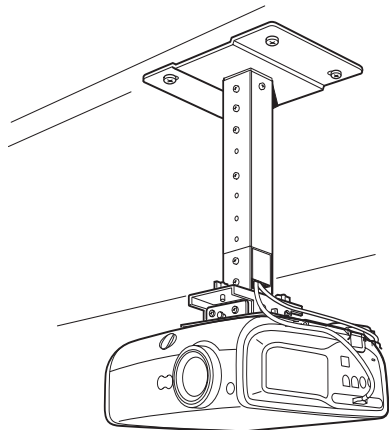

Remote Control

The projector can be operated using buttons on the remote control or the top control on the main unit.

The remote control allows you to operate all functions of the projector.

POWER button (P42, P62)

Turns the projector on or off.

ASPECT button (P60)

Toggles between the modes for aspect ratio.

FOCUS button (P52)

Adjusts focusing.

[^] [v]: For rough adjustment.

[<] [>]: For fine adjustment.

Press **FOCUS** and then **AUTO SET** to adjust the focusing automatically.

D.SHIFT/KEystone button (P53)

Corrects keystone distortion.

[^] [v]: For keystone adjustment.

Press **D.SHIFT/KEystone** and then **AUTO SET** to adjust the keystone automatically.

- Moves the image up, down, left, and right when [16:9 D. image shift] or [4:3 D. image shift] is selected. (P57, P58)
- [^], [v], [<], [>]: Moves an image to the desired position.

D. ZOOM button (P66)

Zooms the image in or out digitally.

[+]: Zooms the image in (up to 12x).

[-]: Zooms the image out (1x minimum).

[^] [v] [<] [>]: Moves an image to the desired position.

FREEZE button (P64)

Freezes the projected image.

IMAGE button (P61)

Switches among image modes (image qualities).

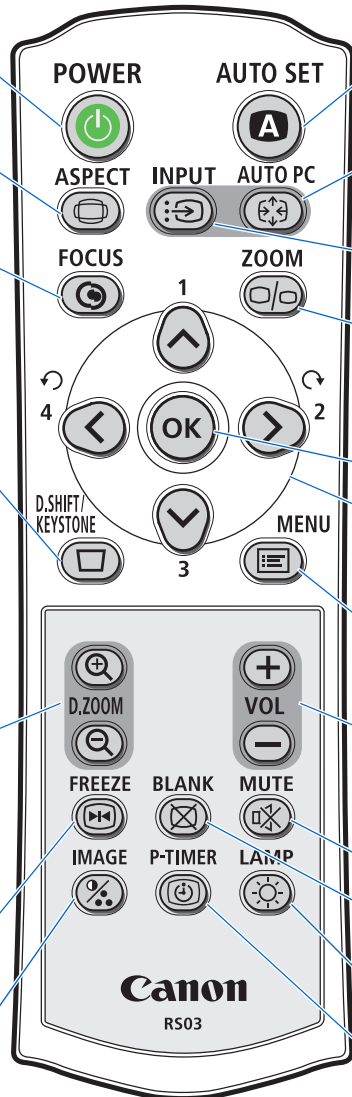

AUTO SET button (P46)

Performs input signal settings, auto adjustment on focusing, keystone distortion, screen color correction, and so on.

INPUT button (P48)

Switches among input signals.

ZOOM button (P51)

Adjusts the image size.

[^] [v]: For rough adjustment.

Pointer buttons (P71)

Selects the upper, lower, left or right item in the menu.

MENU button (P70)

Displays a menu on the screen.

VOL button (P65)

Adjusts the sound volume.

[+]: Increases the volume.

[-]: Decreases the volume.

BLANK button (P64)

Toggles between display/non-display of image.

P-TIMER button (P67)

Displays the time elapsed since this button was pressed.

AUTO PC button (P50)

Adjusts tracking and so on automatically in accordance with signal from a computer when ANALOG PC-1 or ANALOG PC-2 is selected.

OK button (P72)

Determines the item selected from the menu.

MUTE button (P65)

Mutes the sound.

LAMP button (P91)

Switches the lamp mode between Standard and Silent.

Top Control

POWER button/lamp (P42, P62)

Turns the projector on or off.
 Green: The projector is on.
 Flashing green: The projector is being turned on.
 Red: The projector can be turned on.
 Flashing red: The projector is being turned off (the lamp is being cooled).

LED illumination lamp (P96)

Indicates the projector status with LEDs.
 Blinking from the left: The projector is being turned on.
 Blinking from the right: The projector is being turned off.
 Middle LED flashing slowly: The image is being blanked out.
 Left and right LEDs flashing slowly: The image is freezing.

FOCUS button (P52)

Adjusts focusing.
 [^] [v]: For rough adjustment.
 [<] [>]: For fine adjustment.
 Press **FOCUS** and then **AUTO SET** to adjust the focusing automatically.

ZOOM button (P51)

Adjusts the image size.
 [^] [v]: For rough adjustment.
 [<] [>]: For fine adjustment.

Pointer/VOL button (P71, P65)

Adjusts the sound volume.
 [<]: Decreases the volume.
 [>]: Increases the volume.
 Selects the upper, lower, left or right item in the menu.

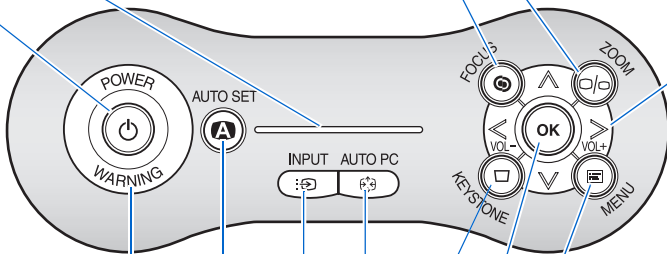

WARNING lamp (P116)

Flashes red when a problem has been detected on the projector.

AUTO SET button (P46)

Performs input signal settings, auto adjustment on focusing, keystone distortion, screen color correction, and so on.

INPUT button (P48)

Switches among input signals.

AUTO PC button (P50)

Adjusts tracking and so on automatically in accordance with signal from a computer when ANALOG PC-1 or ANALOG PC-2 is selected.

MENU button (P70)

Displays a menu on the screen.

OK button (P72)

Determines the item selected from the menu.

KEYSTONE button

Corrects keystone distortion. (P53)
 [^] [v]: For keystone adjustment.
 Press **D.SHIFT/KEYSTONE** and then **AUTO SET** to adjust the keystone automatically.

- Moves the image up, down, left, and right when [16:9 D. image shift] or [4:3 D. image shift] is selected. (P57, P58)
- [^], [v], [<], [>]: Moves an image to the desired position.

Input Terminals

- (1) **HDMI IN Terminal (P38)**
 Receives a digital content image signal (HDMI).
 Carries both video and audio signals across a single cable.
- (2) **ANALOG PC-1/DVI-I IN Input Terminal (P1 DVI-I IN) (P35, P36)**
 Connects an external monitor output from a computer.
 Receives an analog PC (ANALOG PC-1) or a digital signal (DIGITAL PC).
- (3) **ANALOG PC-2/COMPONENT IN Terminal (P2/COMPONENT IN) (P35, P40)**
 Receives an analog PC signal (ANALOG PC-2).
 Use a supplied component cable to receive a component image signal (COMPONENT).

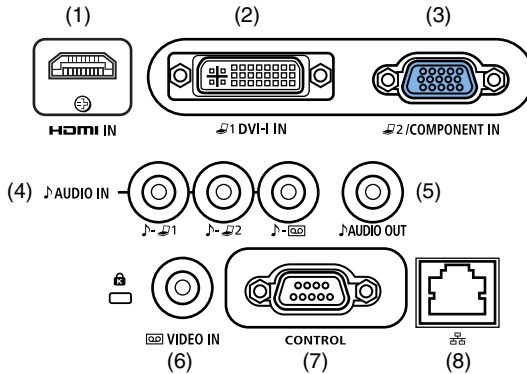

- (4) **AUDIO IN Terminal (P35, P36, P39, P40)**
 The audio input terminals corresponding to 3 image input systems other than HDMI-IN. Each terminal receives the audio signal corresponding to "DIGITAL PC/ANALOG PC-1", "ANALOG PC-2/COMPONENT", and "VIDEO" from the left. The internal speaker outputs the audio signal for the selected image signal.
- (5) **AUDIO OUT Terminal (P37, P41)**
 The audio output terminal to output an audio to external AV equipment. It outputs the audio signal corresponding to the projected image signal.
- (6) **VIDEO IN Terminal (P39)**
 Receives a composite video signal from AV equipment.
- (7) **Service port (CONTROL)**
 Exclusively used by the service personnel (it is not used normally).
- (8) **LAN port (P104)**
 Connects a LAN cable.
 Used to connect the projector to the network.

Preparing the Remote Control

■ Installing Remote Control Batteries

1 Open the battery compartment lid.
Slide the lid with it pressed down.

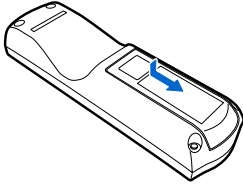

2 Insert batteries.
Insert new two AAA-size batteries in the compartment with the + and – poles positioned correctly.

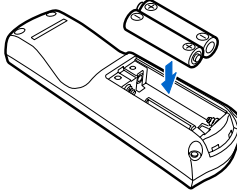

3 Replace the compartment lid.

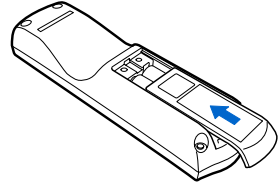

- If buttons on the remote control are inoperative when you attempt to operate the projector, replace the batteries with new ones.
- It is recommended to check the batteries before a presentation.

■ Remote Control Operating Range

Point the remote control to the infrared remote receiver on the front or rear of the projector whenever pressing any button.

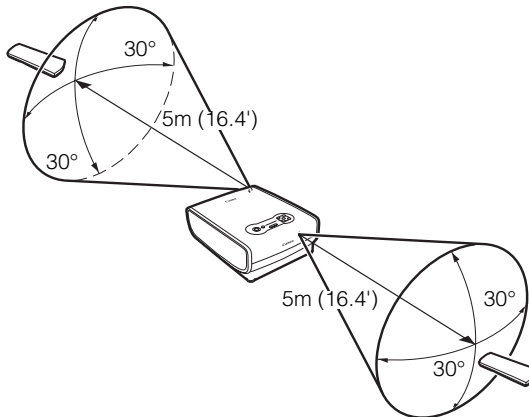

- Use the remote control within a distance of approximately 5 m (16.4') from the projector.
- Use the remote control within an angle of 30° in any direction from directly in front of the infrared remote receiver.
- The remote control may be inoperative if there is an obstacle between the remote control and main unit or the infrared remote receiver on the main unit is exposed to direct sunlight or strong light of lighting equipment.
- When you use two projectors at the same time, you can change the channel settings to prevent the two remote controls from interfering with each other. (P94)

Projecting an Image

Table of Contents

Safety Instructions

Before Use

Projecting an Image

Useful Functions Available During a Presentation

Setting Up Functions from Menus

Connecting the Projector to Network

Appendix

Index

Steps for Setting Up the Projector and Projecting an Image

Connecting the Projector to Equipment (P34)



Turning on the Power (P42)



Do you want to project an image from a notebook computer?

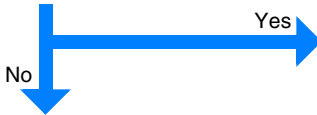

For a notebook computer, turn on the monitor output (P44) and then go to Auto Setup.

Performing the Auto Setup (P45)

Image projected properly?

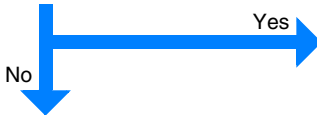

Projection is complete.

Selecting an Input Signal (P47)

Image projected properly?



Projection is complete.

Adjusting the Image (P49)

Do the following adjustments.

- Setting the Display Resolution of the Computer (P49)
- Adjusting misaligned images or flickering of the screen using the Auto PC (P50)
- Adjusting the Image Size (P51)
- Adjusting the Focus (P52)
- Adjusting keystone Distortion (P53)

Making Fine Adjustments

- Selecting an Aspect Ratio of Projected Image (Screen aspect) and a Screen Mode (Aspect) (P55, P59)
- Selecting an Image Mode (P61)

Setting Up the Projector

■ Placing in Front of the Screen

Place the projector in front of the screen.



- Be sure to place the projector parallel to the screen to ensure distortion-free projections.
- The screen must not be exposed to direct sunlight or light from lighting equipment. In a bright room, it is recommended to limit ambient lighting in order to improve the image quality.

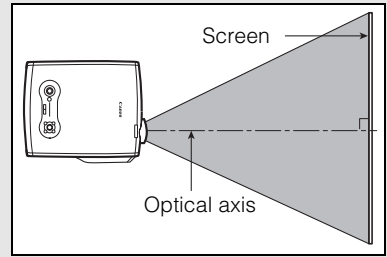

Projected Image Size

The projected image size is determined by the distance between the projector and the screen (projection distance) as well as the zoom (P51). For the relationship between the screen size and the projection distance, see also the table listed in "Relationship between Screen Size and Projecting Distance" on page 129.

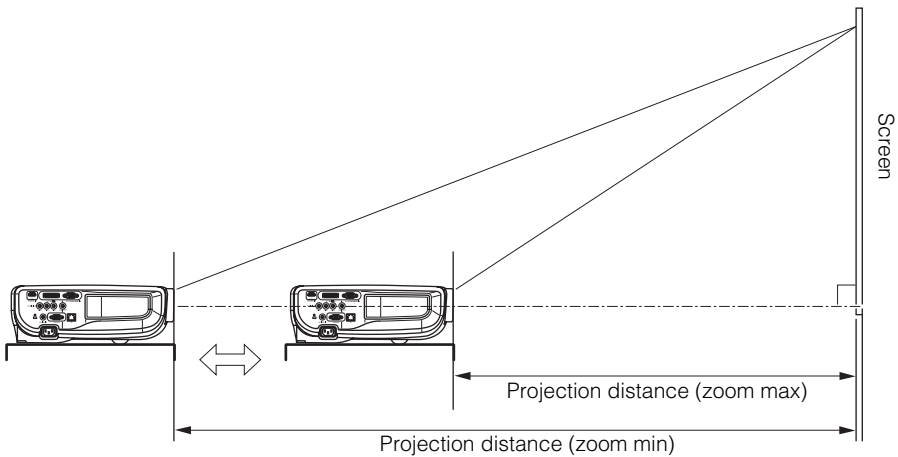

Screen size	40	60	80	100	150	180	200	250	300
Width (cm)	86	129	172	215	323	388	431	538	646
Height (cm)	54	81	108	135	202	242	269	337	404
Projection distance (zoom max)	1.2 m (3.9')	1.8 m (5.9')	2.4 m (7.9')	3.0 m (9.8')	4.5 m (14.8')	5.4 m (17.7')	6.1 m (20.0')	7.6 m (24.9')	9.1 m (29.9')
Projection distance (zoom min)	1.8 m (5.9')	2.6 m (8.5')	3.5 m (11.5')	4.4 m (14.4')	6.7 m (22.0')	8.0 m (26.3')	8.9 m (29.2')	-	-

■ Placing on a Level Place

Be sure to keep the projector as horizontal as possible.

If you need to point the projector up (for example, when the screen is placed on a higher position), follow the instruction given in "When Pointing the Projector Up" on the following page.

- Adjust the tilt of the projecting image using the rear adjustable foot.

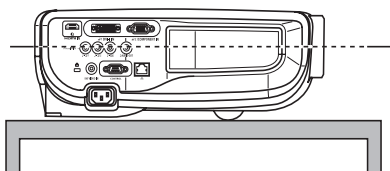
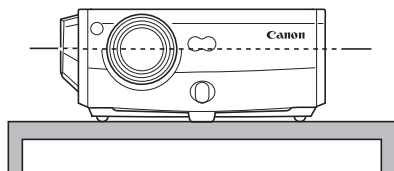

Make sure that the installation position is free from any obstacle that may block the exhaust vent on the right side of the projector and the air intake vent on the bottom of the projector.

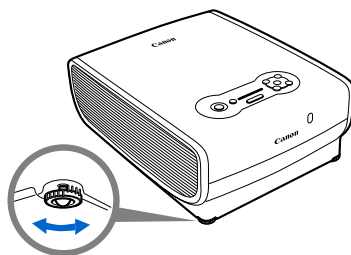

Ceiling Mounting or Rear Projection

You can mount the projector on the ceiling (Ceiling mounted) with it turned up side down or place it behind the screen (Rear) if you use a translucent screen. For ceiling mounting or rear projection, you have to invert the projected image. (P81)

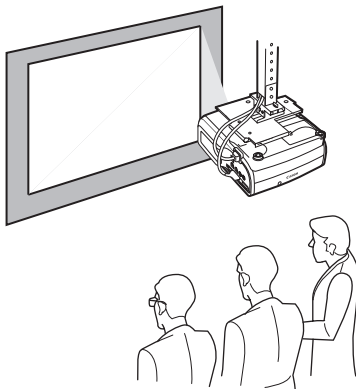

Ceiling Mounting

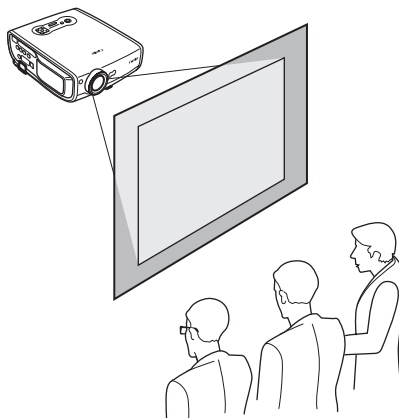

Rear Projection

■ When Pointing the Projector Up

When the screen is placed on a higher position, point the projector up using the adjustable foot.

You can point it up as far as 10 degrees.

The keystone distortion of the projecting image can be corrected with the auto keystone (P45) or by using the keystone distortion adjust function (P53).

- 1 Lift the front side of the projector and push the adjusting foot lock button to extend the adjustable foot.
- 2 Raise the image to the desired height angle, then release the button to lock the foot in place.

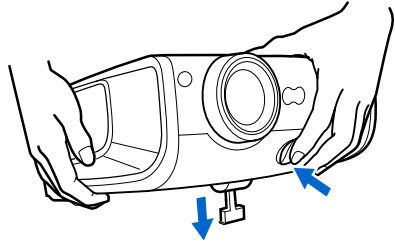

If Keystone Distortion is Too Large

If the keystone distortion is too large to adjust, adjust the projector height by, for example, placing it on a pedestal.

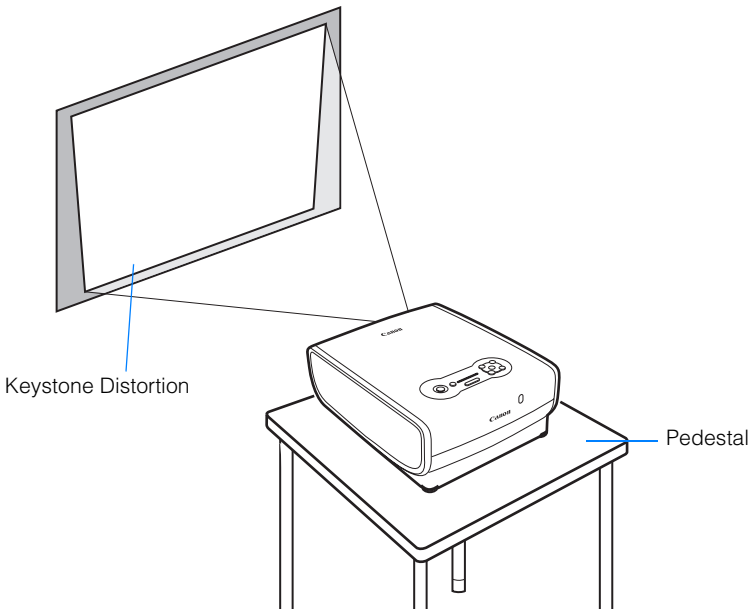





Connecting the Projector





Connectable Equipment and Input Terminals

DIGITAL PC
ANALOG PC-1 Use this name to select the appropriate image.  : Video signal or data flow

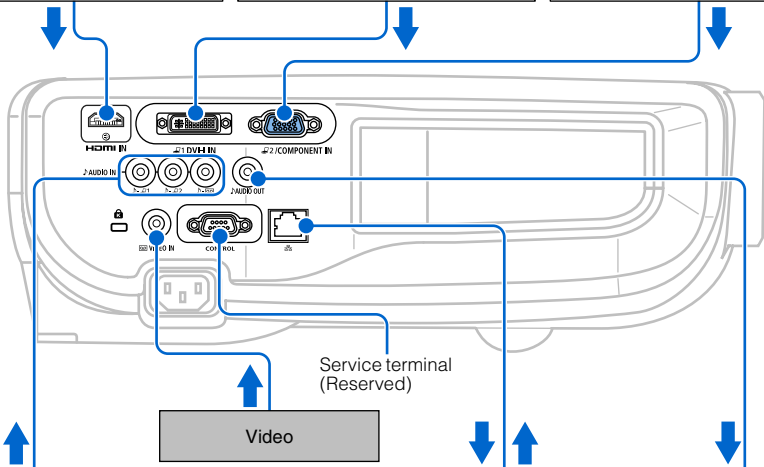
DVI-I IN terminal The name of the terminal to which to connect equipment. (Pxxx) : indicates the page(s) to refer to.

HDMI	DIGITAL PC ANALOG PC-1	ANALOG PC-2 COMPONENT
HDMI IN terminal	ANALOG PC-1/ DVI-I IN terminal	ANALOG PC-2/ COMPONENT IN terminal
AV equipment (P38)  Digital video camera* (P38)  HDMI IN terminal can be used to connect only AV equipment.	Computer (P35, P36)  DVI-I IN terminal can be used to connect only computer.	Computer (P35, P36)  AV equipment (P40) 



AUDIO IN terminal	VIDEO IN terminal	LAN terminal	AUDIO OUT terminal
Audio signal for each image input 1 DIGITAL PC (P35, P36) 2 COMPONENT (P35, P36, P40) VIDEO (P39)	AV equipment (P39)  Digital video camera* (P39)  Digital camera* (P39) 	Network (P104) 	Amplified speaker (P37, P41) 

* Connect to the playback mode.

Connecting the Projector to the Computer

Connect the projector to the computer.

Before connecting the cables, turn off both the projector and computer.

The digital connection (P36) is recommended when projecting a WUXGA or UXGA image in high quality.

■ Connecting to RGB Monitor Output Terminal (analog connection)

Supplied computer connection cable (Input signal type: [ANALOG PC-1] - P47)

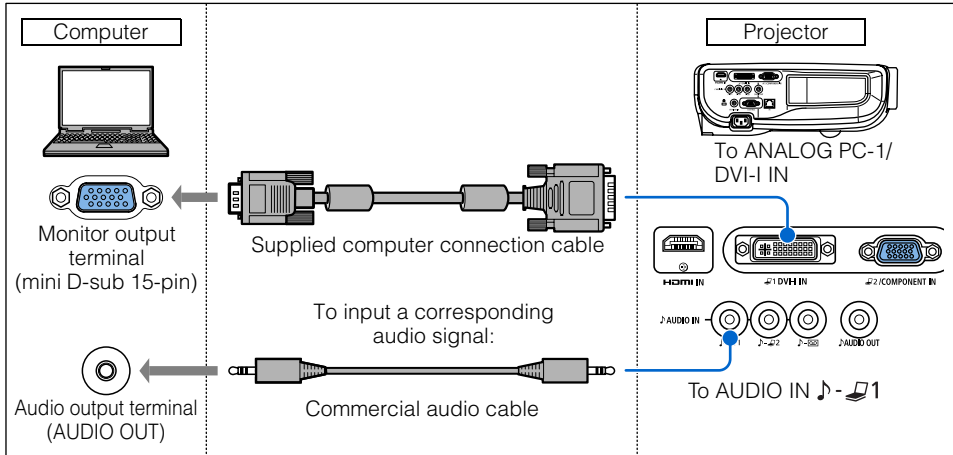

VGA cable (Input signal type: [ANALOG PC-2] - P47)

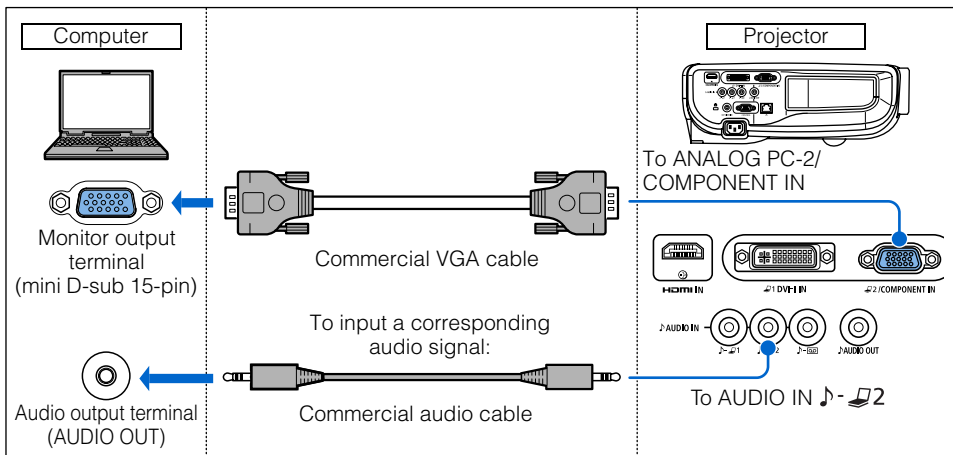

- Use full connected VGA cable in which all pins are connected; otherwise, an image will be projected improperly.
- Use an audio cable without a built-in resistor. Using an audio cable with a built-in resistor turns down the sound.

BNC cable (Input signal type: [ANALOG PC-2] - P47)

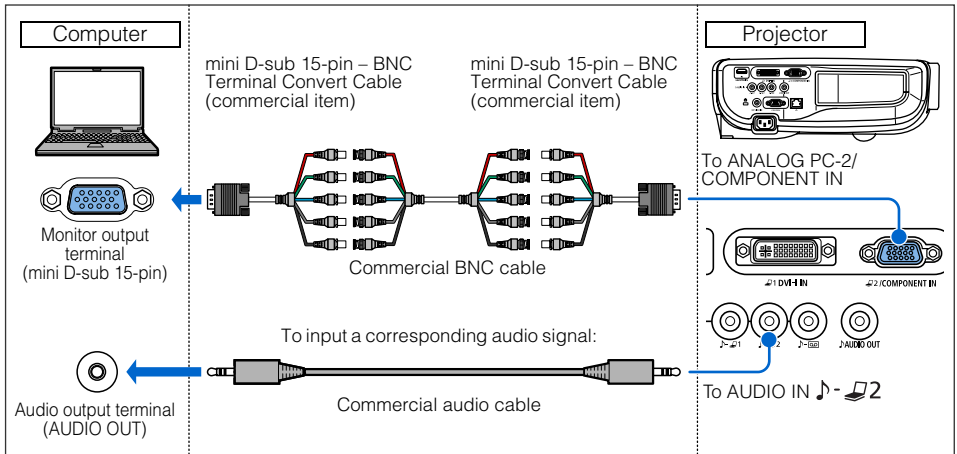

- It cannot project a signal whose dot clock is 170MHz or higher.
- Use an audio cable without a built-in resistor. Using an audio cable with a built-in resistor turns down the sound.

■ Connecting to DVI Monitor Output Terminal (digital connection)

DVI cable (Input signal type: [DIGITAL PC] - P47)

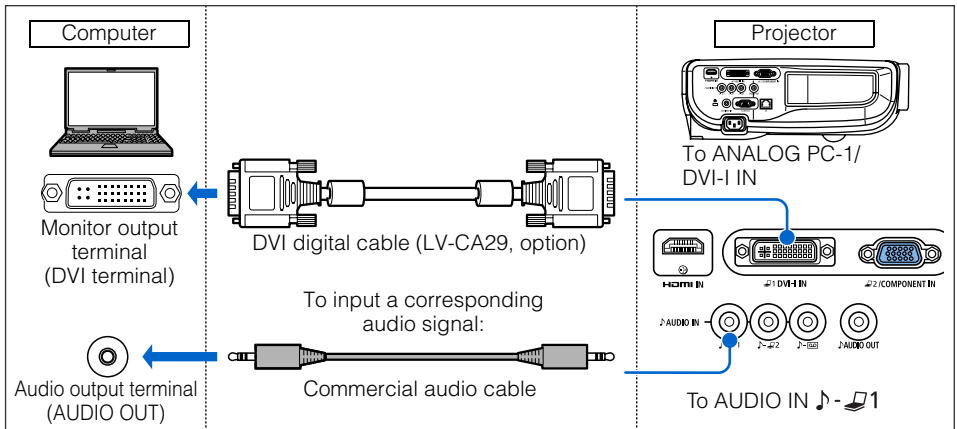

- Use an audio cable without a built-in resistor. Using an audio cable with a built-in resistor turns down the sound.

■ Outputting Audio to Speakers

It is possible to output sound of projected images to amplified speakers.

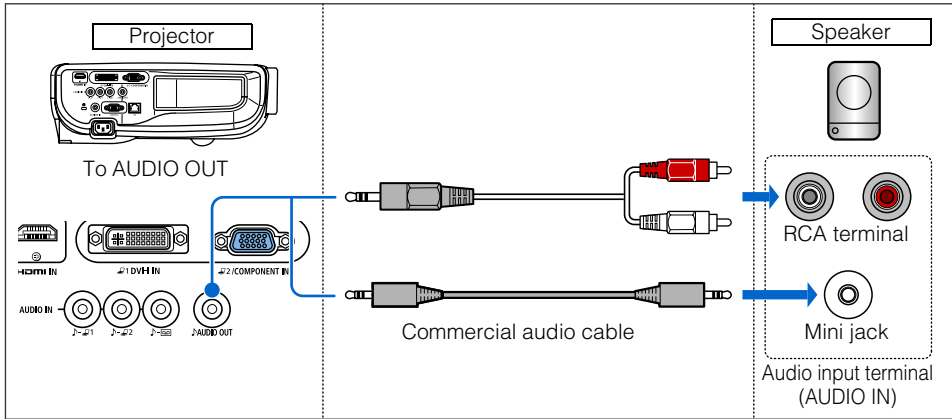

Use an audio cable without a built-in resistor. Using an audio cable with a built-in resistor turns down the sound.

Connecting to AV Equipment

Connect the projector and AV equipment.

Before connecting the cables, turn off both the projector and AV equipment.

The description provided here is just examples. For more detailed information, refer to the manual for the connecting AV equipment.

■ Connecting to Digital Video Output Terminal (digital connection)

HDMI cable (Input signal type: [HDMI] - P47)

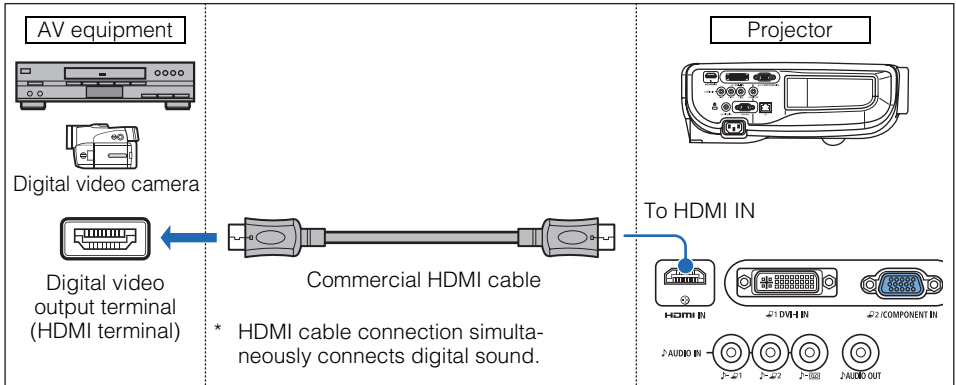

■ Connecting to Analog Video Output Terminal (analog connection)

Video cable (Input signal type: [VIDEO] - P47)

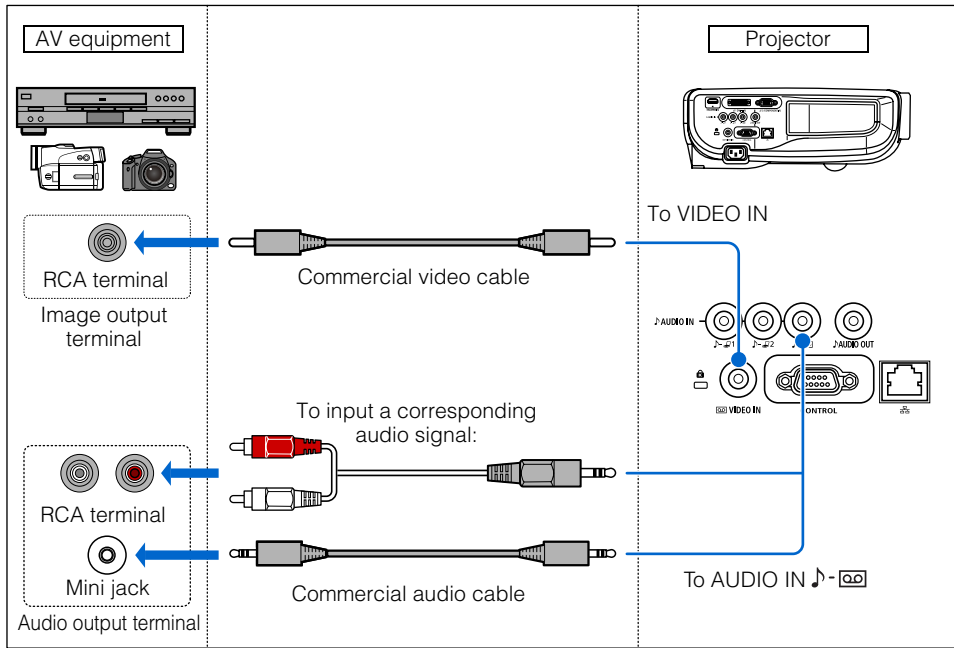

Use an audio cable without a built-in resistor. Using an audio cable with a built-in resistor turns down the sound.

Connecting the Projector

Supplied component cable (Input signal type: [COMPONENT] - P47)

A Component video signal from AV equipment can be input to the projector by connecting the supplied component cable to the ANALOG PC-2/COMPONENT IN terminal of the projector.

Use a commercial component cable that fits to the terminal type of the AV equipment to connect the supplied component cable.

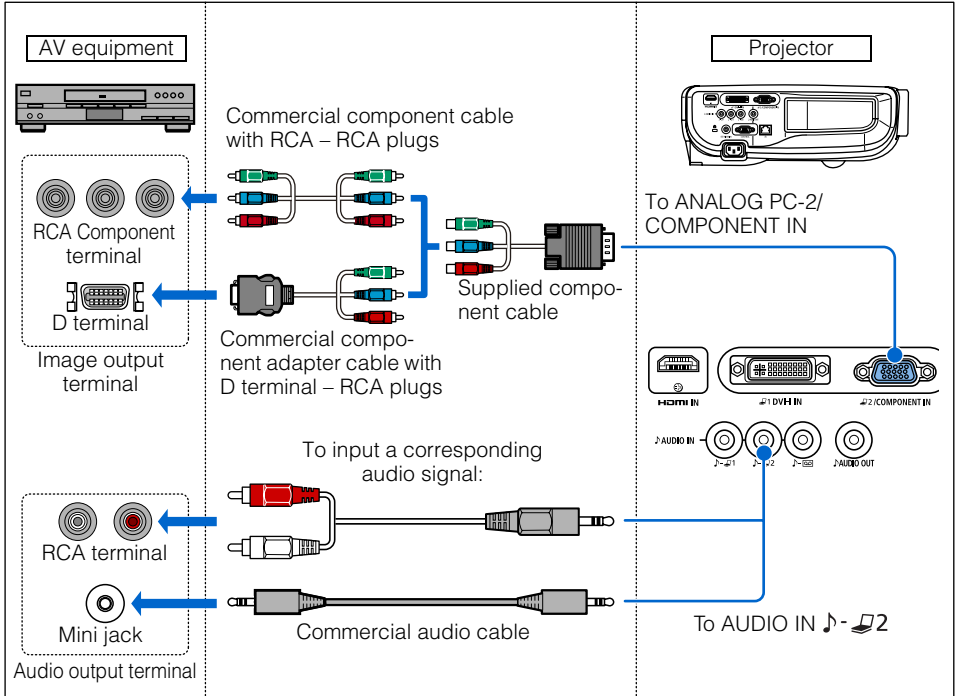

Use an audio cable without a built-in resistor. Using an audio cable with a built-in resistor turns down the sound.

■ Outputting Audio to Speakers

It is possible to output sound of projected images to AV equipment or amplified speakers.

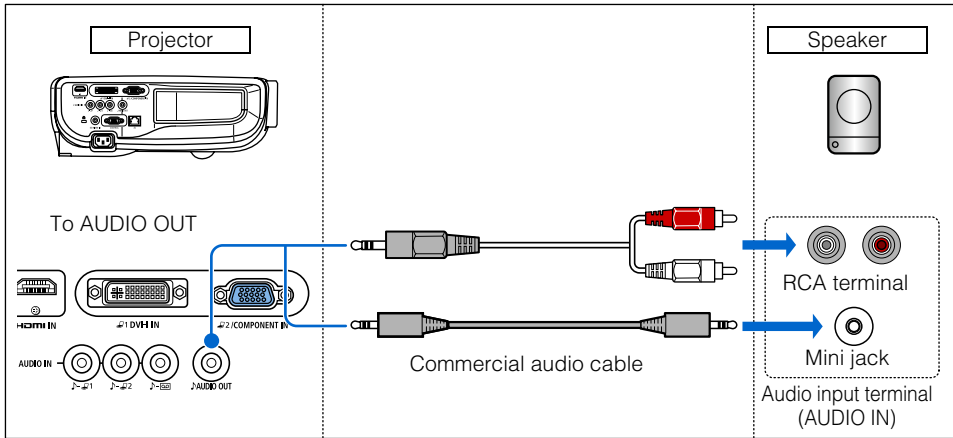

Use an audio cable without a built-in resistor. Using an audio cable with a built-in resistor turns down the sound.

Starting Projection

- 1** Check the connection between the projector and a computer or AV equipment. (P34 – P41)
- 2** Connect the power cord and make sure that the [POWER] indicator lights up red. Flashing red [POWER] indicator indicates that the lamp is being cooled. Wait until the indicator turns a steady red.

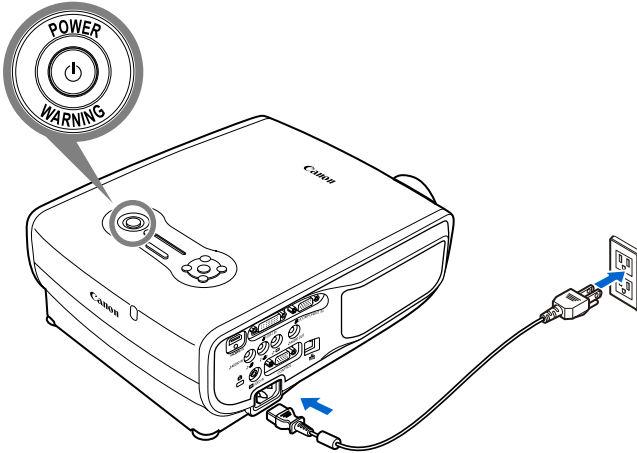

- Fully insert the power cord plug into the socket.
- Connect the ground terminal on the power plug to ground. Otherwise, an electric shock may result or the computer may suffer electromagnetic radiation problems or be subject to poor reception by TV and radio.
- Wait at least 5 minutes before turning on the projector when you turn off the projector. It may shorten the lamp life if you turn on the projector immediately after turning it off.
- To save power, unplug the power cord when not in use.

- 3** Remove the lens cap and press the POWER button. The POWER indicator flashes green, and then lights in green.

Remote control

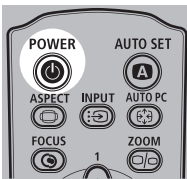

Top control

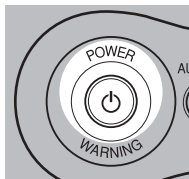

The countdown window is displayed for approximately 20 seconds, and then the projection is started. Press the **OK** button to make the countdown window disappear.

- 4** Turn on the computer or AV equipment power.

Changing Operations When Projector is Turned On

You can change operations when the projector is turned on as follows:

- You can turn on the projector by connecting the power cord without pressing the **POWER** button. (P93)
- You can specify whether to enable or disable the LED illumination lamp. (P96)
- You can change the countdown window. (P84)
- You can skip the countdown window. (P42)

Using the Power Saving Mode (power management)

When you enable the power management mode, the lamp is automatically turned off if the projector receives no signal input for a certain period of time. (P92)

5 Press the AUTO SET button.

Performs auto adjustment on focusing, keystone distortion, input signal settings, and screen color correction. For more details, refer to the page 45.

If the projector is projecting an image properly with [AUTO SETUP], the projection is complete.

For how to turn off the projector, refer to the page 62. Perform the appropriate operation depending on the following situations.

■ When the Language Selection Screen Appears

A window appears when the projector is turned on for the first time. You can select a language to be used by the projector for displaying menus and messages in the window.

Select the desired language with the pointer buttons and press the **OK** button.

You can change the language from the menu at a later time. (P95)

If the language selection screen is out of focus, press the **FOCUS** and then **AUTO SET** buttons to make focus adjustment.

Remote control



Top control

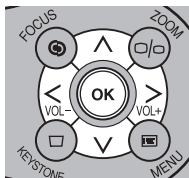

Language		
English	Русский	Čeština
Deutsch	Nederlands	Dansk
Français	Suomi	إنجليزي
Italiano	Norsk	中文简体
Español	Türkçe	中文繁體
Português	Polski	한국어
Svenska	Magyar	日本語

An item highlighted in orange will be selected.

■ When the Password Input Screen Appears

If you have set a password, the Password input screen appears. Enter your password. (P97)

■ When "No signal" Appears

A notebook computer requires to turn on the external monitor output. (P44)
Press the **INPUT** button to select an appropriate input signal. (P48)

■ When Notebook Computer Screen Does Not Appear

Set your notebook computer to output signals to an external monitor. For more details, refer to "Changing Notebook Computer Screen Output" below.

■ Adjusting Image

- For the display resolution of the computer, select "1920 x 1200 pixels" or a resolution closest to the output signal resolution of the computer. (P49)
- Use the auto PC function to adjust shift in computer image or the flickering of the screen. (P50)
- Use the **ZOOM** button to adjust the size of the projecting image. (P51)
- Use the **FOCUS** button to correct the focus adjustment if necessary. (P52)
- Use the **D.SHIFT/KEystone** button to adjust keystone correction if necessary. (P53)
- Select the aspect ratio of the projecting image (screen aspect) or a screen mode (aspect) according to the aspect ratio of the screen, type of input image signal and so on. (P55 - P60)
- Select an image mode depending on the projecting image. (P61)

Changing Notebook Computer Screen Output

To use a notebook computer, you need to change the screen output on the notebook computer.

This operation is not required for a desktop computer.

■ Turning On External Monitor Output

You can turn on the external monitor output via keyboard operation.

To turn on the external monitor output, press an icon for an external monitor or a function key ([F1] to [F12]) while holding [Fn] key down.

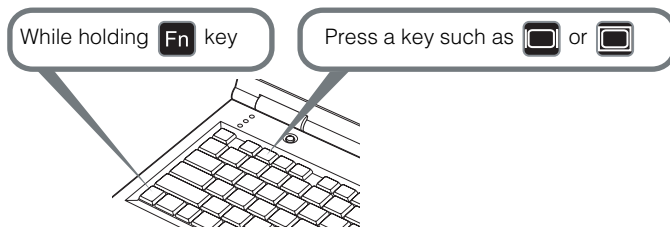

The function keys you use and the method used to turn on the external monitor output vary depending on the model. For details, see the instructions of your notebook computer.

Setting Up the Screen Automatically

Auto Setup

The auto setup function automatically makes the following settings and adjustments.

Setting image input signal (Auto input)

Focusing (Auto focus)

Keystone correction (Auto keystone)

Screen color correction (Auto screen color correction)

Use the auto setup function when:

- You turned the power on and the countdown sequence was completed.
- You changed the position or angle of the projector during the projection process.



- The auto screen color correction is disabled at the factory. To enable the auto screen color correction when performing the auto setup, select the function in menu. (P80)
- You cannot set a digital PC signal or an AV equipment signal ([Digital PC] and [HDMI]) with the auto setup function. Select the appropriate signal by pressing the **INPUT** button. (P48)
- When "No signal" message appears, press the **INPUT** button to select an appropriate input signal. (P48)
- If focusing, keystone distortion and/or screen color correction have not been performed properly, manually adjust them. (Adjusting the focus: P52, Correcting keystone distortion: P53 and Correcting the screen color: P80)
- If you select [16:9 D. image shift] or [4:3 D. image shift] for [Screen aspect], [Auto setup] will be disabled and the following screen appears.

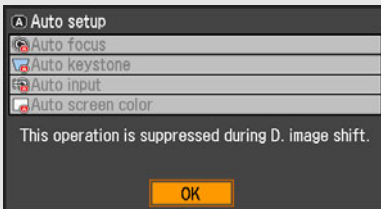

- When you press the **INPUT** button and then the **AUTO SET** button, only the input signal type is set.
- When you press the **FOCUS** button and then the **AUTO SET** button, only the focus is adjusted. If you select [16:9 D. image shift] or [4:3 D. image shift] for [Screen aspect], the auto focus function will be disabled.
- When you press the **D.SHIFT/KEystone** button and then the **AUTO SET** button, only the keystone distortion is adjusted. If you select [16:9 D. image shift] or [4:3 D. image shift] for [Screen aspect], the keystone adjustment will be disabled. The keystone adjustment is not performed under the some other conditions. For the details, refer to the page 54.

■ Performing the Auto Setup

Press the **AUTO SET** button to perform the auto setup.

Remote control

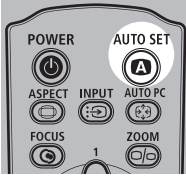

Top control

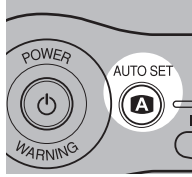

- After the auto setup is complete, the following window appears. Press the **OK** button.

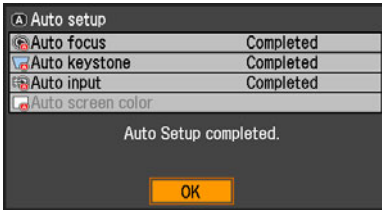









Selecting an Input Signal (INPUT)

Select an appropriate input signal in the [INPUT] menu if you want to project a digital PC or AV equipment signal or you connect multiple computers or AV equipment to receive their input signals.

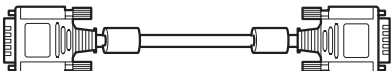
Skip this step if you have not changed the input signal since the last projection.

■ Types of Input Signals

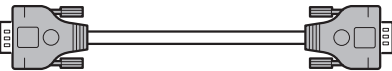
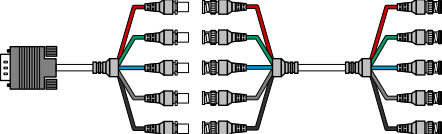
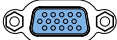
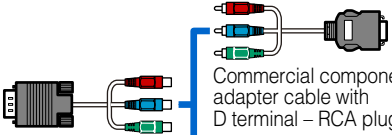
The table below shows the relationship among input signals supported by the projector, input terminals and connection cables.

Input signal	Input terminal	Types of connection cables
HDMI	HDMI IN 	HDMI cable (commercial item) 
DIGITAL PC	ANALOG PC-1/ DVI-I IN 	DVI digital cable (LV-CA29, option) 
ANALOG PC-1	ANALOG PC-1/ DVI-I IN 	Computer connection cable (supplied item) 
ANALOG PC-2	ANALOG PC-2/ COMPONENT IN 	VGA cable (commercial item) 
		BNC cable (commercial item)  mini D-sub 15-pin - BNC Terminal Convert Cable (commercial item) Commercial BNC cable
COMPONENT	ANALOG PC-2/ COMPONENT IN 	Component cable (supplied item)  Commercial component adapter cable with D terminal - RCA plugs Commercial component cable with RCA-RCA plugs
VIDEO	VIDEO IN 	Video cable (commercial item) 

■ Selecting an Input Signal

1 Press the INPUT button to pop up a window shown at the lower right.

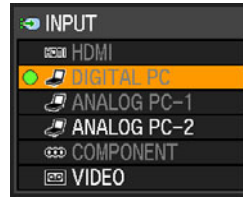
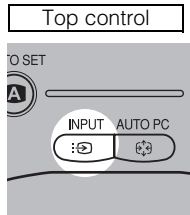
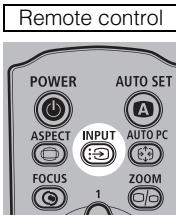

The currently active input signal is marked with a circle and highlighted in orange. An input signal that is ready for projection is displayed in white. When no signal is received, it is displayed in gray. [HDMI], [DIGITAL PC], and [ANALOG PC-1] may be displayed in gray even if they are ready for projection.

2 The selection is toggled through available input signal types by pressing the INPUT button.

- You can select the target input signal with [\wedge] / [\vee].
- Only the input signals displayed in white can be selected.

3 Press the OK button to determine the input signal type.
If no button is pressed in 4 seconds, the selected input signal type is chosen.

Setting the Display Resolution of the Computer

Set the display resolution of the computer to "1920 x 1200 pixels" or a resolution closest to the output signal resolution of the computer based on the performance of the projector (resolution: 1920 x 1200 pixels). (P128)

■ Windows Vista

- 1 Open the [Control Panel] from the start menu, then select [Appearance and Personalization] - [Adjust screen resolution] in the [Control Panel Home].
- 2 Select "1920 x 1200 pixels" or a resolution closest to the output signal resolution of the computer.
- 3 Click the OK button.

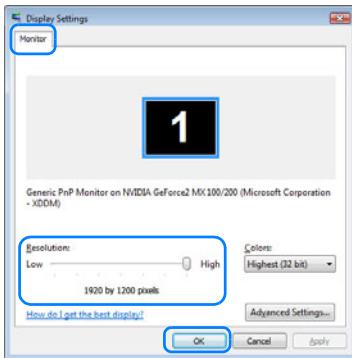

■ Windows XP

- 1 Right-click on the desktop background and select [Properties] to open the [Display Properties].
- 2 Click the [Settings] tab, and under [Screen Resolution], select "1920 x 1200 pixels" or a resolution closest to the output signal resolution of the computer.
- 3 Click the OK button.

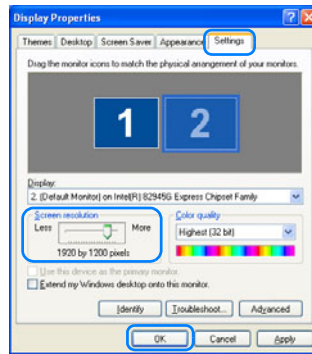

■ Macintosh OSX

- 1 Open the Apple Menu and select [System Environment Setting].
- 2 In the System Environment Setting window, click the [Displays] icon to display the Display window.
- 3 Select the [Display] tab and select "1920 x 1200" or a resolution closest to the output signal resolution of the computer from the [Resolution] list.
- 4 Close [System Environment Setting] window.

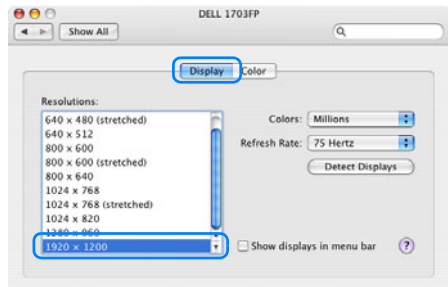

AUTO PC

When you press the **AUTO PC** button if there is a shift in image display or flickering of screen with the [ANALOG PC-1] or [ANALOG PC-2] selected, the projector is adjusted to an optimum condition.

The result of adjustment is recorded for each input signal ([ANALOG PC-1] or [ANALOG PC-2]). If you connect the projector to the same computer, you can project the image with the same settings as before simply by select the input signal.

■ Performing the Auto PC Function

Press the **AUTO PC** button to make projector adjustment.

Remote control

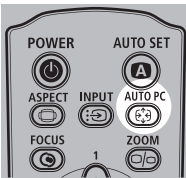

Top control

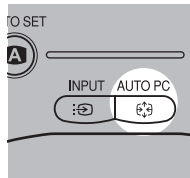

Perform the following if the project image has not been properly adjusted with the auto PC function.

- From [Input signal select], select an input signal type based on the resolution of the computer. (P74)
- If the adjustment is still insufficient, from [Input signal settings] select [Total dots], [Tracking], [Horizontal position], [Vertical position], [Horizontal pixels] and [Vertical pixels] to make adjustments. (P75 – P78)
- For the signal types supported by the projector, see the table on page 128.

Adjusting the Image Size

Use the **ZOOM** button to adjust the size of the projecting image.
Change the projector installation position if your desired image is too large or too small to adjust it with the zoom function. (P31)

- 1** Press the **ZOOM** button to pop up a window shown at the lower right.

Remote control

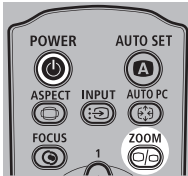

Top control

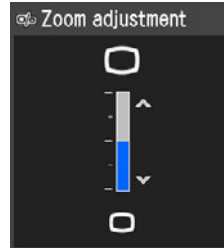
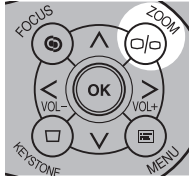

- 2** Press the pointer buttons to adjust the image size.

Remote control



Top control

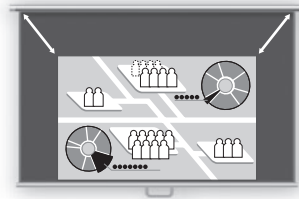
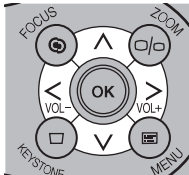

[^] / [v]: Rough adjustment.
[<] / [>]: Fine adjustment.

- 3** When the image size is determined, press the **OK** button or the **ZOOM** button.

Adjusting the Focus

You can adjust the focus with the **FOCUS** button. The projection image may be out of focus if the projection distance is beyond the range of 1.2 m (3.9') to 9.1 m (29.6'). Move the projector installation position if such is the case. (P31)

■ Auto focusing

Press the **FOCUS** button, and then the **AUTO SET** button.



If you select [16:9 D. image shift] or [4:3 D. image shift] for [Screen aspect], the auto focus function will be disabled.

■ Manual focusing

1 Press the **FOCUS** button to pop up a window shown at the lower right.

Remote control

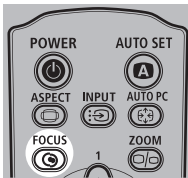

Top control

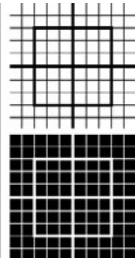
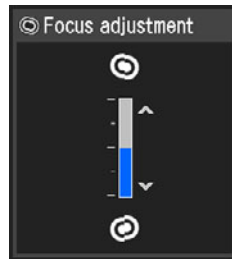
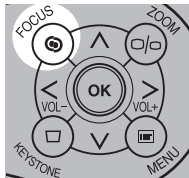

2 Press the pointer buttons to adjust the focus.

Remote control



Top control

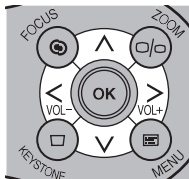

[\wedge] / [\vee]: Rough adjustment.

[\lt] / [\gt]: Fine adjustment.

3 When the focus is adjusted optimally, press the **OK** button or the **FOCUS** button.

Adjusting Keystone Distortion

The D.SHIFT/KEYSTONE button corrects the keystone distortion.



- Keystone can be adjusted within the range of ± 20 degrees. If the keystone distortion is too large to adjust, move the projector installation position. (P31)
- The amount of adjustment may be smaller depending on type of input signal.
- The result of keystone adjustment is memorized. If you place the projector at the same position, the keystone adjustment is not necessary.
- Signals are processed digitally when keystone distortion is corrected. The image may look different from the original one. In addition, the aspect ratio of the image may change.
- If you select [16:9 D. image shift] or [4:3 D. image shift] for [Screen aspect], the keystone adjustment will be disabled. Project the image at right angle to the screen. The keystone adjustment is not performed under the some other conditions. For the details, refer to the next page.

■ Auto adjustment

Press the D.SHIFT/KEYSTONE button, and then the AUTO SET button.

■ Manual adjustment

1 Press the D.SHIFT/KEYSTONE button to pop up a window shown at the lower right.

Remote control

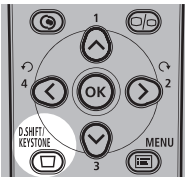

Top control

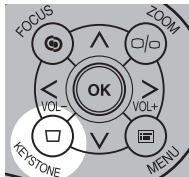

Keystone adjustment



2 Press the pointer buttons to adjust the focus.

Remote control

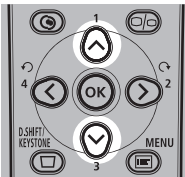

Top control

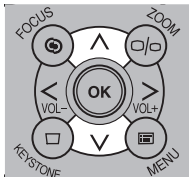

[\wedge]: Reduces the length of the upper edge.

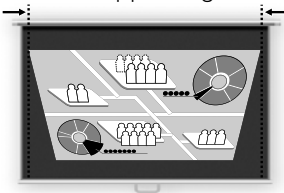

[\vee]: Reduces the length of the lower edge.

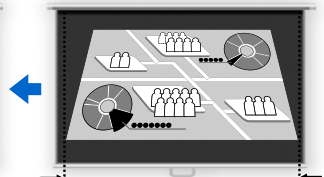
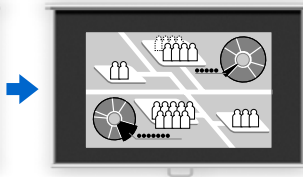

3 When the keystone distortion has been adjusted, press the OK button.

■ Resetting the Keystone Adjustment

Perform the following steps to reset the keystone adjustment.

Press the **D.SHIFT/KEYSTONE** button twice to display the [Keystone reset] window.

On the window, select [OK] with [**<**], and then press the **OK** button.

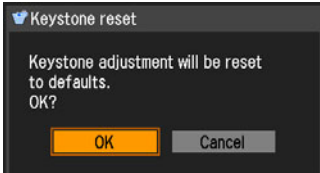

It cannot perform the keystone adjustment under the combinations shown in the following table.

Signal	Signal type	Resolution (dots)	Screen Aspect
Analog PC	SXGA	1280 x 1024	[4:3]
	UXGA	1600 x 1200	[4:3], [16:9], [16:10]
Component	1080i	–	[16:9], [16:10]
HDMI	1080i	–	[16:9], [16:10]

Selecting Screen Aspect and Aspect

Select an optimum aspect ratio of the projecting image (screen aspect) or an optimum screen mode (aspect) according to the aspect ratio of the screen, type of input image signal and so on for the projection making best use of the screen size.

- [Screen aspect]: Select the same aspect ratio with your screen.
- [Aspect]: Select [Auto] unless the type of input signal is [VIDEO].

You may need to change the setting depending on the resolution of the computer. If the image is not projected with a desired aspect ratio, see "Relationship between Aspect and Screen Aspect" in Appendix on page 125.

Selecting Screen Aspect

Select the aspect ratio of projecting image to the aspect ratio of the screen. Perform the following steps to select the aspect ratio of the projecting image.

- 1 Press the MENU button to display a menu window.

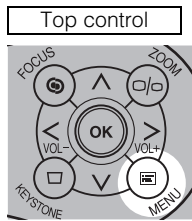
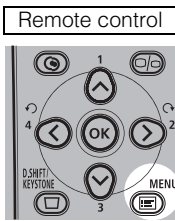

- 2 Use [←] / [→] to select the [Display settings] tab.

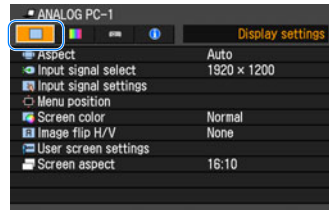
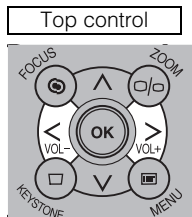
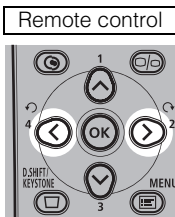

- 3 Select [Screen aspect] with [↑] / [↓], and then press the OK button.

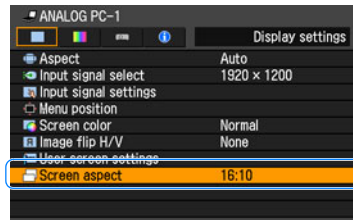
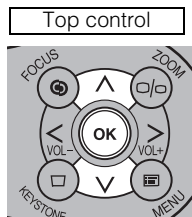
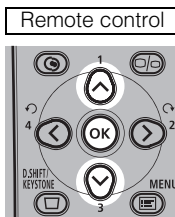

4 Use [\wedge] / [\vee] to select a screen aspect type.

Remote control

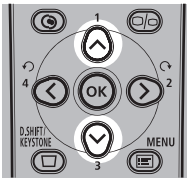

Top control

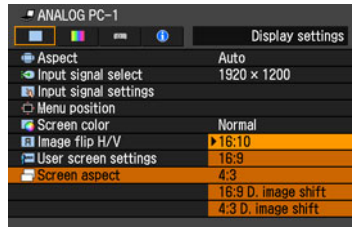
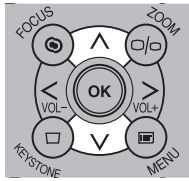

16:10

Select this when you use a screen with aspect ratio of 16:10. Also, select this when you project an image on a wall.

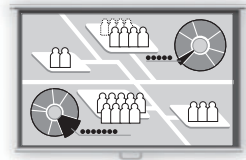

16:9

Select this when you use a screen with aspect ratio of 16:9.



4:3

Select this when you use a screen with aspect ratio of 4:3.

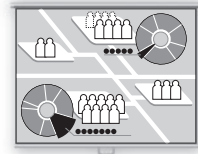

16:9 D. image shift

Select this when you use a screen with aspect ratio of 16:9. Suitable for projecting visual software having aspect ratio of 16:9. You cannot correct the keystone distortion in this mode, but you can move the image up or down with images being projected horizontally. See the following page on how to shift the image.

4:3 D. image shift

Select this when you use a screen with aspect ratio of 4:3. Suitable for projecting visual software having aspect ratio of 4:3. You cannot perform the keystone adjustment in this mode; however, you can move the image to the left or right while projecting the image horizontally. For the details on how to move the image, refer to the page [58](#).

5 Press the OK button to accept your setting and then press the MENU button.

■ Moving Image with 16:9 D. Image Shift

- 1 Press the D.SHIFT/KEystone button when [16:9 D. image shift] is selected for [Screen aspect] to pop up a window at the lower right.

Remote control

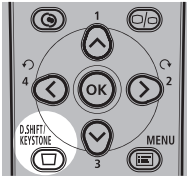

Top control

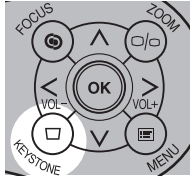

- 2 Use [\wedge] / [\vee] to move the image.

Remote control

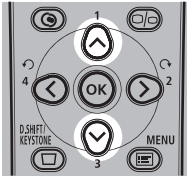

Top control

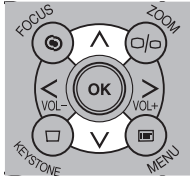

[\wedge]: Moves up the image.

[\vee]: Moves down the image.

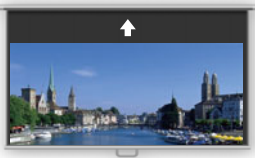

- 3 When the image shift adjustment has been completed, press the OK button.

■ Moving Image with 4:3 D. Image Shift

- 1 Press the D.SHIFT/KEYSTONE button when [4:3 D. image shift] is selected for [Screen aspect] to pop up a window at the lower right.

Remote control

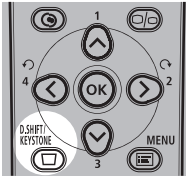

Top control

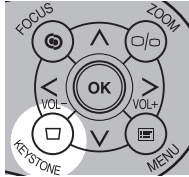

- 2 Use [<] / [>] to move the image.

Remote control

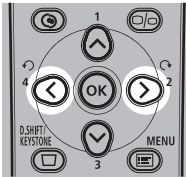

Top control

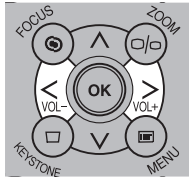

[<]: Move the image to the left.

[>]: Move the image to the right.



- 3 When the image shift adjustment has been completed, press the OK button.

■ Resetting the Image Shift

Perform the following steps to reset the image shift adjustment.

Press the D.SHIFT/KEYSTONE button twice to display the [D.image shift reset] window.

On the window, select [OK] with [<], and then press the OK button.

Selecting Aspect Ratio

Select the aspect ratio of projecting image based on the input signal type, aspect ratio of the screen and resolution.

For more details on the aspect ratios, refer to "When Projecting an Image from a Computer" on page [125](#).

■ Types of Aspect Ratios

Auto

An image is projected at an aspect ratio of the input signal. Select this mode for normal image projection.



[Auto] is not available if the input signal type is [VIDEO].

Full

An image is projected at an aspect ratio of 16:10.

Select this to project computer screen images having an aspect ratio of 16:10 (WUXGA, WSXGA+, WSXGA, and WXGA (1280 x 800)) fully on the screen.

16:9

An image is projected at an aspect ratio of 16:9. Select this if an image of 16:9 aspect ratio cannot be appropriately projected in the [AUTO] mode.

4:3

An image is projected at an aspect ratio of 4:3. Select this if an image of 4:3 aspect ratio cannot be appropriately projected in the [AUTO] mode.

Zoom

An image with 4:3 aspect ratio is projected in the center of the screen enlarged in 16:9 aspect ratio with the upper and lower portion of the image cut off. Select this when projecting visual software having aspect ratio of 4:3 and black belts at the top and bottom of the image.

- This mode is available when you select [16:10], [16:9] or [16:9 D. image shift] for [Screen aspect] and select [HDMI (480p)], [COMPONENT (480p, 480i)] or [VIDEO] for input signal.

True size

An image is projected with the original resolution of the input signal. Select this to clearly project a computer screen image having a resolution of WUXGA or lower.

- This mode is available when you select [ANALOG PC-1], [ANALOG PC-2] or [DIGITAL PC] for input signal.
- This mode is also available when you select [HDMI (480p, 576p, 720p, 1080i, 1080p)] and [COMPONENT (480p, 576p, 720p, 1080i, 1080p)] for input signal. 1080i and 1080p are unavailable when [4:3] or [4:3 D. image shift] is selected for [Screen aspect].

■ How to Select an Aspect Ratio

Press the **ASPECT** button on the remote control to select an appropriate aspect ratio. The selection is toggled among types for aspect ratios by pressing the **ASPECT** button.

For more details on the aspect ratios, refer to "When Projecting an Image from a Computer" on page 125.

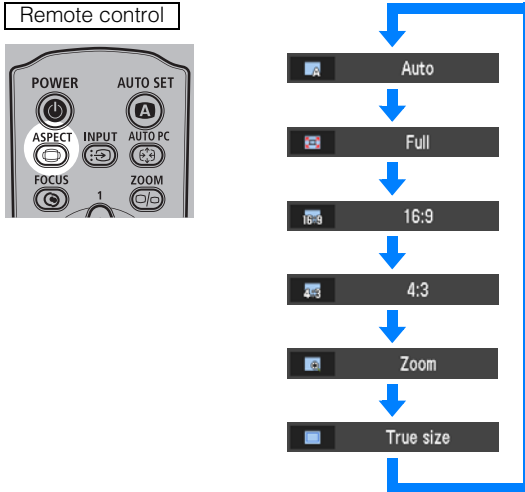

You can also select any aspect ratio from the menu. (P73)



Some aspect ratios may not appear depending on types of input signals.

Selecting an Image Mode

You can select an image mode depending on the projecting image. In each image mode, you can further adjust the brightness, contrast, sharpness, gamma, color adjustment, advanced adjustment, and lamp mode. (P85)

■ Image modes

Standard

Select this to project an image with near-original quality and a high regard for reproduction of white. It is suited to project text-based computer screens or visual software (moving pictures) in a bright room.

Presentation

Select this to project an image with quality suited for the presentation. It is also suited to project visual software (moving pictures) with a high regard for the brightness.

Movie

Select this to project common visual software (moving pictures). It is suited to easily enjoy the atmosphere of a moving theater in a dim room.

sRGB

Select this if you want to project an image in the display mode conforming to the sRGB standard (P130). It is suited to project an image shot by sRGB-compatible digital camera.

■ How to Select an Image Mode

Press the **IMAGE** button on the remote control to select your desired image mode. The selection is toggled among aspect types by pressing the button.

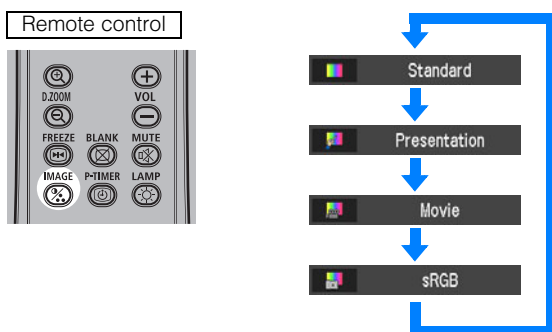

You can also select any image mode from the [Image mode] menu. (P85)

Turning Off the Projector

1 Press the **POWER** button to pop up a window shown at the lower right.

Remote control

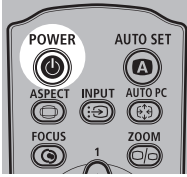

Top control

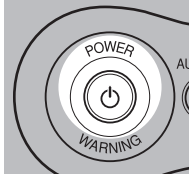

Press the **POWER** button again while the confirmation message is displayed. The lamp goes off, the [POWER] indicator starts flashing in red and the cooling fan starts.



- You cannot turn the projector on while the cooling fan is in operation.
- If you want to continue projecting, press a button other than **POWER** or wait until the confirmation message disappears.
- Wait at least 5 minutes before turning on the projector when you turn off the projector. It may shorten the lamp life if you turn on the projector immediately after turning it off.
- Using the projector for a long time may shorten the life of the lamp and internal optical components.

2 Disconnect the power cord from the AC outlet.

It continues to cool down the lamp even after removing the power cord. Thus, you may move or put away the projector immediately after the use. With the power cord connected, the LED illumination lamp turns on during cooling cycle.

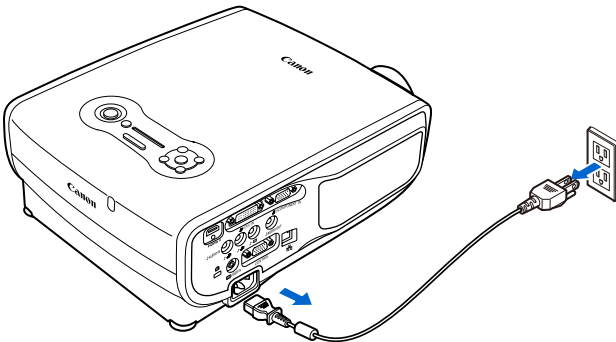

- Wait until the cooling fan stops before putting the projector in the carrying bag. Do not put the projector in the carrying bag until the cooling fan stops rotating. The projector may be damaged due to the heat.
- Attach the lens cap to the lens to protect it and put the projector in the carrying bag. Replace the adjustable foot to prevent the damage on the projector.

Useful Functions Available During a Presentation

Table of Contents

Safety Instructions

Before Use

Projecting an Image

Useful Functions Available During a Presentation

Setting Up Functions from Menus

Connecting the Projector to Network

Appendix

Index

Useful Functions Available During a Presentation

Blackened Out an Image Temporarily





Useful when:

- You finished the presentation.
- You want to divert attendees' attention from the screen.

Remote control



Press the  button to blacken out the image.

Press the  button again to show the image.

- You can set the screen state while blackening out the image on the menu. You can also set a specified image. (P83)
- The lamp keeps a turn-on state while blackening out the image.
- The (middle) LED illumination lamp on the top control flush slowly while blackening out the image.

Freezing the Picture



Useful when:

- You want to perform a computer operation which is irrelevant to the proceedings of the presentation.
- You want to stop a moving image.

Remote control

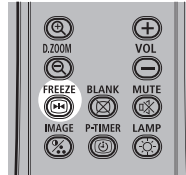

Press the  button to freeze the moving image. The projector shows the following icon.

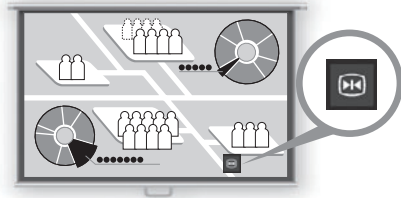

Press the  button again to cancel the FREEZE function.

- The (left and right) LED illumination lamps on the top control flushes slowly while stopping the image.
- It is cancelled once the input signal is terminated.

Adjusting the Volume



Useful when:

- You want to adjust the volume level of the projectors or external speaker.

Remote control



Press the  button. The following screen appears.

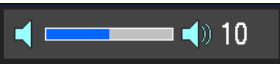

- You can also adjust the volume level with [$<$] / [$>$] of the projector.
- Adjust the volume or mute setting on the computer if the volume level is too low.
- You can also adjust the volume level of the speakers connected via the audio output terminal.

Muting the Sound



Useful when:

- You want to temporarily mute the unnecessary sound.
- You want to immediately mute the sound.

Remote control

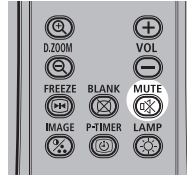

Press the  button to mute the sound. The projector shows the following icon.

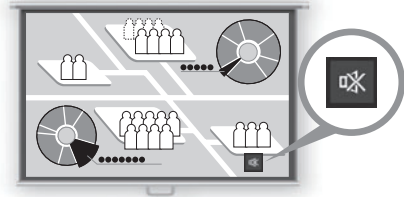

Press the  button again to cancel the MUTE function.

- You can also mute the sound of the speakers connected via the audio output terminal.

Zooming an Image



Useful when:

- Zoom in an object such as a small graph during a presentation (up to 12x).
- Focusing on the current subject.

Press the  button. A part of the image is enlarged each time pressed.

Remote control

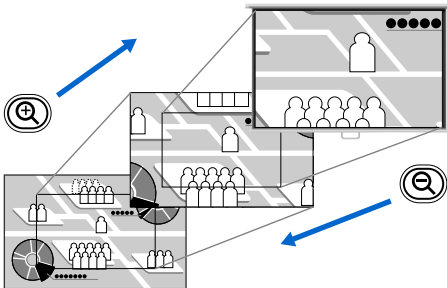

- The magnification appears on the screen.

You can move the area to the enlarged by using [\wedge] / [\vee] / [\leftarrow] / [\rightarrow].

Remote control

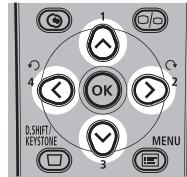

Projector

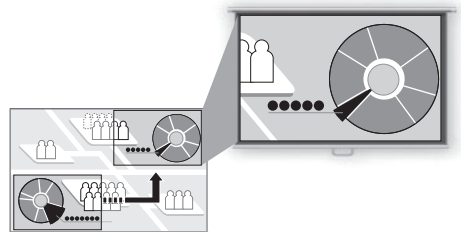
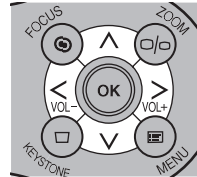

You can restore the original size of the image by pressing the  button.

Showing the Elapsed Time P-TIMER



Useful when:

- You want to manage the proceedings of the presentation.

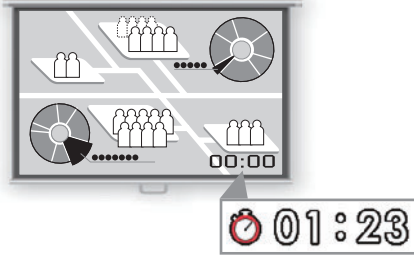

Press the ^{P-TIMER} button to start counting.

- The elapsed time is displayed at the lower right corner of the screen.
- Time is counted up to 59:59. Then the timer returns to 00:00.

Remote control

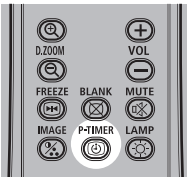

Press the ^{P-TIMER} button again to stop the timer.

- Press the ^{P-TIMER} button while the timer is stopped. The timer disappears from the screen.

Then press the ^{P-TIMER} button to start counting from 00:00.

Setting Functions from Menus

Table of Contents

Safety Instructions

Before Use

Projecting an Image

Useful Functions Available During a Presentation

Setting Up Functions from Menus

Connecting the Projector to Network

Appendix

Index

How to Use Menu

With a menu, you can set the operation of the projector in detail.

■ Menu Configuration

The menu screen is divided into four tabs as follows:



[Display settings] tab (P73)

You can set the type of signal or the method of projection of the images input.



[System settings] tab (P92)

You can set the operation of the projector.



[Image adjustment] tab (P85)

You can adjust the image quality and colors as you like.



[Information] tab (P101)

You can confirm the information about the signal types of the images projected and other projector-specific information.

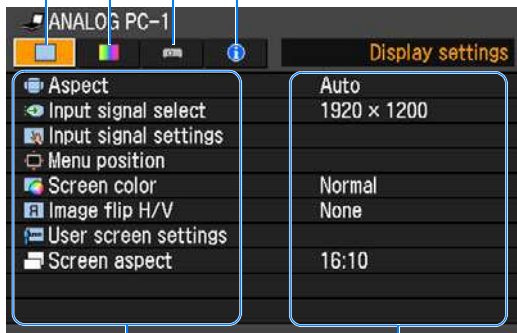

Menu items

Contents of menu

Input Signal Types for which a Menu Item is Displayed

Different menu items are displayed for different input signal types.

In the following explanation of each menu item, the input signal type for which the menu item is displayed is indicated as follows:

- Input signal for which the menu item is displayed
- Input signal for which the menu items is not displayed



Basic Operation of Menu

1 Press the MENU button to display a menu window.

Remote control

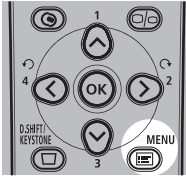

Top control

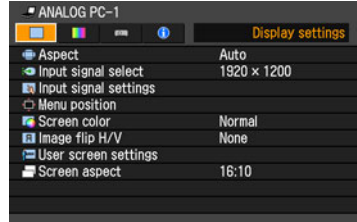
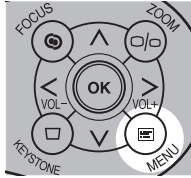

2 Use [<] / [>] to select a tab.

Remote control

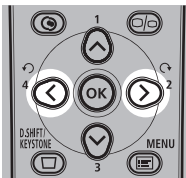

Top control

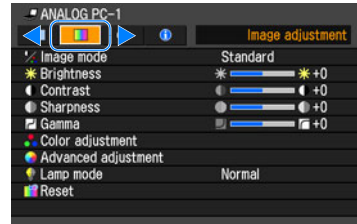
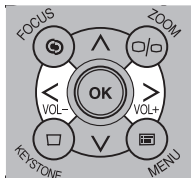

- If the tab position is not highlighted in orange, use [^] / [v] to move the highlight to the top.

3 Use [^] / [v] to select an item.

Remote control



Top control

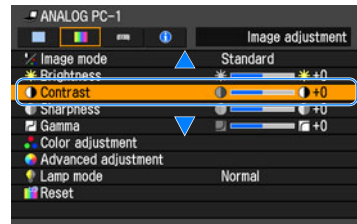
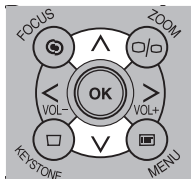

4 Select contents.

How to select the contents varies depending on items.

Selection from a list Example: Aspect

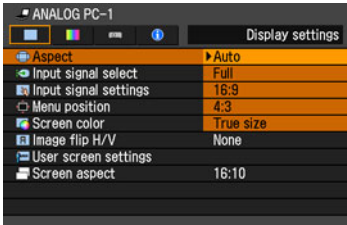

1. Press the **OK** button or [**>**], and a list of the contents is displayed.
2. Use [**^**] / [**v**] to select contents.
3. If you found the contents you desired, press the **OK** button or [**>**].

With [**<**] / [**>**] Example: Contrast



Use [**<**] / [**>**] to change the adjustment volume.

In a different screen (1) Example: Menu position

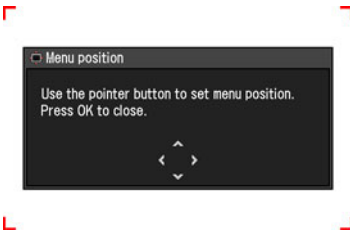

1. Press the **OK** button to display a different screen.
2. The follow the instruction on the screen.

In a different screen (2) Example: Tracking

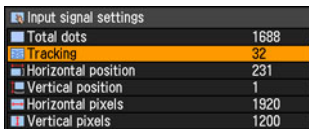

1. Press the **OK** button to display a different screen.
2. Use [**^**] / [**v**] to select contents, and use [**<**] / [**>**] to select a value.
3. If you found the contents you desired, press the **OK** button.

5 Press the MENU button, and the menu screen disappears.

Setting Display Status

Selecting an Image Projection Mode

[Aspect]

- HDMI
- DIGITAL PC
- ANALOG PC
- COMPONENT
- VIDEO



You can select a projection mode corresponding to the aspect ratio of image. (P59)

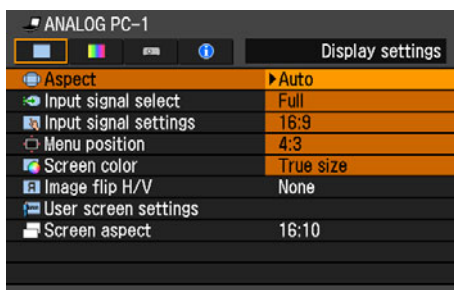

- Different contents are displayed for different screen aspects or input signal types.
- The **ASPECT** button on the remote control can also be used to select the Aspect settings.

Auto	An image is projected at an aspect ratio of the input signal. Select this mode for normal image projection.
Full	An image is projected at an aspect ratio of 16:10. Select this to project computer screen images having an aspect ratio of 16:10 (WUXGA, WSXGA+, WSXGA, and WXGA (1280 x 800)) fully on the screen.
16:9	An image is projected at an aspect ratio of 16:9. Select this if an image of 16:9 aspect ratio cannot be appropriately projected in the [AUTO] mode.

4:3 An image is projected at an aspect ratio of 4:3. Select this if an image of 4:3 aspect ratio cannot be appropriately projected in the [AUTO] mode.

Zoom An image with 4:3 aspect ratio is projected in the center of the screen enlarged in 16:9 aspect ratio with the upper and lower portion of the image cut off. Select this when projecting visual software having aspect ratio of 4:3 and black belts at the top and bottom of the image.

- This mode is available when you select [16:10], [16:9] or [16:9 D. image shift] for [Screen aspect] and select [HDMI (480p)], [COMPONENT (480p, 480i)] or [VIDEO] for input signal.

True size An image is projected with the original resolution of the input signal. Select this to clearly project a computer screen image having a resolution of WUXGA or lower.

- This mode is available when you select [ANALOG PC-1], [ANALOG PC-2] or [DIGITAL PC] for input signal.
- This mode is also available when you select [HDMI (480p, 576p, 720p, 1080i, 1080p)] and [COMPONENT (480p, 576p, 720p, 1080i, 1080p)] for input signal. 1080i and 1080p are unavailable when [4:3] or [4:3 D. image shift] is selected for [Screen aspect].

Press the **OK** button to accept your setting and then press the **MENU** button.

 [Auto] and [True size] are not available if the input signal type is [VIDEO].

Selecting an Input Signal Type (ANALOG PC)

[Input signal select]

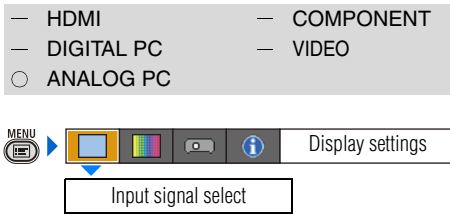

You can select a proper resolution if auto PC adjustment function (P50) cannot project a correct image from a computer.

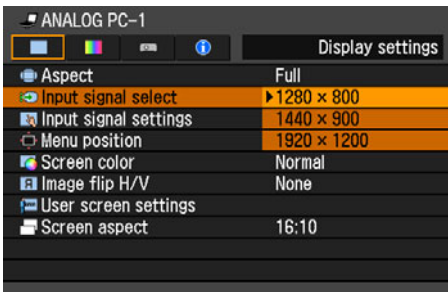

Press the **OK** button to accept your setting and then press the **MENU** button.

Select an input signal corresponding to the resolution of the computer.

- For the signal types supported by the projector, see the table on page 128.

Selecting an Input Signal Type (VIDEO)

[Input signal select]

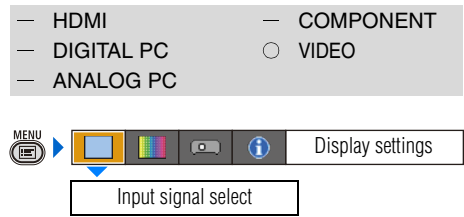

You can select a proper signal type if a video image from your AV equipment is not projected correctly.

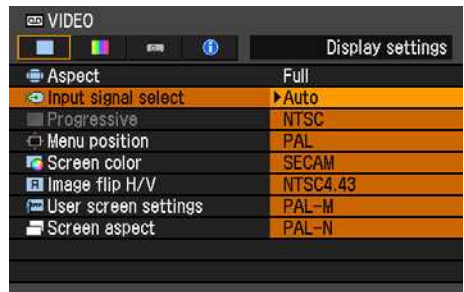

Press the **OK** button to accept your setting and then press the **MENU** button.

- [Auto] is the factory default.
- Refer to the User's Manual of your AV equipment connected to the projector to confirm the input signal type.

Selecting an Input Signal Type (COMPONENT)

[Input signal select]

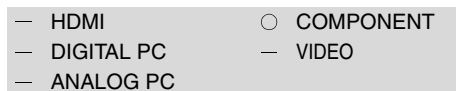

You can select a proper component signal type, if a video image from AV equipment is not projected correctly.

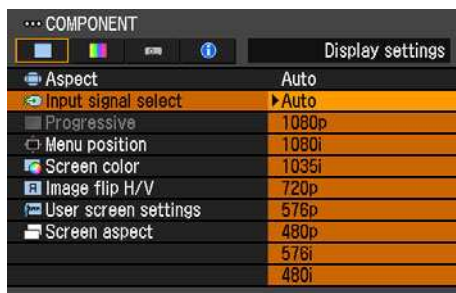

Press the **OK** button to accept your setting and then press the **MENU** button.

- [Auto] is the factory default.
- Refer to the User's Manual of your AV equipment connected to the projector to confirm the component signal type.

Adjusting Input Signal (ANALOG PC) – Total Dots

[Input signal settings] - [Total dots]

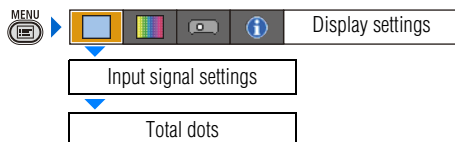
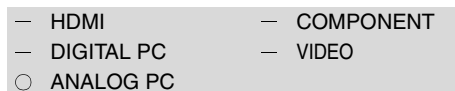

You can adjust the total number of dots in the horizontal direction. Adjust it when stripes are displayed on the screen.

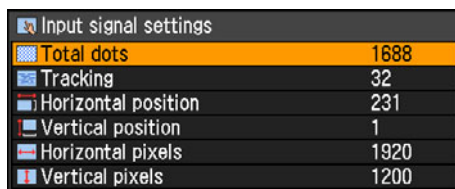

Use [**<**] / [**>**] to select a value. When you have completed the adjustment, press the **MENU** button.

- Perform this adjustment if the [AUTO PC] function (P50) cannot adjust the project image correctly.
- You can make adjustment either for [ANALOG PC-1] or [ANALOG PC-2].

Adjusting Input Signal (ANALOG PC) – Tracking

[Input signal settings] - [Tracking]

- HDMI
- DIGITAL PC
- ANALOG PC
- COMPONENT
- VIDEO

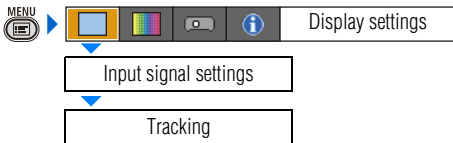

You can fine-tune the timing for generating an image from the image signal. Adjusts the tracking when the image distorts or flickers.

Input signal settings	
Total dots	1688
Tracking	32
Horizontal position	231
Vertical position	1
Horizontal pixels	1920
Vertical pixels	1200

Use [$<$] / [$>$] to select a value. When you have completed the adjustment, press the **MENU** button.

- Perform this adjustment if the [AUTO PC] function (P50) cannot adjust the project image correctly.
- You can make adjustment either for [ANALOG PC-1] or [ANALOG PC-2].

Adjust Input Signal (ANALOG PC) – Horizontal position

[Input signal settings] - [Horizontal position]

- HDMI
- DIGITAL PC
- ANALOG PC
- COMPONENT
- VIDEO

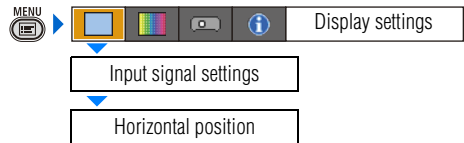

You can adjust the horizontal position of the screen when the projected image is shifted in the horizontal direction.

Input signal settings	
Total dots	1688
Tracking	32
Horizontal position	231
Vertical position	1
Horizontal pixels	1920
Vertical pixels	1200

Use [$<$] / [$>$] to select a value. As the value increases, the screen moves to the left.

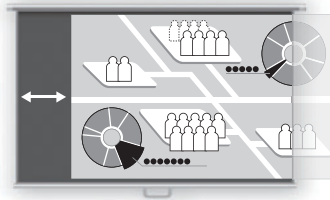

When you have completed the adjustment, press the **MENU** button.

- Perform this adjustment if the [AUTO PC] function (P50) cannot adjust the project image correctly.
- You can make adjustment either for [ANALOG PC-1] or [ANALOG PC-2].

Adjust Input Signal (ANALOG PC) – Vertical position

[Input signal settings] - [Vertical position]

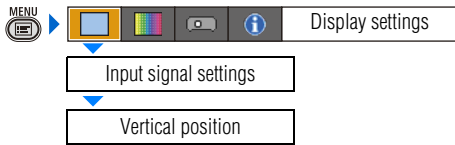

You can adjust the vertical position of the screen when the projected image is shifted in the vertical direction.

Input signal settings	
Total dots	1688
Tracking	32
Horizontal position	231
Vertical position	1
Horizontal pixels	1920
Vertical pixels	1200

Use [$<$] / [$>$] to select a value. As the value increases, the screen moves upward.

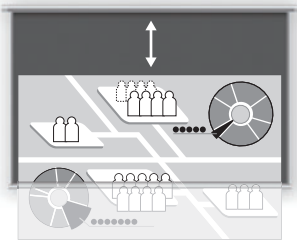

When you have completed the adjustment, press the **MENU** button.

- Perform this adjustment if the [AUTO PC] function (P50) cannot adjust the project image correctly.
- You can make adjustment either for [ANALOG PC-1] or [ANALOG PC-2].

Adjust Input Signal (ANALOG PC) – Horizontal pixels

[Input signal settings] - [Horizontal pixels]

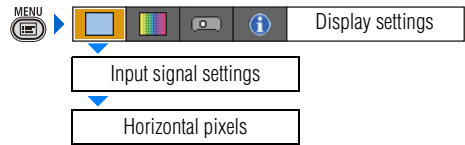

You can adjust the number of the pixels in the horizontal direction if the length of the screen is too long or too short in the horizontal direction.

Input signal settings	
Total dots	1688
Tracking	32
Horizontal position	231
Vertical position	1
Horizontal pixels	1920
Vertical pixels	1200

Use [$<$] / [$>$] to select a value.

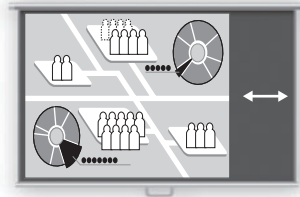

When you have completed the adjustment, press the **MENU** button.

- Perform this adjustment if the [AUTO PC] function (P50) cannot adjust the project image correctly.
- You can make adjustment either for [ANALOG PC-1] or [ANALOG PC-2].

Adjust Input Signal (ANALOG PC) – Vertical pixels

[Input signal settings] - [Vertical pixels]

- HDMI
- DIGITAL PC
- ANALOG PC
- COMPONENT
- VIDEO

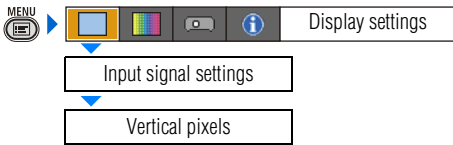

You can adjust the number of the pixels in the vertical direction if the length of the screen is too long or too short in the vertical direction.

Input signal settings	
Total dots	1688
Tracking	32
Horizontal position	231
Vertical position	1
Horizontal pixels	1920
Vertical pixels	1200

Use [\leftarrow] / [\rightarrow] to select a value.

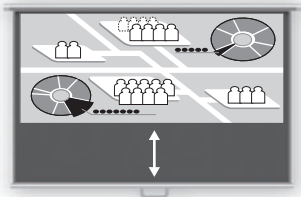

When you have completed the adjustment, press the **MENU** button.

- Perform this adjustment if the [AUTO PC] function (P50) cannot adjust the project image correctly.
- You can make adjustment either for [ANALOG PC-1] or [ANALOG PC-2].

Selecting HDMI Input Level

[HDMI input level]

- HDMI
- DIGITAL PC
- ANALOG PC
- COMPONENT
- VIDEO



You can select this as required when you project visual software with the HDMI signals.

HDMI	
Display settings	
Aspect	Auto
HDMI input level	Auto
HDMI over scan	Normal
Progressive	Expanded
Menu position	
Screen color	Normal
Image flip H/V	None
User screen settings	
Screen aspect	16:10

Press the **OK** button to accept your setting and then press the **MENU** button.

- [Auto] is the factory default.
- You can select this only when the type of signal sent from AV equipment is RGB.
- The signal level is select automatically in [Auto] mode. (Some AV equipment may not support this.)
- If the HDMI output of your AV equipment allows switching between [Normal] and [Expanded], we recommend you to set [Expanded]. The contrast of images will be improved and dark scenes will be rendered more realistically. In this case, select [Auto] or [Expanded] for the HDMI input level.

For more detailed information, refer to the User's Manual of your AV equipment connected to the projector.

Select HDMI Over Scan

[HDMI over scan]

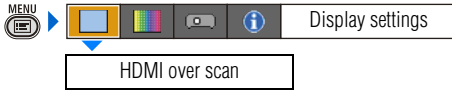

You can select this as required when you project visual software with the HDMI signals.

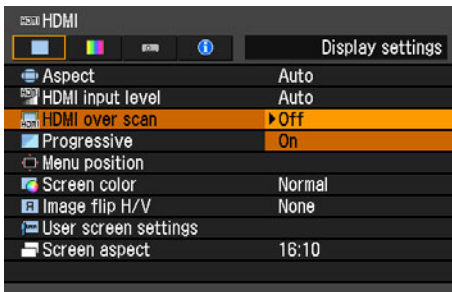

- Off** The entire input signals (100%) are projected. The images projected may be smaller than the full projection screen.
- On** Images are projected with disorders at their peripheral section of images trimmed off. (The central 95% of the images are projected.)
 A part of peripheral sections of images may be cut out depending on the resolution of the signals. In such a case, select [Off].

Press the **OK** button to accept your setting and then press the **MENU** button.

- [On] is the factory default.

Performing Progressive Processing

[Progressive]

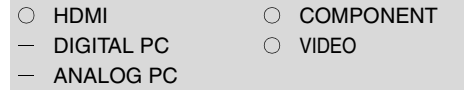

You can select this as required when the images have low resolution.

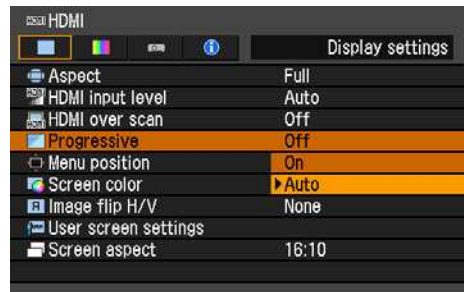

- Off** Do not perform the progressive processing.
- On** Performs the progressive processing. This mode is available when the HDMI signal is 1080i or, VIDEO or COMPONENT signal is 1080i, 1035i, 576i, or 480i.
- Auto** Performs the appropriate progressive processing according to the input signal.

Press the **OK** button to accept your setting and then press the **MENU** button.

- [Auto] is the factory default.
- You can set this mode for either [HDMI], [COMPONENT] or [VIDEO].
- Select [Off] when flickers and horizontal lines are noticeable on a fast-moving picture.
- For the details of the progressive processing, refer to the page [132](#).

Selecting a Menu Position

[Menu position]

- HDMI
- DIGITAL PC
- ANALOG PC
- COMPONENT
- VIDEO



You can change the position of menu displayed.

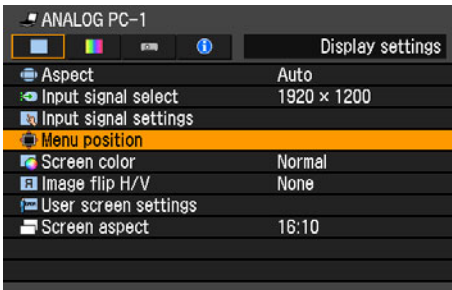

Move the menu to the desired position with [\wedge] / [\lt] / [\vee] / [\gt].



When the menu has been moved to the desired position, press the **OK** or **MENU** button.

Correcting the Screen Color

[Screen color]

- HDMI
- DIGITAL PC
- ANALOG PC
- COMPONENT
- VIDEO



You can adjust the color quality of the images projected corresponding to the color of the projection screen.

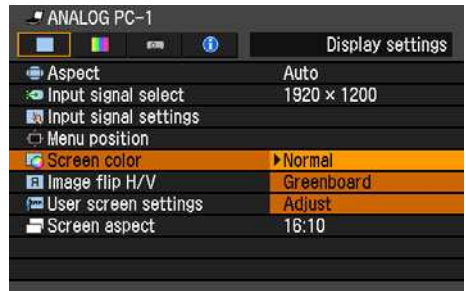

Normal Select this if a standard type of projection screen is used. The images are projected in the light quality similar to that of natural light.

Greenboard Select this if a greenboard (in dark green color) is used for the projection screen. The color quality similar to [Normal] is obtained on the greenboard.

Adjust Select this if you make detailed adjustment. The following popup screen will appear.

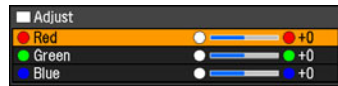

Use [\wedge] / [\vee] to select a primary color. [\gt] makes the color selected darker. [\lt] makes the color selected lighter. Press the **AUTO SET** button while the screen is displayed if you want to perform the auto color correction.

Press the **OK** button to accept your setting and then press the **MENU** button.

- [Normal] is the factory default.

Reversing projection

[Image flip H/V]

- HDMI COMPONENT
 DIGITAL PC VIDEO
 ANALOG PC



You can make this setting if you want to hang the projector from the ceiling or project an image from behind the screen.

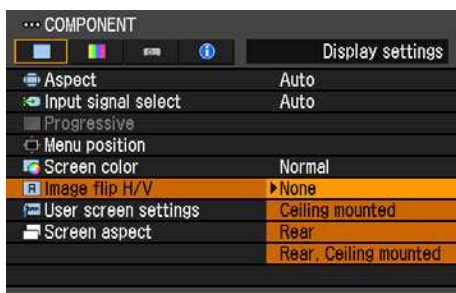

None	Select this if you project an image normally.
Ceiling mounted	Select this if you project an image with the projector hung from the ceiling. The projected images is inverted in both vertical and horizontal directions.
Rear	Select this if you project an image from behind the screen. The projected images is inverted in the horizontal direction.
Rear, Ceiling mounted	Select this if you project an image from behind the screen with the projector hung from the ceiling. The projected image is inverted in the vertical direction.

Press the **OK** button to accept your setting and then press the **MENU** button.

- [None] is the factory default.

None (Normal image)

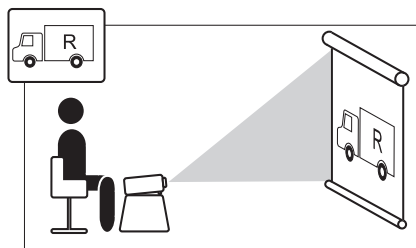

Ceiling mounted

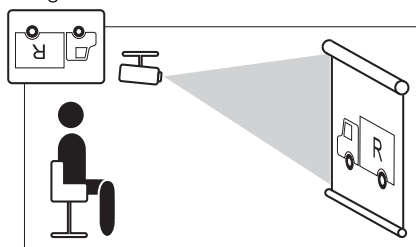

Rear

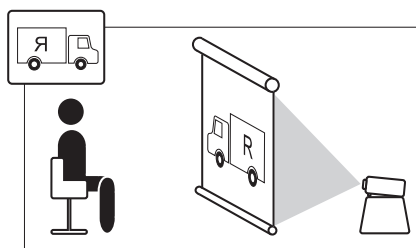

Rear, Ceiling mounted

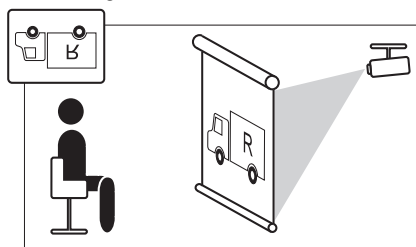

- To hang the projector from the ceiling, use the optional bracket. Contact your Canon dealer.
- The keystone distortion adjustment will be reset.

Capturing a Logo

[User screen settings] - [Logo capture]

- HDMI
- DIGITAL PC
- ANALOG PC
- COMPONENT
- VIDEO

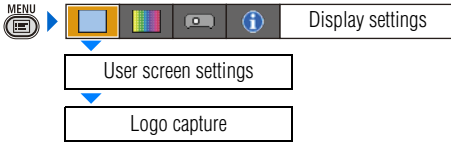

You can capture a part of the images being projected as [User logo].

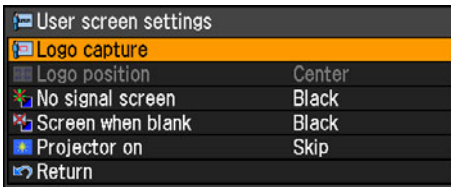

A screen for capturing images is displayed.

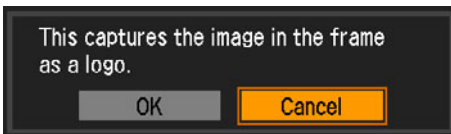

OK Press the **OK** button, and the image in the red frame is captured as [User logo].

Cancel Cancels the image capturing.

- For projecting the captured log on a screen, select [User logo] on the [Projector on], [No signal screen], [Screen when blank].
- You may not capture an image depending on the resolution and scan system.
- You cannot capture an image when [16:9], [16:9 D. image shift], or [4:3 D. image shift] is selected for [Screen aspect].

Selecting the User Logo Display Position

[User screen settings] - [Logo position]

- HDMI
- DIGITAL PC
- ANALOG PC
- COMPONENT
- VIDEO

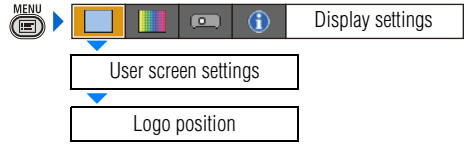

You can select a log display position.

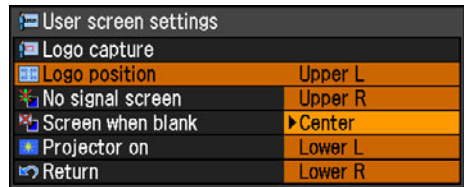

Upper L Select a position you want to display a user logo and press the **OK** button.

Upper R

Center

Lower L

Lower R

Press the **OK** button to accept your setting and then press the **MENU** button.

- [Center] is the factory default.
- You cannot select [Logo position] if you have not captured a user logo on the [Logo capture] screen.

No Signal Screen

[User screen settings] - [No signal screen]

- HDMI
- DIGITAL PC
- ANALOG PC
- COMPONENT
- VIDEO

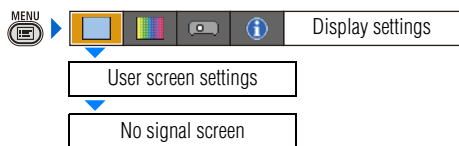

You can display a user logo on a screen when there is no input signal.

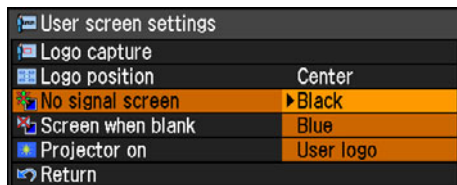

Black	The screen is all black. Displays no user logo.
Blue	The screen is blue background. Displays no user logo.
User logo	Displays a user logo.

Press the **OK** button to accept your setting and then press the **MENU** button.

- [Blue] is the factory default.
- [User logo] is available only when a user's logo has been registered.

Screen When Blank

[User screen settings] - [Screen when blank]

- HDMI
- DIGITAL PC
- ANALOG PC
- COMPONENT
- VIDEO

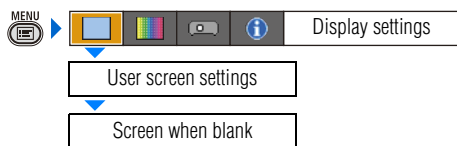

You can display a user logo a screen when the projected image is blacked out temporarily by pressing the **BLANK** button on the remote control.

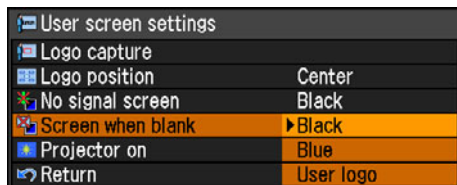

Black	The screen is all black. Displays no user logo.
Blue	The screen is blue background. Displays no user logo.
User logo	Displays a user logo.

Press the **OK** button to accept your setting and then press the **MENU** button.

- [Black] is the factory default.
- [User logo] is available only when a user's logo has been registered.

Selecting a Logo at Startup

[User screen settings] - [Projector on]

- HDMI
- DIGITAL PC
- ANALOG PC
- COMPONENT
- VIDEO

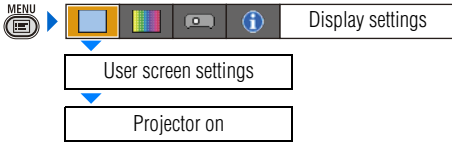

You can display a specified logo on a screen from the moment the projector is turned on to the moment it is ready for projection.

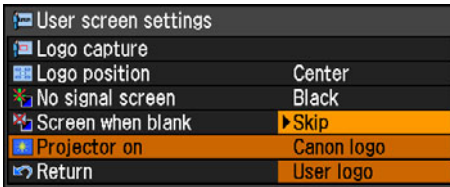

Skip	Projects an input signal immediately after turning on the projector.
Canon logo	Displays the Canon logo captured at the factory.
User logo	Displays a user logo captured on the [Logo capture] screen.

Press the **OK** button to accept your setting and then press the **MENU** button.

- [Canon logo] is the factory default.
- [User logo] is available only when a user's logo has been registered.

Selecting Aspect Ratio of Screen

[Screen aspect]

- HDMI
- DIGITAL PC
- ANALOG PC
- COMPONENT
- VIDEO



You can select proper option corresponding to the aspect ratio of the projecting screen. (P55)

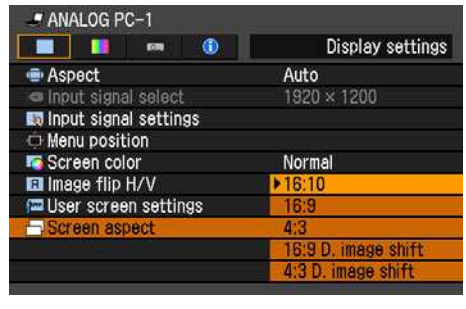

16:10	Select this when you use a screen with aspect ratio of 16:10.
16:9	Select this when you use a screen with aspect ratio of 16:9.
4:3	Select this when you use a screen with aspect ratio of 4:3.
16:9 D. image shift	Select this when you use a screen with aspect ratio of 16:9. You can move the screen upward or downward with D.SHIFT/KEystone button.
4:3 D. image shift	Select this when you use a screen with aspect ratio of 4:3. You can move the screen to the left or right with D.SHIFT/KEystone button.

Press the **OK** button to accept your setting and then press the **MENU** button.

- [16:10] is the factory default.
- If you select [16:9 D. image shift] or [4:3 D. image shift], the keystone adjustment will be reset. For more details, refer to the page 56.
- [Auto] may be automatically selected for [Screen aspect] depending on the screen aspect setting.

Setting the Image Quality

Selecting an Image Quality

[Image mode]

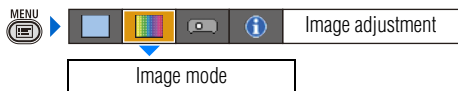

You can select an image mode suitable for the projecting image.

You can select it also with the **IMAGE** button on the remote control. (P61)



Press the **OK** button to accept your setting and then press the **MENU** button.

- [Standard] is the factory default.
- You can decide the image quality by adjusting the following items in each image mode: [Brightness], [Contrast], [Sharpness], [Gamma], [Color adjustment], [Advanced adjustment] and [Lamp mode].
- The adjustment you have made is stored as each combination of input signals and an image mode.

Standard	Select this to project an image with near-original quality and a high regard for reproduction of white. It is suited to showing a computer screen or watching visual software (moving pictures) in a bright room.
Presentation	Select this to project an image with quality suited for the presentation. It is also suited to project visual software (moving pictures) with a high regard for the brightness.
Movie	Select this to project moving pictures of all kinds. Its brightness is suited to easily enjoy the atmosphere of a movie theatre in a dim room.
sRGB	Select this if you want to project an image in the display mode conforming to the sRGB standard (P130). It is suited to project an image shot by sRGB-compatible digital camera.

Adjusting the Brightness

[Brightness]

- HDMI
- DIGITAL PC
- ANALOG PC
- COMPONENT
- VIDEO



You can adjust the brightness of images.

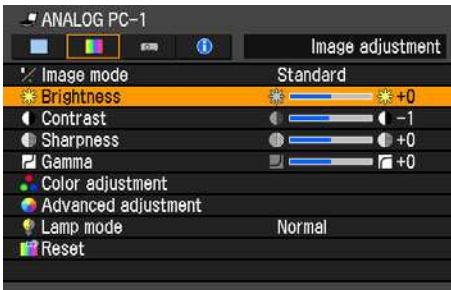

[>] Increases the brightness of an image.

[<] Decreases the brightness of an image.

When you have completed the adjustment, press the **MENU** button.

- The adjustment you have made is stored as an adjusted value of input signals being projected in an image mode.

Adjusting the Contrast

[Contrast]

- HDMI
- DIGITAL PC
- ANALOG PC
- COMPONENT
- VIDEO



You can adjust the contrast of images.

If you want to make it more or less vivid, adjust the difference in tone between the lightest and darkest portions of the image.

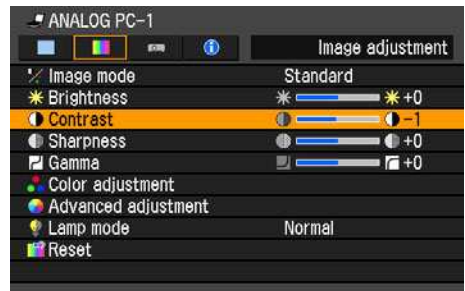

[>] Increases the contrast of an image. It emphasizes the darker portion and the bright portion on the projected image.

[<] Decreases the contrast of an image. The image becomes less vivid.

When you have completed the adjustment, press the **MENU** button.

- The adjustment you have made is stored as an adjusted value of input signals being projected in an image mode.

Adjusting the Sharpness

[Sharpness]

- HDMI COMPONENT
 DIGITAL PC VIDEO
 ANALOG PC



You can adjust the sharpness of images.

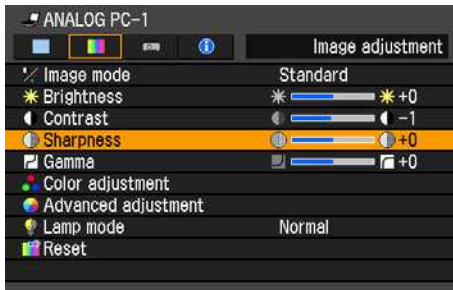

[>] Increases the sharpness of an image.

[<] Decreases the sharpness of an image.

When you have completed the adjustment, press the **MENU** button.

- The adjustment you have made is stored as an adjusted value of input signals being projected in an image mode.

Making a Gamma Correction

[Gamma]

- HDMI COMPONENT
 DIGITAL PC VIDEO
 ANALOG PC

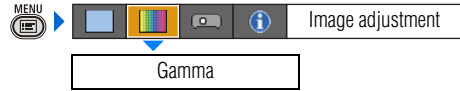

You can correct the obscure portion of an image due to too dark or bright.

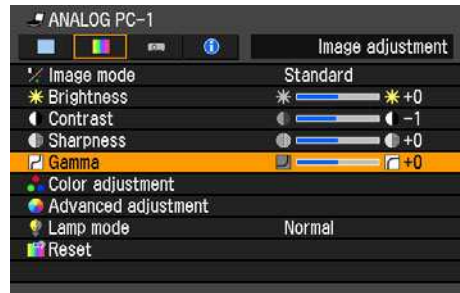

[>] Brighten the dark portion.

[<] Darken the bright portion.

When you have completed the adjustment, press the **MENU** button.

- The adjustment you have made is stored as an adjusted value of input signals being projected in an image mode.
- For the details of the gamma correction, refer to the page [132](#).

Making Color Adjustment (HDMI/DIGITAL PC/ANALOG PC)

[Color adjustment]

- HDMI — COMPONENT
- DIGITAL PC — VIDEO
- ANALOG PC

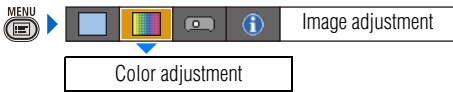

You can adjust the color quality of images for each of primary colors, red, green and blue.



R/G/B Gain Adjust the intensity of each color.
 [>] Increases the color intensity.
 [<] Decreases the color intensity.

R/G/B Offset Adjusts the color reproducibility of dark portions of each color.
 [>] Increases the color reproducibility of color.
 [<] Decreases the color reproducibility of color.

When you have completed the adjustment, press the **MENU** button.

- The adjustment you have made is stored as an adjusted value of input signals being projected in an image mode.
- Adjusting a color makes mark shown in [Color adjustment] in the menu.

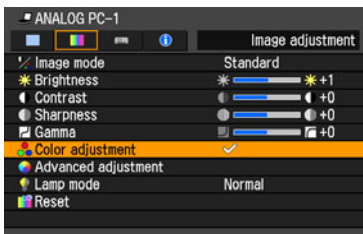

Making Color Adjustment (COMPONENT/VIDEO)

[Color adjustment]

- HDMI COMPONENT
- DIGITAL PC VIDEO
- ANALOG PC

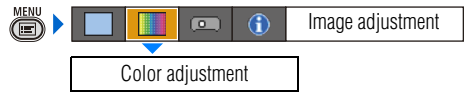

You can adjust the color depth and hue of images for each of primary colors, red, green and blue.

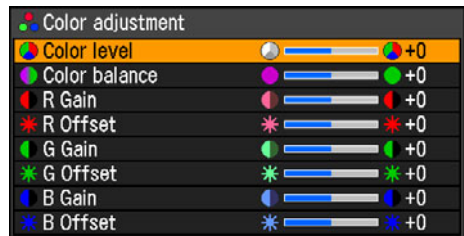

Color level Adjusts the intensity of each color.
 [>] Increases the intensity of color.
 [<] Decreases the intensity of color.

Color balance Adjusts the color balance of a reddish or greenish image.
 [>] Corrects a reddish image.
 [<] Corrects a greenish image.

R/G/B Gain The same as "Making Color Adjustment (HDMI/DIGITAL PC/ANALOG PC)".

R/G/B Offset The same as "Making Color Adjustment (HDMI/DIGITAL PC/ANALOG PC)".

When you have completed the adjustment, press the **MENU** button.

- You cannot adjust the color balance in [Video] except NTSC.
- The adjustment you have made is stored as an adjusted value of input signals being projected in an image mode.

Making Advanced Adjustment (Noise reduction)

[Advanced adjustment] - [Noise reduction]

- HDMI
- COMPONENT
- DIGITAL PC
- VIDEO
- ANALOG PC

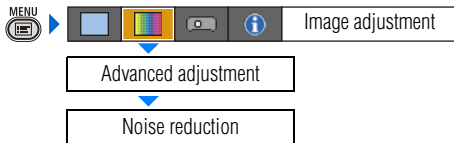

You can reduce noise of picture.

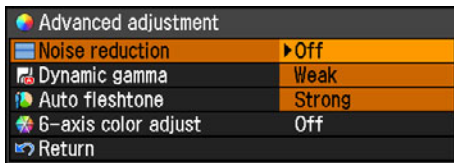

- Off** Disables noise reduction.
- Weak** Select this option for noisy picture.
- Strong** Select this option for excessively noisy picture.

Press the **OK** button to accept your setting and then press the **MENU** button.

- Noise reduction may produce an after-image for quick footage.
- Select [Weak] for quick footage. Select [Strong] for slow footage.
- The setting you have made is stored as a setting value of input signals being projected in an image mode.
- Making this setting makes mark shown in [Advanced adjustment] in the menu.

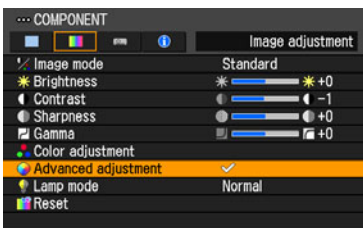

Making Advanced Adjustment (Dynamic gamma)

[Advanced adjustment] - [Dynamic gamma]

- HDMI
- COMPONENT
- DIGITAL PC
- VIDEO
- ANALOG PC

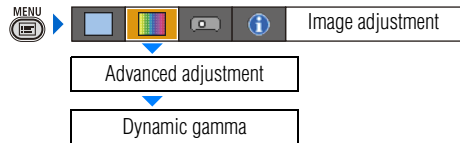

You can adjust the gradation representation of light and dark portions of an image automatically.

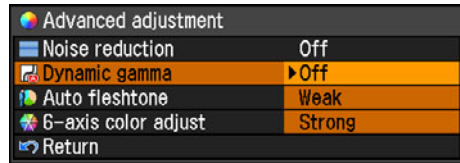

- Off** Dynamic gamma is disabled.
- Weak** Dynamic gamma is used a little.
- Strong** Dynamic gamma is used to a large extent.

Press the **OK** button to accept your setting and then press the **MENU** button.

- The adjustment you have made is stored as an adjusted value of input signals being projected in an image mode.

Making Advanced Adjustment (Auto fleshtone)

[Advanced adjustment] - [Auto fleshtone]

- HDMI
- DIGITAL PC
- ANALOG PC
- COMPONENT
- VIDEO

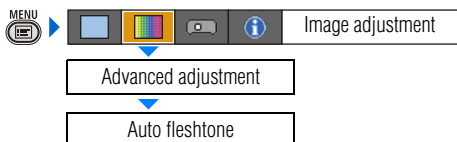

You can represent the skin color impressively.

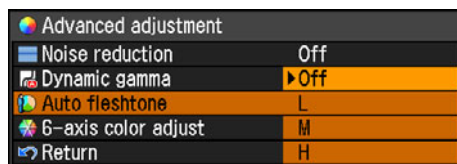

Off	Disables the [Auto fleshtone] function.
L	Specifies the intensity of the [Auto fleshtone] in three steps.
M	
H	

Press the **OK** button to accept your setting and then press the **MENU** button.

- The adjustment you have made is stored as an adjusted value of input signals being projected in an image mode.

Adjusting Fine Color Adjustment (6-axis color adjust)

[Advanced adjustment] - [6-axis color adjust]

- HDMI
- DIGITAL PC
- ANALOG PC
- COMPONENT
- VIDEO

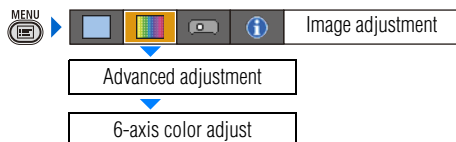

You can make fine color adjustment with RGB (red, green, blue) and CMY (cyan, magenta, yellow). For the details of 6-axis color adjust, refer to the page 133.

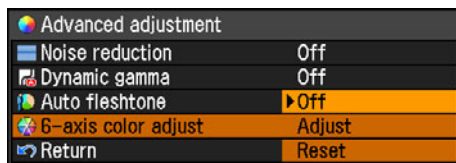

Off Disables the 6-axis color adjustment. If you select [Adjust], the previous setting of 6-axis color adjustment becomes active again.

Adjust Enables the 6-axis color adjustment.

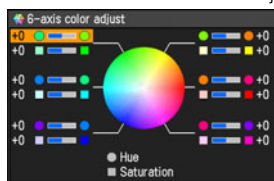

Use [\wedge] / [\vee] to select [\bigcirc Hue] or [\square Saturation], then adjust them with [$<$] / [$>$].

Reset Returns any adjustment values to zero.

When you have completed the adjustment, press the **MENU** button.

- [Off] is the factory default.
- The adjustment you have made is stored as an adjusted value of input signals being projected in an image mode.

Reducing the Lamp Brightness

[Lamp mode]

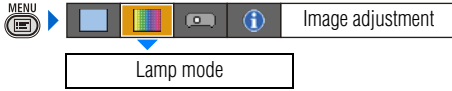
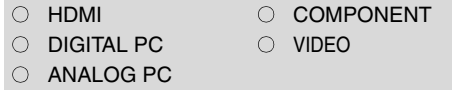

Reducing the lamp brightness reduces power consumption and cooling fan noise. You can enable or disable this mode also with the **LAMP** button on the remote control.

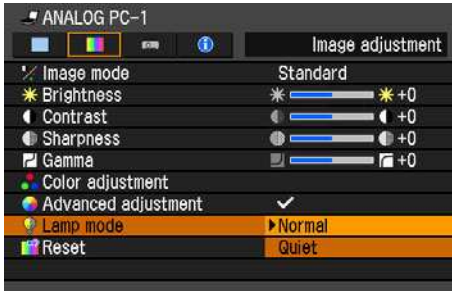

Normal Projects an image at the normal brightness level.

Quiet Reduces the lamp brightness and cooling fan noise.

Press the **OK** button to accept your setting and then press the **MENU** button.

- [Normal] is the factory default.
- The setting you have made is stored as a setting value of input signals being projected in an image mode.

Resetting the Image Settings

[Reset]



You can reset the current image settings to the default settings.

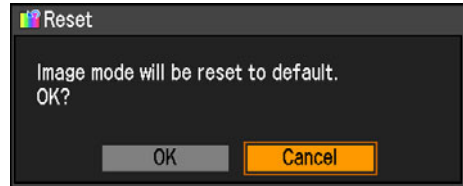

OK Resets the image settings.

Cancel Cancels resetting of the image settings.

Press the **OK** button to accept your setting and then press the **MENU** button.

- Only the setting of the combined input signals being projected and an image mode is reset.

Setting Various Function

Setting Auto Setup Function

[Auto setup]

- HDMI
- DIGITAL PC
- ANALOG PC
- COMPONENT
- VIDEO



You can select an items you want to enable in the auto setup function.



Select [On] for the items if you want to enable in auto setup function.

Auto focus	Enables the auto focusing.
Auto keystone	Enables the auto keystone correction.
Auto input	Enables the auto input selection.
Auto screen color	Adjusts color quality of images corresponding to the color of the projection screen.

Press the **OK** button to accept your setting and then press the **MENU** button.

- The factory default settings are as follows:
 - [Auto focus]: [On]
 - [Auto keystone]: [On]
 - [Auto input]: [On]
 - [Auto screen color]: [Off]
- You cannot change any items in [Auto setup] if [16:9 D. image shift] or [4:3 D. image shift] is selected for [Screen aspect]. In addition, you cannot perform the auto setup function. For the details of the [Auto setup], refer to the page 45.

Selecting the Power Management Mode

[Power management mode]

- HDMI
- DIGITAL PC
- ANALOG PC
- COMPONENT
- VIDEO

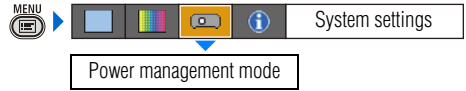

You can turn off the lamp or projector automatically for saving power.

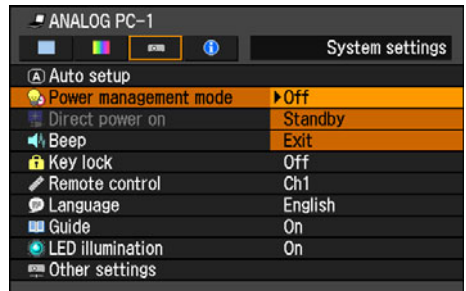

Off	Disables the power management mode.
Standby	If no input signal is received for 30 seconds, the projector enters the standby mode, turning off the lamp five minutes after start of countdown. If it receives the input signal or is operated during such period of 30 seconds, it resumes projection.
Exit	If no input signal is received for 30 seconds, it displays the count down and turns off the projector after 5 minutes.

Press the **OK** button to accept your setting and then press the **MENU** button.

- [Off] is the factory default.
- The **POWER** indicator flashes red and green when the projector is in the [Standby] power management mode.
- You cannot enable the [Direct power on] function (see the next item), if you select [Off].

Skip the POWER Button Operation

[Direct power on]

- HDMI COMPONENT
 DIGITAL PC VIDEO
 ANALOG PC

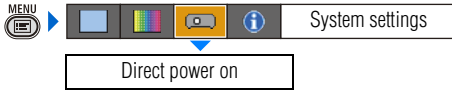

You can turn on the projector only by connecting the power cable without pressing the **POWER** button.

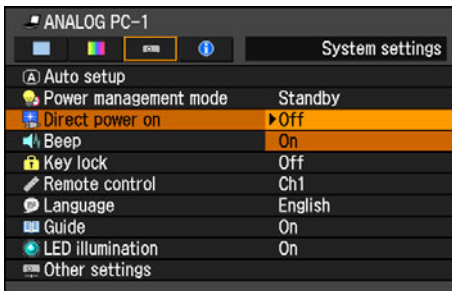

Off You need to press the **POWER** button to turn on the projector.

On You can turn on the projector only by connecting the power cable.

Press the **OK** button to accept your setting and then press the **MENU** button.

- [Off] is the factory default.



- Before setting the direct power-on to [On], be sure to set the [Power management mode], described on the preceding page, to [Standby] or [Exit].
- Wait at least 5 minutes when you power on the projector again after disconnecting it. It may shorten the lamp life if you turn on the projector immediately after turning it off.

Enabling/Disabling the Beep

[Beep]

- HDMI COMPONENT
 DIGITAL PC VIDEO
 ANALOG PC



You can select whether a beep sounds or not when you operate the projector.

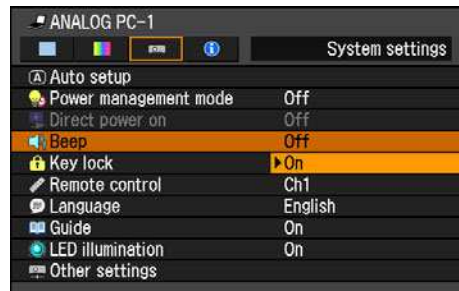

Off Disables the beep.

On Enables the beep.

Press the **OK** button to accept your setting and then press the **MENU** button.

- [On] is the factory default.
- It does not beep if you mute the projector sound with the **MUTE** button on the remote control.

Prohibiting the Projector Operation

[Key lock]

- | | |
|----------------------------------|---------------------------------|
| <input type="radio"/> HDMI | <input type="radio"/> COMPONENT |
| <input type="radio"/> DIGITAL PC | <input type="radio"/> VIDEO |
| <input type="radio"/> ANALOG PC | |

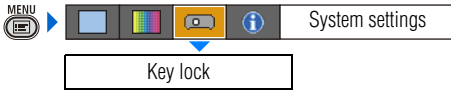

You can prohibit the operation of the projector from either the top control or remote control.

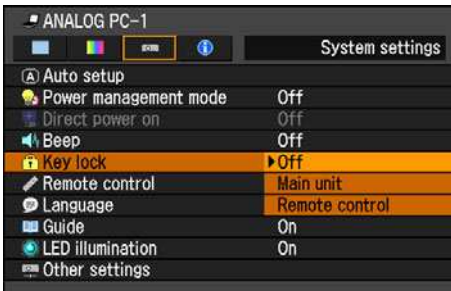

Off	Disables the key lock.
Main unit	Prohibit the operation from the main unit. Use the remote control.
Remote control	Prohibit the operation from the remote control. Use the main unit.

Press the **OK** button to accept your setting and then press the **MENU** button.

- [Off] is the factory default.



The key lock function becomes effective from the moment the **OK** button is pressed after selecting [Main unit] or [Remote control]. Be sure to press the **OK** button on the top control or remote control which is not locked.

To Unlock Key Lock Function

Turn off the projector and unplug the power plug. Hold down the **OK** button on the top control and connect the power plug. Make sure to keep holding down the **OK** button until a beep sounds. The key lock is unlocked.

Setting up the Remote Control Channel

[Remote control]

- | | |
|----------------------------------|---------------------------------|
| <input type="radio"/> HDMI | <input type="radio"/> COMPONENT |
| <input type="radio"/> DIGITAL PC | <input type="radio"/> VIDEO |
| <input type="radio"/> ANALOG PC | |



You can set different channels to different remote controls, if you use two projectors at the same time.

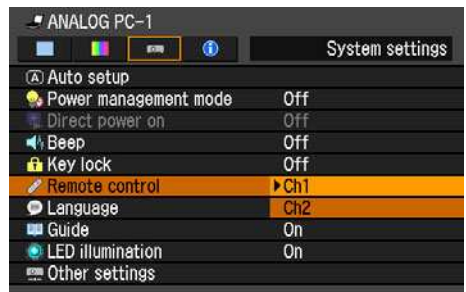

- Ch1** Select the channel of the remote control used for this projector, and press the **OK** button.
- Ch2** button.

Press the **OK** button to accept your setting and then press the **MENU** button.

- The factory default is [Ch1] for both projector and remote control.
- After changing the channel on the menu, be sure to change the channel of the remote control, too.

Selecting a Channel on the Remote Control

You can change the channel on the remote control as follows:

- Ch1** Press the **OK** button and [\wedge] for 3 seconds at the same time.
- Ch2** Press the **OK** button and [$\>$] for 3 seconds at the same time.

Selecting a Display Language

[Language]

- HDMI COMPONENT
 DIGITAL PC VIDEO
 ANALOG PC



You can select the language in which the menu is displayed.

Language		
▶ English	Русский	Čeština
Deutsch	Nederlands	Dansk
Français	Suomi	إنجليزي
Italiano	Norsk	中文简体
Español	Türkçe	中文繁體
Português	Polski	한국어
Svenska	Magyar	日本語

Use [^] / [v] / [<] / [>] to select the language to be used in the menu, then press the OK button.

English	English
Germany	Deutsch
French	Français
Italian	Italiano
Spanish	Español
Portuguese	Português
Swedish	Svenska
Russian	Русский
Dutch	Nederlands
Finnish	Suomi
Norwegian	Norsk
Turkish	Türkçe
Polish	Polski
Hungarian	Magyar
Czech	Čeština
Danish	Dansk
Arabic	إنجليزي
Chinese (Simplified)	中文简体
Chinese (Traditional)	中文繁體
Korean	한국어
Japanese	日本語

When the setting is completed, press the MENU button.

Showing/hiding the Guide Screen

[Guide]

- HDMI COMPONENT
 DIGITAL PC VIDEO
 ANALOG PC



You can select whether to show or hide the guide screen which explains operations.

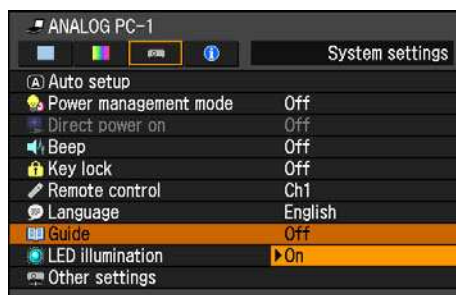

Off Hides the guide screen.

On Shows the guide screen.

Press the OK button to accept your setting and then press the MENU button.

- [On] is the factory default.
- The guide screen is shown when:
 - Power is turned off by pressing the POWER button (P62).
 - No input signal can be detected (P44).
 - An invalid button is pressed in the [BLANK], [FREEZE], or [D.ZOOM] mode (P64, 66).

Turning on/off LED Illumination

[LED illumination]

- HDMI
- COMPONENT
- DIGITAL PC
- VIDEO
- ANALOG PC

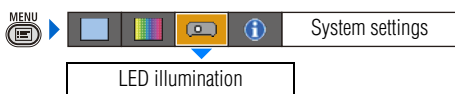

You can select whether to enable or disable the LED illumination (P26).

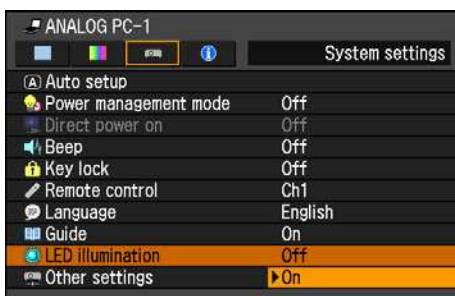

Off Disables the LED illumination.

On Enables the LED illumination.

Press the **OK** button to accept your setting and then press the **MENU** button.

- [On] is the factory default.
- LED illumination is unrelated to turning on/off of the **POWER** or **WARNING** lamp.

Extending the Menu Display Time

[Other settings] - [Menu display time]

- HDMI
- COMPONENT
- DIGITAL PC
- VIDEO
- ANALOG PC

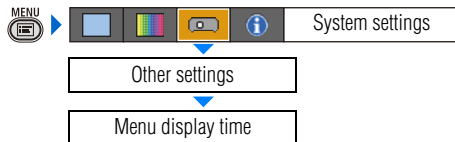

You can extend the menu display time, which is 30 seconds usually, to 3 minutes.

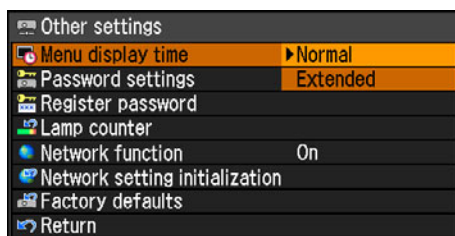

Normal The menu is displayed for 30 seconds.

Extended The menu is displayed for 3 minutes.

Press the **OK** button to accept your setting and then press the **MENU** button.

- [Normal] is the factory default.
- You cannot extend the display time for the window indicating the completion of Auto setup (P46), the guide window (P95), the lamp replacement window (preparation) (P123), or the lamp replacement window (warning) (P123).
- You cannot use the button holding operation in the keystone adjustment.

Setting a Password

[Other settings] - [Password settings]

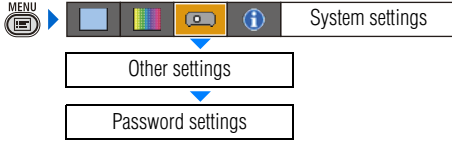

Disables the projector unless the correct password is entered.

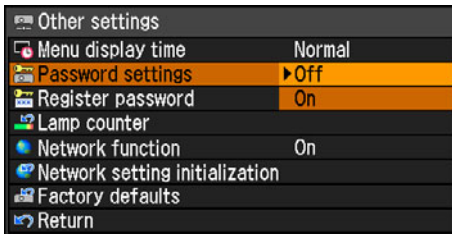

Off	The projector can be used even if no password is entered.
On	The projector cannot be used unless you enter your password.

Press the **OK** button to accept your setting and then press the **MENU** button.

- [Off] is the factory default.
- You cannot set [On] unless you have completed [Register password].

Once you set a password, the password entry screen appears at power-on.

Enter a 4-digit password with [\wedge] / [\vee] / [\lt] / [\gt]. If the password is valid, the projection starts. If you enter a wrong passwords three times, the power will be turned off.

- The power is also turned off if no password is inputted for 3 minutes.

To Cancel the Password

Turn off the projector and unplug the power plug. Hold down the **MENU** button on the top control and connect the power plug. Make sure to keep holding down the **MENU** button until a beep sounds. The password is cancelled (the registered password is also reset).

Registering a Password

[Other settings] - [Register password]

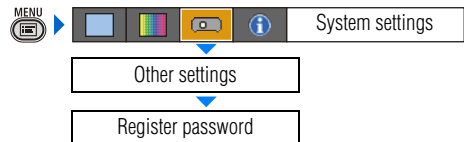

You can register a password for starting projection.

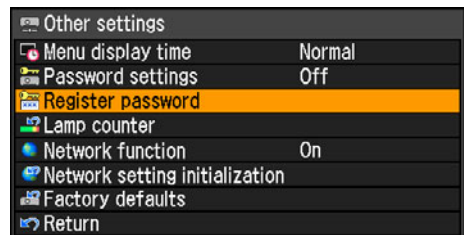

Press the **OK** button after selecting [Register password], and the following screen for registering a password appears:

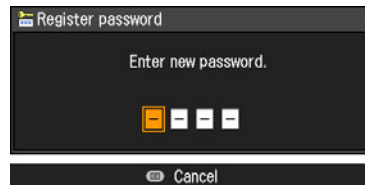

Enter a 4-digit password using [\wedge] / [\lt] / [\vee] / [\gt] (e.g., $\wedge\wedge\wedge\wedge$, $\lt\lt\lt\lt$, $\wedge\vee\lt\gt$). The 4-digit password is entered from the left to right digits, the password is automatically registered.

- Press the **MENU** button to abort the registration.

Resetting the Lamp Counter

[Other settings] - [Lamp counter]

- HDMI
- COMPONENT
- DIGITAL PC
- VIDEO
- ANALOG PC

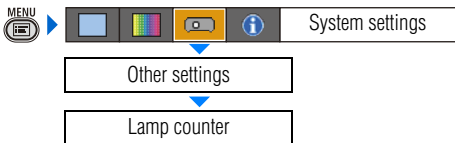

You can reset the lamp counter that indicates the timing to replace the projector when you replace it.

! Do not reset the lamp counter except when you have replaced the lamp. Otherwise, the lamp counter cannot indicate the correct timing for replacing the lamp. For the details of the lamp replacement, refer to the page 124.

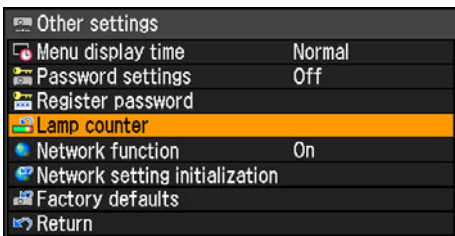

Press the **OK** button after selecting [Lamp counter], and the lamp counter is displayed.

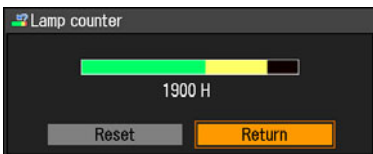

Select the [Reset] and press the **OK** button.

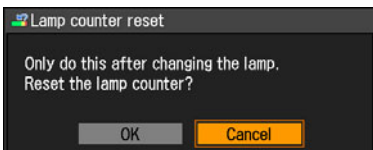

Select **[OK]** on the screen for confirmation, press the **OK** button, and the lamp counter is reset.

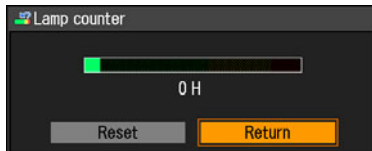

Press the **MENU** button.

■ About the Display of the Lamp Counter

The lamp counter displays the hours of use of the lamp in the following way:

Less than 1,800 hours
Displayed in green bar.

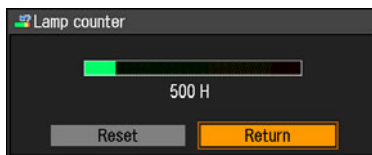

1,800 – less than 2,000 hours
Displayed in green and yellow bar.

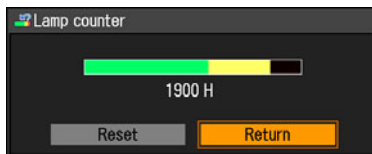

For 1,800 - 1,900 hours, a message "Obtain a new lamp." appears when power is turned on.

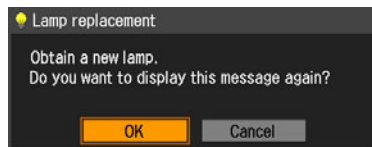

Over 2,000 hours
Displayed in green, yellow and red bar.

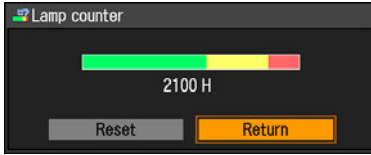

A message "Replace with the new lamp." appears when power is turned on.



Turning On/Off the Network Function

[Other settings] -[Network function]

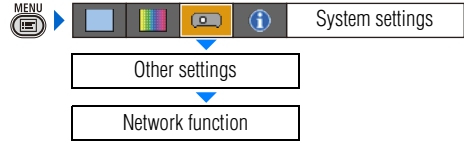

You can save power if you turn off the network function when you don't use the network function.

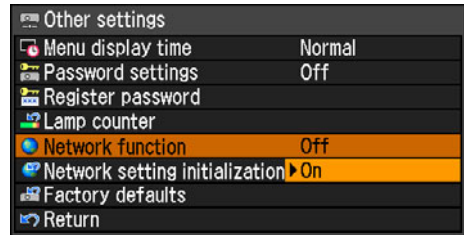

Off	You can save energy by disabling the network function.
On	You can enable the network function.

Press the **OK** button to accept your setting and then press the **MENU** button.

- [Off] is the factory default.

Initializing network settings

[Other settings] - [Network setting initialization]

- HDMI
- DIGITAL PC
- ANALOG PC
- COMPONENT
- VIDEO

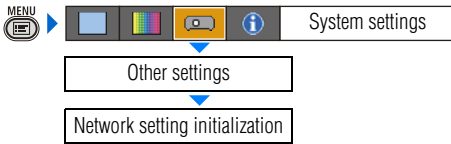

You can Initialize the network settings.

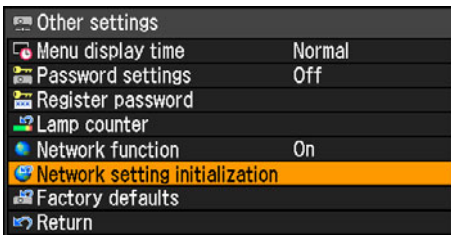

Press the **OK** button after selecting [Network setting initialization], and the following screen for confirmation appears:

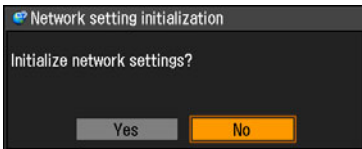

- | | |
|-----|--------------------------------------|
| Yes | The network settings is initialized. |
| No | Initialization is aborted. |

Press the **OK** button to accept your setting and then press the **MENU** button.

- Initialized are "IP address" and other items set in "Connecting the Projector to Network" (P103).
- You can do this initialization also from a Web browser. (P112)

Resetting to the Default Setting

[Other settings] - [Factory defaults]

- HDMI
- DIGITAL PC
- ANALOG PC
- COMPONENT
- VIDEO

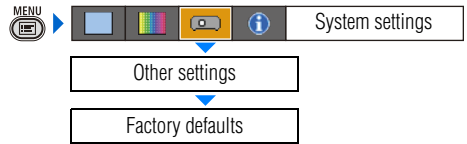

You can reset the menu item settings and restore the system settings to the factory defaults.

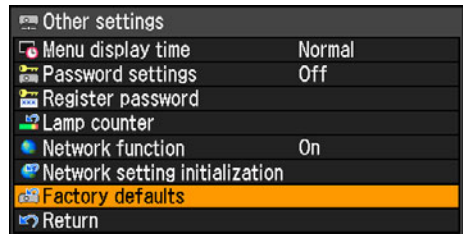

Press the **OK** button after selecting [Factory defaults], and the following screen for confirmation appears:

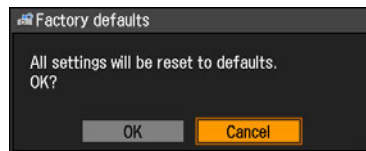

- | | |
|--------|------------------------------------|
| OK | Settings are reset to default. |
| Cancel | Settings are not reset to default. |

Press the **OK** button to accept your setting and then press the **MENU** button.

- This function cannot reset the value of [Lamp counter], [Language], [Remote control], [Input signal] and [Network setting] to default.
- For factory defaults settings, refer to the page [142,143](#).

Checking the Information of the Projector

[Information]

- HDMI
- DIGITAL PC
- ANALOG PC
- COMPONENT
- VIDEO



You can confirm the information about the signal types of the images projected and other projector-specific information.



Information shown

Item	Meaning
Model name	Model name of this projector
Input signal	Details of the input signal currently selected "Type of signal", "resolution of signal", "frequency" and other information is shown.
Firmware	Current firmware version
Serial no.	Serial number unique to this projector
IP address	Details of the network settings (P106)
Gateway address	[Not set] is shown for an item having no settings.
E-mail sender address	
E-mail recipient address	
Projector name	ID of this projector on the network
System information ID	This is an item of system information. Normally this is not displayed.

Connecting the Projector to Network

Table of Contents

Safety Instructions

Before Use

Projecting an Image

Useful Functions Available During a Presentation

Setting Up Functions from Menus

Connecting the Projector to Network

Appendix

Index

Setting an IP Address

It is possible to send an error notification e-mail (P113) from the projector to the computer when you connect the projector to the network.

To connect via the network, an IP address must be assigned to the projector. Set an IP address by following the steps below. (The examples shown are Windows XP screenshot images.)

■Setting IP Address of the Computer

- 1 Connect the projector and a computer directly via a cross or straight type LAN cable.

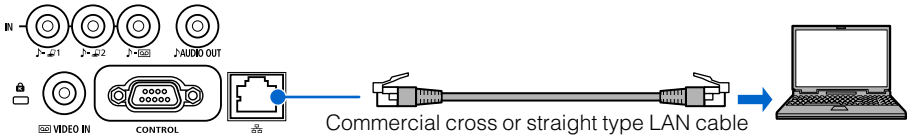

- 2 Turn on the power of the projector and computer.
- 3 Select [On] for [Network function] in the projector menu. (P99)
- 4 Open [Control Panel] from the [Start] menu, then select [Network and Internet Connections] - [Network Connections].
- 5 Right-click [Local Area Connection], and open [Properties].
- 6 Select [Internet Protocol (TCP/IP)] and click the [Properties] button. Take notes of the original network settings (IP address, subnet mask, DHCP settings, etc).
- 7 Select [Use the following IP address] and set as follows:
[IP address]: 192.168.254.1
[Subnet mask]: 255.255.255.0

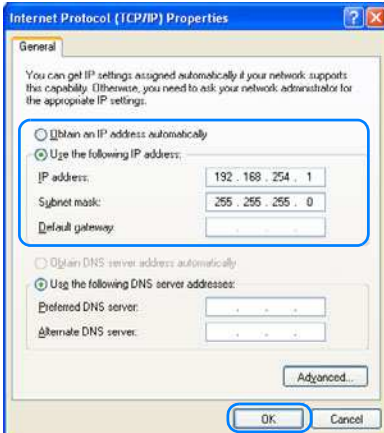

- 8 When you have specified the settings, click the [OK] button and then click the [OK] button on the [Local Area Connection Properties] window to close it.

■ Resetting the IP Address Setting of the Computer

- 1 Turn off the projector and remove the LAN cable.
- 2 Follow the step 3 to 6 to restore the network setting to the original setting.

Setting Network

■ Displaying the Network Configuration Screen

- 1 Turn on the computer and projector.
- 2 Launch a web browser, enter "http://192.168.254.254" in the address bar, and press the Enter key.
The password input screen appears.
The supported web browsers is Microsoft Internet Explorer 6 or later.
- 3 In the password input screen, enter "root" for [User name] and "system" for [Password] and click the [OK] button.

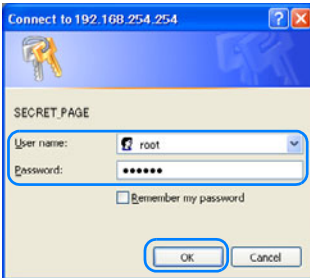

The projector network configuration screen appears on the web browser. The following information is displayed.

- [Projector name]: The name of the projector on the network
- [MAC address]: The MAC address of the projector
- [IP address]: The IP address of the projector
- [Power Status]: The power status of the projector
- [Lamp Time Normal Mode]: The total lamp used time in its normal mode
- [Lamp Time Quiet Mode]: The total lamp used time in its quiet mode
- [Lamp Time Converted]: The total lamp used time (converted value)
- [Filter Time]: The total filter used time

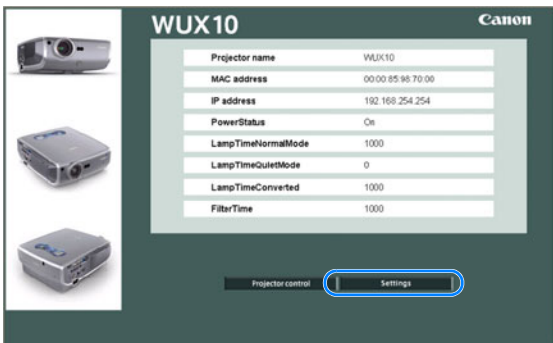

Click the [Settings] button to display the menu screen.

■ Setting the Network

- 1 In the menu screen, click [Password], input the new user name and password, and click the [OK] button.

Setting items:

[User name]: The user name for logging in the network

[New password]: The new password

[Confirm new password]: The password for confirmation

The screenshot shows the WUX10 network settings interface. The title bar reads 'WUX10 WUX10 Password'. On the left, a menu lists 'Apply', 'Initialize', 'Password', 'TCP/IP', 'Mail', 'Mail auth', 'Send test mail', 'SNMP', and 'Projector name'. The 'Password' option is highlighted with a blue circle. The main area contains three input fields: 'User name' with the value 'root', 'New password' with masked characters '*****', and 'Confirm new password' with masked characters '*****'. A note below the fields states '4 - 15 characters'. 'OK' and 'Cancel' buttons are at the top right.

- 2 Click [TCP/IP], enter appropriate values in the following field, and click the [OK] button.

Setting items:

[IP address]: The IP address of the projector

[Subnet mask]: The subnet mask of the projector

[Default gateway]: The default gateway of the projector

The screenshot shows the WUX10 network settings interface. The title bar reads 'WUX10 WUX10 TCP/IP'. On the left, a menu lists 'Apply', 'Initialize', 'Password', 'TCP/IP', 'Mail', 'Mail auth', 'Send test mail', 'SNMP', and 'Projector name'. The 'TCP/IP' option is highlighted with a blue circle. The main area contains three input fields: 'IP address' with the value '192.168.254.254', 'Subnet mask' with the value '255.255.255.0', and 'Default gateway' with the value '0.0.0.0'. 'OK' and 'Cancel' buttons are at the top right.

3 Click [Mail], enter appropriate values in the following field for the error report, and click the [OK] button.

Setting items:

- [To:]: The E-mail address to which the error report is sent (Within 63 alphanumeric characters)
- [Cc:]: The E-mail address to which the carbon copy of the error report is sent (Within 63 alphanumeric characters, can be omitted)
- [From:]: The sender of the E-mail (the projector)
- [SMTP server IP address]: The IP address of the available SMTP mail server
- [SMTP server port number]: The port number of the available SMTP mail server
- [SMTP server IP address]: The IP address of the available SMTP mail server (can be omitted)
- [Time zone]: The time zone of the installation site
- [Mail resend interval]: The E-mail resending interval at a transmission failure
Setting range: 0 - 59 seconds (the factory default: 10 seconds)
- [Mail resend times]: The number of E-mail resending attempts at a transmission failure
Setting range: 0 - 255 times (the factory default: 3 times)
- [Error report]: Turning ON/OFF the error report sending function (the factory default: [OFF])

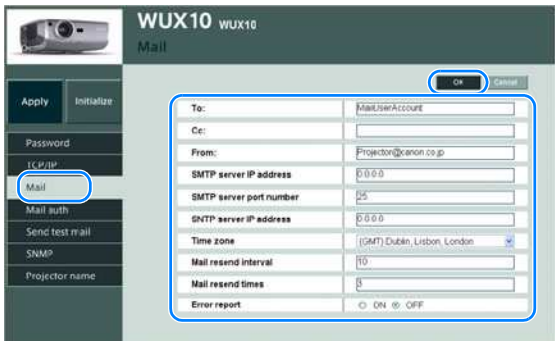

4 If the SMTP mail server authentication is required, click [Mail auth], enter appropriate values in the following field, and click the [OK] button.

Select one of the following four authentication method in [Mail authentication]. Select [OFF] if the mail authentication is not required (the factory default is [OFF]).

[LOGIN (SMTP authentication)], [CRAM-MD5 (SMTP authentication)], [USER/PASS (POP before SMTP)], [APOP (POP before SMTP)]

Setting items:

[User name]: The user name for the mail authentication

[Password]: The password for the mail authentication

[Confirm password]: The password for confirmation

[POP3 server IP address]: The IP address of the POP3 server

[POP3 server port number]: The port number of the POP3 server
(The factory default: 110)

[POP before SMTP response time]: The wait time between the POP3 authentication and the transmission to the SMTP mail server
(millisecond, the factory default: 300)

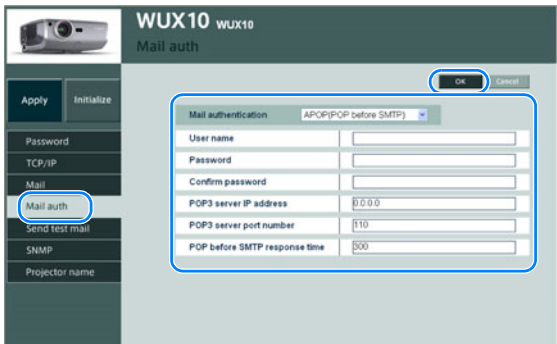

5 If you want to monitor the projector, click [SNMP], enter appropriate values in the following field, and click the [OK] button.

Select one of the following four SNMP version in [SNMP]. Select [OFF] if you don't want to monitor the projector.

(The factory default: [OFF])

[V1], [V2c], [V3 (MD5)], [V3 (DES, MD5)]

Setting items:

- [Receive community]: The name of the community (user)
- [Password]: The password for the community setting
- [Confirm password]: The password for confirmation
- [SNMP trap]: Conditions for sending the SNMP trap
- [Trap IP address]: The IP address to which the SNMP trap is sent
- [Trap community]: The name of the community (user) to which the SNMP trap is sent

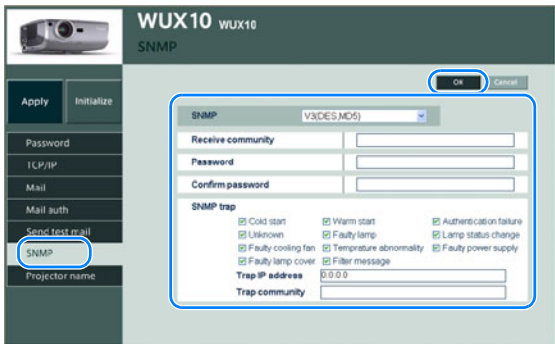

What is the SNMP Agent Function?

This projector supports the SNMP (Simple Network Management Protocol) agent function that monitors the status of the projector. SNMP consists of the manager (a monitoring tool, your PC) and agent (a monitored target, the projector).

The information exchange group via SNMP is called "a community." The message which tells the status of the agent is called "a SNMP trap."

This projector has the following SNMP traps:

- coldStart: it tells the SNMP agent is under initialization.
- warmStart: it tells the SNMP agent is under reset (at the SNMP version upgrade).
- authentication Failure: it tells that it failed the SNMP authentication.
- faultyLamp: it tells that a lamp-related error was occurred.
- faultyPowerSupply: it tells that a power supply-related error was occurred.
- temperatureAbnormality: it tells that a temperature-related error was occurred.
- lampStatusChange: it tells that the status of the lamp used time was changed.
- faultyCoolingFan: it tells that a cooling fan-related error was occurred.
- faultyLampCover: it tells that a lamp cover-related error was occurred.

- filterMessage: it tells that the air filter has reached its replacement timing.
 - UnknownError: it tells that an unknown error was occurred.
- Make sure to install the SNMP manager program on your PC before using the SNMP agent function.

Authentication and Encryption Protocols

SNMP V3 for the projector uses the DES-CBC for the authentication and encryption protocols.

- 6** Click [Projector name], enter the projector name, and click the [OK] button.
The factory default is [WUX10].



- 7** Click [Apply] when you have completed each menu.



Click the [OK] button when the following dialog box is displayed.



The network setting of the projector is now completed.
If you want to test the error report transmission, click [Send test mail].

■ Resetting the Network Setting

- 1 Click [Initialize] in the menu screen.



- 2 Click the [OK] button when the following dialog box is displayed.

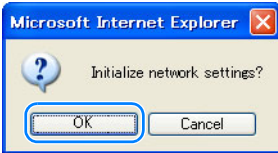

If you want to restore to the factory setting from the projector, perform [Network setting initialization] from the menu.

■ Error Notification Message

It sends the following message when an error occurs in the projector.

Error list

Errors related to temperature	Error name	Temperature abnormality
	Text	The temperature inside the projector is too high for some reason or the outside air temperature is higher than the specified one. If the problem is inside the projector, check whether the projector is installed and operated normally, turn off the projector to cool its inside, and retry projection. If the same warning occurs again, the projector may be defective. Contact your dealer.
Errors related to the lamp	Error name	Faulty lamp
	Text	The lamp has burnt out. Replace the lamp with a new one. If the same warning occurs again, the lamp drive circuit may be defective. Contact your dealer.
Errors related to the lamp cover	Error name	Faulty lamp cover
	Text	The lamp cover is open. Check whether the lamp cover is installed properly. If it is installed properly, the lamp cover detection switch may be defective. Contact your dealer.
Errors related to the cooling fan	Error name	Faulty cooling fan
	Text	The cooling fan or another component may be defective. Contact your dealer.
Errors related to the power supply	Error name	Faulty power supply
	Text	The voltage of part of the power supply is abnormally high or any other problem has occurred in the power supply. Contact your dealer.
Other types of errors	Error name	Unknown Error
	Text	Codes in hexadecimal numbers*

* Contact your Canon dealer.

■ Projector Control

1 Click the [Projector control] button on the network setting screen.

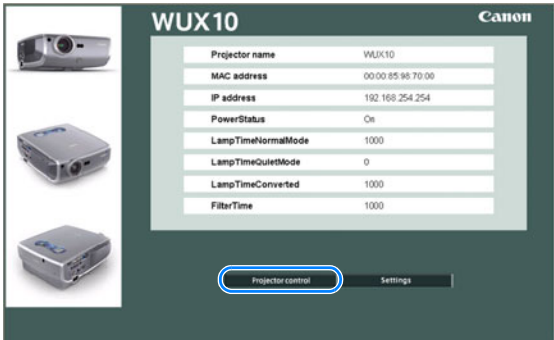

The projector control screen appears.

Controlled items:

- [Power]: Turn ON/OFF the projector (P42, P62)
- [Input]: Select an input signal (P47)
- [Aspect]: Select an aspect ratio (P55)
- [Image mode]: Select an image mode (P61)
- [Blank]: Blank out the image temporarily (P64)
- [Mute]: Mute the sound temporarily (P65)
- [Auto setup]: Perform the auto setup function (P45)
- [Auto PC]: Perform the auto PC function (P50)

- For [Input], [Aspect], and [Image mode], select an item and click the [Apply] button.
- Click the [Refresh] button to display the latest information.
- Click the [Back] button to return to the network setting screen.

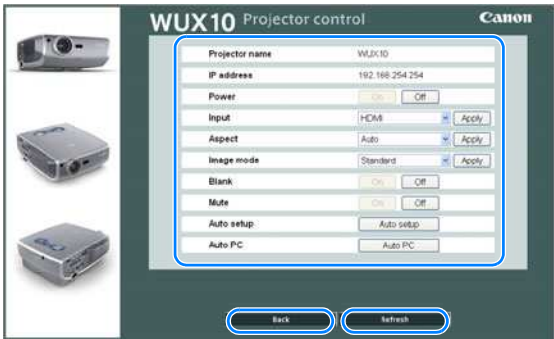

Appendix

Table of Contents

Safety Instructions

Before Use

Projecting an Image

Useful Functions Available During a Presentation

Setting Up Functions from Menus

Connecting the Projector to Network

Appendix

Index

WARNING Lamp Flash Patterns

The WARNING lamp on the Control Panel flashes in red when there is a trouble in the projector.

- Turn off the projector, wait until the cooling fan stops, and disconnect the power plug from the AC outlet before dealing with the trouble.

Flash Pattern	Meaning	Countermeasure
One flash	Temperature, abnormality	The temperature inside the projector is too high for some reason or the outside air temperature is higher than the specified one. If the problem is inside the projector, check whether the projector is installed and operated normally, turn off the projector to cool its inside, and retry projection. If the air intake or exhaust vent is blocked, remove the obstacle. If the same warning occurs again, the projector may be defective. Contact your dealer.
Two flashes	Faulty lamp	The lamp has burnt out. Replace the lamp with a new one. If the same warning is experienced again, the lamp drive circuit may be defective. Contact your dealer.
Three flashes	Faulty lamp cover	The lamp cover is open. Turn off the projector and unplug it from the power outlet, then install the lamp cover and turn on the projector again. If the lamp cover has been installed properly, the lamp cover detection switch may be defective. Contact your dealer.
Four flashes	Faulty cooling fan	The cooling fan or another component may be defective. Contact your dealer.
Five flashes	Faulty power supply	The abnormal voltage is applied to some parts in the power supply or any other failure may be occurred. Turn off the projector and unplug it from the power outlet, then plug it to the outlet and turn on the projector again. Contact your dealer if the same warning is given.

Symptoms and Solutions

■ You cannot turn on the projector.

Cause	Countermeasure
The power cord is not connected correctly.	Check whether the power cord is connected correctly. (P42) Check that [Key lock] is not enabled. (P94)
The power cord has just been connected.	You cannot turn on the projector until the POWER indicator turns red after connecting the power plug. (P42)
The lamp cover is open.	Unplug the power cord from the power outlet and correctly install the lamp cover and then turn on the projector again.
The safety device has activated because you put the projector in the carrying bag during the cooling fan was rotating.	When the safety device is active, the POWER lamp does not turn on when you connect the power cord. You cannot release the safety device. Contact your dealer.
The safety device is activated because the air intake or the exhaust vent is blocked and the internal temperature of the projector is increased.	When the safety device is active, the POWER lamp does not turn on when you connect the power cord. You cannot release the safety device for safety reason. Remove any obstacle that is blocking the air intake or exhaust vent and contact your dealer.

■ You cannot project an image from the projector.

Cause	Countermeasure
Any connection cable is connected incorrectly.	Check whether the projector is connected to the computer or AV equipment correctly. (P34, P47)
20 seconds have not passed since the projector was turned on.	When the projector is turned on, the Opening window is displayed for approximately 20 seconds. To project an image immediately, press the OK button on the remote control or top control. (P42)
No image is sent from the AV equipment.	Check that an image is played on the connected video camcorder, DVD, etc.
The wrong video terminal or signal type is selected.	Check that the correct video terminal and signal type are selected. (P34, P47)
No input signal type has been selected.	Press the INPUT button to select an appropriate input signal type. (P48)
The video signal type is incorrect.	Check whether the selected signal type is correct. (P74, P75, P128)
The BLANK function has been selected.	Press the BLANK button on the remote control. (P64)
No image is sent due to the problem in the computer.	Turn on the projector and computer in this order again.

Cause	Countermeasure
The external monitor output is not set on the notebook computer correctly.	Turn on the external monitor output on the notebook computer. To turn on the external monitor output, press the [LCD] or [VGA] function key or a key with an icon for the external monitor, while holding down the [Fn] key on the keyboard of the notebook computer. (P44) The combination of keys used to perform this operation varies among computer manufacturers. For more detailed information, refer to the User's Manual that came with your computer.
The displayed image is not the same as that displayed on the computer.	Check whether the dual screen (multi-display) mode is selected on the computer. If the dual screen mode has been selected, change it to the simultaneous display mode on the computer. The output setting method varies among computer manufacturers. For more detailed information, refer to the User's Manual that came with your computer.
The lens cap is not removed.	Remove the lens cap.

■ You cannot hear sound.

Cause	Countermeasure
The audio cable is not connected correctly.	Check the cable connection of the audio cable. (P34)
The MUTE function is enabled.	Press the MUTE button on the remote control. (P65)
The volume level is adjusted to the minimum.	Press the VOL button on the remote control or the VOL+ button on the top control to adjust the volume level. (P65)
An audio cable with a built-in resistor is used.	Use an audio cable without a built-in resistor.

■ The projected image is blur.

Cause	Countermeasure
The image is out of focus.	Adjust the focus. (P52)
The distance to the screen is too short.	Check whether the distance to the screen is appropriate. If the distance is shorter than approximately 1.2m (3.9'), the projector cannot focus on the screen. (P31, P129)
The projector is not placed straight in front of the screen.	Check whether the projector is placed obliquely to the screen. A slight error in the projection angle can be corrected through the keystone adjustment function. (P53)
The projector has been moved to a place where the temperature varies a lot.	When the projector is moved from a low-temperature place to a high-temperature place, condensation may form on the lens. The condensation will evaporate a while later and the projector will be able to project a normal image.
The lens is stained.	Clean up the lens. (P121)
The tracking is bad.	Adjust the tracking with the [AUTO PC] or [Tracking] function. (P50, P76)

■ You cannot project an image appropriately.

Cause	Countermeasure
The projected image is inverted in the vertical or horizontal direction.	The ceiling mounted/rear projection setting is incorrect. Check the [Image flip H/V] setting in the [Display settings] menu. (P81)
The dot clock of the inputted signal is 170MHz or higher with a BNC cable.	Set the signal dot clock to 170MHz on your computer.
Using a VGA cable in which some pins are not connected.	Use a VGA cable in which all pins are connected.

■ The projector is forced to be turned off.

Cause	Countermeasure
The air intake or exhaust vent is blocked.	Check whether the air intake or exhaust vent is blocked. If the air intake or exhaust vent is blocked, the temperature inside the projector rises and the power is automatically turned off to protect the projector. (The WARNING lamp flashes once.) Wait until the internal temperature gets down, and then turn on the projector without blocking the intake and exhaust vents. (P22, P23, P42)
The air filter is dirty.	Check whether the bottom air filter is clogged with dust. If the air filter is clogged, clean or replace the air filter. (P122)

Cause	Countermeasure
The lamp has exploded (or it is defective).	Check whether the lamp has exploded. If the lamp has exploded, replace the lamp according to "Lamp Handling Precautions" on page 16. Check the lamp by replacing it with a spare lamp if you have one. (P16, P123, P124)
The operating temperature is inappropriate.	Check whether the operating temperature is 5 to 35°C. (P18) If you use the projector at 2300 meters or higher above sea level, contact your dealer.
Other reasons	The projector may be damaged. Contact your dealer.

■ You cannot operate the remote control.

Cause	Countermeasure
Batteries are not installed properly or they have run out.	Check whether batteries are installed correctly. If batteries are installed correctly, replace them with new batteries. (P28)
You are operating the remote control from the outside of the remote control operating range.	Check whether you are operating the remote control within the remote control operating range. (P28)
There is an obstacle between the projector and the remote control.	Remove the obstacle between the infrared remote receiver of the projector and the remote control or point the remote control to an obstacle-free path.
You are operating the remote control under an inappropriate operating environment.	Check whether the infrared remote receiver of the projector is exposed to direct sunlight or strong light of lighting apparatus. (P28)
The channel setting of the remote control does not match with the setting of the projector.	Check whether the channel setting of the remote control has been changed. You can check the [Remote control] setting in the [System settings] menu. (P94)
The key lock function is prohibiting the remote control operation.	Check whether [Key lock] is enabled to disable the remote control operation. In the System settings menu, set [Key lock] to [Off]. (P94)

Cleaning the Projector

Clean the projector frequently to prevent dust from settling on the surface. A dirty lens may ruin the quality of the projected image.



- The main unit is very hot immediately after turning off the projector. Wait until the projector cools down sufficiently (more than 1 hour) before cleaning the projector. Otherwise, you may get burned or injured.
- Before cleaning the projector, be sure to disconnect the power plug from the AC outlet. Otherwise, electric shock or fire may result.

Wipe the projector's main unit softly with a soft cloth.

If the projector is heavily soiled, soak the cloth in water with a small amount of detergent in it, squeeze the cloth very well, and then wipe the projector with it. After cleaning, wipe the projector with a dry cloth.



- Never use volatile cleaning liquid or benzine, as these may damage the finish of the projector.
- When using a chemical dust cloth, make sure to read the instructions thoroughly.
- When cleaning the projector's lens, use a commonly available air blower or lens cleaning paper. The lens surface is easily damaged, so do not use a hard cloth or tissues.

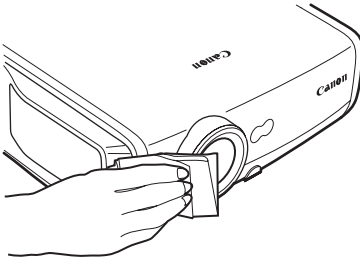

When Not Used for an Extended Period of Time

Be sure to attach the lens cap on the lens and store in the supplied carrying bag.

Cleaning and Replacing the Air Filter

An air filter is installed in the air intake vent on the bottom of the main body to protect the internal lens and mirror from dust. Should the air filter become clogged with dust, the projector may be damaged since it will block the air flow into the projector and raises the internal temperature of the projector. The following screen is displayed when turning on the projector if the air filter needs to be cleaned. Clean the air filter if such is the case.

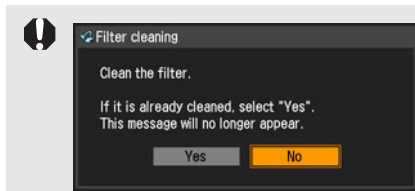

- Only [<], [>], the OK button, and the POWER button are available while this screen is displayed (When you press the POWER button, "Push POWER button again to turn off power." message appears).
- After this screen has been displayed for 10 seconds and disappeared, all buttons become operable.

■ Cleaning the Air Filter

- Turn the projector upside down, remove the cover by pushing the latch, remove the air filter, and clean it with a vacuum cleaner.
- When cleaning dust off the side exhaust vent and the bottom air intake vent, bring the vacuum cleaner nozzle close to them directly.
- If the above screen is displayed when turning on the projector after cleaning the air filter, select [Yes].

■ Replacing the Air Filter

Make sure to replace the air filter when replacing the lamp. Follow the following procedure when replacing the air filter.

- 1** Turn off the projector, disconnect the power plug from the AC outlet, and let the projector stand for at least 1 hour.
- 2** Remove the filter cover by pushing the position of the arrow.
- 3** Remove the air filter.
- 4** Install a cleaned or new air filter.
- 5** Install the filter cover securely without any space.

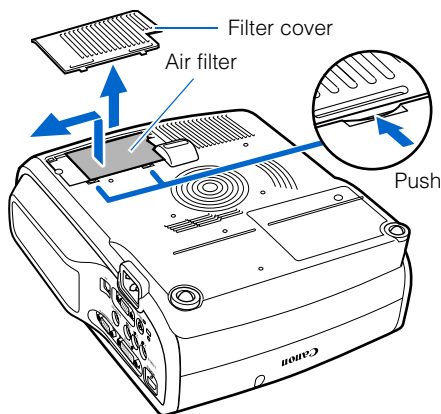

- Handle the air filter carefully. If damaged, the air filter will not work appropriately
- An air filter can be ordered from your dealer.

Replacing the Lamp

When the time of use of the lamp exceeds the certain amount of time, the following message (two types) is displayed for 10 seconds every time the projector is turned on.

1,800 - less than 2,000 hours



Prepare the new lamp when this screen is displayed.

- Only [**<**], [**>**], the **OK** button, and the **POWER** button are available while this screen is displayed.
- When you press the **POWER** button, "Push **POWER** button again to turn off power." message appears.

- After this screen has been displayed for 10 seconds and disappeared, all buttons become operable.
- This message will not be displayed again if you select [Cancel] in response to the message "Do you want to display this message again?".

Over 2,000 hours

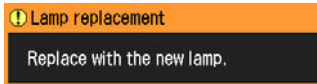

Replace the lamp by referring to the procedure on page [124](#) when this screen is displayed.

- Only the **POWER** button is available while this screen is displayed.
- When you press the **POWER** button, "Push **POWER** button again to turn off the power." message appears.

- After this screen has been displayed for 10 seconds and disappeared, all buttons become operable.
- You can check the time of use of the lamp in [Lamp counter] in the [System settings] menu ([P98](#)).

■ About the Replacing Lamp

This projector uses the following lamp.

Lamp type No.RS-LP04



- Be sure to use the specified lamp.
- A lamp can be ordered from your dealer.
- When replacing the lamp, turn off the projector, wait until the cooling fan stops, disconnect the power plug from the AC outlet, and let the projector stand for at least 1 hour. Otherwise, you may get burned because the main unit is very hot immediately after the projector is turned off.
- Do not touch the inner glass surface when you replace the lamp. Otherwise, the projector's performance may degrade.
- Make sure to handle the lamp carefully and correctly since it may explode if it is scratched or shocked. If a lamp explodes, follow the instructions under "If a Lamp Explodes" on page [16](#).
- Do not remove screws unless specified.

■ Replacing the Lamp

1 Turn off the projector, disconnect the power plug from the AC outlet, and let the projector stand for at least 1 hour.

2 Loosen a screw with a flathead screwdriver and remove the lamp cover.

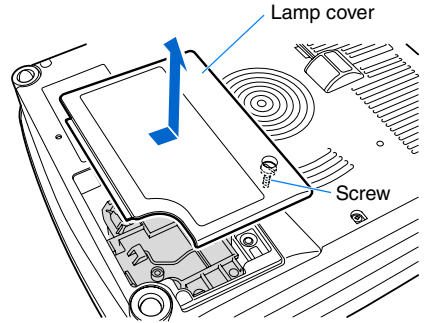

3 Loosen two screws, pull up the handle, and then remove the lamp.

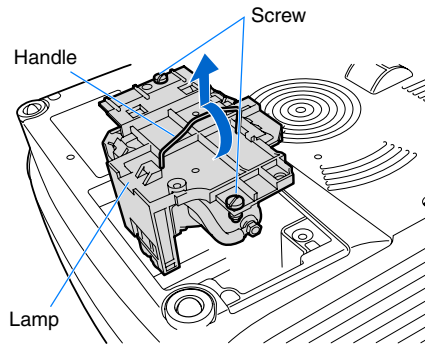

4 Fully insert a new lamp and secure it with two screws.

* After the installation, be sure to push down the handle.

5 Replace the lamp cover and tighten the screw.

6 Turn on the projector.

7 Bring up the menu and select [System settings] -> [Other settings] -> [Lamp counter]. (P98)

8 Select [Reset] -> [OK] to reset the lamp counter.

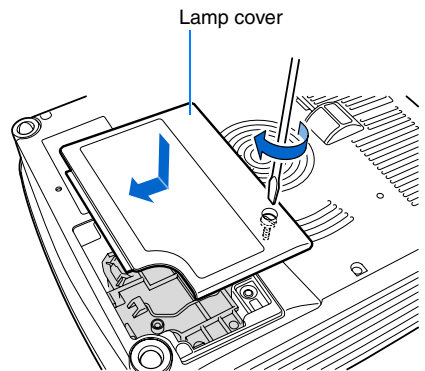











Relationship between Aspect and Screen Aspect

This section describes the relationship between screen aspect (P55) and aspect (P59). To project an image on the whole screen, select the most appropriate screen aspect ratio and aspect according to the aspect ratio of the screen and input signal type.











When Projecting an Image from a Computer

When the input signal is [ANALOG PC-1], [ANALOG PC-2], or [DIGITAL PC], select screen aspect and aspect as follows according to the resolution of the image on the computer.

Screen	Screen Aspect Ratio Setting	Resolution of Computer Screen	Object of Projection *	Aspect Setting
<div style="border: 1px solid black; padding: 2px; margin-bottom: 5px; text-align: center;">16:9</div> <div style="border: 1px solid black; padding: 2px; text-align: center;">16:10</div>	[16:10]	WUXGA 16:10	 Project an image in a largest possible size on the screen.	[Auto] (or [Full])
		WSXGA+, WSGA 16:10	 Project an image in a largest possible size on the screen.	[Auto] (or [Full])
			 Project the computer screen in the original resolution.	[True size]
		WXGA	 Project an image in a largest possible size on the screen.	[Auto]
			 Project the computer screen in the original resolution.	[True size]
		UXGA 4:3	 Project an image in a largest possible size on the screen.	[Auto] (or [4:3])
		SXGA+, XGA, SVGA, VGA 4:3	 Project an image in a largest possible size on the screen.	[Auto] (or [4:3])
			 Project the computer screen in the original resolution.	[True size]
		SXGA 5:4	 Project an image in a largest possible size on the screen.	[Auto]
			 Project the computer screen in the original resolution.	[True size]

* The image is projected on the 16:10 screen.

Relationship between Aspect and Screen Aspect

Screen	Screen Aspect Ratio Setting	Resolution of Computer Screen	Object of Projection	Aspect Setting	
4:3	[4:3] [4:3 D. image shift]	WUXGA 16:10		Project an image in a largest possible size on the screen.	[Auto]
		WSXGA+, WSXGA 16:10		Project an image in a largest possible size on the screen.	[Auto]
				Project the computer screen in the original resolution.	[True size]
		WXGA		Project an image in a largest possible size on the screen.	[Auto]
				Project the computer screen in the original resolution.	[True size]
		UXGA 4:3		Project an image in a largest possible size on the screen.	[Auto] (or [4:3])
		SXGA+, XGA, SVGA, VGA 4:3		Project an image in a largest possible size on the screen.	[Auto] (or [4:3])
				Project the computer screen in the original resolution.	[True size]
		SXGA 5:4		Project an image in a largest possible size on the screen.	[Auto]
				Project the computer screen in the original resolution.	[True size]

When Projecting an Image from Image Software

To project an image such as an image shot by a TV set, commercially available DVD software, or video camcorder (input signal [HDMI], [VIDEO], [COMPONENT]), select an aspect ratio according to the image software format as follows.

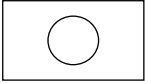
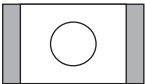
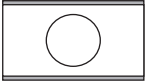
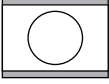
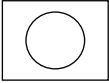
Screen	Screen Aspect Ratio Setting	Projection Result	Aspect Setting *	Screen
<div style="border: 1px solid black; width: 60px; height: 40px; margin: 5px; display: flex; align-items: center; justify-content: center;">16:9</div> <div style="border: 1px solid black; width: 60px; height: 40px; margin: 5px; display: flex; align-items: center; justify-content: center;">16:10</div>	[16:9] [16:9 D. image shift]	16:9		[Auto] (or [16:9])
		4:3		[Auto]
		16:9 image in 4:3 screen		[Zoom]
<div style="border: 1px solid black; width: 60px; height: 40px; margin: 5px; display: flex; align-items: center; justify-content: center;">4:3</div>	[4:3] [4:3 D. image shift]	16:9		[Auto] (or [16:9])
		4:3		[Auto] (or [4:3])

* The image is projected on the 16:9 or 4:3 screen.

- [Auto] cannot be selected for the aspect setting if the input signal type is [VIDEO].
- If an image from image software with aspect ratio of 16:9 is not projected correctly, select [16:9] as screen aspect.
- If you project the 16:9 image with black borders at top and bottom such as in the terrestrial movie broadcasting, you can project the 16:9 image fully on the screen by selecting [Zoom] in [Aspect].

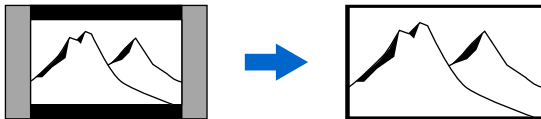

[Zoom] is available when [16:10], [16:9] or [16:9 D. image shift] is selected for the screen aspect and [HDMI (480p)], [COMPONENT (480p, 480i)], or [VIDEO] is selected for the input signal.

- To perform keystone adjustment (P53), select [4:3] or [16:9] for [Screen aspect].

Supported Computer Signal Types

This projector supports following signal types.

If your computer or AV equipment is compatible with any one of these signal types, the projector's auto PC function selects the input signal type to project an image appropriately.

ANALOG RGB

Signal type	Resolution (dots)	Horizontal frequency (KHz)	Vertical frequency (Hz)		
VGA	640 x 480	31.469	59.94		
		37.50	75.00		
		37.861	72.81		
		37.861	74.38		
		43.269	85.01		
SVGA	800 x 600	31.469	70.09		
		34.50	55.38		
		35.156	56.25		
		37.879	60.32		
		37.898	61.03		
		38.00	60.51		
		38.60	60.31		
		46.875	75.00		
		48.077	72.19		
		53.674	85.06		
XGA	1024 x 768	44.028	54.63		
		46.897	58.19		
		47.00	58.31		
		48.363	60.00		
		48.496	60.02		
		56.476	70.07		
		58.032	72.00		
		60.023	75.03		
		60.314	74.92		
		60.994	75.77		
		62.04	77.07		
		63.478	79.35		
		68.677	85.00		
		WXGA	1280 x 768	47.986	59.83
				49.702	60.03
47.712	60.02				
WSXGA	1440 x 900	55.469	59.901		
		74.04	59.95		
WUXGA	1920 x 1200	74.04	59.95		
SXGA	1152 x 864	64.196	70.39		
		61.17	65.28		
		61.846	66.00		
		71.399	75.64		
	1152 x 900	60.00	60.00		
		62.50	58.63		
	1280 x 1024	63.337	59.98		
		63.364	59.95		
		63.735	60.01		
		63.791	60.18		
		63.899	60.00		
		63.981	60.02		
		71.694	67.19		
		76.97	72.00		
		79.976	75.03		
		81.135	76.11		
		SXGA+	1400 x 1050	63.981	60.02
		UXGA	1600 x 1200	75.00	60.00
		MAC LC 13	640 x 480	34.967	66.60
		MAC13	640 x 480	35.00	66.67
MAC16	832 x 624	49.725	74.55		
MAC19	1024 x 768	60.248	75.03		
MAC21	1152 x 870	68.681	75.06		
MAC	1280 x 960	75.00	75.08		

* The specifications in the table above are subject to change without notice.

* This projector does not support any computer signal of which dot clock is 170 MHz or higher.

* Use a full connected VGA cable in which all pins are connected; otherwise, an image may be projected improperly.

DVI

Signal type	Resolution (dots)	Horizontal frequency (KHz)	Vertical frequency (Hz)
D-VGA	640 x 480	31.469	59.94
D-SVGA	800 x 600	37.879	60.32
D-XGA	1024 x 768	48.363	60.00
D-SXGA	1280 x 1024	63.981	60.02
D-SXGA+	1400 x 1050	63.981	60.02
D-UXGA	1600 x 1200	75.000	60.00
D-WUXGA	1920 x 1200	74.04	59.95
D-WSXGA	1440 x 900	55.469	59.901
D-WSXGA+	1680 x 1050	64.674	59.883

HDMI

Signal type	Resolution (dots)	Horizontal frequency (KHz)	Vertical frequency (Hz)
480p	-	31.469	59.94
576p	-	31.250	50.00
720p	-	37.500	50.00
720p	-	44.955	59.94
1080i*	-	28.125	50.00
1080i*	-	33.716	59.94
1080p	-	56.250	50.00
1080p	-	67.433	59.94

* Interlaced signal

COMPONENT

Signal type	Resolution (dots)	Horizontal frequency (KHz)	Vertical frequency (Hz)
480p	-	31.469	59.94
480i*	-	15.734	59.94
576p	-	31.250	50.00
576i*	-	15.625	50.00
720p	-	37.500	50.00
720p	-	44.955	59.94
1035i*	-	33.750	60.00
1080i*	-	28.125	50.00
1080i*	-	33.716	59.94
1080p	-	56.250	50.00
1080p	-	67.433	59.94

* Interlaced signal

Relationship between Screen Size and Projecting Distance

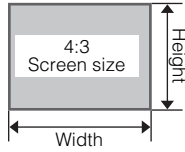
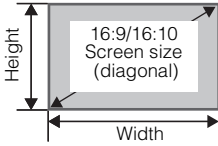

16:10 diagonal	Screen Size						Projecting distance	
	16:10		16:9		4:3		Max. zooming	Min. zooming
	Width	Height	Width	Height	Width	Height		
	cm						m (feet)	
40"	86	54	86	48	72	54	1.2 (3.9')	1.8 (5.9')
50"	108	67	108	61	90	67	1.5 (4.9')	2.2 (7.2')
60"	129	81	129	73	108	81	1.8 (5.9')	2.6 (8.5')
70"	151	94	151	85	126	94	2.1 (6.9')	3.1 (10.2')
80"	172	108	172	97	144	108	2.4 (7.9')	3.5 (11.5')
90"	194	121	194	109	162	121	2.7 (8.9')	4.0 (13.1')
100"	215	135	215	121	179	135	3.0 (9.8')	4.4 (14.4')
110"	237	148	237	133	197	148	3.3 (10.8')	4.9 (16.1')
120"	258	162	258	145	215	162	3.6 (11.8')	5.3 (17.4')
130"	280	175	280	158	233	175	3.9 (12.8')	5.8 (19.0')
140"	302	188	302	170	251	188	4.2 (13.8')	6.2 (20.3')
150"	323	202	323	182	269	202	4.5 (14.8')	6.7 (22.0')
160"	345	215	345	194	287	215	4.8 (15.8')	7.1 (23.3')
170"	366	229	366	206	305	229	5.1 (16.7')	7.5 (24.6')
180"	388	242	388	218	323	242	5.4 (17.7')	8.0 (26.3')
190"	409	256	409	230	341	256	5.8 (19.0')	8.4 (27.6')
200"	431	269	431	242	359	269	6.1 (20.0')	8.9 (29.2')
210"	452	283	452	254	377	283	6.4 (21.0')	–
220"	474	296	474	267	395	296	6.7 (22.0')	–
230"	495	310	495	279	413	310	7.0 (23.0')	–
240"	517	323	517	291	431	323	7.3 (24.0')	–
250"	538	337	538	303	449	337	7.6 (25.0')	–
260"	560	350	560	315	467	350	7.9 (26.0')	–
270"	582	363	582	327	485	363	8.2 (27.0')	–
280"	603	377	603	339	503	377	8.5 (28.0')	–
290"	625	390	625	351	521	390	8.8 (28.9')	–
300"	646	404	646	363	538	404	9.1 (29.9')	–

Glossary

sRGB (P61, P85)

An international color standard of color representation (color space) which is applied to a general digital camera and display, etc. In this projector, if you select [sRGB] in the [Image mode] setting, the projector can project the best-quality image conforming to the sRGB Standard.

DVI (P36, P47)

A digital video signal connection interface for a computer. This interface allows digital data to be transmitted without converting to analog data, assuring high image quality with no signal degradation. The DVI-I (integrated) connector can be used to transmit both an analog video signal and digital video signal.

Digital PC (P27, P36)

A signal system used to send digital information of individual display dots. This system is free from deterioration of image quality because of no analog conversion. Connect the DVI output terminal on the computer and ANALOG PC-1/DVI-I IN terminal on this projector with an optional DVI digital cable (LV-CA29). Select [DIGITAL PC] at projection.

Analog PC (P27, P35, P74)

A signal system used to send analog signal information of R (red), G (green), and B (blue). It is a typical system for connecting a color monitor to a computer. Connect the analog RGB output terminal on your computer and ANALOG PC-1/DVI-I IN terminal on this projector with the supplied computer cable. Select [ANALOG PC-1] at the time of projection.

Or, connect the analog RGB output terminal on your computer and ANALOG PC-2/COMPONENT IN terminal on this projector

with a commercial VGA cable. Select [ANALOG PC-2] at the time of projection.

HDMI (P38, P47)

An abbreviation for High-Definition Multimedia Interface, which is a digital video signal connection interface for AV equipment. It can transmit non-compressed images and audio signals simultaneously. It supports digital contents copy-protected with the HDCP technology. The projector supports HDMI 1.3 standard (10-bit deep color).

HDCP

An abbreviation of High-bandwidth Digital Content Protection which is an encryption technology for copy protection of digital image signals. In this projector, you can project digital contents copy-protected with the HDCP technology.

VIDEO (P27, P39, P74)

An output terminal widely used in an AV equipment. It is also called as a composite output terminal (pin terminal or RCA terminal). For more details, refer to "Composite".

Composite (P27, P39)

A video signal system used to send a brightness signal (Y) and a color signal (C) together. Connect the composite output (RCA) terminal on the AV equipment and the VIDEO IN terminal on this projector with a video cable. Select [VIDEO] at projection.

Aspect (P59, P73, P125)

The aspect ratio is the ratio of the horizontal dimension (width) to the vertical dimension (height) of a screen. It is expressed as "width : height."

The following aspect ratios are normally used in Computer or AV equipment.

[4:3]

The aspect ratio for SXGA+ (1400 x 1050) and XGA (1024 x 768) display resolution in PC or for the traditional television screen.

[5:4]

The aspect ratio for SXGA (1280 x 1024) display resolution.

[16:9]

The aspect ratio for the high resolution digital television or digital terrestrial broadcasting.

[16:10]

The aspect ratio for the wide PC screen such as WUGA (1920 x 1200), WSXGA (1440 x 900), and WSXGA+ (1680 x 1050).

For the aspect ratio for movie screens, "vista vision size" and "cinema scope size", etc. are used.

"Vista vision size"

The aspect ratio close to 16:9. Select [Auto] or [16:9] for [Aspect]. The back belts are added at the top and bottom of the image.

"Cinema scope size"

The landscape-oriented aspect ratio of 8:3. Select [Auto] or [16:9] for [Aspect]. The back belts are added at the top and bottom of the image.

Component (P27, P40, P88)

A signal system in which an image is transmitted by being broken down into the brightness signal (Y), color signal (C), B-Y color difference signal, and R-Y color difference signal. Its image quality is higher than that of the composite video. This system can project a better-quality image as compared with the composite signal system. Connect the component video terminal on the AV equipment and the ANALOG PC-2/COMPONENT IN terminal on this projector with a component cable. Select [COMPONENT] at projection.

Tracking (P50, P76)

To reproduce an image from an analog image signal, the process to accumulate image information at the appropriate timing with reference to the synchronization signal within the image signal is required. This process is called the tracking. This projector can display an image properly by automatically adjust the tracking with the auto PC adjustment function even if there is a small difference in the synchronization signal from an analog imaging device.

Resolution (P49)

The number of dots (horizontal dots x vertical dots) that can be displayed on the screen. It describes the fineness (information amount) of the displayed image.

Resolution	Number of dots	
	Horizontal	Vertical
VGA	640	480
SVGA	800	600
XGA	1024	768
SXGA	1280	1024
SXGA+	1400	1050
UXGA	1600	1200
WUXGA	1920	1200

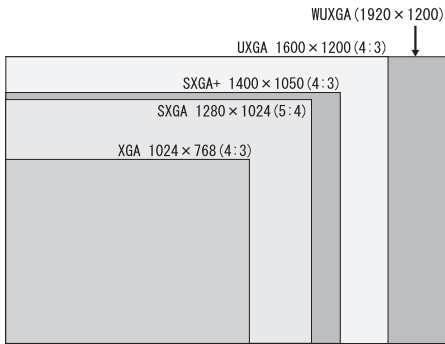

Number of dots in each resolution

If you select WUXGA (1920 dots x 1200 dots) as the display resolution for the connecting computer, this projector can project high-resolution images. If your computer does not have the WUXGA option, select the maximum resolution among the selectable options.

Progressive (P79)

An image display system used to display the entire screen per scan. For an interlace signal (video signal) that displays one screen by two scans (one for odd lines and one for even lines) is input, progressive processing is required. When the progressive function is turned off, one screen is displayed using image signals per interlace signal, deteriorating the vertical resolution of the image. When the progressive function is turned on, one screen is displayed using image signals per two interlace signals, improving the vertical resolution of the image. Turn off the progressive function when flickering and horizontal lines are noticeable on a fast-moving picture.

Offset (P88)

A parameter that shifts the reproduction range of a brightness signal from black to white within an image signal toward the higher or lower level of brightness. The reproducibility of the dark tone is mainly changed. Since you can adjust the offset for each RGB color in this projector, you can also adjust colors.

The offset is normally adjusted with the gain.

Gamma Correction (P87, P89)

A tone adjustment system used during projection of image data. The gamma correction function works effectively when portions of an image are obscure because they are too light or dark.

This projector supports manual gamma correction and dynamic gamma correction which performs the gamma correction automatically.

Gain (P88)

A parameter that adjusts the reproduction range of a brightness signal from black to white within the image signal to naturally reproduce it on the screen. The reproducibility of the bright tone is mainly changed. Since you can adjust the gain for each RGB color in this projector, you can also adjust colors. The gain is normally adjusted with the offset.

6-axis color adjust (P90)

The color adjustment function for an advanced user. You can adjust color balance and color level for 6 axis of RGB (red/green/blue) and CMY (cyan/magenta/yellow) of the projected image to make a fine color adjustment. You can perform the 6-axis color adjustment in the image adjustment menu.

Specifications

■ Projector

Model name		WUX10
Display system		RGB liquid crystal system
Optical system		Color separation by dichroic mirror/polarizing beam splitter and color composition by prism
Display device	Type	Reflective liquid crystal panel
	Size/Aspect ratio	0.71" x 3/16:10
Projection lens	Drive system	Active matrix system
	Number of pixels/Total Number of pixels	2,304,000 (1920 x 1200) x3 panels/6,912,000
	Zoom ratio/Focal length/F value	1.5/f=21.8 to 31.9mm/F1.85 to F2.65
Projection lens	Zooming and focusing system	Electronic operation/electronic operation (with auto focusing function)
	Lens shift	10:0 (fixed)
Light source		275W high-pressure lamp
Screen size (projection distance)		40" to 300" (1.2m/3.9' to 9.1m/12.8')
Number of producible colors		16,770,000 colors (full color)
Brightness*		3,200 lm (at presentation)
Contrast ratio		1000:1 (full white:full black, at presentation)
Uniformity*		88% (at presentation)
Speaker		1W monaural x 1
Maximum input resolution		1920 x 1200 dots
Video signals	ANALOG PC input	WUXGA/WSXGA/WXGA/UXGA/SXGA+/SXGA/XGA/SVGA/VGA (scan rate: horizontal: 15 to 75KHz, vertical 50 to 85Hz)
	DIGITAL PC input	WUXGA/WSXGA+/WSXGA/UXGA/SXGA+/SXGA/XGA/SVGA/VGA
	COMPONENT input	1080p, 1080i, 1035i, 720p, 576i, 576p, 480i, 480p
	HDMI input	1080p, 1080i, 720p, 576p, 480p
	VIDEO input	NTSC, PAL, SECAM, NTSC4.43, PAL-M, PAL-N
Input terminals	DVI-I IN terminal	DIGITAL PC, ANALOG PC-1 (DVI-I connector 29-pin)
	HDMI IN terminal	HDMI ver. 1.3 (10-bit deep color)
	ANALOG PC-2/COMPONENT IN terminal	ANALOG PC-2, COMPONENT (mini D-sub 15-pin)
	VIDEO IN terminal	Composite (RCA)
	CONTROL terminal	RS-232C (mini D-sub 9-pin)
Audio Input terminal		Audio signal (stereo mini jack x 3)
Audio Output terminal		Audio signal (stereo mini jack)
LAN terminal		Network connection (RJ-45)
Input signals	Digital PC	TMDS (Transition Minimized Differential Signaling)
	Analog PC	0.7Vp-p, positive polarity, impedance = 75Ω Horizontal/vertical synchronization: TTL level, negative or positive polarity Composite synchronization in G signal: 0.3Vp-p, negative polarity, impedance=75Ω
	Video	Video: 1Vp-p, negative synchronization, impedance = 75Ω Component: Separate Y Cb/Pb Cr/Pr signal Y: 1Vp-p, Negative synchronization, impedance = 75Ω Cb/Pb: 0.7Vp-p, impedance = 75Ω Cr/Pr: 0.7Vp-p, impedance = 75Ω
	Audio	142mVrms, impedance = 47 KΩ or more
Noise (normal mode/silent mode)		36/32dB
Operating temperature		5 °C to 35 °C
Power supply		AC 100-240 V 50/60 Hz
Power consumption (normal mode/silent mode/standby state)		400W/330W/8W (when the network function is off)
Dimensions		284 (W) x 114 (H) x 336 (D) mm/11.4 (W) x 4.6 (H) x 13.4 (D) in (excluding protrusions)
Weight		5.0 kg/11.02lbs
Accessories		Remote control, batteries for remote control, power cord, computer connection cable, component cable, carrying bag, lens cover, string for lens cover, User's Manual, and Warranty Card.

* 99.99% or more of the LCD panel pixels are effective. During projection, 0.01% or less of pixels may stay lit or unlit due to the characteristics of the LCD panel.

* Using the projector continuously for an extended period of time may accelerate the deterioration of optical parts.

■ Remote Control

Power supply	Two 3.0 V, AAA-size batteries
Operating range	About 5 m (16.4') (to infrared remote receiver)
Dimensions	42 (W) x 22 (H) x 135 (D) mm / 1.7 (W) x 0.9 (H) x 5.3 (D) in
Weight (not including batteries)	55 g

■ External View

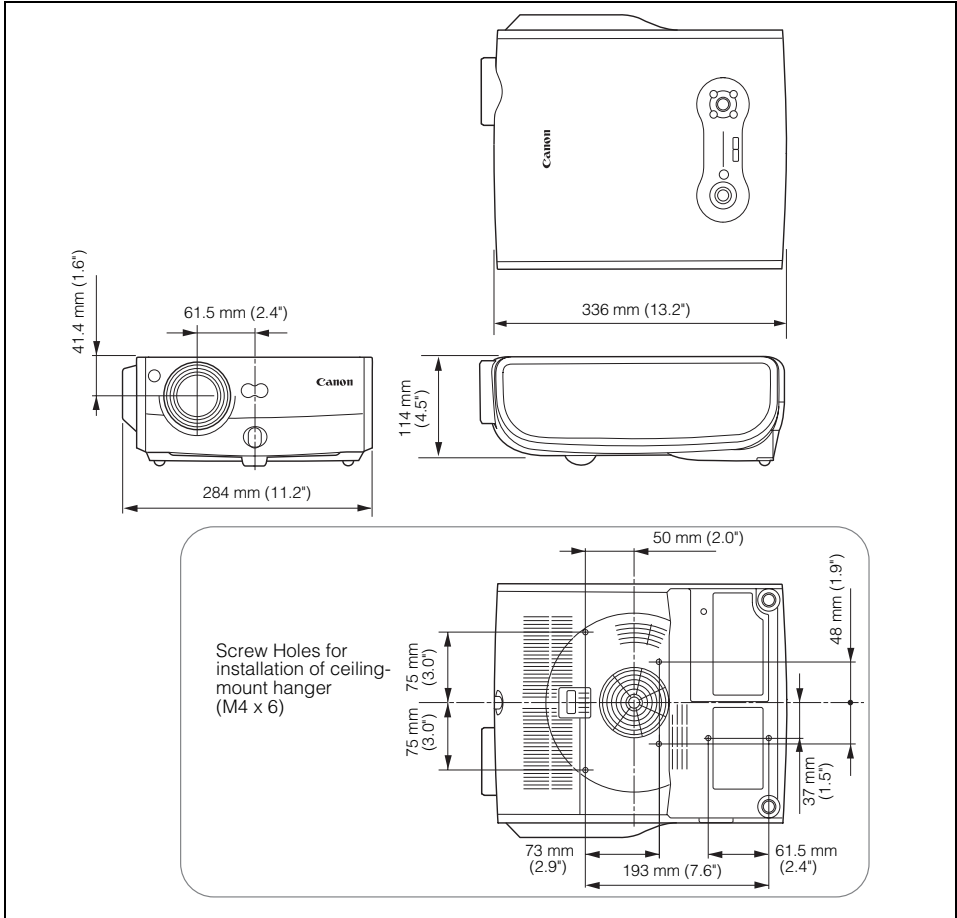

■ ANALOG PC-2/COMPONENT IN terminal

This terminal is used as a computer analog PC input or component input terminal. Use a D-sub computer cable for connection.

The terminal specifications for the analog PC input and component input are the same.

Mini D-sub 15-pin

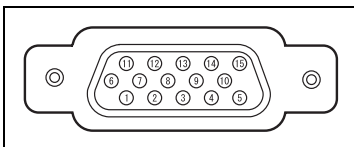

1	R	9	+5 V power
2	G	10	Ground (Vertical sync.)
3	B	11	Monitor ID0
4	Monitor ID2	12	DDC data
5	Ground (Horizontal sync.)	13	Horizontal sync.
6	Ground (R)	14	Vertical sync.
7	Ground (G)	15	DDC clock
8	Ground (B)		

■ Service Port (CONTROL)

Pin assignment

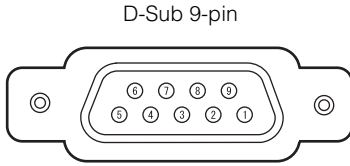

Pin No.	Signal
1	OPEN
2	RxD
3	TxD
4	OPEN
5	GND
6	OPEN
7	OPEN
8	OPEN
9	OPEN

Communication format

Communication mode: RS-232-C, asynchronous,
half-duplex communication

Communication speed: 19,200 bps

Character length: 8 bits

Stop bits: 2 bits

Parity: None

Flow control: None

Control Commands

Function	ASCII Representation	Binary Representation
Power supply	On	POWER ON<CR>
	Off	POWER OFF<CR>
	Get	GET POWER<CR>
Input signals	Digital PC	INPUT=D-RGB<CR>
	HDMI	INPUT=HDMI<CR>
	Analog PC-1	INPUT=A-RGB1<CR>
	Analog PC-2	INPUT=A-RGB2<CR>
	Component	INPUT=COMP<CR>
	Video	INPUT=VIDEO<CR>
Image mode	Standard	IMAGE=STANDARD<CR>
	Presentation	IMAGE=PRESENTATION<CR>
	sRGB	IMAGE=SRGB<CR>
	Movie	IMAGE=MOVIE<CR>
	Get	GET IMAGE<CR>
Brightness	Setting	BRI=<value><CR>
	Get	GET BRI<CR>
Sharpness	Setting	SHARP=<value><CR>
	Get	GET SHARP<CR>
Contrast	Setting	CONT=<value><CR>
	Get	GET CONT<CR>
Aspect ratio	Auto	ASPECT=AUTO<CR>
	Full	ASPECT=FULL<CR>
	16:9	ASPECT=16:9<CR>
	4:3	ASPECT=4:3<CR>
	Zoom	ASPECT=ZOOM<CR>
	True size	ASPECT=TRUE<CR>
Lamp mode	Normal	LAMP=NORMAL<CR>
	Quiet	LAMP=SILENT<CR>
	Get	GET LAMP<CR>
BLANK	Blank On	BLANK=ON<CR>
	Blank Off	BLANK=OFF<CR>
	Get	GET BLANK<CR>

Numerics

6-axis color adjust90, 133

A

Adjustable foot33

Adjusting keystone distortion53

Adjusting the focus52

Adjusting the volume65

Air filter122

ANALOG PC35, 36, 47

Analog PC130

ANALOG PC-1/

DVI-I IN terminal27, 35, 47

ANALOG PC-2/

COMPONENT IN terminal .27, 35, 40, 47

ASPECT60

Aspect55, 59, 73, 125, 131

Audio IN terminal27, 35, 37, 39, 40

Audio OUT terminal27, 37, 41

Authentication and Encryption

Protocols111

Auto (Aspect)59

Auto fleshtone90

Auto focus45, 92

Auto input45, 92

Auto keystone45, 92

AUTO PC50

Auto screen color45, 92

AUTO SET46

Auto setup45, 92

B

Beep93

BLANK64

Brightness86

C

Carrying bag17, 21

Ceiling mounted32, 81

Channel setting94

Color adjustment88

COMPONENT40, 47

Component131

Composite130

Connecting the projector to the
computer35

Contrast86

D

D. ZOOM66

D.SHIFT/KEYSTONE53, 57

DIGITAL PC36, 47

Digital PC130

Direct power on93

Display resolution

(preparing the computer)49

Display settings menu70

Displays logo84

DVI36, 47, 130

DVI-I IN35, 36, 47

Dynamic gamma89

F

Factory defaults100

FOCUS52

FREEZE64

G

Gain88, 132

Gamma correction87, 132

Guide95

H

HDCP130

HDMI38, 47, 130

HDMI IN terminal27, 38

HDMI input level78

HDMI over scan79

Horizontal pixels77

Horizontal position76

I

IMAGE61

Image adjustment menu70

Image flip H/V81

Image mode85

Image mode (Image quality) 61
 Information 70, 101
 INPUT 48
 Input signal select 74, 75
 Input terminal 27
 Connecting the projector to the
 computer 35
 Connecting to AV equipment 38
 Installation 17
 IP address 104

K

Key lock 94
 Keystone 53

L

LAMP 91
 Lamp counter 98
 Lamp mode 91
 Lamp replacement 98, 123, 124
 LAN port 27, 104
 Language 95
 LED illumination 96
 Lens cap 20
 Logo capture 82
 Logo position 82

M

MENU 70
 Menu display time 96
 Menu position 80
 MUTE 65

N

Network settings 99, 100, 104
 Noise reduction 89

O

Offset 88, 132
 OK 25

P

Password settings 97

POWER 42, 62, 93
 Power management 43
 Power management mode (settings) 92
 Power saving (power management) 43
 Progressive 79, 132
 Projecting distance 31, 129
 Projector on 84
 P-TIMER 67

R

Rear projection 32, 81
 Register password 97
 Remote control 24, 28, 94
 Reset 91, 100
 Resolution 131
 Reverse projection (ceiling-mounted/
 rear projection) 32, 81

S

Screen aspect 55, 84, 125
 Screen color 80
 Screen size 129
 Screen when blank 83
 Selecting a language 43, 95
 Selecting an input signal 47
 Setting Display Status 73
 Setting the Image Quality 85
 Setting up the projector 17, 31
 Setting Various Function 92
 Sharpness 87
 Signal type 128
 SNMP Agent Function 110
 sRGB 61, 85, 130
 System settings menu 70

T

Top control 26
 Total dots 75
 Tracking 76, 131
 True size (Aspect) 59
 Turning on external monitor output
 (preparing the notebook
 computer) 44

V

Vertical pixels	78
Vertical position	77
VIDEO	39, 47, 130
VIDEO IN terminal	27, 39
VOL	65

W

WARNING lamp	26, 116
--------------------	---------

Z

ZOOM	51
Zoom (Aspect)	59
Zoom (image size)	51
Zooming an Image	66

Options

- | | |
|--|---|
| <ul style="list-style-type: none">• Replacement lamp
Part No.: RS-LP04• Ceiling-mount hanger
Part No.: RS-CL07• Ceiling-mount pipe
(40 cm/16 in to 60 cm/24 in)
Part No.: RS-CL08* | <ul style="list-style-type: none">• Ceiling-mount pipe
(60 cm/24 in to 100 cm/40 in)
Part No.: RS-CL09*• DVI digital cable
Part No.: LV-CA29 |
|--|---|

* This part is used to hang the projector from a ceiling.
For more detailed information, refer to the instruction manual that comes with the ceiling-mount hanger RS-CL07.

Menu Configuration

The Display settings menu

Aspect	DIGITAL PC/ANALOG PC P73
	Auto *
	Full
	16:9
	4:3
	True size
	VIDEO
	Full *
	16:9
	4:3
	Zoom
	HDMI
	Auto *
	Full
	16:9
	4:3
	Zoom
	True size
	COMPONENT
	Auto *
	Full
	16:9
	4:3
	Zoom
	True size
Input signal select	ANALOG PC P74
	640 x 480
	:
	1920 x 1200
	VIDEO P74
	Auto *
	NTSC
	PAL
	SECAM
	NTSC4.43
	PAL-M
	PAL-N
	COMPONENT P75
	Auto *
	1080p
	1080i
	1035i
	720p
	576p
	576i
	480p
	480i

Input signal settings	ANALOG PC
	Total dots P75
	Tracking P76
	Horizontal position P76
	Vertical position P77
	Horizontal pixels P77
	Vertical pixels P78
HDMI input level	HDMI P78
	Auto *
	Normal
	Expanded
HDMI over scan	HDMI P79
	Off
	On *
Progressive	VIDEO/COMPONENT/ P79
	HDMI
	Off
	On
	Auto *
Menu position	P80
Screen color	Normal * P80
	Greenboard
	Adjust Red/Green/Blue
Image flip H/V	None * P81
	Ceiling mounted
	Rear
	Rear, Ceiling mounted
User screen settings	
Logo capture	OK/Cancel P82
Logo position	Upper L P82
	Upper R
	Center *
	Lower L
	Lower R
No signal screen	Black P83
	Blue *
	User logo
Screen when blank	Black * P83
	Blue
	User logo
Projector on	Skip P84
	Canon logo *
	User logo
Return	
Screen aspect	16:10 P84
	16:9
	4:3
	16:9 D. image shift
	4:3 D. image shift

*: Factory defaults (setting after reset)

The Image adjustment menu

Image mode	Standard *	P85
	Presentation	
	Movie	
	sRGB	
Brightness	P86	
Contrast	P86	
Sharpness	P87	
Gamma	P87	
Color adjustment		
	VIDEO/COMPONENT	P88
	Color level	
	Color balance (only for COMPONENT)	
	COMMON	P88
	R Gain	
	R Offset	
	G Gain	
	G Offset	
	B Gain	
	B Offset	
Advanced adjustment		
Noise reduction	VIDEO/ COMPONENT/HDMI	P89
	Off	
	Weak	
	Strong	
Dynamic gamma	Off	P89
	Weak	
	Strong	
Auto flesh tone	Off	P90
	L	
	M	
	H	
6-axis color adjust	Off *	P90
	Adjust	Hue/Saturation
	Reset	
Return		
Lamp mode	Normal *	P91
	Quiet	
Reset	OK/Cancel	P91

The Information menu

Model name	P101
Input signal	
Firmware	
Serial no.	
IP address	
Gateway address	
E-mail sender address	
E-mail recipient address	
Projector name	
System information ID	

The System settings menu

Auto setup	P92
Auto focus	Off
	On *
Auto keystone	Off
	On *
Auto input	Off
	On *
Auto screen color	Off *
	On
Return	
Power management mode	Off *
	Standby
	Exit
Direct power on	Off *
	On
Beep	Off
	On *
Key lock	Off *
	Main unit
	Remote control
Remote control	Ch1 *
	Ch2
Language	English
	Polish
	Germany
	Hungarian
	French
	Czech
	Italian
	Danish
	Spanish
	Arabic
	Portuguese
	Chinese
	Swedish
	(Simplified)
	Russian
	Chinese
	(Traditional)
	Dutch
	Korean
	Finnish
	Norwegian
	Japanese
	Turkish
Guide	Off
	On *
LED illumination	Off
	On *
Other settings	
Menu display time	Normal *
	Extended
Password settings	Off
	On *
Register password	Password input
Lamp counter	Return
	Reset (OK/Cancel)
Network function	Off *
	On
Network setting Initialization	YES/NO
Factory defaults	OK/Cancel
Return	

**CANON INC.**

30-2, Shimomaruko 3-chome, Ohta-ku, Tokyo
146-8501, Japan

U.S.A.

CANON U.S.A. INC.

One Canon Plaza, Lake Success, NY 11042-
1198, U.S.A.

For all inquiries concerning this product, call toll
free in the U.S.

1-800-OK-CANON

CANADA

CANON CANADA INC. HEADQUARTERS

6390 Dixie Road, Mississauga, Ontario L5T
1P7, Canada

CANON CANADA INC. MONTREAL BRANCH

5990, Côte-de-Liesse, Montréal Québec H4T
1V7, Canada

CANON CANADA INC. CALGARY OFFICE

2828, 16th Street, N.E. Calgary, Alberta T2E
7K7, Canada

For all inquiries concerning this product, call toll
free in Canada

1-800-OK-CANON

EUROPE, AFRICA & MIDDLE EAST

CANON EUROPA N.V.

Bovenkerkerweg 59-61, 1185 XB Amstelveen,
The Netherlands

CANON FRANCE S.A.S

17, quai du President Paul Doumer, 92414
Courbevoie Cedex, France

CANON UK LTD.

Woodhatch Reigate Surrey RH2 8BF, United
Kingdom

CANON DEUTSCHLAND GmbH

Europark Fichtenhain A10, 47807 Krefeld, Ger-
many

CANON ITALIA S.p.A.

Via Milano 8 I-20097 San Donato Milanese, Mil-
ano, Italy

CANON Schweiz AG

Geschäftsbereich Wiederverkauf, Industri-
estrasse 12, CH-8305 Dietlikon,
Switzerland

CANON GMBH

Zetschegasse 11, A-1230 Wien, Austria

CANON España, S.A.

C/Joaquín Costa, 41, 28002 Madrid, Spain

CANON PORTUGAL S.A.

Rua Alfredo da Silva, 14 Alfragide 2610-016
Amadora, Portugal

CANON Belgium N.V./S.A.

Berkenlaan 3, 1831 Diegem (Mechelen), Bel-
gium

CANON Netherland NV

Neptunusstraat 1, 2132 JA Hoofddorp, The
Netherlands

CANON LUXEMBOURG S.A.

Rue des Joncs 21, L-1818 Howald, Luxem-
bourg

CANON DANMARK A/S

Knud Hoejgaards Vej 1 DK-2860 Soeborg, Dan-
mark

CANON OY

Huopalahdentie 24 PL 1 00351 Helsinki, Fin-
land

CANON SVENSKA AB

Gustav III:s Boulevard 26 169 88 Solna, Swe-
den

CANON NORGE as

Hallagerbakken 110, Postboks 33, Holmlia,
1201 Oslo, Norway

CENTRAL & SOUTH AMERICA

CANON LATIN AMERICA, INC.

703 Waterford Way, Ste. 400 Miami, FL 33126,
U.S.A.

ASIA

CANON (China) Co., Ltd.

15F Jinbao Building No.89 Jinbao Street,
Dongcheng District, Beijing 100005, China

CANON HONGKONG CO., LTD.

19/F., The Metropolis Tower, 10 Metropolis
Drive, Hunghom, Kowloon, Hong Kong

CANON SINGAPORE PTE. LTD.

1 HarbourFront Avenue, #04-01 Keppel Bay
Tower, Singapore 098632

CANON KOREA CONSUMER IMAGING INC.

Gangnam Finance Center 17F,737, Yeoksam-
Dong, Gangnam-gu, Seoul, 135-984, Korea

OCEANIA

CANON AUSTRALIA PTY. LTD.

1 Thomas Holt Drive, North Ryde, N.S.W. 2113,
Australia

CANON NEW ZEALAND LTD.

Akoranga Business Park, Akoranga Drive,
Northcote, Auckland, New Zealand