

# Canon

## Multimedia Projector

# LV-X4 LV-7230

### Owner's Manual



**E**  
English

**ProSelecta**

View :: Compare :: Select - [www.ProSelecta.com](http://www.ProSelecta.com)

# Features and Design

---

This Multimedia Projector is designed with the most advanced technology for portability, durability, and ease of use. This projector utilizes built-in multimedia features, a palette of 16.77 million colors, and matrix liquid crystal display (LCD) technology.

## ◆ **Wide Zoom Lens**

---

This projector is equipped with Wide Zoom Lens which is 1.6 times the zoom ratio, and it allows you to enjoy 100" screen size in range of 8.2' (2.5m) to 13.1' (4m).

## ◆ **Compact Design**

---

This projector is designed compact in size and weight. It is easy to carry and work anywhere you wish to use.

## ◆ **Compatibility**

---

The projector widely accepts various video and computer input signals including; Computers, 6 Color systems, Component video, S-video and RGB scart.

## ◆ **Simple Computer System Setting**

---

The projector has the Multi-scan system to conform to almost all computer output signals quickly. (See page 27.)

## ◆ **Digital Zoom (for Computer)**

---

The digital zoom function expands (to approx. 16 times of screen size) or compress the image size, allowing you to focus on crucial information at a presentation. (See page 33.)

## ◆ **Keystone Adjustment**

---

The keystone correction function is provided to correct distortion of the projected image allowing you to use the projector without locational constraints. (See page 24 and 41.)

## ◆ **Power Management**

---

The Power management function reduces power consumption and maintain the lamp life. (See page 43.)

## ◆ **User's Logo**

---

A projected image can be captured and used for the starting display of the projector with the Capture function. You can also display the captured image in an interval during your presentation instead of blackout image with the No show function. (See page 25 and 42.)

## ◆ **Selectable Lamp Mode**

---

Brightness of the projection lamp can be selected in the Setting menu. (See page 44.)

## ◆ **Blackboard Function**

---

Blackboard\* can be used as a projection screen. (See page 31 and 37.)

\* The board color is limited to Green.

## ◆ **Film Function**

---

The Film function reproduces pictures faithful to the original film quality from 3:2 pull-down video contents. (See page 39.)

## ◆ **PIN Code Lock Function**

---

The PIN code lock function prevents others except users from using the projector. (See page 20, 45 and 46.)

## ◆ **Multilanguage Menu Display**

---

Operation menu is available in 12 languages; English, German, French, Italian, Spanish, Portuguese, Dutch, Swedish, Russian, Chinese, Korean, or Japanese. (See page 41.)

## ◆ **Switchable Interface Terminal**

---

The projector provides a switchable interface terminal. You can use the terminal as computer input or monitor output conveniently. (See page 43.)

# Table of Contents

|   |            |  |            |
|---|------------|--|------------|
| <b>Features and Design</b> .....            | <b>.2</b>  | <b>Computer Input</b> .....                          | <b>.26</b> |
| <b>Table of Contents</b> .....              | <b>.3</b>  | Input Source Selection                               | 26         |
| <b>To the Owner</b> .....                   | <b>.4</b>  | Computer System Selection                            | 27         |
| <b>Safety Instructions</b> .....            | <b>.5</b>  | Auto PC Adjustment                                   | 28         |
| Air Circulation                             | 6          | Manual PC Adjustment                                 | 29         |
| Installing the Projector in Proper Position | 6          | Image Level Selection                                | 31         |
| Moving the Projector                        | 6          | Image Level Adjustment                               | 32         |
| <b>Compliance</b> .....                     | <b>.7</b>  | Screen Size Adjustment                               | 33         |
| <b>Part Names and Functions</b> .....       | <b>.8</b>  | <b>Video Input</b> .....                             | <b>.34</b> |
| Front                                       | 8          | Input Source Selection (Video, S-Video)              | 34         |
| Back  | 8          | Input Source Selection (Component, RGB Scart 21-Pin) | 35         |
| Bottom                                      | 8          | Video System Selection                               | 36         |
| Terminal                                    | 9          | Image Level Selection                                | 37         |
| Top Control                                 | 10         | Image Level Adjustment                               | 38         |
| Remote Control Unit                         | 11         | Screen Size Adjustment                               | 40         |
| Pointer Function                            | 12         | <b>Setting</b> .....                                 | <b>.41</b> |
| Wireless Mouse Operation                    | 12         | Setting  | 41         |
| Remote Control Code                         | 13         | <b>Maintenance and Cleaning</b> .....                | <b>.47</b> |
| Operating Range                             | 13         | Warning Indicator                                    | 47         |
| Remote Control Battery Installation         | 14         | Cleaning the Air Filters                             | 48         |
| <b>Installation</b> .....                   | <b>.15</b> | Attaching the Lens Cover                             | 48         |
| Positioning the Projector                   | 15         | Cleaning the Projection Lens                         | 49         |
| Adjustable Feet                             | 15         | Cleaning the Projector Cabinet                       | 49         |
| Connecting the AC Power Cord                | 16         | Lamp Replacement                                     | 50         |
| Connecting to a Computer                    | 17         | Lamp Replace Counter                                 | 51         |
| Connecting to Video Equipment               | 18         | <b>Appendix</b> .....                                | <b>.52</b> |
| Connecting to Component Video Equipment     | 19         | Troubleshooting                                      | 52         |
| <b>Basic Operation</b> .....                | <b>.20</b> | Indicators and Projector Condition                   | 54         |
| Turning On the Projector                    | 20         | Menu Tree  | 55         |
| Turning Off the Projector                   | 21         | Compatible Computer Specifications                   | 57         |
| How to Operate the On-Screen Menu           | 22         | Technical Specifications                             | 58         |
| Menu Bar                                    | 23         | Configurations of Terminals                          | 60         |
| Zoom and Focus Adjustment                   | 24         | Optional Parts                                       | 60         |
| Keystone Adjustment                         | 24         |  |            |
| Picture Freeze Function                     | 24         |  |            |
| No Show Function                            | 25         |  |            |
| P-Timer Function                            | 25         |  |            |
| Sound Adjustment                            | 25         |  |            |

---

## Trademarks

Each name of corporations or products in this book is either a registered trademark or a trademark of its respective corporation.





# To the Owner

Before operating this projector, read this manual thoroughly and operate the projector properly.

This projector provides many convenient features and functions. Operating the projector properly enables you to manage those features and maintains it in better condition for a considerable time.

Improper operation may result in not only shortening the product-life, but also malfunctions, fire hazard, or other accidents.

If your projector seems to operate improperly, read this manual again, check operations and cable connections and try the solutions in the "Troubleshooting" section in the end of this booklet. If the problem still persists, contact the dealer where you purchased the projector or the service center.

|   |   |   |
|---|---|---|
|    | <b>CAUTION</b><br><b>RISK OF ELECTRIC SHOCK</b><br><b>DO NOT OPEN</b>   |  |
| <b>CAUTION : TO REDUCE THE RISK OF ELECTRIC SHOCK, DO NOT REMOVE COVER (OR BACK). NO USER-SERVICEABLE PARTS INSIDE EXCEPT LAMP REPLACEMENT. REFER SERVICING TO QUALIFIED SERVICE PERSONNEL.</b> |   |   |
|    | THIS SYMBOL INDICATES THAT DANGEROUS VOLTAGE CONSTITUTING A RISK OF ELECTRIC SHOCK IS PRESENT WITHIN THIS UNIT.             |   |
|    | THIS SYMBOL INDICATES THAT THERE ARE IMPORTANT OPERATING AND MAINTENANCE INSTRUCTIONS IN THE OWNER'S MANUAL WITH THIS UNIT. |   |

## CAUTION

Not for use in a computer room as defined in the Standard for the Protection of Electronic Computer/Data Processing Equipment, ANSI/NFPA 75.

Ne peut être utilisé dans une salle d'ordinateurs telle que définie dans la norme ANSI/NFPA 75 Standard for Protection of Electronic Computer/Data Processing Equipment



## Safety Precaution

**WARNING : TO REDUCE THE RISK OF FIRE OR ELECTRIC SHOCK, DO NOT EXPOSE THIS APPLIANCE TO RAIN OR MOISTURE.**

- This projector produces intense light from the projection lens. Do not stare directly into the lens as possible. Eye damage could result. Be especially careful that children do not stare directly into the beam.
- Install the projector in a proper position. If not, it may result in a fire hazard.
- Provide appropriate space on the top, sides and rear of the projector cabinet for allowing air circulation and cooling the projector. Minimum clearance must be maintained. If the projector is to be built into a compartment or similarly enclosed, the minimum distances must be maintained. Do not cover the ventilation slot on the projector. Heat build-up can reduce the service life of your projector, and can also be dangerous.

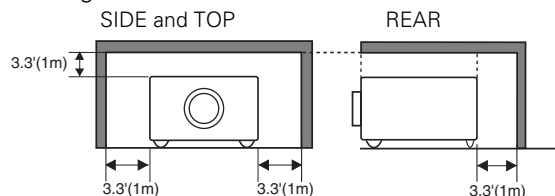

- Do not put any flammable object or spray can near the projector, hot air is exhausted from the ventilation holes.
- If the projector is not to be used for an extended time, unplug the projector from the power outlet.

**READ AND KEEP THIS OWNER'S MANUAL FOR LATER USE.**

## NOTE FOR CUSTOMERS IN THE US

 LAMP(S) INSIDE THIS PRODUCT CONTAIN MERCURY AND MUST BE RECYCLED OR DISPOSED OF ACCORDING TO LOCAL, STATE OR FEDERAL LAWS.

# Safety Instructions

All the safety and operating instructions should be read before the product is operated.

Read all of the instructions given here and retain them for later use. Unplug this projector from AC power supply before cleaning. Do not use liquid or aerosol cleaners. Use a damp cloth for cleaning.

Follow all warnings and instructions marked on the projector.

For added protection to the projector during a lightning storm, or when it is left unattended and unused for long periods of time, unplug it from the wall outlet. This will prevent damage due to lightning and power line surges.

Do not expose this unit to rain or use near water... for example, in a wet basement, near a swimming pool, etc...

Do not use attachments not recommended by the manufacturer as they may cause hazards.

Do not place this projector on an unstable cart, stand, or table. The projector may fall, causing serious injury to a child or adult, and serious damage to the projector. Use only with a cart or stand recommended by the manufacturer, or sold with the projector. Wall or shelf mounting should follow the manufacturer's instructions, and should use a mounting kit approved by the manufacturers.

An appliance and cart combination should be moved with care. Quick stops, excessive force, and uneven surfaces may cause the appliance and cart combination to overturn.



Slots and openings in the back and bottom of the cabinet are provided for ventilation, to insure reliable operation of the equipment and to protect it from overheating.

The openings should never be covered with cloth or other materials, and the bottom opening should not be blocked by placing the projector on a bed, sofa, rug, or other similar surface. This projector should never be placed near or over a radiator or heat register.

This projector should not be placed in a built-in installation such as a book case unless proper ventilation is provided.

Never push objects of any kind into this projector through cabinet slots as they may touch dangerous voltage points or short out parts that could result in a fire or electric shock. Never spill liquid of any kind on the projector.

Do not install the projector near the ventilation duct of air-conditioning equipment.

This projector should be operated only from the type of power source indicated on the marking label. If you are not sure of the type of power supplied, consult your authorized dealer or local power company.

Do not overload wall outlets and extension cords as this can result in fire or electric shock. Do not allow anything to rest on the power cord. Do not locate this projector where the cord may be damaged by persons walking on it.

Do not attempt to service this projector yourself as opening or removing covers may expose you to dangerous voltage or other hazards. Refer all servicing to qualified service personnel.

Unplug this projector from wall outlet and refer servicing to qualified service personnel under the following conditions:

- a. When the power cord or plug is damaged or frayed.
- b. If liquid has been spilled into the projector.
- c. If the projector has been exposed to rain or water.
- d. If the projector does not operate normally by following the operating instructions. Adjust only those controls that are covered by the operating instructions as improper adjustment of other controls may result in damage and will often require extensive work by a qualified technician to restore the projector to normal operation.
- e. If the projector has been dropped or the cabinet has been damaged.
- f. When the projector exhibits a distinct change in performance-this indicates a need for service.

When replacement parts are required, be sure the service technician has used replacement parts specified by the manufacturer that have the same characteristics as the original part. Unauthorized substitutions may result in fire, electric shock, or injury to persons.

Upon completion of any service or repairs to this projector, ask the service technician to perform routine safety checks to determine that the projector is in safe operating condition.

## **Air Circulation**

Openings in the cabinet are provided for ventilation and to ensure reliable operation of the product and to protect it from overheating, and these openings must not be blocked or covered.

### **CAUTION**

Hot air is exhausted from the exhaust vent. When using or installing the projector, the following precautions should be taken.

- Do not put any flammable objects near the vent.
- Keep the exhaust vent at least 3'(1m) away from any objects.
- Do not touch a peripheral part of the exhaust vent, especially screws and metallic part. This area will become hot while the projector is being used.
- Do not put anything on the cabinet. The materials put on the cabinet will not only get damaged but also cause fire hazard by heat.

Cooling fans are provided to cool down the projector. This projector monitors internal temperature and control the running speed of the cooling fans.

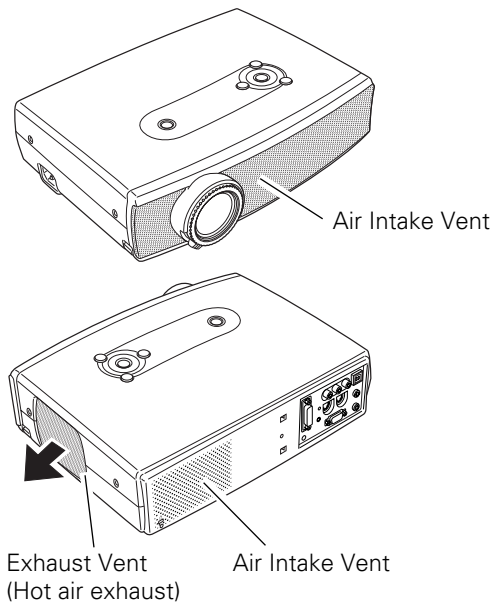

## **Installing the Projector in Proper Position**

Install the projector properly. Improper Installation may reduce the lamp life and cause a fire hazard.

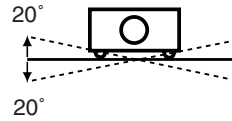

Do not tilt the projector more than 20 degrees from side to side.



Do not point the projector up to project an image.



Do not point the projector down to project an image.



Do not put the projector on either side to project an image.

## **Moving the Projector**

When moving the projector, replace the Lens Cover and retract Adjustable Feet to prevent damage to the lens and cabinet.

When the projector is not in use for an extended period, put it into the case (carrying bag) supplied with the projector.

### **CAUTION**

Carrying Bag (supplied) is intended for protection from dust and scratches on the surface of a cabinet, and it is not designed to protect an appliance from external forces. Do not transport a projector through a courier or transport services with this bag, otherwise the projector can be damaged. When handling a projector, do not drop, bump, subject it to strong forces or put other things on the cabinet.

### **USE CAUTION IN CARRYING OR TRANSPORTING THE PROJECTOR**

- Do not drop or bump a projector, otherwise damages or malfunctions may result.
- When carrying a projector, use a suitable carrying case.
- Do not transport a projector by using a courier or transport service in an unsuitable transport case. This may cause damage to a projector. To transport a projector through a courier or transport service, consult your dealer for their information.

## **Federal Communication Commission Notice**

Multimedia Projector, Model : LV-X4E, LV-X4U, LV-7230E, LV-7230U

This device complies with Part 15 of the FCC Rules. Operation is subject to the following two conditions:

- (1) This device may not cause harmful interference, and
- (2) this device must accept any interference received, including interference that may cause undesired operation.

Note : This equipment has been tested and found to comply with the limits for a Class B digital device, pursuant to part 15 of the FCC Rules. These limits are designed to provide reasonable protection against harmful interference in a residential installation. This equipment generates, uses and can radiate radio frequency energy and, if not installed and used in accordance with the instructions, may cause harmful interference to radio communications. However, there is no guarantee that interference will not occur in a particular installation. If this equipment does cause harmful interference to radio or television reception, which can be determined by turning the equipment off and on, the user is encouraged to try to correct the interference by one or more of the following measures :

- Reorient or relocate the receiving antenna.
- Increase the separation between the equipment and receiver.
- Connect the equipment into an outlet on a circuit different from that to which the receiver is connected.
- Consult the dealer or an experienced radio/TV technician for help.

Use of shielded cable is required to comply with class B limits in Subpart B of Part 15 of FCC Rules.

Do not make any changes or modifications to the equipment unless otherwise specified in the instructions. If such changes or modifications should be made, you could be required to stop operation of the equipment.

Canon U.S.A., Inc.  
One Canon Plaza, Lake Success, NY 11042, U.S.A.  
Tel No. (516)328-5600

## **Canadian Radio Interference Regulations**

This Class B digital apparatus complies with Canadian ICE-003.

### **Réglementation canadienne sur les interférences radio**

Cet appareil numérique de la classe B est conforme à la norme NMB-003 du Canada.

## **AC Power Cord Requirement**

The AC Power Cord supplied with this projector meets the requirement for use in the country you purchased it.

### **AC Power Cord for the United States and Canada :**

AC Power Cord used in the United States and Canada is listed by the Underwriters Laboratories (UL) and certified by the Canadian Standard Association (CSA).

AC Power Cord has a grounding-type AC line plug. This is a safety feature to be sure that the plug will fit into the power outlet. Do not try to defeat this safety feature. Should you be unable to insert the plug into the outlet, contact your electrician.

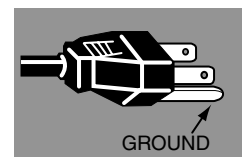

**THE SOCKET-OUTLET SHOULD BE INSTALLED NEAR THE EQUIPMENT AND EASILY ACCESSIBLE.**

# Part Names and Functions

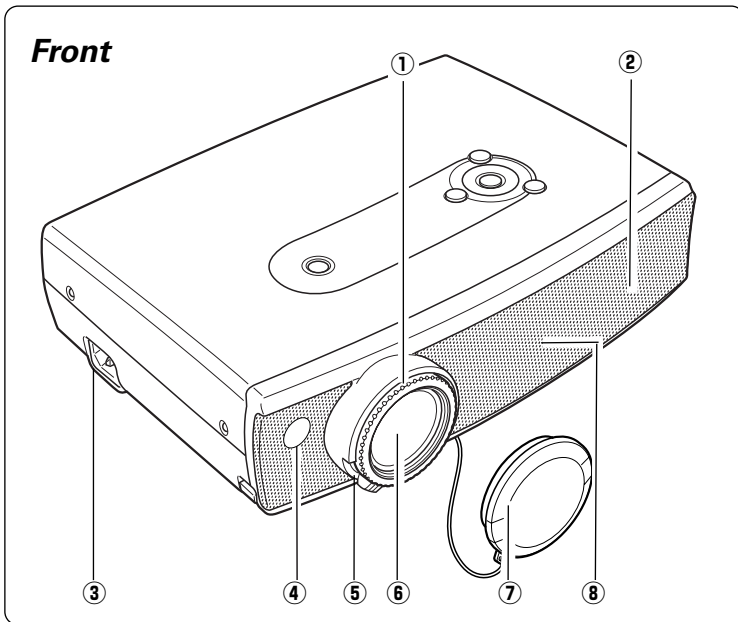

- ① Focus Ring
- ② Speaker
- ③ Power Cord Connector
- ④ Infrared Remote Receiver
- ⑤ Zoom Lever
- ⑥ Projection Lens
- ⑦ Lens Cover (See page 48 for attaching.)
- ⑧ Air Intake Vent

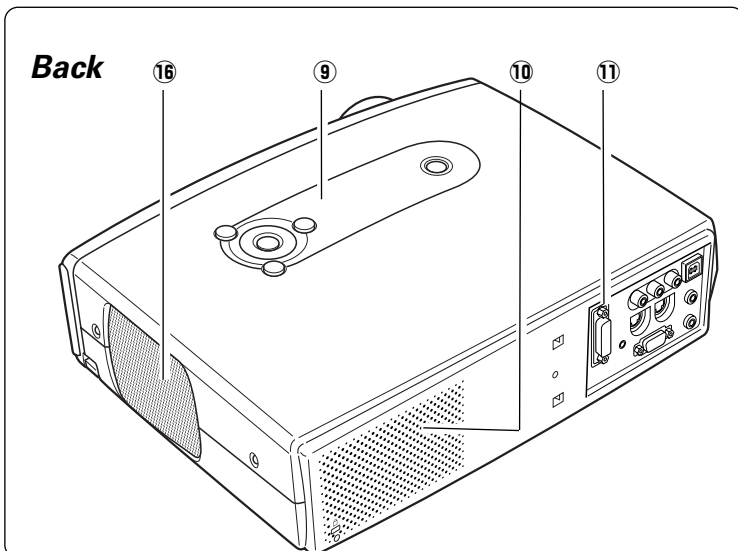

- ⑨ Top Controls and Indicators
- ⑩ Air Intake Vent
- ⑪ Terminals and Connectors

- ⑫ Air Intake Vent
- ⑬ Air Filter
- ⑭ Adjustable Feet
- ⑮ Lamp Cover

- ⑯ Exhaust Vent



Hot air is exhausted from the exhaust vent. Do not put heat-sensitive objects near this side.

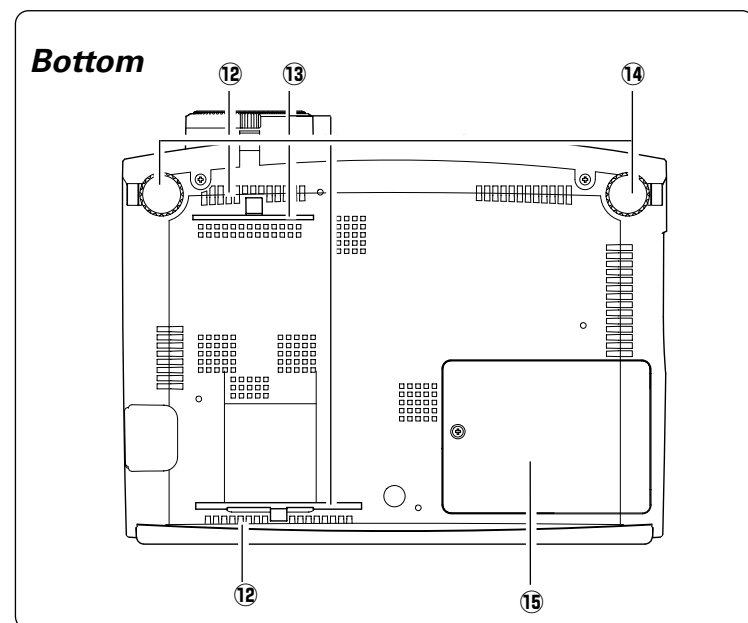



## Terminal

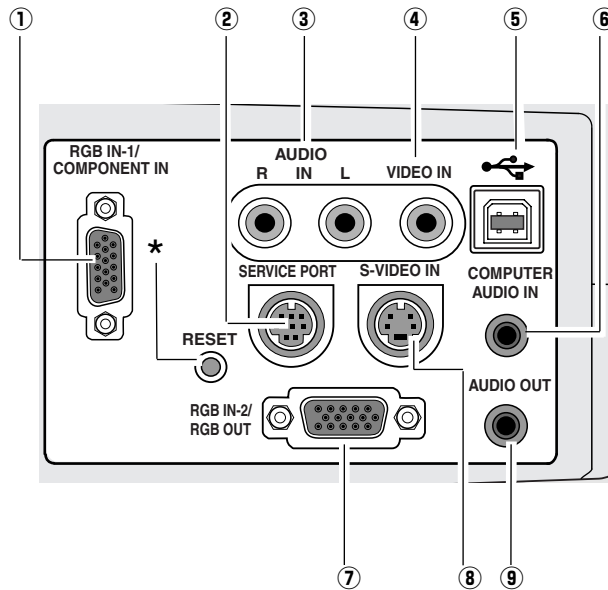

## ① RGB IN-1/ COMPONENT IN

Connect output signal from a computer (Analog RGB) or video equipment (Component or RGB Scart) to this terminal. Optional cables are required when using this terminal as component input or RGB Scart 21-Pin Video input. (p17,19)

## ② SERVICE PORT

This jack is used to service this projector.

## ③ AUDIO IN

Connect the audio output from video equipment connected to ④ or ⑧ to this jack. (When the audio output is monaural, connect it to L (MONO) jack.) (p18)

## ④ VIDEO IN

Connect the composite video output from video equipment to VIDEO jack. (p18)

## ⑤ USB (Series B)

When operating the connected computer with the remote control unit, connect USB port of your computer to this connector with a USB cable. (p17)

## ⑥ COMPUTER AUDIO IN

Connect the audio output (stereo) from a computer or video equipment connected to ① or ⑦ to this jack. (p17,19)

## ⑦ RGB IN-2 / RGB OUT

This terminal is switchable and can be used for input from a computer or output to the other monitor. Set the terminal up as either Computer input or Monitor output properly. (Used for Monitor out, this terminal outputs only incoming signal from RGB IN-1/ COMPONENT IN terminal.) (p17,43)

## ⑧ S-VIDEO IN

Connect the S-VIDEO IN output from video equipment to this jack. (p18)

## ⑨ AUDIO OUT

Connect an external audio amplifier to this jack. (p17, 18,19)  
This terminal outputs sound from AUDIO IN terminal (③ or ⑥).

\* A built-in micro processor which controls this unit may occasionally malfunction and need to be reset. This can be done by pressing the RESET button with a pen, which will shut down and restart the unit. Do not use the RESET function excessively.

## Top Control

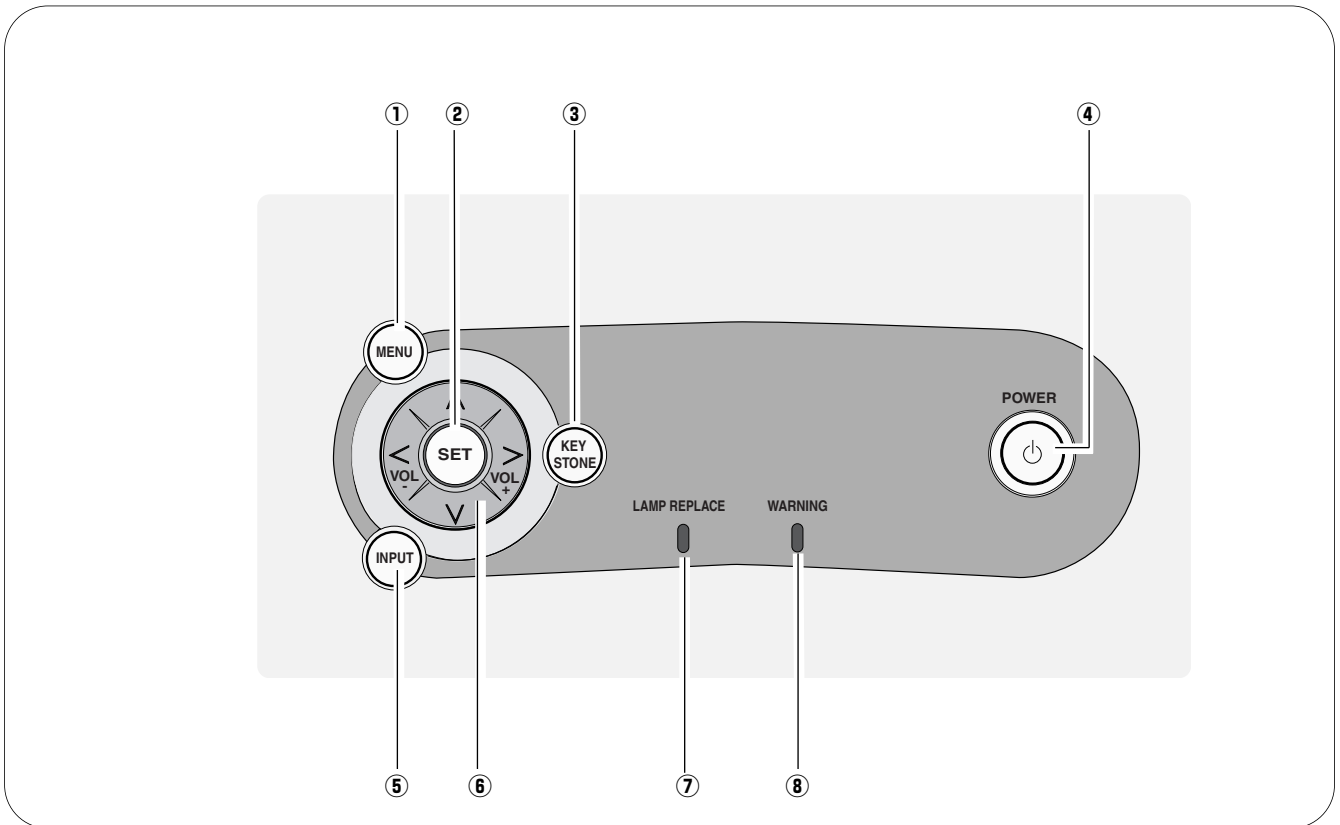

- ① **MENU button**  
Opens or closes the On-Screen Menu. (p22)
- ② **SET button**  
Executes the item selected. It is also used to expand / compress the image in Digital zoom +/- mode. (p33)
- ③ **KEYSTONE button**  
Corrects keystone distortion. (p24, 41)
- ④ **POWER button**  
Turns the projector on or off. (p20,21)
- POWER indicator**  
Blinks red until the projector gets ready to be turned on. It turns red when the projector is in the stand-by mode. It remains green while the projector is under operation. (p54)
- ⑤ **INPUT button**  
Selects input source. (p26, 34, 35 )
- ⑥ **POINT ▲▼◀▶(VOL+/-)button**  
Selects an item or adjusts value in the On-Screen Menu. These are also used to pan the image in the Digital zoom + mode. (p33)  
Point ◀▶ buttons are used as VOL +/- button. (p25)
- ⑦ **LAMP REPLACE indicator**  
Turns yellow when the life of the projection lamp draws to an end. (p50, 54)
- ⑧ **WARNING indicator**  
Lights red when the projector detects abnormal condition. This also blinks red when the internal temperature of the projector exceeds the operating range. (p47, 54)

## Remote Control Unit

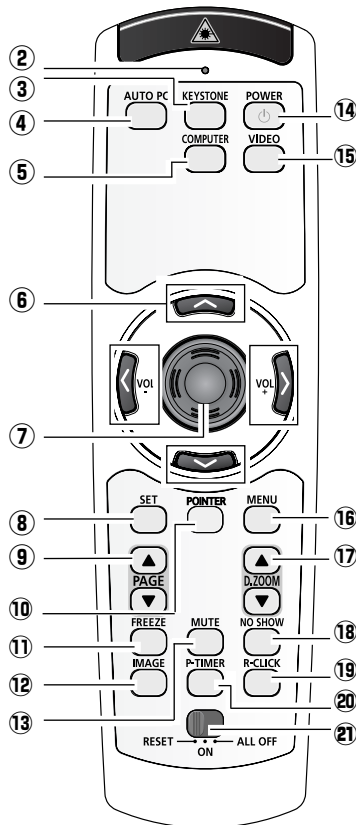
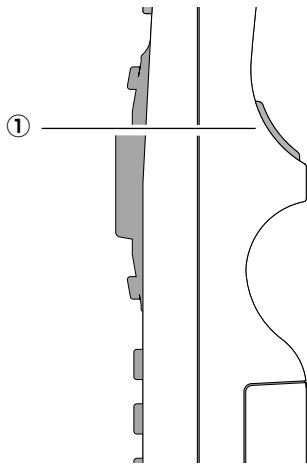

- ① **L-CLICK button**  
Acts as left click for wireless mouse operation. (p12)
- ② **SIGNAL EMISSION indicator**  
This indicator lights red while a signal is being sent from the remote control unit to the projector.
- ③ **KEYSTONE button**  
Corrects keystone distortion. (p24, 41)
- ④ **AUTO PC button**  
Operates the Auto PC adjustment function. (p28)
- ⑤ **COMPUTER button**  
Selects input source (COMPUTER 1 or COMPUTER 2). (p26)
- ⑥ **POINT (▲▼◀▶) button**  
Selects an item or adjusts value in the On-Screen Menu. These are also used to pan the image in the Digital zoom + mode. (p33)  
Point ◀▶ button are also used as VOL+/- buttons. (p25)
- ⑦ **PRESENTATION POINTER button**  
Move a pointer of the projector or a pointer for wireless mouse operation. (p12)
- ⑧ **SET button**  
Executes the item selected, or to expand or compress image in the Digital zoom +/- mode. (p33)
- ⑨ **PAGE UP/DOWN button**  
Turns pages; the Up button to the previous page and the Down button to the next page for an image from a computer. Connect the projector and your computer with a USB cable before use. (p17.)
- ⑩ **POINTER button**  
Activates the Pointer function of the projector. (p12)
- ⑪ **FREEZE button**  
Freezes the projected picture. (p24)
- ⑫ **IMAGE button**  
Selects image levels.(p31, 37)
- ⑬ **MUTE button**  
Mutes sound. (p25)
- ⑭ **POWER button**  
Turns the projector on or off. (p20,21)
- ⑮ **VIDEO button**  
Selects input source (VIDEO). (p34)
- ⑯ **MENU button**  
Opens or closes the On-Screen Menu. (p22)
- ⑰ **D.ZOOM button**  
Selects the Digital zoom +/- mode and resize the image. (p33)
- ⑱ **NO SHOW button**  
Turns the picture into black image. (p25)
- ⑲ **R-CLICK button**  
Acts as right click for wireless mouse operation. (p12)
- ⑳ **P-TIMER button**  
Operates P-Timer function. (p25)
- ㉑ **RESET/ON/ALL-OFF switch**  
When using the remote control unit, set this switch to "ON." Set it to "ALL OFF" when it is not used for energy saving. Slide this switch to the "RESET" to initialize the remote control code. (p13)

## Pointer Function

You can move Spotlight or Pointer of the projector with the remote control unit to emphasize a part of the projected image.

**✓ Note:**

You can choose the size of Spotlight (Large, Middle, and Small) and the pattern of Pointer (Arrow, Finger, and Dot) in the Setting Menu. See "Pointer" on page 44.

- 1** Press the POINTER button on the remote control unit to display the Spotlight or Pointer (Arrow, Finger or Dot) you have selected.
- 2** Move the Spotlight or Pointer with the PRESENTATION POINTER button.
- 3** To clear the Spotlight or Pointer displayed on the screen, press the POINTER button toward the projector.

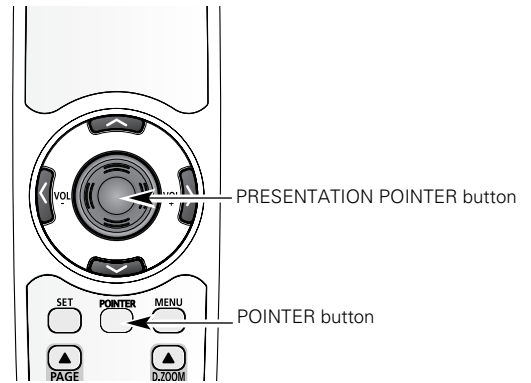

**Spotlight**

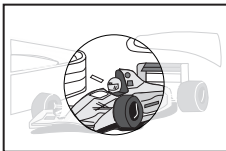

**Pointer**

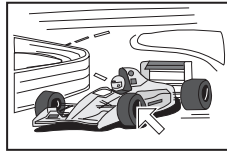

## Wireless Mouse Operation

The remote control unit can be used as a wireless mouse for your computer. Before operating the wireless mouse, connect your computer and the projector with the supplied USB cable. (See page 17 for connection.) When the Pointer function is used, the wireless mouse is not available.

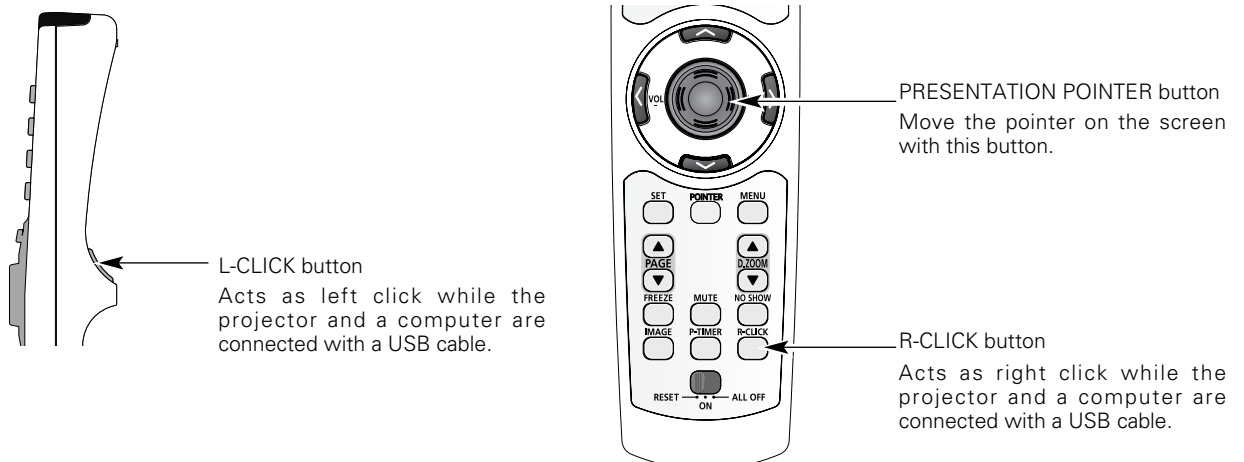

## Remote Control Code

This projector has eight different remote control codes (Code 1-Code 8); the factory-set, initial code (Code 1) and the other seven codes (Code 2 to Code 8). This switching function prevents remote control interference when operating several projectors or video equipment at the same time. (Change the remote control code for the projector first before changing that for the remote control unit. See "Remote control" on page 44.)

- 1** While pressing the MENU button, press the IMAGE button number of times corresponding to each remote control code number. Each time you press the IMAGE button, the code is changed sequentially. (See the list below.)
- 2** To initialize the remote control code for the remote control unit, slide the RESET/ON/ALL-OFF switch to the RESET, and then to the ON. The initial code is Code 1.

| Remote Control Code | Number of Times of Pressing IMAGE Button |
|---------------------|--|
| Code 1              | 1  |
| Code 2              | 2  |
| Code 3              | 3  |
| Code 4              | 4  |
| Code 5              | 5  |
| Code 6              | 6  |
| Code 7              | 7  |
| Code 8              | 8  |

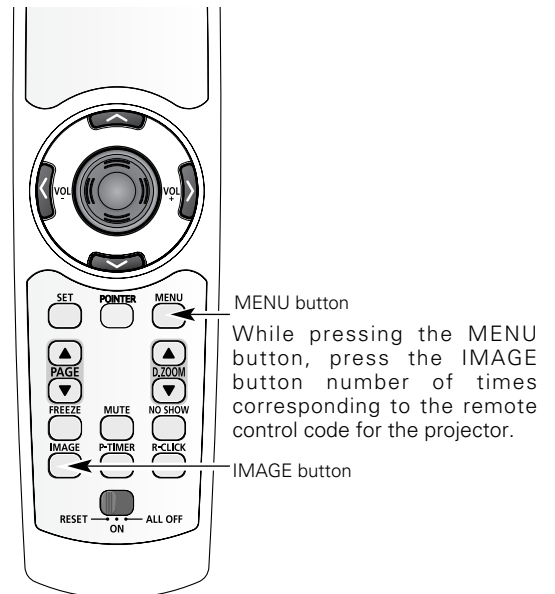

## Operating Range

Point the remote control unit toward the projector (Infrared Remote Receiver) whenever pressing any button. Maximum operating range for the remote control unit is about 16.4' (5m) and 60° in front of the projector.

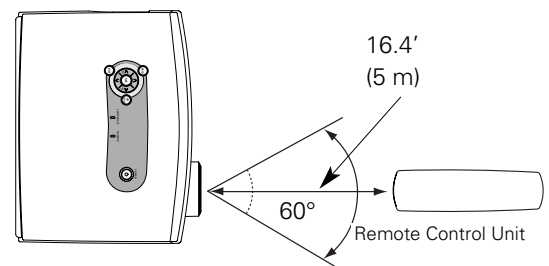

## Remote Control Battery Installation

- 1** Remove the battery compartment lid.

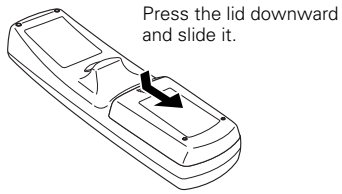

- 2** Slide the batteries into the compartment.

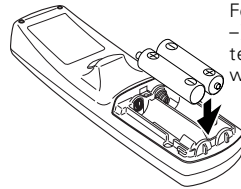

**Two AA size batteries**  
For correct polarity (+ and -), be sure battery terminals are in contact with pins in compartment.

- 3** Replace the compartment lid.

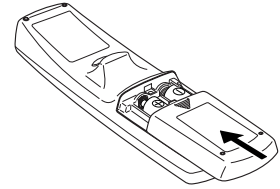

To insure safe operation, please observe the following precautions :

- Use (2) AA, UM3 or LR06 type alkaline batteries.
- Replace two batteries at the same time.
- Do not use a new battery with a used battery.
- Avoid contact with water or liquid.
- Do not expose the remote control unit to moisture or heat.
- Do not drop the remote control unit.
- If a battery has leaked on the remote control unit, carefully wipe the case clean and install new batteries.
- Risk of explosion if the battery is replaced by an incorrect type.
- Dispose of used batteries according to the instructions.

# Installation

## Positioning the Projector

This projector is designed to project on a flat projection surface and can be focused from 3.3'(1.0m) - 25.3'(7.7m). Refer to the figure and the table below for the screen size and the distance between the projector and the screen.

$$A : B = 9 : 1$$

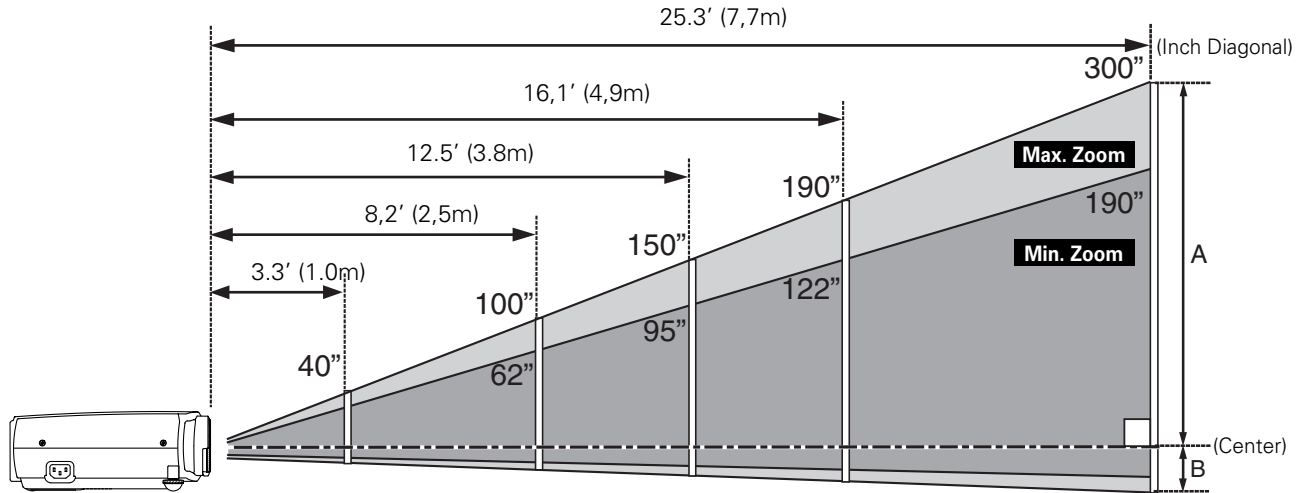

|                        |             |              |              |              |              |
|------------------------|-------------|--------------|--------------|--------------|--------------|
| Screen Size (W x H) mm | 40"         | 100"         | 150"         | 190"         | 300"         |
| 4 : 3 aspect ratio     | 813 x 610   | 2032 x 1524  | 3048 x 2286  | 3861 x 2896  | 6096 x 4572  |
| Zoom (min)             | 5.2' (1.6m) | 13.1' (4.0m) | 19.7' (6.0m) | 25.3' (7.7m) | —            |
| Zoom (max)             | 3.3' (1.0m) | 8.2' (2.5m)  | 12.5' (3.8m) | 16.1' (4.9m) | 25.3' (7.7m) |

### ✓ Note:

- The brightness in a room has a great influence on picture quality. It is recommended to limit ambient lighting in order to obtain the best image.
- The values shown above are approximate and may vary from the actual size.

## Adjustable Feet

Projection angle can be adjusted up to 11.9 degrees with the adjustable feet.

- 1** Lift the front of the projector and pull upward the feet lock latches on both sides of the projector.
- 2** Release the feet lock latches to lock the adjustable feet and rotate the adjustable feet to adjust the position and tilt.
- 3** To retract the adjustable feet, lift the front of the projector and pull and undo the feet lock latches.  
Keystone distortion of the projected image can be adjusted by menu operation. (p24, 41)

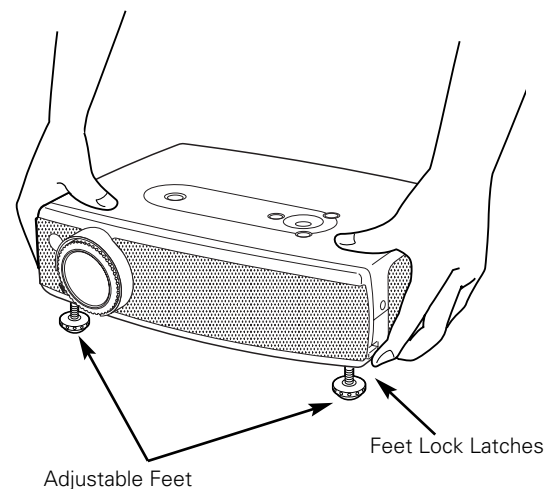

## Connecting the AC Power Cord

This projector uses nominal input voltages of 100-120 V or 200-240 V AC. This projector automatically selects the correct input voltage. It is designed to work with single-phase power systems having a grounded neutral conductor. To reduce risk of electrical shock, do not plug into any other type of power system.

Consult your authorized dealer or service station if you are not sure of the type of power being supplied.

Connect the projector with all peripheral equipment before turning the projector on. (See page 17-19 for connection.)

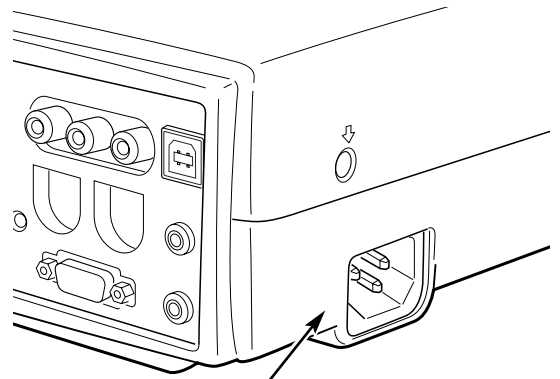

Connect AC power cord (supplied) to the projector.  
The AC outlet must be near this equipment and must be easily accessible.



### CAUTION

For safety, unplug AC power cord when the projector is not in use. When this projector is connected to an outlet with AC power cord, it is in Stand-by mode and consumes a little electric power.

### NOTE ON THE POWER CORD

AC power cord must meet requirement of the country where you use a projector. Confirm an AC plug type with the chart below and proper AC power cord must be used. If supplied AC power cord does not match your AC outlet, contact your sales dealer.

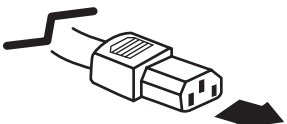
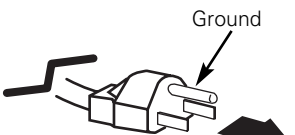
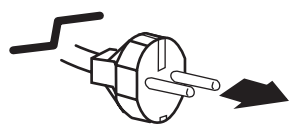
| Projector side  | AC outlet side   |   |
|---|--|---|
|  <p data-bbox="438 1400 622 1467">To power cord connector on your projector.</p> | <p data-bbox="710 1198 997 1220"><b>For the U.S.A. and Canada</b></p>  <p data-bbox="885 1243 965 1265">Ground</p> <p data-bbox="829 1400 997 1456">To the AC outlet.<br/><b>(120 V AC)</b></p> | <p data-bbox="1045 1198 1324 1220"><b>For Continental Europe</b></p>  <p data-bbox="1157 1422 1340 1478">To the AC outlet.<br/><b>(200 - 240 V AC)</b></p> |



## Connecting to a Computer

### Cables used for connection

- VGA Cable (HDB 15 pin) (Only a cable is supplied.)
  - USB Cable
  - Audio Cables (Mini Plug: stereo) \*
- (\* = Not supplied with this projector.)

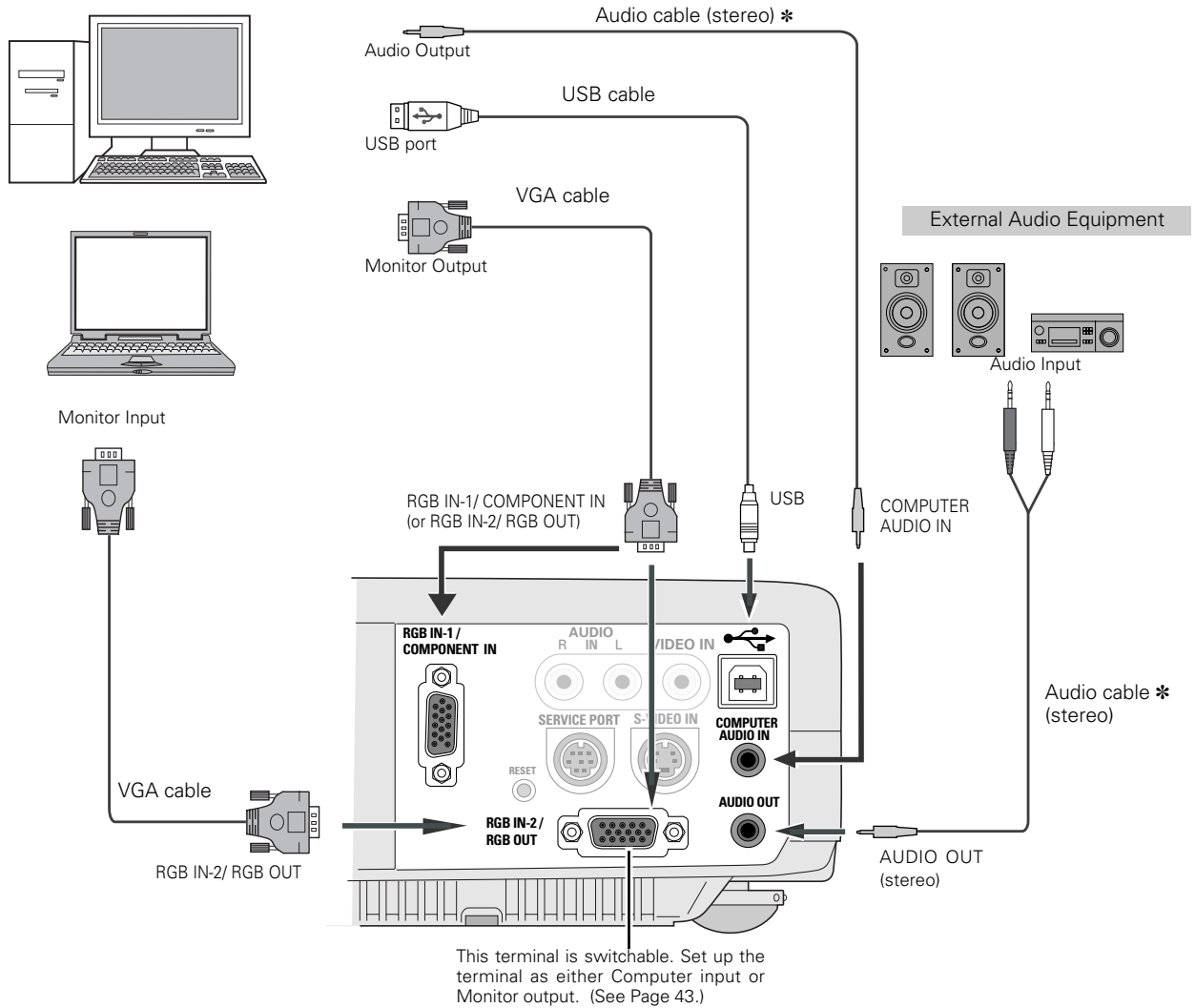

**✓ Note:**

- If you wish to use Page ▲▼ buttons on the remote control unit, connect USB port of your computer to the USB socket of the projector. (p9, 12 and 44)
- When connecting AUDIO OUT to external audio equipment, the projector's built-in speaker is disconnected.



**Note:**

When connecting the cable, the power cords of both the projector and the external equipment should be disconnected from AC outlet.

## Connecting to Video Equipment

### Cables used for connection

- Video and Audio Cable (RCA x 3) \*
  - S-VIDEO Cable \*
  - Audio Cable (Mini Plug: stereo) \*
- (\* = Not supplied with this projector.)

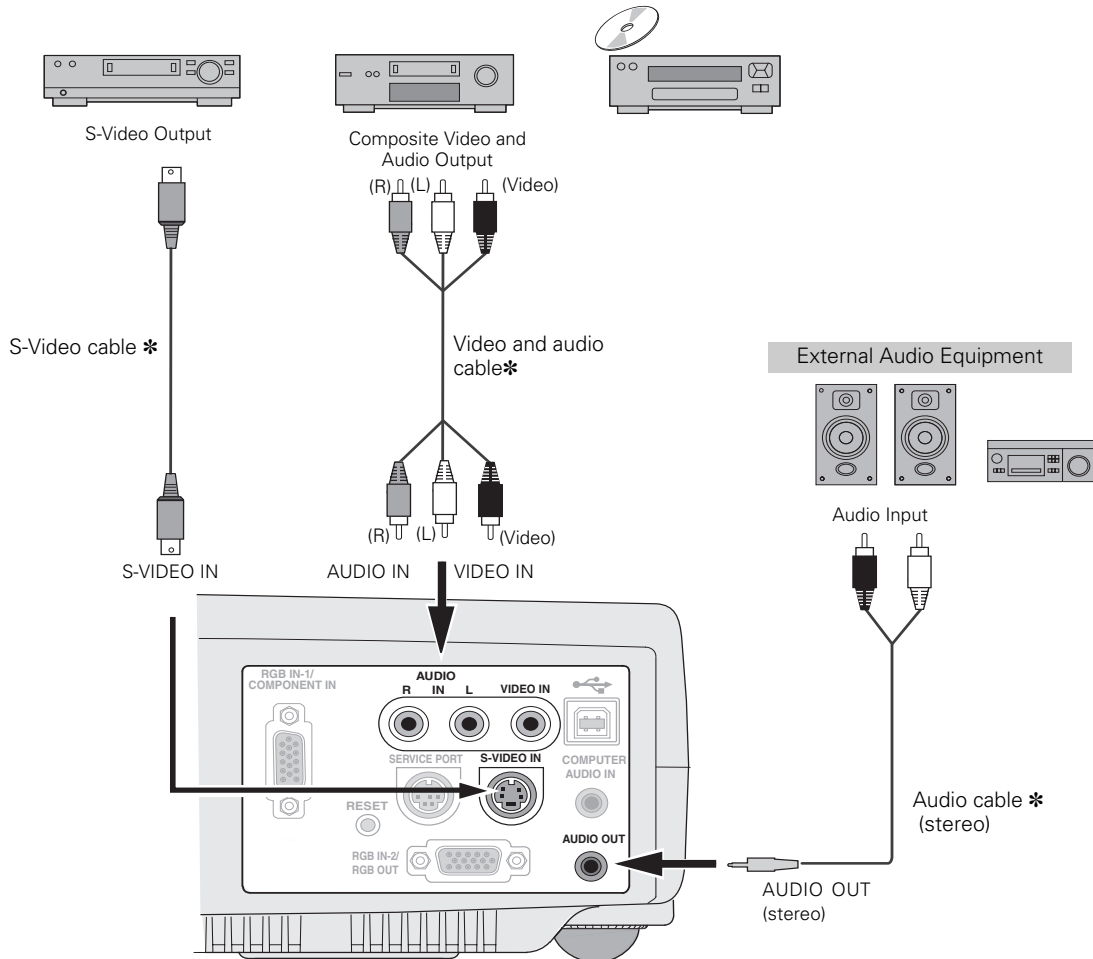

**Note:**

- The S-VIDEO jack has priority over the VIDEO jack under the condition of connecting both the S-VIDEO jack and the VIDEO jack when selecting AUTO in the Input Menu.
- When connecting AUDIO OUT to external audio equipment, the projector's built-in speaker is disconnected.



**Note:**

When connecting the cable, the power cords of both the projector and the external equipment should be disconnected from AC outlet.

## Connecting to Component Video Equipment

### Cables used for connection

- Audio Cables (Mini Plug (stereo) x 2 or RCA x 2) \*
  - Video and Audio Cable (RCA x 3) \*
  - Scart-VGA Cable \*
  - Component-VGA Cable \* (Separately supplied as LV-CA32)
- (\* = Not supplied with this projector.)

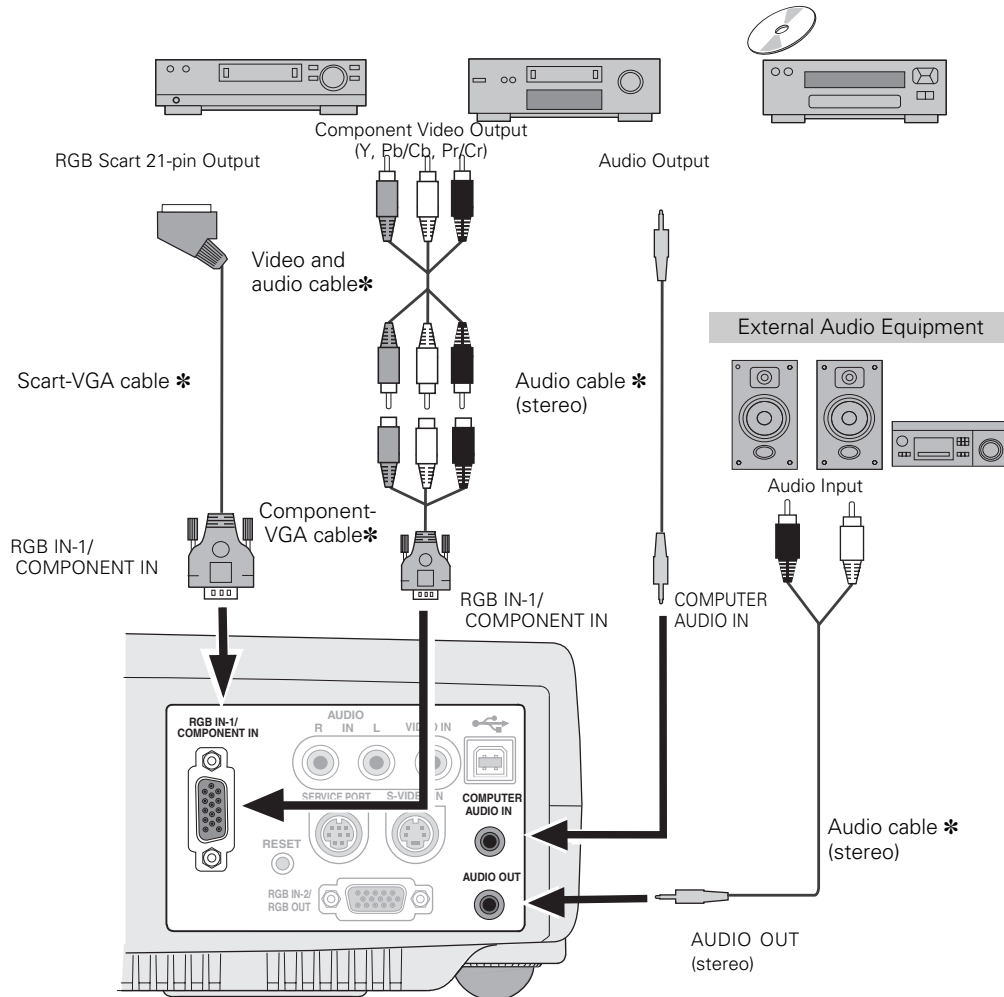

**Note:**

- Input sound to the COMPUTER AUDIO IN terminal when using the RGB IN-2/RGB OUT terminal as input.
- When connecting AUDIO OUT to external audio equipment, the projector's built-in speaker is disconnected.



**Note:**

When connecting the cable, the power cords of both the projector and the external equipment should be disconnected from AC outlet.

## Turning On the Projector

- 1 Complete peripheral connections (with a computer, VCR, etc.) before turning on the projector.
- 2 Connect the projector's AC power cord into an AC outlet. The POWER indicator blinks red in a moment and lights red.
- 3 Press the POWER button on the top control or on the remote control unit. The POWER indicator turns green lighting and the cooling fans start to operate. The preparation display appears on the screen and the count down starts.
- 4 After the count-down, the image level that was selected last and the Lamp mode status icon (see page 44) appear on the screen.

### ✓ Note:

If the projector is locked with a PIN code, PIN code Input Dialog Box will appear.  
Enter the PIN code as instructed below.

### Enter a PIN code

Select a number by pressing the Point ◀▶ button and fix the number with the SET button. The number will change to "\*". If you fixed a wrong number, move the pointer to "Set" or "Clear" once by pressing the Point ▼ button, then return to "PIN code". Enter the correct number again. Repeat this step to complete entering a four-digit number.

When the four-digit number is fixed, the pointer will automatically move to "Set". Press the SET button so that you can start to operate the projector.

If you entered a wrong PIN code, "PIN code" and the number (\*\*\*\*) will turn red and disappear. Enter a correct PIN code all over again.

### What is PIN code?

PIN code is a security code using Personal Identification Number that allows the person who knows it to operate the projector. Setting PIN code prevents others except the specific users from operating the projector.

A PIN code consists of a four-digit number. Refer to PIN code lock function in Setting on page 45 and 46 for locking operation of the projector with your PIN code.



The preparation display disappears after 30 seconds.

### Selected Image Level and Lamp Mode

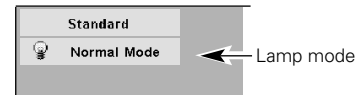

(See page 44 for Lamp mode.)

### PIN code Input Dialog Box

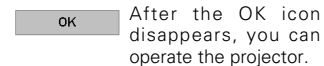

After the OK icon disappears, you can operate the projector.

## Turning Off the Projector

- 1 Press the POWER button on the top control or on the remote control unit, and a message "Power off?" appears on the screen.
- 2 Press the POWER button again to turn off the projector. The POWER indicator starts to blink red, and it continues while the cooling fans are operating for about 90 seconds. (About 120 seconds when the fan mode is L2. See page 46.)
- 3 When the projector has cooled down enough to be turned on again, the POWER indicator lights red. Then you can disconnect the AC power cord.

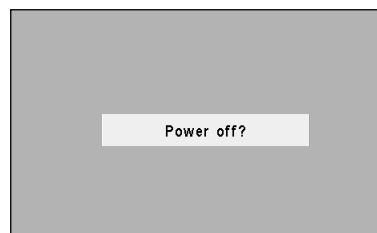

The message disappears after 4 seconds.



TO MAINTAIN THE LIFE OF LAMP, ONCE YOU TURN PROJECTOR ON, WAIT AT LEAST 5 MINUTES BEFORE TURNING IT OFF.

DO NOT DISCONNECT AC POWER CORD WHILE COOLING FANS ARE RUNNING OR BEFORE POWER INDICATOR LIGHTS RED. OTHERWISE IT WILL RESULT IN SHORTENING LAMP LIFE.

### ✓ Note:

- The projector cannot be turned on during the cooling period with the POWER indicator blinking red. You can turn it on again after the POWER indicator lights red.
- When the On start function is on, this projector is turned on automatically by connecting the AC power cord to an AC outlet. (See page 43 for the On start function.)
- Do not operate the projector continuously without rest. Continuous use may result in shortening the lamp life. Turn off the projector and give it a rest about an hour in every 24 hours.
- This projector monitors internal temperature and automatically controls the running speed of the cooling fans.
- If the WARNING indicator blinks or lights red, see "Warning Indicator" on page 47.

## How to Operate the On-Screen Menu

The projector can be adjusted or set via the On-Screen Menu. Refer to the following pages regarding each adjustment and setting procedure.

- 1 Press the MENU button to display the On-Screen Menu.
- 2 Press the Point ◀▶ button to select a Menu icon to adjust. Press the Point ▲▼ button to select an item to adjust.
- 3 Press the SET button to show the item data. Press the Point ◀▶ button to adjust the data. Refer to the following pages for respective adjustment.

✓ **Note:**

The selected item is not in effective until the SET button is pressed.

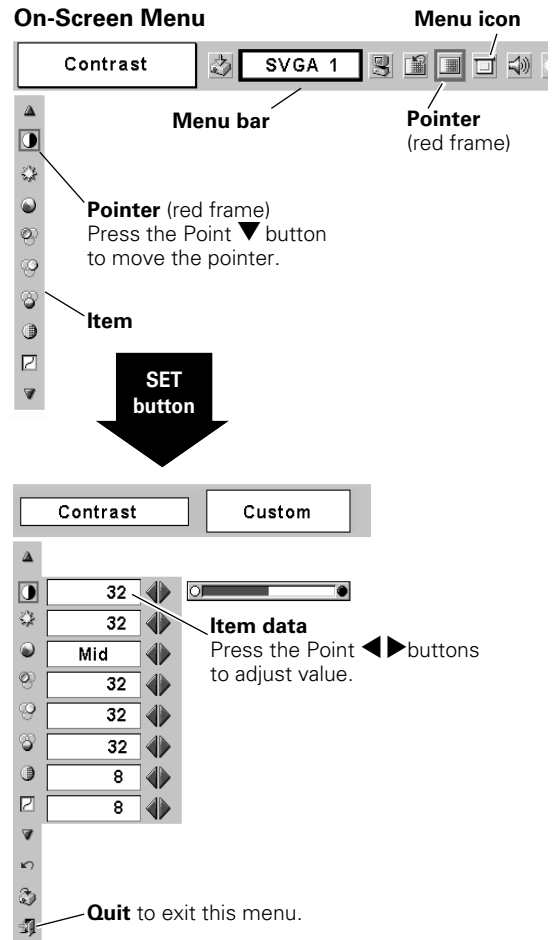

### Remote Control Unit

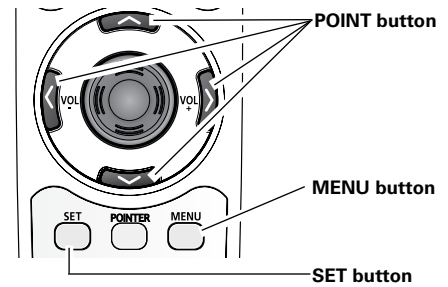

### Top Control

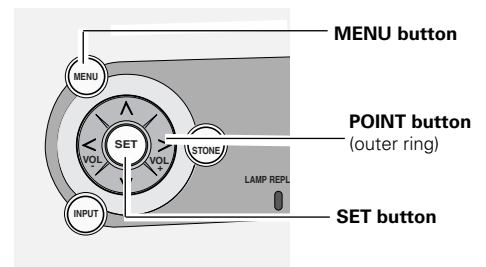

## Menu Bar

### For computer source

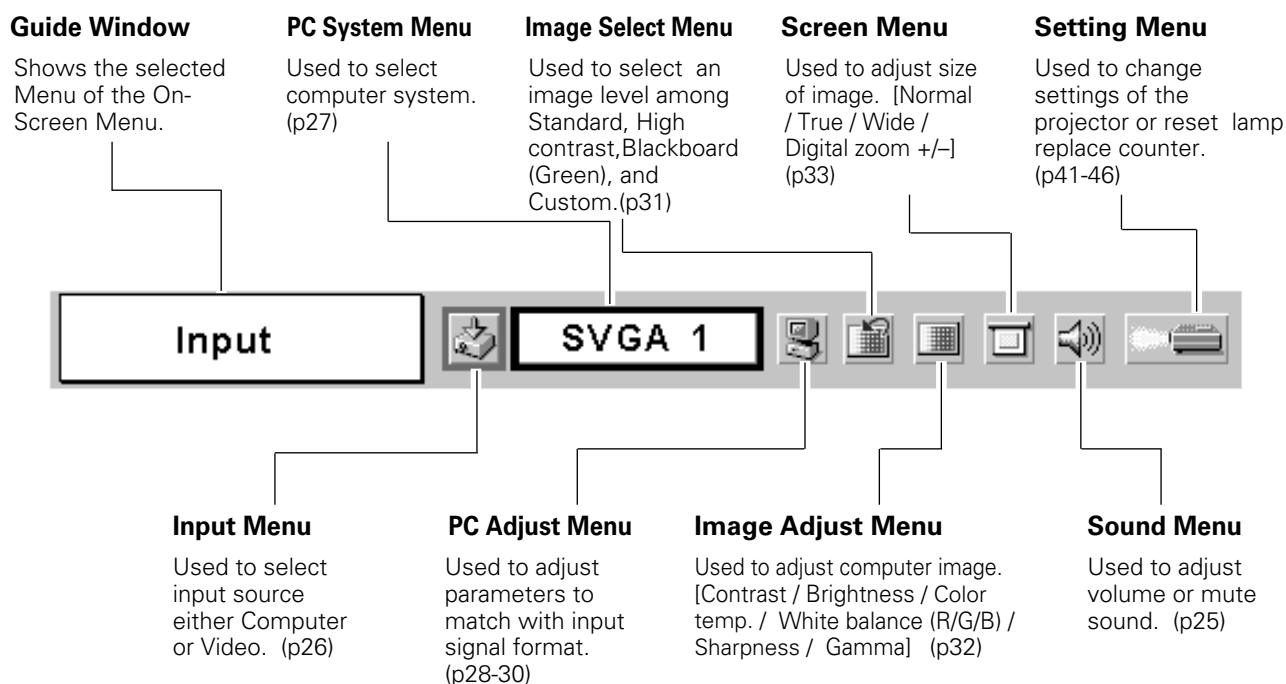

### For video source

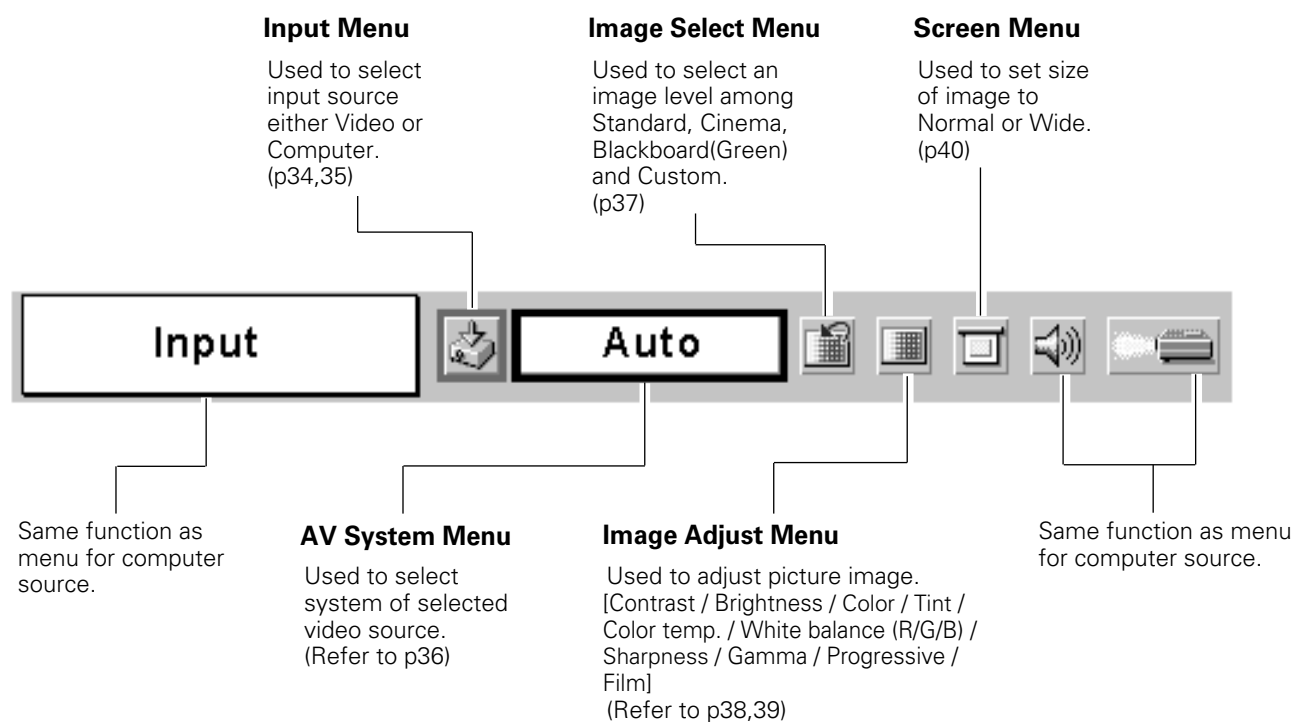

## Zoom and Focus Adjustment

Rotate the Zoom Lever to zoom in and out.

Rotate the Focus Ring to adjust the projected picture focus.

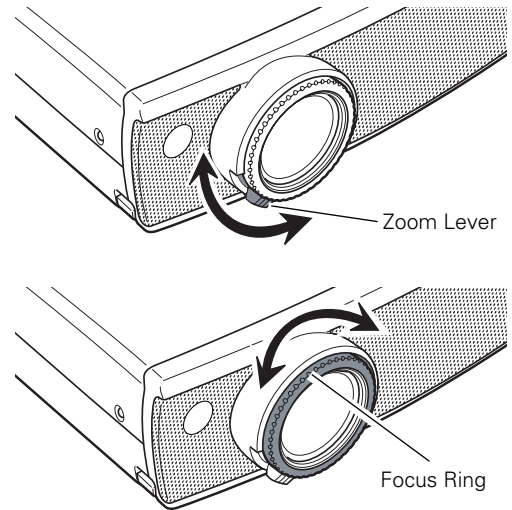

## Keystone Adjustment

If a projected picture has keystone distortion, correct the image with KEYSTONE adjustment.

- 1 Press the KEYSTONE button on the top control, the remote control unit or select Keystone in the Setting Menu (p41). The keystone dialog box appears.
- 2 Correct keystone distortion by pressing the Point ▲▼ button. Keystone adjustment can be memorized. (p41)



- The arrows are blue when there is no correction.
- The arrows disappear at the maximum correction.
- The direction of the arrow being corrected turns light blue.
- If you press the KEYSTONE button on the top control or on the remote control unit once more while the keystone dialog box is being displayed, the keystone adjustment will be canceled.

Reduce the upper width with Point ▲ button.

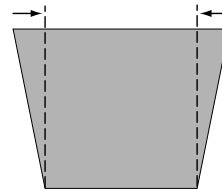

Reduce the lower width with Point ▼ button.

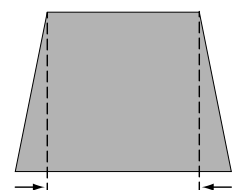

## Picture Freeze Function

Press the FREEZE button on the remote control unit to freeze the picture on the screen. To cancel the FREEZE function, press the FREEZE button again. (p11)



## No Show Function

Press the NO SHOW button on the remote control unit to black out the image. To restore to normal, press the NO SHOW button again or press any other button. When a projected image is captured and set as "User" in the Logo item in the Setting Menu (p42), the screen changes each time you press the NO SHOW button as follows.

black out → the captured image → normal → .....



The message disappears after 4 seconds.

## P-Timer Function

Press the P-TIMER button on the remote control unit. The timer display "00 : 00" appears on the screen and the timer starts to count time (00 : 00 ~ 59 : 59).

To stop the P-Timer, press the P-TIMER button. And then, press the P-TIMER button again to cancel the P-Timer function.



## Sound Adjustment

### Direct Operation

#### Volume

Press the VOL (+/-) button on the top control or on the remote control unit to adjust volume. The volume dialog box appears on the screen for a few seconds.

(+) button to turn up the volume and (-) button to turn down the volume.

#### Mute

Press the MUTE button on the remote control unit to cut off sound. To restore sound to its previous level, press the MUTE button again or press the VOL (+/-) button.

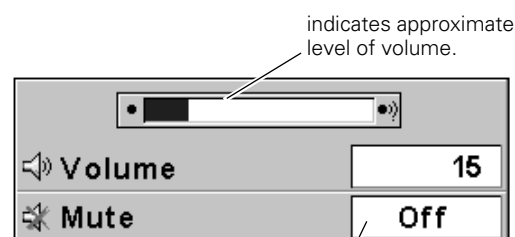

Press the MUTE button to set the Mute function On or Off.

The display disappears after 4 seconds.

### Menu Operation

**1** Press the MENU button and the On-Screen Menu will appear. Press the Point ◀▶ button to move the red frame pointer to the Sound Menu icon.

**2** Press the Point ▼ button to move the red frame pointer to the item that you want to select, and then press the SET button.

#### Volume

Press the Point ▶ button to turn up the volume, and press the Point ◀ button to turn down the volume.

#### Mute

Press the Point ◀▶ button to cut off sound. Dialog box display is changed to "On" and sound is cut off. To restore sound to its previous level, press the Point ▶ button again.

### Sound Menu

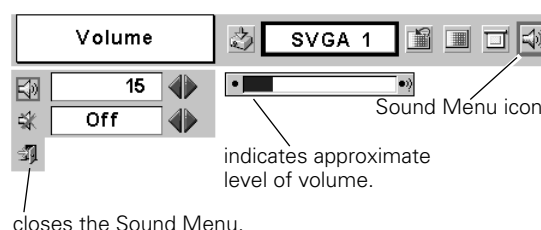

## Input Source Selection

### Direct Operation

Choose either Computer 1 or Computer 2 by pressing the INPUT button on the top control or press the COMPUTER button on the remote control unit.

Before using these buttons, correct input source should be selected through menu operation as described below.

#### INPUT button

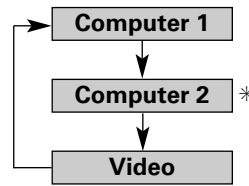

#### COMPUTER button

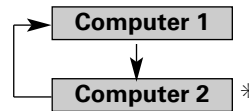

\* See Note on the bottom of this page.

### Menu Operation

- 1 Press the MENU button and the On-Screen Menu will appear. Press the Point ◀▶ button to move the red frame pointer to the Input Menu icon.
- 2 Press the Point ▼ button to move the red arrow pointer to either Computer 1 or Computer 2, and then press the SET button.
- 3 After the Source Select Menu appears for Computer 1, move the pointer to RGB and then press the SET button.

**RGB** When the input source is analog coming from a computer through the RGB IN-1/ COMPONENT IN terminal, select RGB.

**Component** See "Selecting Input Source (Component / RGB-Scart 21-pin )" on p35.

**RGB (Scart)** See "Selecting Input Source (Component / RGB-Scart 21-pin )" on p35.

#### ✓ Note:

Computer 2 is not displayed when the RGB IN-2/ RGB OUT terminal is used as Monitor out. (p43)

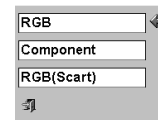
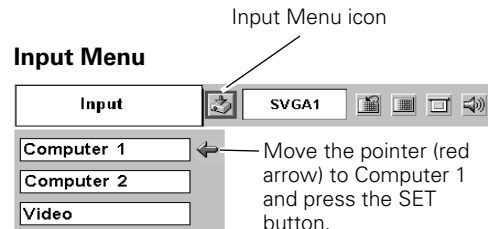

#### Source Select Menu

Move the pointer to RGB and press the SET button.

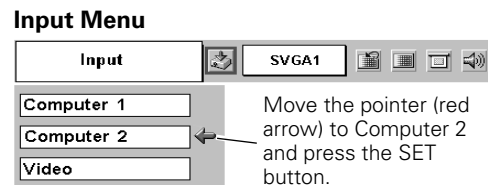

## Computer System Selection

This projector automatically tunes to various types of computers based on VGA, SVGA, XGA or SXGA with its Multi-scan system and Auto PC Adjustment. If Computer is selected as a signal source, this projector automatically detects the signal format and tunes to project a proper image without any additional setting. (Signal formats provided in this projector is shown on page 57 )

✓ **Note:**

The projector may display one of the following messages.

**Auto**

When the projector cannot recognize connected signal conforming to PC Systems provided in this projector, Auto PC Adjustment function works to display proper images and the message "Auto" is displayed on the PC System menu box. When the image is not projected properly, manual adjustment is required. (p29,30 )

-----

There is no signal input from computer. Check the connection of your computer and the projector. ( " Troubleshooting" p52 )

**Mode 1**

User preset system manually adjusted in PC Adjust menu. Adjustment data can be stored in Mode 1 - 5. ( p29,30 )

**SVGA 1**

PC Systems provided in the projector. The projector chooses a proper system and displays it.

\*Mode 1 and SVGA 1 are examples.

### PC System Menu

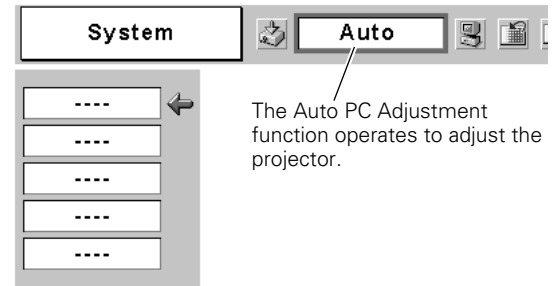

### Selecting Computer System Manually

PC system can also be selected manually.

- 1** Press the MENU button and the On-Screen Menu will appear. Press the Point ◀▶ button to move the red frame pointer to the PC System Menu icon.
- 2** Press the Point ▼ button to move the red arrow pointer to the system that you want to set, and then press the SET button.

### PC System Menu

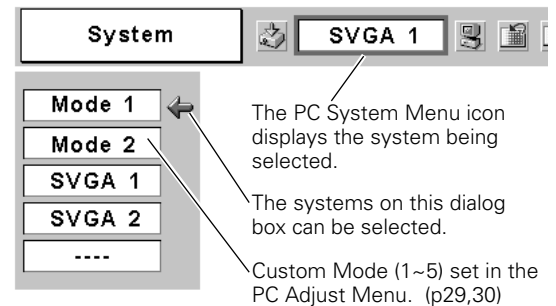

## Auto PC Adjustment

Auto PC Adjustment function is provided to automatically adjust Fine sync, Total dots, Horizontal, and Vertical to conform to your computer. Auto PC Adjustment function can be operated as follows.

### Auto PC Adj.

- 1 Press the MENU button to display the On-Screen Menu. Press the Point ◀▶ button to move the red frame pointer to PC Adjust Menu icon.
- 2 Press the Point ▼ button to move the red frame pointer to Auto PC Adj. icon and then press the SET button twice. This Auto PC Adjustment can be also executed by pressing the Auto PC button on the remote control unit.

### To store adjustment parameters

Adjustment parameters from Auto PC Adjustment can be memorized in this projector. Once parameters are memorized, the setting can be done just by selecting Mode in the PC System Menu (p27). See "Store" on page 30.

### ✓ Note:

- Fine sync, Total dots and Picture Position of some computers can not be fully adjusted with this Auto PC Adjustment function. When the image is not provided properly with this operation, manual adjustments are required. (p29,30)
- The Auto PC Adjust cannot be operated when 480i, 575i, 480p, 575p, 720p, 1035i, or 1080i is selected in the PC System Menu.

### PC Adjust Menu

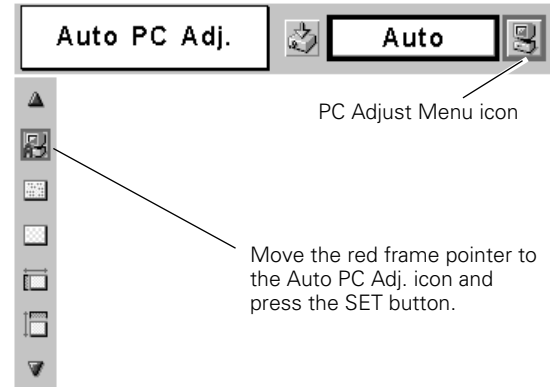

## Manual PC Adjustment

Some computers employ special signal formats which may not be tuned by Multi-scan system of this projector. Manual PC Adjustment enables you to precisely adjust several parameters to match those signal formats. The projector has 5 independent memory areas to memorize those parameters manually adjusted. It allows you to recall the setting for a specific computer.

- 1 Press the MENU button and the On-Screen Menu will appear. Press the Point ◀▶ button to move the red frame pointer to the PC Adjust Menu icon.
- 2 Press the Point ▼ button to move the red frame pointer to the item that you want to adjust and then press the SET button. An adjustment dialog box will appear. Press the Point ◀▶ button to adjust value.

### **Fine sync**

Eliminates flicker from the image displayed. Press the Point ◀▶ button to adjust value. (From 0 to 31)

### **Total dots**

Adjusts the number of total dots in one horizontal period. Press the Point ◀▶ button and adjust number to match your PC image.

### **Horizontal**

Adjusts horizontal picture position. Press the Point ◀▶ button to adjust the position.

### **Vertical**

Adjusts vertical picture position. Press the Point ◀▶ button to adjust the position.

### **Current mode**

Press the SET button to show H-Freq. and V-Freq. of the connected computer.

### **Clamp**

Adjusts clamp level. When the image has dark bars, try this adjustment.

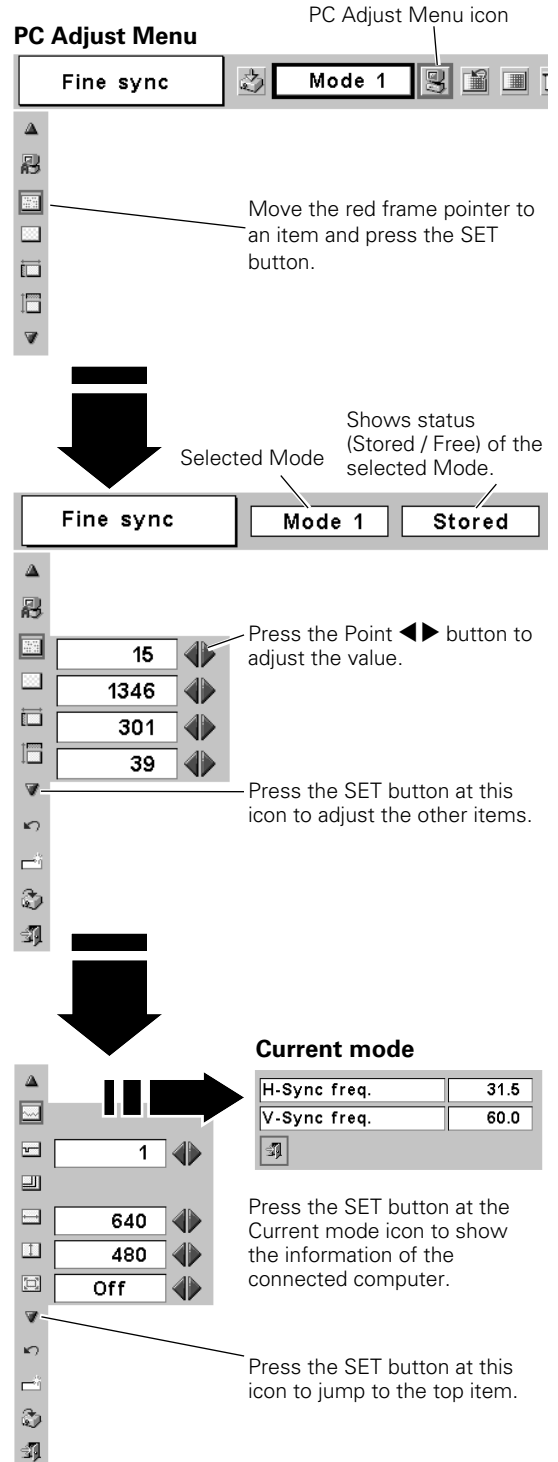

**PC Adjust Menu**

PC Adjust Menu icon

Fine sync Mode 1

Move the red frame pointer to an item and press the SET button.

Shows status (Stored / Free) of the selected Mode.

Fine sync Mode 1 Stored

Selected Mode

Press the Point ◀▶ button to adjust the value.

15 1346 301 39

Press the SET button at this icon to adjust the other items.

**Current mode**

|              |      |
|--------------|------|
| H-Sync freq. | 31.5 |
| V-Sync freq. | 60.0 |

Press the SET button at the Current mode icon to show the information of the connected computer.

1 640 480 Off

Press the SET button at this icon to jump to the top item.

 **Display area**

Select the resolution at the Display area dialog box.

 **Display area H**

Adjusts the horizontal area displayed by this projector. Press the Point ◀▶ button to decrease/increase value and then press the SET button.

 **Display area V**

Adjusts the vertical area displayed by this projector. Press the Point ◀▶ button to decrease/increase value and then press the SET button.

 **Full screen**

With this function on, SXGA image is fully displayed at 4 : 3 aspect ratio. It is displayed at 5 : 4 aspect ratio with this function off.

 **Reset**

Resets all adjustment to their previous levels.

 **Mode free**

To clear adjustment data previously set, move the red frame pointer to the Mode free icon and then press the SET button. Move the red arrow pointer to the Mode that you want to clear and then press the SET button.

 **Store**

To store adjustment data, move the red frame pointer to the Store icon and then press the SET button. Move the red arrow pointer to any of Mode 1 to 5 in which you want to store and then press the SET button.

 **Quit**

Exits the PC Adjust Menu.

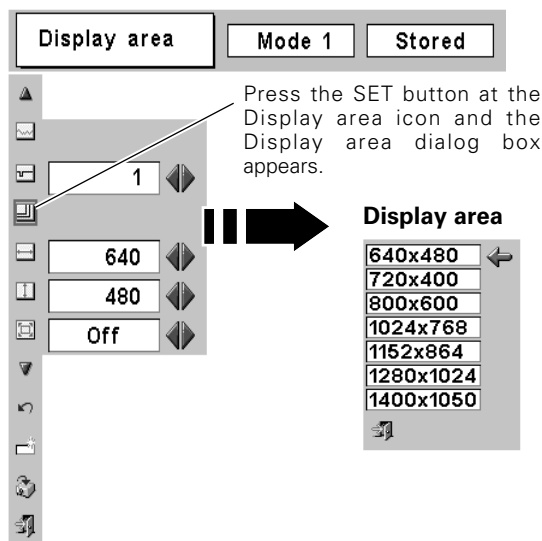

**To clear adjustment data**

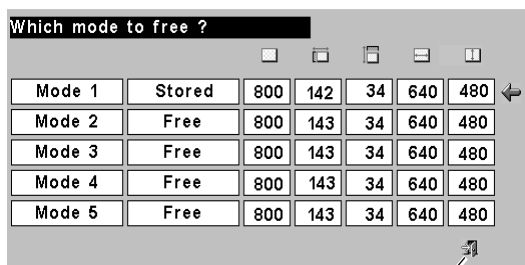

**To store adjustment data**

This Mode has parameters being stored.

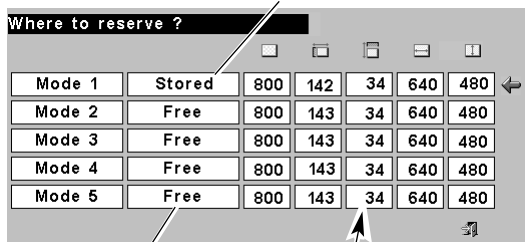

✓ **Note:**

Auto PC Adjust, Display area, Display area (H/V), and Full screen cannot be selected when "480i", "575i", "480p", "575p", "720p", "1035i", or "1080i" is selected in the PC System Menu (p27).

## Image Level Selection

### Direct Operation

Select an image level among Standard, High contrast, Blackboard(Green), Custom by pressing the IMAGE button on the remote control unit.

#### Standard

Normal picture level preset on this projector.

#### High contrast

Picture adjustment improved in reproduction of the halftones. This adjustment is suitable for providing a better image in a brighter place.

#### Blackboard(Green)

Picture level suitable for the image projected on a blackboard. This mode assists to enhance the image projected on a blackboard. This is mainly effective on a green colored board, not truly effective on a black colored board.

#### Custom

User preset image in the Image Adjust Menu (p32).

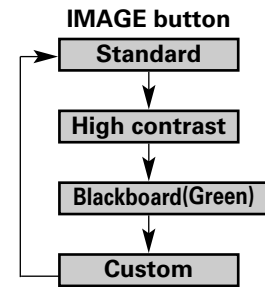

### Menu Operation

- 1 Press the MENU button and the On-Screen Menu will appear. Press the Point ◀▶ button to move the red frame pointer to the Image Select Menu icon.
- 2 Press the Point ▼ button to move the red frame pointer to the level that you want to set and then press the SET button.



#### Standard

Normal picture level preset on this projector.



#### High contrast

Picture adjustment improved in reproduction of the halftones. This adjustment is suitable for providing a better image in a brighter place.



#### Blackboard(Green)

Picture level suitable for the image projected on a blackboard. See above for further description.



#### Custom

User preset image in the Image Adjust Menu (p32).

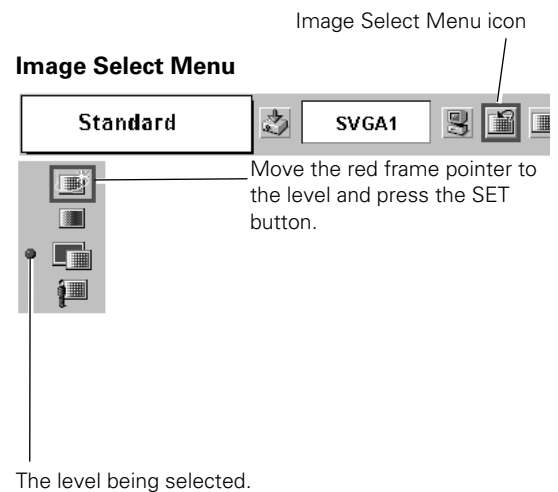

## Image Level Adjustment

**1** Press the MENU button and the On-Screen Menu will appear. Press the Point ◀▶ button to move the red frame pointer to the Image Adjust Menu icon.

**2** Press the Point ▼ button to move the red frame pointer to the item that you want to adjust, and then press the SET button. The level of each item is displayed. Adjust each level by pressing the Point ◀▶ button.

### Contrast

Press the Point ◀ button to decrease contrast and the Point ▶ button to increase contrast. (From 0 to 63.)

### Brightness

Press the Point ◀ button to adjust image darker and the Point ▶ button to adjust image brighter. (From 0 to 63.)

### Color temp.

Press the Point ◀ button or the Point ▶ button for Color temp. level that you want to select. (XLow, Low, Mid, or High)

### White balance (Red)

Press the Point ◀ button to lighten red tone and the Point ▶ button to deepen red tone. (From 0 to 63.)

### White balance (Green)

Press the Point ◀ button to lighten green tone and the Point ▶ button to deepen green tone. (From 0 to 63.)

### White balance (Blue)

Press the Point ◀ button to lighten blue tone and the Point ▶ button to deepen blue tone. (From 0 to 63.)

### Sharpness

Press the Point ◀ button to soften the image and the Point ▶ button to sharpen the image. (From 0 to 15.)

### Gamma

Press the Point ◀▶ button to obtain better balance of contrast. (From 0 to 15.)

### Reset

Resets all adjustment to their previous levels.

### Store

To store the image data adjusted manually, move the red frame pointer to the Store icon and press the SET button. The message "OK?" will appear. Select [Yes] to store manual adjustment. To set this manual adjustment, select Custom by pressing the IMAGE button or through the Image Select Menu (p31).

### Quit

Closes the Image Adjust Menu.

### Image Adjust Menu

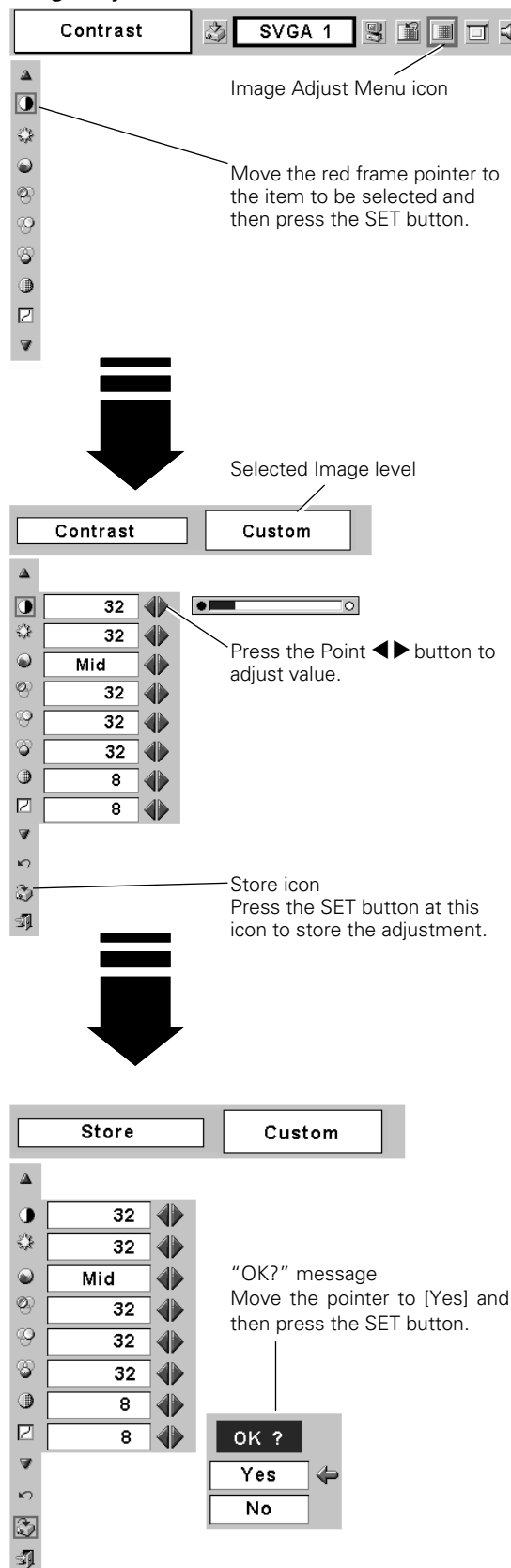



## Screen Size Adjustment

This projector has a picture screen resize function, which enables you to display the desirable image size.

- 1 Press the MENU button and the On-Screen Menu will appear. Press the Point ◀▶ button to move the red frame pointer to the Screen Menu icon.
- 2 Press the Point ▼ button and move the red frame pointer to the function that you want to select and then press the SET button.

### Normal

Provides image to fit screen size.

### True

Provides image in its original size. When the original image size is larger than the screen size (1024 x 768), this projector enters "Digital zoom +" mode automatically.

### Wide

Provides image to fit wide video aspect ratio (16 : 9) by expanding image width uniformly. This function can be used for providing a squeezed video signal at 16 : 9.

### Digital zoom +

When the Digital zoom + is selected, the On-Screen Menu disappears and the message "D. Zoom +" is displayed. Press the SET button to expand the image size. And press the Point ▲▼◀▶ button to pan the image. The Panning function can work only when the image is larger than the screen size.

A projected image can be also expanded by pressing the D.ZOOM ▲ button on the remote control unit.

### Digital zoom -

When the Digital zoom - is selected, the On-Screen Menu disappears and the message "D. Zoom -" is displayed. Press the SET button to compress the image size.

A projected image can be also compressed by pressing the D.ZOOM ▼ button on the remote control unit.

To exit the Digital Zoom +/- mode, press any button except the D.ZOOM ▲/▼, SET, and Point button.

To return to the previous screen before adjusting the screen size, select Screen size from the Screen Size Adjustment or Input source from the Input Source Selection (p26) again, or adjust the screen size with the D.ZOOM or the SET button.

### Screen Menu

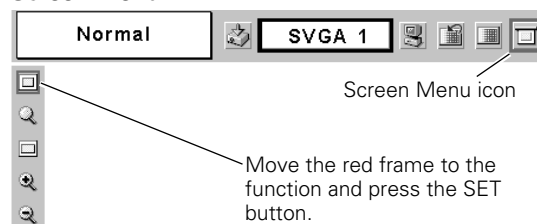

### ✓ Note:

- This Screen Menu cannot be operated when "720p(HDTV)", "1035i (HDTV)", or "1080i (HDTV)" is selected in the PC System Menu (p27).
- The True and Digital zoom +/- cannot be selected when "480i", "575i", "480p", or "575p" is selected in the PC System Menu (p27).
- This projector cannot display any resolution higher than 1280 X 1024. If your computer's screen resolution is higher than 1280 X 1024, reset the resolution to the lower before connecting to the projector.
- The image data in other than XGA (1024 x 768) is modified to fit the screen size in initial mode.
- The panning function may not operate properly if the computer system prepared in the PC Adjust Menu is used.

# Video Input

## Input Source Selection (Video, S-Video)

### Direct Operation

Choose Video by pressing the INPUT button on the top control or the VIDEO button on the remote control unit.

Before using these buttons, correct input source should be selected through menu operation as described below.

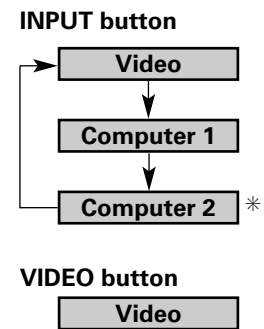

\* See Note on the bottom of this page.

### Menu Operation

- 1 Press the MENU button and the On-Screen Menu will appear. Press the Point ◀▶ button to move the red frame pointer to the Input Menu icon.
- 2 Press the Point ▼ button to move the red arrow pointer to Video and then press the SET button. The Source Select Menu will appear.
- 3 Move the pointer to the source that you want to select and then press the SET button.

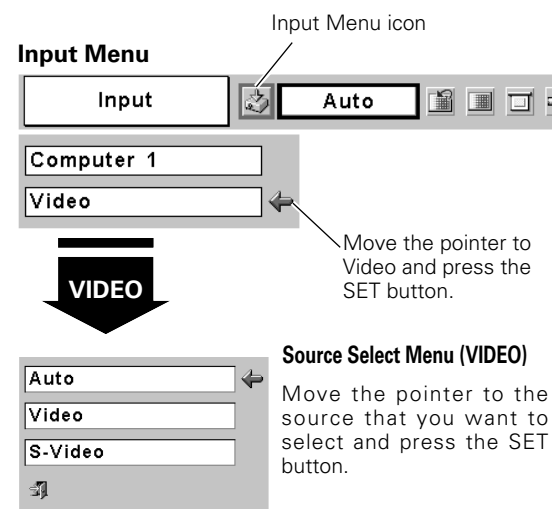

#### Auto

When selecting Auto, the projector automatically detects incoming video signal, and adjusts itself to optimize its performance. The projector selects connection in the following order:

- 1st S-Video
- 2nd Video

The S-VIDEO jack has priority over the VIDEO jack under the condition of connecting both the S-VIDEO jack and the VIDEO jack.

#### Video

When video input signal is connected to the VIDEO jack, select Video.

#### S-Video

When video input signal is connected to the S-VIDEO jack, select S-Video.

#### ✓ Note:

When Monitor out is selected at the Terminal item in the Setting Menu, Computer 2 is not displayed. (p43)

## Input Source Selection (Component, RGB Scart 21-Pin)

### Direct Operation

Choose Computer 1 by pressing the INPUT button on the top control or press the COMPUTER button on the remote control unit.

Before using these buttons, correct input source should be selected through menu operation as described below.

#### INPUT button

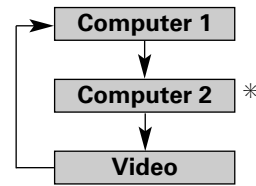

#### COMPUTER button

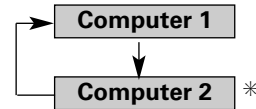

\* See Note on the bottom of this page.

### Menu Operation

- 1 Press the MENU button and the On-Screen Menu will appear. Press the Point ◀▶ button to move the red frame pointer to the Input Menu icon.
- 2 Press the Point ▼ button to move the red arrow pointer to Computer 1, and then press the SET button. The Source Select Menu will appear.
- 3 Move the pointer to the correct input source and then press the SET button.

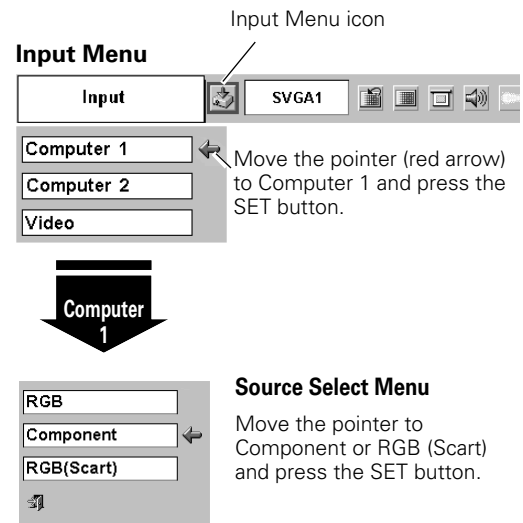

**Component** When the input source is coming from video equipment connected to the RGB IN-1/ COMPONENT IN terminal with a Component-VGA Cable, select Component.

**RGB (Scart)** When the input source is coming from video equipment connected to the RGB IN-1/ COMPONENT IN terminal with a Scart-VGA Cable, select RGB (Scart).

✓ **Note:**

- Component-VGA Cable and Scart-VGA Cable are optionally supplied. See page 60 for order.
- Computer 2 is not displayed when the RGB IN-2/RGB OUT terminal is used as Monitor out. (p43)

### Video System Selection

- 1 Press the MENU button and the On-Screen Menu will appear. Press the Point ◀▶ button to move the red frame pointer to the AV System Menu icon.
- 2 Press the Point ▼ button to move the red arrow pointer to the system that you want to select and then press the SET button.

#### Video or S-Video

##### Auto

The projector automatically detects incoming video system, and adjusts itself to optimize its performance. When Video System is PAL-M or PAL-N, select system manually.

##### **PAL / SECAM / NTSC / NTSC4.43 / PAL-M / PAL-N**

If the projector cannot reproduce proper video image, it is necessary to select a specific broadcast signal format among PAL, SECAM, NTSC, NTSC 4.43, PAL-M, and PAL-N.

#### AV System Menu (Video or S-Video)

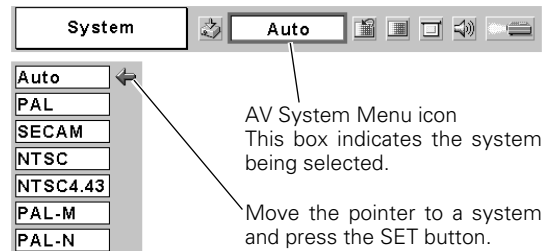

#### Component

##### Auto

The projector automatically detects incoming video signal, and adjusts itself to optimize its performance.

##### **COMPONENT VIDEO SIGNAL FORMAT**

If the projector cannot reproduce proper video image, it is necessary to select a specific component video signal format among 480i, 575i, 480p, 575p, 720p, 1035i, and 1080i.

#### AV System Menu (Component)

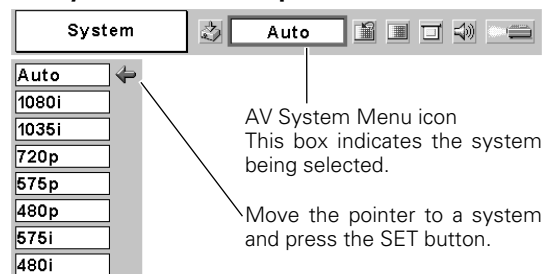

#### ✓ Note:

The AV System Menu cannot be selected when selecting RGB(Scart).

## Image Level Selection

### Direct Operation

Select a desired image level among Standard, Cinema, Blackboard (Green), Custom by pressing the IMAGE button on the remote control unit.

#### Standard

Normal picture level preset on this projector.

#### Cinema

Picture level adjusted for the picture with fine tone.

#### Blackboard(Green)

Picture level suitable for the image projected on a blackboard. This mode assists to enhance the image projected on a blackboard. This is mainly effective on a green colored board, not truly effective on a black colored board.

#### Custom

User preset image in the Image Adjust Menu (p38,39).

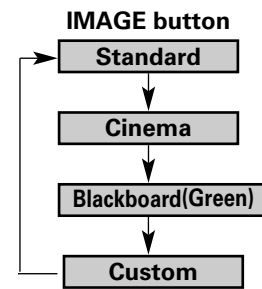

### Menu Operation

- 1 Press the MENU button and the On-Screen Menu will appear. Press the Point ◀▶ button to move the red frame pointer to the Image Select Menu icon.
- 2 Press the Point ▼ button to move the red frame pointer to the level that you want to set and then press the SET button.



#### Standard

Normal picture level preset on this projector.



#### Cinema

Picture level adjusted for the picture with fine tone.



#### Blackboard(Green)

Picture level suitable for the image projected on a Blackboard. See above for further description.



#### Custom

User preset image in the Image Adjust Menu (p38,39).

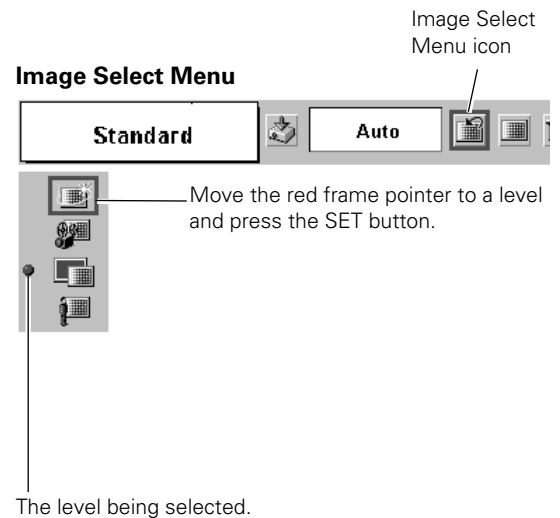

## Image Level Adjustment

- 1 Press the MENU button and the On-Screen Menu will appear. Press the Point ◀▶ button to move the red frame pointer to the Image Adjust Menu icon.
- 2 Press the Point ▼ button to move the red frame pointer to the item that you want to adjust and then press the SET button. The level of each item is displayed. Adjust each level by pressing the Point ◀▶ button.

### Contrast

Press the Point ◀ button to decrease contrast and the Point ▶ button to increase contrast. (From 0 to 63.)

### Brightness

Press the Point ◀ button to adjust image darker and the Point ▶ button to adjust image brighter. (From 0 to 63.)

### Color

Press the Point ◀ button to lighten color and the Point ▶ button to deepen color. (From 0 to 63.)

### Tint

Press the Point ◀▶ button to obtain proper color. (From 0 to 63.)

### Color temp.

Press the Point ◀▶ button for Color temp. level that you want to select. (XLow, Low, Mid, or High)

### White balance (Red)

Press the Point ◀ button to lighten red tone and the Point ▶ button to deepen red tone. (From 0 to 63.)

### White balance (Green)

Press the Point ◀ button to lighten green tone and the Point ▶ button to deepen green tone. (From 0 to 63.)

### White balance (Blue)

Press the Point ◀ button to lighten blue tone and the Point ▶ button to deepen blue tone. (From 0 to 63.)

### Sharpness

Press the Point ◀ button to soften the image and the Point ▶ button to sharpen the image. (From 0 to 15.)

### Gamma

Press the Point ◀▶ button to obtain better balance of contrast. (From 0 to 15.)

#### ✓ Note:

The Tint cannot be adjusted when the video system is PAL, SECAM, PAL-M, or PAL-N.

### Image Adjust Menu

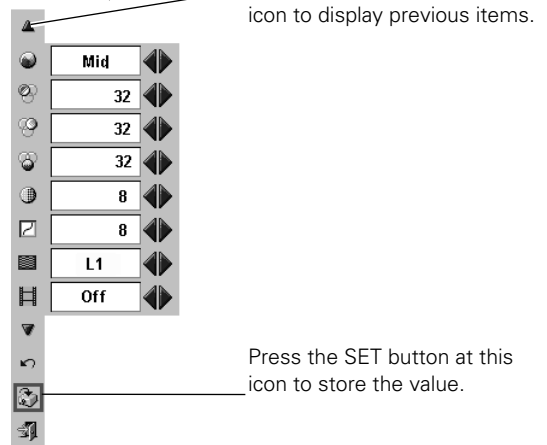
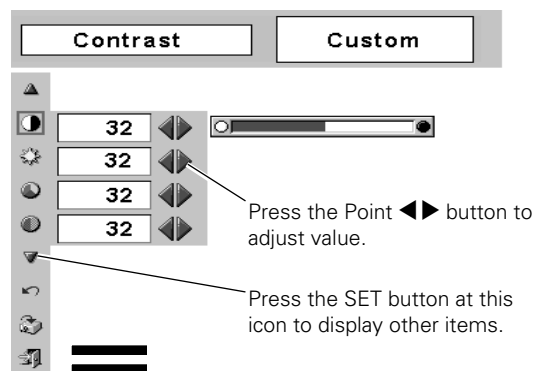
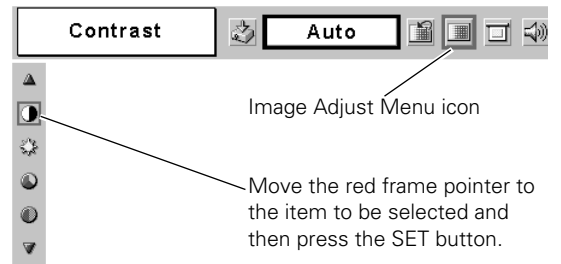

 **Progressive**

Interlaced video signal can be displayed in a progressive picture.  
 Off . . . . .Not activated.  
 L1 . . . . .Select "L1" for an active picture.  
 L2 . . . . .Select "L2" for a still picture.

 **Film**

This function is effective on 3:2 pulldown video source. With this function On, the projector reproduces pictures faithful to the original film quality.

 **Reset**

Resets all adjustment to their previous levels.

 **Store**

To store the adjustment data, move the red frame pointer to the Store icon and press the SET button. The message "OK?" will appear. Select [Yes] to store the adjustment data.  
 To select this manual adjustment, select Custom by pressing the IMAGE button or through the Image Select Menu (p37).

 **Quit**

Closes the Image Adjust Menu.

 **Note:**

- Progressive cannot be selected when 480p, 575p, 720p, 1035i, or 1080i is selected.
- Film can only be activated in any state shown below.
  1. When selecting NTSC, NTSC4.43 PAL-M or 480i in the AV System Menu (p36).
  2. When selecting Auto and signal is NTSC, NTSC4.43, PAL-M(Composite) or 480i(Component) in the AV System Menu (p36).
- 3:2 Pulldown or Telecine transfer is the process of changing images from film mode to video mode. While film runs at 24 frames per second (fps), NTSC television signals (or video) have a run rate of 30fps so the 24 fps film needs to be speeded up to 30fps and transferred using a proper field pattern to get the best film-like images.

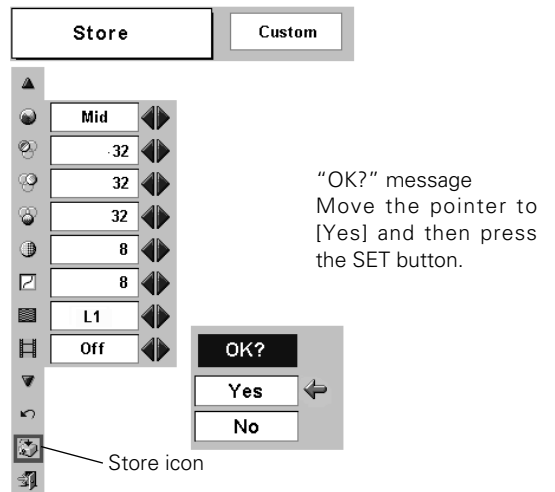

## Screen Size Adjustment

This projector has a picture screen resize function, which enables you to display the desirable image size.

- 1 Press the MENU button and the On-Screen Menu will appear. Press the Point ◀▶ button to move the red frame pointer to the Screen Menu icon.
- 2 Press the Point ▼ button and move the red frame pointer to the function that you want to select and then press the SET button.

### **Normal**

Provides image at a normal video aspect ratio of 4 : 3.

### **Wide**

Provides image at a wide screen ratio of 16 : 9.

#### ✓ **Note:**

Screen Menu cannot be operated when "720p", "1035i", or "1080i" is selected in the AV System Menu (p36).

### Screen Menu

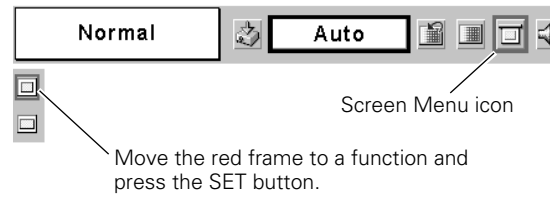



## Setting

This projector has Setting menu that allows you to set up the other various functions described as follows;

- 1 Press the MENU button to display the On-Screen Menu. Press the Point ◀▶ button to move the red frame pointer to the Setting Menu icon.
- 2 Press the Point ▼ button to move the red frame pointer to the item that you want to set and then press the SET button. The Setting dialog box appears.

### **Language**

The language used in the On-Screen Menu is available in English, German, French, Italian, Spanish, Portuguese, Dutch, Swedish, Russian, Chinese, Korean, or Japanese.

### **Keystone**

This function corrects distortion of a projected image. Select either Store or Reset with the Point ◀▶ button, and then press the SET button. The keystone dialog box appears. Adjust keystone with the Point ▲▼ button.

Store . . . . stores the keystone adjustment even if the AC power cord is disconnected.

Reset . . . . resets the keystone adjustment when the AC power cord is disconnected.

### **Blue back**

When this function is "On," the projector produces a blue image while input signal is not detected.

### **Display**

This function decides whether to display On-Screen Displays.

On . . . . . shows all the On-Screen Displays.

Off . . . . . does not show On-Screen Displays except;

- On-Screen Menu
- "Power off?" message
- P-Timer
- "No signal" message
- "Wait a moment!" message

### **Logo PIN code lock**

This function prevents others except specific users from changing the Logo setting.

Off . . . . .the Logo setting can be changed freely from the Logo menu. (p42)

On . . . . .the Logo setting cannot be changed without the Logo PIN code.

If you want to change the Logo PIN code lock setting, enter a Logo PIN code along the following steps. The initial Logo PIN code is set "4321" at the factory.

### Setting Menu (Language)

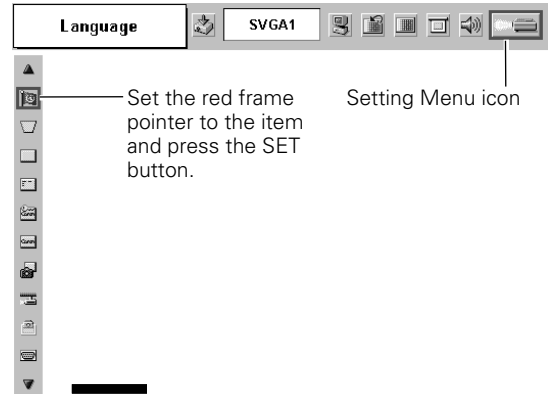

When pressing the SET button at Language, the Language Menu appears.

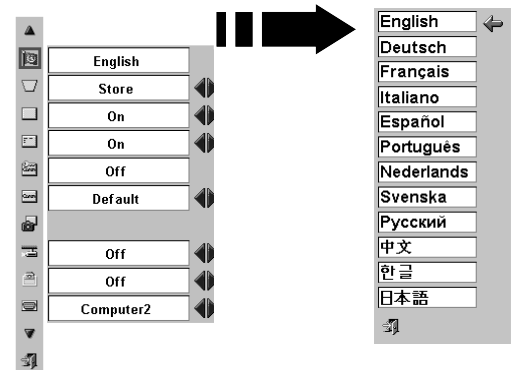

### Logo PIN code lock

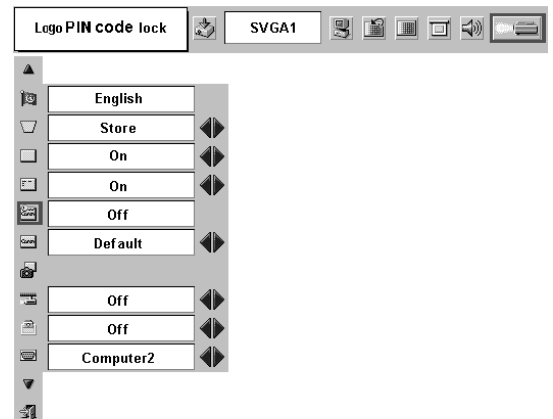

**Enter a Logo PIN code**

Select a number by pressing the Point ◀▶ button and fix the number with the SET button. The number will change to "\*". If you fixed a wrong number, move the pointer to "Set" or "Clear" once by pressing the Point ▼ button, then return to "Logo PIN code". Enter the correct number again.

Repeat this step to complete entering a four-digit number.

When the four-digit number is fixed, the pointer will automatically move to "Set". Press the SET button so that you can change the Logo PIN code lock setting.

If you entered a wrong Logo PIN Code, "Logo PIN code" and the number (\*\*\*\*) will turn red and disappear. Enter a correct Logo PIN code all over again.

**Change the Logo PIN code**

Logo PIN code can be changed to your desired four-digit number. Select "Logo PIN code change" with the Point ▼ button and press the SET button. Set a new Logo PIN code. Be sure to note the new Logo PIN code and keep it at hand.

**✓ Note:**

- If you forget your Logo PIN code and unable to change it, the Logo PIN code can be reset to the factory default setting (4321) according to the following procedures. When you reset the Logo PIN code, the PIN code will be reset, as well.
  1. Disconnect the AC Power Cord from the AC outlet.
  2. As pressing the SET button on the projector, connect the AC Power Cord into an AC outlet again. Keep pressing the SET button until the POWER indicator lights. The Logo PIN code will be returned to the factory default setting while the Logo PIN code lock state will remain the same as previous set state.

**Logo**

This function decides what to be displayed on the starting-up display as follows:

- User . . . . .the image you captured
- Default . . . . .the factory-set logo
- Off . . . . .count-down only

**Capture**

This function enables you to capture the image being projected and use it for a starting-up display or interval of presentations. After capturing the projected image, go to the Logo function and set it to "User". Then the captured image can be displayed when turning on the projector next time or pressing the NO SHOW button. (p25)

To capture the image, select [Yes]. To cancel the Capture function, select [No].

**✓ Note:**

- Before capturing an image, select Standard in the Image Select Menu to capture a proper image. (See page 31,37.)
- A signal from a computer can be captured up to XGA(1024 x 768). A signal from video equipment can be captured except for 720p, 1035i, and 1080i.
- When capturing the image that has been adjusted by the Keystone function, the adjustment data is automatically reset and the projector captures an image without keystone adjustment.
- When the Logo PIN code lock function is On, the Logo and Capture menu cannot be selected.

**Logo PIN code lock Dialog Box**

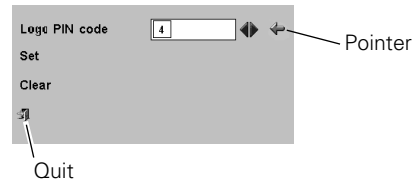

After a correct Logo PIN code is entered, the following dialog box will appear.

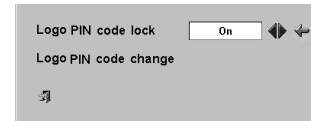

Select On/Off by pressing the Point ◀▶ button or change the Logo PIN code.

**Capture**

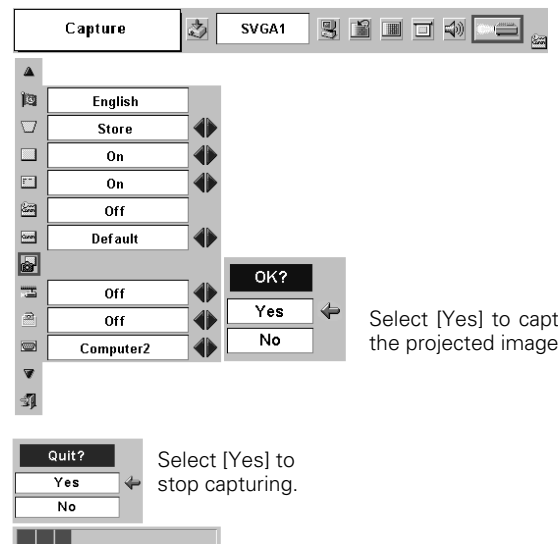

Select [Yes] to capture the projected image.

Select [Yes] to stop capturing.

 **Ceiling**

When this function is "On," the picture is top/bottom and left/right reversed. This function is used to project the image from a ceiling mounting the projector.

 **Rear**

When this function is "On," the picture is left/right reversed. This function is used to project the image to a rear projection screen.

 **Terminal**

The RGB IN-2/RGB OUT terminal on the back of the projector is switchable for computer input or monitor output. (See page 9) Select Computer 2 or Monitor Out with the Point Left/Right button.

- RGB IN-2 . . . . .computer input
- RGB Out . . . . .monitor out

Terminal item is not available when selecting Computer 2 to the input source. Change the input source to the others (Computer1 or Video) so that the Terminal item will be available. (p26, 34, 35)

**Ceiling**

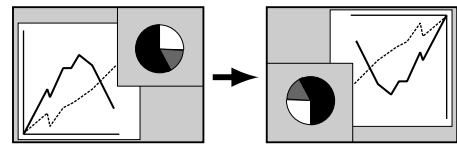

**Rear**

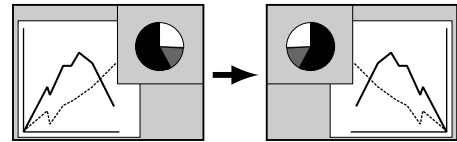

 **Power management**

For reducing power consumption as well as maintaining the lamp life, the Power Management function turns off the projection lamp when the input signal is interrupted and no button is pressed for 30 seconds or more.

If the input signal is interrupted and no button is pressed for 30 seconds or more, the timer display with the message "No signal" appears on the screen. The count-down of the set time will get started. The count-down time can be set between 1 and 30 minutes.

When the count-down time has been elapsed, the lamp will be turned off to cool itself down. The POWER indicator is blinking red during this cooling-off period. The next operation depends on the setting as follows :

- Ready . . . . .When the lamp has been fully cooled down, the POWER indicator changes to green blinking. In this condition, the projection lamp will be turned on if the input signal is reconnected or any button on the top control or remote control unit is pressed.
- Shutdown . . .When the lamp has been fully cooled down, the power will be turned off.
- Off . . . . .The Power Management function is canceled.

 **On start**

When this function is "On," the projector is automatically turned on just by connecting the AC power cord to a wall outlet.

**✓ Note:**  
Be sure to turn the projector off properly (see "Turning Off the Projector" on page 21). If the projector is turned off in the wrong steps, the On start function does not operate properly.

**Power management**



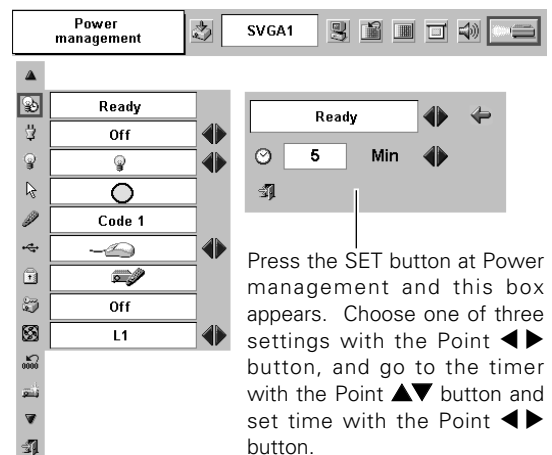

Time left until Lamp off



 **Lamp mode**

This function allows you to change brightness of the screen.

-  Normal mode .... normal brightness
-  Auto mode .... the controlled brightness according with input signal
-  Silent mode .... lower brightness reduces the lamp power consumption and extends the lamp life. The sound is quiet.

**✓ Note:**

*Lamp mode is not switched into Silent mode within 2 minutes after the projector is turned on.*

 **Pointer**

You can emphasize a part of the projected image with this function. Choose either Spotlight or Pointer with the Point ▲▼ button and press the SET button. Then select one of three different sizes (Large, Middle, and Small) of Spotlight or a pointer of three different patterns (Arrow, Finger, and Dot) of Pointer. (See page 12 for operation.)

 **Remote control**

This projector provides eight different remote control codes (Code 1-Code 8);the factory-set, initial code(Code1) and the other seven codes (Code 2 to Code 8). This switching function prevents remote control interference when operating several projectors or video equipment at the same time.

When operating the projector in "Code 7", both the projector and the remote control unit must be switched to "Code 7".

**To change the code for the projector:**



Select either "Code 1" or "Code 8" in this Setting Menu.

**To change the code for the remote control:**

While holding down the MENU button, press the IMAGE button number of times corresponding to the remote control code for the projector. (See page 13 for details.)

 **USB**

This projector is equipped with the USB port for interactive operation between the projector and computer. Selects either of the followings as needed.

-  .... When using the remote control unit as the wireless mouse for a computer connected to the projector with a USB cable.
-  .... When controlling the projector with a computer.  
This item is provided for future use. Not available now.

**Pointer**

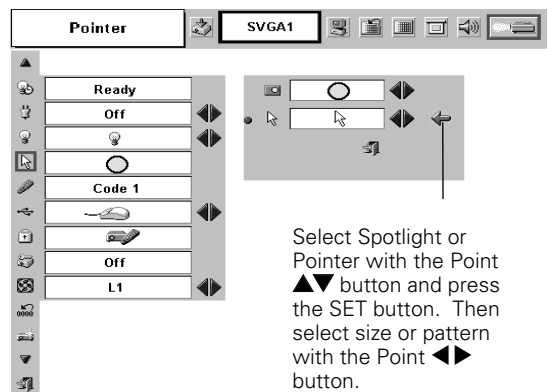

**Remote control**

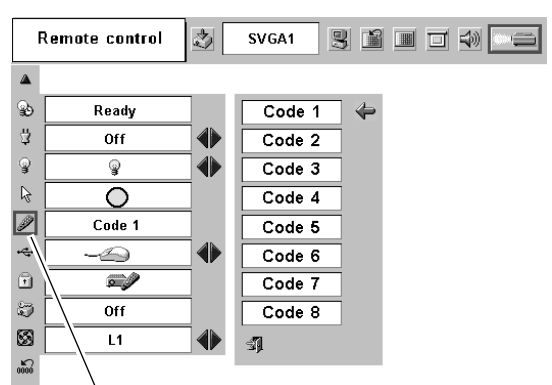

**Key lock**

This function locks operation of the top control and remote control unit. It is useful to prevent operation by an unauthorized person.

- .... not locked.
- .... locks operation of the top control. To unlock, use the remote control unit.
- .... locks operation of the remote control unit. To unlock, use the top control.

If the top control accidentally becomes locked and you do not have the remote control unit nearby, disconnect the AC power cord from the AC outlet, and then while pressing the SET button, reinsert the AC power cord. This will release the top control lock.

**Key lock**

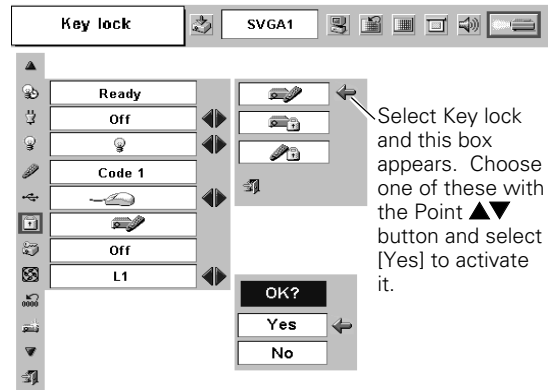

**PIN code lock**

This function prevents the projector from being operated by others except specific users and provides the following settings for your options.

- Off.....the projector is not locked with the PIN code.
- On1 .....requires to enter the PIN code every time turning on the projector.
- On2.....requires to enter the PIN code to operate the projector once the power cord is disconnected; as long as the AC power cord is connected, the projector can be operated without the PIN code.

To change the PIN code Lock setting or the PIN code (the four-digit number), you are required to enter the PIN code. "1234" is set as the initial PIN code at the factory.

**PIN code lock**

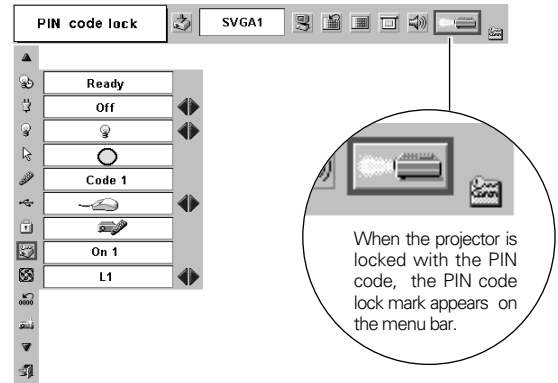

**Enter a PIN code**

Select a number by pressing the Point ◀▶ button and fix the number with the SET button. The number will change to "\*". If you fixed a wrong number, move the pointer to "Set" or "Clear" once by pressing the Point ▼ button, then return to "PIN code". Enter the correct number again. Repeat this step to complete entering a four-digit number.

When the four-digit number is fixed, the pointer will automatically move to "Set". Press the SET button so that you can change the following PIN code lock settings.

If you entered a wrong PIN code, "PIN code" and the number (\*\*\*\*) will turn red and disappear. Enter a correct PIN code all over again.

**Enter a PIN code**

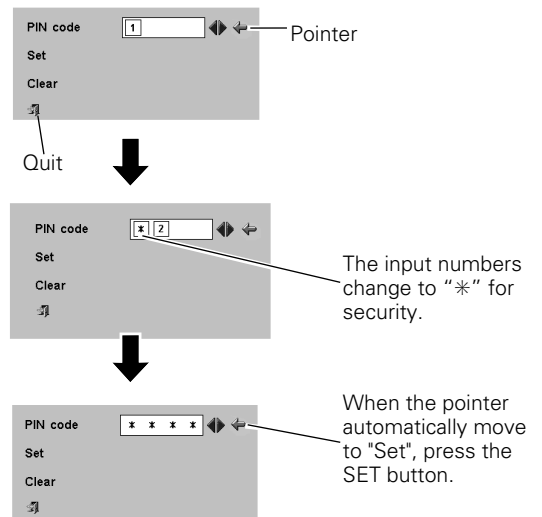

**To Change the PIN code lock setting**

Select Off, On1, or On2 with the Point ◀▶ button and then "Quit" with the Point ▼ button and press the SET button to close the dialog box.

**To Change the PIN code**

The PIN code can be changed to your desired four-digit number.

Select "PIN code change" with the Point ▼ button, and press the SET button. The New PIN code input dialog box will appear.

Select a number with the Point ◀▶ button and fix the number with the SET button. Repeat it to complete entering a four-digit number. When the four-digit number is fixed, the pointer will automatically move to "Set". Then press the SET button.

Be sure to note the new Logo PIN code and keep it at hand.

✓ **Note:**

*If you forget your PIN code and unable to start operating the projector, the PIN code can be reset to the factory default setting (1234) according to the following procedure. When you reset the PIN code, the Logo PIN code will be reset, as well.*

1. Disconnect the AC Power Cord from the AC outlet.
2. As pressing the SET button on the projector, connect the AC Power Cord into an AC outlet again. Keep pressing the SET button until the POWER indicator lights. The PIN code will be returned to the factory default setting while the PIN code lock state will remain the same as previous set state.

 **Fan**

This function provides you the following alternatives in the cooling fans operation after turning off the projector.

- L1 . . . . .normal operation. Cooling the projector for 90 seconds after turning off the projector.
- L2 . . . . .slower operation than the normal (L1) , but takes longer to cool down the projector. Cooling the projector for 120 seconds after turning off the projector.

 **Lamp counter reset**

This function is used to reset the lamp replace counter. When replacing the projection lamp, reset the lamp replace counter by using this function. See page 51 for operation.

 **Factory default**

This function returns all setting values except for the PIN code lock, the Logo PIN code lock, the User logo and the lamp counter to the factory default settings.

**Change the PIN code lock setting**



Select a desired setting with the Point ◀▶ button.

**Change the PIN code**

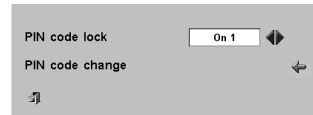

Select PIN code change and press the SET button. The New PIN code input dialog box will appear.

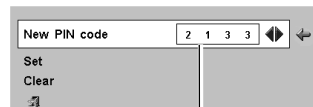

The input numbers are being displayed for confirmation.

**Fan**

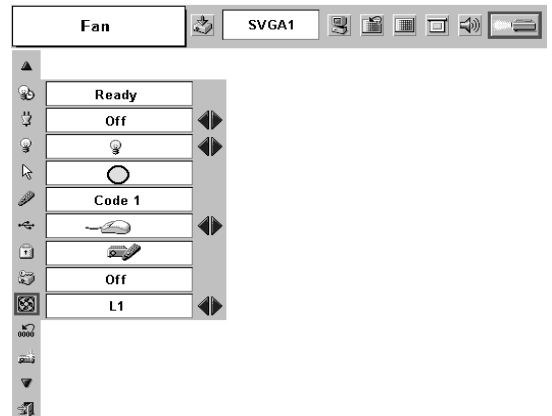

**Factory default**

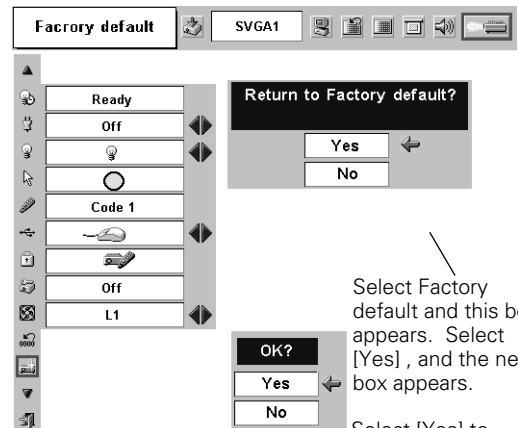

Select Factory default and this box appears. Select [Yes] , and the next box appears.

Select [Yes] to activate it.

# Maintenance and Cleaning

## Warning Indicator

The WARNING indicator shows the state of the function which protects the projector. Check the state of the WARNING indicator and the POWER indicator to take proper maintenance.

### **The projector is shut down and the WARNING indicator is blinking red.**

When the temperature inside the projector exceeds the normal temperature, the projector is automatically shut down to protect the inside of the projector. The POWER indicator is blinking and the projector is being cooled down. When the temperature inside the projector returns to normal, the POWER indicator lights red and the projector can be turned on.

#### **✓ Note:**

*After the temperature inside the projector returns to normal, the WARNING indicator still continues to blink. When the projector is turned on again, the WARNING indicator stops blinking.*

#### **Then check the matters below:**

- Did you provide appropriate space for the projector to be ventilated? Check the installing condition to see if ventilation slots are not blocked.
- Is the projector not installed near the ventilation duct of air-conditioning equipment which may be hot? Install the projector away from the ventilation duct of air-conditioning equipment.
- Are the air filters clean? Clean the air filters periodically.

### **The projector is shut down and the WARNING indicator lights red.**

When the projector detects an abnormal condition, it is automatically shut down to protect the inside and the WARNING indicator lights red. In this case, disconnect the AC power cord and reconnect it, and then turn the projector on once again for check. If the projector is still turned off and the WARNING indicator lights red, disconnect the AC power cord and contact the service station for check and repair.



#### **CAUTION**

DO NOT LEAVE THE PROJECTOR WITH THE AC POWER CORD CONNECTED UNDER THE ABNORMAL CONDITION. IT MAY RESULT IN FIRE OR ELECTRIC SHOCK.

#### **TOP CONTROL**

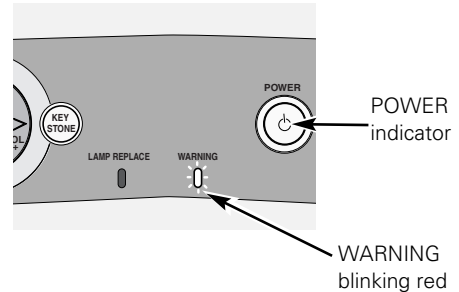

#### **TOP CONTROL**

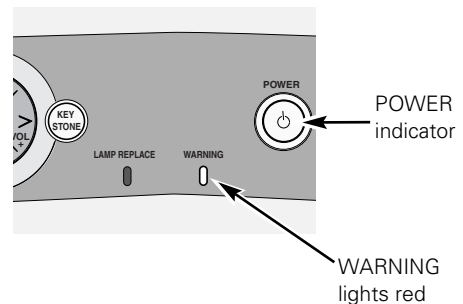

### Cleaning the Air Filters

Air filters prevent dust from accumulating on the surface of the optical elements inside the projector. Should the air filters become clogged with dust particles, it will reduce cooling fans' effectiveness and may result in internal heat build up and adversely affect the life of the projector. Clean the air filters following the steps below.

- 1 Turn off the projector, and disconnect the AC power cord from the AC outlet.
- 2 Turn the projector upside down and remove the air filters by pulling the latches upward.
- 3 Clean the air filters with a brush or rinse them softly.
- 4 When cleaning the air filters by rinsing, dry them well. Replace the air filters properly. Make sure that the air filters are fully inserted.



#### CAUTION

Do not operate the projector with the air filters removed. Dust may accumulate on the LCD panel and the projection mirror degrading picture quality. Do not put small parts into the air intake vents. It may result in malfunction of the projector.

#### RECOMMENDATION

**We recommend avoiding dusty/smoky environments when operating the projector. Usage in these environments may cause poor image quality.**

When using the projector under dusty or smoky conditions, dust may accumulate on a lens, LCD panels, or optical elements inside the projector. This condition may degrade the quality of a projected image.

When the symptoms above are noticed, contact your authorized dealer or service station for proper cleaning.

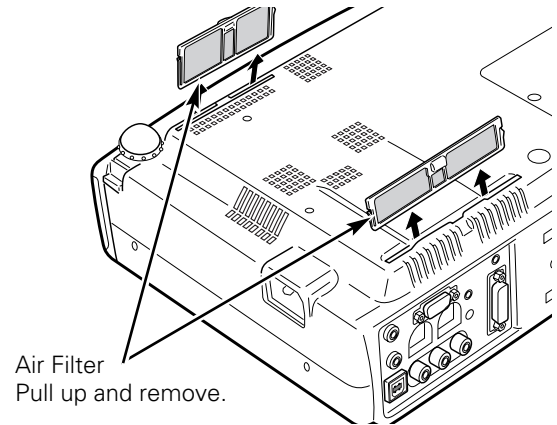

### Attaching the Lens Cover

When moving this projector or while not using it over an extended period of time, replace the lens cover.

- 1 Pass the string through a hole of the lens cover.
- 2 Turn the projector upside down.
- 3 Attach the string with lens cover to a hole on the bottom of the projector and secure it with a screw.

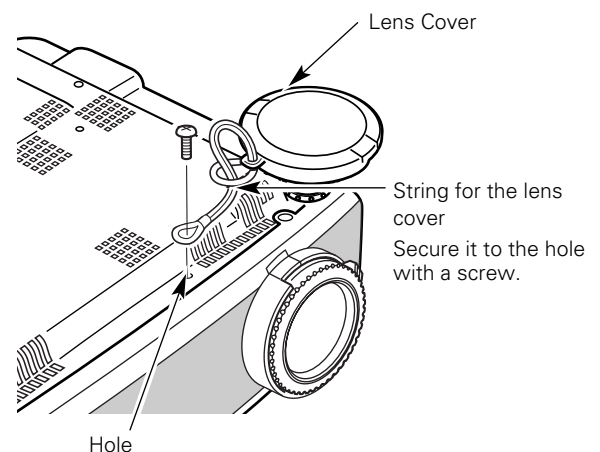



## Cleaning the Projection Lens

Follow these steps to clean the projection lens.

- 1** Disconnect the AC power cord before cleaning.
- 2** Softly wipe the projection lens with a cleaning cloth that contains a small amount of non-abrasive camera lens cleaner, or use lens cleaning paper or a commercially available air blower to clean the lens. Avoid using an excessive amount of cleaner. Abrasive cleaners, solvents, or other harsh chemicals might scratch the surface.
- 3** When the projector is not in use, replace the lens cover.

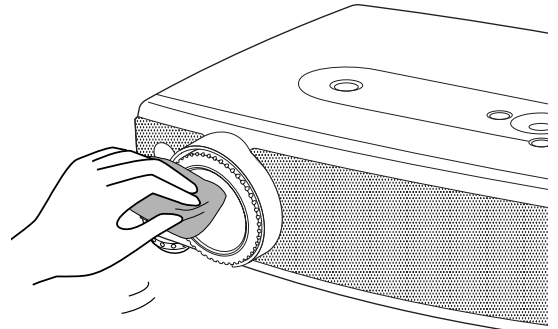

## Cleaning the Projector Cabinet

Follow these steps to clean the projector cabinet.

- 1** Disconnect the AC power cord before cleaning.
- 2** Softly wipe the projector body with a soft, dry cleaning cloth. When it is heavily soiled, use a small amount of mild detergent and finish with a soft, dry cleaning cloth. Avoid using an excessive amount of cleaner. Abrasive cleaners, solvents, or other harsh chemicals might scratch the surface.
- 3** When the projector is not in use, put the projector in an appropriate carrying case to protect it from dust and scratches.

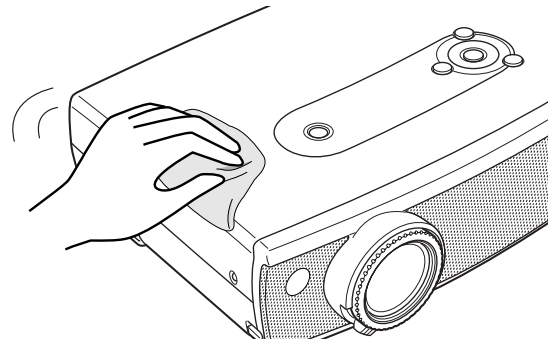

## Lamp Replacement

When the life of the projection lamp of this projector draws to an end, the LAMP REPLACE indicator lights yellow. If this indicator lights yellow, replace the lamp with a new one promptly.

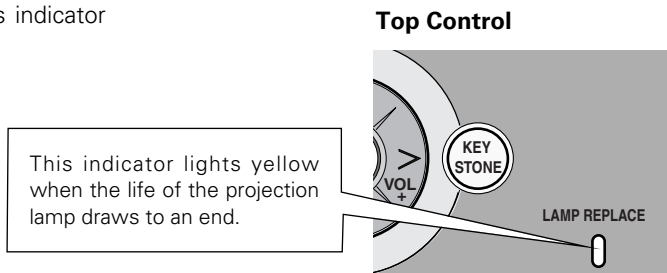

### CAUTION

Allow a projector to cool, for at least 45 minutes before you open the Lamp cover. The inside of the projector can become very hot.



### CAUTION

For continued safety, replace with a lamp of the same type. Do not drop a lamp or touch a glass bulb! The glass can shatter and may cause injury.

Follow these steps to replace the lamp.

- 1** Turn off the projector and disconnect the AC plug. Allow the projector to cool for at least 45 minutes.
- 2** Loosen the screw with a screwdriver, and remove the lamp cover.
- 3** Loosen 2 screws of the lamp with a screwdriver and pull out the lamp by grasping the handle.
- 4** Replace the lamp with a new one and tighten the 2 screws back into position. Make sure that the lamp is set properly. Replace the lamp cover and tighten the screw.
- 5** Connect the AC power cord to the projector and turn on the projector.
- 6** **Reset the Lamp replace counter.**  
See "Lamp Replace Counter" on the next page .

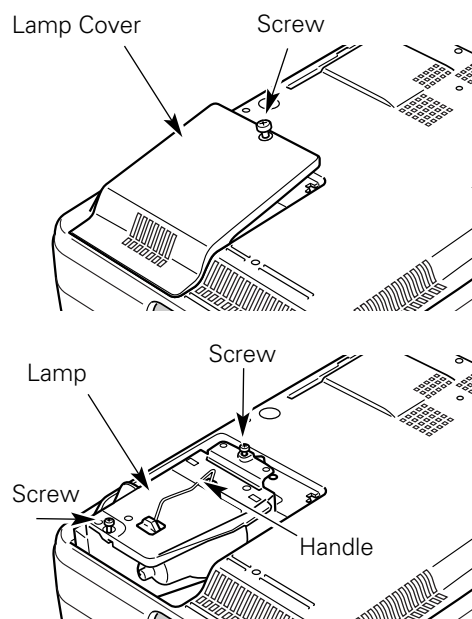

### **ORDER REPLACEMENT LAMP**

Replacement lamp can be ordered through your dealer. When ordering a projection lamp, give the following information to the dealer.

- **Model No. of your projector** : **LV-X4, LV-7230**
- **Replacement Lamp Type No.** : **LV-LP21 (for LV-X4)**  
(610 315 5647)  
**LV-LP18 (for LV-7230)**  
(610 309 2706)

## Lamp Replace Counter

Be sure to reset the lamp replace counter after the lamp is replaced. When the lamp replace counter is reset, the LAMP REPLACE indicator stops lighting.

- 1 Turn the projector on, press the MENU button and the On-Screen Menu will appear. Press the Point ◀▶ button to move the red frame pointer to the Setting Menu icon.
- 2 Press the Point ▼ button to move the red frame pointer to the Lamp counter reset item and then press the SET button. The message "Lamp replace counter Reset?" is displayed. Move the pointer to [Yes] and then press the SET button.
- 3 Another confirmation dialog box appears and select [Yes] to reset the Lamp replace counter.

✓ **Note:**

*Do not reset the Lamp replace counter without implementation of lamp replacement.  
Be sure to reset the Lamp replace counter only after replacing the lamp.*

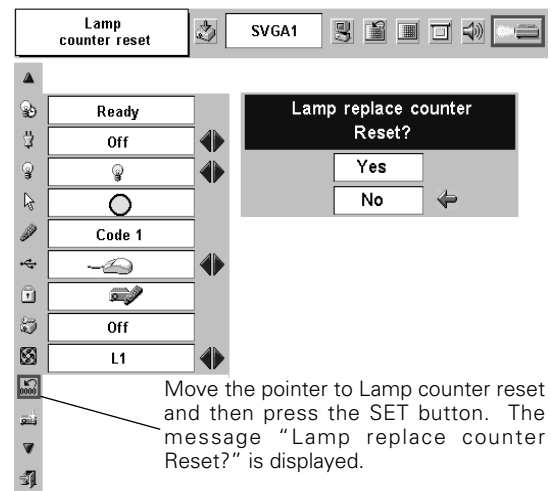

Move the pointer to Lamp counter reset and then press the SET button. The message "Lamp replace counter Reset?" is displayed.



## LAMP HANDLING PRECAUTIONS

This projector uses a high-pressure lamp which must be handled carefully and properly. Improper handling may result in accidents, injury, or create a fire hazard.

- Lamp life may differ from lamp to lamp and according to the environment of use. There is no guarantee of the same life for each lamp. Some lamps may fail or terminate their life in a shorter period of time than other similar lamps.
- If the projector indicates that the lamp should be replaced, i.e., if the LAMP REPLACE indicator lights up, replace the lamp with a new one IMMEDIATELY after the projector has cooled down. ( Follow carefully the instructions in the Lamp Replacement section of this manual. ) Continuous use of the lamp with the LAMP REPLACE indicator lighted may increase the risk of lamp explosion.
- A Lamp may explode as a result of vibration, shock or degradation as a result of hours of use as its lifetime draws to an end. Risk of explosion may differ according to the environment or conditions in which the projector and lamp are being used.

### IF A LAMP EXPLODES, THE FOLLOWING SAFETY PRECAUTIONS SHOULD BE TAKEN.

If a lamp explodes, disconnect the projector's AC plug from the AC outlet immediately. Contact an authorized service station for a checkup of the unit and replacement of the lamp. Additionally, check carefully to ensure that there are no broken shards or pieces of glass around the projector or coming out from the cooling air circulation holes. Any broken shards found should be cleaned up carefully. No one should check the inside of the projector except those who are authorized trained technicians and who are familiar with projector service. Inappropriate attempts to service the unit by anyone, especially those who are not appropriately trained to do so, may result in an accident or injury caused by pieces of broken glass.

## Troubleshooting

Before calling your dealer or service center for assistance, check the items below once again.

- Make sure you have properly connected the projector to peripheral equipment as described in "Connecting to a Computer" and "Connecting to Video Equipment" on page 17-19.
- Make sure all equipment is connected to AC outlet and the power is turned on.
- If the projector does not project an image being operated with a computer, restart the computer.

---

**Problem:**

– Solutions

---

**No power**

- Plug the power cord of the projector into the AC outlet.
  - See if the POWER indicator lights red.
  - Wait 90-120 seconds after the projector is turned OFF when turning the projector back on. The projector can be turned on after the POWER indicator turns red. (See "Turning Off the Projector" on page 21.)
  - Check the WARNING indicator. If the WARNING indicator lights red, the projector cannot be turned on. (See "Warning Indicator" on page 47.)
  - Check the projection lamp. (See page 50 and 51.)
  - Unlock Key lock for the projector in the Setting Menu. (See page 45.)
- 

**Image is out of focus.**

- Adjust focus of the projector. (See page 24.)
  - Provide proper distance between the projector and the projection screen. (See page 15.)
  - Check the projection lens to see if it needs cleaning. (See page 49.)
  - Moving the projector from a cool to a warm place may result in moisture condensation on the projection lens. In such cases, leave the projector OFF and wait until condensation disappears.
- 

**No image**

- Check the connection between your computer or video equipment and the projector. (See page 17-19)
  - See if the input signal is correctly output from your computer. Some laptop computers may need to change the setting for monitor output when connecting to a projector. See your computer's instruction manual for the setting.
  - It takes about 30 seconds to display an image after turning on the projector.
  - See if the selected system is corresponding with your computer or video equipment. (See page 27 and 36)
  - Select correct input source once again through menu operation. (See page 26, 34 and 35)
  - Make sure the temperature is not out of the specified Operating Temperature (41 °F ~ 95 °F (5 °C ~ 35 °C)).
- 

**Image is Left/Right reversed.  
image is Top/Bottom reversed.**

- Check the Ceiling / Rear item. (See "Setting" on page 43.)
  - Check the Ceiling item. (See "Setting" on page 43.)
- 

**No sound**

- Check audio cable connection from audio input source.
  - Adjust the audio source.
  - Press the Vol (+) button. (See page 25)
  - Press the Mute button. (See page 25)
-

**Some displays are not seen during the Operation.**

- Check the Display item. (See “Setting” on page 41.)

**PIN code dialog box appears at start-up.**

- PIN code lock is being set. Input a PIN code (1234 or numbers you have set). (See “PIN code lock” on page 20,45 and 46.)

**Computer 2 cannot be selected.**

- Select Computer 2 at the Terminal item in the Setting Menu. (See “Setting” on page 43.)

**The Terminal item cannot be selected.**

- The Terminal item in the Setting Menu cannot be selected after Computer 2 is selected. Select other input source such as Computer 1 or Video with the INPUT button on the top control, the COMPUTER button or the VIDEO button on the remote control unit so that the Terminal item can be selected.

**The Remote Control unit does not work.**

- Check the batteries.
- Make sure no obstruction is between the projector and remote control unit.
- Make sure you are not too far from the projector when using the remote control unit. Maximum operating range is 16.4’ (5m).
- Make sure the code of the remote control unit is conformed to the projector. (See page 44.)
- Unlock Key lock for the remote control unit in the Setting Menu. (See page 45.)

**Wireless Mouse function does not work.**

- Make sure your computer is connected to the projector with a USB cable. (See page 17.)
- Check cable connection between the projector and your computer. (See page 17.)

**WARNING :**

**High voltages are used to operate this projector. Do not attempt to open the cabinet.**

If problems still persist after following all operating instructions, contact the dealer where you purchased the projector or the service center. Give the model number and explain about the problem. We will advise you how to obtain service.



























The CE Mark is a Directive conformity mark of the European Community (EC).



This symbol on the nameplate means the product is Listed by Underwriters Laboratories Inc. It is designed and manufactured to meet rigid U.L. safety standards against risk of fire, casualty and electrical hazards.

## Indicators and Projector Condition

Check the indicators to see the projector condition.

| Indicators  |   |   | Projector Condition   |
|---|---|---|---|
| POWER<br>red/green  | WARNING<br>red  | LAMP<br>REPLACE<br>yellow   |   |
|    |    |    | The projector is OFF. (The AC power cord is unplugged.)   |
|    |    |    | The projector is preparing for stand-by or the projection lamp is being cooled down. The projector cannot be turned on until cooling is completed.  |
|    |    |    | The projector is ready to be turned on with the POWER button.   |
|    |    |    | The projector is operating normally.  |
|   |   |   | The projector is in the Power management mode.  |
|  |  |  | The temperature inside the projector is abnormally high. The projector cannot be turned on. When the projector is cooled down enough and the temperature returns to normal, the POWER indicator lights red and the projector can be turned on. (The WARNING indicator keeps blinking.) Check and clean the air filters.   |
|  |  |  | The projector has been cooled down enough and the temperature returns to normal. When turning on the projector, the WARNING indicator stops blinking. Check and clean the air filters.  |
|  |  |  | The projector detects an abnormal condition and cannot be turned on. Unplug the AC power cord and plug it again to turn on the projector. If the projector is turned off again, disconnect the AC power cord and contact the dealer or the service center for service and checkup. Do not leave the projector on. It may cause electric shock or a fire hazard. |

 ●●● lights green.    
  ●●● blinks green.    
  ●●● lights red.    
  ●●● blinks red.    
  ●●● off

\* When the life of the projection lamp draws to an end, the LAMP REPLACE indicator lights yellow. When this indicator lights yellow, replace the projection lamp with a new one promptly. Reset the Lamp replace counter after replacement of the lamp. See page 50 and 51.

# Menu Tree

## Computer Input / Video Input

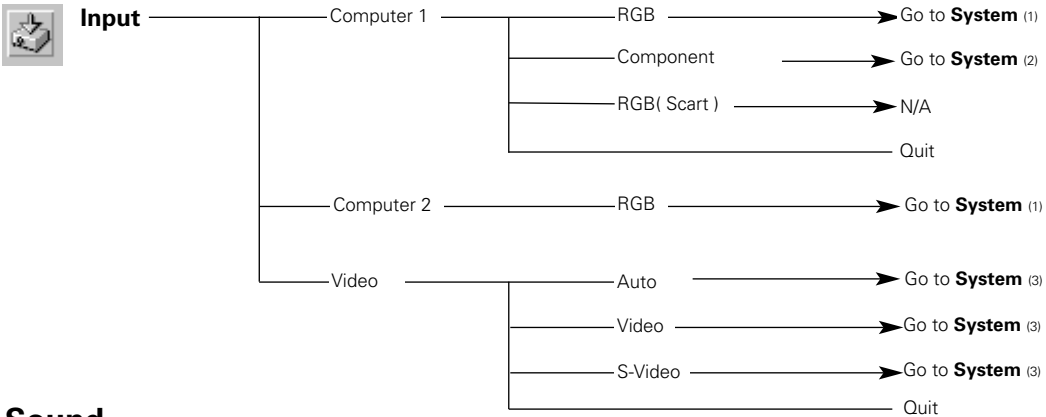

## Sound

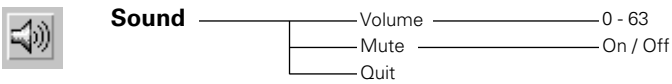

\*N/A --- not applicable

## Computer Input

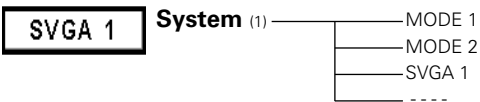

\*Systems displayed in the System Menu vary depending on an input signal.

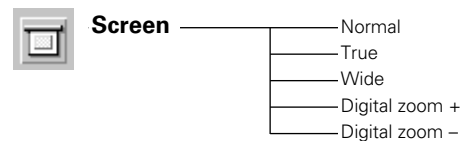
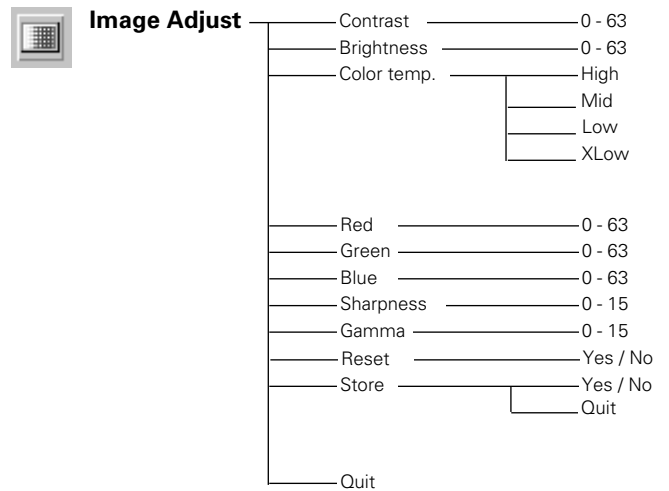
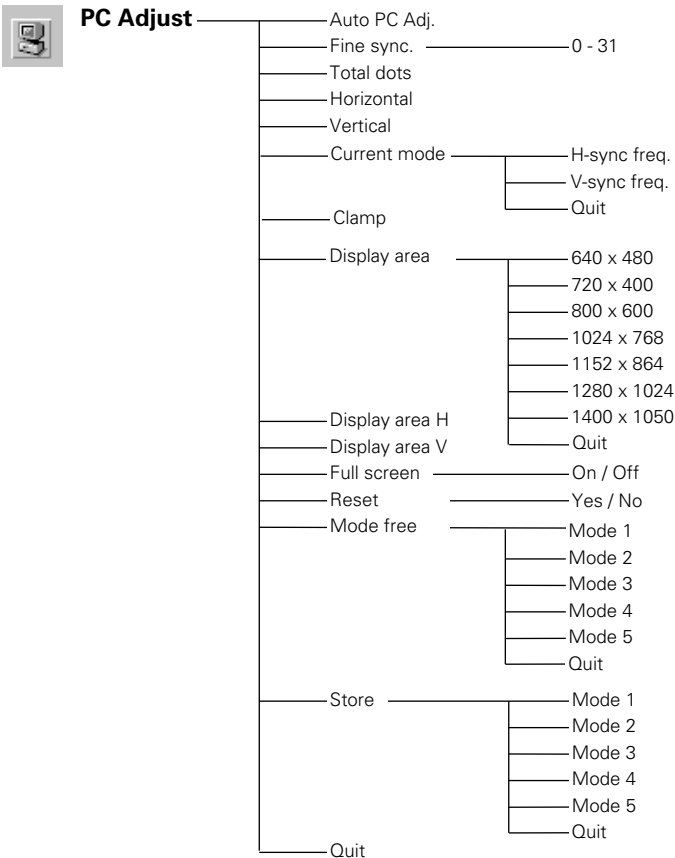
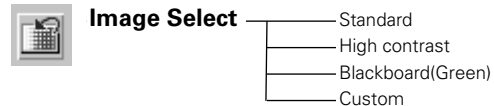

## Video Input

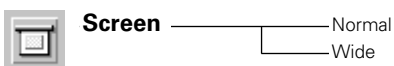
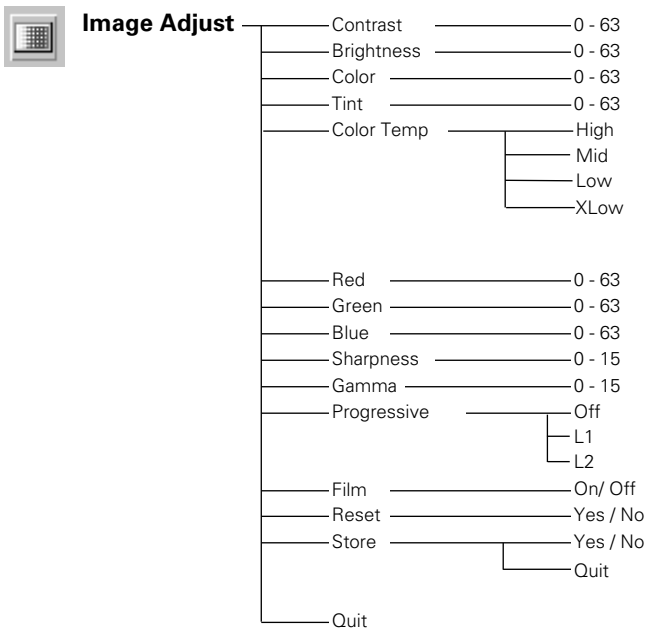
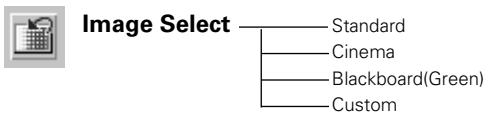
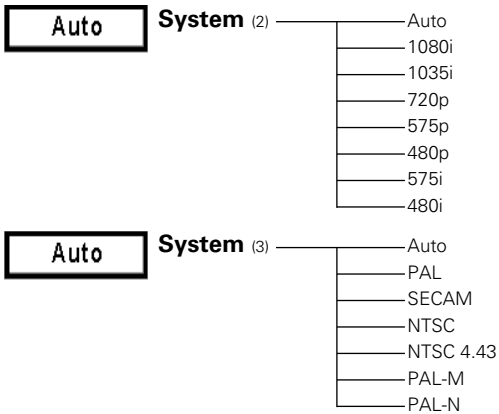

## Setting

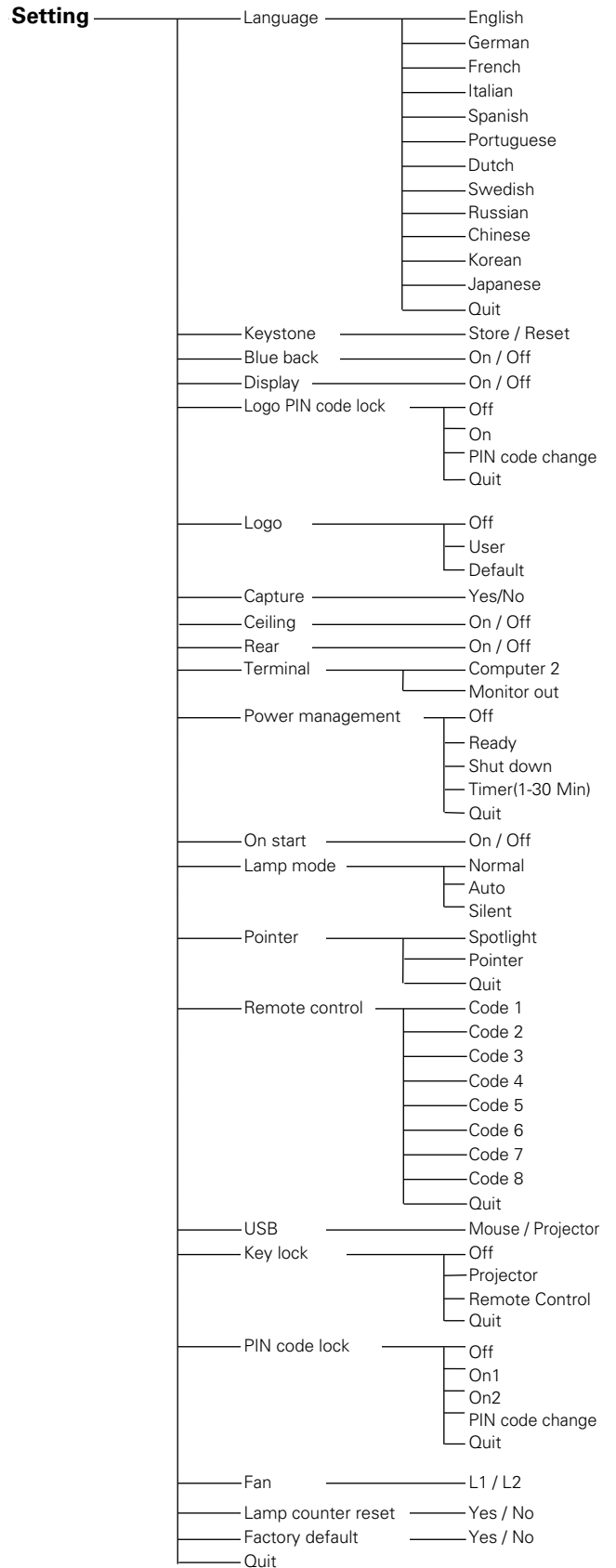



## Compatible Computer Specifications

Basically this projector can accept the signal from all computers with the V, H-Frequency below mentioned and less than 130 MHz of Dot Clock.

| ON-SCREEN DISPLAY | RESOLUTION | H-Freq. (kHz) | V-Freq. (Hz)      | ON-SCREEN DISPLAY | RESOLUTION  | H-Freq. (kHz) | V-Freq. (Hz)      |
|-------------------|------------|---------------|-------------------|-------------------|-------------|---------------|-------------------|
| VGA 1             | 640 x 480  | 31.47         | 59.88             | XGA 11            | 1024 x 768  | 61.00         | 75.70             |
| VGA 2             | 720 x 400  | 31.47         | 70.09             | XGA 12            | 1024 x 768  | 35.522        | 86.96 (Interlace) |
| VGA 3             | 640 x 400  | 31.47         | 70.09             | XGA 13            | 1024 x 768  | 46.90         | 58.20             |
| VGA 4             | 640 x 480  | 37.86         | 74.38             | XGA 14            | 1024 x 768  | 47.00         | 58.30             |
| VGA 5             | 640 x 480  | 37.86         | 72.81             | XGA 15            | 1024 x 768  | 58.03         | 72.00             |
| VGA 6             | 640 x 480  | 37.50         | 75.00             | MAC 19            | 1024 x 768  | 60.24         | 75.08             |
| VGA 7             | 640 x 480  | 43.269        | 85.00             | MAC 21            | 1152 x 870  | 68.68         | 75.06             |
| MAC LC13          | 640 x 480  | 34.97         | 66.60             | SXGA 1            | 1152 x 864  | 64.20         | 70.40             |
| MAC 13            | 640 x 480  | 35.00         | 66.67             | SXGA 2            | 1280 x 1024 | 62.50         | 58.60             |
| 575i              | ————       | 15.625        | 50.00 (Interlace) | SXGA 3            | 1280 x 1024 | 63.90         | 60.00             |
| 480i              | ————       | 15.734        | 60.00 (Interlace) | SXGA 4            | 1280 x 1024 | 63.34         | 59.98             |
| SVGA 1            | 800 x 600  | 35.156        | 56.25             | SXGA 5            | 1280 x 1024 | 63.74         | 60.01             |
| SVGA 2            | 800 x 600  | 37.88         | 60.32             | SXGA 6            | 1280 x 1024 | 71.69         | 67.19             |
| SVGA 3            | 800 x 600  | 46.875        | 75.00             | SXGA 8            | 1280 x 1024 | 63.98         | 60.02             |
| SVGA 4            | 800 x 600  | 53.674        | 85.06             | SXGA 10           | 1280 x 960  | 60.00         | 60.00             |
| SVGA 5            | 800 x 600  | 48.08         | 72.19             | SXGA 11           | 1152 x 900  | 61.20         | 65.20             |
| SVGA 6            | 800 x 600  | 37.90         | 61.03             | SXGA 12           | 1152 x 900  | 71.40         | 75.60             |
| SVGA 7            | 800 x 600  | 34.50         | 55.38             | SXGA 13           | 1280 x 1024 | 50.00         | 86.00 (Interlace) |
| SVGA 8            | 800 x 600  | 38.00         | 60.51             | SXGA 14           | 1280 x 1024 | 50.00         | 94.00 (Interlace) |
| SVGA 9            | 800 x 600  | 38.60         | 60.31             | SXGA 15           | 1280 x 1024 | 63.37         | 60.01             |
| SVGA 10           | 800 x 600  | 32.70         | 51.09             | SXGA 16           | 1280 x 1024 | 76.97         | 72.00             |
| SVGA 11           | 800 x 600  | 38.00         | 60.51             | SXGA 17           | 1152 x 900  | 61.85         | 66.00             |
| MAC 16            | 832 x 624  | 49.72         | 74.55             | SXGA 18           | 1280 x 1024 | 46.43         | 86.70 (Interlace) |
| XGA 1             | 1024 x 768 | 48.36         | 60.00             | SXGA 19           | 1280 x 1024 | 63.79         | 60.18             |
| XGA 2             | 1024 x 768 | 68.677        | 84.997            | SXGA 21           | 1400 x 1050 | 63.90         | 60.00             |
| XGA 3             | 1024 x 768 | 60.023        | 75.03             | MAC               | 1280 x 960  | 75.00         | 75.08             |
| XGA 4             | 1024 x 768 | 56.476        | 70.07             | 480p              | ————        | 31.47         | 59.88             |
| XGA 5             | 1024 x 768 | 60.31         | 74.92             | 575p              | ————        | 31.25         | 50.00             |
| XGA 6             | 1024 x 768 | 48.50         | 60.02             | 720p              | ————        | 45.00         | 60.00             |
| XGA 7             | 1024 x 768 | 44.00         | 54.58             | 1035i             | ————        | 33.75         | 60.00 (Interlace) |
| XGA 8             | 1024 x 768 | 63.48         | 79.35             | 1080i             | ————        | 33.75         | 60.00 (Interlace) |
| XGA 9             | 1024 x 768 | 36.00         | 87.17 (Interlace) | 1080i             | ————        | 28.125        | 50.00 (Interlace) |
| XGA 10            | 1024 x 768 | 62.04         | 77.07             |                   |             |               |                   |

## Technical Specifications

### Mechanical Information

|                        |   |
|------------------------|---|
| Projector Type         | Multi-media Projector   |
| Dimensions (W x H x D) | 11.81" x 3.23" x 8.94" (300mm x 82mm x 227mm) (Not including adjustable feet) |
| Net Weight             | 6.4lbs (2.9kgs)   |
| Feet Adjustment        | 0° to 11.9°   |

### Panel Resolution

|                  |                                       |
|------------------|---------------------------------------|
| LCD Panel System | 0.8" TFT Active Matrix type, 3 panels |
| Panel Resolution | 1,024 x 768 dots                      |
| Number of Pixels | 2,359,296 (1,024 x 768 x 3 panels)    |

### Signal Compatibility

|                           |  |
|---------------------------|--|
| Color System              | PAL, SECAM, NTSC, NTSC4.43, PAL-M, PAL-N       |
| High Definition TV Signal | 480i, 480p, 575i, 575p, 720p, 1035i, and 1080i |
| Scanning Frequency        | H-sync. 15 ~ 100 KHz, V-sync. 50 ~ 100 Hz      |

### Optical Information

|                                  |  |
|----------------------------------|--|
| Projection Image Size (Diagonal) | Adjustable from 40" to 300"  |
| Projection Lens                  | F 1.7 ~ 2.5 lens with f 20.3 mm ~ 32.5 mm with manual zoom and focus |
| Throw Distance                   | 3.3' ~ 25.3' (1.0m ~ 7.7m)   |
| Projection Lamp                  | 200W   |

### Interface

|                                       |  |
|---------------------------------------|--|
| Video Input Jacks                     | RCA Type x 1                                   |
| S-Video                               | Mini DIN 4 pin x 1                             |
| Audio Input Jacks                     | RCA Type x 2                                   |
| RGB Input 1/ Component Input Terminal | (VGA) HDB15 Terminal X 1                       |
| RGB Input 2/ RGB Output Terminal      | (VGA) HDB15 Terminal X 1 (In / Out switchable) |
| Computer Audio Input Jacks            | Mini Jack (stereo) x 1                         |
| Service Port Connector                | Mini DIN 8 pin x 1                             |
| USB Connector                         | USB Series B receptacle x 1                    |
| Audio Output Jack                     | Mini Jack (stereo) x 1 (Variable)              |

### Audio

|                    |                         |
|--------------------|-------------------------|
| Internal Audio Amp | 1.0W RMS                |
| Built-in Speaker   | 1 speaker, ø1.1" (28mm) |

### Power

|                               |   |
|-------------------------------|---|
| Voltage and Power Consumption | AC 100 ~ 120 V (3.6 A Max. Ampere), 50 / 60 Hz (The U.S.A and Canada)<br>AC 200 ~ 240 V (1.8 A Max. Ampere), 50 / 60 Hz (Continental Europe ) |
|-------------------------------|---|

### Operating Environment

|                       |                                |
|-----------------------|--------------------------------|
| Operating Temperature | 41 °F ~ 95 °F (5 °C ~ 35 °C)   |
| Storage Temperature   | 14 °F ~ 140 °F (-10°C ~ 60 °C) |

### Remote Control Unit

|                 |  |
|-----------------|--|
| Battery         | AA, UM3 or LR06 Type x 2                 |
| Operating Range | 16.4' (5m) / ±30°                        |
| Dimensions      | 2.0" x 1.0" x 7.1" (50mm x 27mm x 181mm) |
| Net Weight      | 0.34 lbs (154 g) (including batteries)   |

**Accessories**

---

Owner's Manual  
AC Power Cord  
Remote Control Unit and Batteries  
VGA Cable  
USB Cable  
Lens Cover with String and Screw  
Soft Carrying Bag  
PIN code Label

- The specifications are subject to change without notice.
- LCD panels are manufactured to the highest possible standards. Even though 99.99% of the pixels are effective, a tiny fraction of the pixels (0.01% or less) may be ineffective by the characteristics of the LCD panels.
- The On-Screen Menu and figures in this manual may differ slightly from the product.

## Configurations of Terminals

### RGB INPUT/COMPONENT INPUT/RGB OUTPUT TERMINAL (ANALOG)

Terminal : HDB15-PIN

Pin Configuration

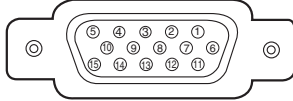

|   |                            |    |  |
|---|----------------------------|----|--|
| 1 | Red (R/Cr) Input / Output  | 9  | ----   |
| 2 | Green (G/Y) Input / Output | 10 | Ground (Vert.sync.)                          |
| 3 | Blue (B/Cb) Input / Output | 11 | Ground / ----                                |
| 4 | ----                       | 12 | ----   |
| 5 | Ground (Horiz.sync.)       | 13 | Horiz.sync.Input/Output(Composite H/V sync.) |
| 6 | Ground (Red)               | 14 | Vert. sync. Input / Output                   |
| 7 | Ground (Green)             | 15 | ----   |
| 8 | Ground (Blue)              |    |  |

### SERVICE PORT CONNECTOR

Terminal : Mini DIN 8-PIN

Pin Configuration

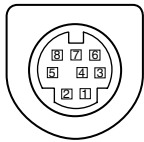

|   | Serial    |
|---|-----------|
| 1 | R X D     |
| 2 | ----      |
| 3 | ----      |
| 4 | GND       |
| 5 | RTS / CTS |
| 6 | T X D     |
| 7 | GND       |
| 8 | GND       |

### USB CONNECTOR (Series B)

Pin Configuration

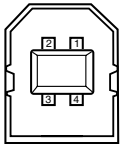

|   |        |
|---|--------|
| 1 | Vcc    |
| 2 | - Data |
| 3 | + Data |
| 4 | Ground |

## Optional Parts

The parts listed below are optionally available. When ordering those parts, give the item name and Model No. to the sales dealer.

Model No.

**COMPONENT-VGA Cable** : LV-CA32

**SCART-VGA Cable** : LV-CA31  
(This cable is used for RGB Scart 21-Pin Video output of video equipment.)

**CEILING HANGER** : LV-CL08

**While the projector is locked with the PIN code...**

Put a label below on in a prominent place of the projector's body while it is locked with a PIN code.

The label is provided with the product to identify the projector locked with a PIN code.

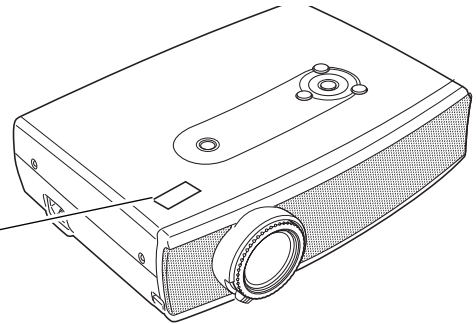







**CANON INC.** 30-2, Shimomaruko 3-chome, Ohta-ku, Tokyo 146-8501, Japan

**CANON U.S.A., INC.**

One Canon Plaza, Lake Success, NY 11042, U.S.A.

**CANON CANADA, INC.**

6390 Dixie Road Mississauga, Ontario L5T 1P7 Canada

**CANON LATIN AMERICA, INC.**

703 Waterford Way Suite 400 Miami, Florida 33126 U.S.A.

**CANON MEXICANA, S.DE R.L.DE C.V.**

Blvd. M. A. Camacho No.138, Piso PB 15, 16 y 17, Col. Lomas de Chapultepec,  
C.P. 11000 México, D.F. México

**CANON EUROPA N.V.**

P.O.Box 2262, 1180 EG Amstelveen, The Netherlands

**CANON COMMUNICATION & IMAGE FRANCE S.A.**

102, Avenue du General de Gaulle, 92250 La Garenne Colombes, France

**CANON (UK) LTD.**

Woodhatch, Reigate, Surrey RH2 8BF, United Kingdom

**CANON DEUTSCHLAND GmbH**

Europark Fichtenhain A 10, 47807 Krefeld, Germany

**CANON ITALIA S.p.A.**

Via Milano 8, I-20097 San Donato Milanese (MI), Italy

**CANON (Schweiz) A.G.**

Industriestrasse 12, 8305 Dietlikon, Switzerland

**CANON BELGIUM N.V./S.A**

Bessenveldstraat 7, 1831 Diegem, Belgium

**CANON GmbH**

Zetschegasse 11, A-1232 Wien, Austria

**CANON ESPANA S.A.**

C/Joaquin Costa 41, 28002 Madrid, Spain

**CANON SVENSKA AB**

Stensättravägen 13, S-127 88 Skarholmen 2, Sweden

**CANON NORGE A/S**

Hallagerbakken 110, P. O. Box 2-33, Holmlia 1201 Oslo 12, Norway

**CANON OY**

Huopalahdentie 24, P.O. Box 1, FIN-00351 Helsinki, Finland

**CANON HONGKONG CO., LTD.**

19/F., The Metropolis Tower, 10 Metropolis Drive, Hung Hom, Kln., H. K.

**CANON SINGAPORE PTE. LTD.**

1 HarbourFront Avenue #04-01, Keppel Bay Tower Singapore 098632

**CANON AUSTRALIA PTY. LTD.**

1 Thomas Holt Drive, North Ryde, Sydney, N.S.W.2113, Australia

**CANON NEW ZEALAND LTD.**

Akoranga Business Park, Akoranga Drive, Northcote, Auckland, New Zealand

**CANON DENMARK A/S**

Knud Hoejgaards Vej, DK-2860 Soeborg, Denmark