

# Multimedia Projector

MODEL LV-7300

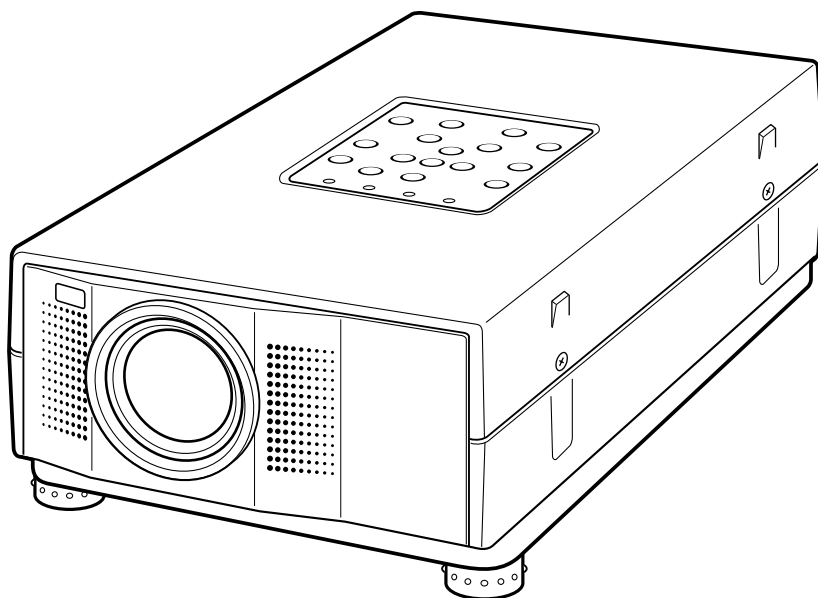

Owner's Manual

## INFORMATION TO THE USER

NOTE : This equipment has been tested and found to comply with the limits for a Class A digital device, pursuant to Part 15 of FCC Rules. These limits are designed to provide reasonable protection against harmful interference when the equipment is operated in a commercial environment. This equipment generates, uses, and can radiate radio frequency energy and, if not installed and used in accordance with the instruction manual, may cause harmful interference to radio communications. Operation of this equipment in a residential area is likely to cause harmful interference in which case the user will be required to correct the interference at his own expense.

## TO THE OWNER

As the owner of a new Multimedia Projector, you are probably eager to try out your new projector. Before you do, we suggest that you spend a little time reading this manual to familiarize yourself with the operating procedures, so that you will receive maximum satisfaction from the many features included in your new projector.

This owner's manual will acquaint you with your projector's features. Reading it will help us too. Through the years, we have found that many service requests were not caused by problems with our projectors. They were caused by problems that could have been prevented, if the owner had followed the instructions in the manual.

You can often correct operating problems yourself. If your projector fails to work properly, see "TROUBLESHOOTING" section on pages 36 ~ 37 and try the solution marked for each problem.

## SAFETY PRECAUTIONS

### WARNING:

**TO REDUCE THE RISK OF FIRE OR ELECTRIC SHOCK, DO NOT EXPOSE THIS APPLIANCE TO RAIN OR MOISTURE.**

This Projector has a grounding-type AC line plug. This is a safety feature to be sure that the plug will fit into the power outlet. Do not try to defeat this safety feature.

This projector produces intense light from the projection lens. Do not stare directly into the lens as possible eye damage could result. Be especially careful that children do not stare directly into the beam.

This projector should be set in the way indicated. If not, it may result in fire hazard.

If the projector will not be used for an extended time, unplug the projector from the power outlet.

**READ AND KEEP THIS OWNER'S MANUAL FOR LATER USE.**



**CAUTION**  
**RISK OF ELECTRIC SHOCK**  
**DO NOT OPEN**



**CAUTION : TO REDUCE THE RISK OF ELECTRIC SHOCK, DO NOT REMOVE COVER (OR BACK). NO USER-SERVICEABLE PARTS INSIDE EXCEPT LAMP REPLACEMENT. REFER SERVICING TO QUALIFIED SERVICE PERSONNEL.**



THIS SYMBOL INDICATES THAT DANGEROUS VOLTAGE CONSTITUTING A RISK OF ELECTRIC SHOCK IS PRESENT WITHIN THIS UNIT.



THIS SYMBOL INDICATES THAT THERE ARE IMPORTANT OPERATING AND MAINTENANCE INSTRUCTIONS IN THE OWNER'S MANUAL WITH THIS UNIT.

# IMPORTANT SAFETY INSTRUCTIONS

All the safety and operating instructions should be read before the product is operated.

Read all of the instructions given here and retain them for later use. Unplug this projector from AC power supply before cleaning. Do not use liquid or aerosol cleaners. Use a damp cloth for cleaning.

Do not use attachments not recommended by the manufacturer as they may cause hazards.

Do not place this projector on an unstable cart, stand, or table. The projector may fall, causing serious injury to a child or adult, and serious damage to the projector. Use only with a cart or stand recommended by the manufacturer, or sold with the projector. Wall of shelf mounting should follow the manufacturer's instructions, and should use a mounting kit approved by the manufacturers.

Do not expose this unit to rain or use near water... for example, in a wet basement, near a swimming pool, etc...

Slots and openings in the back and bottom of the cabinet are provided for ventilation, to insure reliable operation of the equipment and to protect it from overheating.

The openings should never be covered with cloth or other materials, and the bottom opening should not be blocked by placing the projector on a bed, sofa, rug, or other similar surface. This projector should never be placed near or over a radiator or heat register.

This projector should not be placed in a built-in installation such as a book case unless proper ventilation is provided.

This projector should be operated only from the type of power source indicated on the marking label. If you are not sure of the type of power supplied, consult your authorized dealer or local power company.

Do not overload wall outlets and extension cords as this can result in fire or electric shock. Do not allow anything to rest on the power cord. Do not locate this projector where the cord may be damaged by persons walking on it.

Never push objects of any kind into this projector through cabinet slots as they may touch dangerous voltage points or short out parts that could result in a fire or electric shock. Never spill liquid of any kind on the projector.

Do not attempt to service this projector yourself as opening or removing covers may expose you to dangerous voltage or other hazards. Refer all servicing to qualified service personnel.

Unplug this projector from wall outlet and refer servicing to qualified service personnel under the following conditions:

- When the power cord or plug is damaged or frayed.
- If liquid has been spilled into the projector.
- If the projector has been exposed to rain or water.

- If the projector does not operate normally by following the operating instructions. Adjust only those controls that are covered by the operating instructions as improper adjustment of other controls may result in damage and will often require extensive work by a qualified technician to restore the projector to normal operation.
- If the projector has been dropped or the cabinet has been damaged.
- When the projector exhibits a distinct change in performance-this indicates a need for service.

When replacement parts are required, be sure the service technician has used replacement parts specified by the manufacturer that have the same characteristics as the original part. Unauthorized substitutions may result in fire, electric shock, or injury to persons.

Upon completion of any service or repairs to this projector, ask the service technician to perform routine safety checks to determine that the projector is in safe operating condition.

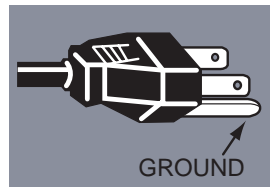

This projector is equipped with a grounding type AC line plug. Should you be unable to insert the plug into the outlet, contact your electrician. Do not defeat the safety purpose of this grounding type plug.

Follow all warnings and instructions marked on the projectors.

For added protection to the projector during a lightning storm, or when it is left unattended and unused for long periods of time, unplug it from the wall outlet. This will prevent damage due to lightning and power line surges.



An appliance and cart combination should be moved with care. Quick stops, excessive force, and uneven surfaces may cause the appliance and cart combination to overturn.

If the projector is to be built into a compartment or similarly enclosed, the minimum distances must be maintained. Do not cover the ventilation slot on the projector. Heat build-up can reduce the service life of your projector, and can also be dangerous.

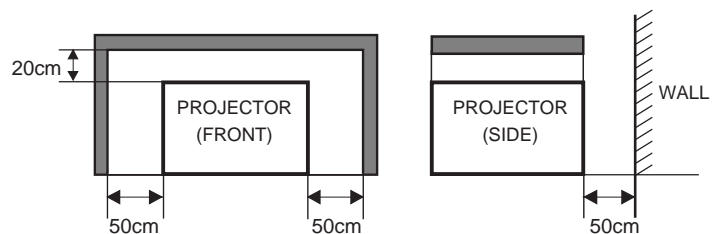

# TABLE OF CONTENTS

## FEATURES AND DESIGN 5

## PREPARATION 6

NAME OF EACH PART OF THE PROJECTOR	6
SETTING-UP THE PROJECTOR	7
POSITIONING THE PROJECTOR	8
ADJUSTABLE FEET	8
CONNECTING THE AC POWER CORD	8
VENTILATION	8
MOVING THE PROJECTOR	9

## CONNECTING THE PROJECTOR 10

TERMINALS OF THE PROJECTOR	10
CONNECTING TO THE VIDEO EQUIPMENT	11
CONNECTING TO THE IBM-COMPATIBLE COMPUTER	12
CONNECTING TO THE MACINTOSH COMPUTER	14

## BEFORE OPERATION 16

OPERATION OF THE REMOTE CONTROL	16
TOP CONTROLS AND INDICATORS	18
OPERATING ON-SCREEN MENU	19

## BASIC OPERATIONS 21

TURNING ON / OFF THE PROJECTOR	21
ADJUSTING THE PICTURE	22
NO SHOW FUNCTION	23
SOUND ADJUSTMENT	23

## COMPUTER MODE 24

SELECTING COMPUTER MODE	24
SELECTING COMPUTER SYSTEM	24
PC ADJUSTMENT	25
COMPATIBLE COMPUTER SPECIFICATIONS	26
PICTURE IMAGE ADJUSTMENT	27
PICTURE POSITION ADJUSTMENT	29
PICTURE SCREEN ADJUSTMENT	29

## VIDEO MODE 30

SELECTING VIDEO MODE	30
SELECTING COLOR SYSTEM	30
PICTURE IMAGE ADJUSTMENT	31
PICTURE SCREEN ADJUSTMENT	31

## SETTING 32

SETTING MENU	32
SELECTING LANGUAGE	32

## APPENDIX 33

OPERATING WIRELESS MOUSE	33
MAINTENANCE	34
AIR FILTER CARE AND CLEANING	34
LAMP REPLACEMENT	35
TROUBLESHOOTING	36
TECHNICAL SPECIFICATIONS	38

---

### TRADEMARKS

- Apple, Macintosh, and PowerBook are trademarks or registered trademarks of Apple Computer, Inc.
- IBM and PS/2 are trademarks or registered trademarks of International Business Machines, Inc.
- Each name of corporations or products in the owner's manual is a trademark or a registered trademark of its respective corporation.

# FEATURES AND DESIGN

---

This Multimedia Projector is designed with most advance technology for portability, durability, and ease for use. The projector utilizes built-in multimedia features, a palette of 16.77 million colors, and matrix liquid crystal display (LCD) technology.

## ◆ **Compatibility**

---

This projector is compatible with many different types of personal computers and video devices, including;

- IBM-compatible computers, including laptops, up to 1280 x 1024 resolution.
- Apple Macintosh and PowerBook computers up to 1280 x 1024 resolution.
- Various video equipment using any of the world wide video standards, including NTSC, NTSC4.43, SECAM, PAL, and PAL-M.

## ◆ **Image Resolution**

---

Picture Image is projected in the resolution of 1024 x 768. The projector provides computer images just as they appear on your computer's monitor. Screen resolutions between 1024 x 768 and 1280 x 1024 are compressed to 1024 x 768. The projector cannot display screen resolutions over 1280 x 1024. If your computer's screen resolution is higher than 1280 x 1024, reset it to a lower resolution before you connect the projector.

## ◆ **Portability**

---

This projector is extremely compact in size and weight. Having a sophisticated shape like an attaché case with a retractable carrying handle, the projector will help you make powerful presentation wherever you go.

## ◆ **Automatic Multiscanning System**

---

This projector can detect output signals from most personal computers currently distributed. It is free from complicated adjustments to project picture images from PC.

## ◆ **Multilanguage Menu Display**

---

Operation menu is displayed in; English, Deutsch, Français, Italiano, Español, or Japanese.

## ◆ **Other Features**

---

This projector has No show, Digital zoom and Mute functions, and Air Pad Remote Control.

## ◆ **Accessories**

---

This projector comes with the parts listed below. Check to make sure all are included. If any part is missing, contact to a sales dealer.

- Owner's Manual.
- AC Power Cord.
- Wireless Remote Control Unit.
- Batteries for Remote Control Unit.
- VGA Cable.
- Control Cable for PS/2 port.
- Lens Cover.
- Carrying Bag.

# PREPARATION

## NAME OF EACH PART OF THE PROJECTOR

### FRONT OF THE CABINET

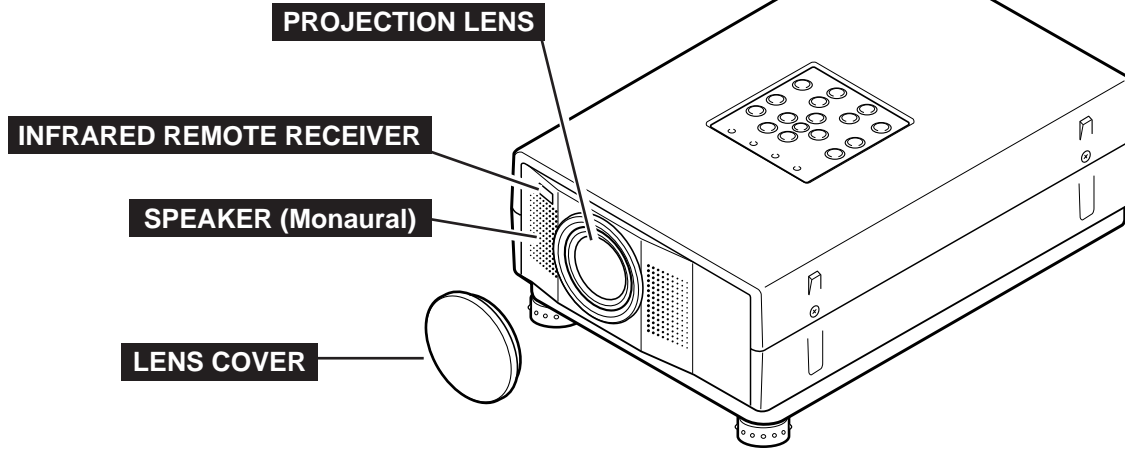

### BACK OF THE CABINET

#### EXHAUST VENT



#### HOT AIR EXHAUSTED !

Air blown from the exhaust vent is hot. When using or installing the projector, following attention should be taken.

- Do not put a flammable object near this part.  
Keep heat-sensitive objects away from the exhaust vent.
- Do not touch this part especially screws and metallic parts. This part will become hot while the projector is used.

#### POWER CORD CONNECTOR

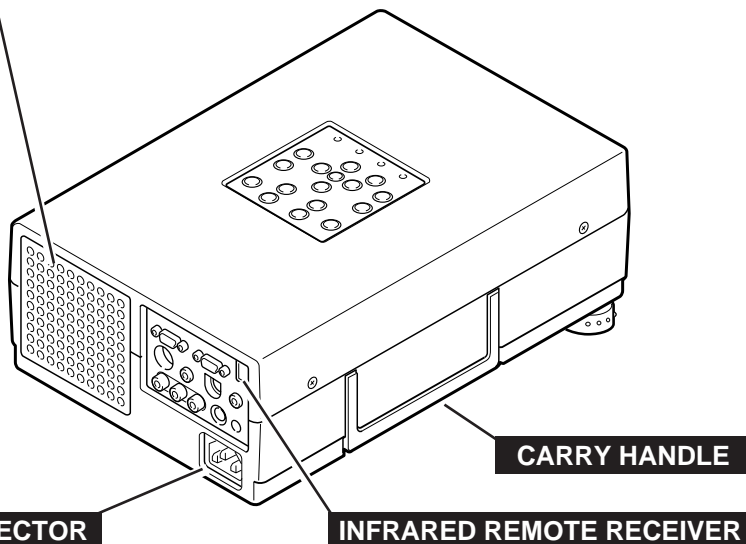

### BOTTOM OF THE CABINET

#### AIR INTAKE VENT

This Air Intake Vent should not be blocked.

#### LAMP COVER

#### ADJUSTABLE FEET

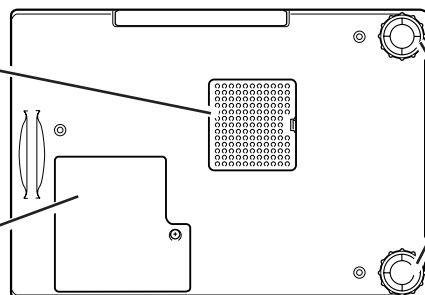

# SETTING-UP THE PROJECTOR

## POSITIONING THE PROJECTOR

- This projector is basically designed to project on a flat projection surface.
- The projector can be focused from 4.6'(1.4m) ~ 35.4'(10.8m).
- Refer to the figure below to adjust the screen size.

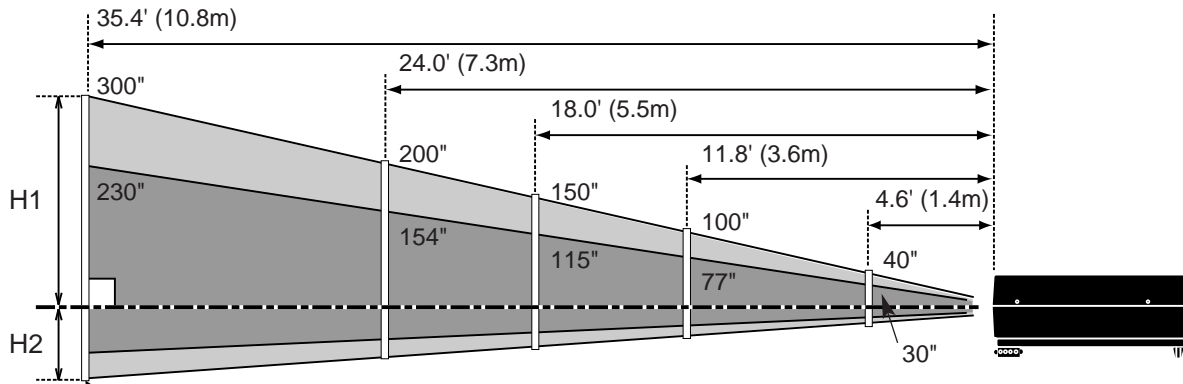

Screen Size (W x H) mm	30"	60"	100"	150"	200"	300"
Height (H1)	17.1"(435mm)	34.3"(870mm)	57.1"(1451mm)	85.7"(2177mm)	114.3"(2903mm)	171.4"(4354mm)
Height (H2)	0.9"(22mm)	1.7"(44mm)	2.9"(73mm)	4.3"(109mm)	5.7"(145mm)	8.6"(218mm)

## ROOM LIGHT

The brightness in the room has a great influence on the picture quality. It is recommended to limit ambient lighting in order to provide the best image.

## ADJUSTABLE FEET

Picture tilt and projection angle can be adjusted by twisting ADJUSTABLE FEET. Projection angle can be adjusted 0 to 2 degrees by rotating Adjustable Feet.

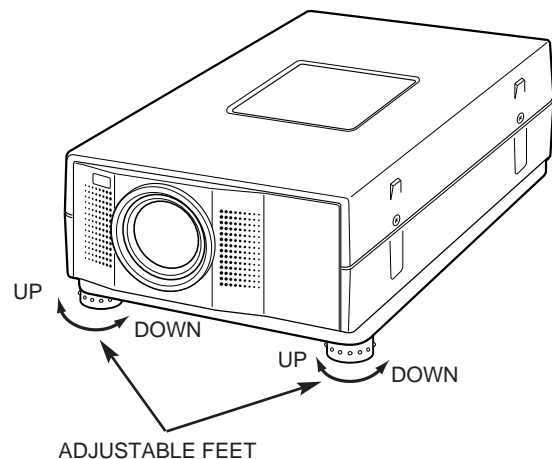

# PREPARATION

## CONNECTING THE AC POWER CORD

This projector uses nominal input voltages of 100-120 V AC. The projector automatically selects the correct input voltage. It is designed to work with single-phase power systems having a grounded neutral conductor. To reduce the risk of electrical shock, do not plug into any other type of power system.

Consult your authorized dealer or service station if you are not sure of the type of power supply being in use.

Connect the projector with the peripheral equipment before turning the projector on. (Refer to pages 10 ~15 for connection.)



### CAUTION

For the safety, unplug the AC Power Cord when the appliance is not used.

When this projector is connected to the outlet with the AC Power Cord, the appliance is in Stand-by Mode and consumes a little electric power.

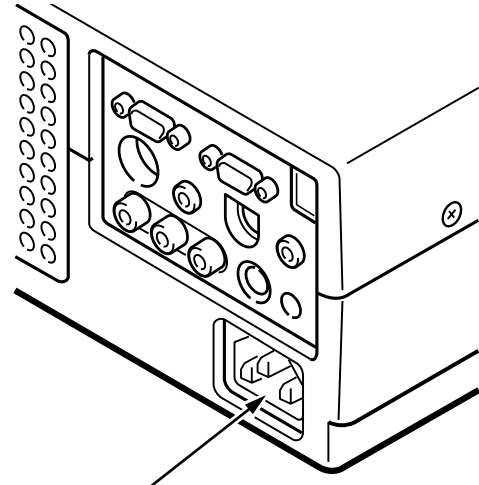

Connect the AC power supply cord (supplied) to the projector. The socket-outlet must be near this equipment and must be easily accessible.

Projector side (Female)

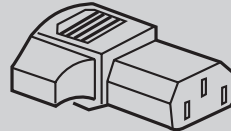

AC outlet side (Male)

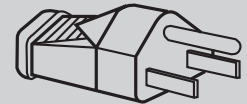

## VENTILATION

This projector is equipped cooling fans for protection from overheating. Pay attention to the following to ensure the ventilation and avoid a possible risk of fire and malfunction.

- Do not cover the vent slot.
- Keep the rear grill at least one meter away from any object.
- Make sure that there is no object under the projector. An obstacle under the projector may prevent the projector from taking the cooling air through the bottom vent slot.

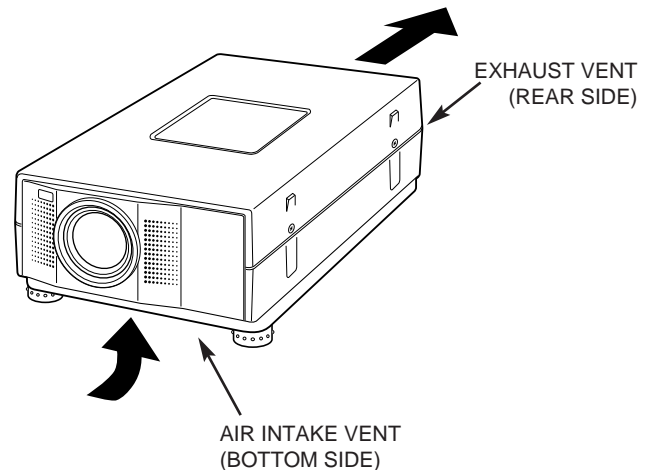



## MOVING THE PROJECTOR

Use the Carry Handle when moving the Projector.

- Replace the lens cover and rotate the feet fully clockwise (to shorten the feet) when moving the projector to prevent damage to the cabinet.

### NOTE

The carrying bag (supplied) is intended for protection from dust and scratches on the surface of the cabinet, and it is not designed to protect the LCD projector from external shock.

Do not drop the projector, subject it to strong forces, or put other things on the cabinet when carrying the projector with this bag. Do not transport the projector through a courier or transport services with this bag. The projector can be damaged.

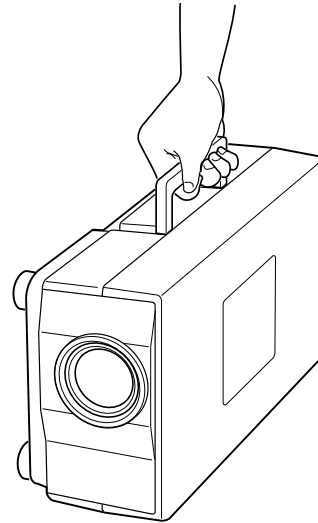

### CAUTION IN CARRYING OR TRANSPORTING THE PROJECTOR

- Do not drop or give a shock to the projector, otherwise damages or malfunctions may result.
- When carrying the projector, use a carrying case recommended by Sanyo.
- Do not transport the projector by using a courier or transport service in an unsuitable transport case. This may cause damage to the projector. To transport the projector through a courier or transport service, use a case recommended by Sanyo.
- For carrying or transportation cases, contact a Sanyo authorized dealer.

# CONNECTING THE PROJECTOR

## TERMINALS OF THE PROJECTOR

### COMPUTER INPUT TERMINAL

Connect the computer output to this terminal.  
(Refer to P12 ~15.)

### MONITOR OUTPUT TERMINAL

Connect to the monitor to this terminal.  
(Refer to P12 ~15.)

### CONTROL PORT CONNECTOR

When controlling the computer with the Remote Control of this projector, connect the mouse port to this connector.  
(Refer to P12 ~15.)

### SERIAL PORT CONNECTOR

This connector is used to connect a computer to control this projector with the PC.  
(Refer to P12 ~13.)

### COMPUTER AUDIO INPUT JACK

Connect the audio output from the computer to this jack.  
(Refer to P12 ~15.)

### AUDIO OUTPUT JACK

Connect the audio amplifier to this jack.  
(Refer to P12 ~15.)

### AUDIO INPUT JACKS

Connect the audio outputs from the video equipment to these jacks.  
(Refer to P11.)

- When the audio output is monaural, connect it to the AUDIO LEFT jack.

### VIDEO INPUT JACK

Connect the video output from the video equipment to this jack.  
(Refer to P11.)

### S-VIDEO INPUT JACK

Connect the S-VIDEO output from the video equipment to this jack.  
(Refer to P11.)

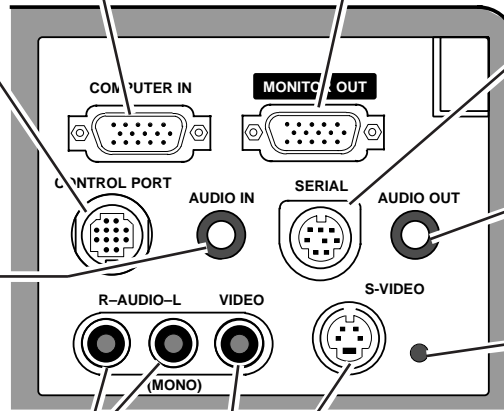

### RESET BUTTON

This projector uses a micro processor to control the unit. Occasionally, the micro processor may malfunction and need to be reset. This can be done by pressing the RESET button with a pen, which will shut down the unit. Turn the projector off and restart the unit. Do not use the RESET function excessively.

### COMPUTER INPUT / MONITOR OUTPUT TERMINAL

#### Terminal : HDB15-PIN

Connect the display output terminal of the computer to this COMPUTER INPUT with the VGA Cable (supplied), and connect the monitor to this MONITOR OUTPUT with the monitor cable (not supplied). When connecting the Macintosh computer, the MAC/VGA Adapter is required (not supplied).

#### Pin Configuration

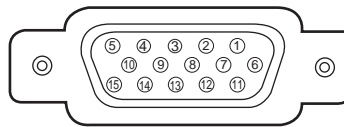

1	Red Input	9	Non Connect
2	Green Input	10	Ground (Vert.sync.)
3	Blue Input	11	Sense 0
4	Sense 2	12	Sense 1
5	Ground (Horiz.sync.)	13	Horiz. sync.
6	Ground (Red)	14	Vert. sync.
7	Ground (Green)	15	Reserved
8	Ground (Blue)		

### CONTROL PORT CONNECTOR

#### Terminal : MULTI-POLE 12-PIN

When controlling the computer with the projector's Wireless Remote Control Unit, connect control port (PS/2, Serial or ADB port) on your computer to this connector. (Control Cable for PS/2 Port is supplied.)

#### Pin Configuration

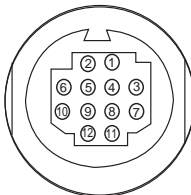

	PS/2	Serial	ADB
1	----	T X D	----
2	CLK	----	ADB
3	DATA	----	----
4	----	----	----
5	----	R X D	----
6	----	----	----
7	----	READY	----
8	----	----	----
9	GND	GND	GND
10	----	----	----
11	----	----	----
12	----	----	----

### SERIAL PORT CONNECTOR

#### Terminal : DIN 8-PIN

This connector is used to connect a computer to control the projector with the PC. For this connection, the Serial Cable is required (This cable is not supplied).

#### Pin Configuration

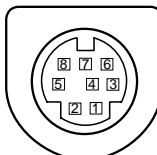

1	R x D	5	MUXTTL
2	ADB	6	T x D
3	MUX232	7	---
4	GND	8	---

# CONNECTING TO THE VIDEO EQUIPMENT

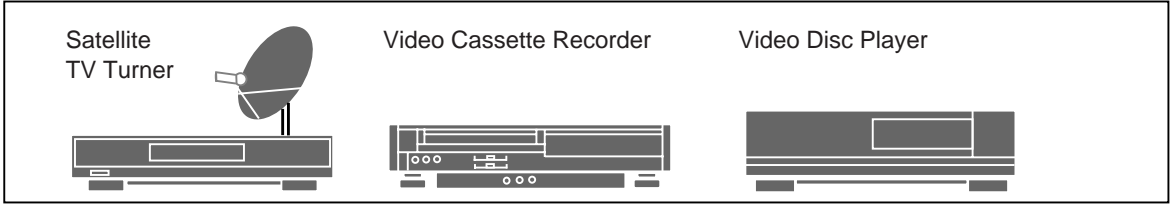

Video / Audio Output

S-VIDEO Output

**Used cables for connection**

- VIDEO CABLE \*
- S-VIDEO CABLE \*
- AUDIO CABLE (stereo) \*

\* These cables are not supplied with this projector.

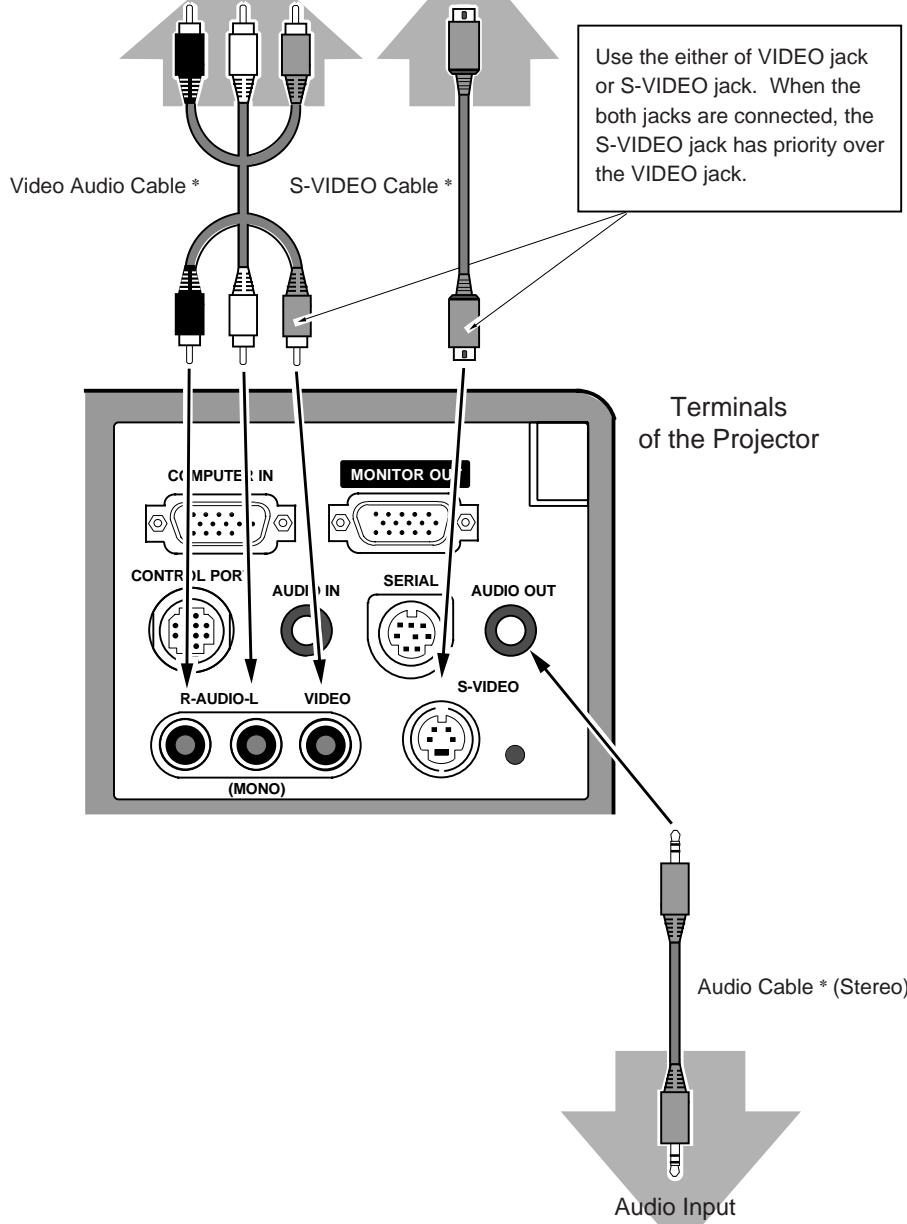

**NOTE :**  
When connecting the cable, the power cords of both the projector and the external equipment should be disconnected from AC outlet. Turn the projector and peripheral equipment on before the computer is switched on.

**External Audio Equipment**

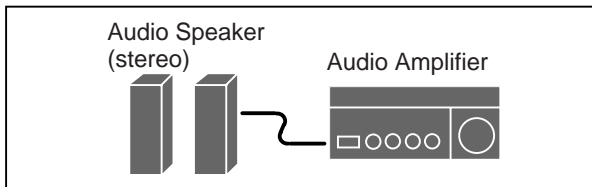

# CONNECTING TO THE IBM-COMPATIBLE COMPUTER

To connect with the IBM-compatible computer, refer to the figure below.

**Used cables for connection**

- VGA CABLE
- CONTROL CABLE FOR PS/2 PORT
- CONTROL CABLE FOR SERIAL PORT \*
- MONITOR CABLE \*
- PC AUDIO CABLE (stereo) \*

\* These cables are not supplied with this projector.



**NOTE :**

When connecting the cable, the power cords of both the projector and the external equipment should be disconnected from AC outlet. Turn the projector and peripheral equipment on before the computer is switched on.

IBM-COMPATIBLE COMPUTERS (VGA / SVGA / XGA / SXGA)

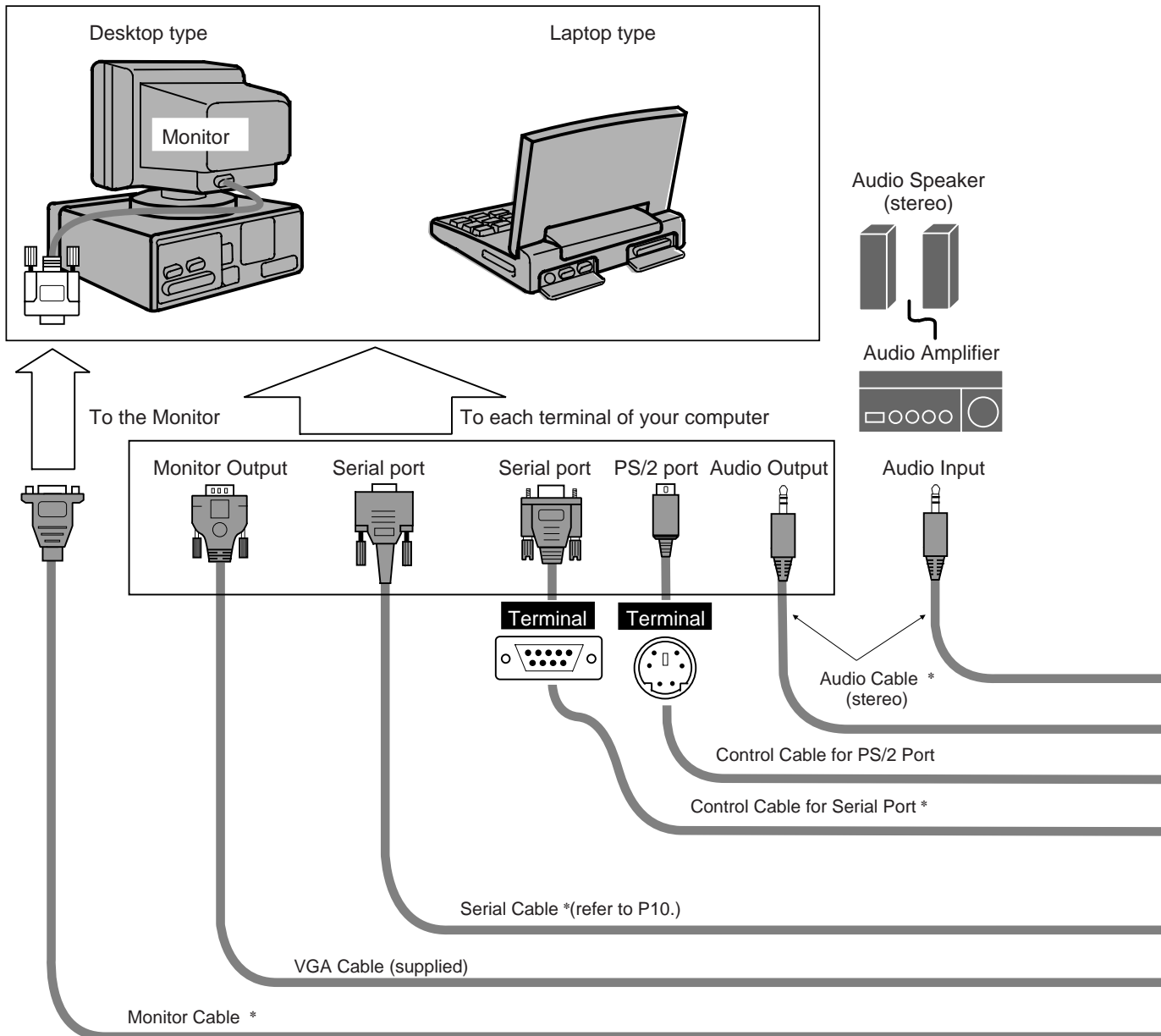

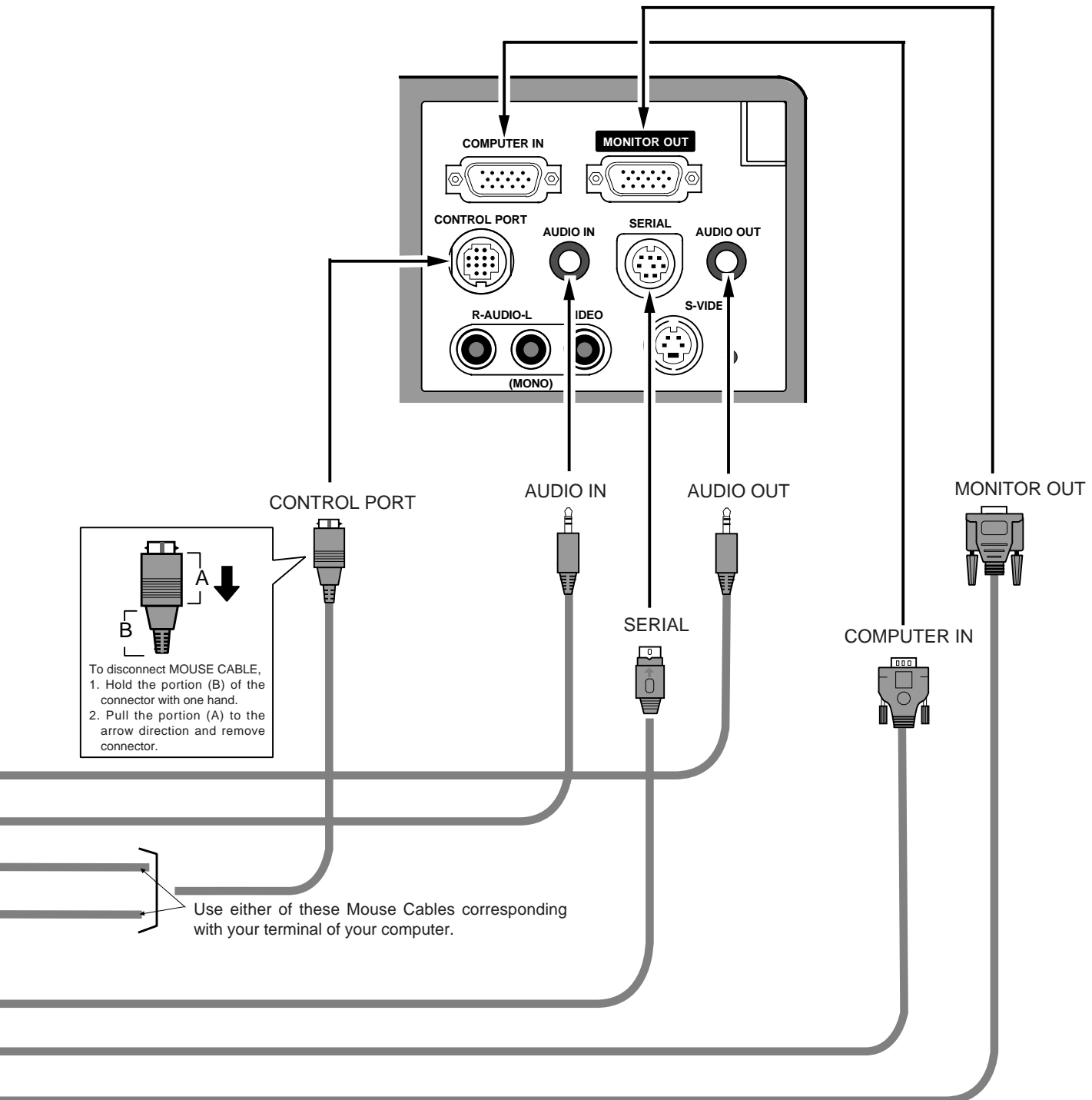

## CONNECTION TO THE MACINTOSH COMPUTER

To connect with the Macintosh computer, refer to the figure below.

### Used cables for connection

- VGA CABLE
- CONTROL CABLE FOR ADB PORT \*
- MAC ADAPTER \*
- MONITOR CABLE \*
- PC AUDIO CABLE (stereo) \*

\* These cables are not supplied with this projector.



### NOTE :

When connecting the cable, the power cords of both the projector and the external equipment should be disconnected from AC outlet. Turn the projector and peripheral equipment on before the computer is switched on.

### MACINTOSH COMPUTERS (VGA / SVGA / XGA / SXGA)

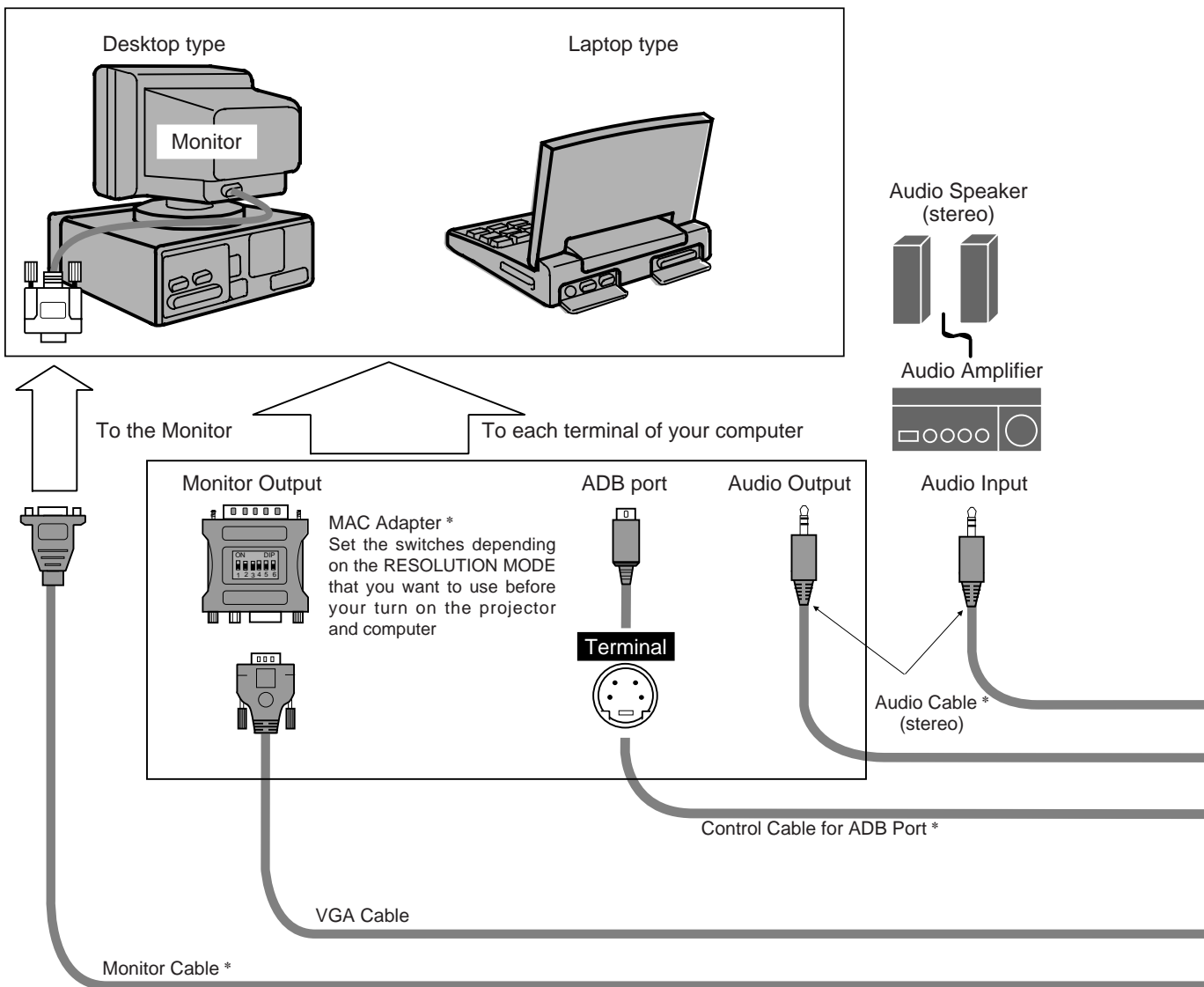

## ◆ MAC/VGA ADAPTER (not supplied)

Set the switches as shown in the table below depending on the RESOLUTION MODE that you want to use before your turn on the projector and computer.

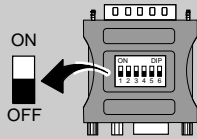

	1	2	3	4	5	6
13" MODE (640 x 480)	ON	ON	OFF	OFF	OFF	OFF
16" MODE (832 x 624)	OFF	ON	OFF	ON	OFF	OFF
19" MODE (1024 x 768)	OFF	ON	ON	OFF	OFF	OFF
21" MODE (1152 x 870)	ON	ON	ON	ON	OFF	OFF

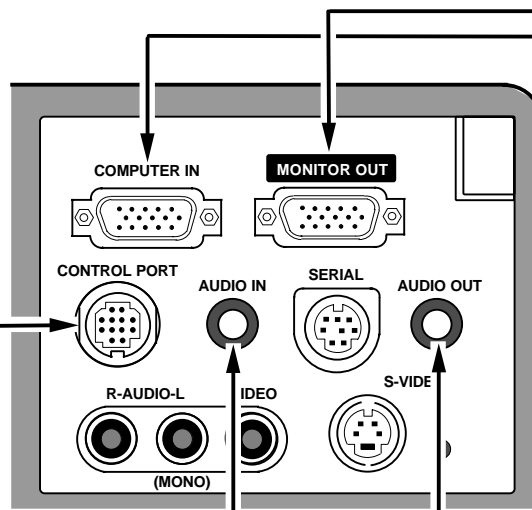

CONTROL PORT      AUDIO IN      AUDIO OUT      MONITOR OUT

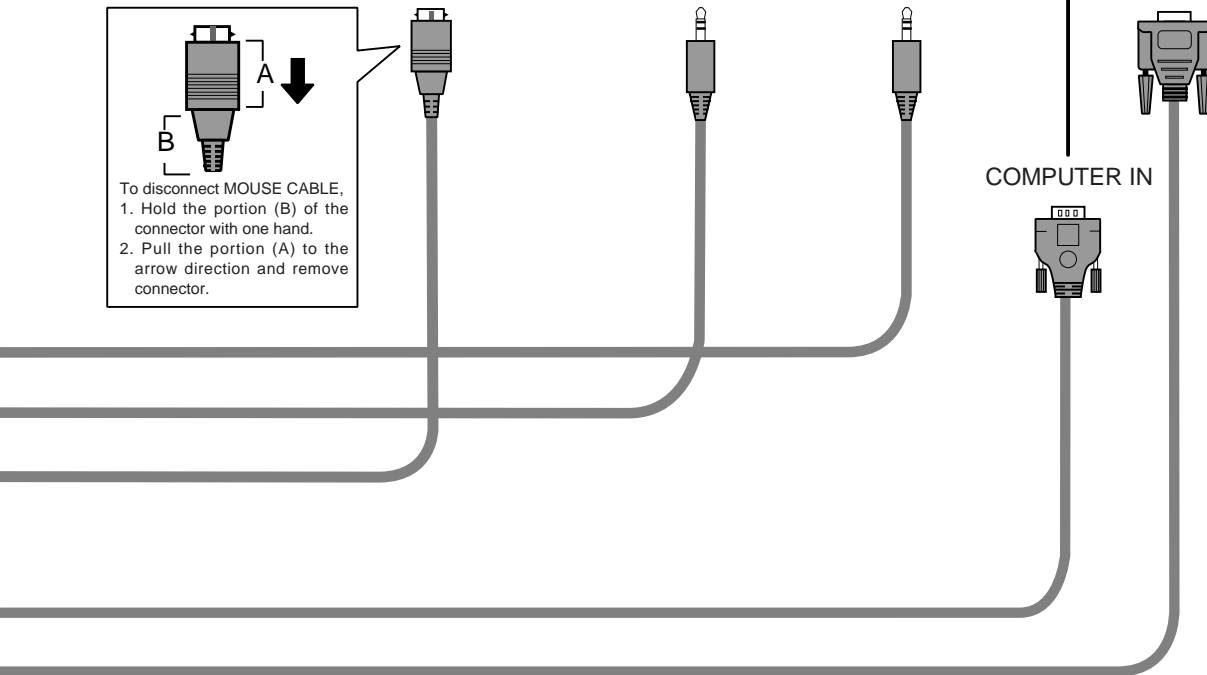
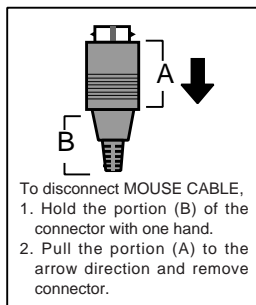

# BEFORE OPERATION

## OPERATION OF THE REMOTE CONTROL

This remote control unit is not only able to operate the projector but also usable as a wireless mouse for a PC. POINT button and two CLICK buttons are used for wireless mouse operation. (Refer to page 33.) Wireless mouse is usable when PC mouse pointer is displayed on the screen, the wireless mouse cannot be used when the On-Screen Menu is displayed.

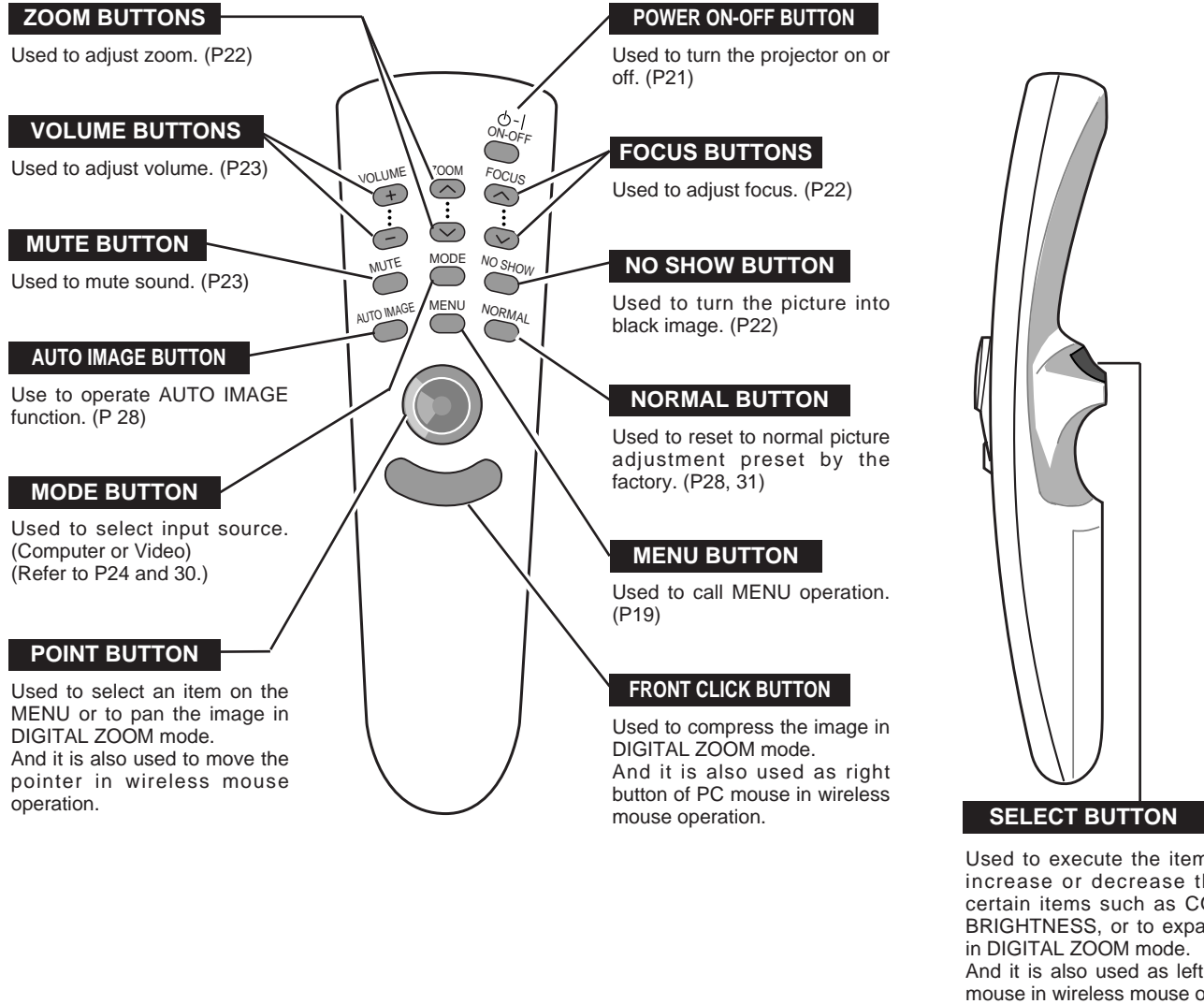



**Remote Control Batteries Installation**

**1** Remove the battery compartment lid.

Press the lid downward and slide it.

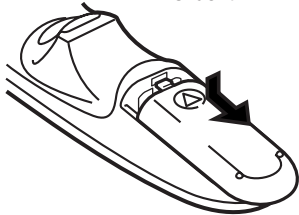

**2** Slide the batteries into the compartment.

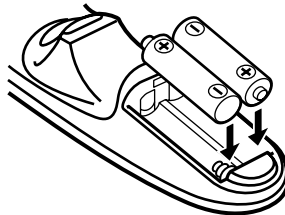

**3** Replace the compartment lid.

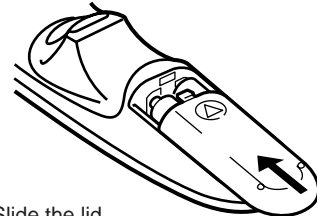

Slide the lid upward.

For correct polarity (+ and -), be sure the battery terminals are in contact with the pins in the compartment.



To insure safe operation, please observe the following precautions :

- Use (2) AA type alkaline batteries.
- Replace two batteries at the same time.
- Do not use a new battery with a used battery.
- Avoid contact with water or liquid.
- Do not drop the remote control unit.
- If batteries have leaked on the remote control, carefully wipe the case clean and load new batteries.

**Operating Range of the Remote Control**

Point the remote control toward the projector (Receiver Window) whenever pressing the buttons. Maximum operating range for the remote control is about 16.4' (5m) and 60° front and rear of the projector

**FRONT**

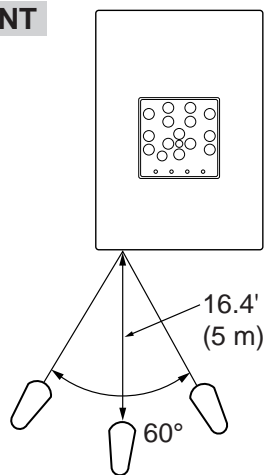

**REAR**

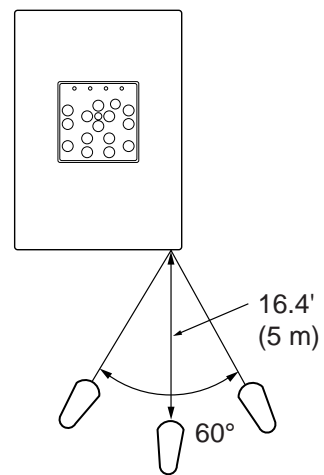

# TOP CONTROLS AND INDICATORS

**LAMP REPLACE INDICATOR**

This indicator turns to yellow when the life of the projection lamp draws to an end. (Refer to P35.)

**TEMPERATURE WARNING INDICATOR**

This indicator flashes red when internal projector temperature is too high. (Refer to P34.)

**READY INDICATOR**

This indicator is lit in green when the projector is ready to be turned on.

**LAMP INDICATOR**

This indicator is lit in dim when the projector is turned on. And the light is brightened when the projector is in stand-by mode.

**POINT BUTTONS**

Used to move the pointer. (Refer to P19.)

**FOCUS BUTTONS**

Used to select focus adjust. (Refer to P22.)

**MENU BUTTON**

Used to active or terminate the MENU operation. (Refer to P19.)

**MODE BUTTON**

Used to select input source. (Computer or Video) (Refer to P24 and 30.)

**NORMAL BUTTON**

Used to reset to normal picture adjustment preset by factory. (Refer to P28 and 31.)

**VOLUME BUTTONS**

Used to adjust volume. (Refer to P23.)

**POWER ON-OFF BUTTON**

Used to turn the projector on or off. (Refer to P21.)

**ZOOM BUTTONS**

Used to select zoom adjust. (Refer to P22.)

**SELECT BUTTON**

Used to execute the item selected or to adjust the values in certain items on the MAIN MENU DISPLAY.

**AUTO IMAGE BUTTON**

Used to operate AUTO IMAGE function. (Refer to P28.)

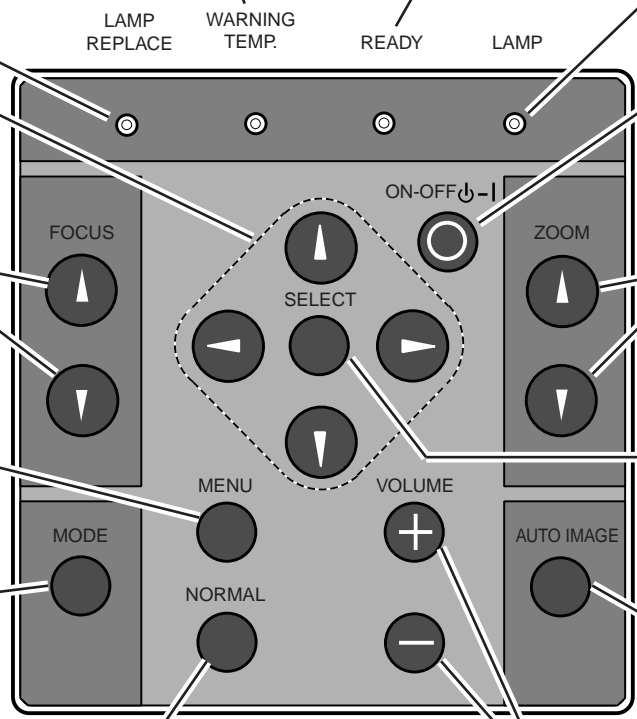

# OPERATING ON-SCREEN MENU

## HOW TO OPERATE ON-SCREEN MENU

You can control and adjust this projector through ON-SCREEN MENU. Refer to the following pages to operate the each adjustment on the ON-SCREEN MENU.

### 1 MOVING THE POINTER

Move the pointer (see the NOTE below) by pressing POINT button(s) on the Top Control or on the Remote Control Unit.

### 2 SELECT THE ITEM

Select the item by pressing SELECT button.

NOTE : Pointer is the icon on the ON-SCREEN Menu to select the item. See the figures on the section "FLOW OF ON-SCREEN MENU" below.

### WIRELESS REMOTE CONTROL

#### POINT BUTTON

Used to move the Pointer to UP/ DOWN/ RIGHT/ LEFT.

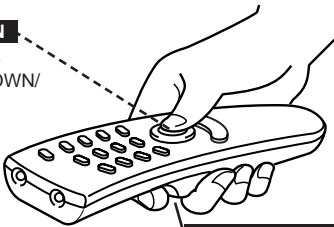

#### SELECT BUTTON

Used to select the item.

### TOP CONTROL

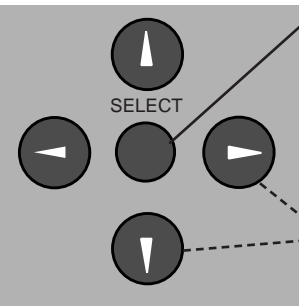

#### SELECT BUTTON

Used to select the item.

#### POINT BUTTONS

Used to move the Pointer to UP/ DOWN/ RIGHT/ LEFT.

## FLOW OF ON-SCREEN MENU

### Display ON-SCREEN MENU

1 Press MENU button to display the ON-SCREEN MENU (MENU BAR). The red frame is the POINTER.

### Select the MENU

2 Move the POINTER (red frame) to the ITEM ICON that you want to select by pressing POINT RIGHT/ LEFT buttons.

3 Select the ITEM by pressing SELECT button. The dialog box of the ITEM appears.

### Control and adjust through ON-SCREEN MENU

4 Move the POINTER downward by pressing POINT DOWN button. (The shape of POINTER become an arrow.)

5 Move the POINTER to the ITEM that you want to adjust and adjust the ITEM by pressing SELECT button. Refer to the following pages for details of respective adjustments.

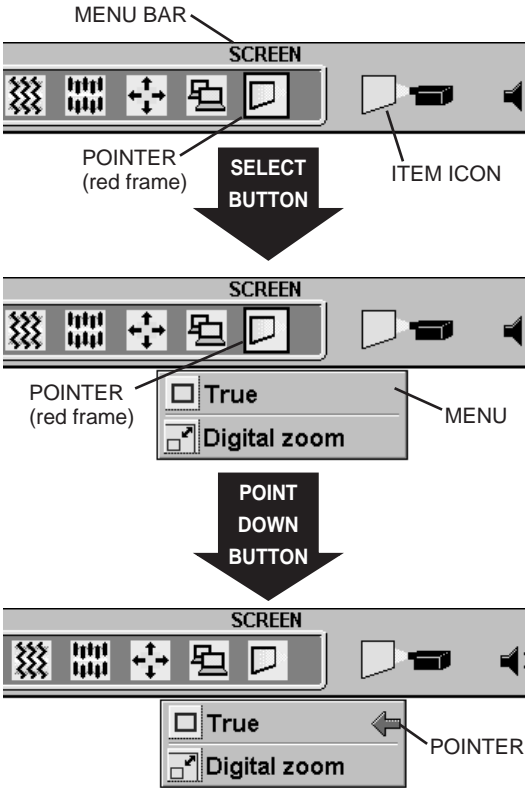

**MENU BAR**

**MENU BAR IN COMPUTER MODE** Press MENU BUTTON while being in Computer mode.

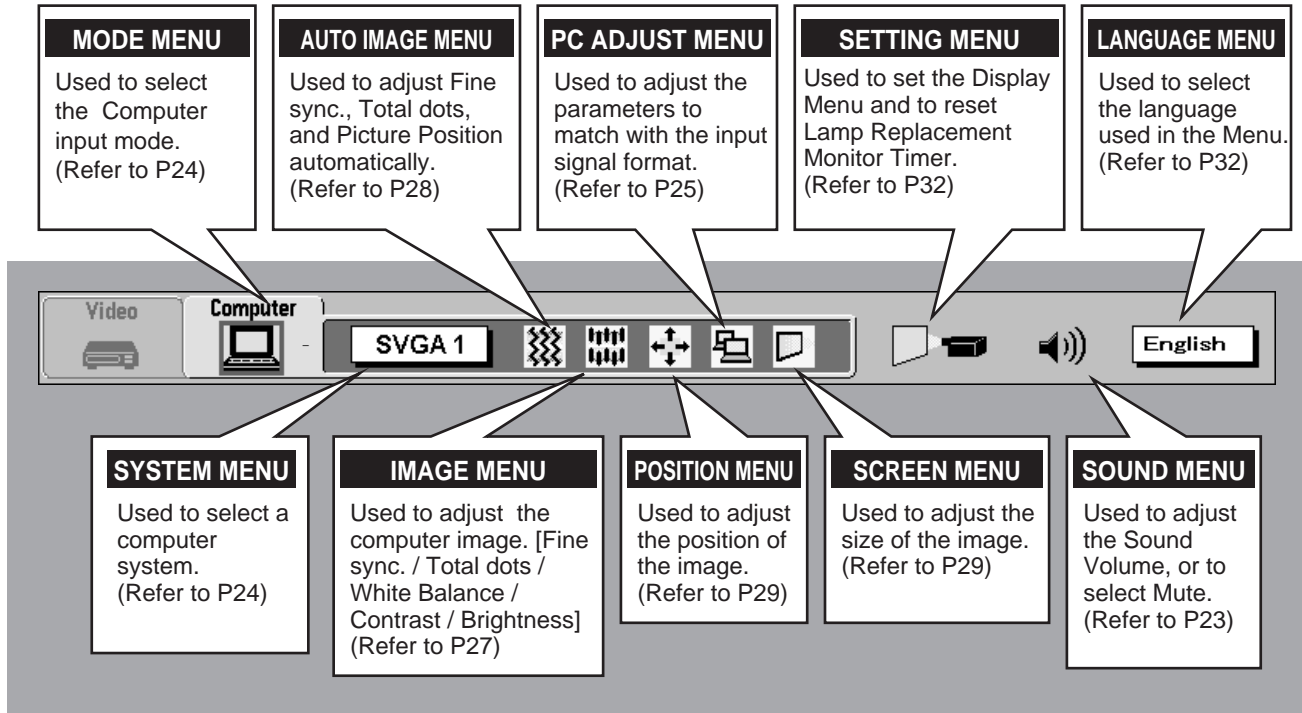

**MENU BAR IN VIDEO MODE** Press MENU BUTTON while being in Video mode.

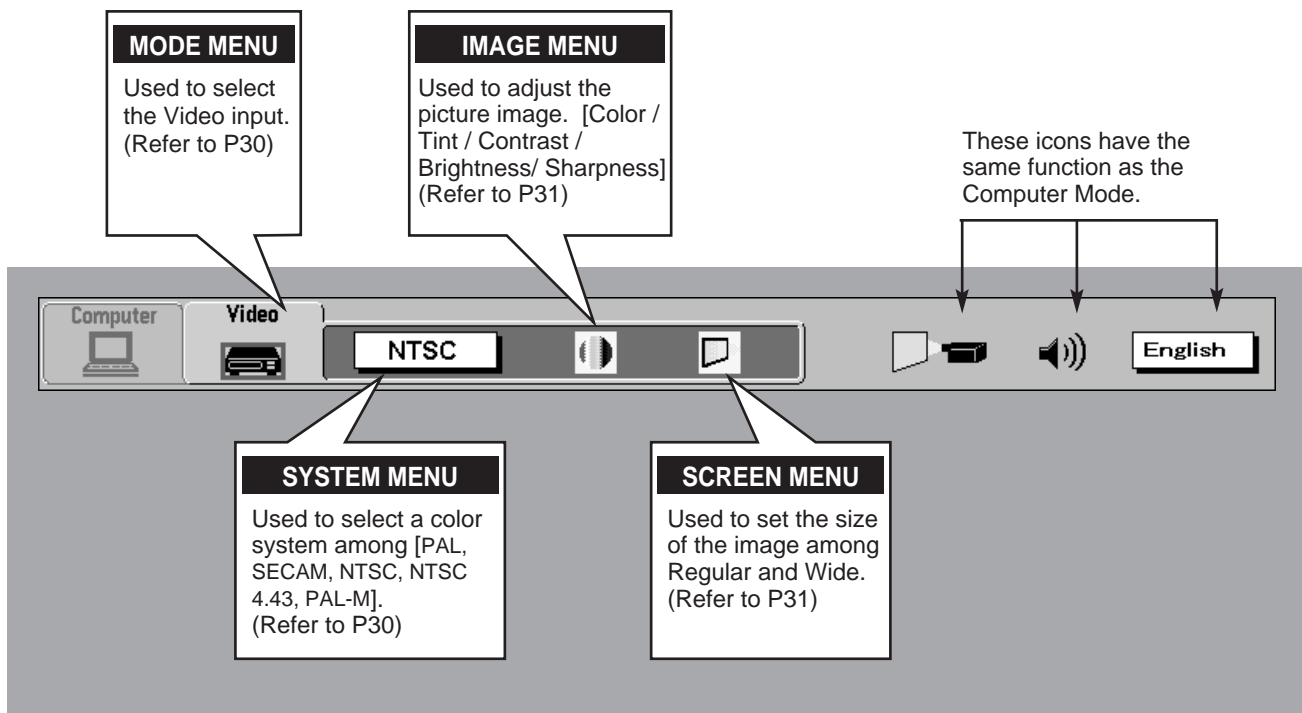

## TURNING ON / OFF THE PROJECTOR

### Turning on the Projector

- 1 Complete the peripheral connections (with Computer, VCR, and etc.) before turning on the projector. (Refer to "CONNECTING TO THE PROJECTOR" on Pages 10~15 for connecting those equipment.
- 2 Connect the projector's AC power cord into a wall outlet. The LAMP POWER indicator lights RED, and the READY indicator lights GREEN.
- 3 Press the power ON-OFF button on the Remote Control Unit or on the Top Control to ON. The LAMP POWER indicator dims, and the Cooling Fans start to operate. The Preparation Display appears on the screen and the count-down starts. The signal from the source appears after 30 seconds.

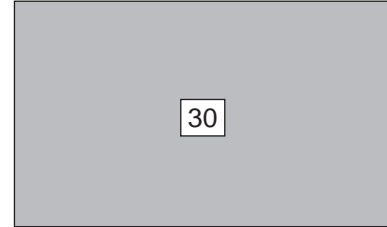

The Preparation Display disappears after 30 seconds.

### Turning off the Projector

- 1 Press the power ON-OFF button on the Remote Control Unit or on the Top Control, and the message "Power off?" appears on the screen.
- 2 Press again the power ON-OFF button to turn off the projector. The LAMP POWER indicator lights bright and the READY indicator turns off. The Cooling Fans operate for 90 seconds after the projector is turned off. (During this "Cooling Down" period, this appliance cannot be turned on.)
- 3 When the cooling the projector has finished, the READY indicator turns to green again and you can turn the projector on. To power down completely, disconnect the AC power cord.

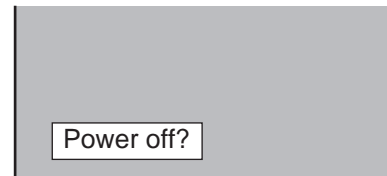

The message disappears after 4 seconds.



TO MAINTAIN THE LIFE OF THE LAMP, ONCE YOU TURN IT ON, WAIT AT LEAST 5 MINUTES BEFORE TURNING IT OFF.

When the TEMPERATURE WARNING indicator flashes red, the projector is automatically turned off. Wait at least 5 minutes before turning the projector on again.

If the TEMPERATURE WARNING indicator continues to flash, follow procedures below:

1. Disconnect the AC power cord from the AC outlet.
2. Check the air filters for dust accumulation.
3. Clean the Air Filter. (See "AIR FILTER CARE AND CLEANING" section on page 33.)
4. Press the power ON-OFF button to ON.

If the TEMPERATURE WARNING indicator still continues to flash, call your authorized dealer or service station.

**NOTE :** The Cooling Fan may work for cooling while the projector is turned off. When the Cooling Fan is working, TEMPERATURE WARNING INDICATOR flashes red.

## ADJUSTING THE PICTURE

### ZOOM Adjustment

- 1 Press ZOOM  $\wedge$  /  $\vee$  button on the Remote Control Unit or ZOOM  $\blacktriangle$  /  $\blacktriangledown$  button on the Top Control to turn into the ZOOM mode.
- 2 Press ZOOM  $\wedge$  or  $\blacktriangle$  button to have the image larger, and press ZOOM  $\vee$  or  $\blacktriangledown$  button to have the smaller.

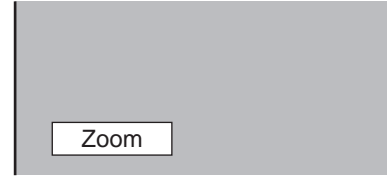

The message disappears after 4 seconds.

### FOCUS Adjustment

- 1 Press FOCUS  $\wedge$  /  $\vee$  button on the Remote Control Unit or FOCUS  $\blacktriangle$  /  $\blacktriangledown$  on the Top Control to turn into the FOCUS mode.
- 2 Adjust the focus of the image by pressing FOCUS  $\wedge$  /  $\vee$  or FOCUS  $\blacktriangle$  /  $\blacktriangledown$  buttons.

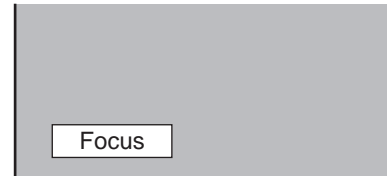

The message disappears after 4 seconds.

## NO SHOW FUNCTION

Press the NO SHOW button on the Remote Control Unit to turn the picture into black image. These function is cancelled when the NO SHOW button is pressed again or any other function button is pressed.

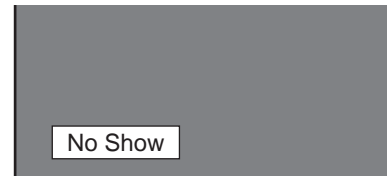

The message disappears after 4 seconds.

# SOUND ADJUSTMENT

## Direct Operation

### Sound Volume Adjustment

Press the VOLUME (+/-) buttons (located on the Top Control or on the Remote Control Unit) to adjust the volume. The Volume dialog box appears on the screen for a few seconds.  
(+) button to increase the volume, and (-) button decreasing.

### Sound Mute Setting

Press the MUTE button on the Remote Control Unit to cut off the sound. To restore the sound to its previous level, press the MUTE button again or press VOLUME (+/-) buttons.

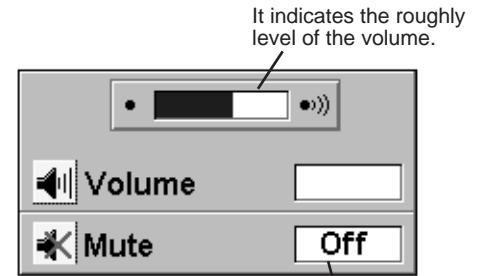

Press the MUTE button to set the Mute function On or Off.

The display disappears after 4 seconds.

## Menu Operation

- 1 Press the MENU button and the ON-SCREEN MENU will appear. Press the POINT LEFT/RIGHT buttons to select SOUND and press the SELECT button. Another dialog box SOUND ADJUST Menu will appear.
- 2 Press the POINT DOWN button and a red-arrow icon will appear. Move the arrow to the item that you want to select by pressing the POINT UP/DOWN buttons.

### Volume

Move the arrow to ▲ or ▼ of "Volume" by pressing the POINT UP/ DOWN buttons. To increase the volume, point the arrow to ▲ and then press the SELECT button. To decrease the volume point the arrow to ▼ and then press the SELECT button.

### Mute

To cut off the audio sound, point the arrow to "Mute" and then press the SELECT button. The Mute display is changed On from Off and the sound is cut off. To restore the sound to its previous volume level, set the Mute to Off.

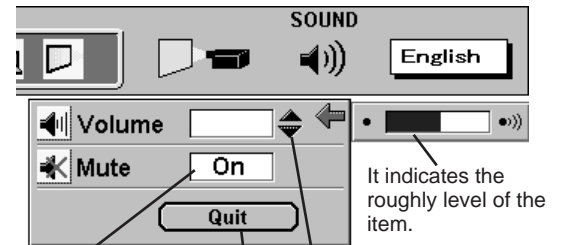

Move the arrow to the item and then press the SELECT button.

Move the arrow to ▲ or ▼ and press the SELECT button.

It indicates the roughly level of the item.

It closes the Sound Menu.

# COMPUTER MODE

## SELECTING COMPUTER MODE

### Direct Operation

Press the MODE button on the Top Control or the Remote Control Unit. The input source is selected among COMPUTER or VIDEO. The "Computer" or "Video" display will appear on the screen for a few seconds.

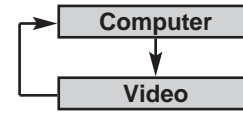

### Menu Operation

Press the MENU button and the ON-SCREEN MENU will appear. Press the POINT LEFT/RIGHT buttons to select Computer  and press the SELECT button.

#### CURRENT MODE DISPLAY

When selecting the Computer Mode, the Current Mode display appears. It shows the information of the computer of the mode selected.

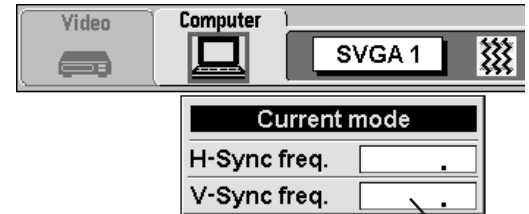

Providing the information of the computer detected by the projector.

## SELECTING COMPUTER SYSTEM

### Automatic Multiscanning system

This projector automatically adapt to most different types of computer based on VGA, SVGA or XGA (refer to "COMPATIBLE COMPUTER SPECIFICATION" on page 26). When selecting Computer, this projector become automatically suited to the incoming signal and projectors the proper image without any special setting. (Setting of the Computer System may be required when connecting some computers.)

Note : The projector may provides the messages below.

**Go PC adj.** The projector cannot discriminate or detect the input signal from the computer. Adjust and set the computer system manually. (Refer to page 25.)

**No signal** There is no signal input from the computer. Make sure the connection of the computer and the projector is set correctly. (Refer to TROUBLESHOOTING on page 36.)



#### SYSTEM BOX

It displays the SYSTEM being selected.

### Selecting Computer System Manually

To set the Computer system manually, select the mode on the ON-SCREEN MENU.

**1** Press the MENU button and the ON-SCREEN MENU will appear. Press the POINT LEFT/RIGHT buttons to select SYSTEM and press the SELECT button. Another dialog box COMPUTER MODE Menu will appear. (The COMPUTER MODE Menu also appears by pressing the SYSTEM button on the Top Control or the Remote Control Unit.)

**2** Press the POINT DOWN button and a red-arrow icon will appear. Move the arrow to the system that you want to set, and then press SELECT button.

The system being selected.



The systems on this dialog box can be selected.

When this mark is displayed as black, more computer system modes will be available. Move the arrow to this mark and then press the SELECT button, and another mode will be displayed.

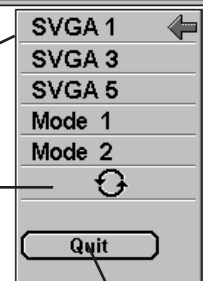

It closes the SYSTEM Menu.



# PC ADJUSTMENT

This Projector can automatically detect display signals from most personal computers currently distributed. However, some computers employ special signal formats which are different from the standard ones and may not be detected by this projector. If this happens, the projector cannot reproduce a proper image and the image is recognized as a flickering picture, a non-synchronized picture, a non-centered picture or a skewed picture.

This projector has PC ADJUSTMENT function, to enable you to precisely adjust several parameters to match with the input signal format. The projector has eight independent memory areas where you can store the parameter you have set. This enables you to recall the setting for a specific computer whenever you need it.

- 1 Press the MENU button and the ON-SCREEN MENU will appear. Press the POINT LEFT/RIGHT buttons to select PC ADJUST and press the SELECT button. Another dialog box "Where to reserve" Menu will appear.
- 2 In this dialog box, you can store the parameter into the area from "Mode 1" to "Mode 8." When memorizing the new computer parameter, select the Mode with the message of "Free" by pressing the POINT UP/DOWN buttons and SELECT button. To change the parameters of the Mode previously set, select the Mode with "Stored."
- 3 When the Mode is selected, Parameter adjustment dialog box appears. Adjust the each item to match with your computer.

- Total lines** The number of the total vertical lines. Adjust the number to match your PC image.
- Total dots** The number of the total dots in one horizontal period. Adjust the number to match your PC image.
- Horizontal** Adjustment of the horizontal picture position. When the image is not centered on the screen, adjust this item.
- Vertical** Adjustment of the vertical picture position. When the image is not centered on the screen, adjust this item.
- Clamp** Adjustment of the clamp level. When the image has a dark bar(s), try this adjustment.
- Display area** Adjustment of the display area to match your PC. The data of the selected mode is displayed in "H" and "V" boxes.
- Horiz. scale** Adjusting the height of the picture image.
- Vert. scale** Adjusting the width of the picture image.

- 4 When the parameter data adjustment finishes to be set, select "Stored" and press the SELECT button. "OK?" dialog box is displayed for confirmation.

Each of the keys operates as follow.

- Reset** .... It recall the parameter data that previously adjusted.
- Mode free** .... It clear the parameter data previously set the selected Mode.
- Stored** .... It stores the parameters in the memory.
- Quit** .... It closes the PC ADJUST Menu.

- 5 To select the Mode manually adjusted in PC ADJUSTMENT Menu, select the mode at the SYSTEM SELECT Menu. (Refer to page 24.)

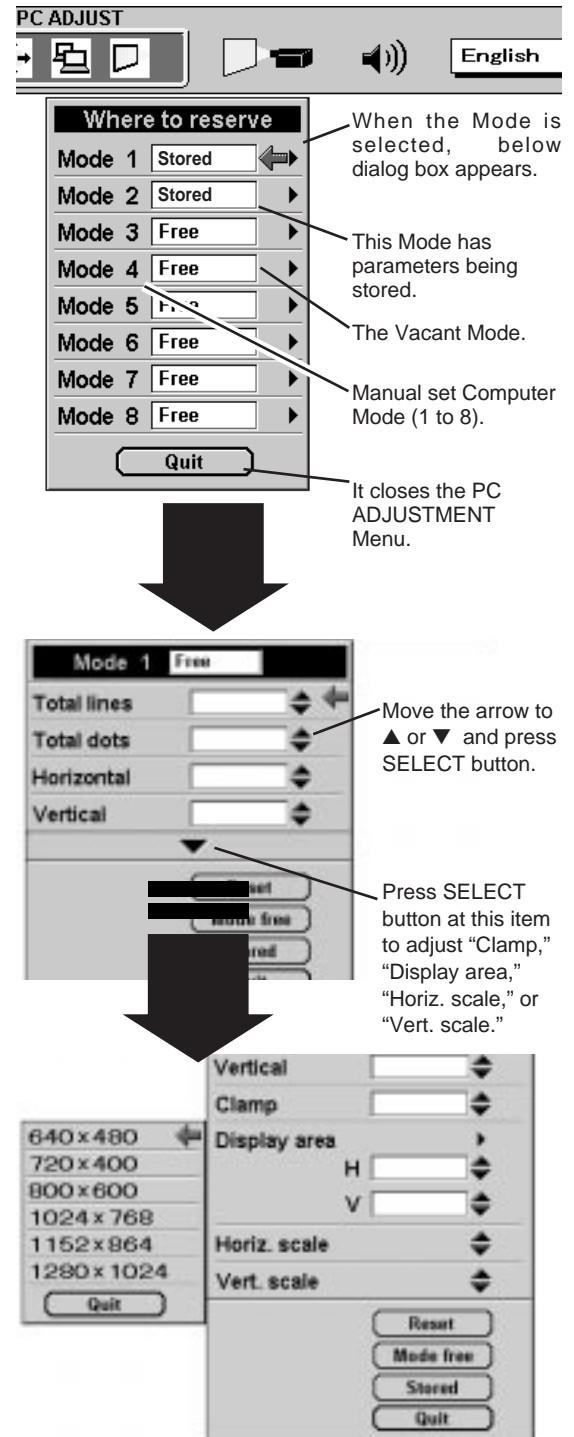

## COMPATIBLE COMPUTER SPECIFICATIONS

Basically this projector can accept the signal from all computers with the V, H-Frequency below mentioned and less than 165 MHz of Dot Clock.

ON-SCREEN DISPLAY	RESOLUTION	H-Freq. (kHz)	V-Freq. (Hz)	ON-SCREEN DISPLAY	RESOLUTION	H-Freq. (kHz)	V-Freq. (Hz)
VGA 1	640 x 480	31.47	59.88	XGA 5	1024 x 768	60.31	74.92
VGA 2	720 x 400	31.47	70.09	XGA 6	1024 x 768	48.50	60.02
VGA 3	640 x 400	31.47	70.09	XGA 7	1024 x 768	44.00	54.58
VGA 4	640 x 480	37.86	74.38	XGA 8	1024 x 768	63.48	79.35
VGA 5	640 x 480	37.86	72.81	XGA 9	1024 x 768 (Interlace)	36.00	43.59
VGA 6	640 x 480	37.50	75.00	XGA 10	1024 x 768	62.04	77.07
VGA 7	640 x 480	43.269	85.00	XGA 11	1024 x 768	61.00	75.70
MAC LC13	640 x 480	34.97	66.60	XGA 12	1024 x 768 (Interlace)	35.522	43.48
MAC 13	640 x 480	35.00	66.67	XGA 13	1024 x 768	46.90	58.20
MAC1 6	832 x 624	49.72	74.55	XGA 14	1024 x 768	47.00	58.30
MAC 19	1024 x 768	60.24	75.08	XGA15	1024 x 768	58.03	72.0
MAC21	1152 x 870	68.68	75.06	SXGA 1	1152 x 864	64.20	70.40
MAC	1280 x 960	75.00	75.08	SXGA 2	1280 x 1024	62.50	58.60
MAC	1280 x 1024	80.00	75.08	SXGA 3	1280 x 1024	63.90	60.00
RGB	768 x 576 (Interlace)	15.625	25	SXGA 4	1280 x 1024	63.34	59.98
RGB	640 x 480 (Interlace)	15.734	30	SXGA 5	1280 x 1024	63.74	60.01
SVGA 1	800 x 600	35.156	56.25	SXGA 6	1280 x 1024	71.69	67.19
SVGA 2	800 x 600	37.88	60.32	SXGA 7	1280 x 1024	81.13	76.107
SVGA 3	800 x 600	46.875	75.00	SXGA 8	1280 x 1024	63.98	60.02
SVGA 4	800 x 600	53.674	85.06	SXGA 9	1280 x 1024	79.976	75.025
SVGA 5	800 x 600	48.08	72.19	SXGA 10	1280 x 960	60.00	60.00
SVGA 6	800 x 600	37.90	61.03	SXGA 11	1152 x 900	61.20	65.20
SVGA 7	800 x 600	34.50	55.38	SXGA 12	1152 x 900	71.40	75.60
SVGA 8	800 x 600	38.00	60.51	SXGA 13	1280 x 1024 (Interlace)	50.00	43.00
SVGA 9	800 x 600	38.60	60.31	SXGA 14	1280 x 1024 (Interlace)	50.00	47.00
SVGA 10	800 x 600	32.70	51.09	SXGA 15	1280 x 1024	63.37	60.01
SVGA 11	800 x 600	38.00	60.51	SXGA 16	1280 x 1024	76.97	72.00
XGA 1	1024 x 768	48.36	60.00	SXGA 17	1152 x 900	61.85	66.00
XGA 2	1024 x 768	68.677	84.997	SXGA 18	1280 x 1024 (Interlace)	46.43	43.35
XGA 3	1024 x 768	60.023	75.03	SXGA 19	1280 x 1024	63.79	60.18
XGA 4	1024 x 768	56.47	70.07	SXGA 20	1280 x 1024	91.146	85.024

NOTE : Specifications are subject to change without notice.

# PICTURE IMAGE ADJUSTMENT

## Adjust Picture Image Manually

- 1 Press the MENU button and the ON-SCREEN MENU will appear. Press the POINT LEFT/RIGHT buttons to select IMAGE  and press the SELECT button. Another dialog box PICTURE IMAGE ADJUSTMENT Menu will appear.
- 2 Press the POINT DOWN button and a red-arrow icon will appear. Move the arrow to ▲ or ▼ of the item that you want to change by pressing the POINT UP/DOWN buttons. To increase the value, point the arrow to ▲ and then press the SELECT button. To decrease the value point the arrow to ▼ and then press the SELECT button.

### Fine sync

Adjust the picture as necessary to eliminate flicker from the display. (From 0 to 127.)

### Total dots

The number of the total dots in one horizontal period. Adjust the number to match your PC image.

### White balance (Red / Green / Blue)

Point to ▼ to adjust the color of image lighter, and select ▲ to adjust the image deeper. (From 0 to 63.)

### Contrast

Point to ▼ to adjust the image lighter, and select ▲ to adjust the image deeper. (From 0 to 63.)

### Brightness

Point to ▼ to adjust the image darker, and select ▲ to adjust the image brighter. (From 0 to 63.)

Each of the keys operates as follow.

**Reset** .... It recalls the data previously adjusted.

**Stored** .... It stores the adjusted data in the memory.

**Quit** .... It closes the PICTURE IMAGE ADJUSTMENT Menu.

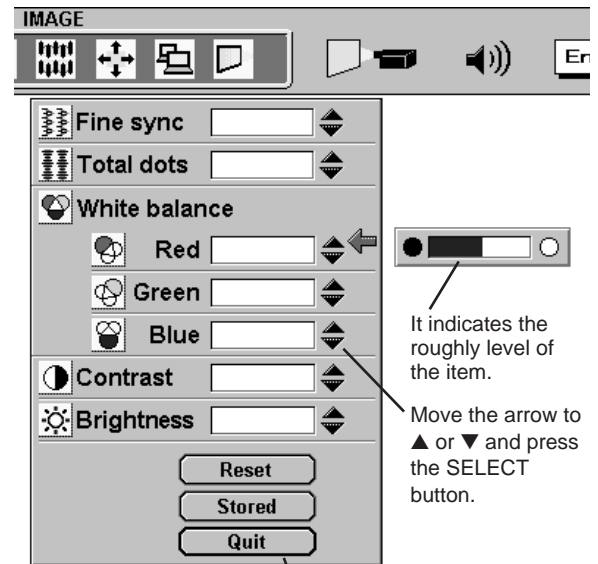

It closes the PICTURE IMAGE ADJUSTMENT Menu.

## Auto Image Function

The Auto Image function is provided to automatically adjust Fine sync., Total dots, and Picture Position for most computers.

- 1 Press the MENU button and the ON-SCREEN MENU will appear. Press the POINT LEFT/RIGHT buttons to select AUTO IMAGE  and press the SELECT button. Another dialog box AUTO IMAGE Menu will appear.
- 2 Move the arrow to an item that you want to adjust by pressing the POINT UP/DOWN button. Change the setting On or Off by pressing the SELECT button.

**Fine sync** Adjust the picture as necessary to eliminate flicker from the display. This item can be adjusted manually. (Refer to page 27.)

**Total Dots** The number of the total dots in one horizontal period. This item can be adjusted manually. (Refer to page 27.)

**Position** Adjustment of the position of the image. This item can be adjusted manually. (Refer to page 29.)

- 3 Move the arrow to "Go!" and press the SELECT button to start the Auto Image function. This adjustment can be executed by pressing AUTO IMAGE button on the Top Control and the Remote Control.

NOTE : The Fine sync., Total dots, and Picture Position of some computers may not be fully adjusted with the Auto Image Function. In that case, manually adjustments is required to make fine image. (Refer to PICTURE IMAGE ADJUSTMENT on page 27 to adjust "Fine sync." or "Total dots" and PICTURE POSITION ADJUSTMENT on page 29 to adjust Picture Position.)

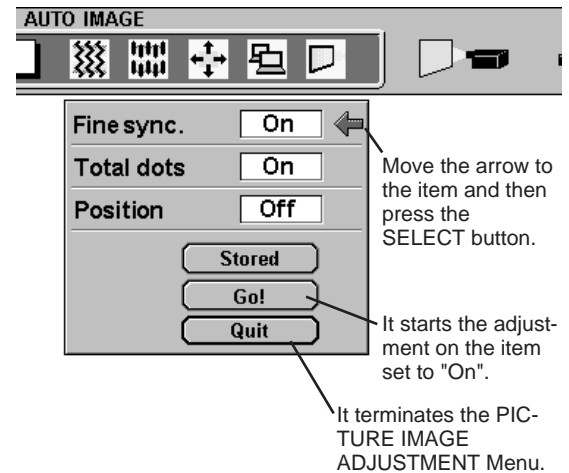

## Normal Function

The normal picture level is preset on this projector by the factory and can be restored anytime by pressing the NORMAL button (located on the Top Control or on the Remote Control Unit). The "Normal" display will be displayed on the screen for a few seconds.

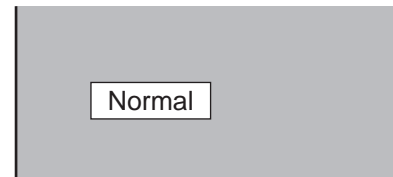

## PICTURE POSITION ADJUSTMENT

The position of the image can be adjusted vertically and horizontally through PICTURE POSITION ADJUSTMENT.

- 1 Press the MENU button and the ON-SCREEN MENU will appear. Press the POINT LEFT/RIGHT buttons to select POSITION  and press the SELECT button. Another dialog box PICTURE POSITION Menu will appear.
- 2 Select the arrow to the direction (described as ←, →, ↑ or ↓) that you want to adjust by pressing the POINT UP/DOWN buttons, and then press the SELECT button.

Each of the keys operates as follow.

**Reset** ..... It recalls the setting data previously set.

**Stored** ..... It stores the setting data in the memory.

**Quit** ..... It closes the PICTURE POSITION Menu.

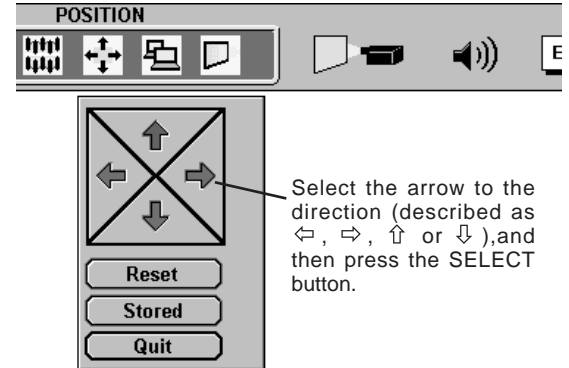

## PICTURE SCREEN ADJUSTMENT

This projector has a picture screen resize function, which enables you to display the image in desirable size.

- 1 Press the MENU button and the ON-SCREEN MENU will appear. Press the POINT LEFT/RIGHT buttons to select SCREEN  and press the SELECT button. Another dialog box PICTURE SCREEN Menu will appear.
- 2 To adjust the image size or pan the image, move the arrow to Digital zoom by pressing POINT UP/DOWN buttons and then press SELECT button. The ON-SCREEN menu and SCREEN ADJUST menu will disappear. The magnifying glass icon and the message "D. Zoom" is displayed to indicate Digital Zoom mode.
- 3 To cancel Digital Zoom mode, press the other buttons except SELECT / FRONT CLICK / POINT buttons. To adjust the image to the screen size (1024 x 768), press NORMAL button.
- 4 To turn the image into its original size select True in the dialog box. When the original image size is larger than the screen size (1024 x 768), this projector becomes Digital Zoom mode automatically.

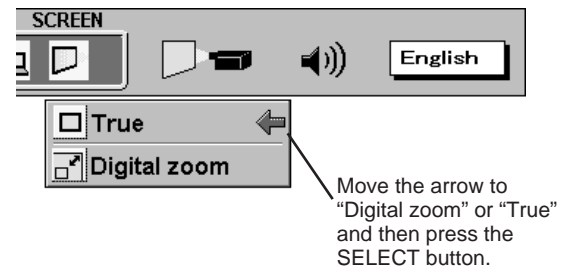

### Expand function

To expand the image size, press SELECT button. The image is magnified by degrees. The maximum size of the projected image in expand mode is 4 times as large as the screen size (1024 x 768).

### Compress function

To compress the image size, press FRONT CLICK button. The size of image is reduced by degrees. The minimum size of the projected image in compress mode is 640 x 480 in VGA, 800 x 600 in SVGA, or 800 x 600 in XGA / SXGA.

### Panning function

To pan the image, press POINT UP/DOWN/LEFT/RIGHT buttons. Panning function can work only when the image is larger than the screen size.

- This projector cannot display in the resolution over than 1240 X 1024. If your computer's screen resolution is higher than 1240 X 1024, reset the resolution to the lower before connecting the projector.
- The image data in other than XGA (1024 x 768) is modified to fit the screen size in the initial mode.
- The normal "Panning Operation" may not function properly if the computer system prepared with the "PC Adjust" is used.

# VIDEO MODE

## SELECTING VIDEO MODE

### Direct Operation

Press the MODE button on the Top Control or the Remote Control Unit. The input source is selected among VIDEO or COMPUTER. The "Video" or "Computer" display will appear on the screen for a few seconds.

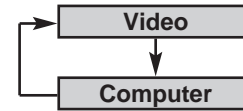

### Menu Operation

Press the MENU button and the ON-SCREEN MENU will appear. Press the POINT LEFT/RIGHT buttons to select Video  and press the SELECT button.



## SELECTING COLOR SYSTEM

- 1 Press the MENU button and the ON-SCREEN MENU will appear. Press the POINT LEFT/RIGHT buttons to select SYSTEM and press the SELECT button. Another dialog box VIDEO SYSTEM Menu will appear. (The display also appears by pressing the SYSTEM button on the Top Control or the Remote Control Unit.)
- 2 Press the POINT DOWN button and a red-arrow icon will appear. Move the arrow to "Auto", and then press the SELECT button.

### Auto

The projector automatically detects the incoming Video system, and adjusts itself to optimize its performance. When the Video System is PAL-M select the system manually.

### PAL / SECAM / NTSC / NTSC4.43 / PAL-M

If the projector cannot reproduce the proper video image, it is required to select a specific broadcast signal format among PAL, SECAM, NTSC, NTSC 4.43, or PAL-M.

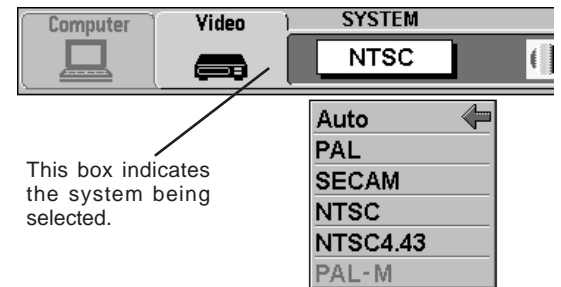

This box indicates the system being selected.

# PICTURE IMAGE ADJUSTMENT

## Adjusting the Picture Image

- 1 Press the MENU button and the ON-SCREEN MENU will appear. Press the POINT LEFT/RIGHT buttons to select IMAGE  and press the SELECT button. Another dialog box PICTURE IMAGE ADJUSTMENT Menu will appear.
- 2 Press the POINT DOWN button and a red-arrow icon will appear. Move the arrow to ▲ or ▼ of the item that you want to change by pressing the POINT UP/DOWN buttons. To increase the value, point the arrow to ▲ and then press the SELECT button. To decrease the value point the arrow to ▼ and then press the SELECT button.

- Color** Point to ▼ to adjust the image lighter, and select ▲ to adjust the image deeper. (From 0 to 63.)
- Tint** Point to ▼ to adjust the color more purple, and select ▲ to adjust more green. (From 0 to 63.)
- Contrast** Point to ▼ to adjust the image lighter, and select ▲ to adjust the image deeper. (From 0 to 63.)
- Brightness** Point to ▼ to adjust the image darker, and select ▲ to adjust the image brighter. (From 0 to 63.)
- Sharpness** Point to ▼ to adjust the image softer, and select ▲ to adjust the image sharper. (From 0 to 63.)

Each of the keys operates as follow.

- Reset** .... It recalls the data previously adjusted.
- Stored** .... It stores the data in the memory.
- Quit** .... It closes the PICTURE IMAGE ADJUSTMENT Menu.

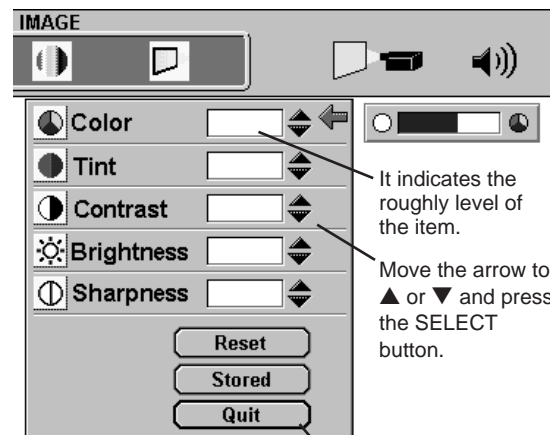

It closes the PICTURE IMAGE ADJUSTMENT Menu.

## Normal Function

The normal picture level is preset on this projector by the factory and can be restored anytime by pressing the NORMAL button (located on the Top Control or on the Remote Control). The "Normal" display will be displayed on the screen for a few seconds.

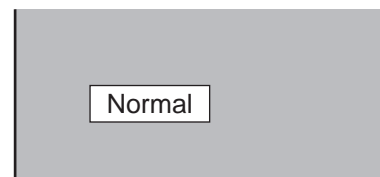

# PICTURE SCREEN ADJUSTMENT

This projector has a picture screen resize function, which enables you to display the image in desirable size.

- 1 Press the MENU button and the ON-SCREEN MENU will appear. Press the POINT LEFT/RIGHT buttons to select SCREEN  and press the SELECT button. Another dialog box PICTURE SCREEN ADJUSTMENT DISPLAY will appear.
- 2 Press the POINT DOWN button and a red-arrow icon will appear. Move the arrow to the screen size that you want to set, and then press the SELECT button.

- Regular** Normal Video Image size with 4 x 3 aspect ratio.
- Wide** It compresses the image vertically to Wider Video Image size with 16 x 9 aspect ratio.

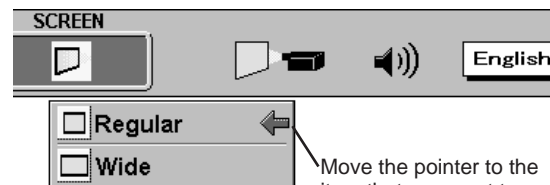

Move the pointer to the item that you want to set, and then press the SELECT button.

## SETTING MENU

- 1 Press the MENU button and the ON-SCREEN MENU will appear. Press the POINT LEFT/RIGHT buttons to select SETTING  and press the SELECT button. Another dialog box SETTING Menu will appear.
- 2 Press the POINT DOWN button and a red-arrow icon will appear. Move the arrow to the item that you want to set, and then press the SELECT button to set it "On" or "Off".

**Blue back** When this function is in the "On" position, this projector will produce a blue image without video noise on the screen when the video source is unplugged or turned off.

**Display** When this function is in the "On" position, the On-Screen Displays always appear when adjustments are made. (The following displays disappear by switching this function "Off.")

- Preparation Display  
(The Number-counting down Display)
- Mode Display
- Volume Display
- Mute Display
- Normal Display

**Ceiling** When this function is in the "On" position, the top / bottom and the left / right reversed picture is provided to project the image from a ceiling mounted projector.

**Rear** When this function is in the "On" position, the left / right reversed picture is provided to project the image to a rear projection screen.

**Split wipe** Turn this function "On" position in the SETTING menu. The picture will change into next one by sliding black image side ways like drawing the black curtains when the input source is turned into another one.

**Lamp age** The Lamp age function is designed to reset the lamp replacement monitor timer. When replacing the lamp, reset the lamp replacement monitor timer by using this function. (Refer to page 35.)

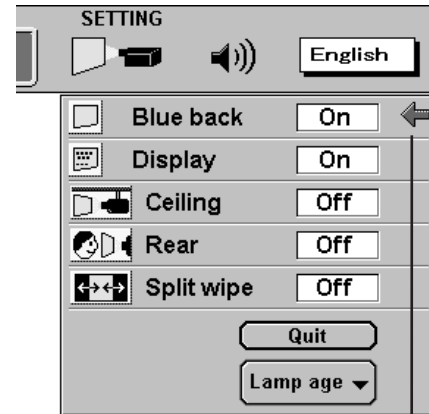

Set the Pointer to the item, and then press the SELECT button.

### Ceiling function

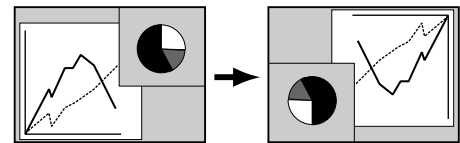

### Rear function

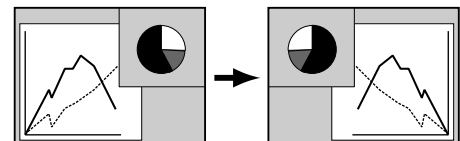

## SELECTING LANGUAGE

The language used in the ON-SCREEN MENU is selectable from among English, German, French, Italian, Spanish and Japanese.

- 1 Press the MENU button and the ON-SCREEN MENU will appear. Press POINT LEFT/RIGHT buttons to select LANGUAGE and press the SELECT button. Another dialog box LANGUAGE Menu will appear.
- 2 Press the POINT DOWN button and a red-arrow icon will appear. Move the arrow to the language that you want to set, and then press the SELECT button.



Move the Pointer to the language that you want to set, and then press the SELECT button.



## OPERATING WIRELESS MOUSE

The Wireless Remote Control Unit is not only able to operate the projector but also usable as a wireless mouse for a PC. POINT buttons and two CLICK buttons are used for wireless mouse operation. Wireless mouse is usable when PC mouse pointer is displayed on the screen. When the menu or indicator of the projector is displayed on the screen instead of the PC mouse pointer, the wireless mouse cannot be used.

### Installation

To use the Wireless Remote Control Unit as the Wireless Mouse for a PC, installation of the mouse driver (not supplied) is required. Make sure that the mouse driver is properly installed in your computer. And make sure that the mouse port of the computer connected to Control Port is activated.

- 1 Connect the mouse port of your computer to the Control Port of the projector with the Control Cable. (Refer to page 12 to 15 for connection.)
- 2 Turn the projector on first, and then turn on your computer. When the computer is switched on first, the Wireless Mouse may not work properly.

Note : When the computer has no mouse port, connect the Serial Port of the computer to Control Port of the projector with the Control Cable for Serial Port.

### Controlling Wireless Mouse

When controlling the pointer of the computer, operate the Wireless Mouse with POINT button, SELECT button, and FRONT CLICK button on the Wireless Remote Control Unit.

#### POINT button

Used to move the pointer. The pointer is moved according to the direction you are pressing.

#### SELECT (REAR CLICK) button

This button has the same function as the left button in a PC mouse.

#### FRONT CLICK

This button has the same function as the right button in a PC mouse. Pressing this button does not affect any operation when in Menu mode.

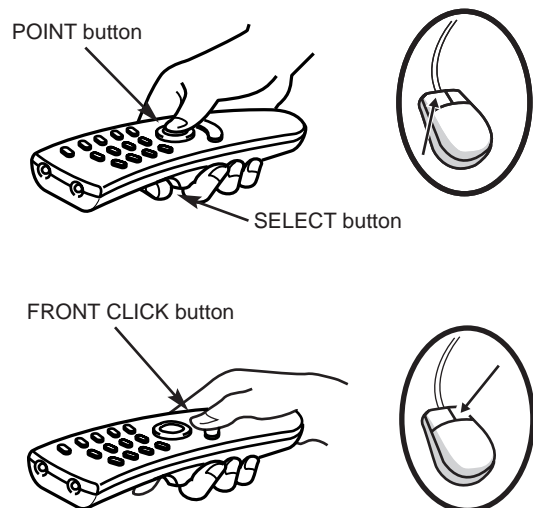

## MAINTENANCE

### TEMPERATURE WARNING INDICATOR

The TEMPERATURE WARNING Indicator flashes red when the internal temperature of the projector exceeds the normal temperature. The Indicator stops to flash when the temperature of the projector become normal. When the TEMPERATURE WARNING Indicator continues to flash, make sure the matters below.

- 1 The Ventilation slots of the projector are blocked. In such an event, reposition the appliance so that the ventilation slots are not obstructed.
- 2 Air filter is clogged with dust particles. Remove dust from the air filter by following instruction in the AIR FILTER CARE AND CLEANING section below.
- 3 If the TEMPERATURE WARNING Indicator remains on after performing the above checks, the Cooling Fans or the Internal Circuits may be malfunctioning. Request service from an authorized dealer or service station.

### AIR FILTER CARE AND CLEANING

The Removable Air Filter prevents dust from accumulating on the surface of the Projection Lens and the Projection Mirror. Should the Air Filter become clogged with dust particles, it will reduce the Cooling Fans' effectiveness and may result in internal heat build up and effect on the life of the projector.

To clean the Air Filter, follow the cleaning procedures below:

- 1 Turn the power off, and disconnect the AC power cord from the AC outlet.
- 2 Remove the Air Filter Cover. Press the cover latch sideway and lift the cover.
- 3 Remove the Air Filter from the Air Filter Cover and clean it with a vacuum cleaner.
- 4 Replace the Air Filter. Make sure that Air Filter Cover is fully inserted.



#### CAUTION

Do not operate the projector with the Air Filter removed. The dust is stuck on the LCD Panel and the Mirror, and it may spoil the fine picture image.

#### RECOMMENDATION

**We recommend to avoid dusty/smoky place for operating the projector. Using in dusty place may cause the picture of poor quality.**

When using under the dusty or smoky conditions, dust may accumulate on the liquid crystal panel and lens inside it, and may resultantly be projected on the screen together with the picture.

When the above symptoms are noticed contact your authorized dealer or service station for the cleaning.

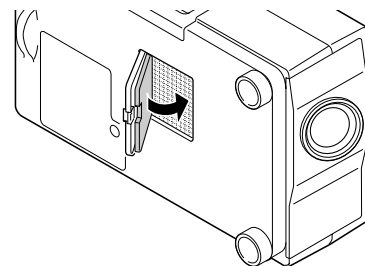
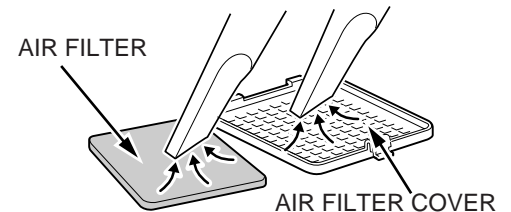
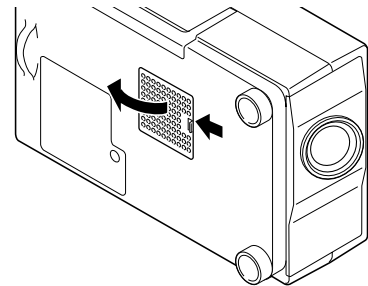

### CLEANING THE PROJECTION LENS

Follow these steps to clean the projection lens:

- 1 Apply a non-abrasive camera lens cleaner to a soft, dry cleaning cloth. Avoid using an excessive amount of cleaner. Abrasive cleaners, solvents or other harsh chemicals might scratch the lens.
- 2 Lightly wipe the cleaning cloth over the lens.
- 3 When you don't use the projector, replace the lens cover.

## LAMP REPLACEMENT Indicator

When the Lamp of this projector draws to an end, the LAMP REPLACEMENT indicator lights yellow. When the image become dark or the color of the image become unnatural, replacement of the Lamp is required.

## LAMP REPLACEMENT



### CAUTION

- For continued safety, replace with a lamp assembly of the same type.
- Allow the projector to cool for at least 45 minutes before you open the lamp cover. The inside of the projector can become very hot.
- Do not drop the lamp assembly or touch the glass bulb! The glass can shatter and may cause injury.

Follow these steps to replace the lamp assembly.

- 1** Turn off the projector and disconnect the AC plug. Allow the projector to cool for at least 45 minutes.
- 2** Remove a screw with a screwdriver and remove the lamp cover.
- 3** Remove 2 screws with a screwdriver and pull out the lamp assembly by grasping the handle.
- 4** Replace the Lamp Assembly and tighten 2 screws. Make sure that the Lamp Assembly is set properly. And replace the Lamp Cover and tighten a screw.
- 5** Connect the AC Power Cord to the projector and turn the projector on.
- 6** Reset the Lamp Replacement Monitor Timer (refer to the section "Lamp Replacement Monitor Timer" below.)

**NOTE :** Do not reset the LAMP REPLACEMENT MONITOR TIMER, when the lamp is not replaced.

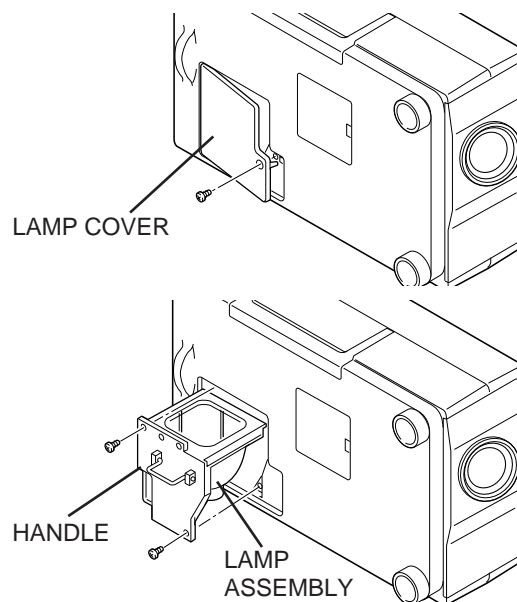

### ORDER REPLACEMENT LAMP

Replacement Lamp can be ordered through your dealer. When ordering the Lamp, give the following information to the dealer.

- Model No. of your projector : LV-7300
- Replacement Lamp Type No. : LV-LP03

## Lamp Replacement Monitor Timer

Be sure to reset the Lamp Replacement Monitor Timer when the Lamp Assembly is replaced. When the Lamp Replacement Monitor Timer is reset, the LAMP REPLACEMENT indicator stops to lighting.

- 1** Turn the projector on, and press the MENU button and the ON-SCREEN MENU will appear. Press the POINT LEFT/RIGHT buttons to select SETTING  and press the SELECT button (refer to the page 32). Another dialog box SETTING MENU Menu will appear.
- 2** Press the POINT DOWN button and a red-arrow icon will appear. Move the arrow to Lamp age, and then press the SELECT button. The message of "Lamp replace monitor Reset?" is displayed.
- 3** Select [Yes] to reset the Timer.

Do not reset the Lamp Replacement Monitor Timer, except after the lamp is replaced.

# TROUBLESHOOTING

Before calling your dealer or service station for assistance, check the matters below once again.

1. Make sure you have connected the projector to your equipment as described in section "CONNECTING THE PROJECTOR" on pages 10 ~ 15.
2. Check cable connection. Verify that all computer, video and power cord are properly connected.
3. Verify that all power is switched on.
4. If the projector still does not produce the image, re-start the computer.
5. If the image still does not appear, unplug the projector from the computer and check the computer monitor's display. The problem may be with your graphics controller rather than with the projector. (When you reconnect the projector, remember to turn the computer and monitor off before you power up the projector. Power the equipment back in order of : Projector and computer.)
6. If the problem still exists, check with following chart.

Problem:	Try these Solution
<b>No power.</b>	<ul style="list-style-type: none"> <li>● Plug the projector into the AC outlet.</li> <li>● Be sure READY Indicator light is On.</li> <li>● Wait 90 seconds after the projector is turned OFF before turning the projector back on.</li> </ul> <p>NOTE : After pressing the power ON-OFF switch to OFF, make sure the projector works as follow.</p> <ol style="list-style-type: none"> <li>1. The LAMP indicator will light and the READY indicator will turn off.</li> <li>2. After one minute, the READY indicator will light green again and the projector may be turned on by pressing the power ON-OFF button.</li> </ol> <ul style="list-style-type: none"> <li>● Check the TEMPERATURE WARNING indicator. If the indicator flashes red, the projector cannot be turned on. (See "TURNING ON/OFF THE PROJECTOR" section on page 21.)</li> <li>● Check the Projection Lamp. (Refer to the page 35.)</li> </ul>
<b>Image is out of focus.</b>	<ul style="list-style-type: none"> <li>● Adjust the focus</li> <li>● Make sure the projection screen is at least 4.6' (1.4m) from the projector.</li> <li>● Check the projection lens to see if it needs cleaning.</li> </ul> <p>NOTE : Moving the projector from a cool temperature location to a warm temperature location may result in moisture condensation on the lens. In such an event, leave the projector OFF and wait until condensation disappears.</p>
<b>Picture is L/R reversed.</b>	<ul style="list-style-type: none"> <li>● Check Ceiling / Rear feature. (See "SETTING" section on page 32.)</li> </ul>
<b>Picture is T/B reversed.</b>	<ul style="list-style-type: none"> <li>● Check Ceiling feature. (See "SETTING" section on page 32.)</li> </ul>
<b>Some displays are not seen during the Operation.</b>	<ul style="list-style-type: none"> <li>● Check Display feature.(See "SETTING" section on page 32.)</li> </ul>
<b>No image.</b>	<ul style="list-style-type: none"> <li>● Check the connection between the computer or video equipment and the projector.</li> <li>● When turning the projector on, it is about 30 seconds to display the image.</li> <li>● Check the system that you select is corresponding with the computer or the video equipment.</li> <li>● Make sure the temperature is not out of the Operating Temperature (5°C ~ 35°C).</li> </ul>
<b>No sound.</b>	<ul style="list-style-type: none"> <li>● Check audio cable connection from audio input source.</li> <li>● Adjust the audio source.</li> <li>● Press VOLUME (+) button.</li> <li>● Press MUTE button.</li> </ul>

Problem:	Try these Solution
<b>Remote Control Unit does not work.</b>	<ul style="list-style-type: none"><li>● Check the batteries.</li><li>● Make sure anything is blocking between the Remote Receiver and the Remote Control Unit.</li><li>● Make sure you are not too far from the projector when using the Remote Control Unit. Maximum operating range is 16.4 feet (5m).</li></ul>
<b>Wireless Mouse function does not work.</b>	<ul style="list-style-type: none"><li>● Check the cable connection between the projector and the computer.</li><li>● Check the mouse setting on your computer.</li><li>● Turn the projector before your turn on the computer.</li></ul>

**WARNING :**

**High voltages are used to operate this projector. Do not attempt to open the cabinet.**

Sanyo Service is easily obtained. If after following all operating instructions, you find that service is necessary, contact the SFS Corporation in Los Angeles, or the store where you purchased the unit. Give the model number and explain the difficulty. We will advise you how to obtain service.

## TECHNICAL SPECIFICATIONS

<b>Projector Type</b>	Multi-media Projector
<b>Dimensions (W x H x D)</b>	8.46" x 4.29" x 12.85" (215mm x 109mm x 326.5mm)
<b>Net Weight</b>	9.48 lbs (4.3 kg)
<b>LCD Panel System</b>	0.9" TFT Active Matrix type, 3 panels
<b>Panel Resolution</b>	1024 x 768 dots
<b>Number of Pixels</b>	2,359,296 (1024 x 768 x 3 panels)
<b>Color System</b>	PAL, SECAM, NTSC, NTSC4.43 and PAL-M
<b>Scanning Frequency</b>	H-sync. 15 ~ 100 KHz, V-sync. 50 ~ 100 Hz
<b>Projection Image size (Diagonal)</b>	Adjustable from 30" to 300"
<b>Horizontal Resolution</b>	800 TV lines
<b>Projection Lens</b>	F 1.7 ~ 2.0 lens with f 33.2mm ~ 43.1mm Motor zoom and focus
<b>Throw Distance</b>	4.6' (1.4m) ~ 35.4' (10.8m)
<b>Projection Lamp</b>	120 W
<b>AV Input Jacks</b>	RCA Type x 1 (Video, Audio R and L) and DIN 4 pin (S-Video) x 1
<b>Computer Input Jacks</b>	(VGA) HDB 15 Terminal x 1
<b>Control Port Jack</b>	Multi-pole 12 pin (Control Port) x 1
<b>Serial Port</b>	Serial Port DIN 8 pin x 1
<b>Monitor Output Jack</b>	(VGA) HDB 15 Terminal x 1
<b>Computer Audio Input Jack</b>	Mini Jack (stereo)
<b>Audio Output Jack</b>	Mini Jack (stereo)
<b>Internal Audio Amp</b>	1W RMS (Monaural)
<b>Built-in Speaker</b>	1 speaker, 1.57" x 1.18" (40mm x 30mm)
<b>Feet Adjustment</b>	0° to 2°
<b>Voltage</b>	AC 100 ~ 120 V, 50 / 60 Hz
<b>Power Consumption</b>	2.2 A (Max. Ampere)
<b>Operating Temperature</b>	41 °F ~ 95 °F (5 °C ~ 35 °C)
<b>Storage Temperature</b>	14 °F ~ 140 °F (-10 °C ~ 60 °C)
<b>Remote Control Transmitter</b>	Power Source : AA Type x 2 Operating Range : 16.4' (5m) / ±30° Dimensions : 2.2" x 1.4" x 7.6" (56mm x 35mm x 193mm) Net Weight : 0.23 lbs (105 g) (including batteries)
<b>Accessories</b>	Owner's Manual AC Power Cord Remote Control Transmitter and Batteries VGA Cable Control Cables for PS/2 port Lens Cover Carrying Bag

- The specifications are subject to change without notice.



This symbol on the nameplate means the product is Listed by Underwriters Laboratories Inc. It is designed and manufactured to meet rigid U.L. safety standards against risk of fire, casualty and electrical hazards.

---

## OPTIONAL PARTS

The parts listed below are optionally supplied. When ordering those parts, give the name and the Type No. of it to the sales dealer.

- Control Cable for Serial Port      Type No. : POA-MC12SRL
- Control Cable for ADB Port        Type No. : POA-MC12MAC
- MAC Adapter                            Type No. : POA-MACAP