



MP8660 Multimedia Projector Operator's Guide

MP8660 Appareil de projection multimédia Guide de l'opérateur

MP8660 Multimedia-Projektor Bedienerhandbuch

Portatil Multimedia MP8660 Manual del usuario

MP8660 Proiettore multimedia Manuale dell'operatore

MP8660 Multimediaprojektor Brukerhåndbok

MP8660 Multimedia Projector Gebruiksaanwijzing

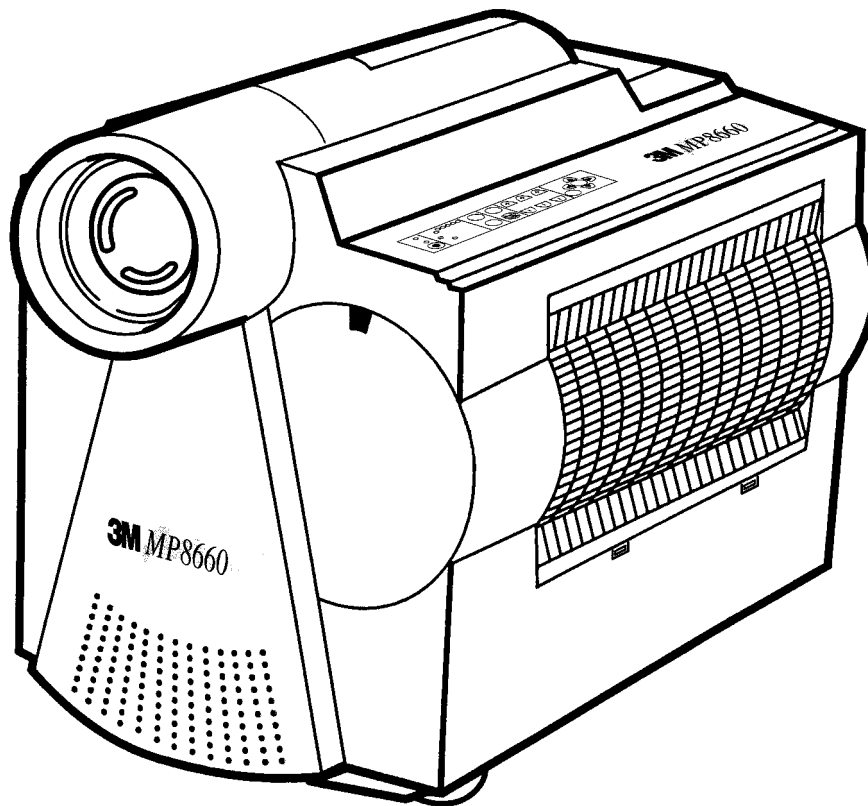



Safeguards	1
Warranty	2
Section 1: Unpack	3
1-1. Contents of Shipping Box	3
1-2. Keep Your Packing Materials	3
1-3. What's Next?	3
Section 2: Product Description	4
2-1. Machine Characteristics	4
2-2. Parts Identification List	4
Section 3: Set Up	5
3-1. Cable Connections	5
3-2. Projector Set Up	9
3-3. Now What?	10
Section 4: Operating the Projector	11
4-1. Turning On the Projector	11
4-2. Projector Control Panel	12
4-3. On-Screen Menus	13
4-4. Adjusting Image Size and Focus	16
4-5. Adjusting the Volume	16
4-6. Video System	16
4-7. MAC Mode (RGB only)	16
4-8. Menu Languages	16
4-9. Turning Off the Projector	16
Section 5: Remote Control	17
5-1. How to Operate the Remote Control	17
Section 6: Lamp Information	19
6-1. Metal Halide Projector Lamp	19
6-2. MP8660 Lamp Replacement	20
Section 7: Maintenance	21
7-1. Cleaning	21
Section 8: Troubleshooting	23
8-1. Service Information	24
Section 9: Accessories	25
9-1. MP8660 Multimedia Projector Accessories	25
Appendix: Technical Information	A-1





INTENDED USE



Before operating the machine, please read the entire manual thoroughly. The 3M™ Multimedia Projector MP8660 was designed, built and tested for use indoors, using 3M™ brand lamps and nominal local voltages. The use of other replacement lamps, outdoor operation or different voltages has not been tested and could damage the projector or peripheral equipment and/or create a potentially unsafe operating condition.

IMPORTANT SAFEGUARDS

1. Read and understand all instructions before using. Pay particular attention to areas where this symbol  is shown.

 **WARNING** – Indicates a potentially hazardous situation which, if not avoided, could result in death or serious injury.

 **Caution** – Indicates a potentially hazardous situation which, if not avoided, could result in minor or moderate injury. It may also be used to alert against unsafe practices.

2. Close supervision is necessary when any appliance is used by or near children. Do not leave appliance unattended while in use.
3. Never look directly into the projector lens when the lamp is on. The metal halide lamp produces a strong light which could damage your eyesight.
-  4. Care must be taken as burns can occur from touching hot parts.
5. Do not operate appliance with a damaged cord or if the appliance has been dropped or damaged — until it has been examined by a qualified service technician.
-  6. Position the cord so that it will not be tripped over, pulled or contact hot surfaces.
7. If an extension cord is necessary, a cord with a current rating at least equal to that of the appliance should be used. Cords rated for less amperage than the appliance may overheat.
8. Always unplug appliance from electrical outlet before cleaning and servicing and when not in use. Grasp plug and pull to disconnect.
9. To reduce the risk of electric shock, do not immerse this appliance in water or other liquids.
10. To reduce the risk of electric shock, do not disassemble this appliance, but take it to a qualified technician when service or repair work is required. Incorrect reassembly can cause electric shock when the appliance is subsequently used.
11. The use of an accessory attachment not recommended by the manufacturer may cause a risk of fire, electric shock, or injury to persons.
12. Connect this appliance to a grounded outlet.
-  13. This unit is equipped with optical lenses and should not be exposed to direct sunlight.
14. Keep ventilation openings free of any obstructions.
15. Always remove the lens cap when the projection lamp is on.
16. The projection lamp contains mercury. Always dispose of it in a proper manner according to local regulations.

SAVE THESE INSTRUCTIONS

The information contained in this manual will help you operate and maintain your 3M MP8660 Multimedia Projector.



THANK YOU FOR CHOOSING 3M

Thank you for choosing 3M multimedia projection equipment. This product has been produced in accordance with 3M's highest quality and safety standards to ensure smooth and troublefree use in the years to come.

For optimum performance, please follow the operating instructions carefully. We hope you will enjoy using this high performance product in your meetings, presentations and training sessions.

LIMITED WARRANTY

3M warrants this product against any defects in material and workmanship, under normal use and storage, for a period of one year from date of purchase. Proof of purchase date will be required with any warranty claim. In the event this product is found to be defective within the warranty period, 3M's only obligation and your exclusive remedy shall be replacement of any defective parts (labor included).

To obtain warranty service, immediately notify the dealer from which you purchased the product of any defects.

LIMITATION OF LIABILITY

THE FOREGOING WARRANTY IS MADE IN LIEU OF ALL OTHER WARRANTIES, EXPRESSED OR IMPLIED, AND 3M SPECIFICALLY DISCLAIMS ANY IMPLIED WARRANTY OF MERCHANTABILITY AND FITNESS. 3M SHALL NOT BE LIABLE FOR ANY DAMAGES, DIRECT, CONSEQUENTIAL, OR INCIDENTAL, ARISING OUT OF THE USE OR INABILITY TO USE THIS PRODUCT.

Important: The above warranty shall be void if the customer fails to operate product in accordance with 3M's written instructions. This warranty gives you specific legal rights and you may have other rights which vary from state to state.

FCC STATEMENT – CLASS A: This equipment generates, uses and can radiate radio frequency energy, and if not installed and used in accordance with the instruction manual may cause interference to radio communications. It has been tested and found to comply with the limits for a Class "A" computing device pursuant to Subpart B of Part 15 of the FCC Rules, which are designed to provide reasonable protection against such interference when operated in a commercial environment. Operation of this equipment in a residential area is likely to cause interference in which case the user at his/her own expense will be required to take whatever measures may be required to correct the interference.

EEC STATEMENT: This machine was tested against the 89/336/EEC (European Economic Community) for EMC (Electro Magnetic Compatibility) and fulfills these requirements.

Video signal cables: Single shielded coaxial cables (FCC shield cable) must be used and the outer shield must be connected to the ground. If normal coaxial cables are used, the cables must be enclosed in metal pipes or in a similar way to reduce the interference noise radiation.

Video inputs: The input signal amplitude must not exceed the specified level. See Section 9.

IBM is a registered trademark of **International Business Machines Corporation**. **Apple Macintosh** and **Apple Powerbook** are registered trademarks of **Apple® Computer, Inc.** Microsoft and Windows 95 are registered trademarks, and Windows and Windows for Work Groups are trademarks of the Microsoft Corporation. All other products are trademarks or registered trademarks of their respective companies.



1-1. Contents of Shipping Box

The 3M Multimedia Projector MP8660 is shipped with the necessary cables required for standard VCR, PC, Apple Macintosh or laptop computer connections. Carefully unpack and verify that you have all of the items shown below in Figure 1-1.

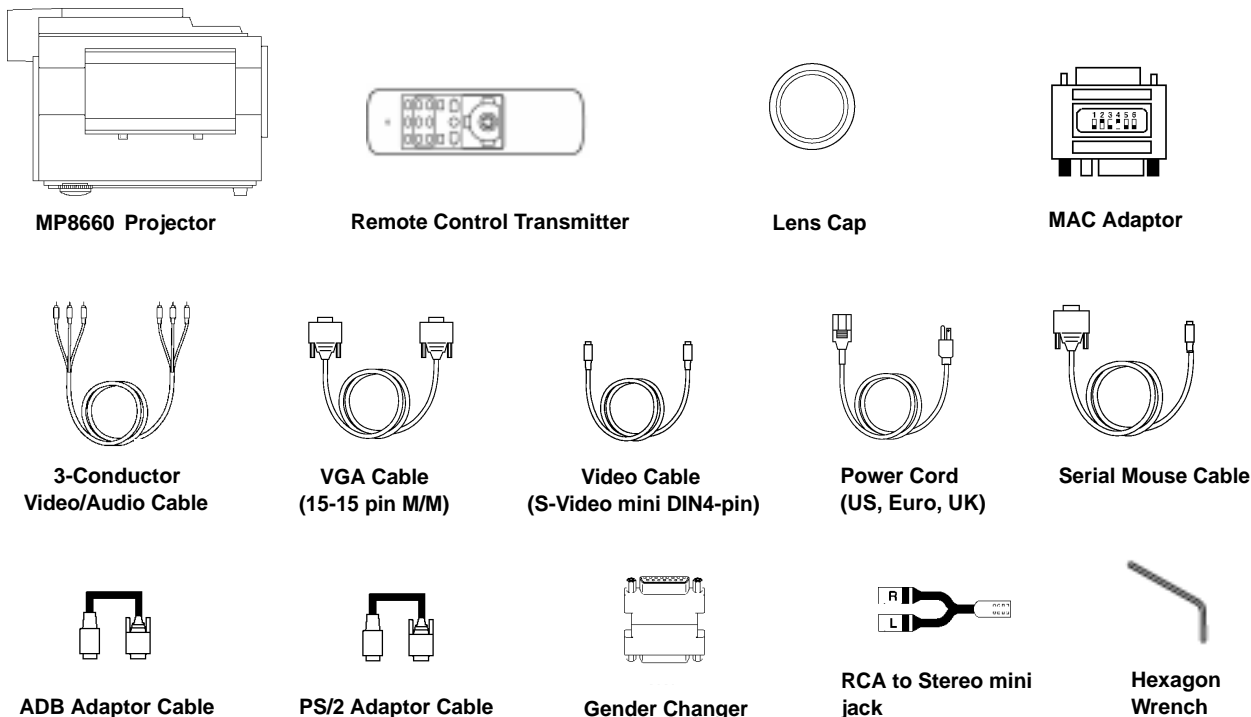

Figure 1-1. Inventory of Shipping Box

The following items are optional and are not packed with the projector:

- ™ RS-232 Control Cable
- ™ VGA MAC Monitor Adaptor
- ™ SVGA MAC Monitor Adaptor

1-2. Keep Your Packing Materials

Save the shipping box and packing materials in the event the MP8660 should require shipping to a 3M Service Center for repair. Check the projection lens, it should be fully retracted to prevent damage during shipping.

Note

The projection lens must be completely retracted to protect it during shipping. If the AUTO RETRACT feature has been disabled, the lens will not retract automatically. Press the ZOOM arrow and FOCUS arrow to retract the lens manually.

1-3. What's Next?

After you have unpacked the MP8660 system and identified all the parts, you are ready to set up the projector.

Take a few minutes to review Section 2 to familiarize yourself with the MP8660 machine characteristics and then turn to Section 3 to set up the projector.

Section 2: Product Description

2-1. Machine Characteristics

The 3M Multimedia Projector MP8660 integrates metal halide lamp and dichroic optics display technology into a single unit. It accepts input from two different computer sources and two video/audio sources and projects a bright super crisp image.

The MP8660 Multimedia Projector offers the following features:

- | | |
|--|---|
| Easy to set up and use | Front & rear IR receiver |
| User replaceable lamp | Full function operator panel |
| Metal halide projection lamp | Back lighting – remote control keypad |
| High brightness lamp output (see note) | Stereo speakers (2 x 1.5 Watt) |
| 800 x 600 SVGA/VGA (NTSC, PAL, SECAM) | Horizontal/vertical image inverting function (rear projection or ceiling mount) |
| XGA compatible (60/70/72/75 Hz) | Horizontal/vertical image position control |
| RGBS compatible | On-screen menus to adjust projected image |
| Advanced scaling of data/video | Menus – English, French, Spanish or German |
| RS-232 control | Fixed keystone correction |
| Serial, PS/2 or ADB mouse emulation | Electronic LCD Panel Alignment |
| Ability to display 16.7 million colors | |
| Two computer input connections | |
| Two video input connections | |
| Power zoom | |
| Power focus | |
| Automatic projection lens retraction | |
| Full function remote control | |

Note

The MP8660 is one of the brightest projectors in the marketplace. The brightness of your machine will vary depending on the ambient room conditions and contrast/brightness settings.

2-2. Parts Identification List

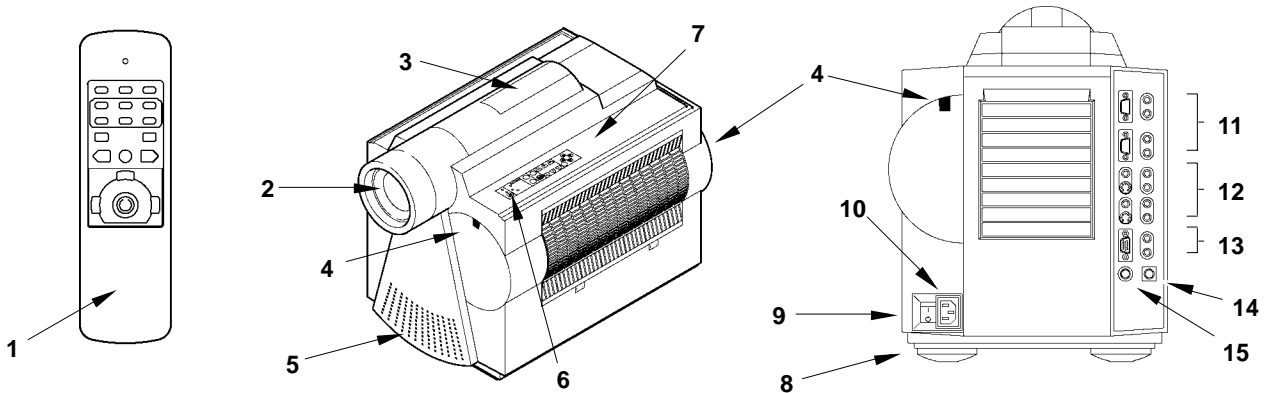

Figure 2-1. Identifying MP8660 Parts

- | | |
|---|--|
| 1. Remote Control Transmitter | 8. Height Adjustment Feet |
| 2. Lens | 9. Main Power Switch |
| 3. Carry Handle | 10. Power Cord Connection |
| 4. Remote Control Sensor (front & rear) | 11. Computer video (RGB) Input Terminals |
| 5. Stereo Speakers (2 x 1.5 Watt) | a. RGB1/RGB2 (D sub 15-pin) |
| 6. Indicator Lights (Change Lamp, Cover, Fan, Temp, Lamp) | b. Audio-L/Audio-R (RCA Jack) |
| 7. Control Panel Keypad | 12. Video/Audio Input Terminals |
| a. Lamp Reset, Special, Reset | a. S-Video1/S-Video2 (Mini DIN 4-pin) |
| b. Standby/On Switch | b. Video1/Video2 (RCA Jack) |
| c. Input Selection | c. Audio-L/Audio-R (RCA Jack) |
| d. Mute, Blank, Zoom, Focus, Volume | 13. RGB/Audio L/R (monitor output) |
| e. Menu Selection/Control | 14. Mouse I/F |
| | 15. Serial I/F (RS-232) |



3-1. Cable Connections

It only takes a few minutes to connect the 3M Multimedia Projector MP8660 to your computer, VCR or other video device (Figure 3-1). Always disconnect the projector power before connecting any cables.

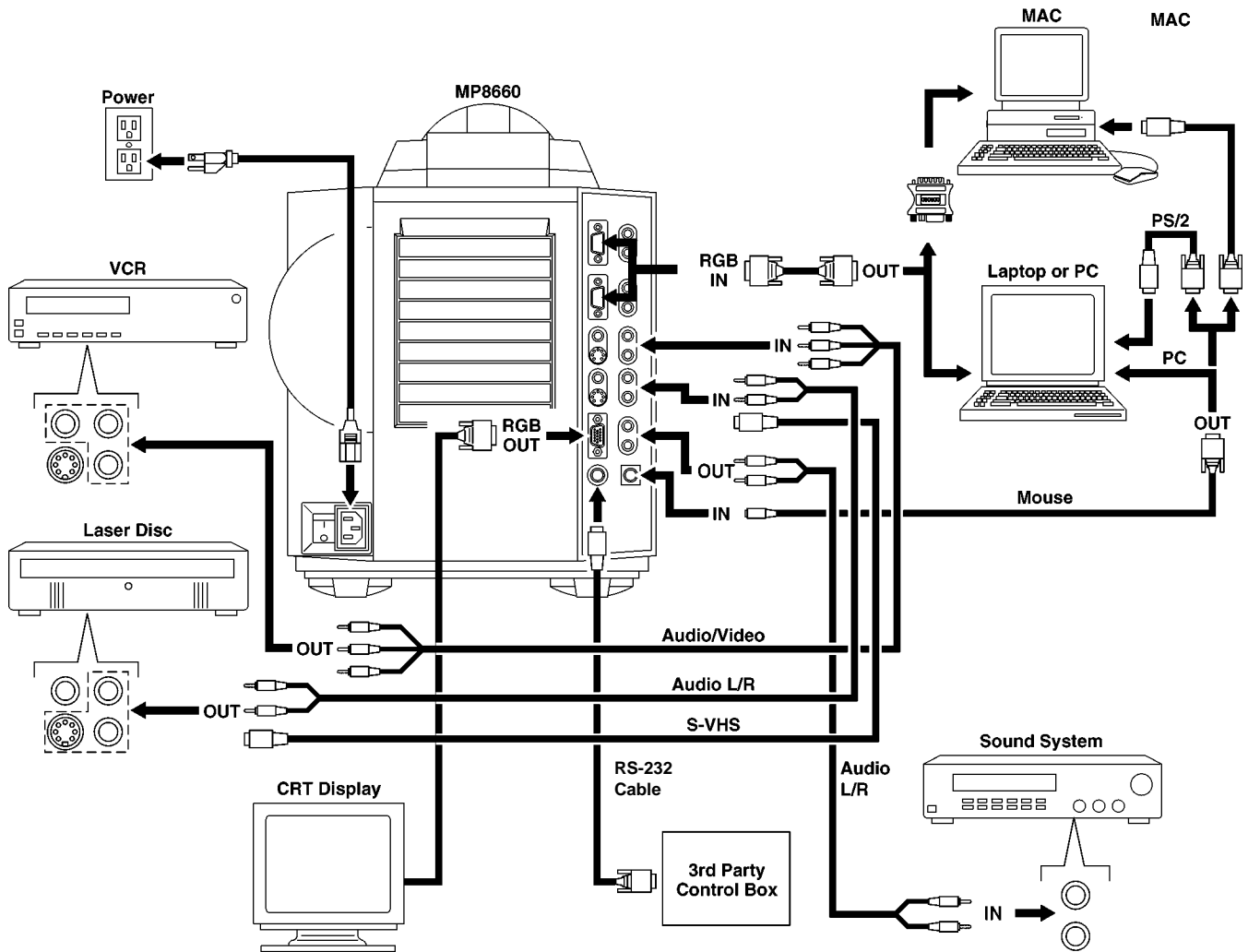

Figure 3-1. Typical Cable Configuration

Terminal Connection Panel

The input connection panel (Figure 3-2) is located on the back of the projector.

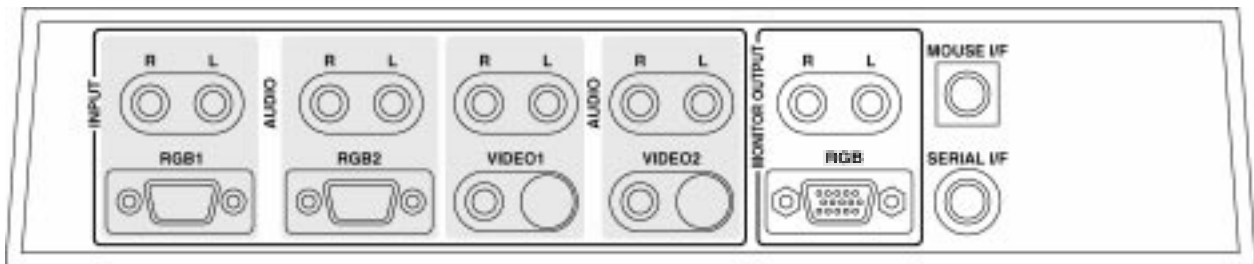



Figure 3-2. Input Connection Panel

Power Connection

 Caution
To prevent damage to equipment, all power to the MP8660 and input sources must be turned OFF during cable hook up.

The power cord (Figure 3-3) is detachable from the projector and has different connection plugs on each end. Plug the female end into the power cord terminal on the projector and the male end into a properly grounded electrical outlet.

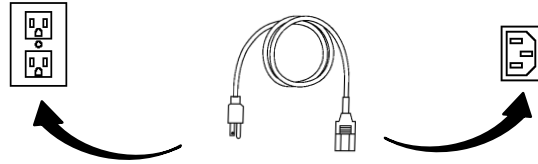

Figure 3-3. Connecting the Power Cord

Computer (RGB) Input Connection

There are two input jacks available for connecting either desktop or laptop computers. Find the cable that fits your computer type. The VGA cable (Figure 3-4) fits IBM™ PC and compatible VGA video systems, and the MAC Adaptor (Figure 3-5) fits on the end of the VGA cable and adapts it to fit Apple™ Macintosh computers and Apple™ Powerbook laptop computers.

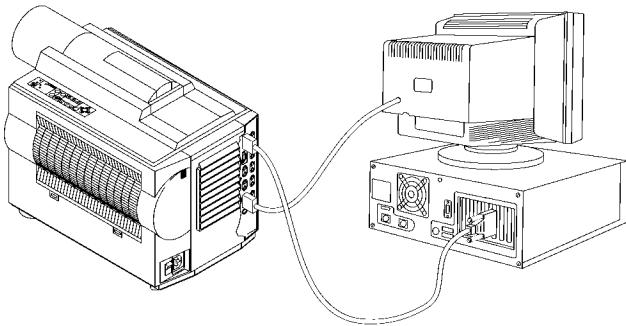

Figure 3-4. IBM Compatible Computer

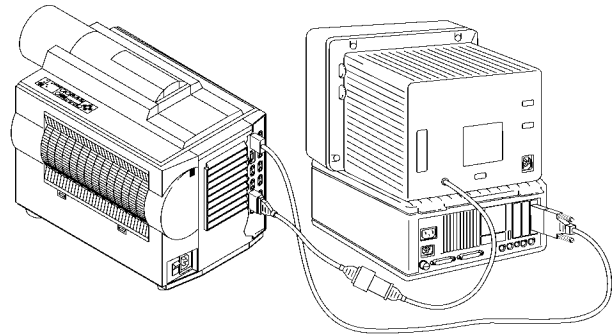

Figure 3-5. Apple Macintosh Computer

MAC Adapter Switch Settings

The MAC Adaptor has six switches which must be set for the resolution output of the monitor. Set all switches to OFF position, then set switches to ON according to the table below:

Resolution	Switch ON
640 x 480 (67 Hz)	1, 2
640 x 480 (60 Hz) 800 x 600	3, 4
832 x 624	2, 4
1024 x 768	2, 3
17 inch Multiscan	1, 2, 5

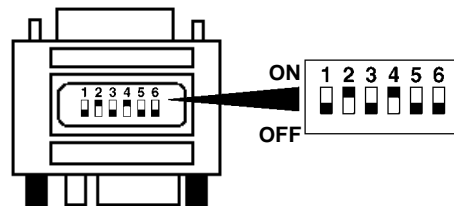

Figure 3-6. MAC Adaptor Switches

Monitor Loop-Through For IBM Compatible Computers

This connection applies to RGB output only. Video input signals are not compatible with the monitor output connection.

- a Power down the computer
- b Connect the monitor cable to the RGB output port on the projector.
- c Turn the power on.
- d Select the appropriate RGB input mode on the projector.

Monitor Loop-Through For MAC Computers (non VGA compatible monitor only)

For Apple Macintosh computers, the gender changer (78-8118-3394-2) and optional SVGA adaptor (78-8118-3236-5) or VGA adaptor (78-8118-3237-3) plus an additional VGA cable (78-8118-3235-7) is required to complete the connection. See Section 9 for ordering information.

- a Power down the computer.
- b Connect the VGA cable to the projector monitor output port.
- c Connect the SVGA or VGA MAC monitor adaptor to the VGA cable.
- d Connect the gender changer to the adaptor.
- e Connect the MAC monitor cable to the gender sender.
- f Turn power on.

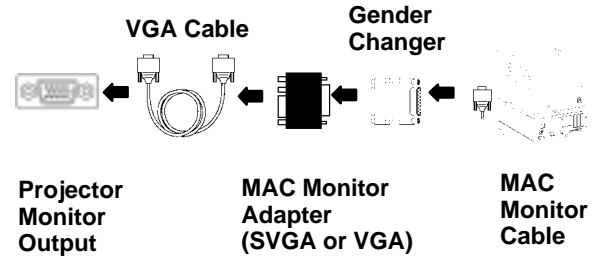

Figure 3-7. MAC Monitor Loop-Through

S-Video Connection

Some video devices can generate S-VHS video, or S-Video (Y/C). The MP8660 will accept this signal through the S-VIDEO1 or S-VIDEO2 connectors. The S-VHS cable has identical round four-pin connectors on either end (Figure 3-8). Connect one end to the S-Video jack on the input source device, and the other end to the S-VIDEO1 or S-VIDEO2 terminal on the MP8660. Remember to connect the audio cables for sound output. S-video input signals have priority over RCA jack input.

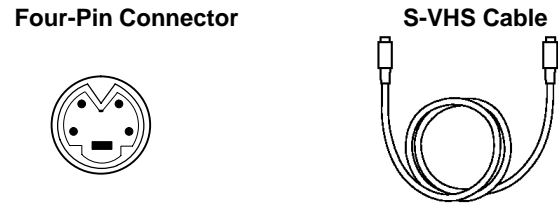

Figure 3-8. S-Video Input

Video/Audio Connection

Find the small, circular connector on your camcorder, laserdisc player, VCR, or other video source marked VIDEO OUT, TO MONITOR, or something similar.

Use the 3-conductor video/audio cable and insert the video (yellow) connector into the video output jack of your video source device. Connect the other end into the MP8660 VIDEO1 or VIDEO2 connector.

Next, find the AUDIO OUT terminals on your VCR or other audio source. Insert the left and right audio cable connectors (Figure 3-9) to the input source. Connect the other end to the AUDIO-L and AUDIO-R terminals on the MP8660.

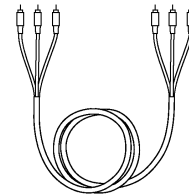

Figure 3-9. 3-Conductor Video/Audio Input Cable

If you are giving a multimedia presentation with stereo sound, you may want to consider connecting the MP8660 audio-out L/R jacks to a high-quality stereo system. When external speakers are connected, the internal speakers are disabled.

Mouse Interface Cable Connection

The MP8660 remote control transmitter can be used to control the mouse button functions on your personal computer or Apple Macintosh type computer. This connection requires the serial mouse cable and for PS/2 or MAC computers, a special cable adapter.

Note

Operating the mouse functions through the MP8660 remote control may disable the internal pointing device (IPD) on your computer. It is recommended that you review the operating instructions for your computer before connecting an external device of any kind.

Serial Mouse Cable (PC Computer):

Install the serial mouse cable (Figure 3-10) to connect the serial mouse port on your computer to the mouse I/F terminal on the MP8660 projector. *A serial mouse driver must be loaded on your PC computer for this function to operate properly.* It is best to reference the operating instructions for your computer before connecting an external mouse device of any kind.

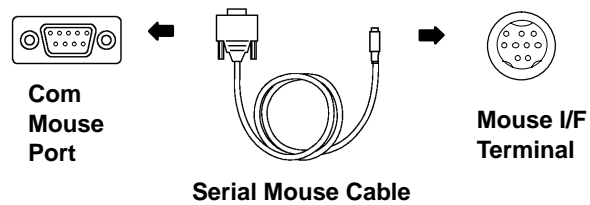

Figure 3-10. PC Serial Mouse Cable

To load a serial mouse driver on a computer using Microsoft™ Windows or Windows for Workgroups, go into the Windows Setup function. From **Program Manager** click **Main**; then click **Windows Setup**; (note the current mouse driver that is loaded); click **Options**; click **Change System Settings**. Choose **Mouse**. You will need to have the **Serial Mouse on Comm 1** driver loaded. It will most likely be listed as **Serial or Bus Mouse**. Click **OK** to apply the serial mouse driver. Restart Windows if prompted.

Hint: To load a serial mouse driver on a computer using Microsoft™ Windows™ 95, go into the Control Panel. Click **Start**; select **Settings**; select **Control Panel**. Click on **Mouse**; select the **General** tab; (note the current mouse driver that is loaded); select **Change**; select **Show all compatible devices**; (note the current Manufacturer and Model); select **Standard Mouse Type** for Manufacturer; select **Standard Serial Mouse**. Click **OK** to apply the serial mouse driver. Restart windows when prompted.

PS/2 Mouse Adapter Cable (PC Computer):

Install a PS/2 mouse adapter cable (Figure 3-11) to the serial mouse cable to complete the mouse emulation connection for a PS/2 computer.

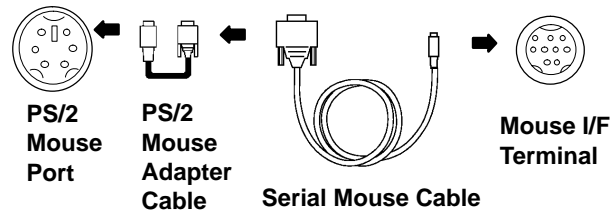

Figure 3-11. PS/2 Mouse Adapter Cable

ADB Mouse Adapter Cable (MAC Computer):

Install an ADB mouse adapter cable (Figure 3-12) to the serial mouse cable to complete the mouse emulation connection for a MAC computer.

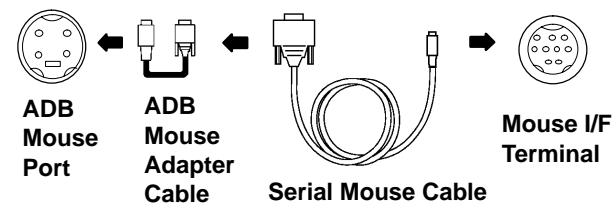

Figure 3-12. ADB Mouse Adapter Cable

Control Cable (3rd Party Control Box):

Install the RS-232 control cable (Figure 3-13) from the RS-232 port on the computer to the RS-232 terminal on the projector. This connect will provide the communication between the MP8660 and a 3rd Party Control Box. See the Technical Appendix for the valid Serial Interface Command Codes which will control projector functions.



Figure 3-13. RS-232 Control Cable

3-2. Projector Set Up

Ambient Light

Whenever you have a choice, light the room from the rear, away from the projection screen. The MP8660 has a brightness adjustment to achieve the best image possible.

Distance to Viewing Screen

The MP8660 can be used in a small or large meeting room to project a quality image from 51 cm (20 inches) to 762 cm (300 inches) in size. The distance between the projector and the viewing screen and the zoom/lens setting (minimum to maximum) will determine the size of the projected image. Refer to the Technical Appendix to determine how far away from the viewing screen you need to place the projector to fill the screen with the projected image.

Remember that increasing the projector-to-screen distance also decreases the image's brightness dramatically. In other words, as the image grows larger, it also grows dimmer.

For best results, experiment to find the right combination of projector-to-screen distance and room lighting.

Carrying Handle

The MP8660 has a carrying handle that folds into the top of the projector housing. To raise the handle, push up on the back end of the handle (Figure 3-14) and then lift upward.

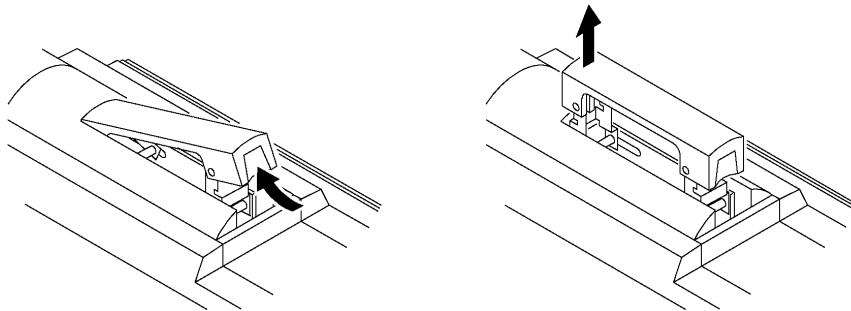

Figure 3-14. Unfolding Handle

Ceiling Mount Considerations

An optional ceiling mount bracket (Figure 3-15) is required to install the MP8660 from the ceiling. For this type of installation, the image must be vertically and horizontally inverted.

See section 9-1 to order the ceiling mount kit.

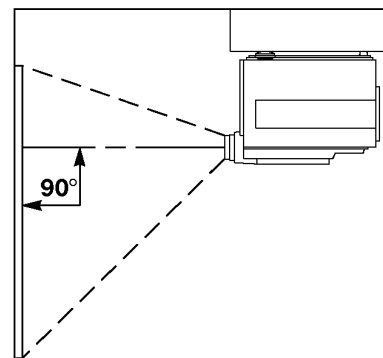

Figure 3-15. Optional Ceiling Bracket

Adjusting the Projector Elevation

The elevation can be adjusted by turning the foot adjuster (Figure 3-16) to raise or lower the angle of the projector.

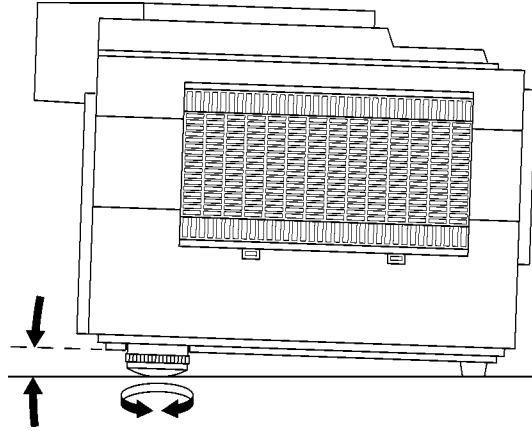

Figure 3-16. Foot Adjusters

Note

Both adjusting feet must be raised or lowered the same amount to project a level image on the viewing screen. The elevation can be adjusted from approximately 0.4 to 7.2 degrees.

Rear Projection

A semi-transparent screen (Figure 3-17) can be used to project an image and view it from the backside of the viewing screen. For this type of installation, the image must be horizontally inverted.

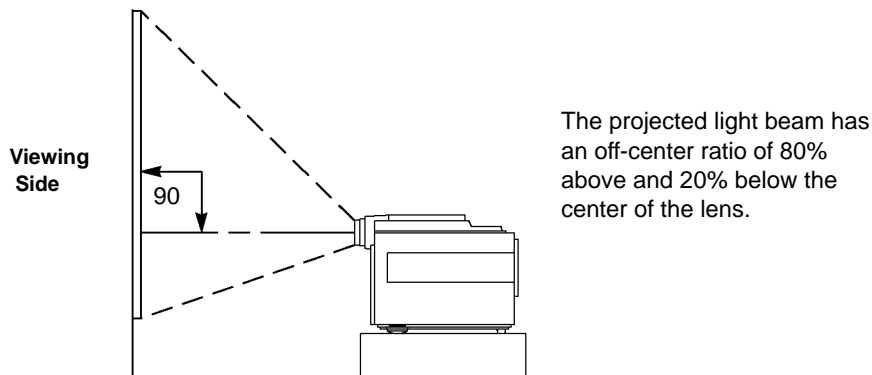

Figure 3-17. Rear Projection Viewing

3-3. Now What?

Your MP8660 is now connected and ready to power on. Turn to Section 4 for details on operating the projector.



4-1. Turning On the Projector

Read the Important Safeguards before operating the MP8660 projector.

Refer to Section 3 to make all cable connections. When the input cables and power cords are connected, turn on the projector power then the power to the input sources.

 Caution
Allow a projector that has been stored in a cold environment to warm up to operating temperature 0 C to 35 C (32 F to 95 F) before applying power.

Step 1: Turn Projector Power On.

Turn on the main power switch located on the backside of the projector.

| = ON
O = OFF

Step 2: Remove Lens Cap. Remove the lens cap from the projection lens before energizing the lamp.

Step 3: Press STANDBY/ON button.

The *Power* indicator (Figure 4-1) will turn from amber to green to indicate that the projector is in the operating mode.

Note

When a metal halide lamp is first turned on, it is normal for it to make noise as the gas inside the bulb heats to the proper operating temperature.

Step 4: Power up input sources.

Step 5: Select Input Source.

Press the RGB or VIDEO button to select the desired video or computer source. Press again to select the next input source.

RGB1 ⇒ RGB2 ⇒ RGB1
Video1 ⇒ Video2 ⇒ Video1

Step 6: Adjust Image Size

Press and hold the ZOOM +/- button to adjust image size.

Step 7: Adjust Image sharpness

Press and hold the FOCUS +/- button to adjust sharpness.

Step 8: Adjust Volume

Press and hold VOLUME +/- button to increase or decrease internal or external speaker volume.

Step 9: Navigate Menus.

Press the MENU button and SELECT arrows to view menus and select options.

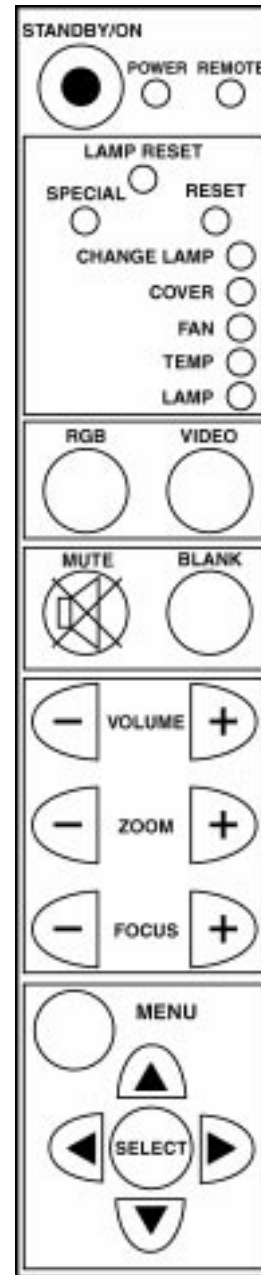

Figure 4-1. Projector Control Panel

4-2. Projector Control Panel

Indicator Lamps

The projector control panel (Figure 4-1) has several indicator lamps that illuminate to indicate normal operation and when alarm conditions have been detected. Refer to the chart below for details.

Normal Operation Indicator Lamps				
LED	Status of the Unit			
	Main Power: ON	STANDBY/ON: ON Lamp: OFF	STANDBY/ON: ON Lamp: ON	Receiving Remote Control Signal
POWER	Amber	GREEN	GREEN	
REMOTE	OFF	OFF	OFF	Blinking GREEN
CHANGE LAMP	OFF	OFF	OFF	
COVER	OFF	OFF	OFF	
FAN	OFF	OFF	OFF	
TEMP	OFF	OFF	OFF	
LAMP	OFF	Blinking GREEN	GREEN	

Alarm Indicator Lamps					
LED	Status of the Unit				
	Lamp Failure	Temperature Failure	Right Panel Open	Lamp Life Over (>1000 hours)	Fan Failure
POWER	Amber	Amber	Amber	GREEN	Amber
REMOTE					
CHANGE LAMP				RED	
COVER			RED		
FAN					RED
TEMP		RED			
LAMP	RED				

Special/Reset Buttons

Press the SPECIAL button (Figure 4-1) to view the firmware revision level and the current input data (RGB or Video) for the projector. The TEST SCREEN (Figure 4-2) will display. If no input is detected, the message “NO INPUT” will display.

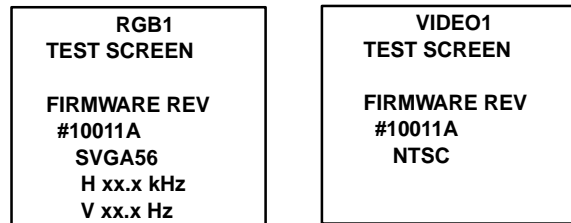

Figure 4-2. Test Screens

Press the RESET button (Figure 4-1) to reset all projector settings to the factory default. Press the down arrow to change to YES (Figure 4-3) and press the SELECT button. Press the SELECT button again to activate the settings and the message “RESET COMPLETE” will display.

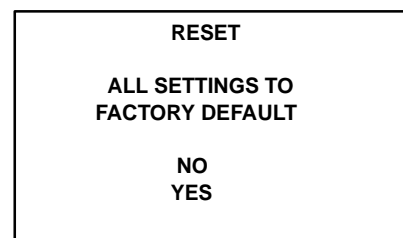







Figure 4-3. Reset Screen

4-3. On-Screen Menus

Use the projector control panel (Figure 4-1) or remote control keypad (Figure 5-2) to navigate the menus.

Press the MENU button  on the projector control panel or remote control keypad to display the Main Menu. Press the up/down arrows  or move the mini-joy stick up/down to move vertically within a menu, sub-menu or adjustment screen.

Press the left/right select arrows  on the projector control panel or move the mini-joy stick left/right to move horizontally within a sub-menu or adjustment screen.

Press the SELECT button  on the control panel or the SELECT (L) button  on the remote to enter a selected adjustment screen.

SETUP SUB-MENUS (RGB, VIDEO)

Press the MENU button to display the Main Menu. The SETUP Sub-Menu will be highlighted. Press the up/down arrow on the control panel or move the mini-joy stick up/down to select the desired sub-menu (SETUP, IMAGE, OPTION). Press the right arrow or move the mini-joy stick right to enter the sub-menu.

Note

The projector will display either the RGB or Video Setup menu according to the input source being projected.

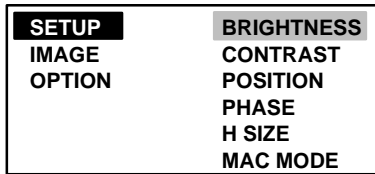

Figure 4-4. Setup Sub-Menu (RGB Input)

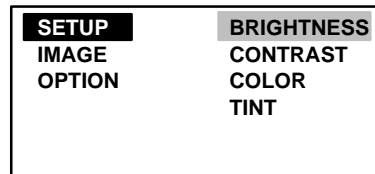

Figure 4-5. Setup Sub-Menu (Video Input)

Press the up/down arrow on the control panel or move the mini-joy stick up/down to select the desired adjustment screen (BRIGHTNESS, CONTRAST, etc.). Press the SELECT button to enter the adjustment screen. Use the control panel arrows or mini-joy stick to change the value/position to the desired setting and press the SELECT button to activate the new setting.

Refer to the SETUP MENU SCREEN charts below. A description and the default value for each value/position is listed.

If you press the RESET button, the selected value will return to the factory default setting.

RGB – SETUP SUB-MENU		
Adjustment Screen	Value/Position	Default
BRIGHTNESS	±00 ———— ————	±0
CONTRAST	±00 ———— ————	±0
POSITION	H ± 00 V ± 00	±0
PHASE	±00	±0
H SIZE	±00	±0
MAC MODE (RGB only)	ON= MAC 16 or 19 inch OFF=all other computers	OFF

SETUP SUB-MENUS (RGB, VIDEO), continued

VIDEO – SETUP SUB-MENU			
Adjustment Screen	Value/Position		Default
BRIGHTNESS	±00	——— ———	±0
CONTRAST	±00	——— ———	±0
COLOR	±00	——— ———	±0
TINT	±00	——— ———	±0

IMAGE SUB-MENU

Press the MENU button to display the Main Menu. The SETUP Sub-Menu will be highlighted. Press the up/down arrow or move the mini-joy stick up/down to select the IMAGE Sub-Menu. Press the right arrow on the control panel or move the mini-joy stick right to enter the sub-menu.

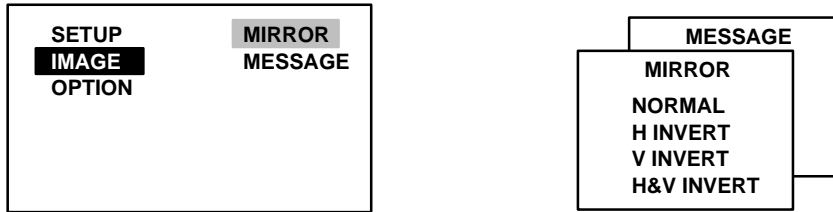

Figure 4-6. Image Menu

Press the up/down arrows or move the mini-joy stick up/down to select the desired adjustment screen (MIRROR or MESSAGE). Press the SELECT button to enter the adjustment screen.

Note

In Figure 4-6, the IMAGE Sub-Menu then the MIRROR Adjustment Screen have been selected. Press SELECT to enter the MIRROR Adjustment Screen.

Use the up/down/left/right arrows or mini-joy stick to change the value. The new value will activate as soon as it is changed. Press the SELECT button to return to the IMAGE Sub-Menu.

Refer to the IMAGE Sub-Menu chart below. A description and the default for each value is listed.

If you press the RESET button, the selected value will return to the factory default setting.

IMAGE SUB-MENU			
Adjustment Screen	Value	Description	Default
MIRROR (see note above)	NORMAL	Standard tabletop projection (no inversion)	ON
	H INVERT	Rear projection application	OFF
	V INVERT	Ceiling mount and rear projection application	OFF
	H & V INVERT	Ceiling mount application	OFF
MESSAGE	ON OFF	ON = messages display OFF = no messages display	ON

OPTION SUB-MENU

Press the MENU button to display the Main Menu. The SETUP Sub-Menu will be highlighted. Press the up/down arrow or move the mini-joy stick up/down to select the OPTION Sub-Menu. Press the right arrow on the control panel or move the mini-joy stick right to enter the sub-menu.

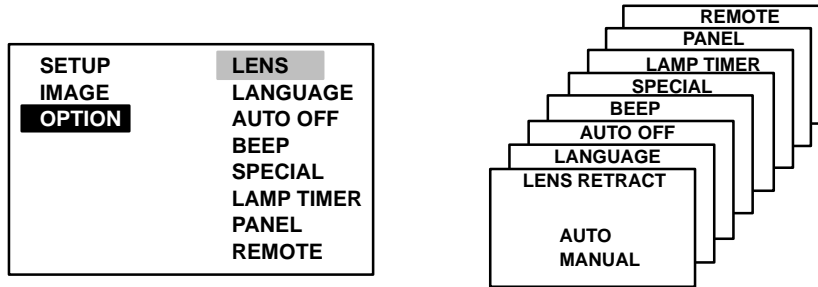

Figure 4-7. Option Menu

Press the up/down arrows or move the mini-joy stick up/down to select the desired adjustment screen (LENS, LANGUAGE, AUTO OFF, BEEP SPECIAL or PANEL). Press the SELECT button to enter the adjustment screen.

Note

In Figure 4-7, the OPTION Sub-Menu and LENS Adjustment Screen have been highlighted. Press SELECT to enter the LENS Adjustment Screen.

Use the up/down/left/right arrows or mini-joy stick to change the adjustment screen to the desired setting. The new value will activate as soon as it is selected. Press the SELECT button to return to the OPTION Sub-Menu.

Refer to the OPTION Sub-Menu chart below. A description and the default for each value is listed. If you press the RESET button, the selected value will return to the factory default setting.

OPTION SUB-MENIU		
Adjustment Screen	Value	Default
LENS	AUTO=lens auto retract On MANUAL=lens auto retract Off	AUTO
LANGUAGE	Select menu language: ENGLISH FRENCH SPANISH GERMAN	English
AUTO OFF	YES=auto power off after 10 minutes of no input (blue screen) NO>manual power off	NO
BEEP	ON=activate beep OFF=no beep	ON
SPECIAL (Test screen displays current input data)	RGB1 TEST SCREEN FIRMWARE REV. #xxxxxx SVGA56 H xx.x kHz V xx.x Hz	—
LAMP TIMER	LAMP TIMER 1000 hours	—
PANEL	GREEN BLUE ± 00 ± 00	00*
REMOTE (Select remote control sensor)	BOTH = Front and rear sensor FRONT= Front sensor only REAR = Back sensor only	BOTH

* The LCD panel alignment can be electronically adjusted up or down by one pixel. This is a vertical adjustment only.

4-4. Adjusting Image Size and Focus

Zoom: Press the ZOOM +/- buttons to adjust the image size. If you cannot make the image fill the screen, locate the projector further back from the screen.

Focus: Press and hold the FOCUS +/- buttons to increase or decrease the sharpness of the projected image.

Caution

To avoid **damaging the internal projector components**, DO NOT rotate the projection lens with your hand. Always use the remote control or control panel buttons to adjust the focus.

4-5. Adjusting the Volume

Press and hold the VOL +/- buttons to increase or decrease the volume.

Note

Press the MUTE button  on the remote control to silence the volume. Press MUTE or VOLUME to return the sound.

4-6. Video System

The MP8660 has an automatic video detection function that will select the correct video system for NTSC, PAL or SECAM.

4-7. MAC Mode (RGB only)

Select the MAC MODE option if you are connecting a 16 inch or 19 inch Macintosh computer. To select this option, go to the SETUP menu, select MAC MODE and choose "ON." When the MAC MODE is turned on, the projector will automatically select the correct mode (either 16 inch or 19 inch). See Technical Appendix for additional information.

4-8. Menu Languages

The MP8660 will display on-screen menus in the following languages:

- English
- French
- Spanish
- German

4-9. Turning Off the Projector

Press the STANDBY/ON button (remote control keypad or projector control panel) to switch the projector to the standby mode. The lamp will shut off and the green indicator on the projector panel will turn to amber. Wait until the cooling fan motor cycles off before you press the Power Off switch (Figure 3-2).

Note

Switching the power off before the fan has cycled off, will decrease the life of the projection lamp.



5-1. How to Operate the Remote Control

The remote control keypad (Figure 5-2) controls basic projector functions.

To use the remote control:

- Aim the remote toward the projection screen or at the back of the projector (Figure 5-1).
- Press the desired button and the signal will bounce off of the screen to the front sensor or directly enter the back sensor.

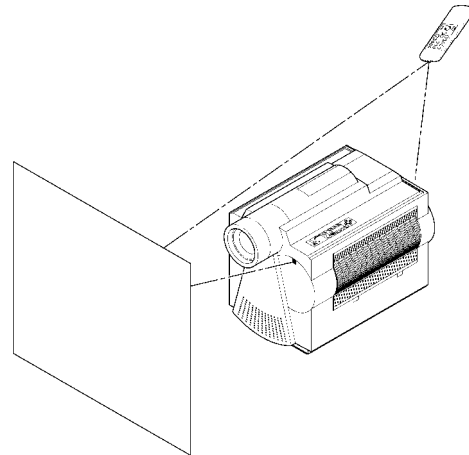

The function of each remote control button is explained below.

Figure 5-1. Using the Remote Control

Remote Control Buttons













-  Press **STANDBY/ON** to switch projector between *projection* and *standby* mode. In *projection* mode the lamp is **ON**. In *standby* mode the lamp is **OFF**.
-  Press **BLANK** to display a black background with no image. Press again to return the image to the screen.
-  Press **MUTE** to switch the audio sound **ON** or **OFF**.
-  Press **ZOOM** () to increase or decrease the size of the screen image.
-  Press **FOCUS** () to increase or decrease the sharpness of the screen image.
-  Press **VOLUME** () to adjust internal/external speaker volume.
-  Press **BACK LIGHT** to light the remote buttons.
-  Press **RGB** to switch computer video input (RGB1 ⇒ RGB2 ⇒ RGB1).
-  Press **MENU** to display the on-screen menus. Move the mini-joy stick up/down or left/right as needed to navigate the menu options. Note: Press **SELECT** to choose the option that is highlighted.
-  Press **SELECT (L)** to choose the highlighted menu option. Refer to On-Screen Menus in Section 4.
-  Press **RESET** to reset menu options to the factory default setting. Refer to On-Screen Menus in Section 4.
-  Press **VIDEO** to switch between video inputs (VIDEO1 ⇒ VIDEO2 ⇒ VIDEO1).



Figure 5-2. Remote Control

Using the Mouse Buttons

Refer to Cable Connections in Section 3 for details on how to connect your type of mouse.

There are three mouse buttons L-Left, R-Right and DRAG and a mini-joy stick for controlling mouse functions. See Figure 5-3.

Mouse Mini-Joy Stick: The mini-joy stick controls the position of the on-screen cursor or pointer.

L – Left Mouse Button: This button has two functions.

- ™ Use it to perform the same function as a left mouse button
- ™ Press L when a menu is displaying to select the highlighted menu option.

R – Right Mouse Button: This button has the same function as a right mouse button.

DRAG: Use this button to hold and drop an object so it can be moved to a new position on the screen.

- ™ Press and release the DRAG button to select a highlighted object (similar to pressing down and holding a normal mouse key button).
- ™ Use the mini-joy stick to move the object to a new position.
- ™ Press the DRAG button again to release the object.

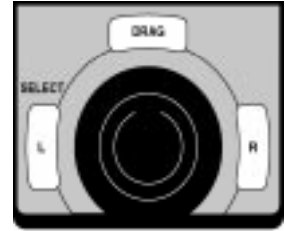

Figure 5-3. Mouse Buttons

Replacing the Batteries

The remote control uses three AAA batteries. The battery cover is located on the back of the remote control (Figure 5-4). Slide the door open to access the batteries. Make sure the polarity (+/-) on each battery matches the decal in the battery compartment.

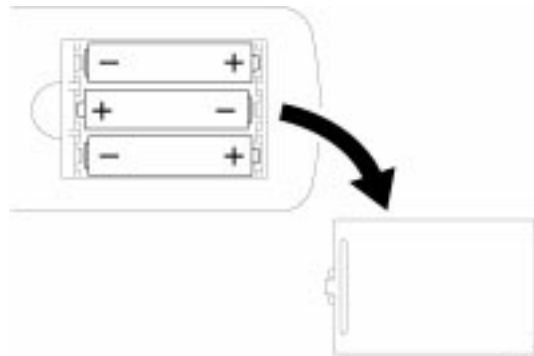

Figure 5-4. Replacing the Batteries



6-1. Metal Halide Projector Lamp

Under normal operating conditions, the lamp should last approximately 1000 hours. However, after time, the lamp brightness will slowly decrease. *The projection lamp contains mercury and should be disposed of according to local regulations.*

Note

The TEMPERATURE indicator will come on if the lamp becomes too hot. If this happens, wait for the fan motor to stop running, turn the power off and let the projector cool. Check for airflow blockage, clean the air filter then turn the power on. If the TEMPERATURE indicator comes on again, call customer service or your dealer for assistance.

Display or Reset Lamp Operation Hours

The LAMP RESET button is a recessed button. Use a paper clip or pen point to press the LAMP RESET button (1) on the projector control panel (Figure 6-1) and the current lamp operating hours (2) will display. *The lamp reset screens will time-out within 5–10 seconds if no selection is made.*

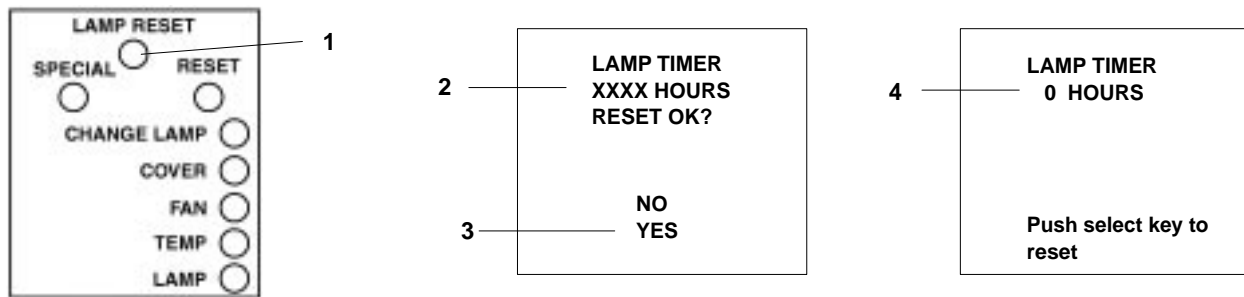

Figure 6-1. Projector Control Panel

Press the up/down arrows TM on the control panel to select either YES or NO.

- YES=reset timer hours to zero
- NO=continue with current timer hours

Note

Reset the lamp hours to zero only when installing a new lamp.

To reset the hours to zero, select YES (3) and press the SELECT button on the control panel.

Press the SELECT button again to complete the procedure and the message “RESET COMPLETE” will display for 10 seconds.

Change Lamp Message

After 1000 hours of lamp operation, the message CHANGE LAMP will display for 30 seconds each time the machine is powered on. This message is an indication that it is time to install a new lamp.

For best results, the lamp should be replaced after 1000 hours of usage. See Section 6-2. Using a lamp beyond 1000 hours is not recommended because there is an increased potential for the lamp to burst when it gets old.

Contact your nearest Service Repair Center or the Technical Assistance Center at:

In U.S. or Canada: **1-800-328-1371**

In other locations, contact your local 3M Sales office.

6-2. MP8660 Lamp Replacement

To replace the lamp on the 3M MP8660 Multimedia Projector, you will need the following:

- 2.5 mm hex wrench (shipped with replacement lamp module)
- Metal halide lamp 78-6969-8460-4

⚠ Caution

Lamp and adjacent metal parts become extremely hot and can cause **burns to your fingers**. Allow the projector to cool for at least 1 hour before replacing the lamp.

⚠ Caution

Do not touch the inside of the lamp glass with your fingers. Oil from your fingers can contaminate the lamp glass and cause it to **crack or burst**.

⚠ Caution

Use care when inserting or removing the lamp module from the projector. Excessive force can cause **damage to the lamp or projector**.

1. **Power OFF:** Press the Standby/ON button and wait for the fan motor to cycle off. Then, turn off the power switch and **UNPLUG THE POWER CORD**.
2. **Allow projector to cool:** If the projector is at operating temperature, wait one hour to allow the metal parts to cool before continuing.
3. **Remove Lamp Access Door:** Use a 2.5 mm hex wrench to unscrew the lamp cover retaining screws (1) and gently open the cover. Set aside (2).
4. **Remove Lamp Module:** Slide the old lamp module (4) out of the projector body.
5. **Insert Lamp Module:** Carefully insert the new lamp module (5) into the opening and slide it all the way back into place. Check the lamp module to be sure that it is fully inserted and flush against the back wall.
6. **Secure Lamp Module:** Tighten the lamp module retaining screws (6) to secure the lamp in place.
7. **Close and Secure Door:** Close lamp access door (7) and tighten the retaining screws (8) to secure the door. Turn on projector and test lamp. If lamp light blinks green but lamp does not illuminate, reseal lamp (step 6).

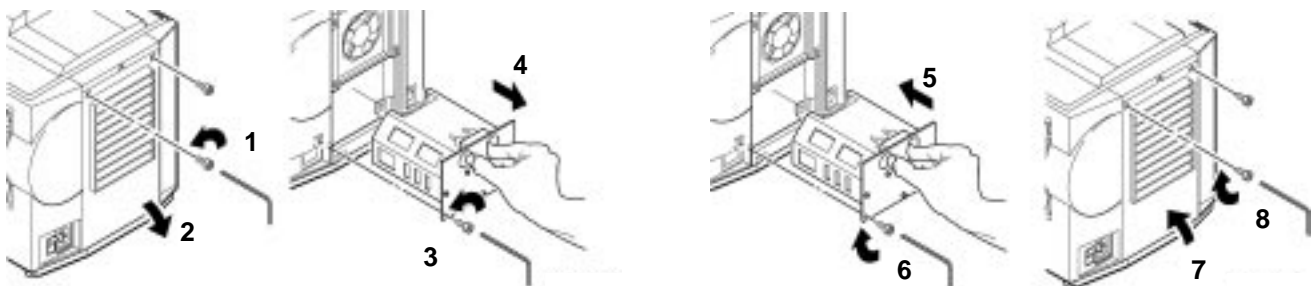

Figure 6-2. Changing the Lamp

Important

The projection lamp contains mercury. Consult your local hazardous waste regulations and **dispose of this lamp in a proper manner.**



7-1. Cleaning

For best performance, keep your projector free of excess dust and surface dirt.

Daily Cleaning

Use a soft cloth to remove dust from the projector housing.

Cleaning the Projection Lens

Use 3M™ Overhead Cleaner 676 to remove surface dirt and smudges from the projection lens (Figure 7-1).

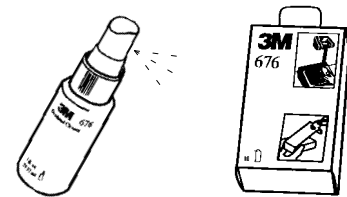

Figure 7-1. Cleaning the Lens

Cleaning the Air Filters

For best performance, clean the air filters every 50 hours of operation.

Removing Air Filters: Unplug the power cord and carefully remove the air filters.

The bottom air filter (Figure 7-2) is located underneath the projector and is easily removed (1) by sliding it out like a center desk drawer.

The side air filter (Figure 7-2) is located on the control panel side of the projector and is easily removed by pressing the release tabs (2) in and lifting the bottom edge of the panel up (3) and away from the body of the projector. This will expose the side air filter inside the projector. Raise the plastic retaining frame (4) and carefully take out the air filter (5).

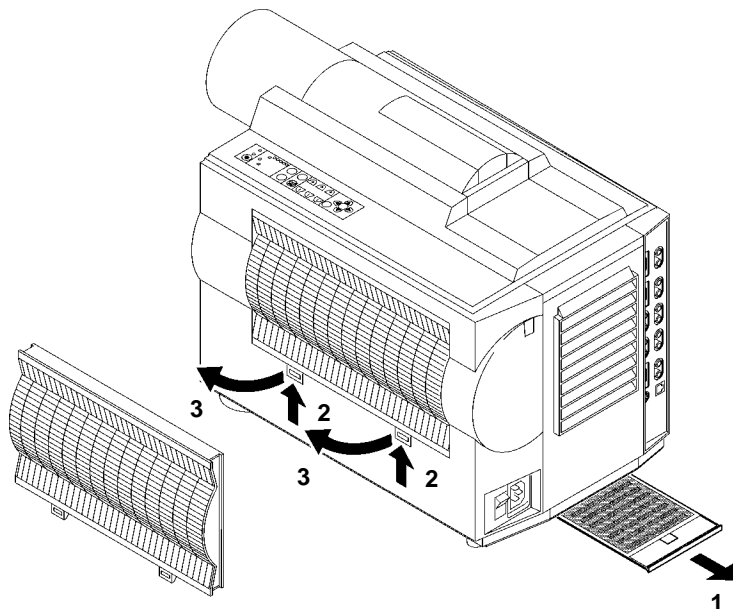

Figure 7-2. Air Filters

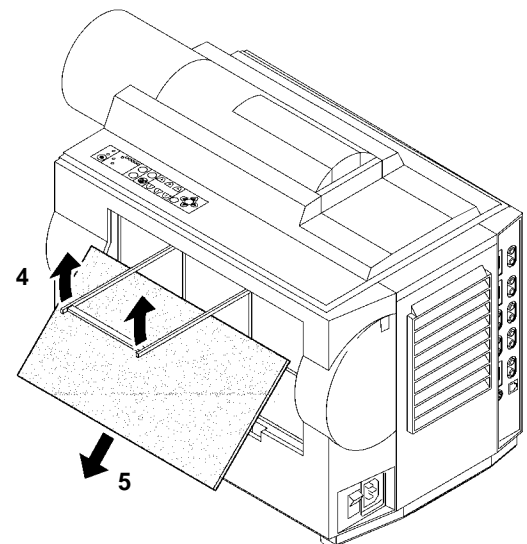

Figure 7-3. Lift up to remove side panel

Cleaning Air Filters:

Use a vacuum cleaner (Figure 7-4) to remove dust and dirt from the air filters and from the mesh screen inside the projector.

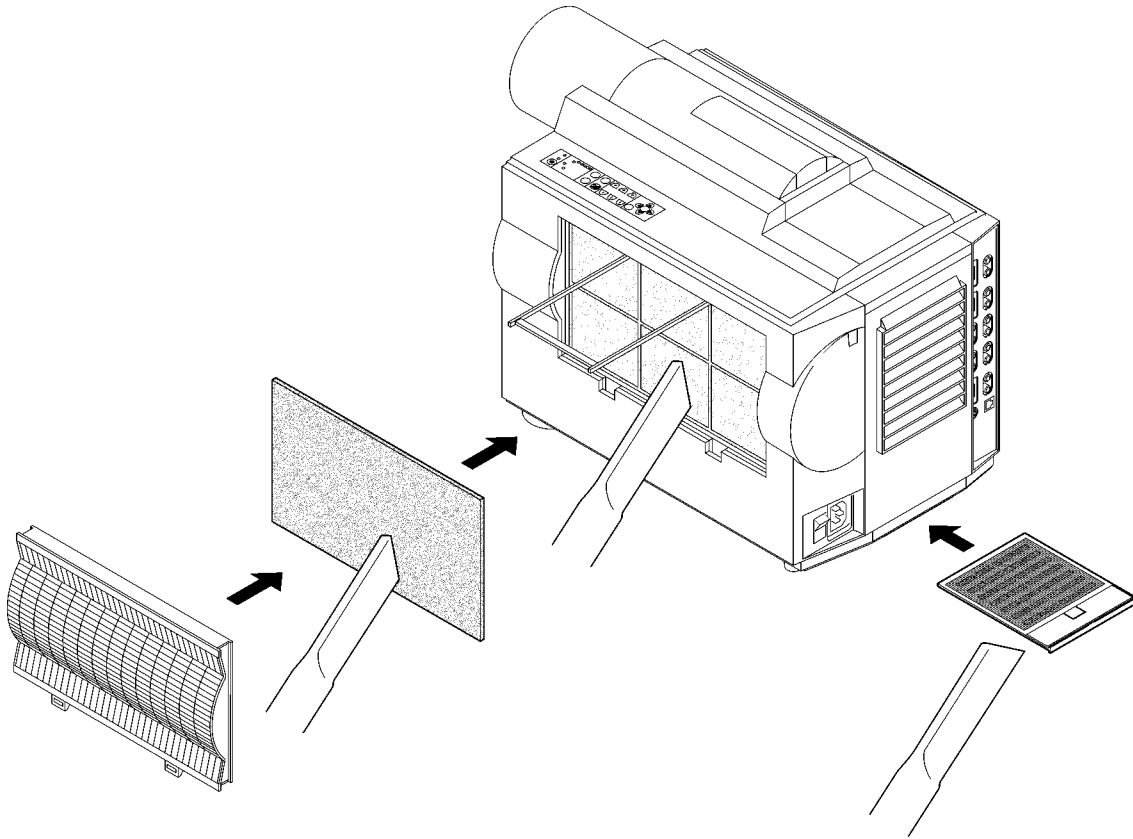

Figure 7-4. Vacuum Air Filters

Reinstall the bottom air filter (top side up) by sliding it back into place (Figure 7-4).

Carefully insert the side air filter and lower the retaining frame to secure it. Replace the side panel and press down on the bottom edge until the tabs lock it into position (Figure 7-2).



Section 8: Troubleshooting

The MP8660 has been designed to be as simple and trouble-free to use as possible. If you should run into problems operating the projector, please review the troubleshooting information below.

Problem	Probable Causes	Solution
<i>Power does not come on</i>	Power not connected. Rear cover is open.	Plug power cord into an electric outlet. Turn power switch to "ON." Close cover door tightly.
<i>No picture and sound</i>	Input connections not properly installed.	Set the projector to the correct input source. Check all cable connections from input source to projector. Make sure the input source power is on.
<i>Picture displays but no sound</i>	Cable connections loose and/or volume adjustment needed.	Check all cable connections from input source to projector. Press VOLUME then + on the remote control. Press the MUTE button on the remote control.
<i>Sound but no picture</i>	Cable connections loose and/or picture adjustment needed. BLANK button has been pressed.	Check all cable connections from input source to projector. Adjust the picture brightness. Press MENU, then press SELECT. Press BLANK button to restore picture.
<i>Weak saturation</i>	Picture adjustment needed.	Adjust picture color and tint (video only). Press MENU, then press SELECT.
<i>Picture is dark</i>	Picture adjustment needed	Adjust the picture brightness and contrast. Press MENU, then press SELECT. Lamp may need replacement. Call customer service for assistance. See Service Information below.
<i>Picture is not sharp and clear</i>	Picture adjustment needed.	Adjust focus, H-size (RGB) and phase. Press MENU, then press SELECT.
<i>WARNING is flashing on the projection screen</i>	Projector is overheating.	Turn the projector off and let it cool for 30 minutes. Clean the air filter and check all ventilation holes for blockage.
<i>LAMP indicator red, Power-On indicator amber</i>	Problem with lamp has been detected.	Turn the power off and let the projector cool. If the LAMP indicator comes on again, replace the lamp. If problem continues, call service.
<i>"Change Lamp" message displays when projector is powered on</i>	Lamp has been used for recommended 1000 hours.	The Change Lamp message will display for 30 seconds after power on when the lamp clock reaches 1000 hours. This lamp is old and should be replaced.

Problem	Probable Causes	Solution
<i>Remote control does not operate</i>	Signal is not being received by front or back sensors.	Point the remote control toward the projection screen so the signal will bounce back to the projector. The REMOTE LIGHT on the control panel should flash when receiving the signal. Make sure the remote control sensors on the front/back of the projector are not blocked from receiving the signal. Move remote closer to the projector. Replace old batteries with fresh AAA batteries. The polarity of the batteries (+/-) must match the decal.
<i>TEMP indicator is red, Power indicator is amber</i>	Projector is overheating.	Turn the projector off and let it cool. Check the ventilation holes for blockage.
<i>COVER indicator is red, Power indicator is amber</i>	Side air filter panel is not completely closed.	Check and close all panels and doors.
<i>FAN indicator is red, Power indicator is amber</i>	A problem with the fan has been detected.	Turn the projector off and let it cool for 30 minutes. Clean the air filters and check all ventilation holes for blockage. Call service if the problem continues.

8-1. Service Information

For product information, product assistance, service information, or to order accessories, please call:

In U.S. or Canada: **1-800-328-1371**

In other locations, contact your local 3M Sales office.



9-1. MP8660 Multimedia Projector Accessories

If you wish to purchase accessories or replacement parts for the 3M MP8660 Multimedia Projector, please refer to the following list:

Accessory Parts List

<u>Part Description</u>	<u>Part Number</u>
Metal Halide Lamp Module, 350W	78-6969-8460-4
Power Cords	26-1009-7103-0US 26-1009-7104-8Euro 26-1010-1051-5UK
VGA Cable (15–15 pin M/M)	78-8118-3235-7
Video Cable (S-Video mini DIN-4pin)	78-8118-3238-1
MAC Adaptor	78-8118-3391-8
Lens Cap	78-8118-3396-7
3-Conductor Video/Audio Cable	78-8118-3234-0
Remote Control	78-6969-3395-9
Gender Changer for Apple Macintosh (monitor loop-through)	78-8118-3394-2
Serial Mouse Cable (Serial mouse emulation)	78-8118-3386-8
ADB Adaptor Cable (MAC mouse emulation)	78-8118-3388-4
PS/2 Adaptor Cable (mouse emulation)	78-8118-3387-6
RS-232 Cable	78-8113-3389-2
S-VGA Apple Macintosh Adaptor (832 x 624)	78-8118-3236-5
VGA Apple Macintosh Adaptor (640 x 480)	78-8118-3237-3
RCA to Stereo Mini Jack	78-8118-3399-1
Hexagon Wrench	78-8118-3377-7
Ceiling Mount Kit	78-6969-8503-1
Adjustable Height Suspension Post	78-6969-8312-7
MP8660 Shipping Case	78-6969-8464-6
MP8660 Soft Carrying Case	78-6969-8463-8

How to Order

Please order these parts through your dealer, or contact 3M Customer Service at the following number:

In U.S. or Canada: **1-800-328-1371**

In other locations, contact your local 3M Sales office.

The contents of this manual are subject to revision without prior notice.

3M assumes no responsibility for the infringement of special rights of a third party or other rights that may arise out of the use of the information contained in this manual.

Reproduction of this manual in any form without prior permission is strictly prohibited.

3M will replace the manual if any pages are missing or collated incorrectly.



Table of Contents

A-1. Specifications	A-1
A-2. S-Video Input Signal Terminal	A-2
A-3. Projector-to-Screen Distances	A-2
A-4. Physical Dimensions	A-3
A-5. Computer Video (RGB) Input Terminal	A-4
A-6. Computer (RGB) Signal Connection Modes	A-4
A-7. Mouse Emulation Connections	A-5
A-8. Serial Interface Command Codes	A-6

A-1. Specifications

Width	28.1 cm (11.06 inch)
Height	35.8 cm (14.1 inch)
Depth	49.1 cm (19.3 inch)
Weight	110V 14.5 kg (32.05 lbs) 220V 15.0 kg (33.15 lbs)
Panel size	8.1 cm (3.2 inches)
Number of pixels per panel	480,000 pixels (H800 X V600), 3 panels = 1.44 million total pixels
Dot defect	< 0.011% of total pixel count
Zoom lens	1.6:1
Metal halide lamp	350W, rated at 1000 hours to half brightness
Power supply	AC100-120V, 50/60Hz AC220-240V, 50/60Hz
Power consumption	Maximum 470W (typical)
Storage temperature range	-20 C to 60 C (-4 F to 140 F)
Operating temperature range	0 C to 35 C (32 F to 95 F)
Input terminals	S-Video: Mini DIN4-pin terminal Video: RCA jack Audio: RCA jack Computer (RGB): D sub15-pin HD terminal
Input signals	S-Video: Luminance 1.0V peak-to-peak, 75Ω termination, Chroma 0.286V peak-to-peak (burst signal) 75Ω term. Video: 1.0V peak-to-peak, 75Ω termination Audio: 260mvRMS, across 46kΩ Computer (RGB1/RGB2): 0~0.7V peak-to-peak, 75Ω
RGB (computer) input	Audio: RCA jack
Output terminals	Computer (RGB): D sub15-pin HD terminal Audio: RCA jack
Output signals	Monitor: 0~0.7V peak-to-peak, 75Ω Audio: 0~0.7V peak-to-peak or less, 680Ω termination
Batteries for remote control	Three AAA, 1.5 Volt

TECHNICAL

A-2. S-Video Input Signal Terminal

The following illustration (Figure 10-1) identifies the terminal connections for the Mini DIN4-pin.

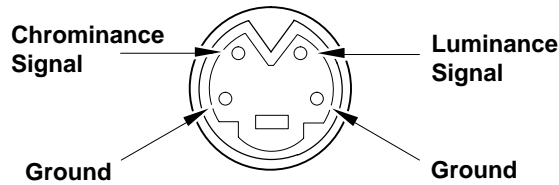

Figure 10-1. S-Video Input (Mini DIN4-pin)

Video input signal terminals are detected by the MP8660 in the following order of priority:

- S-video input terminal
- RCA jack input terminal

A-3. Projector-to-Screen Distances

DISTANCE TO SCREEN	MINIMUM IMAGE			MAXIMUM IMAGE			Image Height From Center of Lens	
	Diagonal	Width	Height (H)	Diagonal	Width	Height (H)	Minimum Image (A)	Maximum Image (A)
152 cm (5 ft.)	76 cm (30 in.)	61 cm (24 in.)	46 cm (18 in.)	121 cm (47.5 in.)	97 cm (38 in.)	72 cm (28.5 in.)	37 cm (14.6 in.)	58 cm (22.8 in.)
229 cm (7.5 ft.)	111 cm (43.8 in.)	89 cm (35 in.)	67 cm (26.3 in.)	176 cm (69.4 in.)	141 cm (55.5 in.)	106 cm (41.6 in.)	54 cm (21.3 in.)	85 cm (33.5 in.)
314 cm (10.3 ft.)	152 cm (60.0 in.)	122 cm (48 in.)	91 cm (36 in.)	238 cm (93.8 in.)	191 cm (75 in.)	143 cm (56.3 in.)	73 cm (28.7 in.)	114 cm (44.9 in.)
381 cm (12.5 ft.)	183 cm (71.9 in.)	146 cm (57.5 in.)	110 cm (43.1 in.)	289 cm (113.8 in.)	231 cm (91 in.)	173 cm (68.3 in.)	88 cm (34.6 in.)	139 cm (54.7 in.)
457 cm (15 ft.)	219 cm (86.3 in.)	175 cm (69 in.)	131 cm (51.8 in.)	343 cm (135 in.)	274 cm (108 in.)	206 cm (81 in.)	105 cm (41.3 in.)	165 cm (65 in.)
564 cm (18.5 ft.)	271 cm (106.9 in.)	217 cm (85.5 in.)	163 cm (64.1 in.)	424 cm (166.9 in.)	339 cm (133.5 in.)	254 cm (100.1 in.)	130 cm (51.2 in.)	203 cm (79.9 in.)
610 cm (20 ft.)	291 cm (114.4 in.)	232 cm (91.5 in.)	174 cm (68.6 in.)	454 cm (178.8 in.)	363 cm (143 in.)	272 cm (107.3 in.)	139 cm (54.7 in.)	218 cm (85.8 in.)

Relationship of heights H (image height) and A (height measured from center of lens) is: $A = 0.8 \times H$

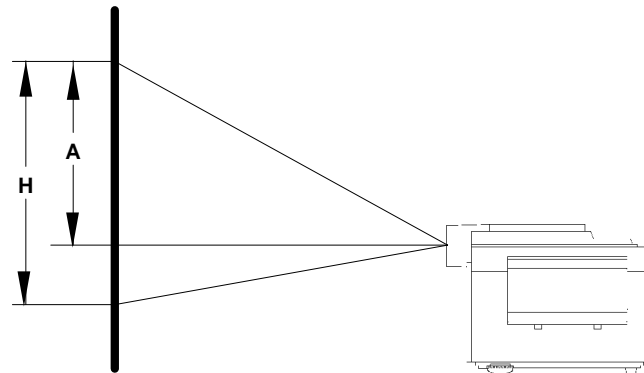

Figure 10-2. Measuring Image Height

A-4. Physical Dimensions

The MP8660 projector has the following physical dimensions:

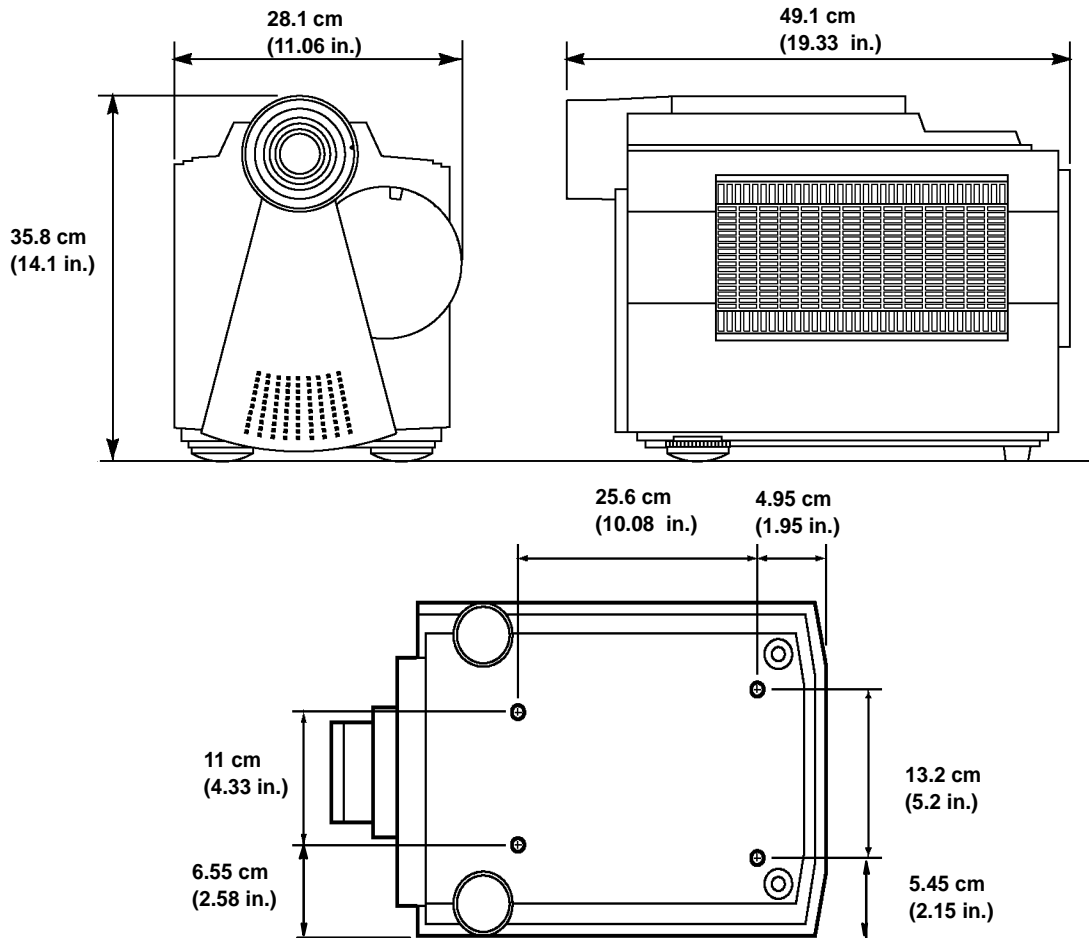

Figure 10-3. Physical Dimensions

A-5. Computer Video (RGB) Input Terminal

The following illustration (Figure 10-4) shows the terminal connections for the D-sub 15 pin HD connector. Refer to the table below for a description of the wire to pin connections.

Pin #	Description	Pin #	Description
1	Image Input (red)	9	Not connected
2	Image Input (green)	10	Ground
3	Image Input (blue)	11	Not connected
4	Not connected	12	Not connected
5	Ground (for sync.)	13	Composite/horizontal sync signal
6	Ground (red)	14	Vertical sync signal
7	Ground (green)	15	Not connected
8	Ground (blue)		

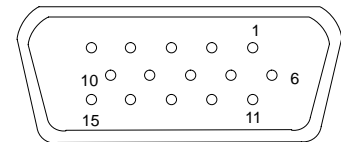

Figure 10-4. D-sub 15 pin Connector

A-6. Computer (RGB) Signal Connection Modes

The MP8660 projector automatically recognizes the following connection modes.

Mode	H-Size	Pixel Number	Scan Frequency		Dot Clock Frequency (MHz)	Synchronization Signal		Computer
			Horizontal (kHz)	Vertical (Hz)		Horizontal width/polarity	Vertical width/polarity	
2	848	640 x 400	24.83	56.42	21.053	64/-	8/-	TEXT 56
3	800	640 x 400	31.47	70.09	25.175	96/-	2/+	TEXT 70
3	800	640 x 350	31.47	70.09	25.175	96/+	2/-	TEXT 70
4	832	640 x 400	37.86	85.08	31.500	32/-	3/+	TEXT 85
4	832	640 x 350	37.86	85.08	31.500	32/+	3/-	TEXT 85
5	800	640 x 480	31.47	59.94	25.175	96/-	2/-	VGA 60
6	832	640 x 480	37.86	72.81	31.500	40/-	3/-	VGA 72
7	840	640 x 480	37.50	75.00	31.500	64/-	3/-	VGA 75
8	832	640 x 480	43.269	85.01	36.000	56/-	3/-	VGA 85
9	896	640 x 480	34.98	66.62	31.334	64/-	3/-	MAC 13
A	1024	800 x 600	35.16	56.25	36.000	72/±	2/±	SVGA 56
B	1056	800 x 600	37.88	60.32	40.000	128/+	4/+	SVGA 60
C	1040	800 x 600	48.08	72.19	50.000	120/+	6/+	SVGA 72
D	1056	800 x 600	46.88	75.00	49.500	80/+	3/+	SVGA 75
E	1048	800 x 600	53.67	85.06	56.250	64/-	3/-	SVGA 85
F	1152	832 x 624	49.73	74.55	57.283	64/-	3/-	MAC 16
10	1344	1024 x 768	48.365	60.006	65.000	136/-	6/-	XGA60
11	1328	1024 x 768	56.476	70.069	75.000	136/-	6/-	XGA 70
12	1328	1024 x 768	58.13	71.59	77.200	136/-	3/-	XGA 72
13	1312	1024 x 768	60.02	75.029	78.750	96/+	3/+	XGA 75
14	1312	1024 x 768	48.78	60.00	64.000	96/-	6/-	MAC 19A
15	1328	1024 x 768	60.24	74.93	80.000	96/-	3/-	MAC 19B

Notes:

- “Mode” denotes the computer mode determined by the projector. The number can be read by the read command through RS-232 interface.
- Advanced scaling is used for all inputs that are not 800 x 600.
- Mode 10 and 140: For XGA, full advanced scaling (vertical and horizontal) is used. Modes 11–13 and 14: Only vertical advanced scaling is used.
- The synchronization signal widths represent the number of dots (horizontal) and the number of lines (vertical).
- H-size denotes the standard number of dots in the horizontal period.
- For the MAC16 and MAC19A/B computers, you must manually set the MAC MODE to “ON” to determine the correct modes. Set the MAC MODE to “OFF” for the following computer modes:
MAC16 as SVGA75
MAC19A as XGA60
MAC19B as XGA75
See Setup Sub-Menu to set MAC MODE.
- Computer name (in right column) appears when you display the TEST SCREEN on the projector.

A-7. Mouse Emulation Connections

Serial Mouse Cable

Mini Din 9-pin



Projector

Computer

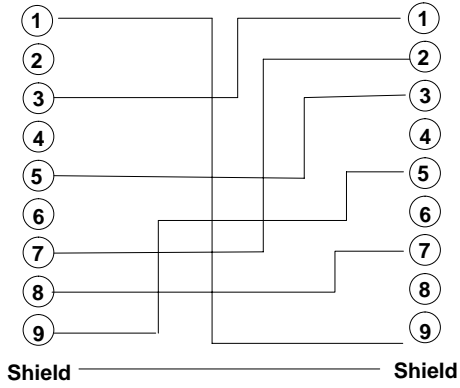

D-Sub 9-pin

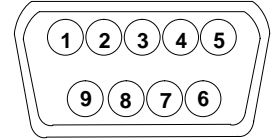

PS/2 Adaptor Cable

D-sub 9-pin

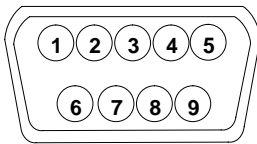

Projector

Computer

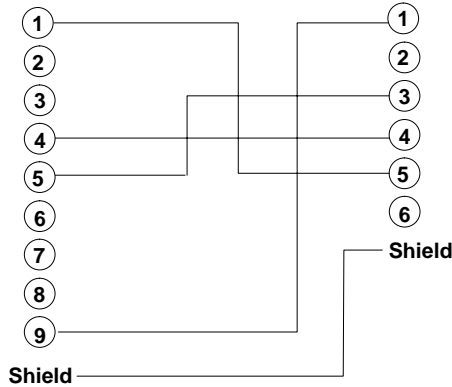

Mini Din 6-pin

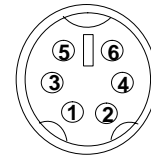

ADB Adaptor Cable

D-sub 9-pin

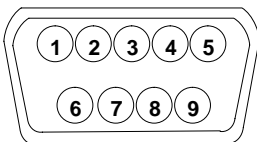

Projector

Computer

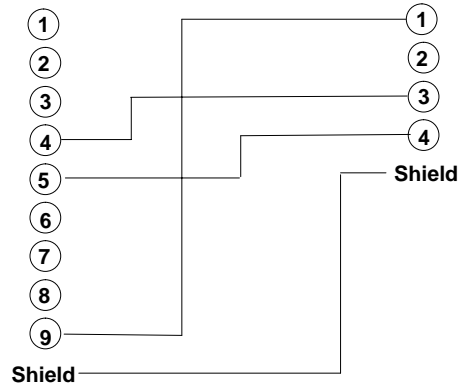

Mini Din 4-pin

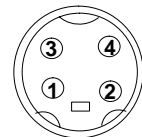

A-8. Serial Interface Command Codes

RS-232 Connection Cable

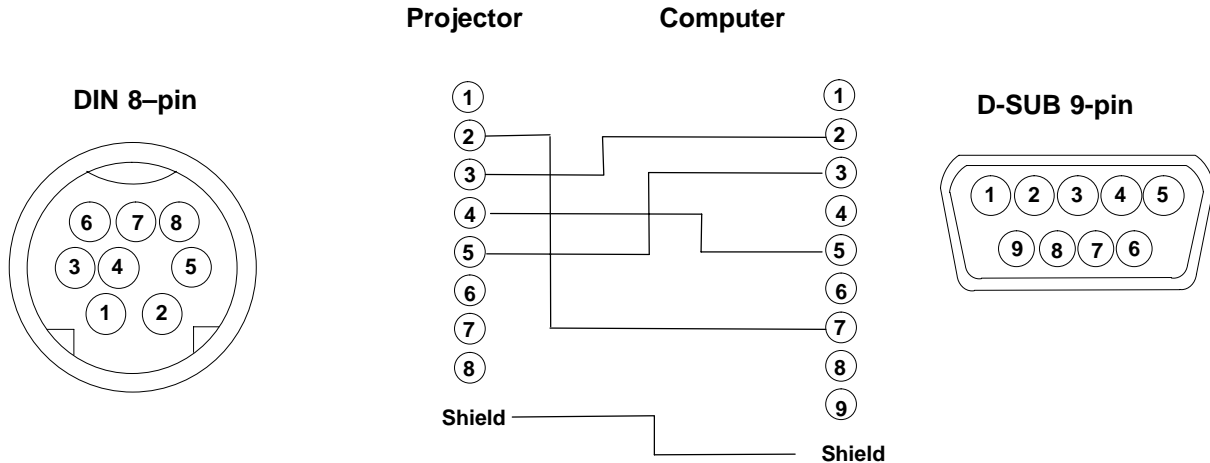

Command Code Formats

All codes in this document are in ASCII Text. In order to get this to work you must send at the same communication setting as the projector.

This should be 9600 8N1.

For the rest of this document CR is a carriage return which is code 13.

There are two types of commands that can be sent to the projector. They are Write commands and Read commands.

Write Command Format

User:

Code	CR
------	----

Projector:

O	K	CR
---	---	----

if it worked or:

N	G	CR
---	---	----

if it did not work.

Read Command Format

User:

Code	CR
------	----

Projector:

Data	O	K	CR
------	---	---	----

if it worked or:

N	G	CR
---	---	----

A-8. Serial Interface Command Codes, continued

Function	Code	Meaning
Power On/Off	Write Codes D00W00 D00W01 Read Codes D00R	Power On Power Off Returns: 00 – Standby 01 – Power on but no lamp 02 – Power on and lamp 03 – Power off but fan running
Input Source	Write Codes D02W01 D02W02 D02W11 D02W12 D03W00 Read Codes D02R	RGB 1 RGB 2 Video 1 Video 2 Shows what input is selected on–screen Returns: 01 – RGB1 02 – RGB2 11 – Video1 12 – Video2
Volume Control	Write Codes D04W00 to D04W14 Read Codes D04R	Sets volume level to a value between 00 and 14 hex. This corresponds to 20 possible settings. Returns: 00 to 14 hex
Focus	Write Codes D05W00 D05W01 D05W10 D05W11 D05W20	300ms Clockwise 300ms Counterclockwise Continuous Clockwise Continuous Counterclockwise Turn off motor
Zoom	Write Codes D06W00 D06W01 D06W10 D06W11 D06W20	300ms Clockwise 300ms Counterclockwise Continuous Clockwise Continuous Counterclockwise Turn off motor
Mute	Write Codes D07W00 D07W01 Read Codes D07R	Mute off Mute on Returns: 00 – mute is off 01 – mute is on
Blank	Write Codes D08W00 D08W01 Read Codes D08R	Blank is off – image is shown Blank is on – black screen is shown Returns: 00 – off 01 – on
Contrast	Write Codes D12W00 to D12W14 Read Codes D12R	Set contrast level to a value between 00 and 14 hex. This corresponds to 20 possible settings. Returns: 00 to 14 hex
Brightness	Write Codes D13W00 to D13W14 Read Codes D13R	Sets brightness level to a value between 00 and 14 hex. This corresponds to 20 possible settings. Returns: 00 to 14 hex

A-8. Serial Interface Command Codes, continued

Function	Code	Meaning
Tint (Hue)	Write Codes D14W00 to D14W14 Read Codes D14R	Sets tint (hue) level to a value between 00 and 14 hex. This corresponds to 20 possible settings. Returns: 00 to 14 hex
Color (Saturation)	Write Codes D15W00 to D15W14 Read Codes D15R	Sets color (saturation) level to a value between 00 and 14 hex. This corresponds to 20 possible settings. Returns: 00 to 14 hex
PC Mode	Read Codes D30R	Returns: 0 to 15 hex 2 to 15: See Computer (RGB) Signal Connection (Section A-6) 00—Shows no input 01—Shows invalid input
MAC Mode	Write Codes D32W00 D32W01 Read Codes D32R	MAC MODE “OFF” MAC MODE “ON” Default is “OFF” Returns: 00—MAC MODE is OFF 01—MAC MODE is ON
Phase	Write Codes D34W00 to D34W80 D35W00 Read Codes D34R	Set phase to a value in the range of 00 to 80 hex. Reset phase to default Returns: 00 to 80 hex
Display Position	Write Codes D36W00 to D36WFE D37W00 to D37WFE D38W00 Read Codes D36R D37R	Change vertical display position (up/down) from reset position by 00 to FE. Change horizontal display position (left/right) from reset position by 00 to FE. Resets display position Returns: 00 to FE vertical position 00 to FE horizontal position
H-Size	Write Codes D39W00 to D39W80 Read Codes D39R	The 00 to 80 denotes the deviation of clock numbers from the standard in one horizontal period. “40” is zero, “00” is -64 and “80” is +64 decimal. Default value is “40” Returns: 00 to 80 hex
Remote Control	Write Codes D50W00 D50W01 Read Codes D50R	Disables the remote control Enables the remote control Returns: 00—Remote control is disabled 01—Remote control is enabled
On-Screen Displays	Write Codes D51W00 D51W01 Read Codes D51R	Disables on-screen display except “WARNING” Enables on-screen display 00—On-screen display is disabled 01—On-screen display is enabled

A-8. Serial Interface Command Codes, continued

Function	Code	Meaning
Language Selection	Write Codes D52W00 D52W01 D52W02 D52W03 Read Codes D52R	English French Spanish German Returns: 00 – English 01 – French 02 – Spanish 03 – German
Mirror	Write Codes D53W00 D53W01 D53W02 D53W03 Read Codes D53R	NORMAL H-INVERT V-INVERT H&V-INVERT Returns: 00–NORMAL 01–H-INVERT 02–V-INVERT 03–H&V-INVERT
Lens Auto Retract	Write Codes D54W00 D54W01 Read Code D54R	Disables auto retract Enables auto retract Default is “auto retract” Returns: 00–Auto retract is disabled 01–Auto retract is enabled
Auto Off	Write Codes D55W00 D55W01 Read Codes D55R	Disables auto off Enables auto off Default is “NO” auto off Returns: 00–Auto off is disabled 01–Auto off is enabled
Beep	Write Codes D56W00 D56W01 Read Codes D56R	Inactivates Beep Activates Beep Default is “Activate” Returns: 00–Beep is disabled 01–Beep is enabled
Special	Write Codes D57W00	Test screen is shown
Green panel position	Write Codes D58W00 D58W01 D58W02 Read Codes D58R	Sets the green panel to center Sets the green panel by 1 pixel up Sets the green panel by 1 pixel down Returns: 00–Green panel is in center position 01–Green panel moves 1 pixel up 02–Green panel moves 1 pixel down

A-8. Serial Interface Command Codes, continued

Function	Code	Meaning
Blue panel position	Write Codes D59W00 D59W01 D59W02 Read Codes D59R	Sets the blue panel to center Sets the blue panel by 1 pixel up Sets the blue panel by 1 pixel down Returns: 00–Blue panel is in center position 01–Blue panel moves 1 pixel up 02–Blue panel moves 1 pixel down
IR receiver selection	Write Codes D5AW00 D5AW01 D5AW02 Read Codes D5AR	Selects Front and Rear IR Receiver Selects Front IR Receiver Selects Rear IR Receiver Returns: 00–Front and Rear Receiver is selected 01–Front receiver is selected 02–Rear receiver is selected
Lamp Timer Reset	Write Codes D60W00 Read Codes D60R	Resets the lamp timer Returns: xxxx–shows lamp operating time in hours (decimal)
Temperature	Read Codes D61R	Returns: Shows the status of internal temperature 00–Temperature level 0 01–Temperature level 1 02–Temperature level 2 03–Temperature level 3 04–Temperature level 4 05–Temperature level 5 06–Temperature level 6
Reset	Write Codes D62W00	Resets all settings to default
Error Status	Read Codes D01R	Returns: 00–No error 01–Interlock error 02–Lamp error 04–Temperature error 08–Fan error 10–Memory error <i>Note: If there is more than one error, the resulting read code will be the sum of the error codes listed above. Example: For Interlock–01 and Lamp–02, resulting read code is 03.</i>

We're easy to reach

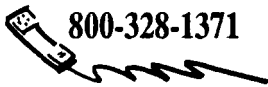

800-328-1371



<http://www.mmm.com/presentations>
e-mail: presentations@mmm.com

3M Austin Center
Building A145-5N-01
6801 River Place Blvd.
Austin, TX 78726-9000

3M Canada
P.O. Box 5757
London, Ontario, Canada
N6A 4T1

3M Mexico, S.A. de C.V.
Apartado Postal 14-139
Mexico, D.F. 07070
Mexico

3M Europe
Boulevard de l'Oise
9500 Cerge Pontoife Cedex
France

Let us help you make the most of your next presentation. We offer everything from presentation supplies to tips for better meetings. And we're the only transparency manufacturer that offers a recycling program for your used transparencies. For late-breaking news, handy references and free product samples, call us toll-free in the continental United States and Canada, 7:30 a.m. to 5:30 p.m. (CST). Or visit our Internet Web site.



*Printed on 50% recycled wastepaper,
including 10% post-consumer wastepaper*

Litho in U.S.A. ©3M 1997
78-6970-8001-4 Rev. A