



# MP7640 Multimedia Projector

## Operator's Guide

MP7640 Projecteur multimédia Guide de l'opérateur

MP7640 Multimedia-Projektor Benutzerhandbuch

Projector de Multimedia MP7640 Manual del Usuario

MP7640 Proiettore Multimediale Manuale dell'operatore

MP7640 Bruksanvisning för multimediprojektor

MP7640 Multimedia Projector Gebruiksaanwijzing

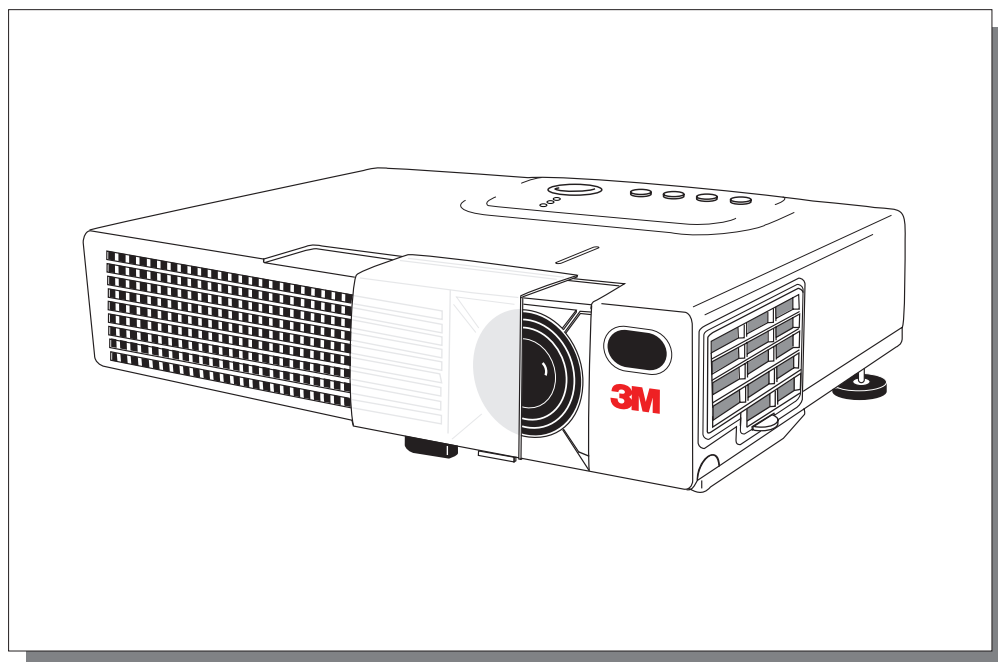



# Table of Contents

## Introduction

Safeguards .....	4
Thank You for Choosing 3M .....	6
Warranty .....	6

## Section 1: Unpack

Contents of Shipping Box .....	7
Optional Accessories .....	7
Keep Your Packing Materials .....	7
What's Next? .....	7

## Section 2: Product Description

Machine Characteristics .....	8
Part Identification List .....	9
System Setup—Connecting to Various Equipment .....	10
Remote Control Transmitter Identification .....	11
Changing Remote Control Battery .....	12

## Section 3: Basic Operations

Projector Startup .....	13
Projector Shutdown .....	13

## Section 4: Adjustments and Functions

How to Use Height Adjustment Foot .....	14
Plug & Play Function .....	15
Freeze Function .....	15
Magnify Function .....	15
Menu Navigation .....	16
Factory Default Setting .....	16
SETUP Submenu .....	17
INPUT Submenu .....	18
IMAGE Submenu .....	19
OPT Submenu .....	20

## Section 5: Maintenance

Cleaning the Air Filter .....	21
-------------------------------	----

## Section 6: Lamp

Lamp .....	22
Display Lamp Operation Hours .....	22
Reset Lamp Hours .....	22
Replacing the Lamp .....	23

## Section 7: Troubleshooting

Symptom/Solution Table .....	24
Message/Solution Table .....	24
Service Information .....	26

## Section 8: Accessories .....

## Section 9: Appendix (English only) .....

# Introduction

## Intended Use

Before operating the machine, please read this entire manual thoroughly. The 3M™ Multimedia Projector MP7640 was designed, built, and tested for use indoors, using 3M lamps, 3M ceiling mount hardware, and nominal local voltages. The use of other replacement lamps, outdoor operation, operation in environments containing heavy cigarette smoke or different voltages has not been tested and could damage the projector or peripheral equipment and/or create a potentially unsafe operating condition.

## Important Safeguards

1. Read and understand all instructions before using. Pay particular attention to areas where these symbols are shown:

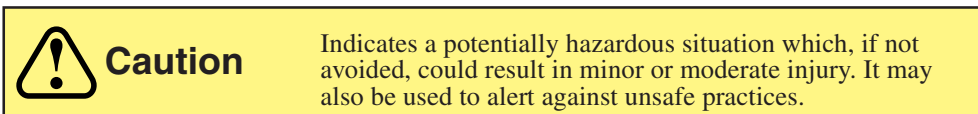

✓ *Note* - Used to emphasize important conditions or details.

2. Close supervision is necessary when any appliance is used by or near children. Do not leave appliance unattended while in use.
3. Never look directly into the projector lens when the lamp is on. The mercury lamp produces a strong light that could damage your eyesight.

- ⚠ 4. Care must be taken, as burns can occur from touching hot parts.

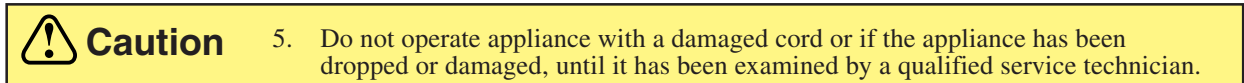

- ⚠ 6. Position the cord so that it will not be tripped over, pulled or placed in contact with hot surfaces.
7. If an extension cord is necessary, a cord with a current rating at least equal to that of the appliance should be used. Cords rated for less amperage than the appliance may overheat.
  8. Always unplug appliance from electrical outlet before cleaning and servicing and when not in use. Grasp plug and pull to disconnect.
  9. To reduce the risk of electric shock, do not immerse this appliance in water or other liquids.
  10. To reduce the risk of electric shock, do not disassemble this appliance. Take it to a qualified technician when service or repair work is required. Incorrect reassembly can cause electric shock when the appliance is subsequently used.
  11. Connect this appliance to a grounded outlet.
  12. Do not expose this projector to direct sunlight or use it outside.
- ⚠ 13. Keep all ventilation openings free of any obstructions.
14. Always open the lens shutter or remove the lens cap when the projector lamp is on.
  15. Do not look directly into light beam of laser pointer. The pointer produces a strong light which could damage your eyesight.
  16. The projection lamp contains mercury. Always dispose of it in a proper manner according to local regulations.
  17. To prevent lamp from bursting, do not continue using the same lamp after changing the mounting position of the projector (desktop to ceiling mount or ceiling mount to desktop mount).
  18. Always operate machine on a flat, sturdy surface.

# Introduction

## Location of Product Safety Labels

The following safety labels are used on or within the MP7640 projector to alert you to items or areas requiring your attention.

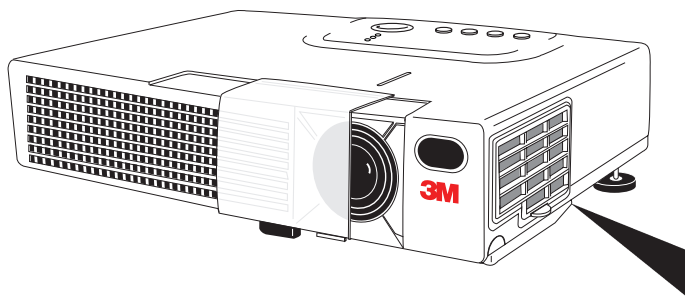

 HIGH TEMPERATURE/HAUTE TEMPERATURE/  
HOCHTEMPERATUR/ALTA TEMPERATURA/  
ALTA TEMPERATURA **3M**

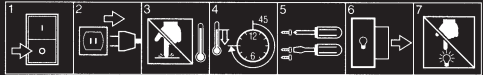

- When replacing lamp, turn off and unplug unit, wait 45 minutes to let lamp cool. High-pressure lamp when hot, may explode if improperly handled.
- Pour changer la lampe, éteindre et débrancher la machine. Attendre 45 minutes de manière à laissez refroidir la lampe. La lampe haute pression risque d'exploser si elle est manipulée sans précaution lorsqu'elle est encore chaude.
- Vor Austausch der Lampe, das Gerät abschalten und den Stecker herausziehen; 45 Minuten warten, um die Lampe abkühlen zu lassen. Falls die heiße Hochdrucklampe falsch gehandhabt wird, kann sie explodieren.
- Prima di sostituire la lampadina, spegnere il proiettore, scollegare la presa di alimentazione ed attendere 45 minuti circa che la lampadina si raffreddi. Se calda, essa è sottoposta ad alta pressione interna e può esplodere.
- Cuando tenga que reemplazar la lámpara, desconecte la alimentación y desenchufe la unidad, y espere 45 minutos para dejar que se enfríe la lámpara. La lámpara, que está a alta presión cuando está caliente, quede explotar si se manipula indebidamente.

QL06982

### Caution

In some countries, the line voltage is NOT stable. This projector is designed to operate safely within a bandwidth of 110 to 230 volts  $\pm$  10 volts, but could fail if power drops or surges of  $\pm$ 10 volts occur. In these high-risk areas, it is recommended to install a power stabilizer unit.

## Save These Instructions

The information contained in this manual will help you operate and maintain your 3M™ MP7640 Multimedia Projector.

# Introduction

## Thank you for Choosing 3M

Thank you for choosing 3M multimedia projection equipment. This product has been produced in accordance with 3M's highest quality and safety standards to ensure smooth and troublefree use in the years to come.

For optimum performance, please follow the operating instructions carefully. We hope you will enjoy using this high performance product in your meetings, presentations, and training sessions.

## Warranty

### Limited Warranty

3M warrants this product against any defects in material and workmanship, under normal usage and storage, for a period of two years from date of purchase. **Exclusion to Warranty:** The lamps are considered a consumable item and are warranted for 90 days or 180 hours, whichever occurs first. Proof of purchase date will be required with any warranty claim. In the event this product is found to be defective within the warranty period, 3M's only obligation and your exclusive remedy shall be replacement of any defective parts (labor included). To obtain warranty service, immediately notify the dealer from which you purchased the product of any defects. In the USA call 1-800-328-1371 for warranty or repair service.

### Limitation Of Liability

THE FOREGOING WARRANTY IS MADE IN LIEU OF ALL OTHER WARRANTIES, EXPRESSED OR IMPLIED, AND 3M SPECIFICALLY DISCLAIMS ANY IMPLIED WARRANTY OF MERCHANTABILITY AND FITNESS FOR A PARTICULAR PURPOSE. 3M SHALL NOT BE LIABLE FOR ANY DAMAGES, DIRECT, CONSEQUENTIAL, OR INCIDENTAL, ARISING OUT OF THE USE OR INABILITY TO USE THIS PRODUCT.

**Important:** The above warranty shall be void if the customer fails to operate product in accordance with 3M's written instructions. This warranty gives you specific legal rights, and you may have other rights which vary from state to state.

**FCC STATEMENT - CLASS A:** This equipment generates, uses and can radiate radio frequency energy, and if not installed and used in accordance with the instruction manual, may cause interference to radio communications. It has been tested and found to comply with the limits for a Class "A" computing device pursuant to Subpart B of Part 15 of the FCC Rules, which are designed to provide reasonable protection against such interference when operated in a commercial environment. Operation of this equipment in a residential area is likely to cause interference, in which case the user at his/her own expense will be required to take whatever measures may be required to correct the interference.

**FCC STATEMENT - CLASS B:** This equipment generates, uses and can radiate radio frequency energy and, if not installed and used in accordance with the instructions, may cause harmful interference to radio communications. However, there is no guarantee that interference will not occur in a particular installation. If this equipment does cause harmful interference to radio or television reception, which can be determined by turning the equipment off and on, the user is encouraged to try to correct the interference by one or more of the following measures:

- Reorient or relocate the receiving antenna.
- Increase the separation between the equipment and receiver.
- Connect the equipment into an outlet on a circuit different from that to which the receiver is connected.
- Consult the dealer or an experienced radio/TV technician for help.

**EEC STATEMENT:** This machine was tested against the 89/336/EEC (European Economic Community) for EMC (Electro Magnetic Compatibility) and fulfills these requirements.

**Video Signal Cables:** Double shielded coaxial cables (FCC shield cable) must be used, and the outer shield must be connected to the ground. If normal coaxial cables are used, the cable must be enclosed in metal pipes or in a similar way to reduce the interference noise radiation.

**Video Inputs:** The input signal amplitude must not exceed the specified level.

## Patents, Trademarks & Copyrights

IBM is a registered trademark of **International Business Machines Corporation**. **Apple Macintosh** and **Apple Powerbook** are registered trademarks of **Apple Computer, Inc.** **Microsoft** and **Windows 95** and **Windows 98** are registered trademarks, and **Windows** and **Windows for Workgroups** are trademarks of the **Microsoft Corporation**. **Toshiba** is a registered trademark of **Toshiba Corporation**. All other products are trademarks or registered trademarks of their respective companies.

## Section 1: Unpack

### Contents of Shipping Box

The 3M™ MP7640 Multimedia Projector is shipped with the necessary cables required for standard VCR, PC, Macintosh™ or laptop computer connections. Carefully unpack and verify that you have all of the items shown below. If any of these items are missing, please contact your place of purchase.

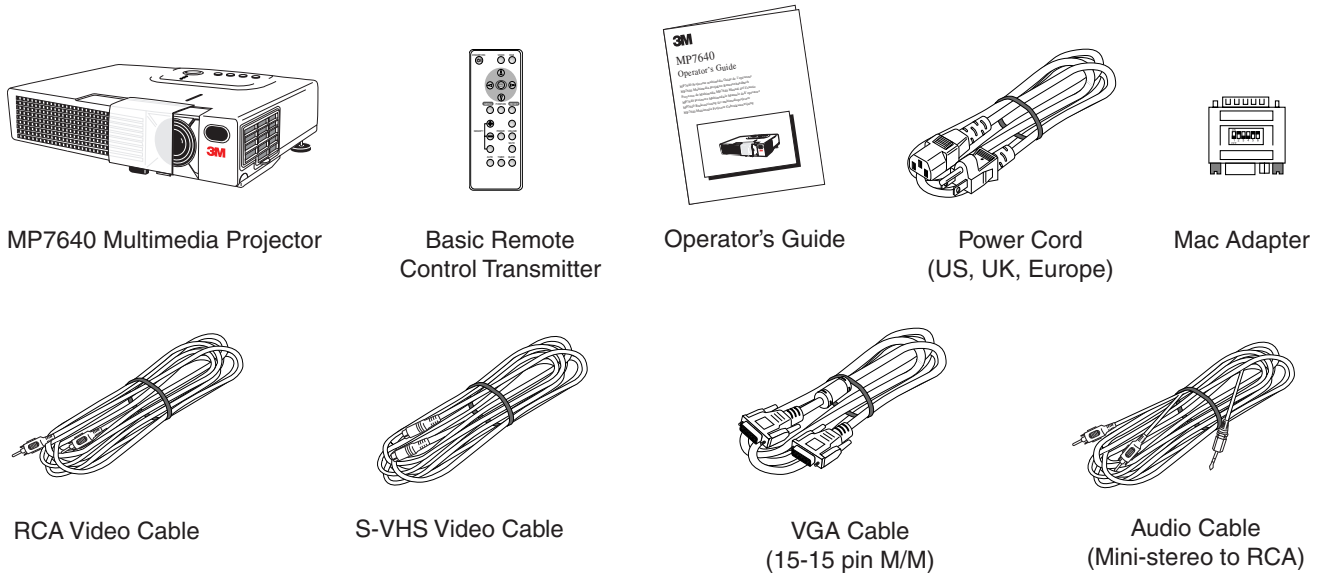

Figure 1.1 Inventory of Shipping Box

### Optional Accessories

- RS-232 control cable ..... (1)
- Deluxe remote control transmitter ..... (1)
- Remote control mouse unit ..... (1)
- Carrying case ..... (1)

### Keep Your Packing Materials

✓ *Note: Save the shipping box and packing materials in the event the MP7640 should require shipping to a 3M Service Center for repair.*

### What's Next?

After you have unpacked the MP7640 system and identified all the parts, you are ready to set up the projector. Please read this guide thoroughly before operating your new projector.

Be sure to check our web site ([www.3m.com/meetings](http://www.3m.com/meetings)) regularly for updates and supplemental information.

## Section 2: Product Description

### Machine Characteristics

The MP7640 Multimedia Projector integrates ultra-high bright lamp and polysilicon LCD display technology into a single unit. It accepts input from one computer source and two video/audio sources, and projects a bright, super-crisp image. Switching your presentation from a computer input to a video input, then back to a computer input simply requires the push of a button on the remote control keypad or control panel keypad.

The MP7640 Multimedia Projector offers the following features:

- UHB (ultra-high bright) projection lamp
- SVGA resolution (3 separate 800 x 600 LCD panels are used for the R, G and B signals)
- Intelligent XGA scaling (60 Hz and 75 Hz)
- Intelligent VGA scaling
- Compact size, lightweight for portability
- RGB (computer video) output terminal
- Manual zoom and focus functions
- 4x digital magnification
- Easy to set up and use
- Ability to display 16.7 million colors
- One computer input connection
- Two video input connections (composite and S-video compatible)
- Slim, lightweight remote control
- Eight blank-screen colors available
- One built-in speaker (1.0 watt)
- Horizontal and vertical image inverting function
- Horizontal and vertical image position control
- Digital keystone correction
- On-screen menu with nine languages
- Universal power supply
- IR sensor in front and rear for maximum remote control range
- RS-232 control capability
- Color balance control for data/video
- Plug & Play compatible
- Freeze function
- Kensington™ Slot  (Kensington microsaver needed)
- Aspect ratio 16:9, 4:3, or 4:3 small

✓ **Note:** *The MP7640 is one of the brightest personal projectors in the marketplace. The brightness of your machine will vary depending on the ambient room conditions and contrast/brightness settings.*



## Section 2: Product Description

### Part Identification List

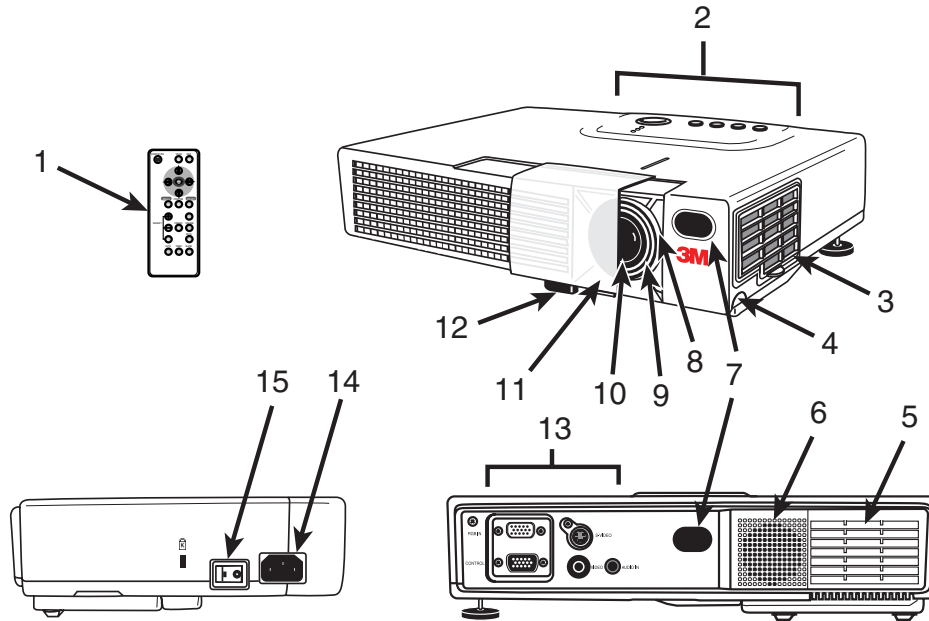

Figure 2.1 Identifying MP7640 Parts

1. Basic remote control transmitter
2. Control panel keypad (see below)
  - a) STANDBY/ON button
  - b) ON, LAMP, TEMP indicators
  - c) INPUT, MUTE, RESET buttons
  - d) MENU disk button
3. Air filter cover
4. Height adjustment foot lock button
5. Cooling fan exhaust
6. Stereo speaker
7. Remote control sensors
8. Zoom knob
9. Focus ring
10. Projection lens
11. Sliding lens door
12. Height adjustment foot
13. Terminal connection panels
  - a) S-Video, Video, Audio input
  - b) RGB input
  - c) RGB output
14. AC power cord connection
15. Main power switch

### Control Panel Keypad Buttons

The control panel keypad is located on top of the projector.

- Press the Standby/On button to turn the projector off and on.
- Press the Input button to select the source of the signal to be displayed onscreen. The type of signal will be displayed at the bottom right of the screen.
- Press the Mute button to turn the audio output off and on.
- Press the Reset button to return the projector to its default settings.
- Press the Menu disk pad button to access on-screen menus and select items. (For more information on this feature, see page 16.)

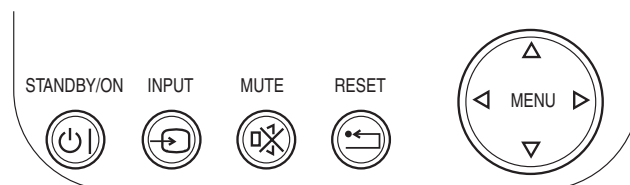

## Section 2: Product Description

### System Setup—Connecting to Various Equipment

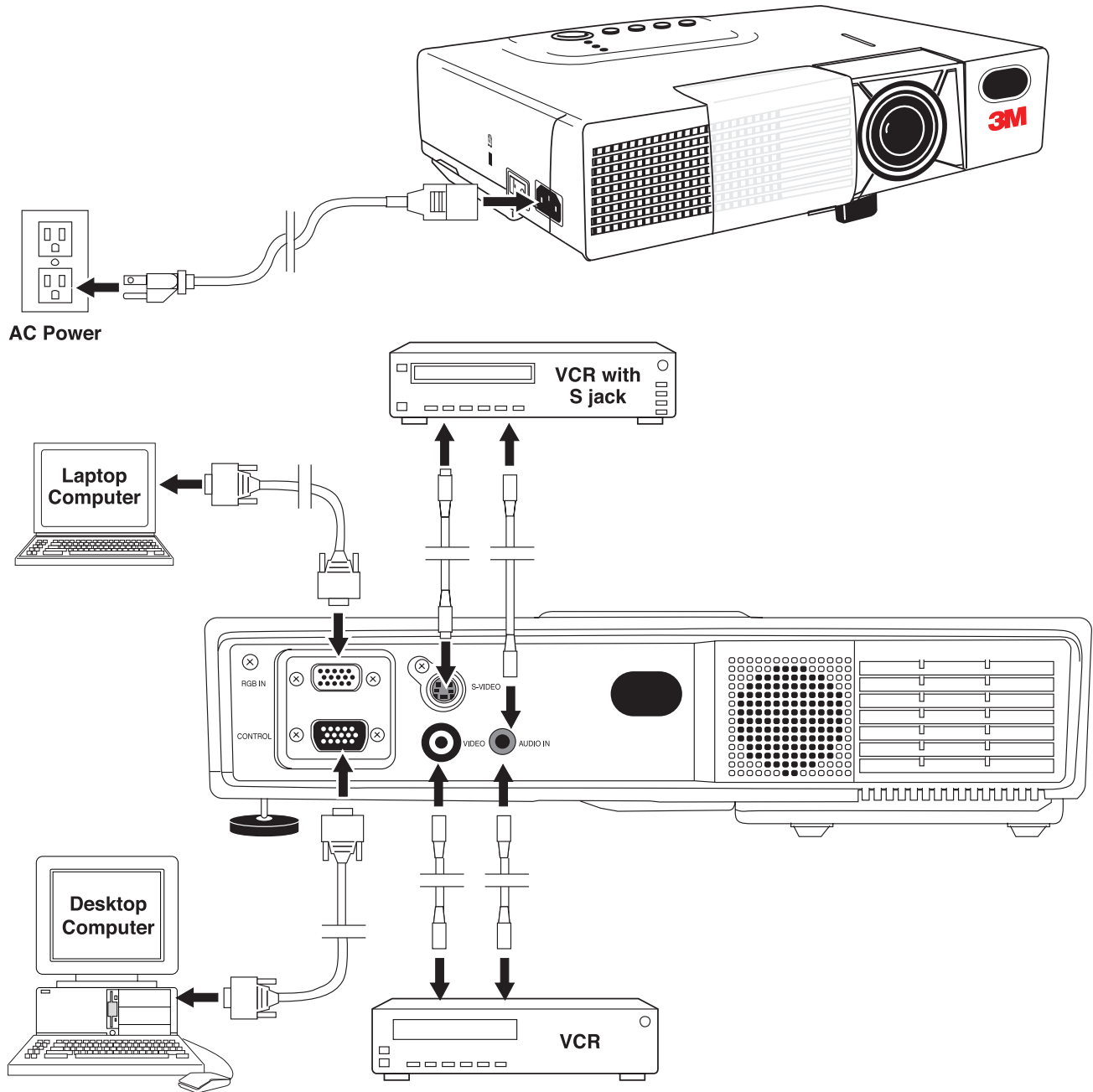

Figure 2.2 Cable Connections



#### Caution

Turn power off to all devices before making connections. Never plug anything into the projector or computer while any device is in operation.

The MP7640 must be powered down when making connections. The mouse emulation may not work if the unit is not powered down before the mouse cable connections are made.

## Section 2: Product Description

### Remote Control Transmitter Identification

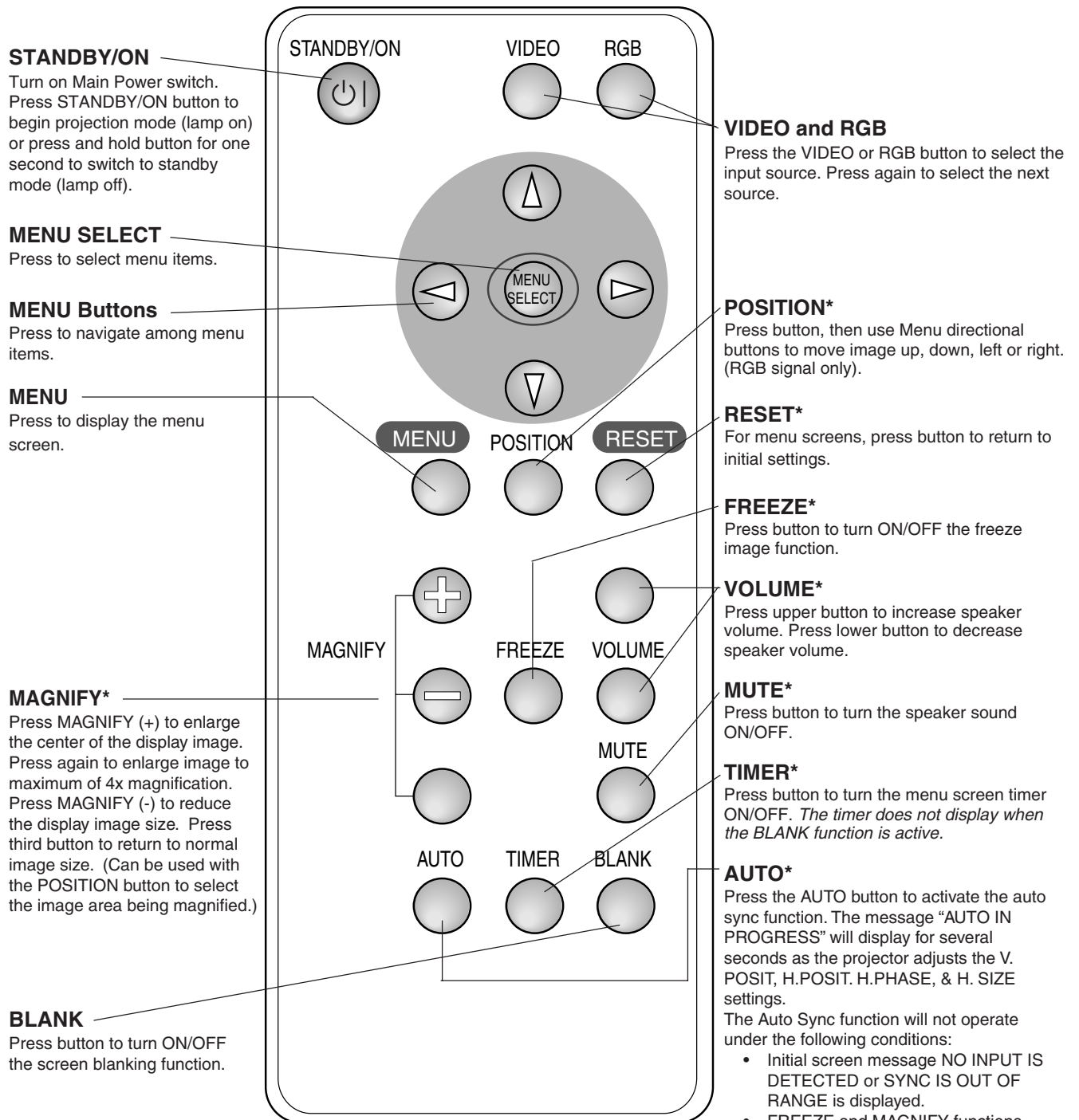

*\*This button will not function if the messages "NO INPUT IS DETECTED" or "SYNC IS OUT OF RANGE" are displayed.*

Figure 2.3 Basic Remote Control Transmitter

## Section 2: Product Description

### Changing Remote Control Battery



#### Caution

This battery contains lithium. Consult your local hazardous waste regulations and dispose of this battery in the proper manner.

This remote control transmitter uses a lithium battery located in a sliding holder inserted into the bottom of the transmitter.

1. Turn the remote control transmitter over to access the battery holder.
2. Push the smaller tab inward as indicated below.
3. Slide the battery holder out of the bottom of the transmitter.
4. Lift the battery out of the holder and replace with the new battery. Make sure the “+” side is facing up.
5. Slide the holder back into the transmitter until the tabs snap into place.



#### Caution

- Avoid excessive heat and humidity.
- Do not mix old and new batteries or different types of batteries.

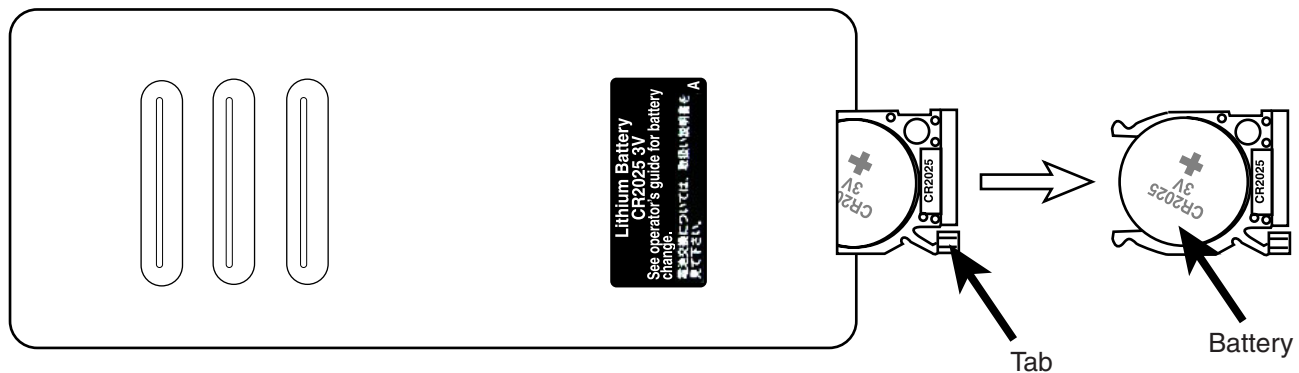

## Section 3: Basic Operations

### Projector Start-up

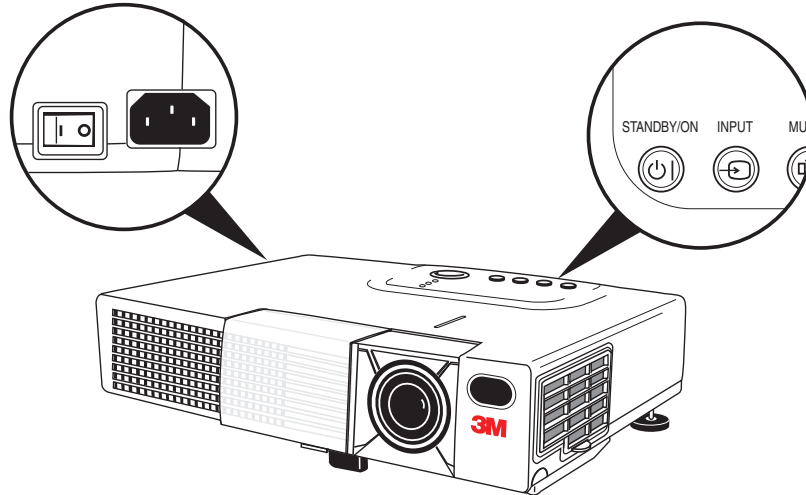







Figure 3.1 Projector Controls

1. Make all equipment and cable connections with the power off.
2. **Turn on the MAIN POWER SWITCH**  of the projector. The ON indicator will light up orange.
3. **Press the STANDBY/ON button** . The ON indicator will blink green during warm-up and lamp ignition, then stay green to indicate correct operation. When power is turned off, there is a 60-second reset period before the STANDBY/ON button will function again.
4. **Turn on all connected equipment.** (Refer to “System Set-up—Connecting to Various Equipment,” page 10.)
5. Open sliding lens door.
6. Press the INPUT button  on the projector or the INPUT SELECT (VIDEO or RGB) button on the remote control transmitter to select the source of the signal to be projected on the screen. The selected signal input is displayed at the bottom right of the screen. The display will show the last selected input source before power was turned off.
7. Adjust picture size using the projection lens Zoom knob. Adjust focus using the projection lens Focus ring.

### Projector Shutdown

1. **Press and hold the STANDBY/ON button**  **for one second.** The ON indicator blinks orange and the lamp turns off. After approximately one minute, the fan stops and the indicator stays orange.
2. Turn off the **MAIN POWER SWITCH**. 
3. Close the sliding lens door.



#### Caution

Do not turn off the POWER SWITCH before pressing the STANDBY/ON button. After the STANDBY/ON button is pressed, the fan rotates for about one minute to cool the projector.

## Section 4: Adjustments and Functions

### How to Use Height Adjustment Foot

Adjust the image elevation and projection angle (within 0 to 10°) using the height adjustment foot at the front of the projector.

1. Raise the front end of the projector so the foot is not touching the tabletop.
2. Push the lock button on the left side of the projector to unlock the foot.
3. Extend or retract the foot to the desired height.
4. Release the lock button to lock the foot into position.
5. For finer adjustment, rotate the tilt adjustment knob on the left rear foot of the projector.



**Caution** Do not unlock the foot adjuster if the projector is not supported.

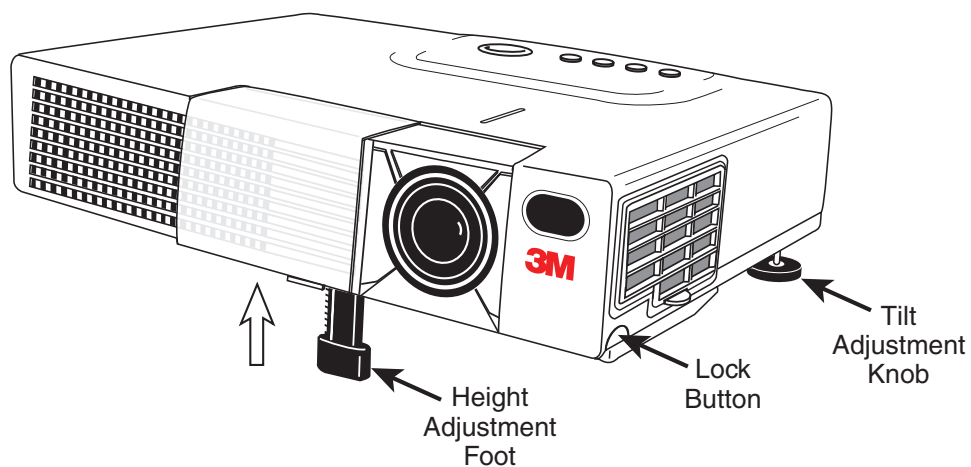

Figure 4.1 Height Adjustment

## Section 4: Adjustments and Functions

### Plug & Play Function

Plug & Play is a system configured with peripheral equipment (including a computer and display), and a compatible operating system. This allows the user to connect various peripheral equipment successfully without having to adjust settings manually. The equipment and projector exchange this information automatically. This projector is VESA DDC (Display Data Channel) 1/2B compatible. Plug & Play is possible by connecting to a computer that is VESA DDC compatible.

✓ **Note:** *Use the RGB cable included with this projector when using plug & play. With other cables, pins (12) - (15) are sometimes not connected (effective only for RGB1).*

### Freeze Function

The Freeze function is used to display (freeze) a single frame of the image being projected. This function can be used with the Magnify function to freeze the image and then enlarge (magnify) part of the image to view it in greater detail. Press the FREEZE button repeatedly to engage or disengage this function.

✓ **Note:** *The FREEZE function will turn off during the operation of the MENU, FOCUS, VOLUME, MUTE, BLANK, TIMER, AUTO or POSITION functions.*

### Magnify Function

The Magnify function is used to enlarge a portion of the projected image. Press the MAGNIFY (+) button to magnify the center of the displayed image. Press again to magnify up to 4x. Press the MAGNIFY (-) button to reduce image size. Press OFF to return to normal image size. To move the display area being magnified, press the POSITION button, then use the DISC PAD to move the magnified area up, down, left or right.

✓ **Note:** *To return to normal display, press the MAGNIFY OFF button. The MAGNIFY function will turn off during the operation of the KEYSTONE or AUTO functions.*

## Section 4: Adjustments and Functions

### Menu Navigation

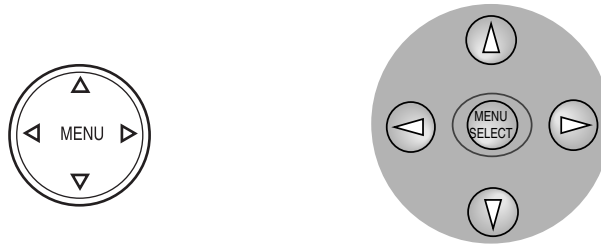









Figure 4.2 Menu disk button on projector and Menu buttons from remote control transmitter

1. **Press MENU disk button on projector or remote control MENU buttons.**  
On-screen menus are displayed on the projected image.
  2. **Select the menu to be adjusted using the MENU disk button or remote control Menu buttons**  .
  3. **Select the menu item to be adjusted using the MENU disk button or any of the remote control Menu buttons**    .
- Highlighted items may be adjusted.
- ✓ **Note:** *Separate settings are provided for the VIDEO and RGB input terminals. Adjustments are saved after shutdown.*

Press MENU SELECT on the remote control to view the full menu or just the selected menu item. When only the selected menu item is displayed, the other menu items are displayed by pressing the   buttons.



### Factory Default Setting:

To reset a single item from SETUP menu:

1. Select the adjustment item (Bright, Contrast...).
2. Press the RESET button. **Only the selected item resets.**

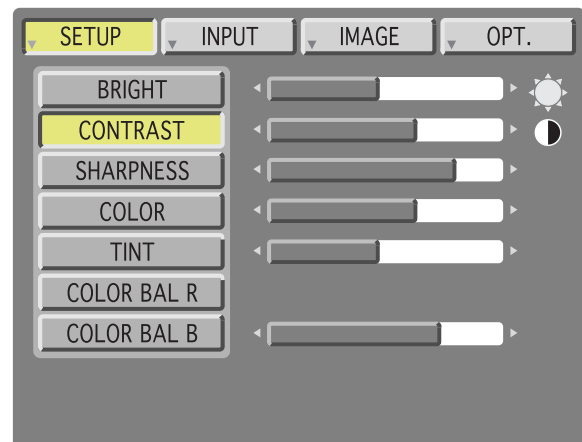

Figure 4.3 Default Settings



## Section 4: Adjustments and Functions

### SETUP Submenu

The SETUP sub-menu is used to adjust and move the image position. The projector will display either the RGB (Figure 4.4) or Video (Figure 4.5) submenu, according to the input source being projected.

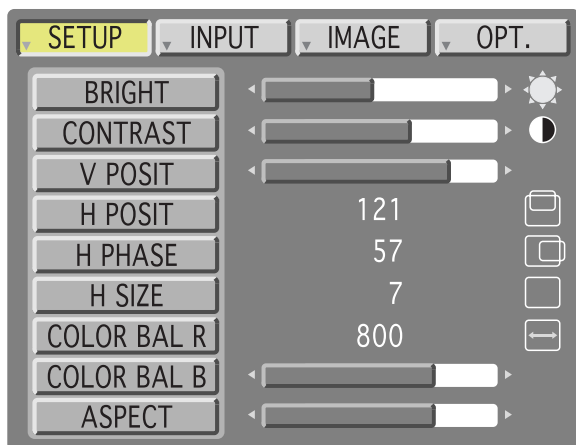

Figure 4.4 RGB signal input

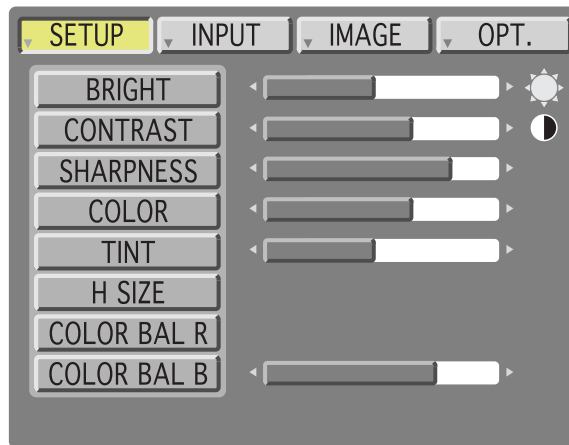

Figure 4.5 Video signal input

Adjustment Item	Details of Adjustment	Freeze On	Magnify On	Both On
<b>BRIGHT (BRIGHTNESS)</b>	Dark ← → Bright	Adjustable	Adjustable	Adjustable
<b>CONTRAST</b>	Lower ← → Higher	Adjustable	Adjustable	Adjustable
<b>V.POSIT (V.POSITION)</b>	Moves the picture up or down.*	Not Adjustable	Not Adjustable	Not Adjustable
<b>H.POSIT (H.POSITION)</b>	Moves the picture left or right.*	Not Adjustable	Not Adjustable	Not Adjustable
<b>H.PHASE</b>	Decreases the picture flicker.*	Not Adjustable	Adjustable	Not Adjustable
<b>H.SIZE</b>	Widens or Narrows the horizontal size of picture.*	Not Adjustable	Not Adjustable	Not Adjustable
<b>SHARPNESS</b>	Soft ← → Sharp	Not Adjustable	Adjustable	Not Adjustable
<b>TINT</b>	Red ← → Green	Not Adjustable	Adjustable	Not Adjustable
<b>COLOR</b>	Less ← → More	Not Adjustable	Adjustable	Not Adjustable
<b>COLOR BAL R</b>	Less red ← → More red	Adjustable	Adjustable	Adjustable
<b>COLOR BAL B</b>	Less blue ← → More blue	Adjustable	Adjustable	Adjustable
<b>ASPECT</b>	4:3, 4:3 small, 16:9	Not Adjustable	Not Adjustable	Not Adjustable

**\*Auto Sync Function:** Press the AUTO button on the remote control to engage the automatic sync function. The message “AUTO IN PROGRESS” will display for several seconds as the projector adjusts the V. POSIT, H.POSIT., H.PHASE, and H. SIZE settings. Auto Sync can also be executed from the control panel key pad. Press and hold the RESET button, then press the INPUT button.

✓ **Note:**

- *TINT cannot be adjusted with a PAL or M-PAL video signal input.*
- *TINT, COLOR, and SHARPNESS cannot be adjusted with an RGB signal input.*
- *V. POSIT, H. POSIT, H. PHASE, and H. SIZE cannot be adjusted with a VIDEO signal input.*
- *Menu operation is not possible during Freeze functions.*
- *Displaying the SETUP submenu will cancel the Magnify and Freeze functions.*

## Section 4: Adjustments and Functions

### INPUT Submenu

The INPUT submenu is used to select the RGB or video input source. The RGB values are shown in Figure 4.6. The Video values are shown in Figure 4.7.

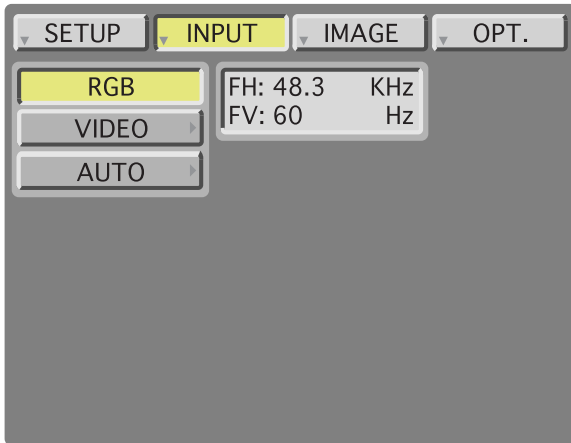

Figure 4.6 RGB Input Submenu

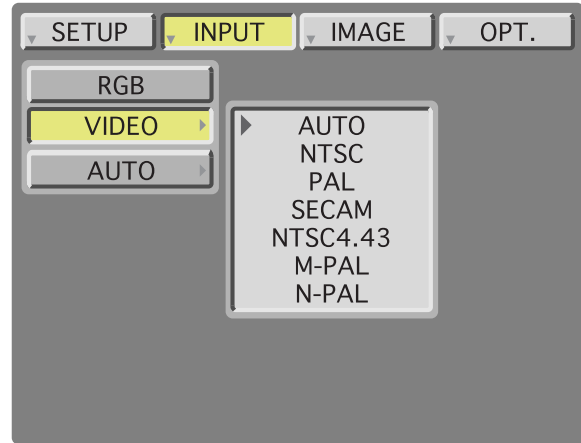

Figure 4.7 Video Input Submenu

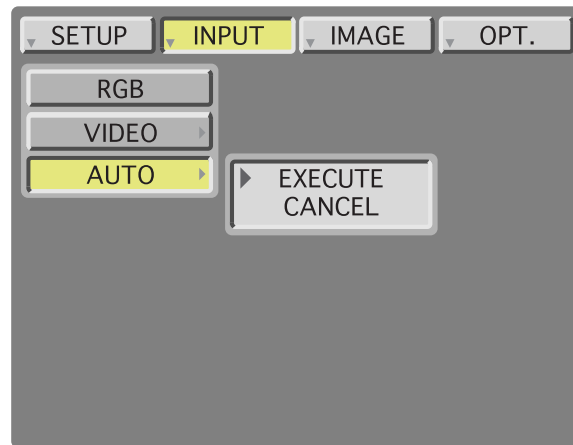

Figure 4.8 Auto Input Submenu

Adjustment Area	Value
RGB	Displays the following RGB inputs: FH: horizontal sync frequency FV: vertical sync frequency
Video	Selects the VIDEO signal format Auto, NTSC, PAL, SECAM, NTSC 4.43, M-PAL, N-PAL
Auto	Selects EXECUTE or CANCEL for Auto signal input detection.

## Section 4: Adjustments and Functions

### IMAGE Submenu

The IMAGE submenu is used to change the image characteristics.

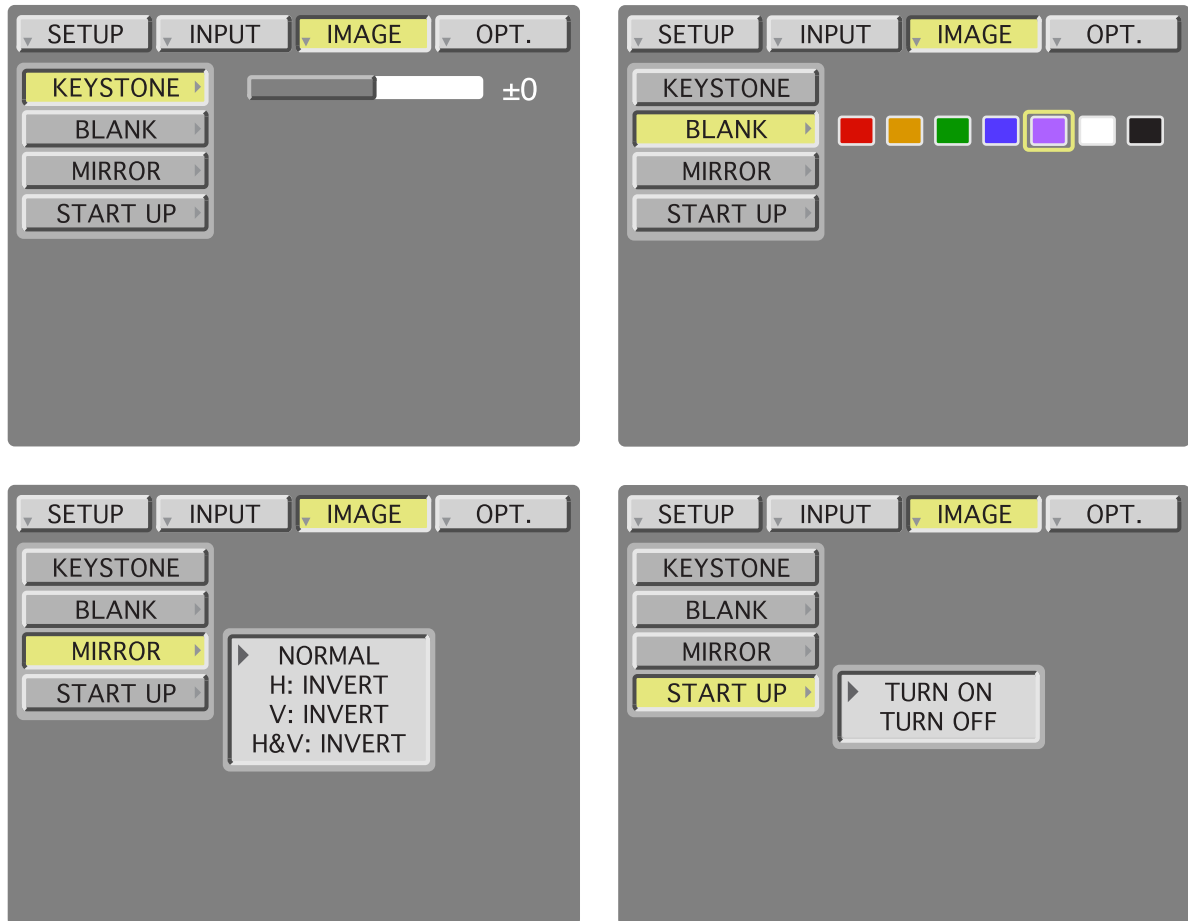

Figure 4.9 Image Adjustment Screens

Adjustment Screen	Value
<b>KEystone</b>	Reduce distortion at bottom of image. $\longleftrightarrow$ Reduce distortion at top of image.
<b>BLANK</b>	Selects the blank screen color: red, orange, green, blue, purple, white or black.
<b>MIRROR</b>	Inverts the picture horizontally or vertically. H: INVERT Inverts the picture horizontally. V: INVERT Inverts the picture vertically. H&V: INVERT Inverts the picture horizontally and vertically.
<b>STARTUP</b>	Enable / Disable startup screen. When canceled, the background color will change to blue.

## Section 4: Adjustments and Functions

### OPT. Submenu

The OPT. submenu allows you to control communication function.

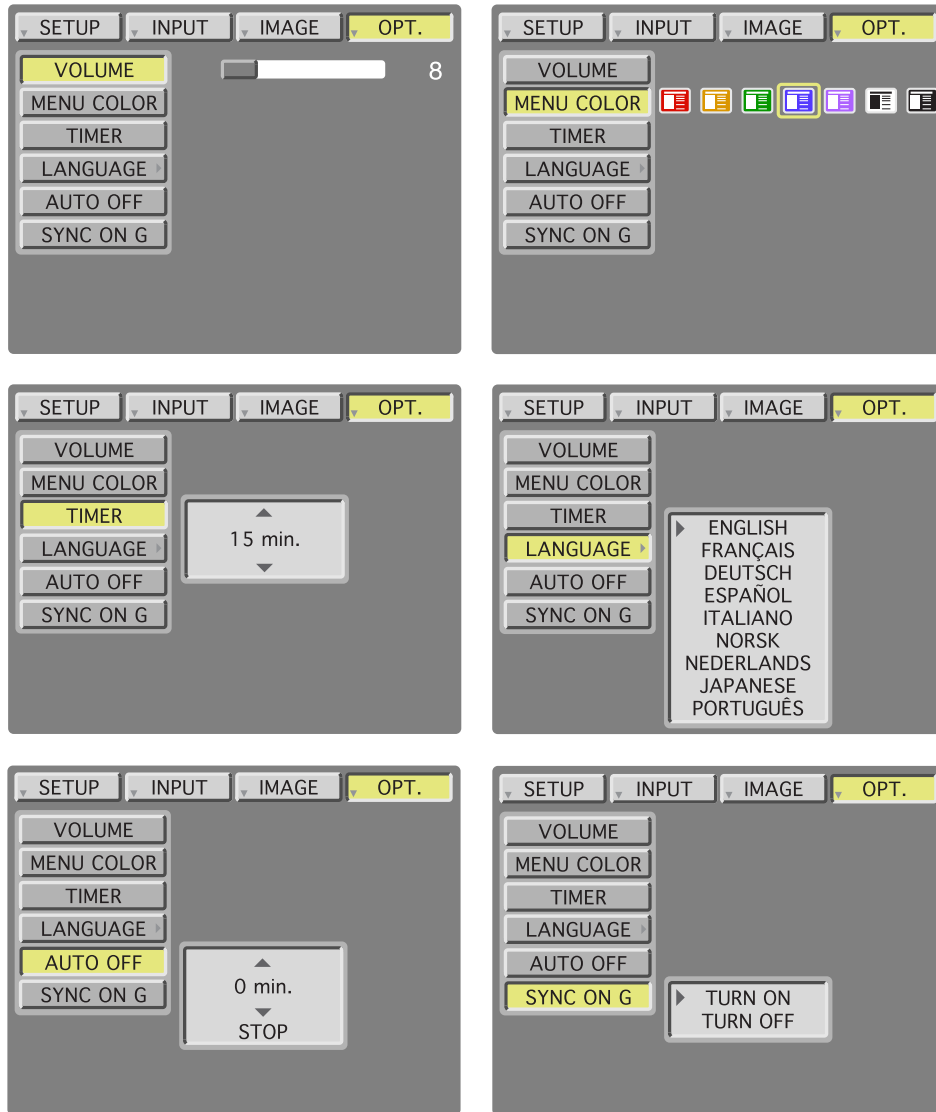

Figure 4.10 OPT Adjustment Screens

Adjustment Screen	Value	Default
<b>VOLUME</b>	Adjusts the loudness of audio coming through the speaker.	8
<b>MENU COLOR</b>	Selects the background color in which the menu system will be displayed. Choice of red, orange, green, blue, purple, white and black. (All menus have white text except white menu, which will have black.)	Blue
<b>TIMER</b>	Sets the timer ( 0-15 minutes).	—
<b>LANGUAGE</b>	Selects the language on-screen menu. (English, French, German, Spanish, Italian, Norwegian, Netherlands, Japanese, and Portuguese)	—
<b>AUTO OFF</b>	Selects how long projector will stay on in minutes, if no input is detected. Select 0 to disable this function.	—
<b>SYNC ON G</b>	Sets the SYNC on G function to ON/OFF (for older Apple computers).	—

## Section 5: Maintenance

### Cleaning the Air Filter

✓ **Note:** Clean the air filter about every 50 hours or if the message “CHECK AIR FLOW” is displayed on the screen. If air is restricted due to dust accumulation on filter, the projector may overheat and shut down automatically.

1. Turn off the **MAIN POWER** switch of the projector and pull out power cord. Let cool for 20 minutes.
2. Push tab up slightly and lift the air filter cover upward and outward to remove it.
3. Vacuum dust and dirt from filter, then place it back in the air filter cover.
4. Replace the air filter cover by inserting the plastic teeth of the air filter cover into their slots and swinging the door back down until the tab snaps into place.

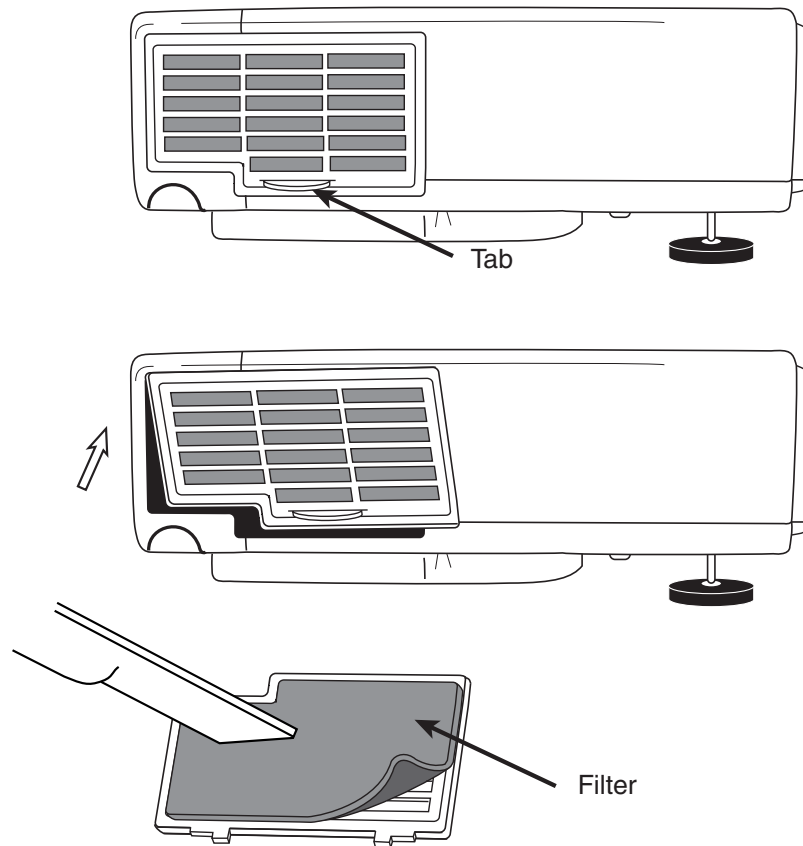

Figure 5.1 Remove Air Filter

## Section 6: Lamp

### Lamp

The following symptoms may indicate that the lamp needs to be replaced:

- LAMP indicator lights up red.
- “CHANGE THE LAMP” message appears on the screen.

### Display Lamp Operation Hours

To determine the lamp operation hours:

1. While the projector is running, press and hold the TIMER button on the remote control for three seconds.
2. The operating time of the lamp will be displayed at the bottom of the screen. The message “CHANGE THE LAMP, AFTER REPLACING LAMP RESET THE LAMP TIMER” will appear after the lamp has reached the end of the normal lamp life. The message “POWER WILL TURN OFF AFTER 20 HOURS” will appear when 20 or less lamp hours remain. The number of hours left until shutdown will decrease until 0 hour is reached, then power will turn off automatically.

✓ **Note:** *After normal lamp operating time has expired, the projector will only run for 10-minute intervals when restarted until the lamp is replaced and the lamp timer is reset. The message “CHANGE THE LAMP” will blink at projector start-up to remind you to change the lamp.*

### Reset Lamp Hours

The lamp operation hours must be reset after changing the lamp. When the lamp has been replaced after the LAMP indicator is red, or the CHANGE THE LAMP message displayed, you must complete the following within 10 minutes after switching on the power. Otherwise, the power will automatically shut down after 10 minutes.

1. To display the total lamp hours, press the RESET button on the projector or the Timer button on the remote control and hold for three seconds. The “LAMP xxxx hr” message will display at the bottom of the screen.
2. To reset the lamp timer, press the RESET button on the projector or MENU button on the remote while the lamp hours are displayed. The lamp hour reset message will display. Use the left-arrow button on the remote control or the Menu diskpad of the projector to select 0, and wait until the timer display has cleared.

## Section 6: Lamp

### Replacing the Lamp



#### WARNING

To reduce the risk of electrical shock, always turn off projector and disconnect power cord before changing lamp.

✓ **Note:** For maximum lamp life, do not shock, handle or scratch the lamp glass when it is hot. Do not use an old or previously used lamp as a replacement lamp.

1. **Remove lamp access door:** The lamp access door is located on the bottom of the machine. Use a screwdriver to loosen the lamp access door retaining screw, gently remove the door, and set it aside.

2. Use a screwdriver to loosen the lamp module retaining screw.

✓ **Note:** These screws are self-containing screws that cannot be removed from the lamp module or access door.

3. **Remove lamp module:** Carefully slide the lamp module out by pulling straight up on the retaining wire on top of the module.

4. **Insert lamp module:** Carefully insert the new lamp module by sliding it straight down into the opening. Ensure that it is fully seated. Tighten the lamp module retaining screw to secure the lamp module in place.

5. Insert the hinge tabs on the bottom of the lamp access door, close, and tighten the retaining screw to secure the door.

✓ **Note:** Reset the lamp operation hours. See the previous page for details.

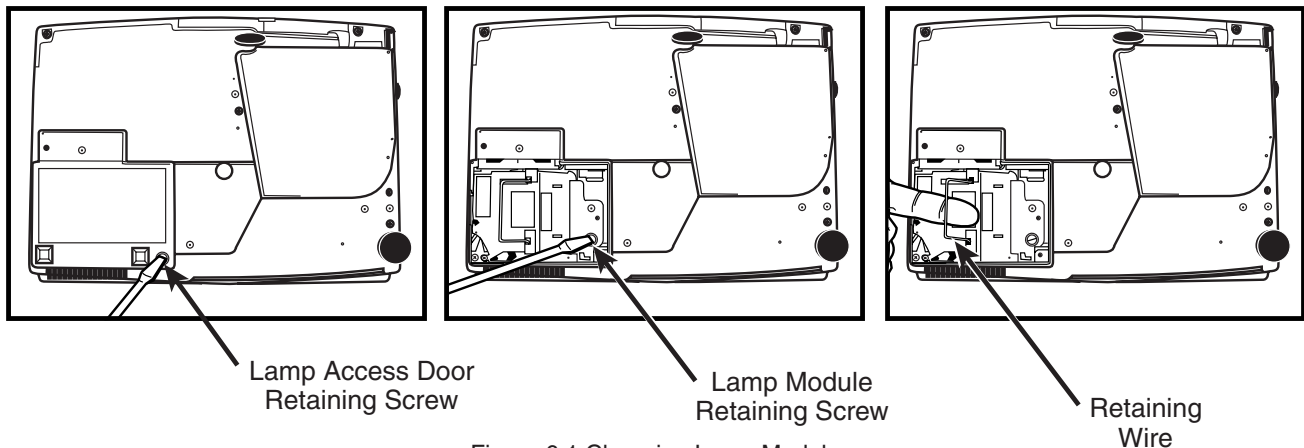

#### Caution

This lamp contains mercury. Consult your local hazardous waste regulations and dispose of this lamp in the proper manner.

## Section 7: Troubleshooting

### Symptoms/Solutions

Symptom	Cause	Solution
Power cannot be turned on.	<ul style="list-style-type: none"> <li>• MAIN POWER switch is not turned on.</li> <li>• The power cord is disconnected.</li> <li>• 60 seconds have not elapsed since the power was turned off.</li> </ul>	<ul style="list-style-type: none"> <li>• Turn the MAIN POWER switch on.</li> <li>• Insert the power cord into an AC socket.</li> <li>• Wait 60 seconds before turning on power.</li> </ul>
No picture or sound.	<ul style="list-style-type: none"> <li>• The setting of the input source is not correct.</li> <li>• RGB/Video/Audio wiring to projector is not correct.</li> </ul>	<ul style="list-style-type: none"> <li>• Set the correct input using the input select button of the projector or the remote control.</li> <li>• Connect the cable to correct input/output source.</li> </ul>
Sound is heard without picture.	<ul style="list-style-type: none"> <li>• RGB/Video/Audio wiring to projector is not correct.</li> <li>• The brightness is set fully to dark.</li> <li>• Lens cap is on.</li> </ul>	<ul style="list-style-type: none"> <li>• Connect the cable to correct input/output source.</li> <li>• Press the MENU button and increase BRIGHTNESS.</li> <li>• Remove lens cap.</li> </ul>
Picture is displayed without sound.	<ul style="list-style-type: none"> <li>• Audio wiring to projector is not correct.</li> <li>• The volume is set to minimum.</li> <li>• The volume is muted.</li> </ul>	<ul style="list-style-type: none"> <li>• Connect the cable to correct input/output source.</li> <li>• Press the VOL button to increase Volume.</li> <li>• Press the MUTE button.</li> </ul>
Color is weak and tint is incorrect.	<ul style="list-style-type: none"> <li>• The color and tint have been adjusted incorrectly.</li> </ul>	<ul style="list-style-type: none"> <li>• Adjust the color and tint correctly.</li> </ul>
Picture is dark.	<ul style="list-style-type: none"> <li>• The brightness and contrast has not been adjusted correctly.</li> <li>• The lamp needs to be replaced.</li> </ul>	<ul style="list-style-type: none"> <li>• Adjust the brightness and contrast correctly.</li> <li>• Replace the lamp with a new one.</li> </ul>
Picture is not clear.	<ul style="list-style-type: none"> <li>• Projector is out of focus.</li> </ul>	<ul style="list-style-type: none"> <li>• Adjust the focus and H. PHASE.</li> </ul>
LAMP indicator lights red.	<ul style="list-style-type: none"> <li>• Lamp will not ignite.</li> <li>• Temperature inside projector is too hot.</li> </ul>	<ul style="list-style-type: none"> <li>• Turn off power and let cool for 20 minutes, then restart.</li> <li>• If problem persists call your dealer.</li> <li>• Check and clear blocked ventilation holes.</li> <li>• Check and clean air filter.</li> </ul>
LAMP indicator blinks red.	<ul style="list-style-type: none"> <li>• Lamp access door on bottom of case is open.</li> <li>• The lamp usage has reached maximum operating hours.</li> </ul>	<ul style="list-style-type: none"> <li>• Ensure lamp access door is closed.</li> <li>• Replace the lamp.</li> </ul>
TEMP indicator blinks red.	<ul style="list-style-type: none"> <li>• Cooling fan not operating.</li> </ul>	<ul style="list-style-type: none"> <li>• Contact your dealer.</li> </ul>

### Messages/Solutions

Error Message Displays	Cause	Solution
NO INPUT IS DETECTED.	The projector is not detecting a signal.	Check cable connections to input device. If input device not connected to this input mode, switch to next mode.
SYNC IS OUT OF RANGE.	The horizontal frequency of input signal exceeds projector capability.	Switch projector to correct resolution. See Appendix.
CHANGE THE LAMP. AFTER REPLACING LAMP, RESET THE LAMP TIME.	Nearing end of normal lamp operating time.	Change the projector lamp and reset the lamp operation hours to zero.
CHANGE THE LAMP. AFTER REPLACING LAMP, RESET THE LAMP TIME. THE POWER WILL TURN OFF AFTER * HR.	Remaining lamp operation time = 20 hours or less. *Indicates number of hours until power turns off automatically.	Change the projection lamp and reset the lamp operation hours to zero.
CHANGE THE LAMP. (blinking)	Normal lamp operating time has expired. Safety feature shuts projector down after 10 minutes.	Change the projector lamp and reset the lamp operation hours to zero.



## Section 7: Troubleshooting

### Indicator Lights

POWER Indicator Light	LAMP Indicator Light	TEMP Indicator Light	Meaning
Lights orange	Turns off	Turns off	Standby status
Blinks green	Turns off	Turns off	Warming up. Wait.
Lights green.	Turns off.	Turns off.	Operation status.
Blinks orange.	Turns off.	Turns off.	Cool down.
Lights red.	Lights red.	Turns off.	The lamp does not light. Wait approx. 20 minutes before turning on power again. If indicator still lights, the lamp may have failed. Replace lamp.
Lights red.	Blinks red.	Turns off.	A lamp has not been inserted or the lamp cover is missing. Turn off projector, disconnect power and wait 45 minutes for projector and lamp to fully cool. Replace lamp and/or lamp cover door, then re-connect power and turn on projector again.
Lights red.	Turns off.	Lights red.	Internal overheating. Turn off projector, disconnect power, and let cool for 20 minutes. Check to see if air filter or ventilation openings are blocked. Clear any obstructions.

## Section 7: Troubleshooting

### Service Information

For product information, product assistance, service information, or to order accessories, please call:

- In U.S. or Canada: **1-800-328-1371**
- In other locations, contact your local 3M sales office.

## Section 8: Accessories

### Accessories

	<b>Part Number</b>
UHB lamp module, 130 W	78-6969-9205-2
Power cord (US)	DY-0205-1356-9
Power cord (UK)	DY-0205-1355-1
Power cord (Germany)	DY-0205-1354-4
VGA cable	78-8118-3401-5
MAC adapter	26-1011-3308-2
S-video cable	78-8118-3238-1
3-conductor video/audio cable	78-8118-3234-1
Stereo mini jack cable	78-8118-8290-7
Remote Control	TBD

### Not Included with Basic Packet

	<b>Part Number</b>
Ceiling mount	78-6969-9206-0
Adjustable height suspension	78-6969-8312-7
Shipping case	78-6969-9204-5
Soft carry case	78-6969-9203-7
RS-232 control cable	78-8118-3312-4
USB mouse cable	78-8118-8186-7
Deluxe Mouse Emulation Kit	78-6969-9233-4

### How to Order

Please order these parts through your dealer, or contact 3M Customer Service at the following number:

- In U.S. or Canada: **1-800-328-1371**
- In other locations, contact your 3M sales office.

The contents of this manual are subject to revision without prior notice.

3M assumes no responsibility for the infringement of special rights of a third party or other rights that may arise out of the information contained in this manual.

Reproduction of this manual in any form without prior permission is strictly prohibited.

3M will replace the manual if any pages are missing or collated incorrectly.

## Section 9: Appendix

### Technical Specifications

Product name	Liquid crystal projector
Model	CP-S220W
Liquid Crystal Panel	
Panel size	1.8 cm (0.7 type)
Drive System	TFT active matrix
Pixels	485,616 pixels (604 horizontal x 804 vertical)
Lens	Zoom lens F = 2.0 ~ 2.3 f = 18 ~ 21
Lamp	130W UHB
Speaker	0.7 W
Power supply	AC100 ~ 120V, 2.0 A / AC220 ~ 240V, 0.9A
Power consumption	200 W
Temperature Range	0 ~ 35°C (32 ~ 95°F) operating
Size	289 mm (11.37 in.) W x 76 mm (2.99 in.) H x 210 mm (8.26 in.) D
Weight	2.38 kg (5.24 lbs.) or less
Input Signal	
RGB	Video: Analog 0.7 Vp-p, 75W terminator (positive) H/V. sync.: TTL level (positive/negative) Compound sync.: TTL level D-sub 15-pin shrink jack
Video	1.0Vp-p, 75W terminator, RCA jack
S-Video	Brightness signal: 1.0Vp-p, 75W terminator Color signal: 0.286Vp-p (burst signal), 75W terminator Mini DIN 4-pin jack
Audio	200 mVrms, 47 kW or less (max. 3.0 Vp-p) Stereo mini jack (Speaker output is L/R mixed.)
Control Signal	D-sub 15-pin shrink jack

# Section 9: Appendix

## Technical Specifications

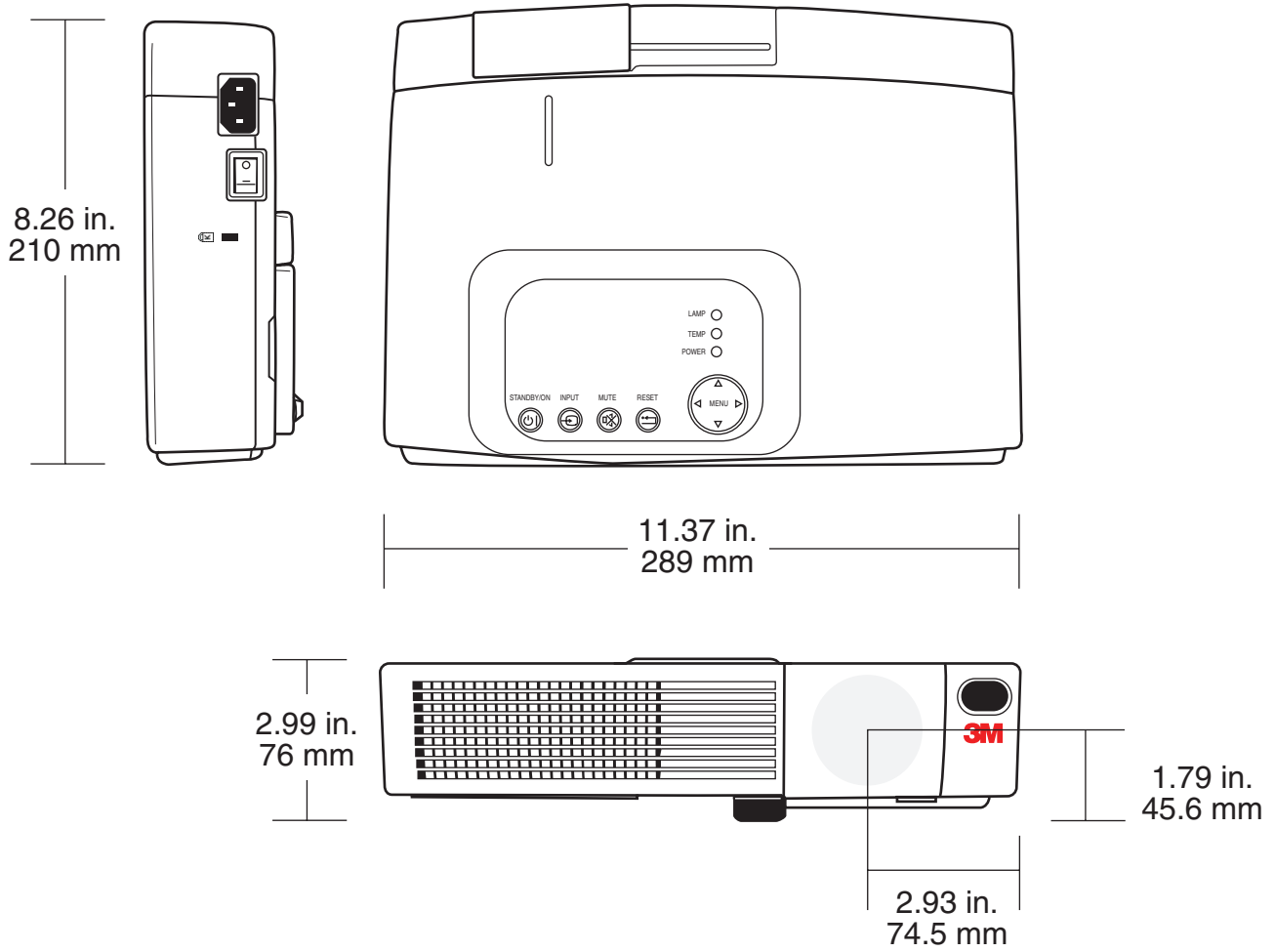

## Section 9: Appendix

### Connection to the Video Signal Terminal

a) Input signal	S-VIDEO Signal		Luminance Signal	1.0Vp-p, 75 $\Omega$ termination
			Chrominance Signal	0.286Vp-p (burst signal), 75 $\Omega$ termination
	VIDEO Signal		1.0Vp-p, 75 $\Omega$ termination	
AUDIO Signal	Input	200mVrms, 20 k $\Omega$ below (MAX 3.0Vp-p)		
	Output	0~200mVrms, 1 k $\Omega$		

b) Signal input terminal

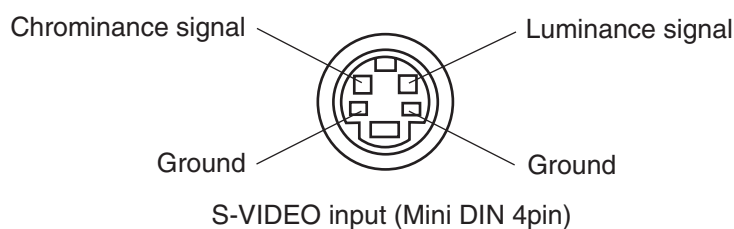

✓ **Note: Video input signal terminals have priority in the following order:**

**1. S-VIDEO input terminal**

**2. RCA jack (composite) input terminal**

**Audio sound from input devices is output to the RGB/Video out jack.**

### Connection to the RGB Signal Terminal

a) Input signal / Output signal

Video Signal		Analog 0.7Vp-p 75 $\Omega$ termination (Positive polarity)
Horizontal sync signal		TTL level (Positive/negative polarity)
Vertical sync signal		TTL level (Positive/negative polarity)
Composite sync signal		TTL level
Audio signal	Input	200mVrms, 20 k $\Omega$ below (MAX 3.0Vp-p)
	Output	0~200 mVrms, 1 k $\Omega$

b) Signal input terminal / output terminal

1	Video signal (Red)	9	No Connection
2	Video signal (Green)	10	Ground
3	Video signal (Blue)	11	No Connection
4	No Connection	12	SDA (DDC 1/2B)
5	No Connection	13	Horizontal/Composite sync signal
6	Ground (for R)	14	Vertical sync signal
7	Ground (for G)	15	SCL (DDC 1/2B)
8	Ground (for B)		

## Section 9: Appendix

### c) Example of computer signal

Resolution H x V	fH (kHz)	fV (Hz)	Rating	Signal mode	Display mode	Note 1
640 x 350	37.9	85.1	VESA	VGA-1	Zoom in	
640 x 400	37.9	85.1	VESA	VGA-2	Zoom in	
720 x 400	37.9	85.0	VESA	TEXT	Zoom in	
640 x 480	31.5	59.9	VESA	VGA-3	Zoom in	
640 x 480	35.0	66.7		Mac 13" mode	Zoom in	SW 1 ON SW 2 ON
640 x 480	37.9	72.8	VESA	VGA-3 (72 Hz)	Zoom in	
640 x 480	37.5	75.0	VESA	VGA-3 (75 Hz)	Zoom in	
640 x 480	43.3	85.0	VESA	VGA-3 (85 Hz)	Zoom in	
800 x 600	35.2	56.3	VESA	SVGA (56 Hz)		
800 x 600	37.9	60.3	VESA	SVGA (60 Hz)		
800 x 600	48.1	72.2	VESA	SVGA (72 Hz)		
800 x 600	46.9	75.0	VESA	SVGA (75 Hz)		
800 x 600	53.7	85.1	VESA	SVGA (85 Hz)		
832 x 624	49.7	74.5		Mac 16: mode	Zoom out	SW 2 ON SW 4 ON
1024 x 768	48.4	60.0	VESA	XGA (60 Hz)	Zoom out	
1024 x 768	56.5	70.1	VESA	XGA (70 Hz)	Zoom out	
1024 x 768	60.0	75.0	VESA	XGA (75 Hz)	Zoom out	

- ✓ **Note 1:** *MAC adapter is necessary to set the resolution mode.  
Projector is compatible with 13-inch mode and 16-inch mode.  
Set all dip switches OFF except those indicated below.*

*MAC 13" mode = switches 1 and 2 are ON  
MAC 16" mode = switches 2 and 4 are ON*

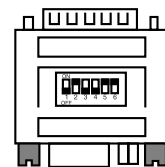

(Example of 16" mode)

- ✓ **Note 2:** *Some input sources may not be displayed properly because they are not compatible with the projector.*

## Section 9: Appendix

### RS-232C Communication

1. Turn off the projector and computer power supplies and connect with the RS-232C cable.
2. Turn on the computer power supply and, after the computer has started up, turn on the projector power supply.

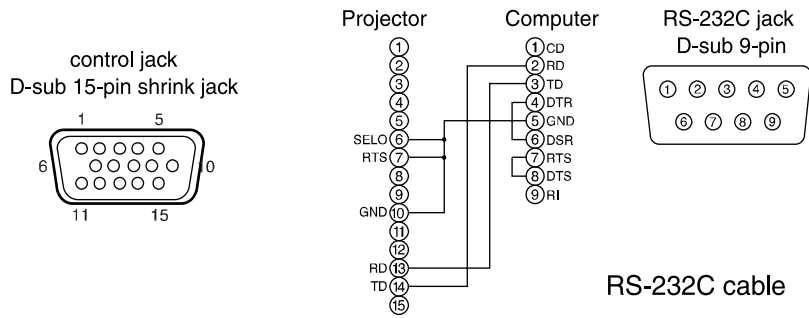

### Communications Setting

19200 bps, 8N1

#### 1 Protocol

Consist of header (6 bytes) + command data (6 bytes).

#### 2 Header

BE + EF + 03 + 06 + 00 + CRC\_low + CRC\_high

CRC\_low: Lower byte of CRC flag for command data (6 bytes).

CRC\_high: Upper byte of CRC flag for command data (6 bytes).

#### 3 Command Data

Command data chart

byte_0	byte_1	byte_2	byte_3	byte_4	byte_5
Action		Type		Setting code	
low	high	low	high	low	high

Action (byte\_0 - 1)

Action	Classification	Content
1	SET	Change setting to desired value.
2	GET	Read projector internal setup value.
4	INCREMENT	Increment setup value by 1.
5	DECREMENT	
6	EXECUTE	Run a command.

### Requesting projector status (Get command)

1. Send the request code Header + Command data ('02H' + '00H' + 'xxH' + 'yyH' + '00H') from the computer to the projector.
2. The projector returns the response code '1DH' + data (2 bytes) to the computer.

### Changing the projector settings (Set command)

1. Send the setting code Header + Command data ('01H' + '00H' + 'xxH' + 'yyH' + data) from the computer to the projector.
2. The projector changes the setting based on the above setting code.
3. The projector returns the response code '06H' to the computer.

### Using the projector default settings (Reset command)

1. The computer sends the default setting code Header + Command data ('06H' + '00H' + 'xxH' + 'yyH' + '00H') to the projector.
2. The projector changes the specified setting based to the default value.
3. The projector returns the response code '06H' to the computer.

### Increasing the projector setting value (Increment command)

1. The computer sends the command code ('04H' + '00H' + 'xxH' + 'yyH' + '00H' + '00H') to the projector.
2. The projector increases the setting value on the above setting code.
3. The projector returns the response code '06H' to the computer.

### Decreasing the projector setting value (Decrement command)

1. The computer sends the command code ('05H' + '00H' + 'xxH' + 'yyH' + '00H' + '00H') to the projector.
2. The projector decreases the setting value on the above setting code.
3. The projector returns the response code '06H' to the computer.

### When a command sent by the projector cannot be understood by the computer

When the command sent by the projector cannot be understood, the error command '15H' is returned by the computer. Sometimes the projector ignores RS-232C commands during other works. If the error command '15H' is returned, please send the same command again.

### When data sent by the projector cannot be practiced

When the command sent by the projector cannot be practiced, the error code '1cH' + 'xxxxH' is returned. When the data length is greater than indicated by the data length code, the projector will ignore the excess data code.

Conversely, when the data length is shorter than indicated by the data length code, an error code will be returned to the projector.



#### Caution

- Operation cannot be guaranteed when the projector receives an undefined command or data.
- Provide an interval of at least 40 ms between the response code and any other code.
- The projector outputs test data when the power supply is switched ON, and when the lamp is lit. Ignore this data.
- Commands are not accepted during warm-up.



## Section 9: Appendix

### Command data chart

Names	Operation type		Header			Command data			
						CRC	Action	Type	Setting code
Blank Color	Set	Red	BE EF	03 06	00 00	3B D3	01 00	00 30	00 00
		Orange	BE EF	03 06	00 00	AB D2	01 00	00 30	01 00
		Green	BE EF	03 06	00 00	5B D2	01 00	00 30	02 00
		Blue	BE EF	03 06	00 00	CB D3	01 00	00 30	03 00
		Purple	BE EF	03 06	00 00	FB D1	01 00	00 30	04 00
		White	BE EF	03 06	00 00	6B D0	01 00	00 30	05 00
		Black	BE EF	03 06	00 00	9B D0	01 00	00 30	06 00
	Get	BE EF	03 06	00 00	08 D3	02 00	00 30	00 00	
Mirror	Set	Normal	BE EF	03 06	00 00	C7 D2	01 00	01 30	00 00
		H Inverse	BE EF	03 06	00 00	57 D3	01 00	01 30	01 00
		V Inverse	BE EF	03 06	00 00	A7 D3	01 00	01 30	02 00
		H&V Inverse	BE EF	03 06	00 00	37 D2	01 00	01 30	03 00
	Get	BE EF	03 06	00 00	F4 D2	02 00	01 30	00 00	
Freeze	Set	Normal	BE EF	03 06	00 00	83 D2	01 00	02 30	00 00
		Freeze	BE EF	03 06	00 00	13 D3	01 00	02 30	01 00
	Get	BE EF	03 06	00 00	B0 D2	02 00	02 30	00 00	
Menu Color	Set	Red	BE EF	03 06	00 00	7F D3	01 00	03 30	00 00
		Orange	BE EF	03 06	00 00	EF D2	01 00	03 30	01 00
		Green	BE EF	03 06	00 00	1F D2	01 00	03 30	02 00
		BLUE	BE EF	03 06	00 00	8F D3	01 00	03 30	03 00
		Purple	BE EF	03 06	00 00	BF D1	01 00	03 30	04 00
		Transparent	BE EF	03 06	00 00	2F D0	01 00	03 30	05 00
		Gray	BE EF	03 06	00 00	DF D0	01 00	03 30	06 00
	Get	BE EF	03 06	00 00	4C D3	02 00	03 30	00 00	
Startup	Set	Turn ON	BE EF	03 06	00 00	0B D2	01 00	04 30	00 00
		Turn OFF	BE EF	03 06	00 00	9B D3	01 00	04 30	01 00
	Get	BE EF	03 06	00 00	38 D2	02 00	04 30	00 00	
Language	Set	English	BE EF	03 06	00 00	F7 D3	01 00	05 30	00 00
		Français	BE EF	03 06	00 00	67 D2	01 00	05 30	01 00
		Deutsch	BE EF	03 06	00 00	97 D2	01 00	05 30	02 00
		Español	BE EF	03 06	00 00	07 D3	01 00	05 30	03 00
		Italiano	BE EF	03 06	00 00	37 D1	01 00	05 30	04 00
		Norsk	BE EF	03 06	00 00	A7 D0	01 00	05 30	05 00
		Nederlands	BE EF	03 06	00 00	57 D0	01 00	05 30	06 00
		Portuguese	BE EF	03 06	00 00	C7 D1	01 00	05 30	07 00
		Japanese	BE EF	03 06	00 00	37 D4	01 00	05 30	08 00
	Get	BE EF	03 06	00 00	C4 D3	02 00	05 30	00 00	

## Section 9: Appendix

### Command data chart

Names	Operation type	Header			Command data				
					CRC	Action	Type	Setting code	
Magnify	Get	BE EF	03	06 00	7C D2	02 00	07 30	00 00	
	Increment	BE EF	03	06 00	1A D2	04 00	07 30	00 00	
	Decrement	BE EF	03	06 00	CB D3	05 00	07 30	00 00	
Timer	Get	BE EF	03	06 00	C8 82	02 00	00 31	00 00	
	Increment	BE EF	03	06 00	AE 82	04 00	00 31	00 00	
	Decrement	BE EF	03	06 00	7F 83	05 00	00 31	00 00	
Auto off	Get	BE EF	03	06 00	C8 72	02 00	00 32	00 00	
	Increment	BE EF	03	06 00	AE 72	04 00	00 32	00 00	
	Decrement	BE EF	03	06 00	7F 73	05 00	00 32	00 00	
Brightness Reset	Execute	BE EF	03	06 00	58 D3	06 00	00 70	00 00	
Contrast Reset	Execute	BE EF	03	06 00	A4 D2	06 00	01 70	00 00	
V.Position Reset	Execute	BE EF	03	06 00	E0 D2	06 00	02 70	00 00	
H.Position Reset	Execute	BE EF	03	06 00	IC D3	06 00	03 70	00 00	
H.Size Reset	Execute	BE EF	03	06 00	68 D2	06 00	04 70	00 00	
Color Balance R Reset	Execute	BE EF	03	06 00	94 D3	06 00	05 70	00 00	
Color Balance B Reset	Execute	BE EF	03	06 00	D0 D3	06 00	06 70	00 00	
Aspect Reset	Execute	BE EF	03	06 00	2C D2	06 00	07 70	00 00	
Video Format Reset	Execute	BE EF	03	06 00	38 D1	06 00	08 70	00 00	
Sharpness Reset	Execute	BE EF	03	06 00	C4 D0	06 00	09 70	00 00	
Color Reset	Execute	BE EF	03	06 00	80 D0	06 00	0A 70	00 00	
Tint Reset	Execute	BE EF	03	06 00	7C D1	06 00	0B 70	00 00	
Keystone Reset	Execute	BE EF	03	06 00	08 D0	06 00	0C 70	00 00	
Mirror Reset	Execute	BE EF	03	06 00	F4 D1	06 00	0D 70	00 00	
Blank Color Reset	Execute	BE EF	03	06 00	B0 D1	06 00	0E 70	00 00	
Startup Reset	Execute	BE EF	03	06 00	4C D0	06 00	0F 70	00 00	
Auto	Execute	BE EF	03	06 00	91 D0	06 00	0A 20	00 00	
Blank on/off	Set	off	BE EF	03	06 00	FB D8	01 00	20 30	00 00
		on	BE EF	03	06 00	6B D9	01 00	20 30	01 00
	Get	BE EF	03	06 00	C8 D8	02 00	20 30	00 00	
Timer on/off	Set	off	BE EF	03	06 00	07 D9	01 00	21 30	00 00
		on	BE EF	03	06 00	97 D8	01 00	21 30	01 00
	Get	BE EF	03	06 00	34 D9	02 00	21 30	00 00	
Error Status	Get	(Example of Return) 00 00    01 00    02 00    03 00 (Normal) (Cover-error) (Fan-error) (Lamp-error)  04 00    05 00    06 00 (Temp-error) (Air flow-error) (Lamp-Time-over)							

**Command data chart**

Names	Operation type		Header			Command data			
						CRC	Action	Type	Setting code
Power Status	Set	OFF	BE EF	03	06 00	2A D3	01 00	00 60	00 00
		ON	BE EF	03	06 00	BA D2	01 00	00 60	01 00
	Get		BE EF	03	06 00	19 D3	02 00	00 60	00 00
Input Source	Set	RGB	BE EF	03	06 00	FE D2	01 00	00 20	00 00
		Video	BE EF	03	06 00	6E D3	01 00	00 20	01 00
		SVideo	BE EF	03	06 00	9E D3	01 00	00 20	02 00
	Get		BE EF	03	06 00	CD D2	02 00	00 20	00 00
Volume	Get		BE EF	03	06 00	31 D3	02 00	01 20	00 00
	Increment		BE EF	03	06 00	57 D3	04 00	01 20	00 00
	Decrement		BE EF	03	06 00	86 D2	05 00	01 20	00 00
Mute	Set	Normal	BE EF	03	06 00	46 D3	01 00	02 20	00 00
		Mute	BE EF	03	06 00	D6 D2	01 00	02 20	01 00
	Get		BE EF	03	06 00	75 D3	02 00	02 20	00 00
Brightness	Get		BE EF	03	06 00	89 D2	02 00	03 20	00 00
	Increment		BE EF	03	06 00	EF D2	04 00	03 20	00 00
	Decrement		BE EF	03	06 00	3E D3	05 00	03 20	00 00
Contrast	Get		BE EF	03	06 00	FD D3	02 00	04 20	00 00
	Increment		BE EF	03	06 00	9B D3	04 00	04 20	00 00
	Decrement		BE EF	03	06 00	4A D2	05 00	04 20	00 00
Color Balance R	Get		BE EF	03	06 00	01 D2	02 00	05 20	00 00
	Increment		BE EF	03	06 00	67 D2	04 00	05 20	00 00
	Decrement		BE EF	03	06 00	B6 D3	05 00	05 20	00 00
Color Balance B	Get		BE EF	03	06 00	45 D2	02 00	06 20	00 00
	Increment		BE EF	03	06 00	23 D2	04 00	06 20	00 00
	Decrement		BE EF	03	06 00	F2 D3	05 00	06 20	00 00
Keystone	Get		BE EF	03	06 00	B9 D3	02 00	07 20	00 00
	Increment		BE EF	03	06 00	DF D3	04 00	07 20	00 00
	Decrement		BE EF	03	06 00	0E D2	05 00	07 20	00 00
Aspect	Set	4:3	BE EF	03	06 00	9E D0	01 00	08 20	00 00
		16:9	BE EF	03	06 00	0E D1	01 00	08 20	01 00
		Small	BE EF	03	06 00	FE D1	01 00	08 20	02 00
	Get		BE EF	03	06 00	AD D0	02 00	08 20	00 00

**Command data chart**

Names	Operation type	Header			Command data				
					CRC	Action	Type		
V.Position	Get	BE EF	03	06 00	0D 83	02 00	00 21	00 00	
	Increment	BE EF	03	06 00	6B 83	04 00	00 21	00 00	
	Decrement	BE EF	03	06 00	BA 82	05 00	00 21	00 00	
H.Position	Get	BE EF	03	06 00	F1 82	02 00	01 21	00 00	
	Increment	BE EF	03	06 00	97 82	04 00	01 21	00 00	
	Decrement	BE EF	03	06 00	46 83	05 00	01 21	00 00	
H.Size	Get	BE EF	03	06 00	B5 82	02 00	02 21	00 00	
	Increment	BE EF	03	06 00	D3 82	04 00	02 21	00 00	
	Decrement	BE EF	03	06 00	02 83	05 00	02 21	00 00	
H.Phase	Get	BE EF	03	06 00	49 83	02 00	03 21	00 00	
	Increment	BE EF	03	06 00	2F 83	04 00	03 21	00 00	
	Decrement	BE EF	03	06 00	FE 82	05 00	03 21	00 00	
Sharpness	Get	BE EF	03	06 00	F1 72	02 00	01 22	00 00	
	Increment	BE EF	03	06 00	97 72	04 00	01 22	00 00	
	Decrement	BE EF	03	06 00	46 73	05 00	01 22	00 00	
Color	Get	BE EF	03	06 00	B5 72	02 00	02 22	00 00	
	Increment	BE EF	03	06 00	D3 72	04 00	02 22	00 00	
	Decrement	BE EF	03	06 00	02 73	05 00	02 22	00 00	
Tint	Get	BE EF	03	06 00	49 73	02 00	03 22	00 00	
	Increment	BE EF	03	06 00	2F 73	04 00	03 22	00 00	
	Decrement	BE EF	03	06 00	FE 72	05 00	03 22	00 00	
Video Format	Set	Auto	BE EF	03	06 00	9E 75	01 00	00 22	0A 00
		NTSC	BE EF	03	06 00	FE 71	01 00	00 22	04 00
		PAL	BE EF	03	06 00	6E 70	01 00	00 22	05 00
		SECAM	BE EF	03	06 00	6E 75	01 00	00 22	09 00
		NTSC 4.43	BE EF	03	06 00	5E 72	01 00	00 22	02 00
		M-PAL	BE EF	03	06 00	FE 74	01 00	00 22	08 00
		N-PAL	BE EF	03	06 00	0E 71	01 00	00 22	07 00
	Get	BE EF	03	06 00	0D 73	02 00	00 22	00 00	







**Important Notice**

All statements, technical information, and recommendations related to 3M's products are based on information believed to be reliable, but the accuracy or completeness is not guaranteed. Before using this product, you must evaluate it and determine if it is suitable for your intended application. You assume all risks and liability associated with such use. Any statements related to the product which are not contained in 3M's current publications, or any contrary statements contained on your purchase order shall have no force or effect unless expressly set forth in a written agreement signed by an authorized officer of 3M.

**Warranty and Limited Remedy.** This product will be free from defects in material and manufacture for a period of two years from the date of purchase. Exclusion to Warranty: The lamps are considered a consumable item and are warranted for 90 days or 180 hours, whichever occurs first. **3M MAKES NO OTHER WARRANTIES, INCLUDING BUT NOT LIMITED TO, ANY IMPLIED WARRANTY OF MERCHANTABILITY OR FITNESS FOR A PARTICULAR PURPOSE.** If this product is defective within the warranty period stated above, your exclusive remedy shall be, at 3M's option, to replace or repair the 3M product or refund the purchase price of the 3M product.

**Limitation of Liability.** Except where prohibited by law, 3M will not be liable for any loss or damage arising from this 3M product, whether direct, indirect, special, incidental or consequential regardless of the legal theory asserted.

Let us help you make the most of your next presentation. We offer everything from presentation supplies to tips for better meetings. And we're the only transparency manufacturer that offers a recycling program for your used transparencies. For late-breaking news, handy reference and free product samples, call us toll-free in the continental United States and Canada, 24 hours a day, or visit our Internet Website.

**800-328-1371****<http://www.3m.com/meetings>  
e-mail: [meetings@mmm.com](mailto:meetings@mmm.com)**

**3M Austin Center**  
Building A145-5N-01  
6801 River Place Blvd.  
Austin, TX 78726-9000

**3M Canada**  
P.O. Box 5757  
London, Ontario  
N6A 4T1

**3M Mexico, S.A. de C.V.**  
Apartado Postal 14-139  
Mexico, D.F. 07000  
Mexico

**3M Europe**  
Boulevard de l'Oise  
95006 Cerge Pontoise Cedex  
France

Litho in USA  
Copyright © 2000 3M IPC.  
All Rights Reserved  
78-6970-9032-8 Rev. A