

Video Projector

Operating Instructions

HDMI[™]
HIGH-DEFINITION MULTIMEDIA INTERFACE

VPL-HS50
VPL-HS51

WARNING

To prevent fire or shock hazard, do not expose the unit to rain or moisture.

To avoid electrical shock, do not open the cabinet. Refer servicing to qualified personnel only.

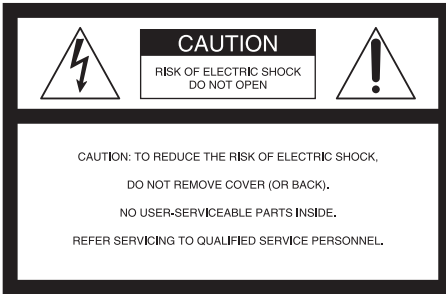

This symbol is intended to alert the user to the presence of uninsulated “dangerous voltage” within the product’s enclosure that may be of sufficient magnitude to constitute a risk of electric shock to persons.



This symbol is intended to alert the user to the presence of important operating and maintenance (servicing) instructions in the literature accompanying the appliance.

For the customers in the USA

If you have any questions about this product, you may call:

Sony Customer Information Service Center
1-800-222-7669 or <http://www.sony.com/>
The number below is for FCC related matters only.

Declaration of Conformity

Trade Name: SONY
Model No.: VPL-HS50/HS51
Responsible Party: Sony Electronics Inc.

Address: 16450 W. Bernardo Dr, San Diego,
CA 92127 U.S.A.
Telephone Number: 858-942-2230

This device complies with Part 15 of the FCC Rules. Operation is subject to the following two conditions: (1) This device may not cause harmful interference, and (2) this device must accept any interference received, including interference that may cause undesired operation.

This equipment has been tested and found to comply with the limits for a Class B digital device, pursuant to Part 15 of the FCC Rules. These limits are designed to provide reasonable protection against harmful interference in a residential installation. This equipment generates, uses, and can radiate radio frequency energy and, if not installed and used in accordance with the instructions, may cause harmful interference to radio communications. However, there is no guarantee that interference will not occur in a particular installation. If this equipment does cause harmful interference to radio or television reception, which can be determined by turning the equipment off and on, the user is encouraged to try to correct the interference by one or more of the following measures:

- Reorient or relocate the receiving antenna.
- Increase the separation between the equipment and receiver.
- Connect the equipment into an outlet on a circuit different from that to which the receiver is connected.
- Consult the dealer or an experienced radio/TV technician for help.

You are cautioned that any changes or modifications not expressly approved in this manual could void your authority to operate this equipment.

This product contains mercury. Disposal of this product may be regulated if sold in the United States. For disposal or recycling information, please contact your local authorities or Electronics Industries Alliance (www.eiae.org).

For the customers in Canada

This Class B digital apparatus complies with Canadian ICES-003.

Voor de klanten in Nederland



Gooi de batterij niet weg maar lever deze in als klein chemisch afval (KCA).

The socket-outlet should be installed near the equipment and be easily accessible.

CAUTION

RISK OF EXPLOSION IF BATTERY IS REPLACED BY AN INCORRECT TYPE.
DISPOSED OF USED BATTERIES ACCORDING TO THE LOCAL RULES.

Table of Contents

Precautions	6
-------------------	---

Connections and Preparations

Unpacking	7
Step 1: Installing the Projector	8
Before Setting Up the Projector ...	9
Installing the Projector and a Screen	10
Step 2: Connecting the Projector	13
Connecting to a DVD Player/ Recorder or Digital Tuner	13
Connecting to Video Equipment	15
Connecting to a Computer	16
Step 3: Adjusting the Picture Size and Position	17
Step 4: Selecting the Menu Language	21

Projecting

Projecting the Picture on the Screen	23
Turning Off the Power	25
Selecting the Wide Screen Mode	26
Selecting the Picture Viewing Mode	29
Adjusting the Picture Quality	30
Adjusting the Picture Using Real Color Processing	32

Using the Menus

Operation through the Menus	34
Picture Menu	37

Signal Menu	40
Function menu	41
Installation Menu	42
Setup Menu	43
Information Menu	44
About the Preset Memory No. ...	44
Adjusting Picture Quality of a Signal from the Computer	45

Others

Troubleshooting	46
Warning Indicators	47
Message Lists	48
Replacing the Lamp	49
Replacing the Air Filter	50
Specifications	52
Input Signals and Adjustable/setting Items	54
Preset Signals	56
Ceiling Installation	58
Location of Controls	61
Front	61
Rear	62
Bottom	63
Remote Control	64
Index	65

Precautions

On safety

- Check that the operating voltage of your unit is identical with the voltage of your local power supply.
- Should any liquid or solid object fall into the cabinet, unplug the unit and have it checked by qualified personnel before operating it further.
- Unplug the unit from the wall outlet if it is not to be used for several days.
- To disconnect the cord, pull it out by the plug. Never pull the cord itself.
- The wall outlet should be near the unit and easily accessible.
- The unit is not disconnected to the AC power source (mains) as long as it is connected to the wall outlet, even if the unit itself has been turned off.
- Do not look into the lens while the lamp is on.
- Do not place your hand or objects near the ventilation holes. The air coming out is hot.

On preventing internal heat build-up

After you turn off the power with the I/⏻ (on/standby) switch, do not disconnect the unit from the wall outlet while the cooling fan is still running.

Caution

The projector is equipped with ventilation holes (intake) and ventilation holes (exhaust). Do not block or place anything near these holes, or internal heat build-up may occur, causing picture degradation or damage to the projector.

On repacking

Save the original shipping carton and packing material; they will come in handy if you ever have to ship your unit. For maximum protection, repack your unit as it was originally packed at the factory.

This manual covers models VPL-HS50 and VPL-HS51.

The illustrations of the projector used in this manual are those of the VPL-HS50 unless the model name is specifically mentioned.

Connections and Preparations

This section describes how to install the projector and screen, how to connect the equipment from which you want to project the picture, etc.

Unpacking

Check the carton to make sure it contains the following items:

- Remote control (1)
- Size AA (R6) batteries (2)
- Air filter (for replacement) (1)

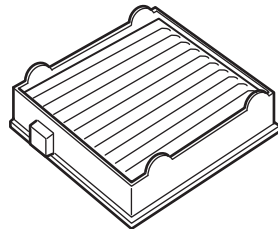
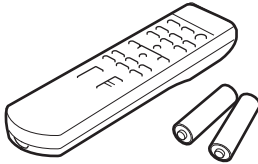

- AC power cord (1)
- CD-ROM (Application software and Operating Instructions) (VPL-HS51 only)
- Operating Instructions (this manual) (1)

Inserting the batteries into the remote control

Insert the batteries **+** side first as shown in the illustration. Inserting them forcibly or with the polarities reversed may cause a short circuit and may generate heat.

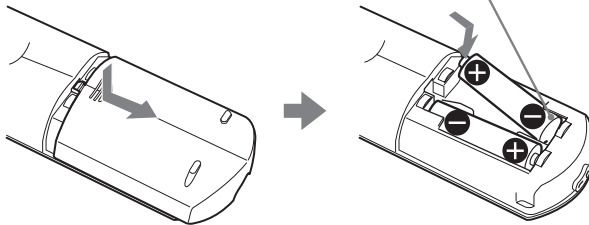

Step 1: Installing the Projector

The projector's lens shift feature allows you to choose a variety of installation locations for your projector. You can enjoy home entertainment with this projector in the following situations.

Enjoying home theater



Watching sports, etc. with your company



Enjoying video games on a large screen



Viewing images shot by a digital video camera on a large screen



Before Setting Up the Projector

Do not place the projector in the following situations, which may cause malfunction or damage to the projector.

Poorly ventilated

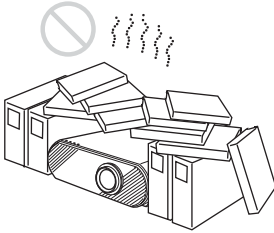

Highly heated and humid

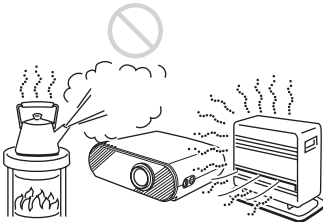

Subject to direct cool or warm air from an air-conditioner

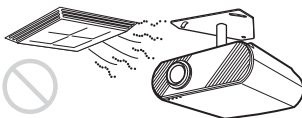

Installing in such a location may cause malfunction of the unit due to moisture condensation or rise in temperature.

Near a heat or smoke sensor

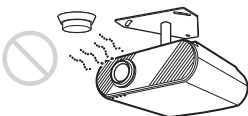

Malfunction of the sensor may be caused.

Very dusty and extremely smoky



Make a special attention to the following while using the projector.

Do not block the ventilation holes.

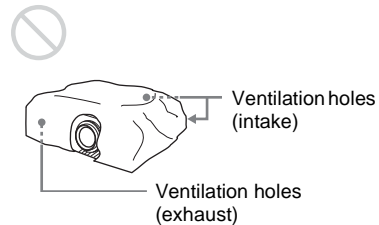

Tip

For details on the location of the ventilation holes (intake or exhaust), see “Location of Controls” on pages 61 to 63.

When installing the unit at altitudes

When using the projector at an altitude of 1,500 m or higher, set “High Altitude Mode” in the Installation menu to “On.” (☞ page 42)

Failing to set this mode when using the projector at high altitudes could have adverse effects, such as reducing the reliability of certain components.

Installing the Projector and a Screen

The installation distance between the projector and a screen varies depending on the size of the screen.

1 Determine the installation position of the projector and screen.

You can obtain a good quality picture if you position the projector with the center of the lens within the areas indicated in the gray areas in the illustration. Use the values a, b, c, d and e in the table on page 11 as a guide.

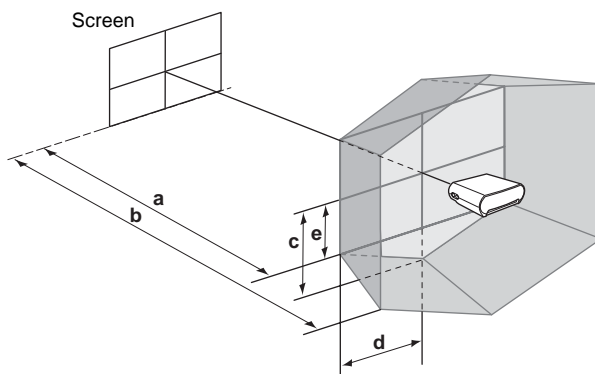

- a:** Minimum projection distance between the screen and the center of the projector's lens
- b:** Maximum projection distance between the screen and the center of the projector's lens
- c:** Vertical distance between the center of the screen and the center of the projector's lens when using the maximum vertical lens shift feature*
- d:** Horizontal distance between the center of the screen and the center of the projector's lens when using the maximum horizontal lens shift feature*
- e:** Maximum vertical distance between the center of the screen and the center of the projector's lens when using both the vertical and horizontal lens shift features with the horizontal lens shift set to the maximum value*

* The distances c, d and e indicated in the illustration show those in the lower or left direction. The same distances in the upper or right direction are appropriate for installation.

For details on the lens shift feature, see “Step 3: Adjusting the Picture Size and Position.” (☞ page 17)

When using the 16:9 aspect ratio screen

Unit: mm (inches)

Screen size (inches)	40	60	80	100	120	150	180	200
a (minimum)	1170 (46 1/8)	1770 (69 3/4)	2380 (93 3/4)	2980 (117 3/8)	3580 (141)	4490 (176 7/8)	5390 (212 1/4)	6000 (236 1/4)
b (maximum)	1790 (70 1/2)	2710 (106 3/4)	3630 (143)	4540 (178 7/8)	5460 (215)	6830 (269)	8210 (323 3/8)	9120 (359 1/8)
c	498 (19 5/8)	747 (29 1/2)	996 (39 1/4)	1245 (49 1/8)	1494 (58 7/8)	1868 (73 5/8)	2241 (88 1/4)	2491 (98 1/8)
d	443 (17 1/2)	664 (26 1/4)	886 (35)	1107 (43 5/8)	1328 (52 3/8)	1660 (65 3/8)	1992 (78 1/2)	2214 (87 1/4)
e	249 (9 7/8)	374 (14 3/4)	498 (19 5/8)	623 (24 5/8)	747 (29 1/2)	934 (36 7/8)	1121 (44 1/4)	1245 (49 1/8)

To calculate the installation measurements (SS: Screen Size)

$$a \text{ (minimum)} = \{(SS \times 21.27/0.7227) - 35.160899\} \times 1.025$$

$$b \text{ (maximum)} = \{(SS \times 33.9409273/0.7227) - 37.678872\} \times 0.975$$

$$c = (SS/0.7227 \times 9)$$

$$d = (SS/0.7227 \times 8)$$

$$e = (SS/0.7227 \times 4.5)$$

When using the 4:3 aspect ratio screen

Unit: mm (inches)

Screen size (inches)	40	60	80	100	120	150	180	200
a (minimum)	1440 (56 3/4)	2180 (85 7/8)	2920 (115)	3660 (114 1/8)	4390 (172 7/8)	5500 (216 5/8)	6610 (260 3/8)	7350 (289 1/2)
b (maximum)	2200 (86 5/8)	3330 (131 1/8)	4450 (175 1/4)	5570 (219 3/8)	6690 (263 1/2)	8370 (329 5/8)	10050 (395 3/4)	11170 (439 7/8)
c	610 (24 1/8)	914 (36)	1219 (48)	1524 (60)	1829 (72 1/8)	2286 (90 1/8)	2743 (108 1/8)	3048 (120 1/16)
d	542 (21 3/8)	813 (32 1/8)	1084 (42 3/4)	1355 (53 3/8)	1626 (64 1/8)	2032 (80 1/16)	2438 (96)	2709 (106 3/4)
e	305 (12 1/8)	457 (18)	610 (24 1/8)	762 (30)	914 (36)	1143 (45)	1372 (54 1/8)	1524 (60)

To calculate the installation measurements (SS: Screen Size)

$$a \text{ (minimum)} = \{(SS \times 21.27/0.5906) - 35.160899\} \times 1.025$$

$$b \text{ (maximum)} = \{(SS \times 33.9409273/0.5906) - 37.678872\} \times 0.975$$

$$c = (SS/0.5906 \times 9)$$

$$d = (SS/0.5906 \times 8)$$

$$e = (SS/0.5906 \times 4.5)$$

2 Position the projector so that the lens is parallel to the screen.

Top view

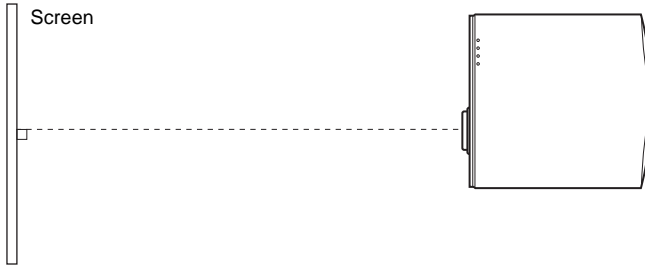

3 Project an image on the screen and adjust the picture so that it fits the screen. (☞ page 17)

To project an image, connect video equipment to the projector. (☞ page 13)

Note

When using a screen with an uneven surface, stripes pattern may rarely appear on the screen depending on the distance between the screen and the projector or the zooming magnifications. This is not a malfunction of the projector.

For installation of the projector on a ceiling, see “Ceiling Installation.” (☞ page 58)

Step 2: Connecting the Projector

When making connections, be sure to do the following:

- Turn off all equipment before making any connections.
- Use the proper cables for each connection.
- Insert the cable plugs properly; plugs that are not fully inserted often generate noise. When pulling out a cable, be sure to pull it out from the plug, not the cable itself.
- Refer to the operating instructions of the connected equipment.

Connecting to a DVD Player/Recorder or Digital Tuner

To connect to a DVD player/recorder or digital tuner equipped with component video connectors

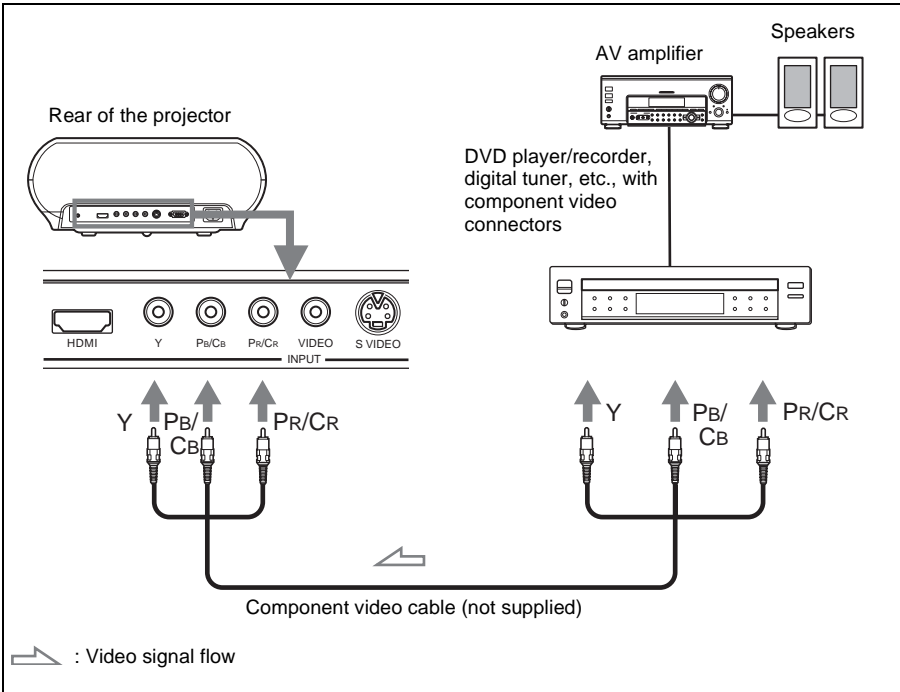

Tip

To connect the projector to a DVD player/recorder, digital tuner, etc. which is not equipped with component video connectors, use the S video cable to connect to the S-video output of the DVD player/recorder, digital tuner, etc. If the connected equipment is not equipped with the S-video output connector, use the video cable to connect to the video output jack on the equipment.

To connect to a DVD player/recorder equipped with HDMI output

You can enjoy better picture quality by connecting a DVD player/recorder equipped with HDMI output to the HDMI input of the projector.

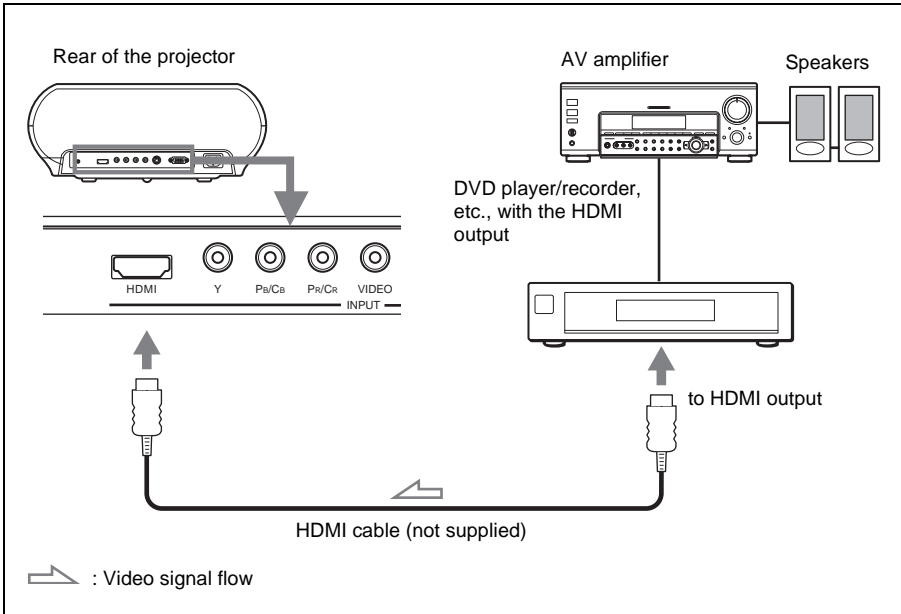

HDMI, HDMI logo and High-Definition Multimedia Interface are trademarks or registered trademarks of HDMI Licensing LLC.

Connecting to Video Equipment

You can connect a DVD player/recorder which is not equipped with component video connectors, hard disk video recorder, VCR or laser disk player. See also the instruction manual of each equipment.

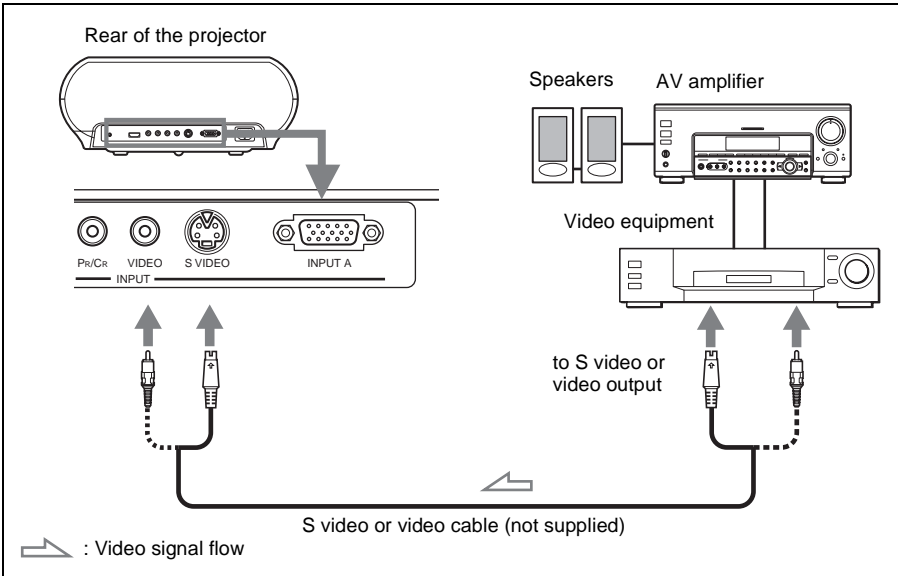

Tip

If you do not know to which connector you should connect the cable, S VIDEO (S video connector) or VIDEO (video connector), connect it to S VIDEO to enjoy better picture quality.

If the equipment to be connected has no S video connector, connect the cable to the video output.

Connecting to a Computer

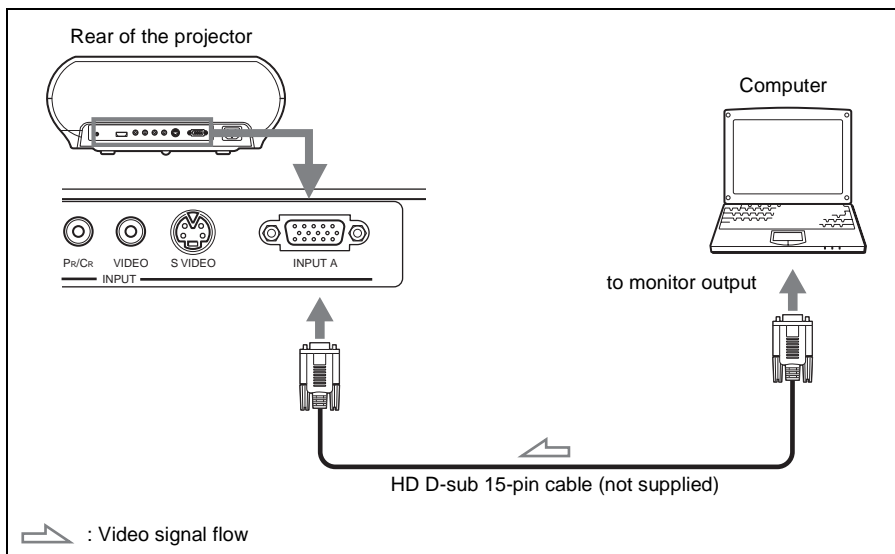

Tip

Set “Input A Signal Sel.” in the Setup  menu to “Auto” or “Computer.” If the input signal does not appear properly, set it to “Computer.”

Note

If you set your computer, such as a notebook type, to output the signal to both your computer’s display and an external monitor, the picture of the external monitor may not appear properly. Set your computer to output the signal to only the external monitor. For details, refer to the computer’s operating instructions supplied with your computer.

Step 3: Adjusting the Picture Size and Position

Project an image on the screen and then adjust the picture position.

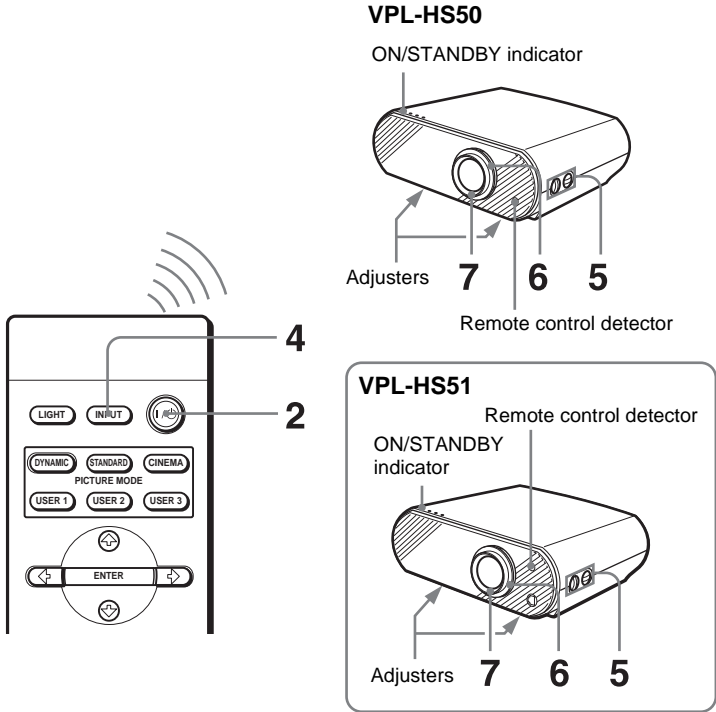

Tip

The I/⏻ (on/standby), INPUT, MENU, and ↑/↓/←/→/ENTER (joystick) buttons on the side panel of the projector function the same as those on the remote control.

Note

Depending on the installation location of the projector, you may not control it with the remote control. In this case, point the remote control to the screen instead of the projector.

1 Plug the AC power cord into a wall outlet.

The ON/STANDBY indicator lights in red and the projector goes into standby mode.



Lights in red.

2 Press the I/⏻ (on/standby) switch to turn on the projector.

The ON/STANDBY indicator lights in green.



Lights in green.

3 Turn on the equipment connected to the projector.

Refer to the operating instructions of the connected equipment.

4 Press INPUT to project the picture on the screen.

Each time you press the button, the input indication changes. (☞ page 24)

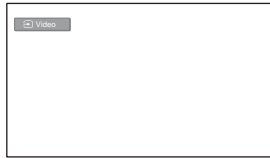

Tip

When “Auto Input Search” is set to “On” in the Function  menu, the channel of the signal input is automatically displayed.

5 Move both LENS SHIFT dials to adjust the picture position.

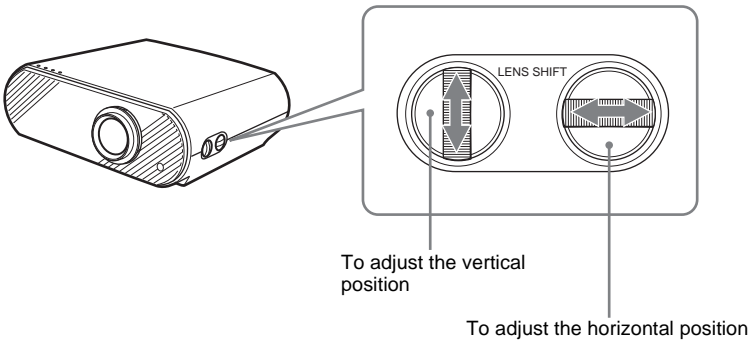

To adjust the horizontal position

Turn the LENS SHIFT dial right or left.

The picture moves right or left by a maximum of half of the screen size from the center of the lens.

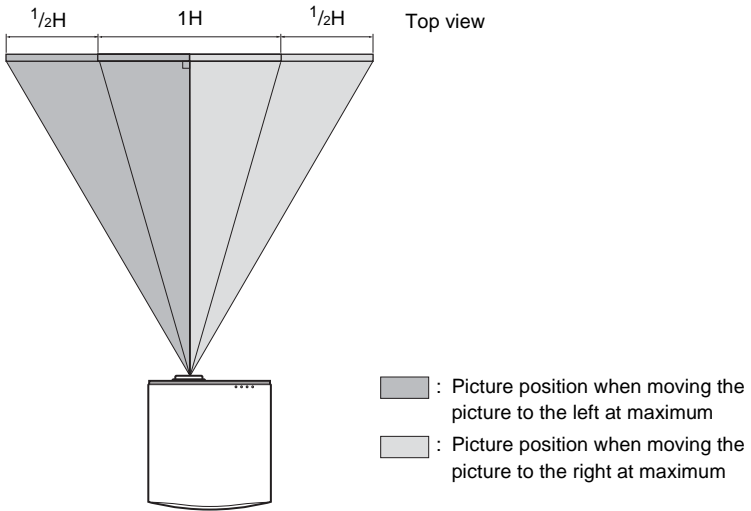

To adjust the vertical position

Turn the LENS SHIFT dial up or down.

The picture moves up or down by a maximum of the screen size from the center of the lens.

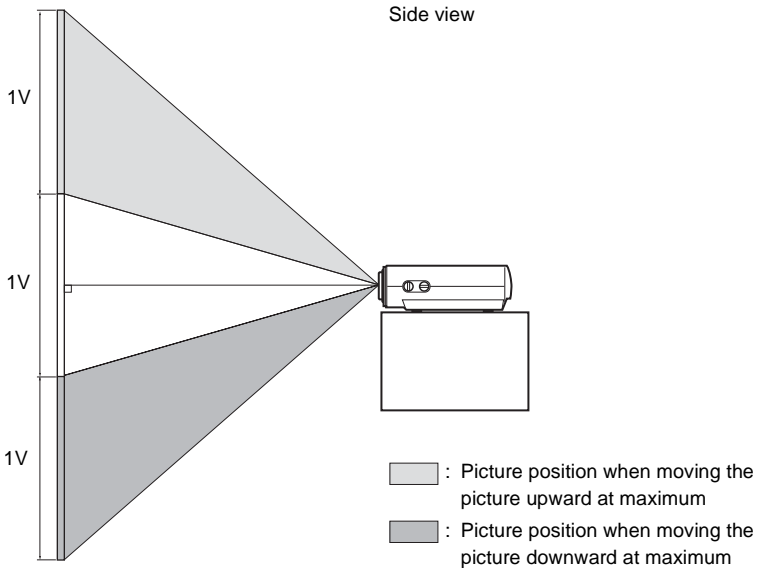

Note

When you use the horizontal and vertical lens shift features at the same time, you can move the picture vertically by a maximum of half of the screen size.

6 Adjust the picture size using the zoom ring.

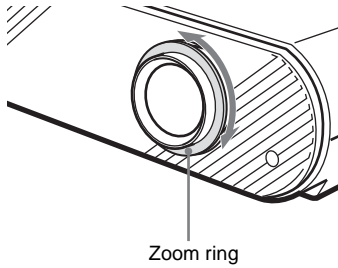

7 Adjust the focus using the focus ring.

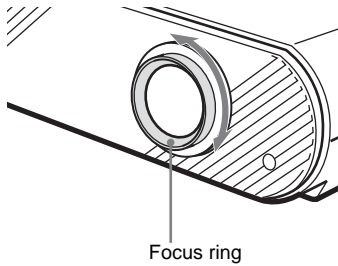

To adjust the tilt of the installation surface

If the projector is installed on an uneven surface, use the adjusters to keep the projector level.

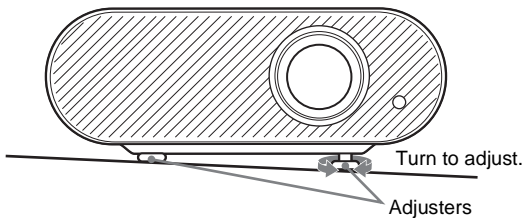

Step 4: Selecting the Menu Language

You can select one of fifteen languages for displaying the menu and other on-screen displays. The factory default setting is English.

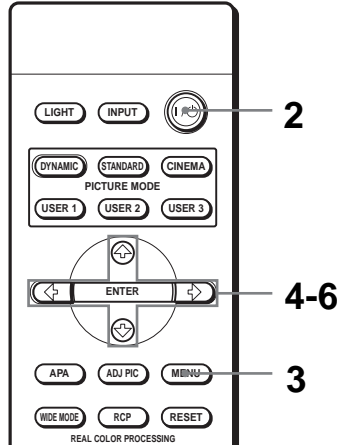

Tip

You can operate the menu using the $\uparrow/\downarrow/\leftarrow/\rightarrow$ (arrow) buttons on the side panel of the projector instead of the $\uparrow/\downarrow/\leftarrow/\rightarrow$ /ENTER buttons on the remote control.

1 Plug the AC power cord into a wall outlet.

The ON/STANDBY indicator lights in red and the projector goes into standby mode.

2 Press the I/ON (on/standby) switch to turn on the projector.

The ON/STANDBY indicator lights in green.

3 Press MENU.

The menu appears.

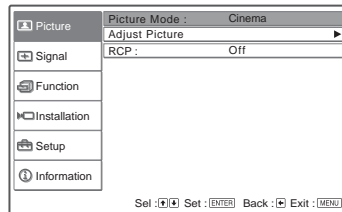

4 Press ↑ or ↓ to select the Setup  menu, and press → or ENTER.

The setting items of the selected menu appears.

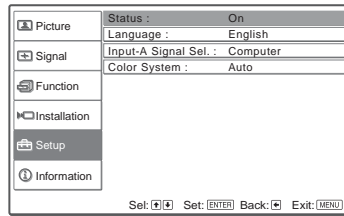
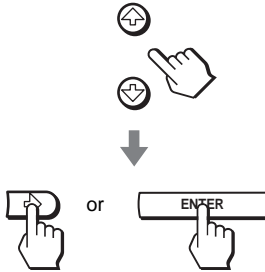

5 Press ↑ or ↓ to select “Language,” and press → or ENTER.

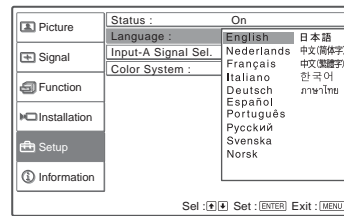
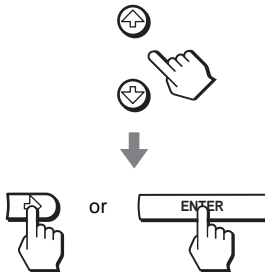

6 Press ↑ or ↓ to select a language, and press ENTER.

The menu changes to the selected language.

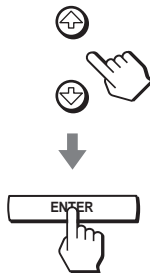

To clear the menu

Press MENU.

Projecting

This section describes how to operate the projector to view the picture from the equipment connected to the projector. It also describes how to adjust the quality of the picture to suit your taste.

Projecting the Picture on the Screen

VPL-HS50

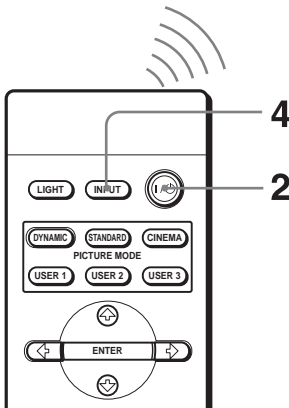
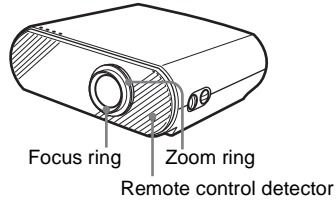

VPL-HS51

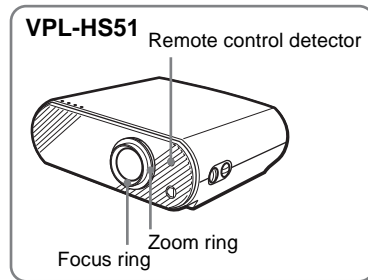

1 Plug the AC power cord into a wall outlet.

The ON/STANDBY indicator lights in red and the projector goes into standby mode.



Lights in red.

2 Press the I/⏻ (on/standby) switch to turn on the projector.

The ON/STANDBY indicator lights in green.



Lights in green.

3 Turn on the equipment connected to the projector.

Refer to the operating instructions of the connected equipment.



4 Press INPUT repeatedly to select the input you want to project on the screen.

Display the indication of the input you want.

Example: To view the picture from the video equipment connected to the VIDEO INPUT jack.



To view the picture from	Press INPUT to display
Video equipment connected to the VIDEO INPUT connector	Video
Video equipment connected to S VIDEO INPUT connector	S-Video
Component equipment connected to Y / PB/CB / PR/CR on the projector	Component
RGB/component equipment connected to the INPUT A connector	Input-A*
Equipment connected to the HDMI connector	HDMI

* Set the “Input-A Signal Sel.” setting in the Setup  menu according to the signal input. When you set it to “Auto,” and cannot display the picture properly, select an appropriate signal with “Input-A Signal Sel.” ( page 43)

Tip

When “Auto Input Search” is set to “On” in the Function  menu, the channel of the input signal is automatically displayed.

5 Turn the zoom ring to adjust the size of the picture.

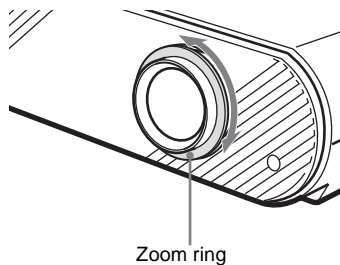

6 Turn the focus ring to adjust the focus.

Adjust to obtain sharp focus.

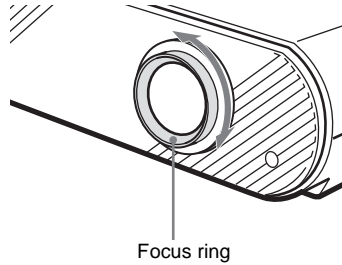

Turning Off the Power

1 Press the I/⏻ (on/standby) switch.

A message “POWER OFF?” appears on the screen.

2 Press the I/⏻ switch again.

The ON/STANDBY indicator flashes in green and the fan continues to run to reduce the internal heat. First, the ON/STANDBY indicator flashes quickly, during which you will not be able to light up the ON/STANDBY indicator with the I/⏻ switch.

3 Unplug the AC power cord from the wall outlet after the fan stops running and the ON/STANDBY indicator lights in red.

You can turn off the projector by holding the I/⏻ (on/standby) switch for about one second, instead of performing the above steps.

Selecting the Wide Screen Mode

You can enjoy various wide screen mode according to the video signal received. You can also select it using the menu. (☞ page 40)

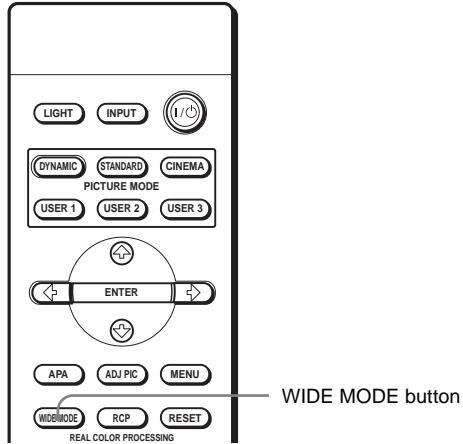

Press WIDE MODE.

Each time you press the button, you can select the “Wide Mode” setting.

Full

A picture squeezed to 4:3 is displayed with the correct aspect ratio. A 4:3 picture is enlarged horizontally to fit the 16:9 screen.



Tip

Squeezed: An original 16:9 aspect ratio picture is recorded horizontally compressed to a 4:3 picture.

Normal

A picture with normal 4:3 aspect ratio is displayed in the center of the screen to fill the vertical screen size.



Wide Zoom

A 4:3 aspect ratio picture is enlarged and the upper and lower portions of the picture are compressed to fit the 16:9 screen. Use this mode to view news, variety shows, etc.



Zoom

A normal 4:3 aspect ratio picture is enlarged vertically and horizontally in the same ratio to fill the 16:9 screen. This mode is ideal for viewing a wide-format movie.





Subtitle

The subtitle area is compressed and displayed in the lower part of the screen. Use this mode to view a movie with subtitles.



Notes

- You can adjust the vertical position of the picture with “V Position” in the Signal  menu only when “Zoom” or “Subtitle” is selected.
- You can adjust the position of the subtitles with “Title Area” in the Signal  menu only when “Subtitle” is selected.

Notes on selecting the wide screen mode

- Select the wide screen mode taking into account that changing the aspect ratio of the original picture will provide a different look from that of the original image.
- Note that if the projector is used for profit or for public viewing, modifying the original picture by switching to the wide mode may constitute an infringement of the rights of authors or producers, which are legally protected.

Selecting the Picture Viewing Mode

You can select the picture viewing mode that best suits the type of program or room condition.

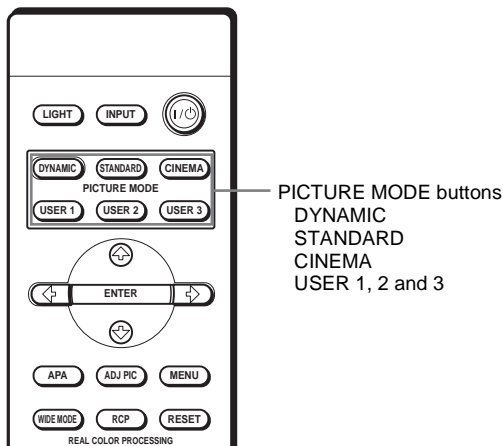

Press one of the PICTURE MODE buttons (DYNAMIC, STANDARD, CINEMA and USER 1, 2 and 3).

DYNAMIC

Select for enhanced picture sharpness in bright environment.

STANDARD

Recommended for normal viewing condition in your home.

CINEMA

Select for soft, film-like picture in dark environment.

USER 1, 2 and 3

You can adjust the quality of the picture to suit your taste and store the settings into the selected memory of the projector. Press one of the USER 1, 2 and 3 buttons, then adjust the picture by using the buttons on the remote control or the menus. (pages 30 and 37) The settings are stored, and you can view the picture with the adjusted picture quality by pressing the button.

Example: To adjust the contrast

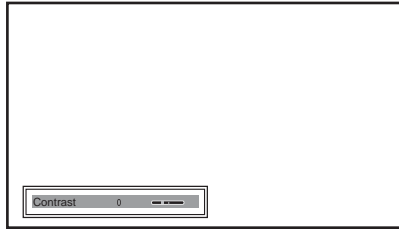

For details on each adjustment, see “Adjust Picture” in the Picture menu. (🔍 page 37) 

2 Make the setting or adjustment on an item.

When changing the adjustment level

To increase the value, press **↑** or **→**.

To decrease the value, press **↓** or **←**.

When changing the setting

Press **↑** or **↓** to change the setting.

To adjust contrast and brightness

Press **CONTRAST +/-** on the remote control to adjust the contrast.

Press **BRIGHT +/-** on the remote control to adjust the brightness.

Adjusting the Picture Using Real Color Processing

The Real Color Processing (RCP) feature allows you to adjust the color and hue of each target of the projected picture you specify independently. You can thus obtain a picture more suitable to your taste.

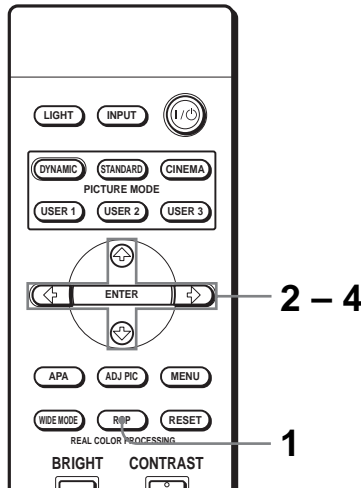

Tip

Freeze the scene of the video source when you are adjusting the picture using Real Color Processing.

- 1 Press RCP on the remote control.**
- 2 Press ↑ or ↓ to select “User 1,” “User 2” or “User 3,” then press →.**
The RCP (Real Color Processing) window appears.
- 3 Select the target color you want to adjust.**
Repeat steps ① and ② described below to specify the target color.
 - ① Press ↑ or ↓ to select “Color Select,” then press ← or → to select the color you want to adjust among “Red,” “Magenta,” “Blue,” “Cyan,” “Green” and “Yellow.”
Only the portions that correspond to the specified color will be colored and the other portions will be displayed in black and white. The reference palette in the RCP window also shows the adjustable colors. Decide the target while you are watching the projected picture, and watching the reference palette as a guide.

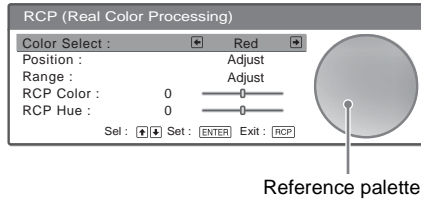

Reference palette

- ② Press **↑** or **↓** to select “Position” or “Range,” and specify it more delicate color and color range you want to adjust using **←** or **→**.

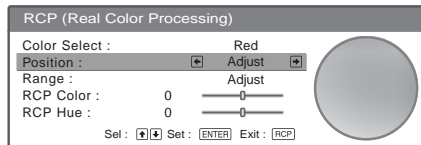

4 Adjust the color of the specified portions.

Press **↑** or **↓** to select “RCP Color” or “RCP Hue,” then adjust the color or hue of the portions selected in step 3 to suit your taste using **←** or **→** while watching the projected picture. The picture is returned to normal color during adjustment.

5 After the adjustment is complete, press RCP.

The RCP window disappears and the normal picture is restored.

The adjusted data will be stored in a memory selected in step 2 and will be recalled later.

Tip

There are some limitations on selection of position and range.

Using the Menus

This section describes how to make various adjustments and settings using the menus.

Operation through the Menus

The projector is equipped with an on-screen menu for making various adjustments and settings. Some of the adjustable/setting items are displayed in a pop-up menu, in a setting menu or adjustment menu with no main menu, or in the next menu window. If you select an item name followed by an arrow (▶), the next menu window with setting items appears.

To change the on-screen menu language, see “Selecting the Menu Language.” (📖 page 21)

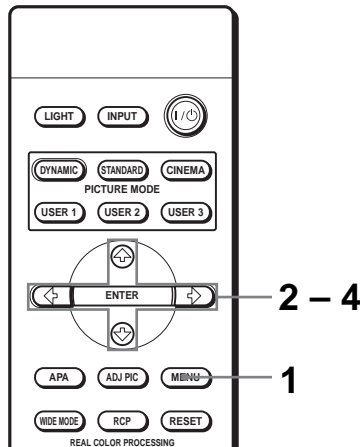

1 Press MENU.

The menu window appears.

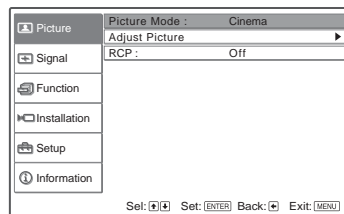

2 Press ↑ or ↓ to select a menu item, and press → or ENTER.

The items that can be set or adjusted with the selected menu appear. The item presently selected is shown as a yellow button.

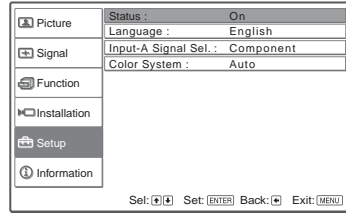

3 Press ↑ or ↓ to select an item you want to set or adjust and press → or ENTER.

The setting items are displayed in a pop-up menu, in a setting menu, in an adjustment menu or in the next menu window.

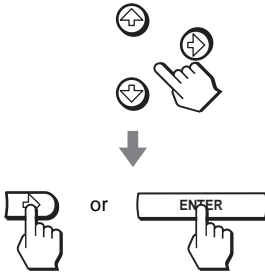

Pop-up menu

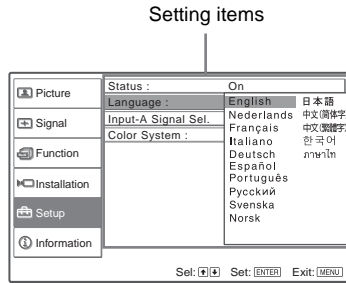

Setting menu

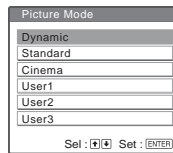

Adjustment menu

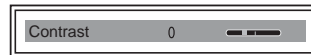

Next menu window

Setting items

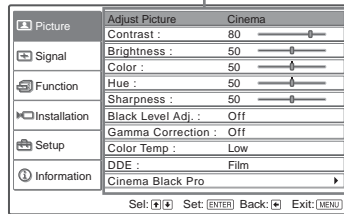

4 Make the setting or adjustment on an item.

When changing the adjustment level

To increase the value, press **↑** or **→**.

To decrease the value, press **↓** or **←**.

Press **ENTER** to restore the original screen.

When changing the setting

Press **↑** or **↓** to change the setting.

Press **ENTER** to restore the original screen.

You can restore the original screen using **←** depending on the selected item.

To clear the menu



Press **MENU**.

To reset the items that have been adjusted

Select the item you want to reset, then press **RESET**.

“Complete!” appears on the screen and the setting is reset to its factory preset value.

Items that can be reset are:

- “Contrast,” “Brightness,” “Color,” “Hue,” “Sharpness” and “Color Temp.” in “Adjust Picture” and “RCP” of the Picture  menu
- “Dot Phase,” “H Size” and “Shift” in “Adjust Signal” of the Signal  menu
- “V Keystone” of the Installation  menu

Items that cannot be adjusted

Adjustable items are limited depending on the input signals. The items that cannot be adjusted or set do not appear in the menu. (☞ page 54)

Picture Menu

The Picture menu is used for adjusting the picture.

Adjust Picture menu

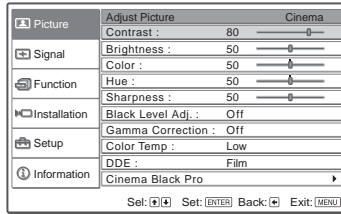
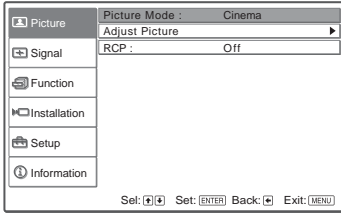

Item	Description
Picture Mode	<p>You can select picture viewing mode that best suits the type of picture or the environment.</p> <p>Dynamic: Select for enhanced picture contrast and sharpness.</p> <p>Standard: Recommended for normal viewing condition. Also select to reduce roughness when viewing the picture with Dynamic.</p> <p>Cinema: Select for soft, film-like picture.</p> <p>User 1, 2 and 3: You can adjust the quality of the picture to suit your taste and store the settings. Once the settings are stored, you can view the picture with the adjusted picture quality by pressing the PICTURE MODE button on the remote control.</p> <p>To store the settings</p> <ol style="list-style-type: none"> 1 Select User 1, User 2 or User 3. 2 Adjust the items you want in the menus. Items that can be stored are: “Adjust Picture” items and “Wide Mode” setting. <p>Tip</p> <p>You can also adjust the picture quality in “Dynamic,” “Standard” or “Cinema,” and store the settings. To reset to the factory setting, press RESET.</p>
Adjust Picture	
Contrast	The higher the setting, the greater the contrast. The lower the setting, the lower the contrast.
Brightness	The higher the setting, the brighter the picture. The lower the setting, the darker the picture.
Color	The higher the setting, the greater the intensity. The lower the setting, the lower the intensity.
Hue	The higher the setting, the more greenish the picture becomes. The lower the setting, the more purplish the picture becomes.
Sharpness	The higher the setting, the sharper the picture. The lower the setting, the softer the picture.

Item	Description
Adjust Picture	
Black Level Adj (Adjust)	<p>Emphasizes black color to produce a bolder “dynamic” picture. Set according to the input signal source.</p> <p>High: Gives higher emphasis to the black color.</p> <p>Low: Gives lower emphasis to the black color.</p> <p>Off: Cancels this feature.</p>
Gamma Correction	<p>Selects a favorite tone from three options.</p> <p>Off: The feature does not function.</p> <p>Gamma1: Makes the dark portion of a scene a little brighter.</p> <p>Gamma2: Makes the dark portion of a scene brighter than that in Gamma1.</p> <p>Gamma3: Makes the whole scene brighter.</p> <p>For the VPL-HS51 only</p> <p>Using the specified controller, “ImageDirector*” supplied as a CD-ROM allows you to adjust, set and store a favorite tone. Adjustable range is limited.</p> <p>* For detailed operations of “ImageDirector,” refer to the Operating Instructions stored in the supplied CD-ROM. “ImageDirector” cannot be used with Macintosh.</p>
Color Temp.	<p>High: Gives the white colors a blue tint.</p> <p>Middle: Gives the white colors a neutral tint.</p> <p>Low: Gives the white colors a red tint.</p> <p>Custom1, Custom2, Custom3: Enables you to adjust, set and store the favorite color temperature.</p>
DDE (Dynamic Detail Enhancer)	<p>Off: Plays a video signal in an interlace format without converting.</p> <p>Progressive: Converts an interlace format video signal to a progressive format.</p> <p>Film: Normally, select this option. Reproduces the 2-3 Pull-Down film sources with smooth picture movement. When the video signal with a format other than the 2-3 Pull-Down is input, “Progressive” is automatically selected.</p>
Cinema Black Pro	<p>Advanced Iris</p> <p>Switches the iris function during projection.</p> <p>Off: Normal contrast.</p> <p>On: Enhances the black by emphasizing the contrast.</p> <p>Auto: Automatically switches to an optimum iris according to a projected scene. The contrast of the scene is emphasized most.</p>
	<p>Lamp Control</p> <p>Switches the lamp wattage during projection.</p> <p>High: Normal wattage.</p> <p>Low: Enhances the black by reducing the lamp wattage.</p> <p>Tip</p> <p>If “Lamp Control” is set to “Low,” the next time the power is turned on, the lamp will use the “High” setting initially, and then go to “Low.”</p>

Item	Description
RCP (Real Color Processing)	<p>You can adjust the color and hue of each selected portion of the picture independently.</p> <p>Off: Cancels this feature.</p> <p>User 1, 2 and 3: You can adjust the picture using Real Color Processing and store the settings. Once the settings are stored, you can view the picture with the adjusted picture quality. For details, see “Adjusting the Picture Using Real Color Processing.” (📖 page 32)</p>

Signal Menu

The Signal menu is used to adjust the input signal. You can adjust the size of the picture, and select wide screen mode, etc

Adjust Signal menu

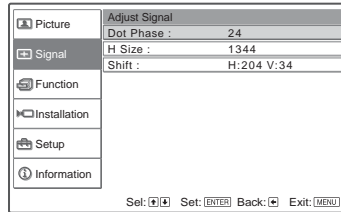
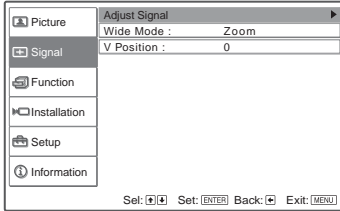

Item	Description
Adjust Signal	
Dot Phase	Adjusts the picture from a computer for clearer picture after it is adjusted by pressing the APA button.
H Size	Adjusts the horizontal size of the picture from a computer. The higher the setting, the wider the picture. The lower the setting, the narrower the picture.
Shift	As the setting for H (horizontal) increases, the picture moves to the right, and as the setting decreases, the picture moves to the left. Use ← or → to adjust the horizontal position. As the setting for V (vertical) increases, the picture moves up, and as the setting decreases, the picture moves down. Use ↑ or ↓ to adjust the vertical position.
Wide Mode	You can select the wide screen mode. Full: A picture squeezed to 4:3 is displayed with the correct aspect. Normal: The 4:3 aspect ratio picture is displayed to fill the vertical screen size. Wide Zoom: The 4:3 aspect ratio picture is enlarged and the upper and lower portions are compressed to fit the 16:9 screen. Zoom: The 4:3 aspect ratio picture is enlarged vertically and horizontally at the equal ratio to fill the 16:9 screen. Subtitle: The subtitle area is compressed and displayed at the lower part of the screen.
V Position	Adjusts the vertical position of the picture in wide screen mode. As the setting increases, the picture moves up. As the setting decreases, the picture moves down. Note This item is adjustable only when “Zoom” or “Subtitle” is selected.
Title Area	Adjusts the subtitle area. As the setting increases, the subtitle area moves up. As the setting decreases, the subtitle area moves down. Note This item is adjustable only when “Subtitle” is selected.

Function menu

The Function menu is used for changing the settings of the function of the projector.

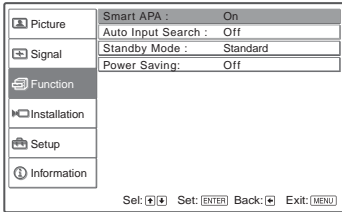



Item	Description
Smart APA	<p>With this item set to On, the APA function works automatically for a signal input from a computer so that the picture can be seen clearly. You can also activate the APA function by pressing the APA button on the remote control.</p> <p>Tip The APA (Auto Pixel Alignment) automatically adjusts the input signal from a computer so that the picture can be seen clearly.</p>
Auto Input Search	When set to On , the projector detects whether Component, HDMI, Video, S Video or Input-A signal is input when the projector is turned on or the INPUT button is pressed. Then the detected input channel is automatically displayed. Set to Off when you want to switch the input channel manually.
Standby Mode	When set to Low , the power consumption in standby mode is lowered.
Power Saving	When set to On , the POWER SAVING indicator lights. The projector goes into power saving mode if no signal is input for 10 minutes, and the lamp goes out and the cooling fan keeps running. In power saving mode, no button functions for the first 60 seconds, then it is cancelled when a signal is input or any button is pressed. If you do not set the projector to power saving mode, select Off .

Installation Menu

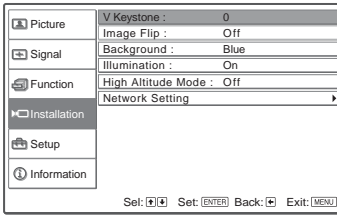
The Installation menu is used for changing the installation settings.



Item	Description
V Keystone	Corrects the vertical trapezoidal distortion of the picture. Sets a lower value (– direction) when the bottom of the trapezoid is longer than the top (). Sets a higher value (+ direction) when the top of the trapezoid is longer than the bottom ().
Image Flip	Flips the picture on the screen horizontally and/or vertically. Off: The picture does not flip. HV: Flips the picture horizontally and vertically. H: Flips the picture horizontally. V: Flips the picture vertically.
Background	Selects the background color of the screen when no signal is input. You can select “ Black ” or “ Blue .”
Illumination	Turns on the illumination on the top panel of the projector when set to On . It turns off when set to Off .
High Altitude Mode	Off: Use this setting when using the projector at normal altitudes. On: Use this setting when using the projector at an altitude of 1,500 m or higher.
Network Setting (VPL-HS51 only)	Displays settings in the network configuration of this projector. Notes <ul style="list-style-type: none"> • You cannot change the network settings with this projector. For information on networking, consult with qualified Sony personnel. • Be sure to set “Standby Mode” in the Function menu to “Standard” when you use the network function. ( page 41)

Setup Menu

The Setup menu is used to change the factory preset settings.

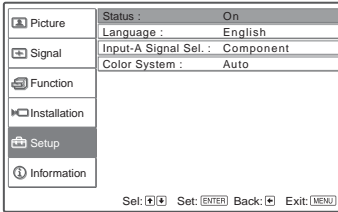

Items	Description
Status	Set to Off to turn off the on-screen displays except for the menus, message when turning off the power, and warning messages.
Language	Selects the language used in the menu and on-screen displays. Available languages are: English, Dutch, French, Italian, German, Spanish, Portuguese, Russian, Swedish, Norwegian, Japanese, Chinese (Simplified Chinese), Chinese (Traditional Chinese), Korean and Thai.
Input-A Signal Sel.	Selects the type of signal input from the equipment by selecting "Input-A" with the INPUT button. Auto: Selects the input signal type automatically. Computer: Inputs the signal from a computer. Component: Inputs the component signal from a DVD player/recorder, digital tuner, etc. Video GBR: Inputs the signal from a TV game or HDTV broadcast. Note When the input signal is not displayed correctly with this item set to Auto, select the item according to the input signal.
Color System	Select the color system of the input signal. Auto: Selects the color system of the input signal automatically from among NTSC3.58, PAL, SECAM, NTSC4.43, PAL-M, PAL-N or PAL60. "NTSC3.58"-"PAL-N": Sets the color system to the selected system manually.

Information Menu

The Information menu is used to display the horizontal and vertical frequencies of the input signal, used time of the lamp, etc.

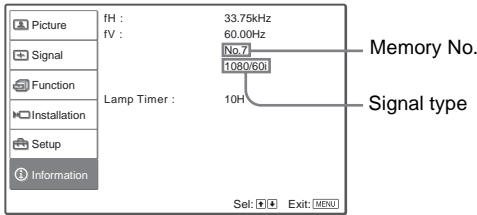

Item	Description
fH	Displays the horizontal frequency of the input signal.
fV	Displays the vertical frequency of the input signal.
(Memory No.)	Displays the preset memory number of the input signal.
(Signal type)	Displays the type of the input signal.
Lamp Timer	Indicates how long the lamp has been turned on.

Note

You cannot change the displays above.

About the Preset Memory No.

This projector has 32 types of preset data for input signals (the preset memory). When the preset signal is input, the projector automatically detects the signal type and recalls the data for the signal from the preset memory to adjust it to an optimum picture. The memory number and signal type of that signal are displayed in the Information  menu.

You can also adjust the preset data through the Signal  menu.

This projector also has 20 types of user memories for Input-A into which you can save the setting of the adjusted data for an unpreset input signal.

When an unpreset signal is input for the first time, a memory number is displayed as 0. When you adjust the data of the signal in the Signal  menu, it will be registered to the projector. If more than 20 user memories are registered, the newest memory always overwrites the oldest one.

See the chart on page 56 to find if the signal is registered to the preset memory.

Note

When the aspect ratio of input signal does not match the screen size, a part of the screen is displayed in black.

Adjusting Picture Quality of a Signal from the Computer

You can automatically adjust to obtain the clearest picture when projecting a signal from the computer.

1 Project a still picture from the computer.

2 Press the APA (Auto Pixel Alignment) button.

When the picture is adjusted properly, “complete!” appears on the screen.

Notes

- When “Smart APA” is set to “On,” the APA function is automatically activated.
- Press the APA button when the image appears on the whole display area of the computer. If there are black edges around the image, the APA function will not function properly and the image may extend beyond the screen.
- If you switch the input signal or re-connect a computer, press the APA button again to get the suitable picture.
- To restore the original screen, press the APA button again during the adjustment.
- When a signal of which the timing is the same as the “Memory No.37” or the “Memory No.55” signal (refer to the “Preset Signals” chart) is input, if the polarity of the synchronized signal is different, the input signal may be misjudged and the image may not appear properly (incorrect aspect ratio or lack of a part of the image). In this case, press the APA button to adjust the image. This APA processing time may be longer than the APA processing time of signal in another case. If the image does not still appear properly, input the signal as described in the following example, then press the APA button again.

Example:

Display of multiple icons or Windows bar in the lower part on a whitish wallpaper

- The picture may not be adjusted properly depending on the types of input signals.
- Adjust the items in the Signal  menu when you adjust the picture manually. (Ⓢ page 40)

Others

This section describes how to solve the problems, how to replace a lamp and air filter, etc.







Troubleshooting

If the projector appears to be operating erratically, try to diagnose and correct the problem using the following instructions. If the problem persists, consult with qualified Sony personnel.

Power

Symptom	Cause and Remedy
The power is not turned on.	<ul style="list-style-type: none">→ Wait for about one minute before turning on the power. (☞ page 25)→ Close the lamp cover securely. (☞ page 49)→ Close the air filter cover securely. (☞ page 50)

Picture

Symptom	Cause and Remedy
No picture.	<ul style="list-style-type: none">→ Check that the proper connections have been made. (☞ page 13)→ Select the input source correctly using the INPUT button. (☞ page 24)→ Set the computer signal to output from an external monitor.→ Set the computer signal to output only to an external monitor.→ Select “Computer,” “Component” or “Video GBR” for “Input-A Signal Sel.” in the Setup  menu according to the input signal. (☞ page 43)
The picture from the INPUT A connector is colored strange.	<ul style="list-style-type: none">→ Select “Computer,” “Component” or “Video GBR” for “Input-A Signal Sel.” in the Setup  menu according to the input signal. (☞ page 43)
The picture from the VIDEO or S VIDEO INPUT connector is colored strange.	<ul style="list-style-type: none">→ Adjust the picture in the “Adjust Picture” of the Picture  menu (☞ page 37)→ Set “Color System” in the Setup  menu to match the color system being input. (☞ page 43)
The picture is too dark.	<ul style="list-style-type: none">→ Adjust the contrast or brightness in the “Adjust Picture” of the Picture  menu properly. (☞ page 37)
The picture is not clear.	<ul style="list-style-type: none">→ Adjust the focus with the focus ring. (☞ page 25)→ Condensation has occurred on the lens. Leave the projector for about two hours with the power on.
The picture flickers.	<ul style="list-style-type: none">→ Adjust “Dot Phase” for “Adjust Signal” in the signal  menu properly. (☞ page 40)

On-screen display

Symptom	Cause and Remedy
On-screen display does not appear.	→ Set “Status” in the Setup  menu to “On.” (☞ page 43)

Remote control

Symptom	Cause and Remedy
The remote control does not work.	<ul style="list-style-type: none"> → Batteries could be weak. Replace with new batteries. (☞ page 7) → Insert the batteries with correct polarities. (☞ page 7)

Warning Indicators

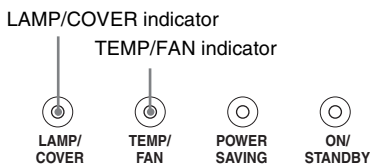

The LAMP/COVER or TEMP/FAN indicator on the control panel lights up or flashes if there is any trouble with your projector.



Symptom	Cause and Remedy
LAMP/COVER flashes.	→ Attach the lamp cover or the air filter cover securely. (☞ pages 49 and 50)
LAMP/COVER lights up.	<ul style="list-style-type: none"> → The lamp has reached the end of its life. Replace the lamp. (☞ page 49) → The lamp becomes a high temperature. Wait until the lamp cools, and then turn on the power again. (☞ page 25)
TEMP/FAN flashes.	→ The fan is broken. Consult with qualified Sony personnel.
TEMP/FAN lights up.	→ The internal temperature is unusually high. Check to see if nothing is blocking the ventilation holes or whether or not the projector is being used at high altitudes.
LAMP/COVER and TEMP/FAN light up.	→ Disconnect the AC power cord, connect it, then turn on the power again. If the indicators still light up, the electrical system breaks down. Consult with qualified Sony personnel.

Message Lists

Warning messages

Message	Cause and Remedy
High temp.! Lamp off in 1 min.	<ul style="list-style-type: none"> → Turn off the power. → Check to see if nothing is blocking the ventilation holes.
Frequency is out of range!	<ul style="list-style-type: none"> → Input a signal that is within the acceptable range of the frequency. → Set the output signal on an external monitor of the connected computer to SVGA. → Set “Input-A Signal Sel.” in the Setup  menu to “Computer”. (☞ page 43)
Please check Input-A Signal Sel.	<ul style="list-style-type: none"> → Set “Input-A Signal Sel.” in the Setup  menu to “Computer” when RGB signal is input from the computer. (☞ page 43)
Please replace the LAMP.	<ul style="list-style-type: none"> → It is time to replace the lamp. Replace the lamp. (☞ page 49)
Please replace the filter.	<ul style="list-style-type: none"> → It is time to replace the air filter. Replace the air filter. (☞ page 50)
High temp.! Probably use in high altitude. Switch to high altitude mode on? Yes: ↑/ No: ↓	<ul style="list-style-type: none"> → When using the projector at an altitude of 1,500 m or higher: select “Yes” to set to “High Altitude Mode”. (☞ page 42) → If this message is displayed when using the projector at an altitude of less than 1,500 m: check to see if nothing is blocking the ventilation holes.

Caution messages

Message	Cause and Remedy
	<ul style="list-style-type: none"> → No signal is input in the selected input. Check connections. (☞ page 13)
Not applicable!	<ul style="list-style-type: none"> → Press the appropriate button.

Replacing the Lamp

The lamp used for the light source has a certain life. When the lamp dims, the color balance of the picture becomes strange, or "Please replace the LAMP." appears on the screen, the lamp may be exhausted. Replace the lamp with a new one (not supplied). Use LMP-H130 Projector Lamp as the replacement lamp.

When replacing the lamp after using the projector

Turn off the projector, then unplug the power cord. Wait for at least an hour for the lamp to cool.

Caution

The lamp becomes a high temperature after turning off the projector with the I/⏻ (on/standby) switch. If you touch the lamp, you may scald your finger. When you replace the lamp, wait for at least an hour for the lamp to cool. When removing the lamp unit, make sure it remains horizontal, then pull straight up. Do not tilt the lamp unit. If you pull out the lamp unit while tilted and if the lamp breaks, the pieces may scatter, causing injury.

- 1 Turn off the projector and unplug the AC power cord.
- 2 Place a protective sheet (cloth) beneath the projector. Turn the projector over so you can see its underside.

Note

Be sure that the projector is stable after turning it over.

- 3 Loosen a screw with the Philips screwdriver ①, then open the lamp cover ②.

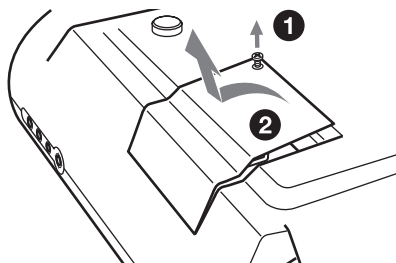

- 4 Loosen the three screws on the lamp unit with the Philips screwdriver ①. Pull out the lamp unit by the handle ②.

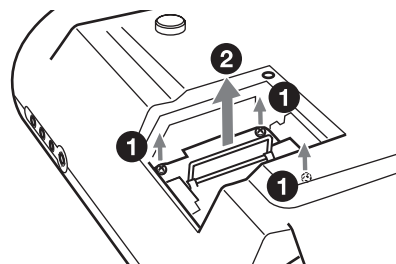

- 5 Insert the new lamp all the way in until it is securely in place ①. Tighten the three screws ②. Fold down the handle.

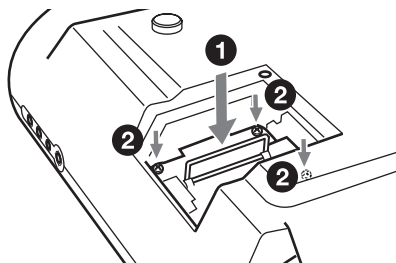

- 6 Close the lamp cover and tighten the screw.
- 7 Turn the projector back over.
- 8 Connect the power cord and set the projector to standby mode.

- 9 Press the following buttons on the remote control in the following order for less than five seconds each: RESET, ←, →, ENTER.**

Notes

- Do not put your hands into the lamp replacement spot, or not fall any liquid or object into it to avoid electrical shock or fire.
- Be sure to use the LMP-H130 Projector Lamp for replacement. If you use lamps other than LMP-H130, the projector may cause a malfunction.
- Be sure to turn off the projector and unplug the power cord before replacing the lamp.
- The projector will not turn on unless the lamp is securely installed in place.
- The projector will not turn on unless the lamp cover is securely closed.

Disposal of the used lamp

For the customers in the USA

This product contains mercury. Disposal of this product may be regulated if sold in the United States. For disposal or recycling information, please contact your local authorities or Electronics Industries Alliance (<http://www.eiae.org>).

Replacing the Air Filter

The air filter should be replaced periodically. When “Please replace the filter.” appears on the screen, replace the air filter immediately.

Notes

- Replacing the air filter is very important to maintain the high efficiency of the projector and to prevent a malfunction. When the replacement message appears on the screen, replace the air filter without delay. It is recommended to replace the air filter approximately every 1000 hours of use.
- When removing the air filter from the projector, be careful that no dust or object gets into the inside of the projector.

- 1 Turn off the projector, then unplug the AC power cord.**
- 2 Open the filter cover toward you, while pushing the three filter lock knobs upward.**

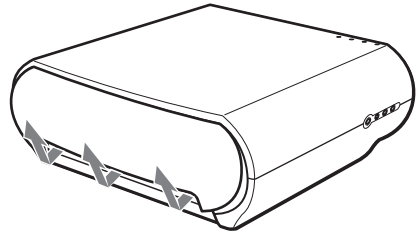

- 3 Remove the air filter from the projector by holding the tab on the filter.**

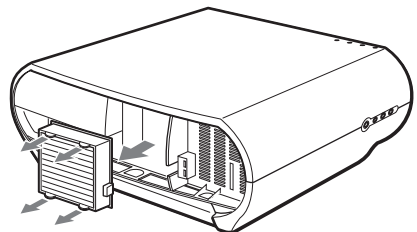

4 Insert the new air filter into the projector.

5 Replace the filter cover.

Note

The projector will not turn on unless the filter cover is securely closed.

Specifications

System

Projection system	3 LCD panels, 1 lens, projection system
LCD panel	0.73-inch TFT LCD panel with micro-lens array, 2,764,800 pixels (921,600 pixels × 3)
Lens	1.6 times zoom lens (manual) f21.3 – 34.1 mm/F2.4 – 3.16
Lamp	135 W UHP type
Projection picture size	40 to 200 inches (measured diagonally)
Color system	NTSC _{3.58} /PAL/SECAM/NTSC _{4.43} /PAL-M/PAL-N/PAL60 system, switched automatically/ manually (PAL60 system not switched manually)
Acceptable video signals	15 kHz RGB/component 50/60 Hz, Progressive component 50/60 Hz, DTV (480/60i, 575/50i, 480/60p, 575/50p, 720/60p, 720/50p, 1080/60i, 1080/50i), 1080/24PsF, Composite video, Y/C video
Acceptable computer signals	fH: 19 to 72 kHz fV: 48 to 92 Hz Maximum resolution WXGA 1280 × 768, fV: 60 Hz

Input

Video input	VIDEO: phono type Composite video: 1 Vp-p±2 dB sync negative (75 ohms terminated) S VIDEO: Y/C mini DIN 4-pin type Y (luminance): 1 Vp-p±2 dB sync negative (75 ohms terminated) C (chrominance): burst 0.286 Vp-p ±2 dB (NTSC) (75 ohms terminated) burst 0.3 Vp-p±2 dB (PAL) (75 ohms terminated)
Y/P _B /C _B /Pr/C _R	Component: phono type G with Sync/Y: 1 Vp-p±2dB sync negative (75 ohms terminated)

B/C _B /P _B :	0.7 Vp-p±2dB positive (75 ohms terminated)
R/C _R /P _R :	0.7 Vp-p±2 dB positive (75 ohms terminated)
HDMI INPUT A	Digital RGB/Y/C _B (P _B)C _R (P _R) HD D-sub 15-pins Analog RGB/component: R/C _R (P _R): 0.7 Vp-p±2 dB (75 ohms terminated) G: 0.7 Vp-p±2 dB (75 ohms terminated) G with sync/Y: 1 Vp-p±2 dB sync negative (75 ohms terminated) B/C _B (P _B): 0.7 Vp-p±2 dB (75 ohms terminated) SYNC/HD: Composite sync input: TTL level, positive/negative Horizontal sync input: TTL level, positive/negative VD: Vertical sync input: TTL level, positive/negative
Ethernet (VPL-HS51)	RJ-45 10BASE-T/100BASE-TX
TRIGGER	Minijack Power on: DC 12 V, output impedance: 4.7 kilohms Power off: 0 V

General

Dimensions	348 × 135 × 360 mm (13 ⁵ / ₈ × 5 ⁷ / ₈ × 14 ⁵ / ₈ inches) (w/h/d)
Mass	VPL-HS50: Approx. 5.6 kg (12 lb 6 oz) VPL-HS51: Approx. 5.7 kg (12 lb 6 oz)
Power requirements	AC 100 to 240 V, 0.8–1.95 A, 50/60 Hz
Power consumption	VPL-HS50: Max. 195 W Standby mode: 3 W ECO mode: 0.5 W VPL-HS51: Max. 195 W Standby mode: 4.5 W ECO mode: 0.5 W
Operating temperature	0°C to 35°C (32°F to 95°F)

Operating humidity	35% to 85% (no condensation)
Storage temperature	-20°C to 60°C (-4°F to 140°F)
Storage humidity	10% to 90%

Supplied accessories

- Remote control RM-PJHS50 (1)
- Size AA (R6) batteries (2)
- AC power cord (1)
- Air filter (for replacement) (1)
- Operating Instructions (1)
- CD-ROM (Application software and Operating Instructions) (VPL-HS51 only)

Design and specifications are subject to change without notice.

Safe regulations

VPL-HS50:

UL60950, CSA No. 950, FCC class B, IC class B, EN60950 (NEMKO), CE, C-Tick

VPL-HS51:

UL60950, FCC class B

Optional accessories

- Projector Lamp LMP-H130 (for replacement)
- Air filter PK-HS10FL (for replacement)
- Projector Suspension Support PSS-610

Warning on power connection

Use a proper power cord for your local power supply.

	The United States, Canada		Continental Europe		UK, Ireland, Australia, New Zealand	Japan
Plug type	VM0233	290B	YP-12A	COX-07	*	YP332
Female end	VM0089	386A	YC-13B	COX-02	VM0310B	YC-13
Cord type	SJT	SJT	H05VV-F	H05VV-F	N13237/CO-228	VCTF
Rated Voltage & Current	10A/125V	10A/125V	10A/250V	10A/250V	10A/250V	7A/125V
Safety approval	UL/CSA	UL/CSA	VDE	VDE	VDE	DENANHO

* Use a rated plug that complies with the regulation of each country and the specifications.

Input Signals and Adjustable/setting Items

Some of the items in the menus cannot be adjusted depending on the input signal. The following tables indicate them.

The items that cannot be adjusted are not displayed in the menu.

Adjust Picture menu

Item	Input signal				
	Video or S video (Y/C)	Component	Video GBR	Computer	HDMI
Contrast	●	●	●	●	●
Brightness	●	●	●	●	●
Color	● (except for B & W)	●	●	—	●
Hue	● (NTSC _{3.58} / NTSC _{4.43} only, except for B & W)	●	●	—	●
Sharpness	●	●	●	—	●
Black Level Adj	●	●	●	—	●
Gamma Correction	●	●	●	●	●
Color Temp.	●	●	●	●	●

Item		Input signal				
		Video or S video (Y/C)	Component	Video GBR	Computer	HDMI
DDE		●	● (preset memory numbers 3,4,7,8,9 only)	● (preset memory numbers 3,4,7,8,9 only)	–	● (preset memory numbers 3,4,7,8,9 only)
Cinema Black Pro	Advanced Iris	●	●	●	●	●
	Lamp Control	●	●	●	●	●

● : Adjustable/can be set

– : Not adjustable/cannot be set

Signal menu

Item		Input signal				
		Video or S video (Y/C)	Component	Video GBR	Computer	HDMI
Dot Phase		–	–	–	●	–
H size		–	–	–	●	–
Shift		–	● (preset memory numbers 5, 6, 7, 8, 9, 10, 11 only)	● (preset memory numbers 5, 6, 7, 8, 9, 10, 11 only)	●	●
Wide Mode		●	● (preset memory numbers 3, 4, 5, 6 only)	● (preset memory numbers 3, 4, 5, 6 only)	–	● (preset memory numbers 3, 4, 5, 6 only)

● : Adjustable/can be set

– : Not adjustable/cannot be set

Preset Signals

Memory No.	Preset signal		fH (kHz)	fV (Hz)	Sync	H Size	HDMI input
1	VIDEO/60	60 Hz	15.734	59.940	–	–	–
2	VIDEO/50	50 Hz	15.625	50.000	–	–	–
3	480/60i	480/60i	15.734	59.940	SonG/Y or composite sync	–	●
4	575/50i	575/50i	15.625	50.000	SonG/Y or composite sync	–	●
5	480/60p	480/60p (Progressive NTSC)	31.470	60.000	SonG/Y	–	●
6	575/50p	575/50p (Progressive PAL)	31.250	50.000	SonG/Y	–	●
7	1080/60i	1035/60i, 1080/60i	33.750	60.000	SonG/Y	–	●
8	1080/50i	1080/50i	28.130	50.000	SonG/Y	–	●
9	1080/24PsF	1080/48i	27.000	48.000	SonG/Y	–	●
10	720/60p	720/60p	45.000	60.000	SonG/Y	–	●
11	720/50p	720/50p	37.500	50.000	SonG/Y	–	●
21	640 × 350	VGA-1 (VGA350)	31.469	70.086	H-pos, V-neg	800	–
22		VESA 85 (VGA350)	37.861	85.080	H-pos, V-neg	832	–
23	640 × 400	NEC PC98	24.823	56.416	H-neg V-neg	848	–
24		VGA-2 (TEXT)/VESA70	31.469	70.086	H-neg V-pos	800	–
25		VESA 85 (VGA400)	37.861	85.080	H-neg, V-pos	832	–
26	640 × 480	VESA 60	31.469	59.940	H-neg, V-neg	800	●
27		Mac 13	35.000	66.667	H-neg, V-neg	864	–
28		VESA 72	37.861	72.809	H-neg, V-neg	832	–
29		VESA 75 (IBM M3)	37.500	75.000	H-neg, V-neg	840	–
30		VESA 85 (IBM M4)	43.269	85.008	H-neg, V-neg	832	–

Memory No.	Preset signal		fH (kHz)	fV (Hz)	Sync	H Size	HDMI input
31	800 × 600	VESA 56	35.156	56.250	H-pos, V-pos	1024	–
32		VESA 60	37.879	60.317	H-pos, V-pos	1056	–
33		VESA 72	48.077	72.188	H-pos, V-pos	1040	–
34		VESA 75 (IBM M5)	46.875	75.000	H-pos, V-pos	1056	–
35		VESA 85	53.674	85.061	H-pos, V-pos	1048	–
36	832 × 624	Mac 16	49.724	74.550	H-neg, V-neg	1152	–
37	1024 × 768	VESA 60	48.363	60.004	H-neg, V-neg	1344	–
38		VESA 70	56.476	70.069	H-neg, V-neg	1328	–
39		VESA 75	60.023	75.029	H-pos, V-pos	1312	–
55	1280 × 768	WXGA 60	47.776	59.870	H-neg, V-pos	1664	–
56	1280 × 720	WXGA 60	44.772	59.855	H-neg, V-pos	1664	–

Note

When a signal other than the preset signals shown above is input, the picture may not appear properly.

Ceiling Installation

Use the PSS-610 Projector Suspension Support when you install the projector on a ceiling. The projection distances for ceiling installation are shown below.

- a: Distance between the screen and the front hole for the mount bracket on the bottom surface of the unit
- b: Distance from the ceiling to the bottom surface of the unit
- x: Distance between the ceiling and the center of the screen

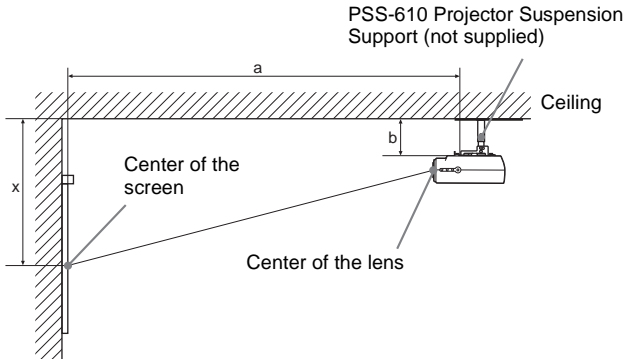

When using the 16:9 aspect ratio screen

Unit: mm (inches)

Screen Size (inches)		40	60	80	100	120	150	180	200
a	Minimum Distance	1290 (50 7/8)	1890 (74 1/2)	2500 (98 1/2)	3100 (122 1/8)	3700 (145 3/4)	4610 (181 5/8)	5510 (217)	6120 (241)
	Maximum Distance	1910 (75 1/4)	2830 (111 1/2)	3750 (147 3/4)	4660 (183 1/2)	5580 (219 3/4)	6950 (273 3/4)	8330 (328)	9240 (363 7/8)
x	Minimum Distance	174 (6 7/8)	299 (11 7/8)	423 (16 3/4)	548 (21 5/8)	672 (26 1/2)	859 (33 7/8)	1046 (41 1/4)	1170 (46 1/8)
	Maximum Distance	b+423 (b+16 3/4)	b+672 (b+26 1/2)	b+921 (b+36 3/8)	b+1170 (b+46 1/8)	b+1419 (b+55 7/8)	b+1793 (b+70 5/8)	b+2166 (b+85 3/8)	b+2416 (b+95 1/4)
b		150, 175, 200, 250, 300 mm (6, 7, 7 7/8, 9 7/8, 10 7/8, 11 7/8 inches) adjustable when using PSS-610							

To calculate the installation measurements (SS: Screen Size)

$$a \text{ (minimum)} = \{(SS \times 21.27/0.7227) - 35.160899\} \times 1.025 + 123.5$$

$$a \text{ (maximum)} = \{(SS \times 33.9409273/0.7227) - 37.678872\} \times 0.975 + 123.5$$

$$x \text{ (minimum)} = (SS/0.7227 \times 4.5) - 75$$

$$x \text{ (maximum)} = b + (SS/0.7227 \times 9) - 75$$

When using the 4:3 aspect ratio screen

Unit: mm (inches)

Screen Size (inches)		40	60	80	100	120	150	180	200
a	Minimum Distance	1560 (61 1/2)	2300 (90 5/8)	3040 (119 3/4)	3780 (148 7/8)	4510 (177 5/8)	5620 (221 3/8)	6730 (265)	7470 (294 1/4)
	Maximum Distance	2320 (91 3/8)	3450 (135 7/8)	4570 (180)	5690 (224 1/8)	6810 (268 1/4)	8490 (334 3/8)	10170 (400 1/2)	11290 (444 5/8)
x	Minimum Distance	230 (9 1/8)	382 (15 1/8)	535 (21 1/8)	687 (27 1/8)	839 (33 1/8)	1068 (42 1/8)	1297 (51 1/8)	1449 (57 1/8)
	Maximum Distance	b+535 (b+21 1/8)	b+839 (b+33 1/8)	b+1144 (b+45 1/8)	b+1449 (b+57 1/8)	b+1754 (b+69 1/8)	b+2211 (b+87 1/8)	b+2668 (b+105 1/8)	b+2973 (b+117 1/8)
b		150, 175, 200, 250, 300 mm (6, 7, 7 7/8, 9 7/8, 10 7/8, 11 7/8 inches) adjustable when using PSS-610							

To calculate the installation measurements (SS: Screen Size)

a (minimum) = $\{(SS \times 21.27/0.5906) - 35.160899\} \times 1.025 + 123.5$

a (maximum) = $\{(SS \times 33.9409273/0.5906) - 37.678872\} \times 0.975 + 123.5$

x (minimum) = $(SS/0.5906 \times 4.5) - 75$

x (maximum) = $b + (SS/0.5906 \times 9) - 75$

Attaching the PSS-610 projector suspension support

For details on installation on a ceiling, refer to the Installation manual for Dealers of the PSS-610. Make sure to consult with a qualified Sony personnel for installation.

The installation measurements are shown below when installing the projector on a ceiling.

Top view

Install the projector so that the center of the lens is parallel to the center of the screen.

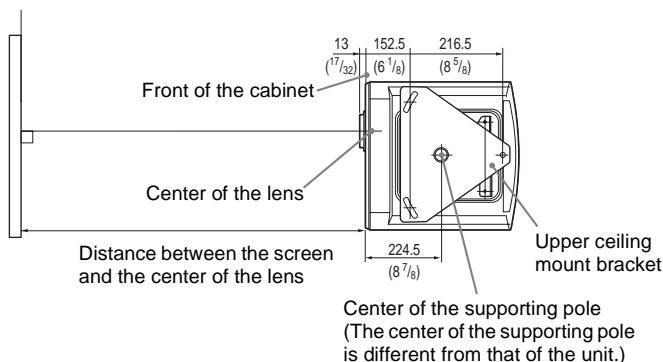

Location of Controls

Front

You can use the buttons on the control panel with the same names as those on the remote control to operate the projector.

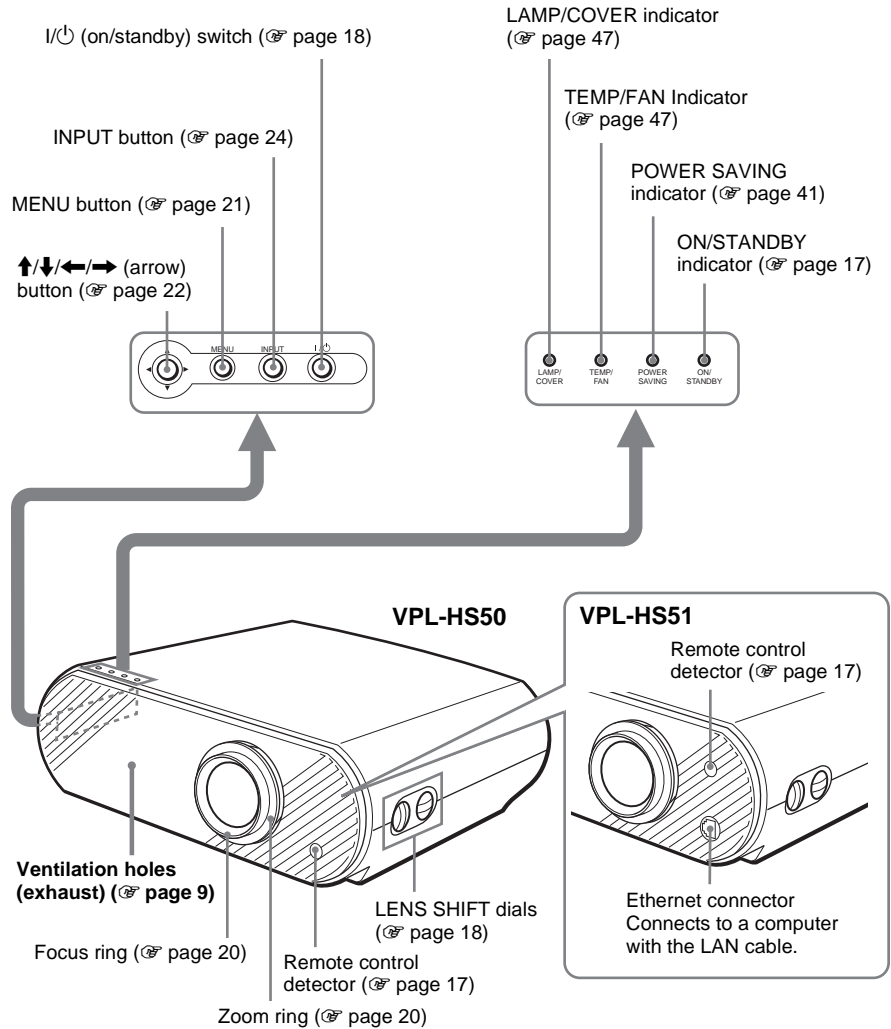

Rear

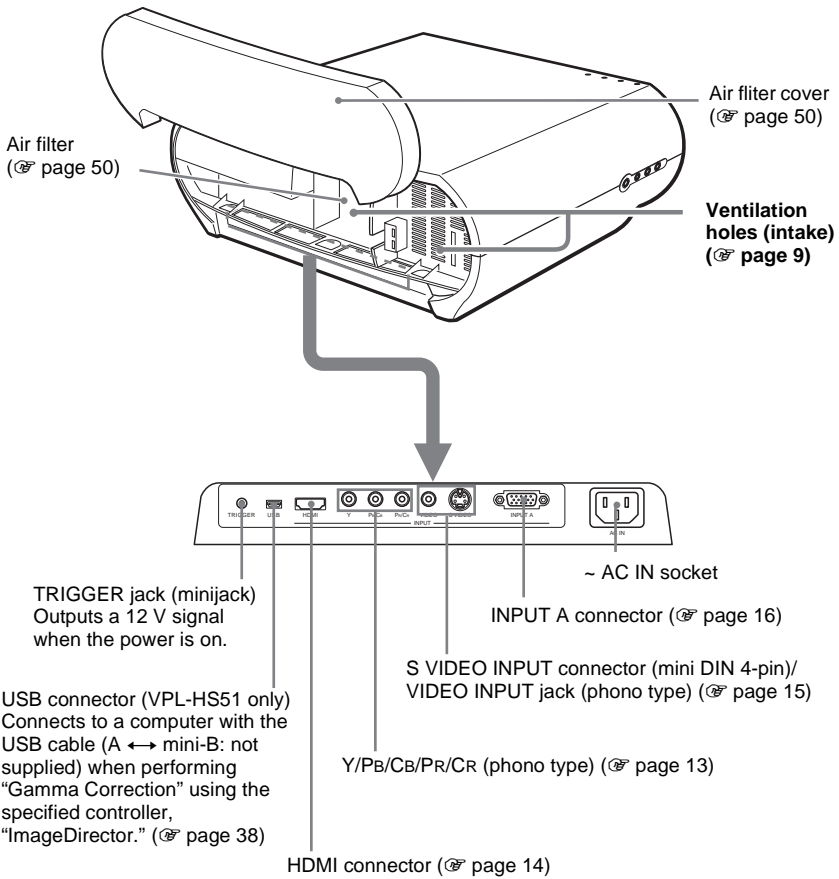

Bottom

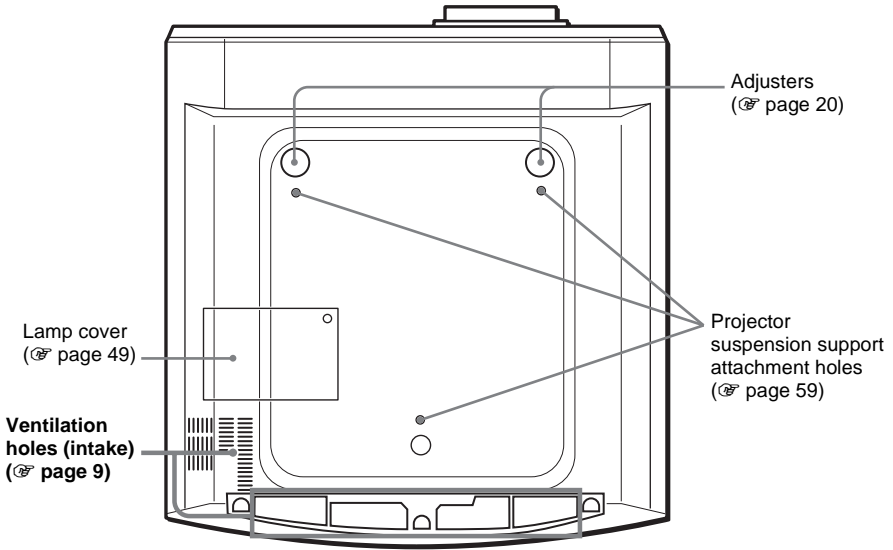

Remote Control

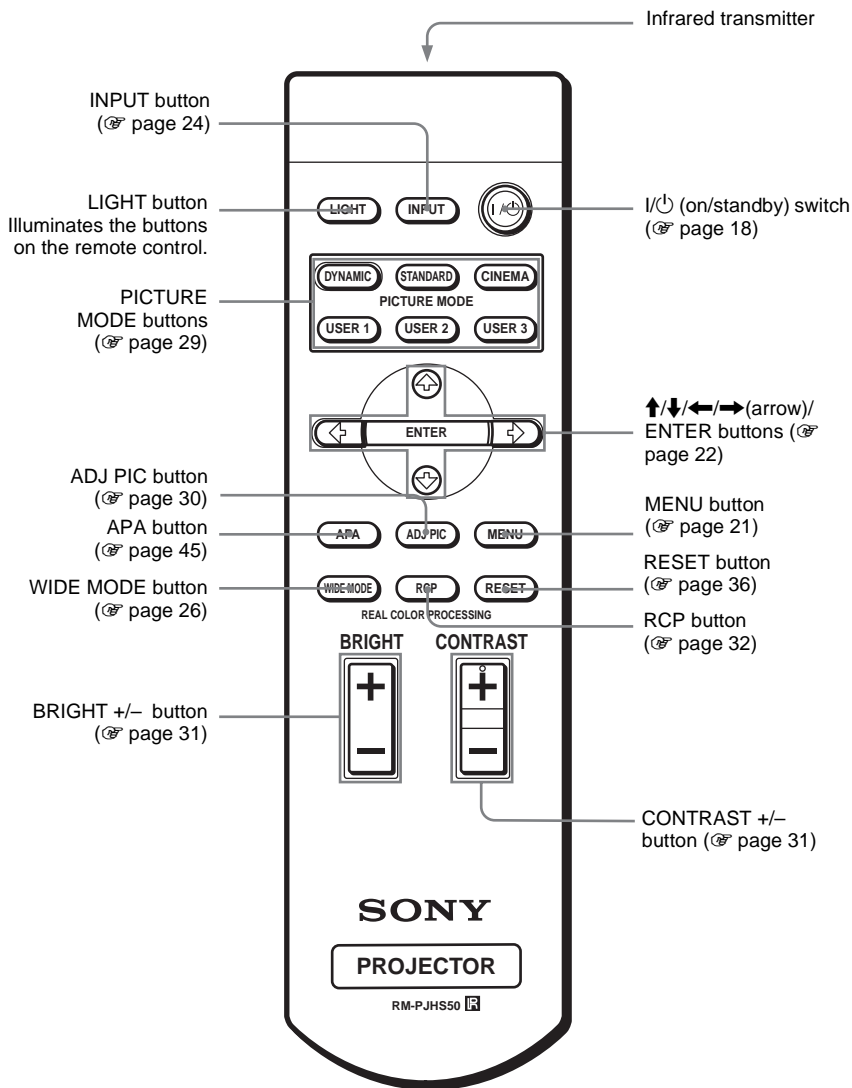

Index

A

Adjust Picture	37
Adjust Signal	40
Adjuster	20
Adjusting	
picture quality	30
Picture Quality of a Signal from the Computer	45
picture size and position	17
picture size/position	17
picture size/shift	40
picture using Real Color Processing	32
zoom	24
Air Filter	50
Auto Input Search	41

B

Background	42
Black Level Adj	38
Brightness	37

C

Ceiling Installation	58
Cinema Black Pro	38
Color	37
Color System	43
Color Temp.	38
Connecting	
Computer	16
DVD Player/Recorder or Digital Tuner	13
Video Equipment	15
Contrast	37

D

DDE	38
Dot Phase	40

F

fH	44
Function menu	41
fV	44

G

Gamma Correction	38
------------------------	----

H

H Size	40
HDMI output	14
High Altitude Mode	42
Hue	37

I

Illumination	42
Image Flip	42
Information menu	44
Input-A Signal Sel.	43
Installation menu	42
Installing the Projector and a Screen	10, 58

L

Lamp Timer	44
Language	43
Lens shift feature	18
Location of Controls	
Bottom	63
Front	61
Rear	62

M

Menu	
clearing	36
Function menu	41
Information menu	44
Installation menu	42
picture	37
Setup menu	43
Signal menu	40
Using the menu	34
Messages	
Caution	48
Warning	48

P

Picture menu	37
Picture Mode	
CINEMA	29
DYNAMIC	29
STANDARD	29
USER 1, 2 and 3	29
Power Saving	41
Precautions	6
Preset Signals	56
Projection	23

R

Real Color Processing	32, 39
Remote control	
inserting the batteries	7
location of controls	64
Replacing the Lamp	49
Reset	
resettable items	36
resetting the items	36

S

Selecting the menu language	21
Setup menu	43
Sharpness	37
Shift	40
Signal menu	40
Smart APA	41
Standby Mode	41
Status	43
Supplied accessories	7

T

Title Area	40
Troubleshooting	46

V

V Keystone	42
V Position	40
Ventilation holes	9

W

Warning Indicators	47
WIDE MODE	26
Wide Mode	26, 40

<http://www.sony.net/>



Printed on 100% recycled paper.
Power consumption in standby is 0.5 W.
Lead-free solder is used for soldering.
Halogenated flame retardants are not used in cabinets and printed wiring boards.
Polystyrene foam for the packaging cushions is not used in packaging.
100% recycled paper is used for the carton.