

IN35 IN35W IN37

InFocus



Declaration of Conformity

Manufacturer: InFocus Corporation, 27500 SW Parkway Avenue, Wilsonville, Oregon 97070 USA

European Office: Louis Armstrongweg 110, 1311 RL Almere, The Netherlands

We declare under our sole responsibility that this projector conforms to the following directives and norms:

EMC Directive 2004/108/EC

EMC: EN 55022

EN 55024

EN 61000-3-2

EN 61000-3-3

Low Voltage Directive 73/23/EEC, Amended by 93/68/EEC

Safety: IEC 60950-1: 1st Edition

September, 2007

Trademarks

Microsoft, PowerPoint, Word, Excel and Windows are trademarks or registered trademarks of Microsoft Corporation. Adobe and Acrobat are trademarks or registered trademarks of Adobe Systems Incorporated. DLP® and the DLP logo are registered trademarks of Texas Instruments and BrilliantColor™ is a trademark of Texas Instruments. InFocus, In Focus, and INFOCUS (stylized) are either registered trademarks or trademarks of InFocus Corporation in the United States and other countries.

FCC Warning

This equipment has been tested and found to comply with the limits for a Class A digital device, pursuant to part 15 of the FCC Rules. These limits are designed to provide reasonable protection against harmful interference when the equipment is operated in a commercial environment. This equipment generates, uses, and can radiate radio frequency energy and, if not installed and used in accordance with the instruction manual, may cause harmful interference to radio communications. Operation of this equipment in a residential area is likely to cause harmful interference in which case the user will be required to correct the interference at his own expense.

Changes or modifications not expressly approved by InFocus Corporation may void authority to operate the equipment.

EN 55022 Warning

This is a Class A product. In a domestic environment it may cause radio interference, in which case the user may be required to take adequate measures. The typical use is in a conference room, meeting room or auditorium.

Canada

This Class A digital apparatus complies with Canadian ICES-003.

Cet appareil numérique de la classe A est conforme à la norme NMB-003 du Canada.

Agency Approvals

UL, CUL, TUV

Other specific Country Approvals may apply, please see product certification label.

This user's guide applies to models W360: IN35, C250, IN35W, C250W, IN37, C315.

InFocus reserves the right to alter product offerings and specifications at any time.

Table of Contents

Introduction	3
Connecting a computer	5
Required computer connections	5
Displaying a computer image	7
Adjusting the image	8
Connecting a video device	9
Displaying a video image	10
Shutting down the projector	12
Troubleshooting your setup	12
Using the keypad buttons	20
Using the remote control	21
Using the audio	22
Optimizing computer images	23
Presentation features	23
Optimizing video images	23
Customizing the projector	23
Using the menus	24
Picture menu	25
Settings menu	28
Maintenance	32
Cleaning the lens	32
Using the security lock	32
Replacing the projection lamp	33
Appendix	35
Projected image size	35

Important Operating Considerations for Safety

- Place the projector in a horizontal position no greater than 15 degrees off axis.
- Locate the projector in a well-ventilated area without any obstructions to intake or exhaust vents. Do not place the projector on a tablecloth or other soft covering that may block the vents.
- Locate the projector at least 4' (1.2 m) away from any heating or cooling vents.
- Use only InFocus-approved ceiling mounts.
- Only InFocus lamps are tested and certified for use in this projector. InFocus is not liable for the performance, safety or certification of any other lamps. The use of other lamps violates the projector warranty and voids all certification marks on this projector.
- Use only the power cord provided. A surge-protected power strip is recommended.
- Refer to this guide for proper startup and shutdown procedures.
- **Warning:** Hg – Lamp contains mercury. Manage in accordance with local disposal laws. See www.lamprecycle.org.
- In the unlikely event of a lamp rupture, particles may exit through the projector side vents. When the projector is turned on, keep people, food, and drinks out of the "keep out" area under and around the projector, as indicated by the "X" areas below.

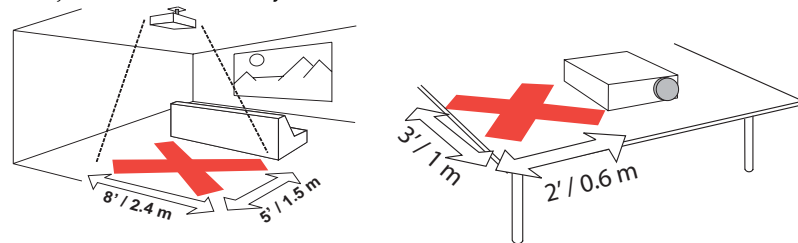

Follow these instructions to help ensure image quality and lamp life over the life of the projector. Failure to follow these instructions may affect the warranty. For complete details of the warranty, see the Warranty booklet.

Introduction

Your new digital projector provides computer and video inputs and delivers outstanding color using BrilliantColor™ technology. The projector is easy to connect, easy to use, and easy to maintain.

The IN35 and IN37 have XGA 1024x768 resolution while the IN35W has WXGA 1280x800 resolution.

Product specifications

To read the latest specifications on your multimedia projector, be sure to visit our website at www.infocus.com, as specifications are subject to change.

Accessories

The standard accessories that came with your projector are listed in the included user's guide. Optional accessories can be found on our website at www.infocus.com or at your retailer or dealer.

Online Registration

Register your projector on our website at www.infocus.com/register to activate your warranty and receive product updates, announcements, and registration incentives.

Projector components and features

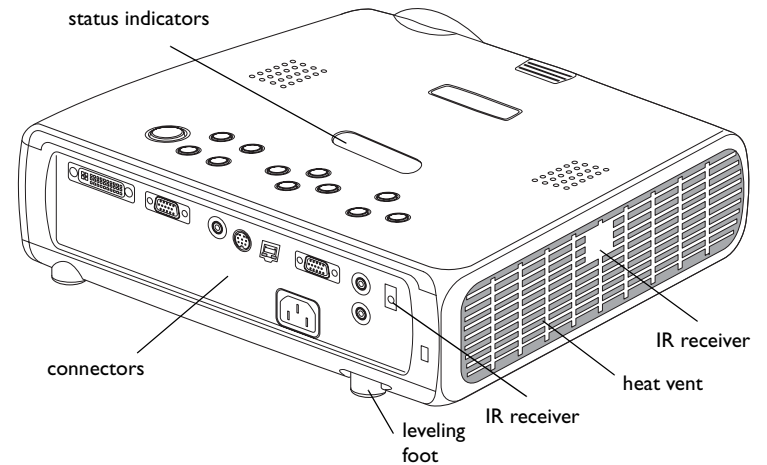
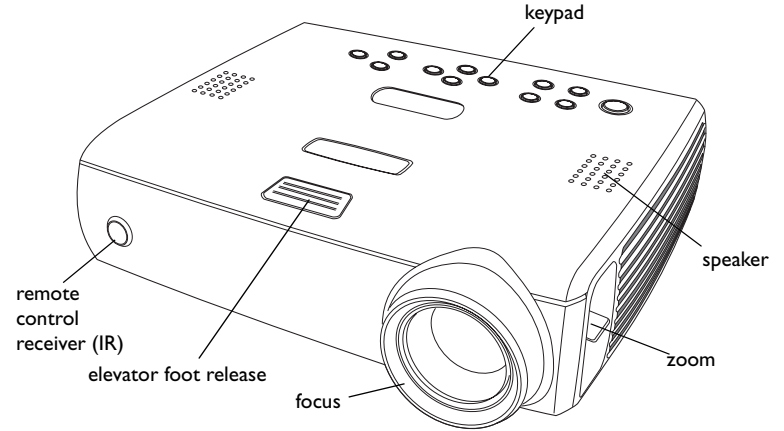

Connector Panel

The projector provides computer and video connectors:

- one M1-D/A (HD, DVI, and computer)
- one VESA (HD, HD component, and computer)
- one VESA (monitor out)
- one S-video
- one composite RCA video
- one audio in/one audio out

It also has an RJ-45 connector for serial control. The Command Line Interface (CLI) specifications and commands are on our website.

Connector panel

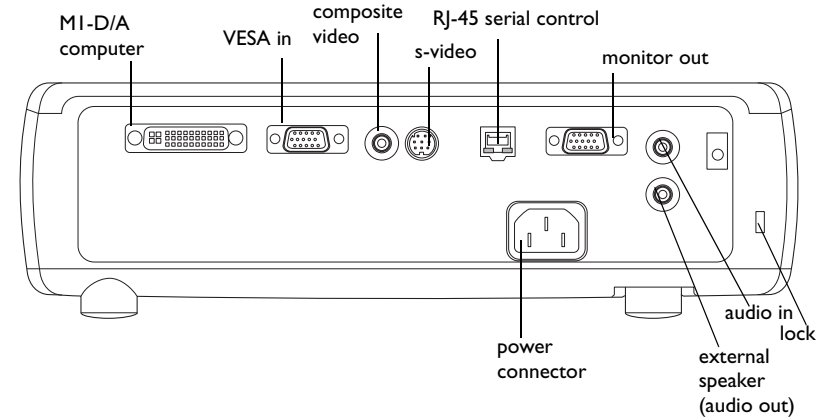

Connecting a computer

Required computer connections

Connect the black end of the computer cable to the **Computer I** connector on the projector. Connect the blue end to the video port on your computer. If you are using a desktop computer, you first need to disconnect the monitor cable from the computer's video port.

Some Macintosh® computers do not have a standard VESA-out video port. If the supplied computer cable will not connect to your computer, purchase the appropriate adapter from your Apple® reseller.

Connect the black power cable to the connector on the back of the projector and to your electrical outlet.

The Power light on the Status Indicator Panel (page 12) turns amber.

NOTE: Always use the power cable that shipped with the projector.

Optional computer connections

To advance slides in a PowerPoint™ presentation using the up and down arrow buttons on the remote, plug the USB connector on the computer cable into the USB mouse connector on your computer.

To have sound with your presentation, connect an audio cable (sold separately) to your computer and to the **Audio In** connector on the projector.

connect computer cable

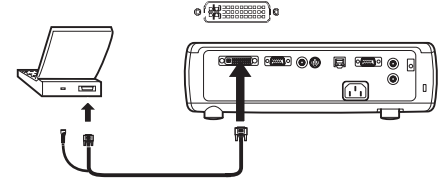

connect power cable

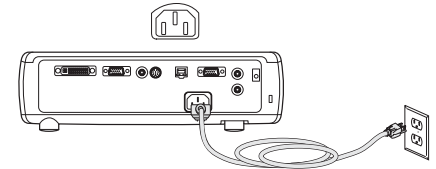

connect computer cable

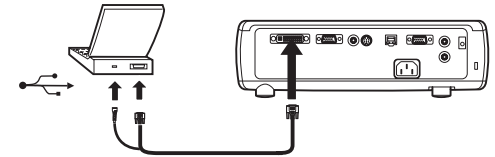

connect audio cable

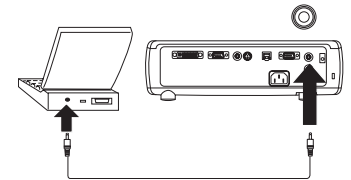

If you are using a desktop computer and want to see the image on your computer screen as well as on the projection screen, plug the monitor cable to the **Monitor Out** connector on the projector.

connect monitor cable

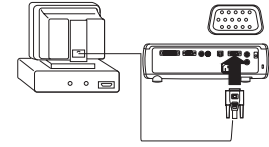

If you prefer connecting your projector to your computer with an optional VESA cable, connect one end of the cable to the VESA port on your computer, and connect the other end of the cable to the blue **Computer 2** connector on the projector.

connect VESA cable

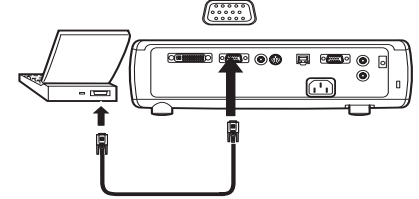

You can control the projector from an LCD control panel or computer by connecting an RS-232 cable to the projector's **Serial Control** connector. Specific RS-232 commands can be found in the Service and Support section of our website.

connect RS-232 cable

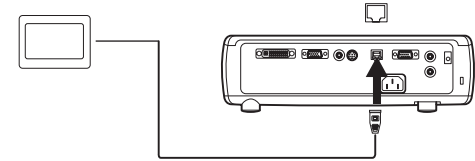

Displaying a computer image

Remove the lens cap.

remove lens cap

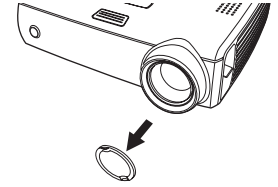

Press the **Power** button on the top of the projector or the remote.

press Power button

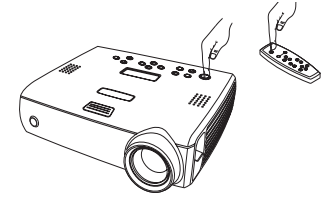

The Power light on the Status Indicator Panel (page 12) blinks green and the fans start to run. When the lamp comes on, the start up screen displays and the Power light is steady green. It can take a minute for the image to achieve full brightness.

? No startup screen? Get help on page 13.

Turn on your computer.

turn on computer



The computer's image should appear on the projection screen. If it doesn't, press the **Source** button on the projector's keypad.

Make sure your laptop's external video port is active.

activate laptop's external port

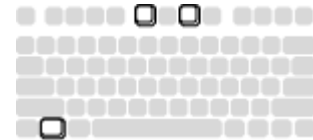

Many laptops do not automatically turn on their external video port when a projector is connected. Usually a key combination like FN + F8 or CRT/LCD key turns the external display on and off. Locate a function key labeled CRT/LCD or a function key with a monitor symbol. Press FN and the labeled function key simultaneously. **Refer to your laptop's documentation to learn your laptop's key combination.**

? No computer image? Try pressing the **Auto Image** button on the keypad. Get help on page 13.

Adjusting the image

Adjust the height of the projector, if necessary, by pressing the release button to extend the elevator foot.

Rotate the leveling foot (located at the bottom back right corner), if necessary.

Position the projector the desired distance from the screen, so that the lens is perpendicular to the screen.

See page 35 for a table listing screen sizes and distances.

Adjust the zoom or focus rings by rotating them until the desired image size and focus are produced.

If the image is not square, adjust the vertical digital keystone by using the buttons on the keypad. Press the upper **Keystone** button to reduce the upper part of the image, and press the lower **Keystone** button to reduce the lower part.

You can also adjust the keystone via the menus. See page 25.

Adjust the Contrast or Brightness in the Picture menu.

See page 24 for help with the menus.

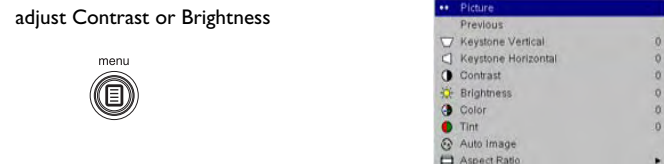
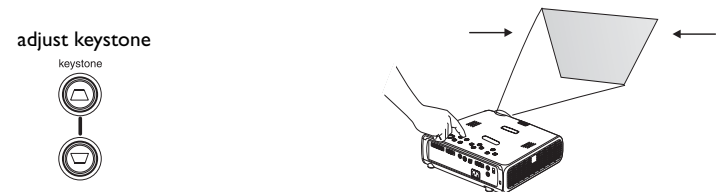
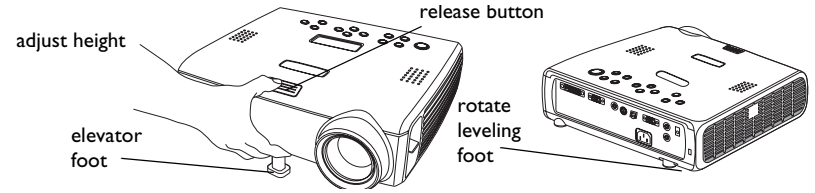

Connecting a video device

No video or audio cables are included with your projector.

If the video device uses a round, four-prong S-video connector, plug an S-video cable into that connector on the video device and into the **Video 2** connector on the projector. If the device uses a composite video connector, plug a composite video cable into that connector on the video device and into the **Video 1** connector on the projector.

For audio, plug a mini-plug audio Y-cable into the **Audio in** connector on the projector and into the video device's left and right audio out connectors.

Connect the black power cable to the connector on the back of the projector and to your electrical outlet.

NOTE: Always use the power cable that shipped with the projector.

To connect a progressive scan EDTV or HD source, use the Component to M1 adapter (sold separately).

connect S-video and audio cables

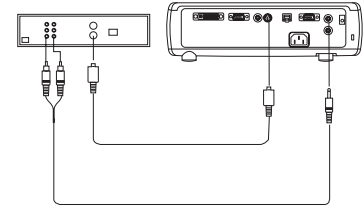

connect video and audio cables

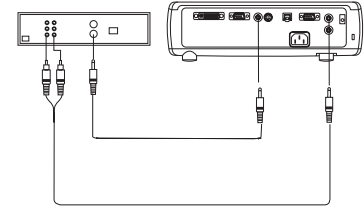

connect power cable

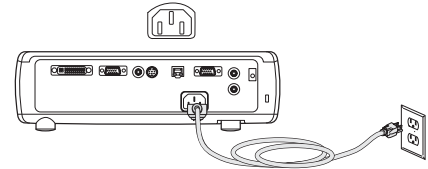

Displaying a video image

Remove the lens cap.

Press the **Power** button on the top of the projector or the remote. The Power light on the Status Indicator Panel (page 12) blinks green and the fans start to run. When the lamp comes on, the start up screen displays and the Power light is steady green. It can take a minute for the image to achieve full brightness.

? No startup screen? Get help on page 12.

Plug in and turn on the video device.

The video device's image should appear on the projection screen. If it doesn't, press the **Source** button on the keypad.

Adjust the height of the projector by pressing the release button to extend the elevator foot. Rotate the leveling foot, if necessary.

Position the projector the desired distance from the screen, so that the lens is perpendicular to the screen. See page 35 for a table listing screen sizes and distances to the screen.

remove lens cap



press Power button



turn on video device

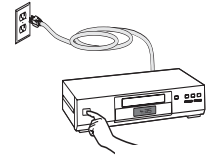

adjust height

release button

elevator foot

rotate leveling foot

adjust distance

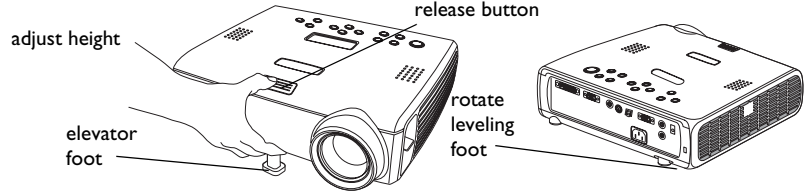
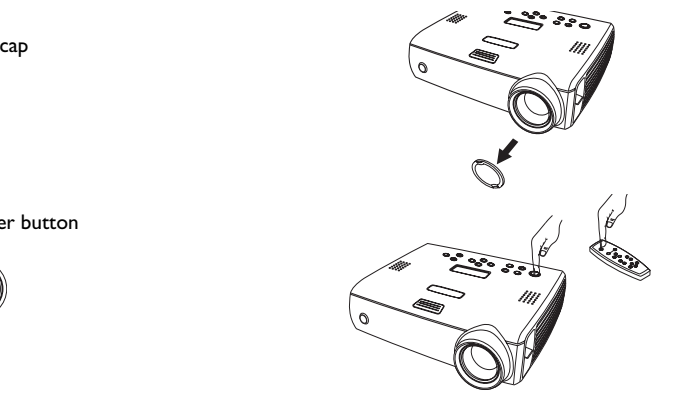
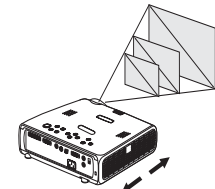

Adjust the zoom or focus rings by rotating them until the desired image size and focus are produced.

adjust zoom and focus

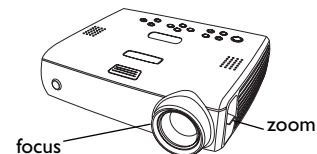

If the image is not square, adjust the vertical keystone using the buttons on the keypad.

Press the upper **Keystone** button to reduce the upper part of the image, and press the lower **Keystone** button to reduce the lower part. You can also adjust the keystone via the menus. See page 25.

adjust keystone

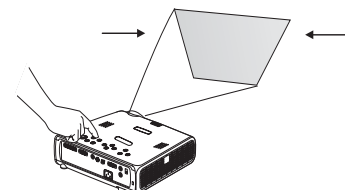

Adjust the volume on the keypad.

adjust volume

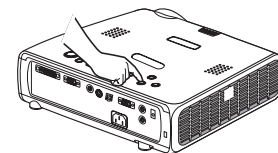

Adjust the **Contrast**, **Brightness**, **Color**, or **Tint** in the Picture menu.

See page 24 for help with the menus.

adjust Picture menu

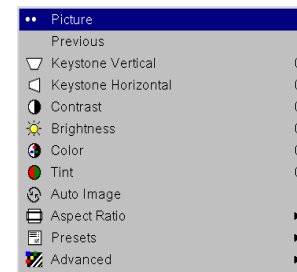

Shutting down the projector

Turning off the projector

To turn off the projector, press the **Power** button and verify that you want to turn the projector off by pressing the **Power** button again within 3 seconds. You can cancel the shutdown by not pressing the **Power** button a second time. The lamp turns off and the LED blinks amber for 1 minute while the fans continue to run to cool the lamp. When the lamp has cooled, the LED lights amber and the fans stop. Unplug the power cable to completely power off the projector.

Power Save

The projector has a Power Save feature that automatically turns the lamp off after no signal is detected for 20 minutes. After 10 additional minutes with no signal, the projector powers down. If an active signal is received before the projector powers down, the image is displayed. You must press the **Power** button to display an image after 30 minutes have passed. When Power Save is enabled, Screen Save is disabled. See page 29.

Screen Save

You can make a blank screen appear five minutes after no signal is detected by turning on Screen Save in the **Settings>System** menu. See page 29. There are six time options for the Screen Save feature. They range from five minutes to 30 minutes with five minute intervals.

Troubleshooting your setup

If your image appears correctly on the screen, skip to the next section (page 21). If it does not, troubleshoot the setup.

The Status Indicator Panel on top of the projector indicates the state of the projector and can help you troubleshoot.

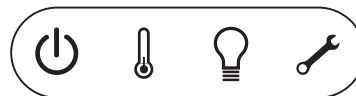



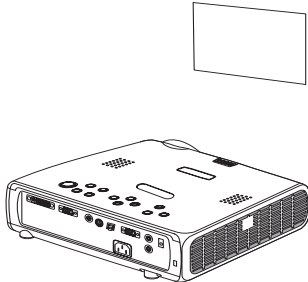
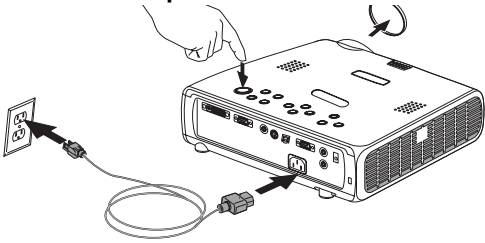
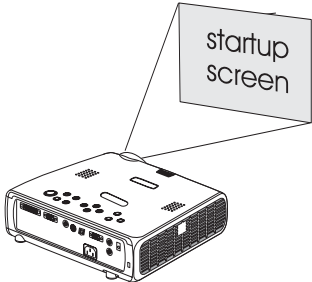
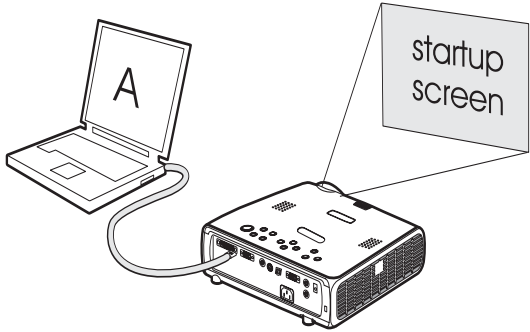

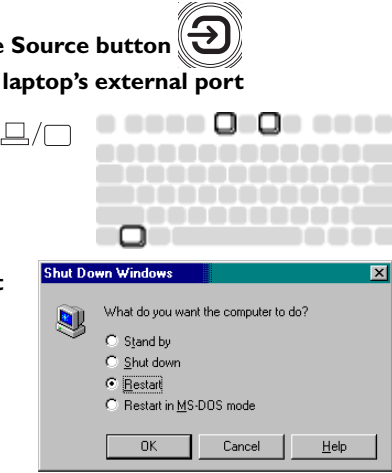
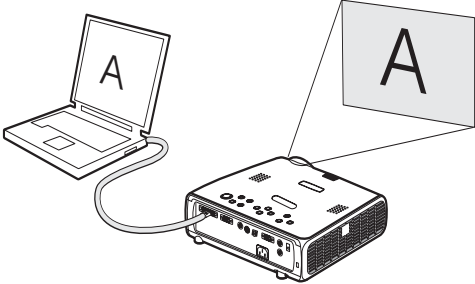

Table I: Status indicator light behavior and meaning

Status Indicator Panel Symbols	Meaning
Power, solid amber 	The projector is plugged in.
Power, blinking green	The power button has been pressed and the software is initializing.
Power, solid green	The projector is on and initialized.
Power, blinking amber	The power button has been pressed twice to turn the projector off and the fans are running to cool the projector.
Thermometer 	The projector is too hot. Make sure the vents aren't blocked (see page 19). Turn off the projector and wait one minute, then turn the projector on again. Contact Technical Support if the problem persists.
Lamp 	Turn off the projector and wait one minute, then turn the projector on again. If the lamp light turns on again, replace the lamp and reset the lamp timer.
Wrench/Service 	Turn off the projector and wait one minute, then turn the projector on again. If the service lamp turns on again, service is required. Visit www.infocus.com/service to contact Service.

Source Troubleshooting

Problem	Solution	Result
<p data-bbox="48 153 260 179">No startup screen</p> 	<p data-bbox="663 151 1124 204">Plug power cable in, press Power button. Remove lens cap.</p> 	<p data-bbox="1183 153 1357 179">Correct image</p> 
<p data-bbox="48 544 371 569">Only startup screen appears</p> 	<p data-bbox="663 576 1013 635">Press the Source button  Activate laptop's external port</p> <p data-bbox="663 812 770 865">or restart laptop</p> 	<p data-bbox="1183 541 1499 567">Computer image projected</p> 

No computer image, just the words “Signal out of range”

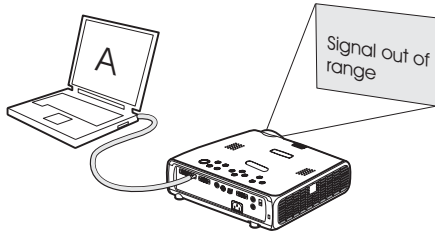

Adjust computer refresh rate in Control Panel>Display>Settings>Advanced>Adapter (location varies by operating system)

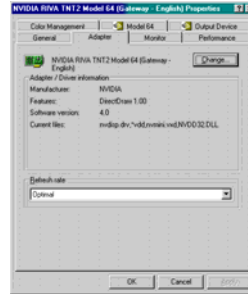

You may also need to set a different resolution on your computer, as shown in the following problem, “Image fuzzy or cropped”

Computer image projected

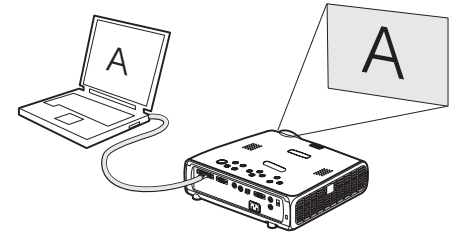

For PC: Image fuzzy or cropped

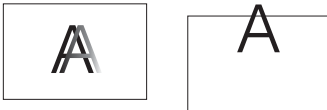

Set your computer’s display resolution to the native resolution of the projector (Start>Settings>Control Panel>Display>Settings tab, select 1024x768)

For a laptop, disable laptop monitor or turn-on dual-display mode



Image clear and not cropped



For Macintosh: Image fuzzy or cropped

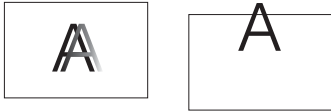

**Set your computer's display resolution to the native resolution of the projector
(Apple menu>System Preferences>Displays, choose 1024x768)**

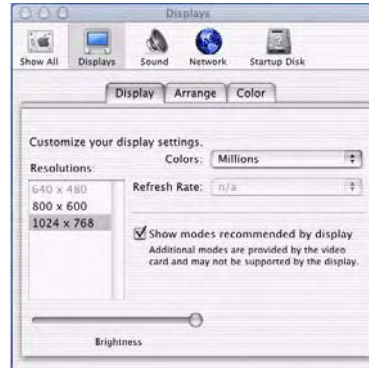
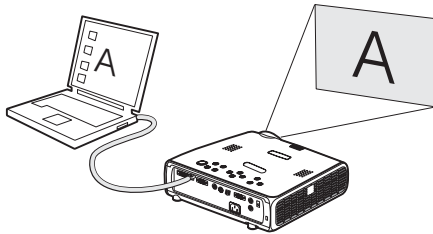

Image clear and not cropped



Only my laptop's background appears, not the Desktop icons



Disable "Extend my Windows Desktop" in Control Panel>Display>Settings>Display 2 (location varies by operating system)

Uncheck this option, then click Apply

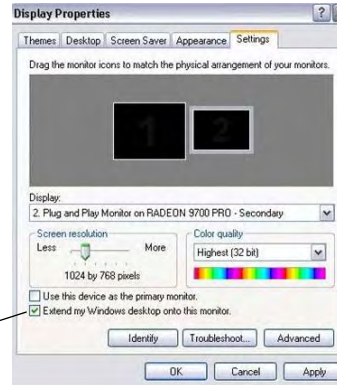

Background and Desktop projected

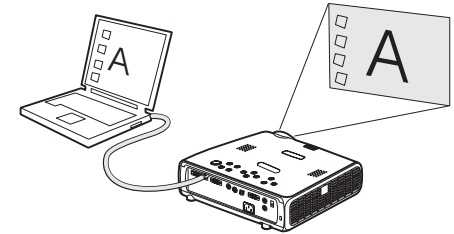

The video embedded in my PowerPoint presentation does not play on the screen

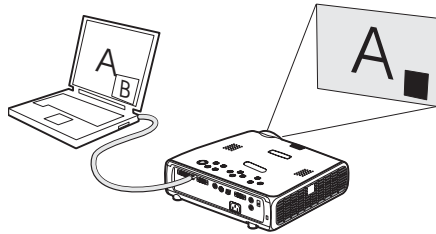

Turn off the internal LCD display on your laptop

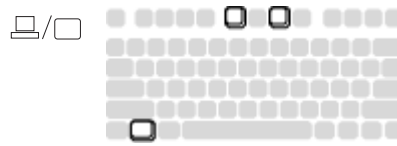

Embedded video plays correctly

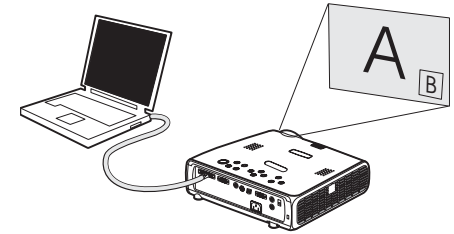

Projector troubleshooting





Problem	Solution	Result
<p>Image not square</p> 	<p>Adjust keystone on keypad or Picture menu</p> 	<p>Square image</p> 
<p>Image not sharp</p> 	<p>Adjust the focus lens or Sharpness in the Picture>Advanced menu</p> 	<p>Correct image</p> 

Image does not fit 16:9 screen

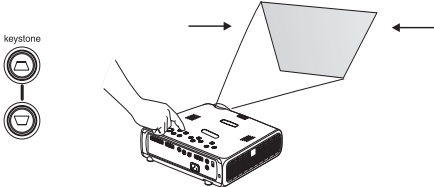

**Change aspect ratio to 16:9 in
Picture>Aspect ratio menu**

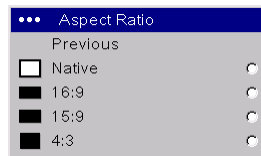

Correct image



Image upside down



Turn off Ceiling in Settings>System menu

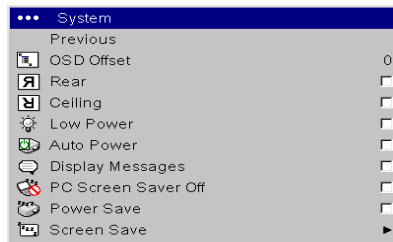

Correct image



Image reversed left to right



Turn off Rear in Settings>System menu

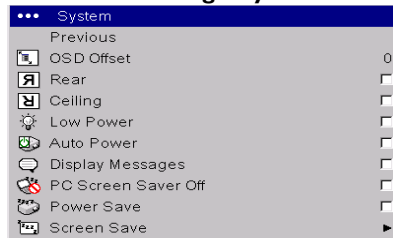

Correct image



Projected colors don't match source

~~COLOR~~

Adjust color, tint, color temperature, brightness, contrast in the menus

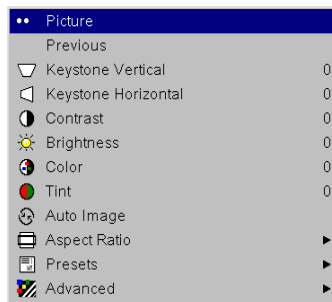

Correct image

COLOR

Image not centered on screen

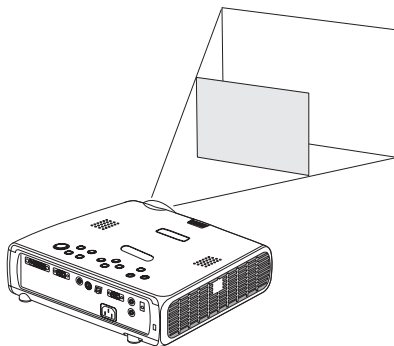

Move projector, adjust zoom, adjust height

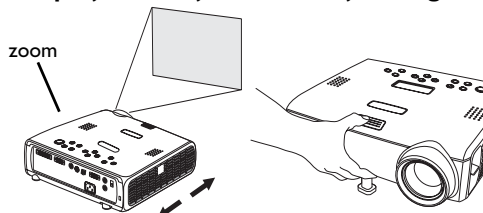

Adjust horizontal or vertical position in Picture>Advanced menu

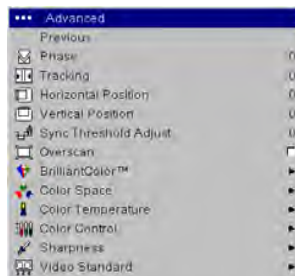

Correct image

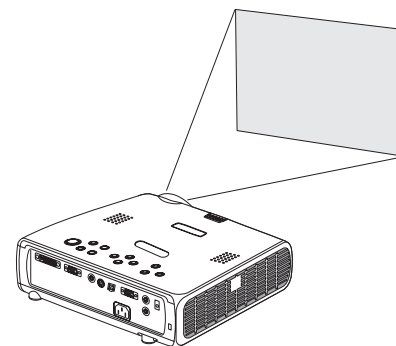

Lamp won't turn on, Temperature light is on

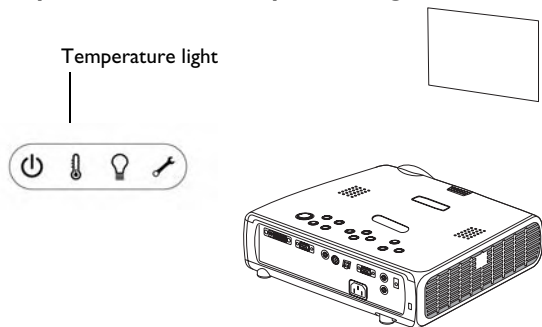

Make sure vents aren't blocked; allow projector to cool for one minute

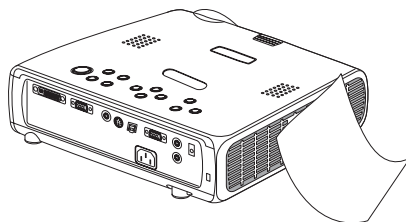

Unplug projector; wait one minute; plug in projector and turn it on: lamp lights

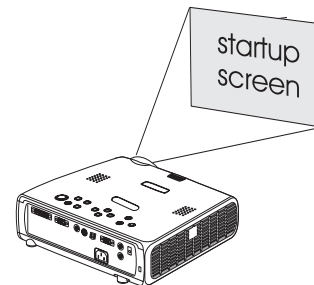

"Change lamp" message appears at startup, lamp won't turn on, Lamp light is turned on

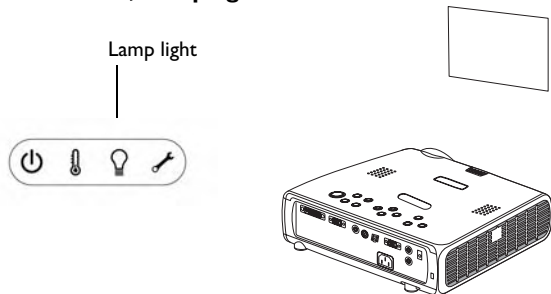

Lamp must be replaced (page 33)

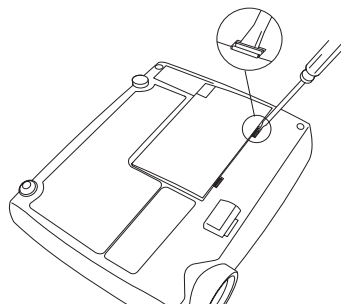

Lamp turns on

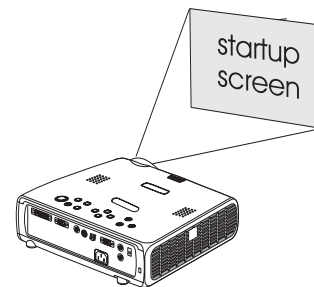

Still having problems?

If you need assistance, visit the Service and Support section of our website or call us.

This product is backed by a limited warranty. An extended warranty plan may be purchased from your dealer. When sending the projector in for repair, we recommend shipping the unit in its original packing material, or having a professional packaging company pack the unit. Please insure your shipment for its full value.

Using the keypad buttons

Most buttons are described in detail in other sections, but here is an overview of their functions:

power—turns the projector on (page 7) and off (page 12).

menu—opens the on-screen menus (page 24).

select—confirms choices made in the menus (page 24).

up/down arrows—navigates to and adjusts settings in the menus (page 24).

auto image—resets the projector to the source.

presets—cycles through the available preset settings (page 26).

keystone—vertical keystone adjusts the squareness of the image (page 8). You can also adjust the keystone via the menus. See page 25.

volume—adjusts sound (page 22).

source—changes the active source.

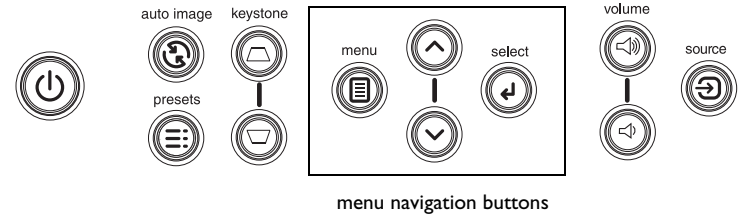

Using the remote control

The remote uses two (2) provided AA batteries. They are easily installed by sliding the cover off the remote's back, aligning the + and - ends of the batteries, sliding them into place, and then replacing the cover.

Caution: When replacing the batteries, be aware that using batteries other than the type provided with the projector may risk severe damage to the remote. When disposing of the batteries, be sure to do so in an environmentally proper manner.

To operate, point the remote at the front of the projector (not at the computer). The range of optimum operation is about 15 feet (4.5m).

Press the remote's **Power** button to turn the projector on and off (see page 12 for shutdown info).

Press the remote's **Menu** button to open the projector's menu system. Use the arrow buttons to navigate, and the **Select** button to select features and adjust values in the menus. See page 24 for more info on the menus.

The remote also has a **Source** button to switch between sources.

If you connect the USB portion of the M1-DA computer cable (page 5) you can use the up and down arrow navigation buttons to advance slides in a PowerPoint presentation.

Troubleshooting the remote

- Make sure the batteries are installed in the proper orientation and are not dead.
- Make sure you're pointing the remote at the projector or the screen, not the computer, and are within the remote range of 15 feet (4.5m). For best results, point the remote at the projector.

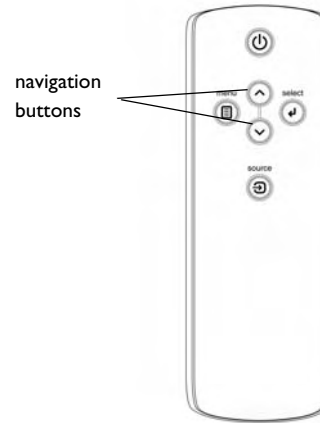

Using the audio

To play sound from the projector, connect your source to the **Audio In** connector on the projector.

To adjust the volume, use the buttons on the keypad.

To adjust the balance or turn off the projector's chime, use the Audio menu (see page 28).

Troubleshooting audio

If there is no sound, check the following:

- Make sure the audio cable is connected.
- Make sure mute isn't active.
- Make sure the volume is turned up enough. Press the **Volume** button on the keypad.
- Adjust the audio source.
- If playing a video, make sure the playback has not been paused.

connect audio cable

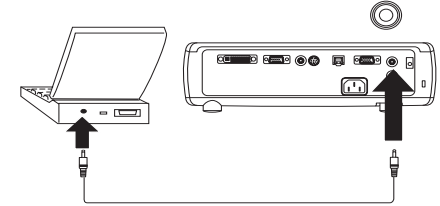

adjust volume

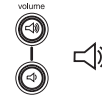

Connecting external speakers

The projector can be attached to external speakers that have their own power source by plugging a speaker cable into the projector's **Audio Out** connector.

external speakers

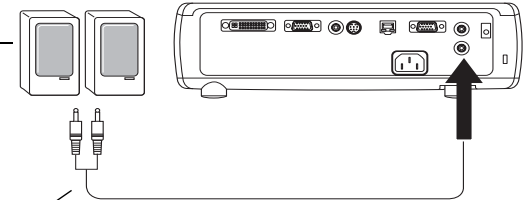

speaker cable

Optimizing computer images

After your computer is connected properly and the computer's image is on the screen, you can optimize the image using the onscreen menus. For general information on using the menus, see page 24.

- Adjust the Keystone, Contrast, or Brightness in the Picture menu.
- Change the Aspect Ratio. See page 25 for details.
- Adjust the Color Space, Temperature or Control in the Advanced menu.
- Adjust the Phase, Tracking, or Horizontal or Vertical position in the Advanced menu.
- Once you have optimized the image for a particular source, you can save the settings using Presets. This allows you to quickly recall these settings later. See page 26.

Presentation features

Several features are provided to make giving presentations easier. The following is an overview, details are found in the menu section on page 24.

- The Custom key, available on several optional remotes only, allows you to assign various features to the button. See page 30 for details.
- The Startup Logo menu option lets you change the default startup screen to a black, white, or blue screen. See page 29.
- Two menu options, Power Save and Screen Save, are provided to automatically shut down the projector after several minutes of inactivity or display a blank screen. This helps preserve lamp life. See page 29.

Optimizing video images

After the video device is connected properly and the image is on the screen, you can optimize the image using the onscreen menus. For general information on using the menus, see page 24.

- Adjust the Keystone, Contrast, Brightness, Color, or Tint in the Picture menu. See page 25.
- Change the Aspect ratio. Aspect ratio is the ratio of the image width to image height. TV screens are usually 1.33:1, also known as 4:3. HDTV and most DVDs are 1.78:1, or 16:9. Choose the option that best fits your input source. See page 25.
- Select a Sharpness, Color Temperature, or Video Standard setting. See page 27.
- Adjust the Color Control or White Peaking settings. See page 27.

Customizing the projector

You can customize the projector for your specific setup and needs. See page 28 to page 32 for details on these features.

- For rear projection, turn Rear mode on in the **Settings>System** menu.
- For ceiling mounted projection, turn Ceiling mode on in the **Settings>System** menu.
- Specify which source the projector checks first for active video during power-up.
- Specify the function of the Custom Key on the optional remote.
- Turn the projector's display messages on and off.
- Turn on power saving features.
- Specify blank screen colors and startup logos.
- Specify the menu language.
- Control your projector using RS-232 commands. See page 6.

Using the menus

To open the menus, press the **Menu** button on the keypad or remote. (The menus automatically close after 60 seconds if no buttons are pressed.) The Main menu appears. Use the arrow buttons to move up and down to highlight the desired submenu, then press the **Select** button.

To change a menu setting, highlight it, press **Select**, then use the up and down arrow buttons to adjust the value, select an option using radio buttons, or turn the feature on or off using check boxes. Press **Select** to confirm your changes. Use the arrows to navigate to another setting. When your adjustments are complete, navigate to Exit, then press **Select** to go to the previous menu; press the **Menu** button at any time to close the menus.

Dots appear before the menu name. The number of dots indicate the menu's level, ranging from one (the Main menu) to four (the most nested menus).

The menus are grouped by usage:

- The Picture menu provides image adjustments.
- The Settings menu provides set-up type adjustments that are not changed often.
- The Source Info menu provides a read-only display of information about the projector and source.

Certain items will be grayed out or hidden until a particular source is connected. For example, Color is only available for video sources and will be hidden when a computer source is active. Other menu items may be grayed out when they are not available. For example, Brightness is grayed out until an image is active.

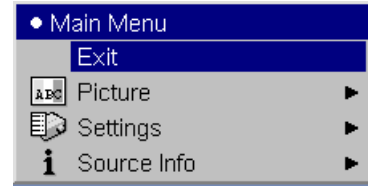

Main menu

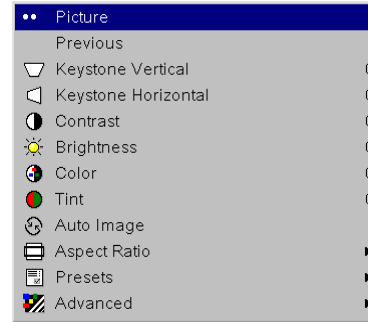
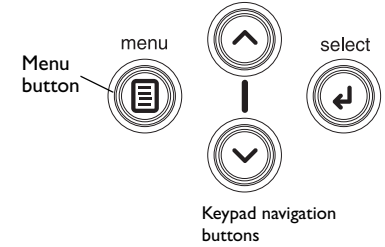

Picture menu

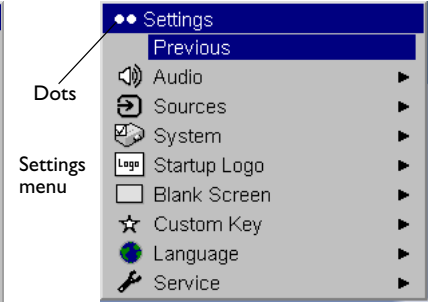

Source Info menu

Picture menu

To adjust the following six settings, highlight the setting, press **Select**, use the up and down arrows to adjust the values, then press select to confirm the changes.

Keystone Vertical: adjusts the image vertically and makes a squarer image. You can also adjust keystone from the keypad.

Keystone Horizontal: adjusts the image horizontally and makes a squarer image.

Contrast: controls the degree of difference between the lightest and darkest parts of the picture and changes the amount of black and white in the image.

Brightness: changes the intensity of the image.

Color: (video and component sources only) adjusts a video image from black and white to fully saturated color.

Tint: (NTSC video sources only) adjusts the red-green color balance in the image.

Auto Image: resets the projector to the source

Aspect Ratio: Aspect ratio is the ratio of the image width to image height. TV screens are usually 1.33:1, also known as 4:3. HDTV and most DVDs are 1.78:1, or 16:9. The default is 4:3, which displays the input resized up or down to fill the display area. The 15:9 option is only available on the WXGA version.

The aspect ratio selection is saved for each source.

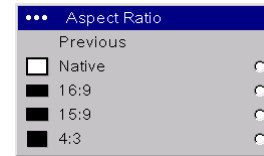
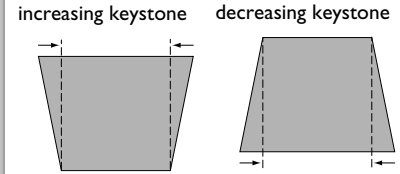
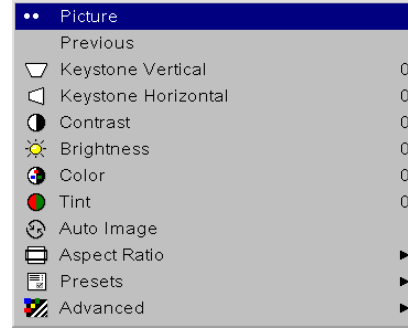

Aspect Ratio

Presets: Presets are provided that optimize the projector for displaying computer presentations and video images in different lighting conditions and on different backgrounds.

There are also user-definable presets. To set a preset for the current source, adjust the image, select Save Settings in the Presets menu, then select Save User 1 (or 2 or 3). You can recall these settings in the future by selecting the User 1 preset.

If you make any adjustments to the image, Presets Off will automatically be selected in the Preset menu to indicate changes have been made.

To restore the factory default settings, choose Factory Reset in the **Settings>Service** menu.

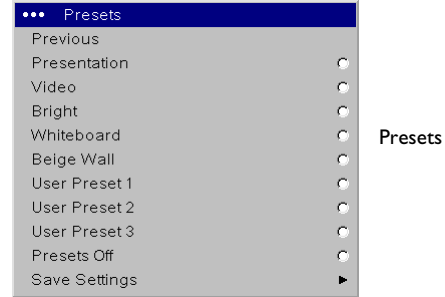

Advanced settings

The following 4 options are for computer and component sources only.

Phase: adjusts the horizontal phase of a computer source.

Tracking: adjusts the vertical scan of a computer source.

Horizontal/Vertical Position: adjusts the position of a computer source.

Sync Threshold Adjust: (enhanced and high definition sources only) If a hardware device, such as a DVD player, is not syncing properly with the projector, select this option to help it sync.

Overscan: removes noise around the video image.

BrilliantColor™: produces an expanded on-screen color spectrum that delivers enhanced color saturation for bright, true-to-life images. Choose Normal Look for most video sources and Bright Look for most computer sources. **White Peaking:** adjusts the white level processed in the image. It increases the brightness of whites that are near 100%.

Color Space: This option applies to computer sources. It allows you to select a color space that has been specifically tuned for the video input. When Auto is selected, the projector automatically determines the standard. To choose a different setting, turn off Auto, then choose RGB for computer sources, choose either REC709 or REC601 for component sources.

Color Temperature: changes the intensity of the colors. Select a listed value.

Color Control: allows you to individually modify each color. Highlight the color, press **Select**, then use the arrows to adjust the value.

Sharpness: changes the clarity of the edges of a video image. Select a sharpness setting.

Video Standard: (video sources only) When it is set to Auto, the projector attempts to pick the video standard automatically based on the input signal it receives. (The video standard options may vary depending on your region of the world.) If the projector is unable to detect the correct standard, the

colors may not look right or the image may appear “torn.” If this happens, manually select a video standard by selecting NTSC, PAL, or SECAM from the Video Standard menu.

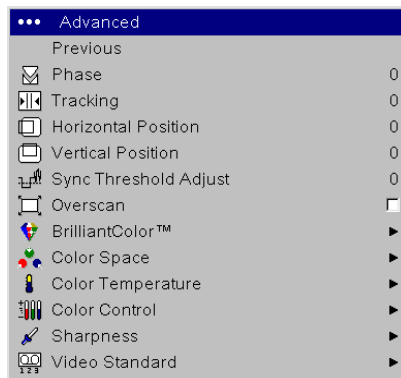

Advanced



BrilliantColor



Color Space

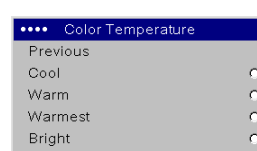

Color Temperature

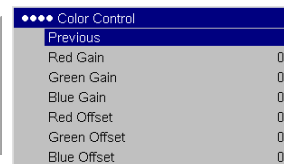

Color Control



Sharpness

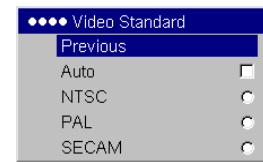

Video Standard

Settings menu

Audio: allows adjustments to the volume and balance, and turns the projector's startup Chime on and off.

Sources: allows you to assign a particular input to a specific source key when using an optional remote. Also allows selection of a default Power-up Source and enables or disables Autosource.

Sources>Power-up Source: this determines which source the projector checks first for active video during power-up.

Sources>Autosource: When Autosource is not checked, the projector defaults to the source selected in Power-up Source. If no source is found, a blank screen displays. When Autosource is checked, Power-up Source determines which source the projector defaults to at startup. If no signal is present, the projector checks the sources in order until a source is found or until power down. When **Autosource** is selected, the **Source Enable** feature indicates which sources the projector attempts to lock onto. You can use the Source Enable feature to eliminate certain sources from this search, which will speed the search. By default, the check boxes for all sources are checked. Uncheck a source box to eliminate it from the search. When Autosource is not checked, the projector defaults to Computer 1 initially, then defaults to whatever source is selected in the Power-up Source menu. To display another source, you must manually select one by pressing the **Source** button on the remote or keypad. This cycles through all the sources that are selected in the Source Enable menu.

System>OSD Offset: allows you to change the position of the On Screen Display items.

Rear: reverses the image so you can project from behind a translucent screen. **Ceiling:** turns the image upside down for ceiling-mounted projection.

Low Power: Turn this on to lower the light output of the lamp. This also lowers the fan speed, making the projector quieter.

Auto Power: When Auto Power is checked, the projector automatically goes into the startup state after power is applied. This allows control of ceiling mounted projectors with a wall power switch.

Display Messages: displays status messages (such as "Searching" or "Mute") in the lower-left corner of the screen.

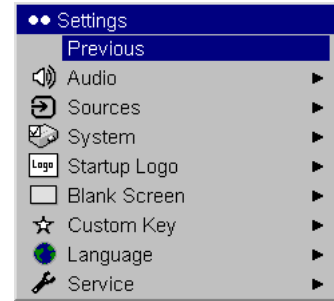

Settings

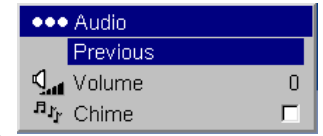

Audio

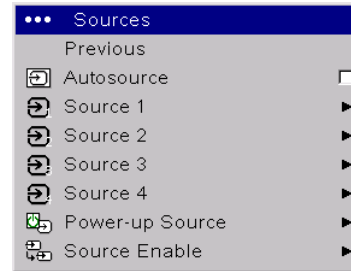

Sources

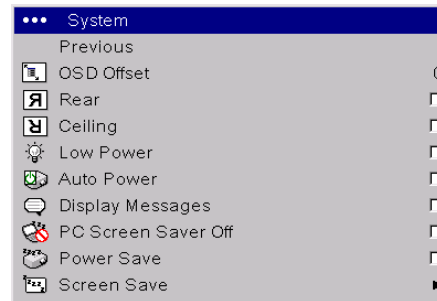
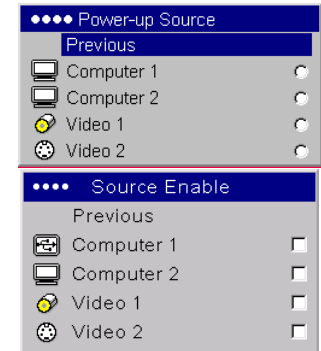

System

PC Screen Saver Off: prevents your computer from going into Screen Save mode. This feature is only available if the USB portion of the computer cable is connected to your computer (page 5).

Power Save: automatically turns the lamp off after no signals are detected for 20 minutes. After 10 additional minutes with no signal, the projector powers down. If an active signal is received before the projector powers down, the image will be displayed.

Screen Save: automatically blanks the screen with a black color after no signals are detected for a preset number of minutes. The image returns when an active source is detected or a remote or keypad button is pressed. Screen Save is disabled when Power Save is enabled.

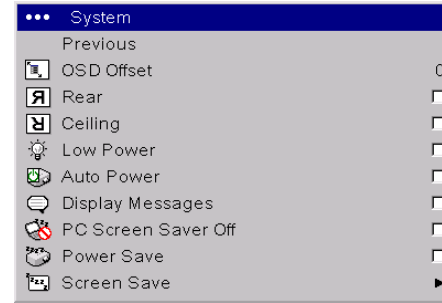

System

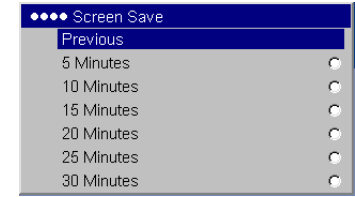

Screen Save

Startup Logo: allows you to display a blank Black, White, or Blue screen instead of the default screen at startup and when no source is detected.



Startup Logo

Blank Screen: determines what color is displayed when no source is detected.

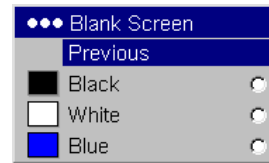

Blank Screen

Custom Key (for use with optional remote only): allows you to assign a different function to the **Custom** button on the remote to quickly and easily use the effect. Only one effect can be enabled at a time. Highlight an effect and press **Select** to choose a different one. The default effect is About.

- **Blank:** displays an empty screen.
- **Mute:** turns off all sound.
- **Aspect Ratio:** toggles among 4:3, 16:9, and Native (see page 25).
- **Source:** cycles through available sources.
- **Auto Image:** resets the projector to the source (page 20).
- **Freeze:** pauses the projected image.
- **Source Info:** the default effect. It opens a window with projector and source information.
- **Source 4:** selects Source 4.
- **Service Info:** opens a window with projector and source information.

Language: allows you to select a language for the onscreen display of menus and messages.

Service: to use these features, highlight them and press **Select**.

Factory Reset: restores all settings (except Lamp Hours) to their default after displaying a confirmation dialog box.

Reset Lamp Hours: resets the lamp hours counter in the Service Info menu to zero. Do this only after changing the lamp. It displays a confirmation dialog box.

PIN: see the next section.

Test Pattern: allows you to display certain patterns to adjust the image. This feature only works with an optional remote. To display test patterns, click the Test Pattern check box, exit the menus, then press the **Blank** button on the remote. To select the patterns, use the up/down arrows on the remote or keypad. To exit the test patterns, press the **Blank** button again.

Serial Port: allows you to select echo status and Baud rate.

Service Info: provides information about the projector and lamp. **Service Code:** only used by authorized service personnel.

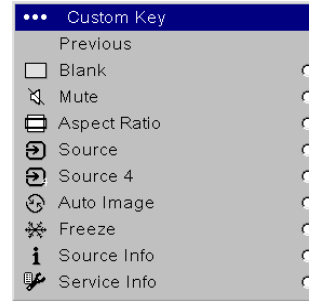

Custom Key



Language

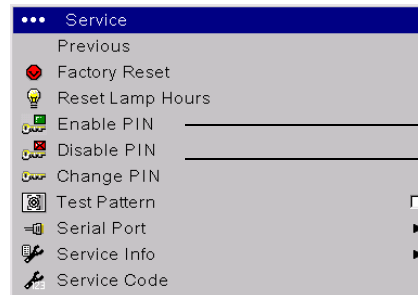

Service menu

appears only when PIN is disabled

appears only when PIN is enabled

PIN feature

The PIN (personal identification number) feature allows you to password protect your projector. Once you enable the PIN feature, you must enter the PIN before you can project an image.

To use this feature, you must register your projector at www.infocus.com/register and follow the instructions there to get a default PIN. The PIN consists of a sequence of 5 navigation button presses. The navigation buttons are menu, select, up arrow and down arrow. Once you have this PIN, select Enable PIN in the Service menu. The Enter PIN dialog box appears.

Use the navigation buttons on the remote or keypad to enter the correct button press sequence. After pressing the first button, a dot appears in the current PIN slot and the highlighted cursor moves to the right one slot. When all 5 numbers are entered correctly, press the **Select** button on the remote or keypad to select OK. If the message “Incorrect PIN” appears, verify the code and re-enter it. If you mis-enter a number, you must enter 5 numbers and press the **Select** button in order to access the “Incorrect PIN” message and re-enter the code.

To enter the PIN at projector startup:

Power up the projector. The “Enter PIN” dialog box appears after the startup screen. Enter the PIN. Use the navigation buttons on the remote or keypad to enter the correct button press sequence. See the description above for instructions. If you lose or forget your PIN, go to www.infocus.com/pin.

To change the PIN:

Select “Change PIN” in the Service menu. Enter the existing PIN. Enter the new PIN. You can navigate between OK and Cancel by pressing the up and down buttons on the keypad. Select OK or Cancel by pressing the **Select** button. Verify the new PIN.

To reset the PIN back to the default:

Power up the projector. After the “Enter PIN” dialog box appears, press and hold the **Select** button down for 10 seconds. Enter the default PIN to use the projector. If you lose or forget your default PIN, go to www.infocus.com/pin.



Maintenance

Cleaning the lens

- 1 Apply a non-abrasive camera lens cleaner to a soft, dry cloth.

Avoid using an excessive amount of cleaner, and don't apply the cleaner directly to the lens. Abrasive cleaners, solvents or other harsh chemicals might scratch the lens.

- 2 Lightly wipe the cleaning cloth over the lens in a circular motion. If you don't intend to use the projector immediately, replace the lens cap.

clean the lens
with a soft dry cloth
and non-abrasive
cleaner

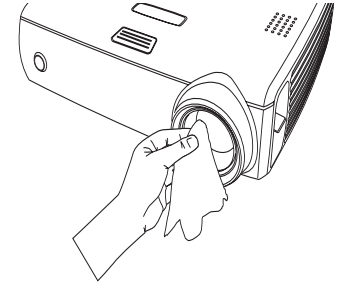

Using the security lock

The projector has a security lock for use with a cable lock system. Refer to the information that came with the lock for instructions on how to use it.

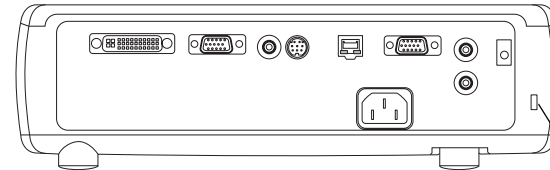

security lock

Replacing the projection lamp

The lamp hour timer in the Service Info menu counts the number of hours the lamp has been in use. Twenty hours before the specified end of the lamp's life, the message "Replace lamp" briefly appears on the screen at each startup. When the expected lamp life has been reached, the Lamp indicator icon lights red (page 12).

NOTE: You can order new lamp housings from www.infocus.com (in select areas), your retailer or your dealer. Only InFocus lamps are tested and certified for use in this projector. InFocus is not liable for the performance, safety or certification of any other lamps. The use of other lamps violates the projector warranty and voids all certification marks on this projector.

- 1 Turn off the projector and unplug the power cable.
- 2 Wait 60 minutes to allow the projector to cool thoroughly.
- 3 Turn the projector upside down and remove the lamp door by placing a flat-blade screwdriver into the space between the lamp door and the projector and gently prying the door off.
- 4 Loosen the captive screw on the lamp module.

WARNINGS:

- To avoid burns, allow the projector to cool for at least 60 minutes before you replace the lamp.
- Only InFocus lamps are tested with this projector. Use of other lamps may cause electrical shock and fire.
- Unplug the power cord before replacing the lamp.
- Do not drop the lamp module. The glass may shatter and cause injury.
- Do not touch the glass lamp screen. Fingerprints can obscure projection sharpness.



Service Info menu

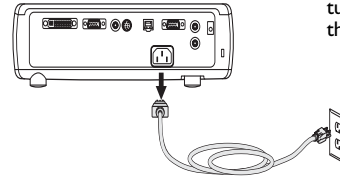

turn off and unplug
the projector

wait 60 minutes

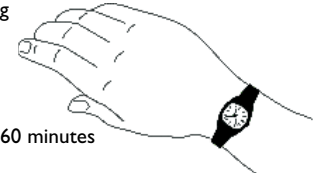

pry the lamp door off

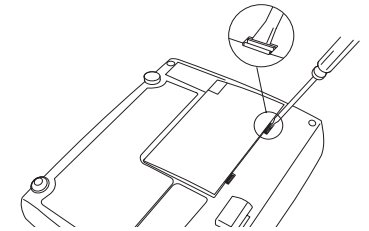

loosen the screw on lamp module

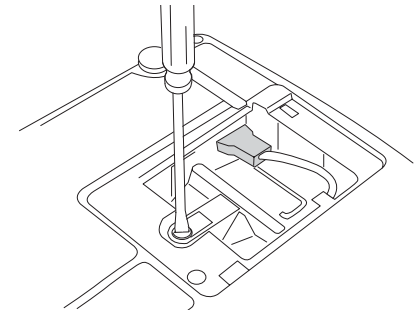

- Be extremely careful when removing the lamp housing. In the unlikely event that the lamp ruptures, small glass fragments may be generated. The lamp module is designed to contain most of these fragments, but use caution when removing it. Before replacing a ruptured lamp, clean the lamp compartment and dispose of cleaning materials. Wash hands after lamp replacement.

Hg – Lamp contains mercury. Manage in accordance with local disposal laws. See www.lamprecycle.org.

- 5 Detach the lamp connector from the projector by gently pulling the connector until it is disconnected from the projector.
- 6 Carefully remove the lamp module by grasping and lifting the metal bail wire. Dispose of the lamp in an environmentally proper manner.
- 7 Install the new lamp module, making sure that it is properly seated. Be careful not to touch the interior components of the projector.
- 8 Snap the bail wire back into its flat position against the lamp module.
- 9 Re-attach the lamp connector to the projector. Make sure the connector is fully inserted.
- 10 Tighten the screw on the lamp module.
- 11 Replace the lamp door.
- 12 Plug in the power cable then press the **Power** button to turn the projector back on, then reset the lamp hour timer.

Resetting the lamp timer

To reset the lamp timer, navigate to the **Settings>Service** menu and select **Reset Lamp Hours**.

disconnect lamp connector

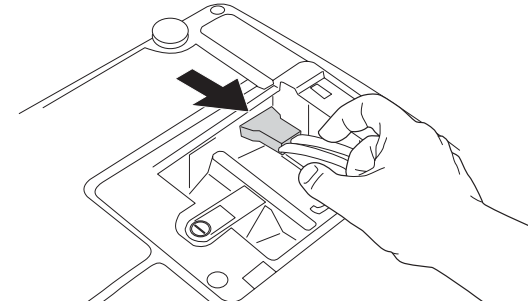

remove module using bail wire

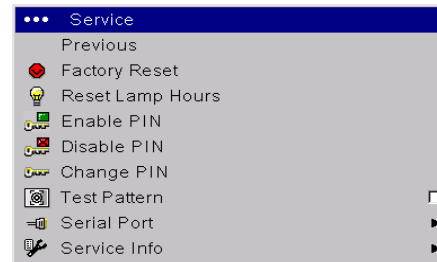
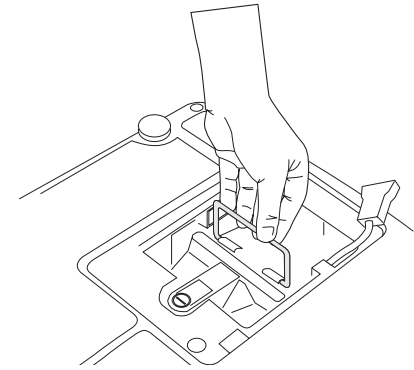

reset lamp time in Service menu

Appendix

Projected image size

**Table 2:
Image sizes for XGA**

Distance to screen (feet/m)	Minimum Diagonal (feet/m)	Maximum Diagonal (feet/m)	Minimum Horizontal (feet/m)	Maximum Horizontal (feet/m)
5/1.5	2.75/0.83	3.4/1.02	2.2/0.66	2.73/0.82
10/3	5.5/1.65	6.8/2.04	4.41/1.32	5.46/1.64
15/4.6	8.25/2.53	10.2/3.13	6.61/2.03	8.2/2.51
20/6.1	11/3.36	13.6/4.15	8.81/2.69	10.93/3.33
30/9.1	16.5/5.01	20.4/6.19	13.22/4.01	16.39/4.97
32.8/10	18.0/5.5	22.3/6.8	14.45/4.41	17.92/5.46

**Table 3:
Image sizes for WXGA**

Distance to screen (feet/m)	Minimum Diagonal (feet/m)	Maximum Diagonal (feet/m)	Minimum Horizontal (feet/m)	Maximum Horizontal (feet/m)
5/1.5	2.55/0.77	3.1/0.93	2.18/0.66	2.65/0.79
10/3	5.1/1.53	6.2/1.86	4.37/1.31	5.29/1.59
15/4.6	7.65/2.35	9.3/2.85	6.55/2.01	7.94/2.43
20/6.1	10.2/3.11	12.4/3.78	8.73/2.66	10.58/3.23
30/9.1	15.3/4.64	18.6/5.64	13.1/3.97	15.87/4.81
32.8/10	16.73/5.1	20.34/6.2	14.32/4.37	17.35/5.29

NOTE: Visit our website for an interactive image size calculator.

INDEX

A

Advanced setting 27
Aspect Ratio 25, 30
audio 22
Audio In connector 5, 9
audio volume 11
audio, troubleshooting 22
Auto Power 28
Autosource 28

B

Blank screen 29
Brightness 8
BrilliantColor 27

C

Ceiling 28
cleaning the lens 32
Color 11, 25
Color Control 27
Color Space 27
Color Temperature 27
colors are incorrect 18
Computer 2 connector 6
computer connections
 optional 5
 required 5
computer image
 optimize 23
 troubleshooting 13
connecting
 computer 5
 external speakers 22
 video device 9
connector panel 4
contacting InFocus 19
Contrast 8, 11, 25

Custom key 23
customer service contact information 19

D

Display Messages 28
displaying
 computer image 7
 video image 10

E

elevator foot 8

F

Factory Reset 30
focus 8, 11
fuzzy image 14

I

image
 display computer 7
 display video 10
image does not fit screen 17
image not centered 18
image not sharp 16
image not square 16
image reversed 17
image size matrix 35
image upside down 17

K

keypad buttons 20
keystone 8, 25

L

lamp replacement 33
Lamp Reset 30
lamp won't turn on 19
Language 30

laptop

 connecting 5
 external video port 7
lens, cleaning 32
leveling foot 8

lock, security 32
Low Power 28
M
Macintosh troubleshooting 15
Main menu 24
menu system 24
Monitor connector 6
N
no computer image 14
no startup screen 13
O
only startup screen appears 13
onscreen menus 24
Overscan 27
P
password-protecting the projector 31
PC Screen Saver 29
personal identification number 31
Picture menu 25
PIN 31
Position 27
power cable 5, 9
Power Save 12, 29
Power-up Source 28
presentation features 23
projected image sizes 35
projector
 adjusting the height 8, 10
 connector panel 4
 customizing 23
 password-protecting 31
 PIN 31
 positioning 8
 registering 3
 safety considerations 2
 troubleshooting problems 12

R
Rear 28
remote control 21
replacing the lamp 33
Reset 30
resetting the lamp timer 34
resolution 3
RS-232 4, 6
S
Screen Save 12, 29
security lock 32
serial connection 6
Service 30
Settings menu 28
Sharpness 27
Source troubleshooting 13
Sources 28
speakers, connecting 22
Startup Logo 29
Sync Threshold Adjust 27
T
Tint 11, 25
Tracking 27
Troubleshooting 12, 13
Turning off the projector 12
U
using the keypad buttons 20
V
VESA connector 6
video connections 9
video images, optimizing 23
Video Standard 27
W
White Peaking 27
X
XGA 3

