

HOME THEATER DLP™ PROJECTOR

MODEL

**HC2000**

User Manual

*HC2000*

**This User Manual is important to you.  
Please read it before using your projector.**

ENGLISH

FRANÇAIS

DEUTSCH

ITALIANO

ESPAÑOL

中文

РУССКИЙ

한국어

PORTUGUÊS

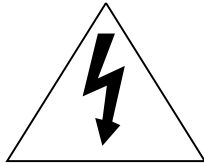

## CAUTION

RISK OF ELECTRIC SHOCK  
DO NOT OPEN

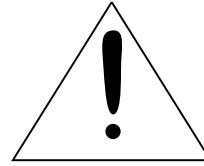

**CAUTION:** TO REDUCE THE RISK OF ELECTRIC SHOCK,  
DO NOT REMOVE COVER (OR BACK)  
NO USER-SERVICEABLE PARTS INSIDE  
REFER SERVICING TO QUALIFIED SERVICE PERSONNEL.

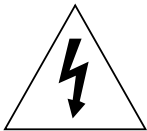

The lightning flash with arrowhead symbol within an equilateral triangle is intended to alert the user to the presence of uninsulated “dangerous voltage” within the product’s enclosure that may be of sufficient magnitude to constitute a risk of electric shock.



The exclamation point within an equilateral triangle is intended to alert the user to the presence of important operating and maintenance (servicing) instructions in the literature accompanying the appliance.

### **WARNING:**

TO PREVENT FIRE OR SHOCK HAZARD, DO NOT EXPOSE THIS APPLIANCE TO RAIN OR MOISTURE.

### **CAUTION:**

TO PREVENT ELECTRIC SHOCK, DO NOT USE THIS (POLARIZED) PLUG WITH AN EXTENSION CORD, RECEPTACLE OR OTHER OUTLET UNLESS THE BLADES CAN BE FULLY INSERTED TO PREVENT BLADE EXPOSURE.

### **NOTE:**

SINCE THIS PROJECTOR IS PLUGGABLE EQUIPMENT, THE SOCKET-OUTLET SHALL BE INSTALLED NEAR THE EQUIPMENT AND SHALL BE EASILY ACCESSIBLE.

### **WARNING**

Use the attached specified power supply cord. If you use another power-supply cord, it may cause interference with radio and television reception.

Use the attached RS-232C cable and Mini D-SUB 15P - DVI conversion cable with this equipment so as to keep interference within the limit of a FCC Class B device.

This apparatus must be grounded.

**DO NOT LOOK DIRECTLY INTO THE LENS WHEN THE PROJECTOR IS IN THE POWER ON MODE.**

### **CAUTION**

Not for use in a computer room as defined in the Standard for the Protection of Electronic Computer/ Data Processing Equipment, ANSI/NFPA 75.

### **When using the projector in Europe:**

#### **COMPLIANCE NOTICE**

This LCD Video Projector complies with the requirements of the EC Directive 89/336/EEC “EMC Directive” as amended by Directive 92/31/EEC and 93/68/EEC, and 73/23/EEC “Low Voltage Directive” as amended by Directive 93/68/EEC.

The electro-magnetic susceptibility has been chosen at a level that gains proper operation in residential areas, on business and light industrial premises and on small-scale enterprises, inside as well as outside of the buildings. All places of operation are characterised by their connection to the public low voltage power supply system.

#### **WARNING**

Use the attached RS-232C cable and Mini D-SUB 15P - DVI conversion cable with this equipment so as to keep interference within the limit of a EN55022 Class B.

Please follow WARNINGS instructions.

# Contents

Important safeguards .....	4
Preparing your projector .....	6
Using the remote control .....	9
Setting up your projector .....	11
Viewing video images .....	14
Viewing computer images .....	19
Menu operation .....	22
Adjusting projected images .....	27
Replacing the lamp .....	30
Cleaning .....	32
Asking for installation .....	33
Troubleshooting .....	34
Specifications .....	36

## Declaration of Conformity

Model Number : HC2000  
Trade Name : MITSUBISHI ELECTRIC  
Responsible party : Mitsubishi Digital Electronics America, Inc.  
9351 Jeronimo Road, Irvine, CA 92618 U.S.A  
Telephone number : +1-(949) 465-6000

This device complies with Part 15 of the FCC Rules. Operation is subject to the following two conditions:

- (1) this device may not cause harmful interference, and
- (2) this device must accept any interference received, including interference that may cause undesired operation.

## Trademark, Registered trademark

Macintosh is registered trademark of Apple Computer Inc.

DLP, Digital Micromirror Device and DMD are all trademarks of Texas Instruments.

Other brand or product names are trademarks or registered trademarks of their respective holders.

# Important safeguards

Please read all these instructions regarding your projector and retain them for future reference. Follow all warnings and instructions marked on the projector.

1. **Read instructions**  
All the safety and operating instructions should be read before the appliance is operated.
2. **Retain instructions**  
The safety and operating instructions should be retained for future reference.
3. **Warnings**  
All warnings on the appliance and in the operating instructions should be adhered to.
4. **Instructions**  
All operating instructions must be followed.
5. **Cleaning**  
Unplug this projector from the wall outlet before cleaning it. Do not use liquid aerosol cleaners. Use a damp soft cloth for cleaning.
6. **Attachments and equipment**  
Never add any attachments and/or equipment without the approval of the manufacturer as such additions may result in the risk of fire, electric shock or other personal injury.
7. **Water and moisture**  
Do not use this projector near water or in contact with water.
8. **Accessories**  
Do not place this projector on an unstable cart, stand, tripod, bracket or table. Use only with a cart, stand, tripod bracket, or table recommended by the manufacturer or sold with the projector. Any mounting of the appliance should follow the manufacturer's instructions and should use a mounting accessory recommended by the manufacturer.



An appliance and cart combination should be moved with care. Quick stops, excessive force and uneven surfaces may cause the appliance and cart combination to overturn.

9. **Ventilation**  
Slots and openings in the cabinet are provided for ventilation, ensuring reliable operation of the projector and to protect it from overheating. Do not block these openings or allow them to be blocked by placing the projector on a bed, sofa, rug, or bookcase. Ensure that there is adequate ventilation and that the manufacturer's instructions have been adhered to.

10. **Power sources**  
This projector should be operated only from the type of power source indicated on the marking label. If you are not sure of the type of power, please consult your appliance dealer or local power company.
11. **Power-cord protection**  
Power-supply cords should be routed so that they are not likely to be walked on or pinched by items placed upon or against them. Pay particular attention to cords at plugs, convenience receptacles, and points where they exit from the appliance. Do not put the power cord under a carpet.
12. **Overloading**  
Do not overload wall outlets and extension cords as this can result in a fire or electric shock.
13. **Objects and liquids**  
Never push objects of any kind through openings of this projector as they may touch dangerous voltage points or short-out parts that could result in a fire or electric shock. Never spill liquid of any kind on the projector.
14. **Servicing**  
Do not attempt to service this projector yourself. Refer all servicing to qualified service personnel.
15. **Damage requiring service**  
Unplug this projector from the wall outlet and refer servicing to qualified service personnel under the following conditions:
  - (a) If the power-supply cord or plug is damaged.
  - (b) If liquid has been spilled, or objects have fallen into the projector.
  - (c) If the projector does not operate normally after you follow the operating instructions. Adjust only those controls that are covered by the operating instructions. An improper adjustment of other controls may result in damage and may often require extensive work by a qualified technician to restore the projector to its normal operation.
  - (d) If the projector has been exposed to rain or water.
  - (e) If the projector has been dropped or the cabinet has been damaged.
  - (f) If the projector exhibits a distinct change in performance - this indicates a need for service.
16. **Replacement parts**  
When replacement parts are required, be sure that the service technician has used replacement parts specified by the manufacturer or parts having the same characteristics as the original part. Unauthorized substitutions may result in fire, electric shock or other hazards.
17. **Safety check**  
Upon completion of any service or repair to this projector, ask the service technician to perform safety checks determining that the projector is in a safe operating condition.

**WARNING:****Unplug immediately if there is something wrong with your projector.**

Do not operate if smoke, strange noise or odor comes out of your projector. It might cause fire or electric shock. In this case, unplug immediately and contact your dealer.

**Never remove the cabinet.**

This projector contains high voltage circuitry. An inadvertent contact may result in an electric shock. Except as specifically explained in the Owner's Guide, do not attempt to service this product yourself. Please contact your dealer when you want to fix, adjust or inspect the projector.

**Do not modify this equipment.**

It can lead to fire or electric shock.

**If you break or drop the cabinet.**

Do not keep using this equipment if you break or drop it. Unplug the projector and contact your dealer for inspection. It may lead to fire if you keep using the equipment.

**Do not face the projector lens to the sun.**

It can lead to fire.

**Use correct voltage.**

If you use incorrect voltage, it can lead to fire.

**Do not place the projector on uneven surface.**

Place the projection on a leveled and stable surface only. Please do not place equipment on unstable surfaces.

**Do not look into the lens when it is operating. It may hurt your eyes.**

Never let children look into the lens when it is on.

**Do not turn off the main power abruptly or unplug the projector during operation.**

It can lead to lamp breakage, fire, electric shock or other trouble. It is best to wait for the fan to turn off before turning main power off.

**Do not touch Air outlet grille and Bottom plate which becomes hot.**

Do not touch them or put other equipment in front of Air outlet grille. The heated Air outlet grille and Bottom plate may cause injury or damage to other equipment. Also, do not set the projector on the desk which is easily affected by heat.

**Do not look into the air outlet grille when projector is operating.**

Heat, dust etc. may blow out of it and hurt your eyes.

**Place of installation**

For safety's sake, refrain from setting the projector at any place subjected to high temperature and high humidity. Please maintain an operating temperature, humidity, and altitude as specified below.

- Operating temperature: between +41°F (+5°C) and +95°F (+35°C)
- Operating humidity: between 30 and 90%
- Never put any heat-producing device under the projector so that the projector does not overheat.
- Do not attach the projector to a place that is unstable or subject to vibration.
- Do not install the projector near any equipment that produces a strong magnetic field. Also refrain from installing near the projector any cable carrying a large current.
- Place the projector on a solid, vibration free surface: otherwise it may fall, causing serious injury to a child or adult, and serious damage to the product.
- Do not stand the projector: it may fall, causing serious injury and damage to the projector.
- Slanting the projector more than  $\pm 10^\circ$  (right and left) or  $\pm 15^\circ$  (front and rear) may cause trouble or explosion of the lamp.
- Do not place the projector near air-conditioning unit or heater to avoid hot air to the exhaust and ventilation hole of the projector.

**COMPLIANCE NOTICE OF FCC**

This equipment has been tested and found to comply with the limits for a Class B digital device, pursuant to Part 15 of the FCC Rules. These limits are designed to provide reasonable protection against harmful interference in a residential installation. This equipment generates, uses and can radiate radio frequency energy and, if not installed and used in accordance with the instructions, may cause harmful interference to radio communications. However, there is no guarantee that interference will not occur in a particular installation. If this equipment does cause harmful interference to radio or television reception, which can be determined by turning the equipment off and on, the user is encouraged to try to correct the interference by one or more of the following measures:

- Reorient or relocate the receiving antenna.
- Increase the separation between the equipment and receiver.
- Connect the equipment into an outlet on a circuit different from that to which the receiver is connected.
- Consult the dealer or an experienced Radio / TV technician for help.

Changes or modifications not expressly approved by Mitsubishi could void the user's authority to operate this equipment.

**COMPLIANCE NOTICE OF INDUSTRY CANADA**

This Class B digital apparatus complies with Canadian ICES-003.

# Preparing your projector

## Checking accessories

The following accessories are provided with this projector. Check to be sure that all of the accessories are packed in the package.

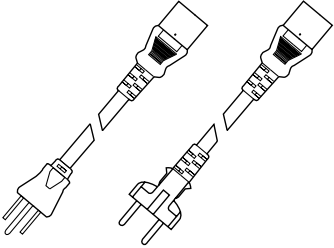
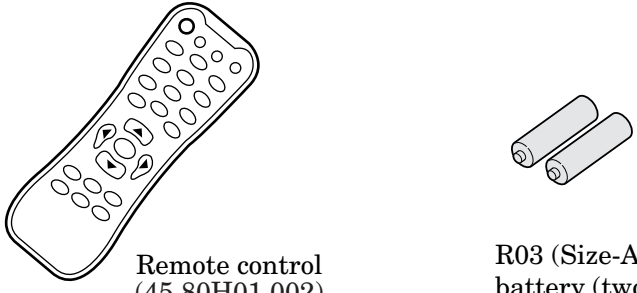
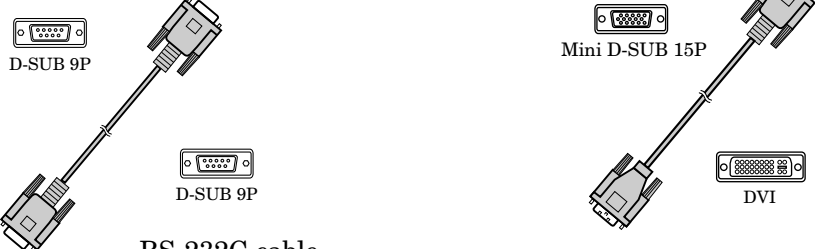
<p>■ Power supply parts</p>  <p>Power cord (two) (42.50115.021, 42.50122.011)</p>	<p>■ Remote control parts</p>  <p>Remote control (45.80H01.002)</p> <p>R03 (Size-AAA) battery (two)</p>
<p>■ Cables</p>  <p>D-SUB 9P</p> <p>RS-232C cable (42.86603.001)</p> <p>Mini D-SUB 15P</p> <p>Mini D-SUB 15P - DVI conversion cable (42.80H04.001)</p> <p>D-SUB 9P</p> <p>DVI</p> <ul style="list-style-type: none"><li>• Used for adjustment by service person.</li></ul>	<p>■ Others</p> <ul style="list-style-type: none"><li>• Lens cap (Attached to the projector) (51.80H05.001)</li><li>• User manual (36.81F01.001)</li><li>• Quick Start up (36.81F02.001)</li><li>• Remote control photo-sensor protection sticker (two) (35.80H03.001)</li><li>• Cushion (See page 11.)</li></ul>

### IMPORTANT:

- The attached power cords are to be used exclusively for this product. Never use them for other products.

## Inserting the batteries into the remote control

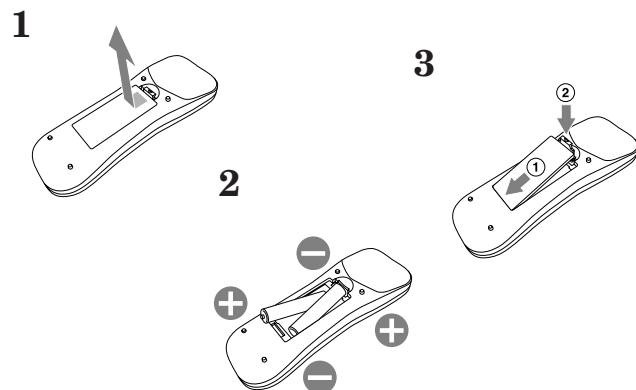

1. Remove the rear lid of the remote control.
2. Check the polarity (+), (-) of the batteries, and set them correctly, inserting their (-) side first.
  - If the battery is inserted from the (+) side first, inserting the (-) side is difficult because the coil spring end hits on the battery side. If the battery is forced to insert in this way, the outer label of the battery may get ripped and it may cause a short-circuit and heating.
3. Attach the rear lid.

### Important:

- Use two size-AAA batteries (R03).
- Replace the two batteries with new ones when the remote control is slow to operate.

### Caution:

- If the batteries are treated incorrectly, they may cause fire or other contamination due to leakage of the liquid, heating, or they may burst. (Read the cautions indicated on the battery, too.)
- Do not use a new battery with an old one.
- Load batteries in the correct position.
- Do not heat, take apart, or throw batteries into fire.
- Do not try to recharge batteries. Do not use rechargeable batteries.
- If the solution of batteries comes in contact with your skin or clothes, rinse with water. If the solution comes in contact with your eyes, rinse them with water and then consult your doctor.

## Overview

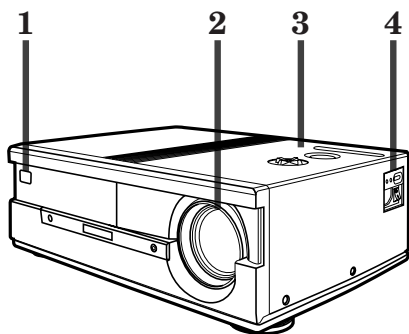

- 1 Remote control sensor (Front)
- 2 Lens
- 3 Control area
- 4 Power / indicators area
- 5 Terminal panel
- 6 Lamp cover
- 7 Exhaust vent

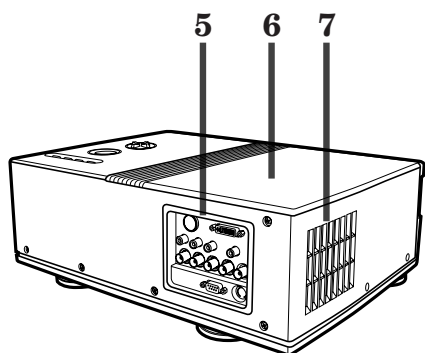

## Control area

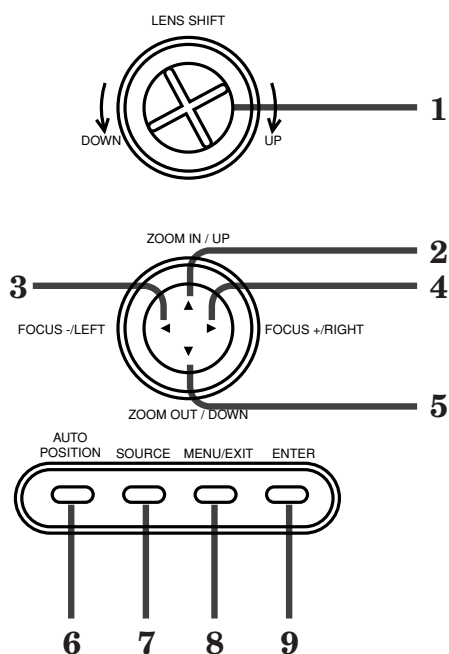

- 1 Lens shift dial
- 2 ZOOM IN / UP (▲) button
- 3 FOCUS - / LEFT (◀) button
- 4 FOCUS + / RIGHT (▶) button
- 5 ZOOM OUT / DOWN (▼) button
- 6 AUTO POSITION button
- 7 SOURCE button
- 8 MENU/EXIT button
- 9 ENTER button

## Preparing your projector (Continue)

### Terminal panel

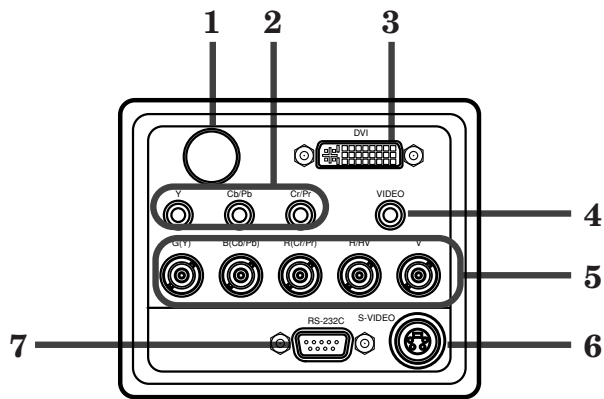

- 1 Remote control sensor (Rear)
- 2 Component terminals
- 3 DVI terminal
- 4 VIDEO terminal
- 5 5 BNC terminals
- 6 S-VIDEO terminal
- 7 RS-232C terminal
  - Used for adjustment by service person.

### Power / indicators area

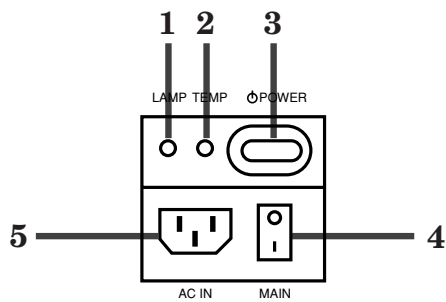

- 1 LAMP indicator
- 2 TEMP (temperature) indicator
- 3 POWER button / POWER indicator
- 4 MAIN switch
- 5 Power cord inlet

### Bottom side

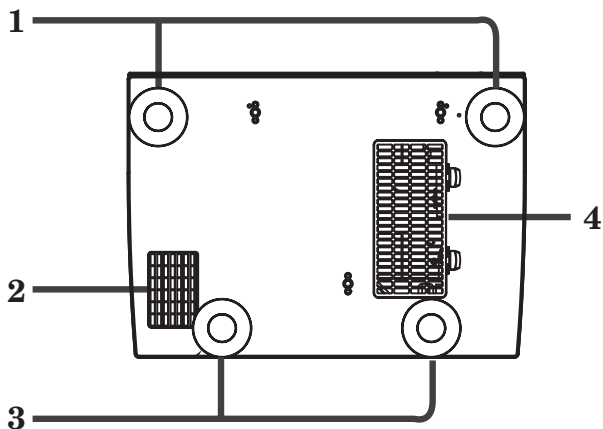

- 1 Angle adjusting feet (front)
- 2 Exhaust vent
- 3 Angle adjusting feet (rear)
- 4 Intake vent / filter cover



# Using the remote control

## Overview of the remote control

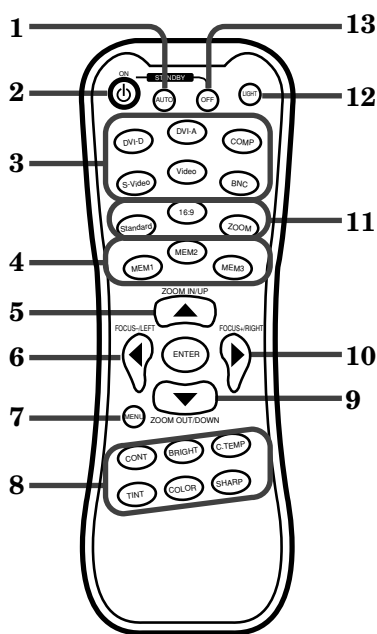

- 1 AUTO (AUTO POSITION) button
- 2 ON (☺) button
- 3 SOURCE buttons
- 4 MEMORY buttons
- 5 ZOOM IN / UP (▲) button
- 6 FOCUS - / LEFT (◀) button
- 7 MENU button
- 8 Picture quality adjusting buttons (see below)
- 9 ZOOM OUT / DOWN (▼) button
- 10 FOCUS + / RIGHT (▶) button
- 11 Aspect buttons
- 12 LIGHT button
- 13 OFF button

### Important:

When you press the LIGHT button, the buttons on the remote control are lit. Press the LIGHT button again or wait approx. 15 seconds after releasing the button to turn them off.

## Using the picture quality adjusting buttons

When you press any of the picture quality adjusting buttons, the screen for adjusting the picture quality appears. Adjust the picture quality by pressing the ▶ and ◀ buttons. The picture quality adjustment can be made alternatively in the **PICTURE** menu or the **PRO PICTURE** menu. (See Pages 27 and 28.) Items in the menus are shown in parentheses below.

**CONT (CONTRAST)** ..... Adjusts the contrast of projected images. Every time you press the ▶ button, the projected image becomes brighter and more vivid. Every time you press the ◀ button, the projected image becomes darker and less vivid.

**BRIGHT (BRIGHTNESS)** ... Adjusts the brightness of projected images. Every time you press the ▶ button, the projected image becomes brighter. Every time you press the ◀ button, the projected image becomes darker.

**C.TEMP (COLOR TEMP.)** .. Selects one of the preset color temperatures.

**TINT (TINT)** ..... Adjusts the tint of projected images. Every time you press the ▶ button, the skin color of the projected image becomes more greenish. Every time you press the ◀ button, the skin color of the projected image becomes reddish. (Available only when the NTSC signal is input.)

**COLOR (COLOR)** ..... Adjusts the color thickness of projected images. Every time you press the ▶ button, the projected image color becomes thicker. Every time you press the ◀ button, the projected image color becomes lighter.

**SHARP (SHARPNESS)** ..... Adjusts the sharpness of projected images. Every time you press the ▶ button, the projected image becomes sharper. Every time you press the ◀ button, the projected image becomes softer.

## Using the remote control (Continue)

### Operational range of the remote control

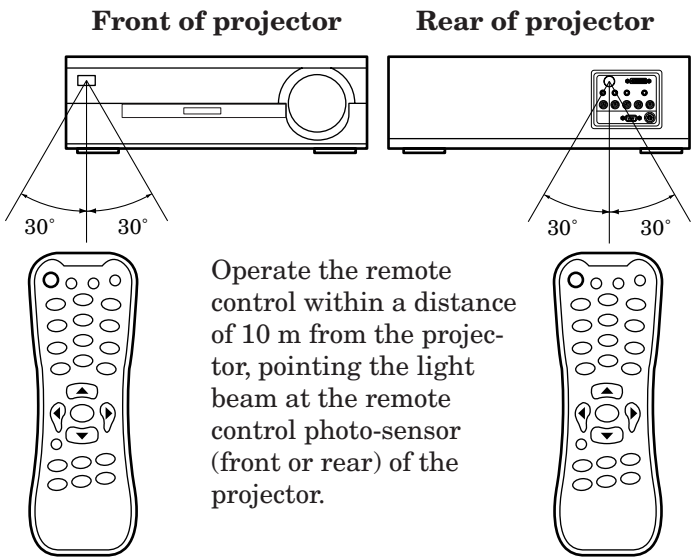

- Keep the remote control photo-sensor out of direct sunlight or fluorescent lamp light.
- Keep the remote control photo-sensor at least 2 m away from fluorescent lamps. Otherwise, the remote control may malfunction.
- If there is an inverter-operated fluorescent lamp near the remote control, the remote control operation may become unstable. On this occasion, stick the attached protection sticker on one of the photo-sensors that is closer to the fluorescent lamp.

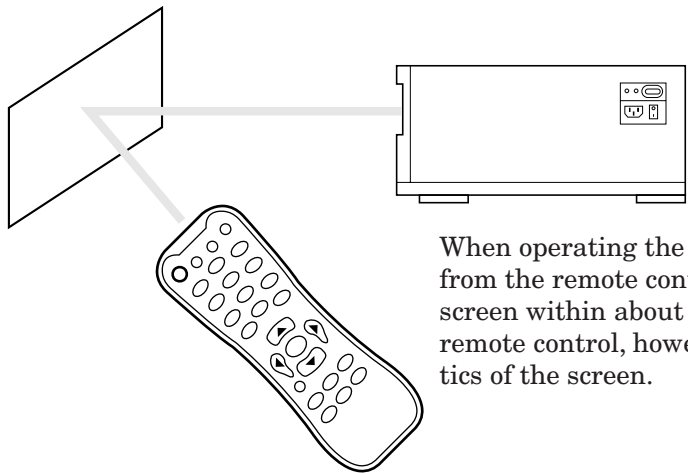

### Reception angle

#### Vertical directions

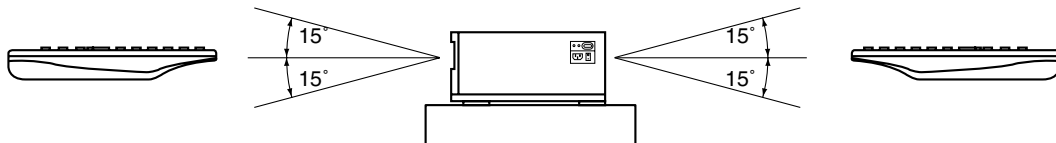

#### Vertical directions (ceiling mount)

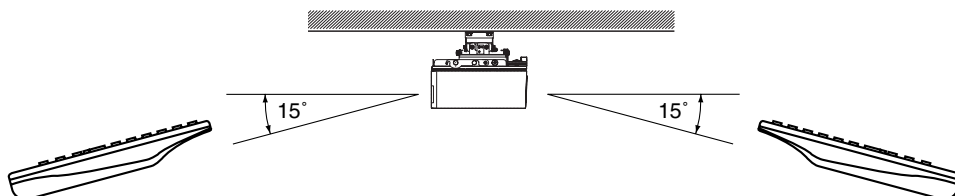

# Setting up your projector

## Setting up the screen

Install the screen perpendicularly to the projector. If the screen can not be installed in such a way, adjust the projection angle of the projector. (See below.)

- Install the screen and projector so that the projector's lens is placed at the same height and horizontal position of the screen center.
- Do not install the screen where it is exposed to direct sunlight or lighting. Light directly reflecting on the screen makes the projected images whitish and hard to view.

## Basic setup

Determine the distance from the screen to the projector according to the size of the images to be projected. (See Pages 12 and 13.)

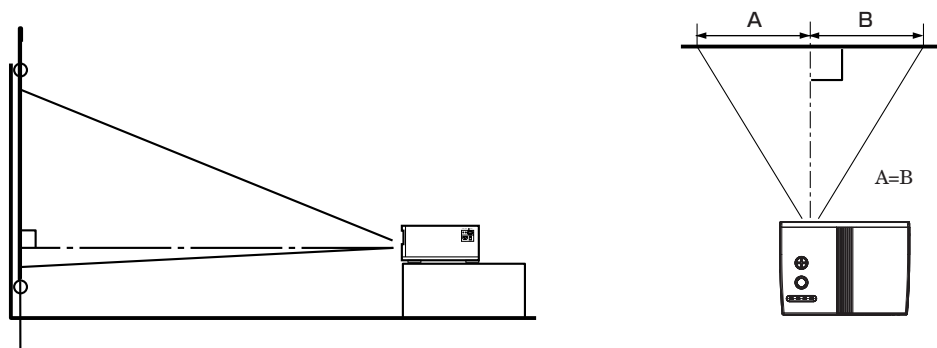

- Do not place this projector on a carpet or blanket because the exhaust vent and the intake vent on the bottom surface are blocked and the inside of the projector is heated, causing a breakdown or fire.
- Depending on the installation conditions, warm air that is emitted from the exhaust vents may flow into the intake vent, causing the projector to display "Over Temperature" and then stop projecting images. In such a case, attach the cushion that comes with the projector to the bottom surface of the projector as shown below.

## Adjusting the projection angle

This projector is provided with four feet for adjusting the projection angle on the bottom surface. Adjust the projection angle depending on the position of the projector. (Turn the feet for adjusting the projection angle to the left or right to adjust their length.)

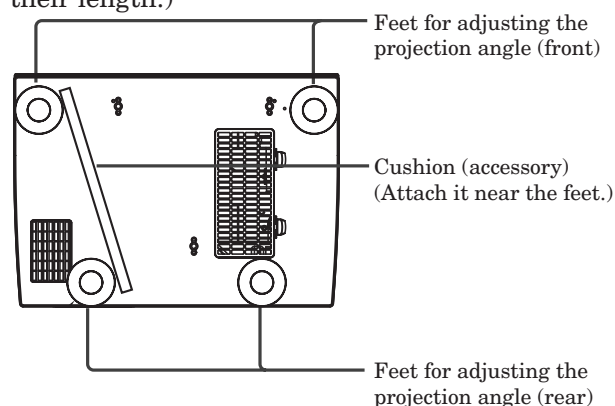

## When projected images are distorted to a trapezoid:

When the screen and the projector are not placed perpendicularly to each other, projected images become trapezoidal. If you cannot make the projector and the screen perpendicular to each other by mechanical adjustments, adjust **KEystone** in the **INSTALLATION** menu. (See Page 25.)

- When the keystone adjustment is applied, the correct aspect ratio may not be obtained.
- To secure the correct aspect ratio, use the projector with its lens centered as much as possible. However, the correct aspect ratio may not be obtained even though the lens is centered.
- When the keystone adjustment is applied, the resolution lowers. In addition, vertical stripes appear and straight lines bend in images with complicated patterns. To prevent such symptoms, keep the screen and the projector perpendicular to each other as much as possible.
- Though the projected image may be distorted momentarily when you change the setting value of the keystone adjustment, such symptom is not a malfunction.
- Though the projected image may be distorted depending on the setting value of the keystone adjustment and the type of the input signal, such symptom is not a malfunction. In such a case, adjust the setting value within the range where the projected image is not distorted.
- The setting value displayed at the time of the keystone adjustment may vary depending on the type of the input signal.

## Setting up your projector (Continue)

### Screen size and projection distance

Refer to the following table to determine the screen size.

#### When the aspect ratio of the screen is 16:9

To position the projector relative to the screen:

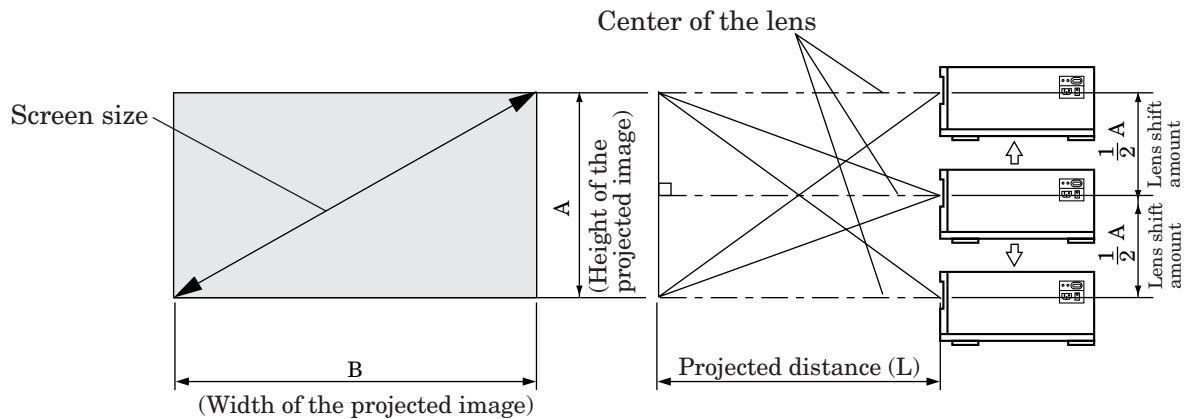

To position the screen relative to the projector:

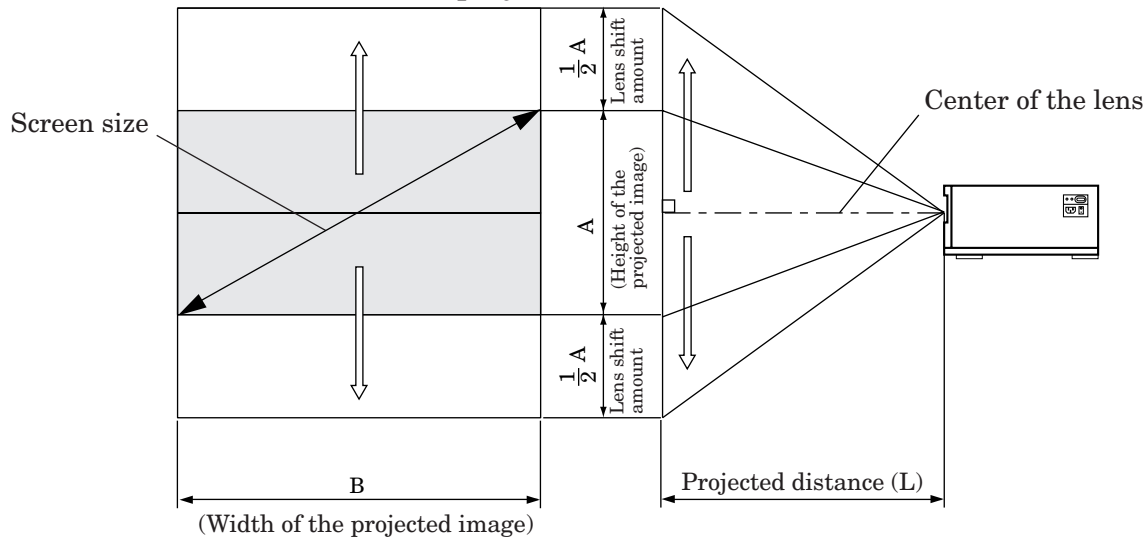

Screen size						Projected distance (L)			
16:9 Diagonal		Height A		Width B		Min.		Max.	
inch	cm	inch	cm	inch	cm	inch	cm	inch	cm
50	127	24	62	44	111	69	175	93	236
60	152	30	75	52	133	83	210	111	283
70	178	34	87	61	155	96	245	130	331
80	203	39	100	70	177	110	280	149	378
90	229	44	112	78	199	124	315	167	425
100	254	49	125	87	221	138	350	186	472
110	279	54	137	96	244	152	385	205	520
120	305	59	149	105	266	165	420	223	567
130	330	64	162	113	288	179	455	242	614
140	356	69	174	122	310	193	490	260	661
150	381	74	187	131	332	207	525	279	709
200	508	98	249	174	443	276	700	372	945
250	635	122	311	218	553	344	875	465	1181

Floor installation (cm)

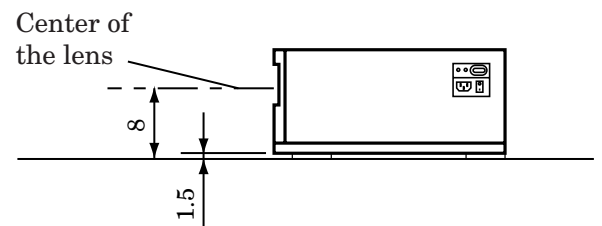

- The above figures are approximate and may be slightly different from the actual measurements.

### When the aspect ratio of the screen is 4:3:

When the aspect ratio of the screen is 4:3, the positional relation between the projected image and the screen is as shown on the right. Refer to the following table for installation.

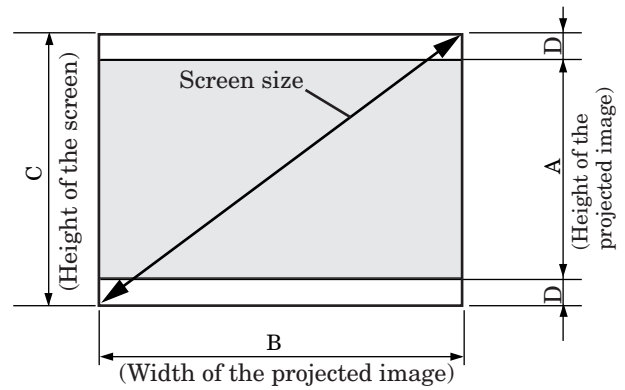

#### To position the projector relative to the screen:

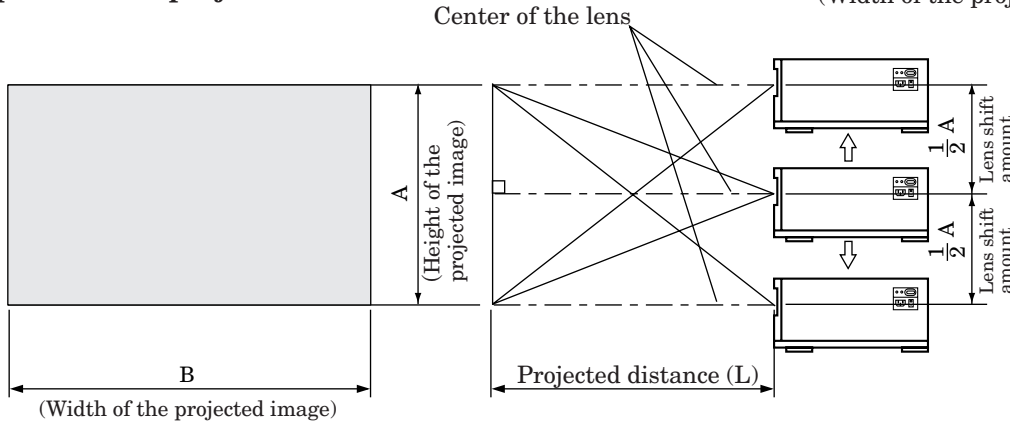

#### To position the screen relative to the projector:

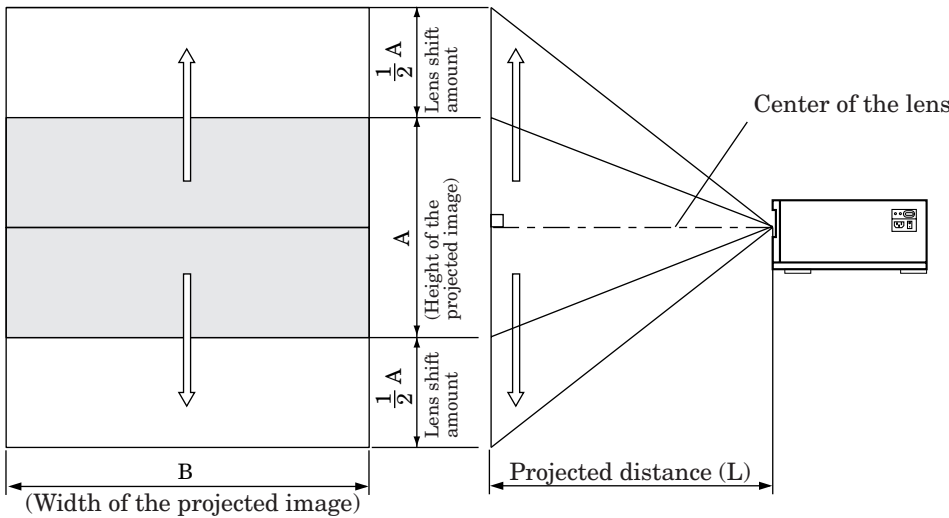

Screen size						Size of the projected image				Blank space (D)		Projected distance (L)			
4:3Diagonal		Height C		Width B		Height A		Width B		inch	cm	Min.		Max.	
inch	cm	inch	cm	inch	cm	inch	cm	inch	cm	inch	cm	inch	cm	inch	cm
50	127	30	76	40	102	22	57	40	102	3.7	9.5	63	161	85	217
60	152	36	91	48	122	27	69	48	122	4.3	11.0	76	193	102	260
70	178	42	107	56	142	31	80	56	142	5.3	13.5	89	225	120	304
80	203	48	122	64	163	36	91	64	163	6.1	15.5	101	257	137	347
90	229	54	137	72	183	41	103	72	183	6.7	17.0	114	289	154	390
100	254	60	152	80	203	45	114	80	203	7.5	19.0	126	321	171	434
110	279	66	168	88	224	50	126	88	224	8.3	21.0	139	353	188	477
120	305	72	183	96	244	54	137	96	244	9.1	23.0	152	386	205	520
130	330	78	198	104	264	59	149	104	264	9.6	24.5	165	418	222	564
140	356	84	213	112	284	63	160	112	284	10.4	26.5	177	450	239	607
150	381	90	229	120	305	67	171	120	305	11.4	29.0	190	482	256	650
200	508	120	305	160	406	90	229	160	406	15.0	38.0	253	643	341	867
250	635	150	381	200	508	113	286	200	508	18.7	47.5	316	803	427	1084

The above figures are approximate and may be slightly different from the actual measurements.

# Viewing video images

## A. Connecting the projector to video equipment

### Preparations:

- Make sure that the power of the projector and that of the video equipment are turned off.

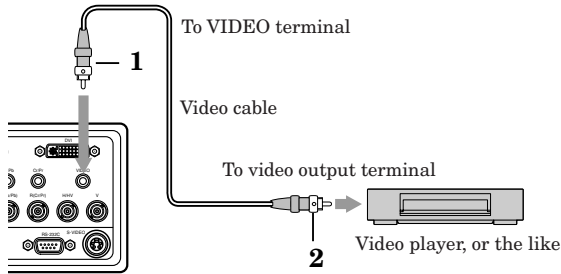

1. Connect one end of a commercially available video cable to the VIDEO terminal of the projector.
2. Connect the other end of the video cable to the video output terminal of the video equipment.

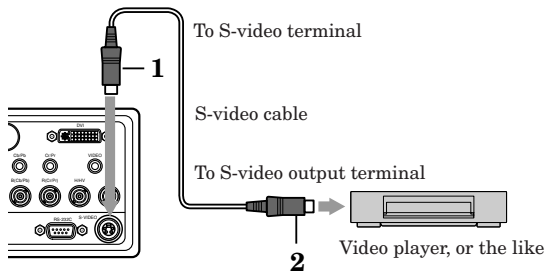

### When the video equipment is equipped with the S-video output terminal, make the connection as follows.

1. Connect one end of a commercially available S-video cable to the S-VIDEO terminal of the projector.
  2. Connect the other end of the S-video cable to the S-video output terminal of the video equipment.
- Also read the instruction manual of the equipment to be connected.
  - This projector does not have any built-in speaker. To reproduce audio, connect audio equipment.
  - Contact your dealer for details of connection.

### When a TV tuner or VCR is connected:

When you use this projector with a TV tuner or VCR connected, no image may appear or a message of No Signal may appear on the screen when you change the channel via any channel that is not being received. In such a case, set the channels of the TV tuner or VCR again. To avoid such symptom, use the TV tuner or VCR with its channel skip function (that is a function not to display channels that are not being received) enabled

### Connecting to a DVD player

To connect this projector to video equipment that has component video output terminals, such as a DVD player, use the COMPONENT terminals.

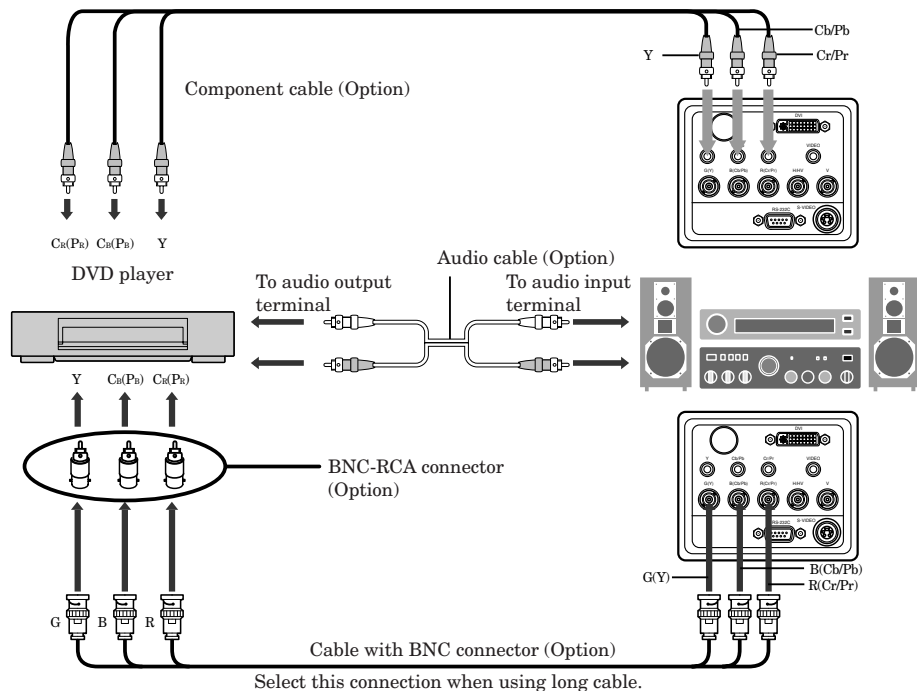

Select this connection when using long cable.

- Images may not be projected correctly depending on the type of the DVD player you use.
- Though it may take some time before an image is displayed on the screen depending on the type of the input signal, such symptom is not a malfunction.

## Connecting to video equipment having a DVI-D terminal

You can project high-quality images by connecting the DVI terminal of this projector to video equipment having a DVI-D output terminal. In addition, this projector supports HDCP and is able to receive encrypted digital video data that are output from DVD players.

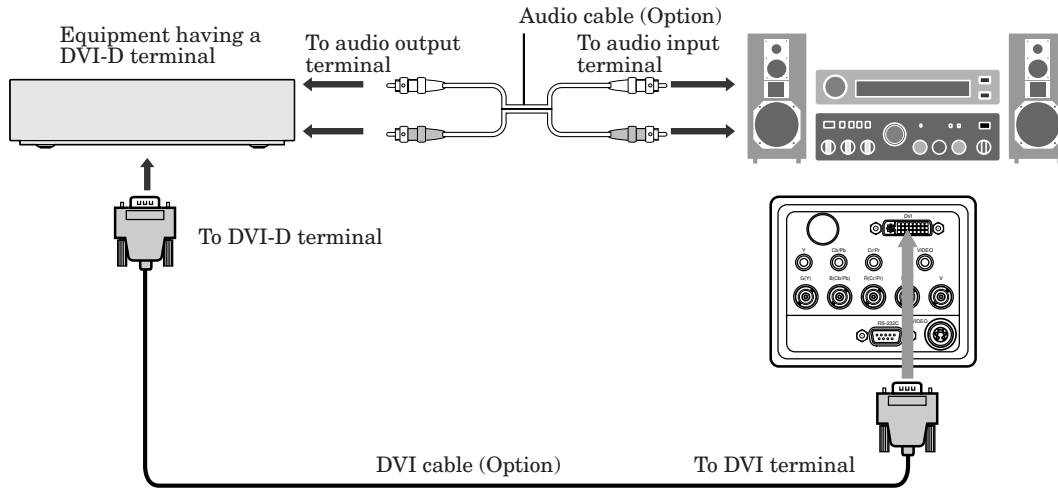

- For connection to the DVI terminal, use a commercially available DVI cable.
- Select **DVI-DIGITAL** as the input source.
- Only RGB signals are supported. Component video signals are not supported.
- HDCP (High-bandwidth Digital Content Protection), developed by Intel Corporation, is a method to encrypt digital video data for the purpose of copy protection.
- When DVI-D is selected as the input source, setting of **COLOR**, **TINT**, **SET UP**, **TRACKING**, **H.POSITION**, **V.POSITION** and **FINE SYNC**. is unavailable.

### When you connect this projector and a DVI-Digital device (such as a DVD player) via the DVI terminal, black color may appear light and pale, depending on the type of the connected device.

- This depends on the black level setting of the connected device. There are two kinds of methods to digitally transfer image data, in which different black level settings are employed respectively. Therefore, the specifications of the signals output from DVD players differ, depending on the type of the digital data transfer method they use.
- Some DVD players are provided with a function to switch the methods to output DVI-Digital signals. When your DVD player is provided with such function, set it as follows.

**NORMAL** → **EXPAND** or **ENHANCED**

- See the users guide of your DVD player for details.
- When your DVD player does not have such function, set **BRIGHTNESS** of this projector to -7. When you have more than one DVD player, it is convenient to store the image quality settings for each DVD player in the memory.

## B. Plugging in the power cord

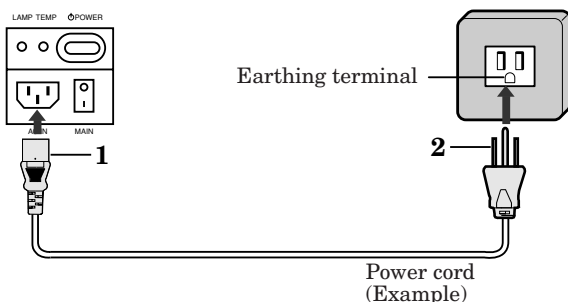

- 1 Plug the attached power cord into the power cord inlet of this projector.
- 2 Plug the other end of the power cord into a power outlet.

- The power cords for use in the U.S. and Europe are included with this projector. Use the appropriate one for your country.
- This projector uses the power plug of three-pin grounding type. Do not take away the grounding pin from the power plug. If the power plug doesn't fit your wall outlet, ask an electrician to change the wall outlet.
- The provided power cord for the U.S. is rated at 120 V. Never connect this cord to any outlet or power supply using other voltages or frequencies than rated. If you use a power supply using other voltage than rated, prepare an appropriate power cord separately.

# Viewing video images (continued)

## C. Projecting images

### Preparation:

- Remove the lens cap.
- Turn on the power of the connected video equipment.

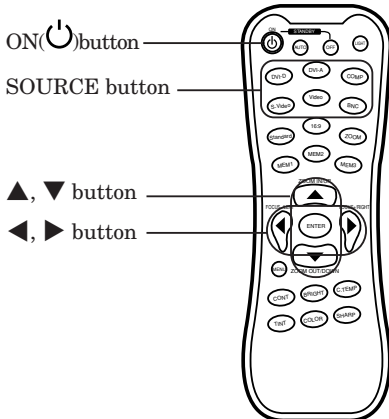
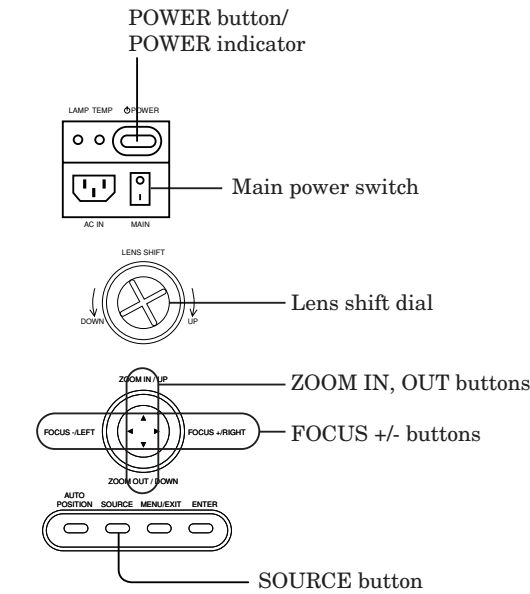

1. Turn the main power switch to on (or to the I position).
  - When the main power switch is turned on, the POWER indicator lights up red.

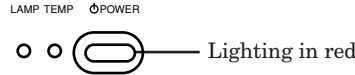

- If the projector was turned off before the lamp was cooled down sufficiently last time, the fan may start rotating and the POWER button may not work after the main power switch is turned on. (The POWER indicator blinks red.) After the fan stops rotating, press the power button to turn back on the POWER indicator.

2. Press the POWER button on the projector or ON (Power) button on the remote control.

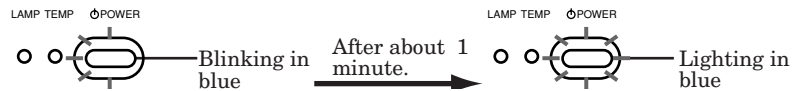

Power can not be turned "OFF".

- It may take about one minute for the lamp to light up.
- The lamp fails to light up on rare occasions. In such a case, wait for a few minutes and then try again.

3. Select an input source.
  - Press the SOURCE button on the projector or any of the SOURCE buttons (such as DVI-D, DVI-A, COMP, S-Video, Video, and BNC) on the remote control that is corresponding to the terminal in use.
  - Switch the input source after an image is projected on the screen.
  - Though it may take some time before an image is displayed on the screen depending on the type of the input signal, such symptom is not a malfunction.
  - Some images become easier to view when the setting of aspect ratio is changed. (See Page 18.)
4. Adjust the position of the projector to keep an appropriate projection distance with which images are projected in their specified sizes.
5. Adjust the position of the projector so that the projector and the screen are perpendicular to each other. (See Page 11.)
  - When the projector cannot be positioned perpendicularly to the screen, adjust the projection angle. (See Page 11.)
6. Adjust the size of the projected image by pressing the ZOOM IN or OUT button on the projector or the remote control.
7. Adjust the focus by pressing the FOCUS+ or FOCUS- button on the projector or the remote control.
8. Adjust the image position by turning the lens shift dial of the projector.

Repeat steps 4 to 8, if necessary.



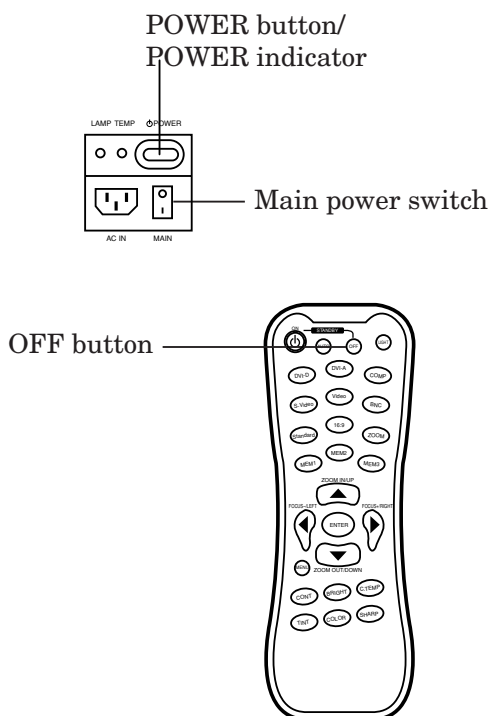

### To stop projecting:

9. Press the **POWER** button on the projector or the **OFF** button on the remote control.
  - A confirmation message is displayed.
  - To cancel the procedure, leave the projector for a while or press the **MENU** button on the remote control or the **MENU/EXIT** button on the projector.
10. Press the **POWER** button on the projector or the **OFF** button on the remote control again.
  - The lamp goes out and the projector goes into a standby mode. In this standby mode, the **POWER** indicator blinks red.
11. Wait about two minutes for the **POWER** indicator to be lit in red steadily.
  - During this period of two minutes in the standby mode, the intake fan and exhaust fan rotate to cool the lamp.
  - Do not turn off the main power switch while the **POWER** indicator is blinking. Turning off the main power switch immediately after use may cause a breakdown.
  - Though the fan makes loud sounds during cooling, such symptom is not a malfunction.
12. Turn the main power switch to off (or to the **O** position).
  - For safety reasons, when you are not going to use the projector for a long time, unplug it from the outlet.
  - Cover the lens with the lens cap to protect it from dust.

### When projected images are distorted to a trapezoid:

Adjust the setting values of **KEYSTONE** in the **INSTALLATION** menu.  
(See Page 23 for menu setting.)

1. Display the **INSTALLATION** menu.
2. Select **KEYSTONE** by pressing the **▲** or **▼** button.
3. Press the **ENTER** button.
  - The **KEYSTONE** menu appears.
4. Select **V.KEYSTONE** or **H.KEYSTONE** by pressing the **▲** or **▼** button.
5. Equalize the widths at the top and bottom of the screen (or heights at the left and right of the screen) by pressing the **◀** or **▶** button, viewing the screen.

To cancel the menu:



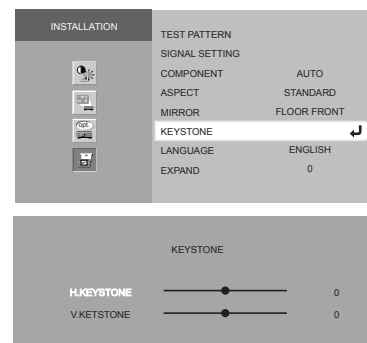











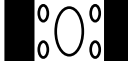

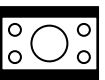

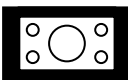

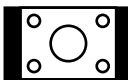

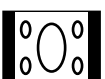
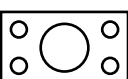
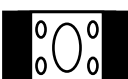
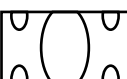
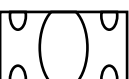





6. Press the **MENU** button several times.

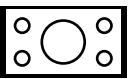

## Viewing video images (continued)

### Setting the aspect ratio

You can change the aspect ratio of the input video signal (or the ratio of width to height of the image). Change the setting according to the type of the input video signal.

	16 : 9	STANDARD	ZOOM1	ZOOM2	ZOOM3	REAL
Original image size	Projects images on the full screen (16:9)	Changes the aspect ratio according to the type of the input signal.	Projects images in the CinemaScope size together with subtitles.	Projects images in the Vista size together with subtitles.	Projects images in the European Vista size together with subtitles.	Projects images in their original size as input.
 4:3 image (480i, 576i, 480p, 576p, and PC)						 PC inputs not less than 1280x720 are projected on the full screen (16:9).
 4:3 CinemaScope and Vista image						
 Squeezed 4:3 (480i, 576i, 480p, 576p)						
 16:9 image (1080i)						 Images are projected with half vertical pixels.
 16:9 image (720p)						 Images are projected on the full screen.

Bold frames  are recommended modes.

- DVDs are usually labeled either FULLSCREEN or WIDESCREEN. FULLSCREEN DVDs produce a 4:3 image as shown above, and WIDESCREEN DVDs produce a 16:9 image as shown above, sometimes with or without thin black bars on the top or bottom of the picture. If you are purchasing DVDs for enjoyment with your HC2000 projector, WIDESCREEN versions of DVDs will fill most of the screen and produce the best viewing results.

### How to change the settings:

#### With the remote control:

- Press any of the aspect buttons (Standard, 16:9, or ZOOM).
  - Every time the ZOOM button is pressed, the zoom mode changes from Zoom 1 to Zoom 2, to Zoom 3, and back to Zoom 1.



Aspect buttons (Standard, 16:9, ZOOM)

#### With the operation panel of the projector:

(See Page 23 for menu setting.)

- Display the **INSTALLATION** menu.
- Select **ASPECT** by pressing the ▲ or ▼ button.
- Select your desired aspect ratio by pressing the ◀ or ▶ button.

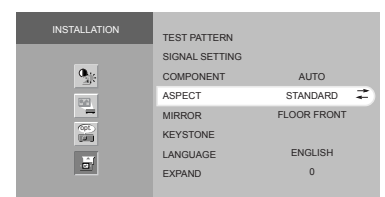

#### To cancel the menu:

- Press the MENU button.

# Viewing computer images

## A. Connecting the projector to a computer

### Preparation:

- Make sure that the power of the projector and that of the computer are turned off.
- When connecting the projector to a desktop computer, disconnect the RGB cables that are connected to the monitor.

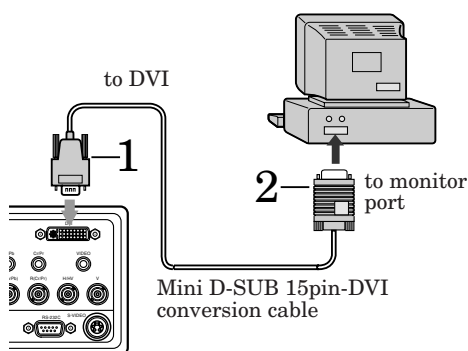

### For analog connection:

1. Connect one end of the supplied Mini D-SUB 15pin-DVI conversion cable to the DVI terminal of the projector.
  2. Connect the other end of the Mini D-SUB 15pin-DVI conversion cable to the monitor port of the computer.
- Additional devices, such as a conversion connector and an analog RGB output adapter, are required depending on the type of the computer to be connected.
  - Use of a long cable other than the supplied cable may decrease the quality of projected images.
  - When viewing images supplied from an analog-connected computer, press the DVI-A button on the remote control.
  - This projector does not support 3-line signals (SYNC-ON-GREEN signals).

### For digital connection:

1. Connect one end of a commercially available DVI cable to the DVI terminal of the projector.
  2. Connect the other end of the DVI cable to the DVI terminal of the computer.
- Additional devices, such as a conversion connector and an analog RGB output adapter, are required depending on the type of the computer to be connected.
  - Use of a long cable may decrease the quality of projected images.
  - When viewing images supplied from a digital-connected computer, press the DVI-D button on the remote control.
  - Turn on the power of the projector before that of the computer.

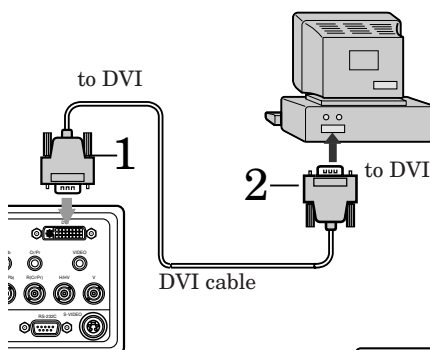

### For connection using the BNC terminal:

1. Connect one end of a commercially available Mini D-SUB 15pin-BNC conversion cable to five BNC terminals of the projector.
2. Connect the other end of the Mini D-SUB 15pin-BNC conversion cable to the monitor port of the computer.

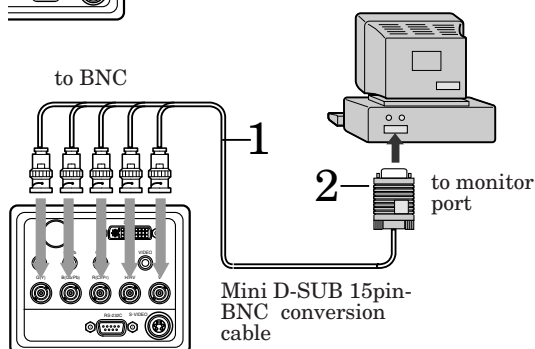

- Additional devices, such as a conversion connector and an analog RGB output adapter, are required depending on the type of the computer to be connected.
- Use of a long cable may decrease the quality of projected images.
- When viewing images supplied from an BNC-connected computer, press the BNC button on the remote control.
- Also read the instruction manual of the equipment to be connected.
- Though the projected image may be displaced or displayed incorrectly when a VGA60 signal is output at the startup of the computer, such symptom is not a malfunction. (This is because VGA60 signal is not supported.)
- This projector does not have any built-in speaker. To reproduce audio, use the speaker of the computer or connect the projector to audio equipment.
- Images may not be projected correctly, depending on the type of the connected computer.
- Contact your dealer for details of connection.

## B. Plugging the power cord

Plug the power cord in the same way as in the case of "Connecting the projector to video equipment." (See Page 15.)

# Viewing computer images (continued)

## C. Protecting images

### Preparation:

- Remove the lens cap.
- Turn on the power of the connected equipment.

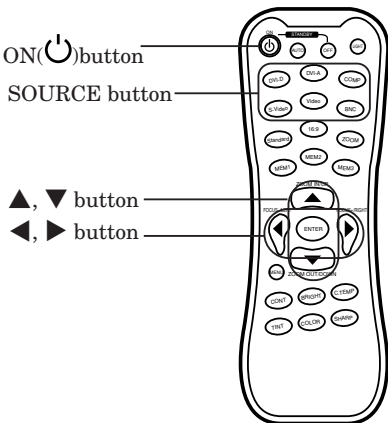
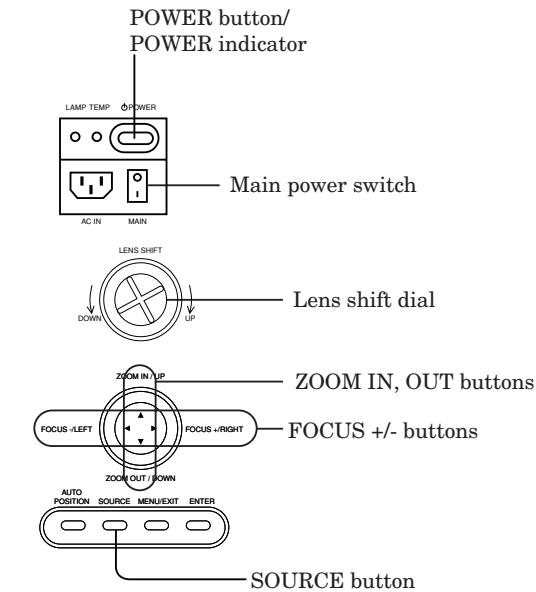

1. Turn the main power switch to on (or to the I position).
  - When the main power switch is turned on, the POWER indicator lights up red.

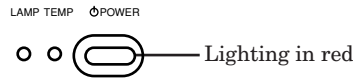

- If the projector was turned off before the lamp was cooled down sufficiently last time, the fan may start rotating and the POWER button may not work after the main power switch is turned on. (The POWER indicator blinks red.) After the fan stops rotating, press the power button to turn back on the POWER indicator.

2. Press the POWER button on the projector or ON (⏻) button on the remote control.

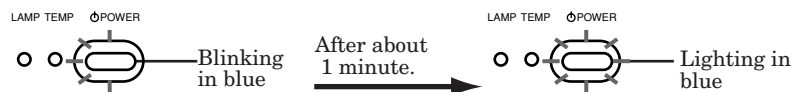

Power can not be turned “OFF”.

- It may take about one minute for the lamp to light up.
  - The lamp fails to light up on rare occasions. In such a case, wait for a few minutes and then try again.
3. Select an input source.
    - Press the SOURCE button on the projector or any of the SOURCE buttons (such as DVI-D, DVI-A, and BNC) on the remote control that is corresponding to the terminal in use.
    - Switch the input source after an image is projected on the screen.
    - Though it may take some time before an image is displayed on the screen depending on the type of the input signal, such symptom is not a malfunction.
    - Images may not be projected in the correct position, depending on the type of the input signal. In such a case, press the AUTO POSITION button on the projector or the AUTO button on the remote control. (See Page 21.)

4. Adjust the position of the projector to keep an appropriate projection distance with which images are projected in their specified sizes.
5. Adjust the position of the projector so that the projector and the screen are perpendicular to each other. (See Page 11.)
  - When the projector cannot be positioned perpendicularly to the screen, adjust the projection angle. (See Page 11.)
6. Adjust the size of the projected image by pressing the ZOOM IN or OUT button on the projector or the remote control.
7. Adjust the focus by pressing the FOCUS+ or FOCUS- button on the projector or the remote control.
8. Adjust the image position by turning the lens shift dial of the projector.

Repeat steps 4 to 8, if necessary.

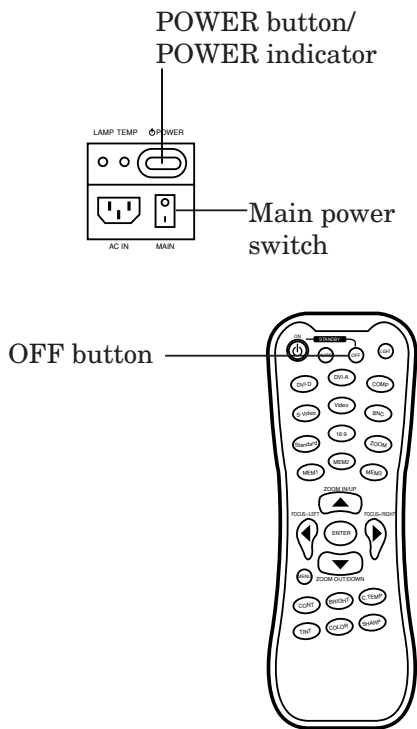

### To stop projecting:

9. Press the POWER button on the projector or the OFF button on the remote control.
  - A confirmation message is displayed.
  - To cancel the procedure, leave the projector for a while or press the MENU button on the remote control or the MENU/EXIT button on the projector.
10. Press the POWER button on the projector or the OFF button on the remote control again.
  - The lamp goes out and the projector goes into a standby mode. In this standby mode, the POWER indicator blinks red.
11. Wait about two minutes for the POWER indicator to be lit in red steadily.
  - During this period of two minutes in the standby mode, the intake fan and exhaust fan rotate to cool the lamp.
  - Do not turn off the main power switch while the POWER indicator is blinking. Turning off the main power switch immediately after use may cause a breakdown.
  - Though the fan makes loud sounds during cooling, such symptom is not a malfunction.
12. Turn the main power switch to off (or to the O position).
  - For safety reasons, when you are not going to use the projector for a long time, unplug it from the outlet.
  - Cover the lens with the lens cap to protect it from dust.

### AUTO POSITION button (AUTO button)

When the image supplied from the computer is displaced, carry out the following procedure.

1. Display a bright image (such as a full-screen display of the Recycle Bin window).
2. When the screen saver has been enabled, disable it.
3. Press the AUTO POSITION button on the projector or the AUTO button on the remote control.
 

The projector automatically makes optimum positional settings for the input signal.

  - If the image is not projected in the correct position even after you press the AUTO POSITION button (or AUTO button) several times, change the settings in the **SIGNAL SETTING** menu to put the image in the correct position. (See Page 29.)
  - When you carry out this procedure with a dark image, the image may be displaced.

### When connecting to a notebook computer:

When the projector is connected to a notebook computer, images may not be projected in some cases. In such cases, set the computer so that it can output signals externally. The setting procedure varies depending on the type of the computer. See the instruction manual of your computer.

### Example of the setting procedure for external output

Press the [Fn] key and any of the keys [F1] to [F12] at the same time. (The key to be pressed depends on the type of the computer you use.)

# Menu operation

- Menus are not displayed when no signal is supplied to the projector.

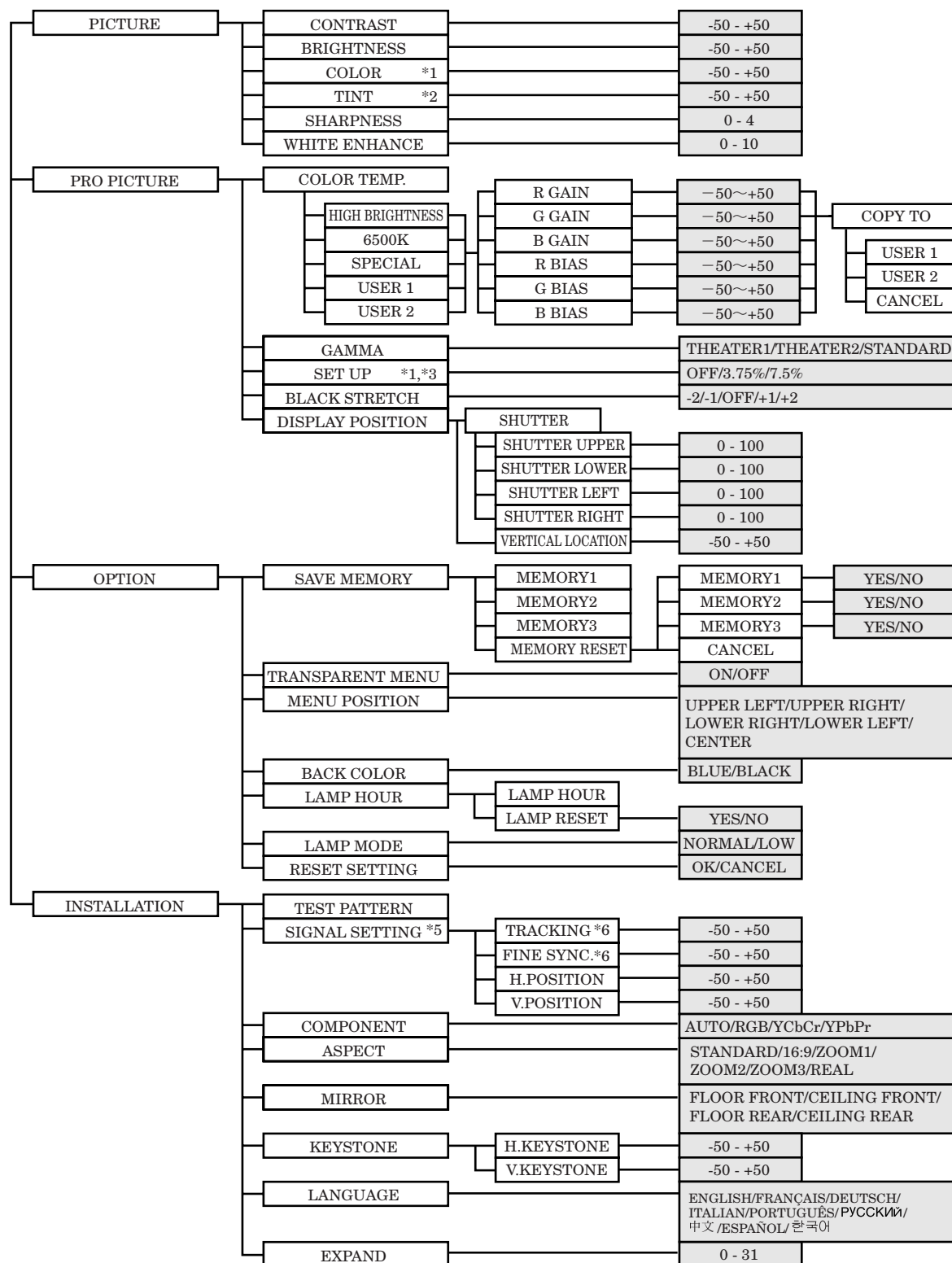

\*1) Unavailable when the computer or DVI-D is selected as the input source.

\*2) Available only when the NTSC signal is input.

\*3) Unavailable when the 720p signal or 1080i signal is input.

\*4) Available only when the signal supplied to the VIDEO terminal or S-VIDEO terminal is selected as the input source.

\*5) Unavailable when DVI-I is selected as the input source.

\*6) Available only when the computer is selected as the input source. However, they may cause available depending on the type of the input component video signal.

## How to set the menus:

Following describe how to set **VERTICAL LOCATION** as an example.

1. Press the **MENU** button.

The top menu appears.

- When no signal is input, the top menu does not appear.



2. Press the **▲** or **▼** button to select a menu to use.

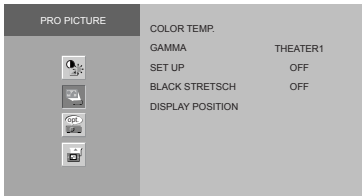

3. Press the **ENTER** button.

The item at the top is selected.

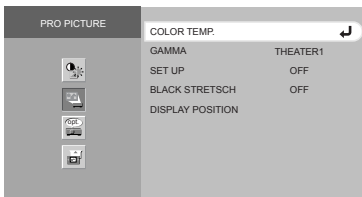

4. Press the **▲** or **▼** button to select an item to adjust.

- To set items marked with **↔**, press the **◀** or **▶** button.

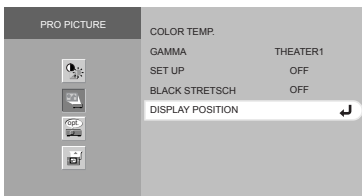

5. Press the **ENTER** button.

- The submenu appears.

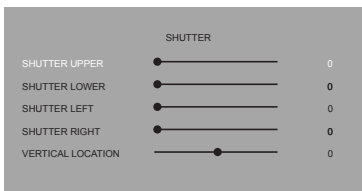

6. Press the **▲** or **▼** button to select an item to adjust.

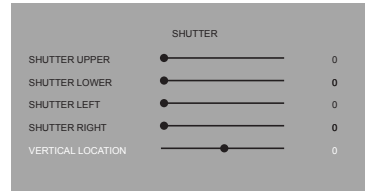

7. Set the selected item by pressing the **◀** or **▶** button.

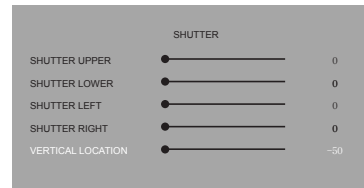

To cancel the menu:

8. Press the **MENU/EXIT** button on the projector or the **MENU** button on the remote control several times.

# Menu operation (continued)

## Available settings in the menus

Set the following items on their relevant menus.

### 1. PICTURE menu



### 2. PRO PICTURE menu

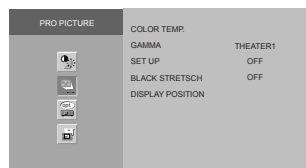

### 3. OPTION menu

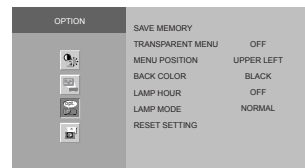

### 4. INSTALLATION menu

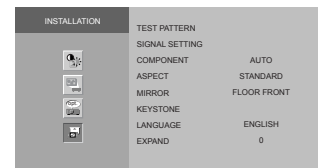

### 1. PICTURE menu

ITEM	SETTING	FUNCTION
CONTRAST	-50 - +50	Use to adjust the contrast of the projected image. (See Page 27.)
BRIGHTNESS	-50 - +50	Use to adjust the brightness of the projected image. (See Page 27.)
COLOR	-50 - +50	Use to adjust the color thickness of the projected image. (See Page 27.)
TINT	-50 - +50	Use to adjust the color tint of the projected image. (See Page 27.)
SHARPNESS	0 - 4	Use to adjust the sharpness of the projected image. (See Page 27.)
WHITE ENHANCE	0 - 10	Use to adjust the white level of the projected image. (See Page 27.)

### 2. PRO PICTURE menu

ITEM	SETTING	FUNCTION
COLOR TEMP.	HIGH BRIGHTNESS/6500K SPECIAL	Select when watching movies in dim lighting as in a theater. Select for the image of which black-to-white balance should be concerned.
GAMMA	USER1/USER2 THEATER1 THEATER2 STANDARD	Select to use the color temperature set by the user. (See Page 28.) Select when watching movies in dim lighting as in a theater. Select to gain the halftone to make the skin color more vibrant even in a dark scene. This mode is suitable for TV viewing. Select to secure the contrast even when the room lighting is increased to some extent.
SET UP	OFF 3.75%/7.5%	Select to make black lighter. Select to make black thicker. <ul style="list-style-type: none"> <li>SET UP has been factory set to OFF. Change this setting to 7.5% for viewing DVD disks for the U.S.</li> </ul>
BLACK STRETSCH	-2/-1/Off/+1/+2	Use to slightly adjust the color shades in the darkest area in the image. Selecting -1 makes black in such area thicker, and selecting +1 makes the color shades in such area crisper. This item does not affect relatively bright images.
DISPLAY POSITION	SHUTTER VERTICAL LOCATION	Use to apply the electric shutter to the upper or lower or left or right portion of the projected image. <ul style="list-style-type: none"> <li>When the menu is displayed or the zoom or focus function is used with the shutter function enabled, the shutter function is disabled temporarily. It is resumed when the menu or the zoom or focus function is canceled.</li> </ul> Use to adjust the vertical position of the projected image on the screen.

### 3. OPTION menu

ITEM	SETTING	FUNCTION
SAVE MEMORY	MEMORY 1/2/3	Use to store the settings of the <b>PICTURE</b> menu or the <b>PRO PICTURE</b> menu in the memory. (See Page 26.)
TRANSPARENT MENU	ON/OFF	Select whether or not to display the menus transparently.
MENU POSITION	5 points	Use to change the position of the menu.
BACK COLOR	BLUE/BLACK	Use to change the color of the screen that appears when no signal is supplied.
LAMP HOUR	LAMP HOUR	Use to confirm the lamp operating time.
LAMP MODE	LAMP RESET NORMAL LOW	Use to reset the lamp operating time when replacing the lamp. Select this option in normal use. Select to moderate the intensity of the lamp. The lamp operating sound is reduced and the lamp lifetime becomes longer. <ul style="list-style-type: none"> <li>Frequent switching of the lamp mode may damage the lamp.</li> </ul>
RESET SETTING		Use to reset the settings of the <b>OPTION</b> menu and the <b>INSTALLATION</b> menu (excluding <b>SAVE MEMORY</b> , <b>LAMP HOUR</b> , and <b>LANGUAGE</b> ) to the factory setting values.



#### 4. Installation Menu

ITEM	SETTING	FUNCTION
TEST PATTERN		The test pattern for focus adjustment is displayed when the ENTER button is pressed.
SIGNAL SETTING		Use to adjust the image supplied from the computer.
	TRACKING	Use to eliminate vertical wide stripes, if appears, viewing the projected image.
	FINE SYNC.	Use to eliminate flickering or blur, if appears, viewing the projected image.
	H.POSITION *	Use to adjust the horizontal position of the projected image.
COMPONENT	V.POSITION *	Use to adjust the vertical position of the projected image.
	AUTO	Select this option in normal use. Input signals are automatically recognized.
	RGB	Select this option when connecting the projector to high definition video equipment having R, G, and B output terminals.
	YCbCr	Select this option when connecting the projector to a DVD player or other device having Y, C <sub>B</sub> , and C <sub>R</sub> component video output terminals.
ASPECT	YPbPr	Select this option when connecting the projector to a MUSE recorder or other device having Y, P <sub>B</sub> , and P <sub>R</sub> component video output terminals.
	STANDARD	Select to change the aspect ratio automatically depending on the input signal.
	16:9	Select to project images with an aspect ratio of 16:9.
	ZOOM1/2/3	Select to enlarge and project images of CinemaScope size, Vista size, or European Vista size.
MIRROR	REAL	Select to project images in their original size as input.
	FLOOR FRONT	Select when viewing images from the front with the projector installed on the floor.
	CEILING FRONT	Select when viewing images from the front with the projector installed on the ceiling.
	FLOOR REAR	Select when viewing images projected from the behind of the screen with the projector installed on the floor.
KEYSTONE	CEILING REAR	Select when viewing images projected from the behind of the screen with the projector installed on the ceiling.
	H.KEYSTONE	Use to correct horizontal keystone distortion.
LANGUAGE	V.KEYSTONE	Use to correct vertical keystone distortion.
	9 languages	Use to select the language used in the menus.
EXPAND		Use to enlarge the projected image. (You cannot change the display position after enlargement.)

- **SIGNAL SETTING** Menu is not displayed when DVI-D is selected as the input source.
- Though horizontal strips may appear on the enlarged projected image, such symptom is not a malfunction.
- Options marked with \* become unavailable depending on the type of the input signal.
- When you change the horizontal or vertical position to a large extent, noise may appear.
- The adjustable range of the vertical position varies depending on the type of the input signal. Though the image may stay in the same position even when the setting value is changed, such symptom is not a malfunction.

## Menu operation (continued)

### To store the image quality settings:

You can store up to 3 patterns of the image quality setting, which consists of the settings of the **PICTURE** menu and the **PRO PICTURE** menu (excluding **COLOR TEMP.**) per group of input signals. (See the table on the right.)

Signal group	Signal name	Number
Video	Video, S-Video, 480i, 576i	3
Progressive	480p, 576p	3
HDTV	1080i, 720p	3
RGB	Others (Computer signal etc.)	3

### To store the settings:

(See Page 23 for menu setting.)

1. Set the items of the **PICTURE** menu and the **PRO PICTURE** menu.
2. Display the **OPTION** menu.
3. Select **SAVE MEMORY** by pressing the ▲ or ▼ button.
4. Select a memory to store the settings by pressing the ◀ or ▶ button.
5. Press the ENTER button.
  - The settings are stored.

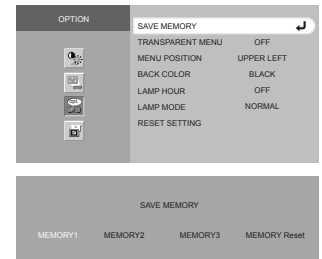

### To enable the stored image quality settings:

1. Press the MEMORY 1, 2, or 3 button on the remote control.

The image quality settings stored in the selected memory is enabled.
- Note that the Image quality settings are just stored on the menu. The remote control is required to enable the stored image quality settings.

### To reset the stored image quality settings (to the factory setting values), carry out the following procedure.

1. Display a video signal belonging to the signal group you want to reset.
2. Display the **OPTION** menu.
3. Select **SAVE MEMORY** by pressing the ▲ or ▼ button.
4. Select **MEMORY RESET** by pressing the ◀ or ▶ button.
5. Press the ENTER button.
6. Select a memory to reset by pressing the ▲ or ▼ button.
  - When you select **CANCEL**, the procedure is canceled (or the memory is not reset).
7. Press the ENTER button.
- This projector has four memories for the groups of input signals, and you can store up to 3 patterns of settings per group. These memories are not classified per input terminal.

# Adjusting projected images

## To adjust the brightness (CONTRAST and BRIGHTNESS):

You can make adjustments for the brightness of the projected image using the menu.

(See Page 23 for menu setting.)

1. Display the **PICTURE** menu.
2. Select **CONTRAST** or **BRIGHTNESS** by pressing the ▲ or ▼ button.
3. Adjust the selected item by pressing the ◀ or ▶ button.

CONTRAST	0
BRIGHTNESS	0

### To cancel the menu:

4. Press the MENU button.

### CONTRAST

Select to adjust the contrast of the image. Every time the ▶ button is pressed, the image becomes brighter and more defined. Every time the ◀ button is pressed, the image becomes darker and less defined.

### BRIGHTNESS

Every time the ▶ button is pressed, the image becomes brighter. Every time the ◀ button is pressed, the image becomes darker.

## To adjust the color (COLOR and TINT):

You can adjust the color of the projected image using the menu.

(See Page 23 for menu setting.)

1. Display the **PICTURE** menu.
2. Select **COLOR** or **TINT** by pressing the ▲ or ▼ button.
  - **COLOR** is unavailable when the computer or DVI-D is selected as the input source.
  - **TINT** is available only when the NTSC signal is input.
3. Adjust the selected item by pressing the ◀ or ▶ button.

COLOR	0
TINT	0

### To cancel the menu:

4. Press the MENU button.

### COLOR

Use to adjust the color thickness of the projected image. Every time the ▶ button is pressed, the color becomes thicker. Every time the ◀ button is pressed, the color becomes lighter.

- **COLOR** is unavailable when the computer or DVI-D is selected as the input source.

### TINT

Use to adjust the tint of the projected image. Every time the % button is pressed, the image appears more greenish. Every time the \$ button is pressed, the image appears more reddish.

## To sharpen or soften the projected image (SHARPNESS):

You can adjust the sharpness of the projected image using the menu. (See Page 23 for menu setting.)

1. Display the **PICTURE** menu.
2. Select **SHARPNESS** by pressing the ▲ or ▼ button.
3. Adjust the selected item by pressing the ◀ or ▶ button.

SHARPNESS	0
-----------	---

### To cancel the menu:

4. Press the MENU button.

## To enhance or weaken the white level of the projected image (WHITE ENHANCE):

You can adjust the white level of the projected image using the menu.

(See Page 23 for menu setting.)

1. Display the **PICTURE** menu.
2. Select **WHITE ENHANCE** by pressing the ▲ or ▼ button.
3. Adjust the selected item by pressing the ◀ or ▶ button.

WHITE ENHANCE	0
---------------	---

### To cancel the menu:

4. Press the MENU button.

## Adjusting projected images (continued)

### To adjust the tone of white (COLOR TEMP.):

You can select a preset color temperature (white tone) using the menu.  
(See Page 23 for menu setting.)

1. Display the **PRO PICTURE** menu.
2. Select **COLOR TEMP.** by pressing the ▲ or ▼ button.
3. Select your desired color temperature by pressing the ▲ or ▼ button.
  - When you select **SPECIAL**, the color temperature which concerns the black-to-white balance is applied.
  - Generally, select **HIGH BRIGHTNESS** for viewing TV and select **6500K** for viewing HDTV.
  - When you select **USER1** or **USER2**, the customized color temperature applies.

COLOR TEMP.

### To cancel the menu:

4. Press the MENU button.

### To adjust the tone of white (To customize the color temperature):

To customize (and store) the color temperature to your preference, carry out the following procedure.  
(See Page 23 for menu setting.)

### To store the settings:

1. Display the **PRO PICTURE** menu.
2. Select **COLOR TEMP.** by pressing the ▲ or ▼ button.
3. Select a color temperature to be used as the reference by pressing the ▲ or ▼ button.
  - Generally, select the most preferable color temperature.
4. Press the ENTER button.
  - The setting items such as **R GAIN**, **G GAIN**, **B GAIN**, **R BIAS**, **G BIAS**, and **B BIAS** are displayed at the lower left of the screen.
5. Press the ▲ or ▼ button to select an item to adjust.
6. Set the selected item by pressing the ◀ or ▶ button.
  - The image varies accordingly.
7. Repeat steps 5 and 6.
8. Press the ENTER button.
  - A screen to store the customized color temperature is displayed.
9. Select **USER1** or **USER2** by pressing the ◀ or ▶ button.
10. Press the ENTER button.
  - The customized color temperature is stored.

### To cancel the menu:

11. Press the MENU button.

### To enable the stored color temperature:

1. Select **USER1** or **USER2** of **COLOR TEMP.** in the **PRO PICTURE** menu.

#### About color temperature

There are different degrees of white color. Color temperature is a way to measure the degree of white color. The lower the color temperature is, the more reddish the white color appears, and the higher the color temperature is, the more bluish the white color appears. With this projector, you can adjust the color temperature by changing the values of gain and bias of R (red), G (green), and B (blue) respectively.

This projector automatically and properly projects video signals supplied from the computer. However, some video signals may not be projected, depending on the type of the computer. In such a case, press the AUTO POSITION button on the projector or the AUTO button on the remote control. (See Page 21.) When the signal is still not projected properly, adjust the projected image using the **SIGNAL SETTING** menu.

## How to adjust the image supplied from the computer using the menu:

Carry out the following procedures according to the symptoms.

Wide strips appear. .... Adjust **TRACKING** in the **SIGNAL SETTING** menu.

The projected image flickers.

The projected image is blurred. .... Adjust **FINE SYNC**. in the **SIGNAL SETTING** menu.

The projected image is displaced horizontally. .... Adjust **H.POSITION** in the **SIGNAL SETTING** menu. Every time the ◀ button is pressed, the image moves to the right. Every time the ▶ button is pressed, the image moves to the left.

The projected image is displaced vertically. .... Adjust **V.POSITION** in the **SIGNAL SETTING** menu. Every time the ◀ button is pressed, the image moves down. Every time the ▶ button is pressed, the image moves up.

1. Display the **INSTALLATION** menu.
2. Select **SIGNAL SETTING** by pressing the ▲ or ▼ button.
3. Press the ENTER button.
  - The **SIGNAL SETTING** menu appears.
4. Press the ▲ or ▼ button to select an item to adjust.
5. Adjust the selected item by pressing the ◀ or ▶ button.

### To cancel the menu:

6. Press the MENU button.
  - Do not change the settings of the **SIGNAL SETTING** menu in normal use.

### Simple method to adjust the image position

#### To adjust the horizontal position:

1. Align the left edge of the image with the left side of the screen by adjusting **H.POSITION**. Then, align the right edge of the image with the right side of the screen by adjusting **TRACKING**.
2. Repeat step 1 above to complete the adjustment of the horizontal position.

#### To adjust the vertical position:

3. Align the upper edge of the image with the upper side of the screen by adjusting **V.POSITION**.

## Special initial settings

In addition to the general image adjustment items, this projector has the following items as hidden adjustment items.

### CW Speed (Color wheel control)

You can change the rotation speed of the color wheel. This item is set to 5 normally.

5 (x5):

The rotation speed of the color wheel increases, reducing color breaking noise.

4 (x4):

Reproducibility of the color shades increases.

- The projected image is distorted momentarily when you change the setting value. Such symptom occurs because of variation in the rotation speed of the color wheel and is not a malfunction.

### LPF (Progressive filter)

You can select whether or not to enable the **LPF**. This item is set to **OFF** normally.

Vertical or horizontal streak noise may appear on the projected image, depending on the type of the DVD player you use. In such a case, you can reduce such streak noise by enabling the LPF. However, projected images become softened slightly.

1. Press the MENU button to display the top menu.
2. Press the AUTO POSITION button and the SOURCE button on the projector at the same time.
3. Press the ▲ or ▼ button to select an item to adjust.
4. Adjust the selected item by pressing the ◀ or ▶ button.

### To cancel the menu:

5. Press the MENU button.



# Replacing the lamp

This projector is equipped with a lamp to project images. This lamp is a consumable. It may burn out or its brightness may decrease during use. In such cases, replace the lamp with a new one as soon as possible. Be sure to replace the lamp with a new lamp separately sold that is exclusive to HC2000. Contact your dealer for purchase of the lamp.

## WARNING:

- Be sure to turn off the main power switch and unplug the power cord from the wall outlet before replacing the lamp. Lamp replacement without turning off the main power switch may result in electric shock.
- Be careful not to drop the lamp fixing screws into the inside of the projector. Don't put a metal piece or flammable object into the projector. Using the projector with any foreign object present inside may result in electric shock or fire. When you can't remove the foreign object from the inside, contact your dealer for removal.
- Be sure to install the lamp securely. When the lamp isn't installed properly, it won't illuminate. Improper installation may also result in fire.
- Don't shake the removed lamp or don't lift it above your face. You may be injured in your eye by flying or falling glass fragments.
- Don't replace the lamp immediately after use because the lamp cover is very hot. You may get burned. Turn off the power using the POWER button. After the lamp goes out, wait about two minutes until the intake and exhaust fans for cooling the lamp stop rotating. Then turn off the main power switch, unplug the power cord, and wait at least one hour to allow the lamp to cool down enough to the touch.

## CAUTION:

When the lamp operating time exceeds 1470 hours<sup>\*1</sup>, a warning indication is displayed on the screen for one minute. When it exceeds 1500 hours<sup>\*1, \*2</sup>, the warning indication is kept displayed on the screen. In such a case, replace the lamp with a new one immediately.

- Don't remove the lamp for any purpose other than replacement. Unnecessary removal of the lamp may result in a breakdown.
- This projector uses a high-pressure mercury lamp as the light source. The high-pressure mercury lamp may explode or fail to illuminate permanently because of an impact, scratch, or deterioration through use. The period of time until explosion or permanent failure to illuminate varies considerably from lamp to lamp, depending on operation conditions. Therefore, the lamp may explode soon after the start of use.
- The possibility of explosion of the lamp increases if you use it beyond its replacement period. When the instruction of lamp replacement appears, replace it with a new one immediately even if the lamp is still lighting normally.
- When the high-pressure mercury lamp explodes, glass fragments will scatter inside or outside the lamp box and the gas charged inside the lamp will diffuse inside or outside the projector. The gas inside the lamp contains mercury. Be careful not to breathe it or avoid it from entering your eye or mouth. If you should breathe it or if it should enter your eye or mouth, see a doctor immediately.
- In the event that the high-pressure mercury lamp has exploded, glass fragments may have been scattered inside the projector. Ask your dealer to replace the lamp and to inspect the inside of the projector. When you clean or replace the lamp by yourself, be sure to hold the handle of the lamp. You may get injured by glass fragments.
- Don't replace the lamp with the projector installed on the ceiling. Glass fragments may fall from the projector, entering your eye or mouth causing injury.
- Dispose of the used lamp according to the local regulations and rules.

\*1) Time when the projector is used with **LAMP MODE** set to **NORMAL**. When it is set to **LOW**, this period of time becomes longer.

\*2) About 3000 hours at the maximum

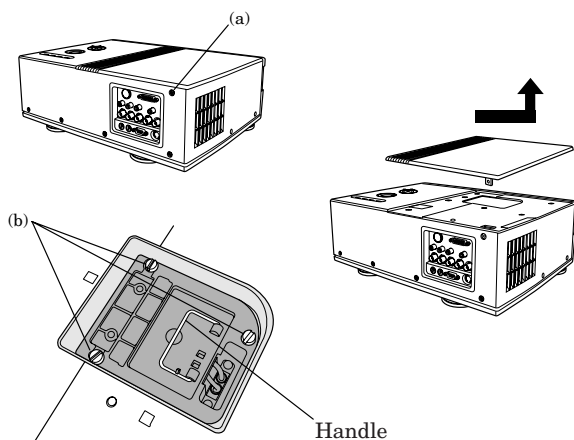

## To replace the lamp:

1. Loosen the lamp cover fixing screw (a) using a hexagon wrench (2-face, 3 mm).
2. Slide the lamp cover to the side and remove it from the projector.
3. Loosen three lamp box fixing screws (b) using a flatblade driver.
4. Lift the handle.

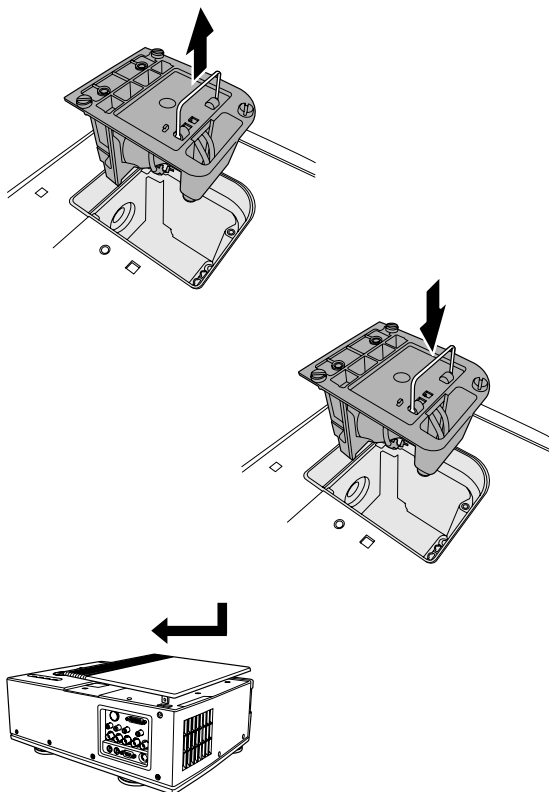

5. Pull the lamp out of the projector by the handle.
  - Pull the lamp out of the projector slowly and carefully. When the bulb has exploded, rough removal of the lamp may cause glass fragments to scatter.
  - Do not spill water on the lamp, or do not place it where children can reach or near flammables. You may get burned or injured.
6. Hold the handle of the new lamp and insert the lamp in the opening in the projector to the end in the correct orientation.
7. Press the handle into its storing position.
  - Make sure that the handle is securely locked.
8. Tighten the three fixing screws (b) securely using a flatblade driver.
9. Mount the lamp cover on the projector and fix the lamp cover fixing screw (a) securely using a hexagon wrench (2-face, 3 mm).
  - When the lamp cover is not mounted correctly, the projector is not turned on.

## How to reset the lamp operating time

1. Display the **OPTION** menu.
2. Select **LAMP HOUR** by pressing the ▲ or ▼ button.
3. Press the ENTER button.
  - The **LAMP HOUR** menu appears.
4. Select **LAMP RESET** by pressing the ◀ or ▶ button.
5. Select **YES** by pressing the ▲ or ▼ button.
6. Press the ENTER button.
  - The lamp operating time is reset.

### To cancel the menu:

7. Press the MENU button.
- When the lamp operating time has exceeded 1500 hours, a warning indication is kept displayed on the screen even after the lamp is replaced until the lamp operating time is reset.
  - Do not reset the lamp operating time unless you replace the lamp.
  - This projector uses a lamp that contains mercury. Disposal of the lamp or the projector with the lamp may be regulated due to environmental considerations. For disposal or recycling information, please contact your local authorities or the Electronic Industries Alliance: [www.eiae.org](http://www.eiae.org). (For US only).

# Cleaning

Be sure to turn off the main power switch and unplug the power cord before you start cleaning.

## To clean the filter:

Clean the filter as frequently as possible (or once per month). Dust collecting on the filter of the intake vent may cause the temperature inside the projector to abnormally rise, damaging the parts inside and affecting the projector's lifetime, resulting in a breakdown.

- When the temperature inside the projector abnormally rises, the TEMP indicator starts blinking red, the power is turned off, and the projector goes into a standby state with the lamp off.

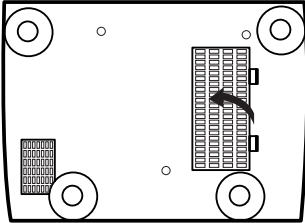

## How to clean the filter of the intake vent:

1. Reverse the projector.
  2. While pressing the tabs on the filter cover, remove the filter cover in the direction of the arrow.
  3. Remove the filter.
  4. Clean the filter.
    - Wash the filter with water, or if dust and dirt are stubborn, wash it with diluted detergent and then rinse it with water sufficiently. After washing, dry it well.
  5. Attach the filter to the projector.
  6. Attach the filter cover to the projector.
    - Make sure that the filter is attached correctly.
- If dirt on the filter cannot be removed or the filter should be damaged, contact your dealer for purchase of another filter.
  - Be sure to attach the filter to the projector. Without the filter, dust and foreign objects may enter the inside of the projector, causing a fire or breakdown.

## Cleaning dust in the intake vent

If dust is accumulated in the intake vent, the temperature in the projector goes up abnormally, and may damage the internal parts. Also, the light-source lamp may come off to protect the internal parts. Clean up the dust with a vacuum cleaner about once a year.

## Cleaning the projector

Softly wipe off dirt on the projector with a soft cloth.

- If the dirt is thick, wipe it off with a cloth soaked in a neutral detergent diluted with water, and then finish with a dry cloth.
- If any pesticide is sprayed over the projector, or if the projector is wiped with benzine or thinner, or if rubber or vinyl products are brought into contact with the projector for a long period of time, the paint on the projector could be damaged.

## Cleaning the lens

Remove dust or dirt on the lens with a commercially available lens cleaning kit (blower, brush, and the like).

- Because the surface of the lens is easily scratched, do not rub or hit the surface with anything hard.



# Asking for installation

## To view images projected by the ceiling-mounted projector from the front:

When the projector is installed on the ceiling, the special ceiling mount bracket, which is separately sold, is required. Be sure to ask a certified installation specialist for installation of the projector. Contact your dealer for details.

- Mitsubishi assumes no responsibilities for any damage caused by use of other manufacturer's ceiling bracket and by inadequate installation conditions even within the warranty period.

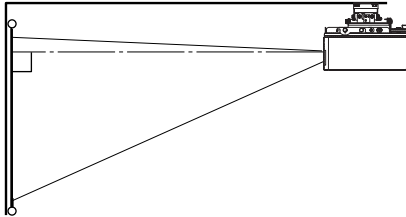

- When installing the projector on the ceiling, set **MIRROR** in the **INSTALLATION** menu to **CEILING FRONT**. See Page 25 for details.
- Ask your installation specialist to provide a breaker. When you do not use the projector, be sure to shut down the main power by the breaker.
- When the projector is installed on the ceiling, projected images may appear darker than those projected when the projector is installed on the floor. This symptom is not a malfunction.
- Do not install the projector where the exhaust vents are exposed to air emitted by an air conditioning. Such installation may cause a breakdown.
- Do not install the projector near a fire alarm because it emits hot air from its exhaust vents.

## To view images projected on the translucent screen from behind:

Be sure to ask a certified installation specialist for installation of the projector. Contact your dealer for details.

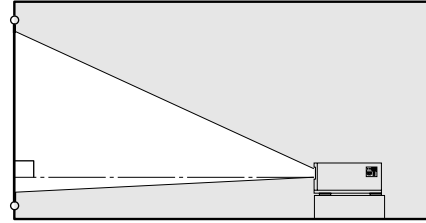

- To view images projected from behind the screen, set **MIRROR** in the **INSTALLATION** menu to **FLOOR REAR**. See Page 25 for details.

## Dimension Drawings (unit : mm)

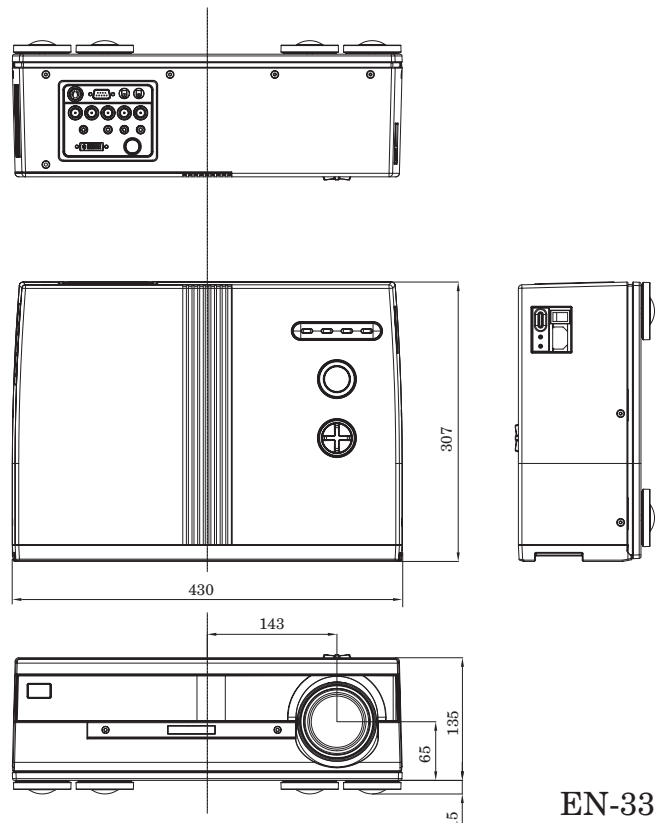
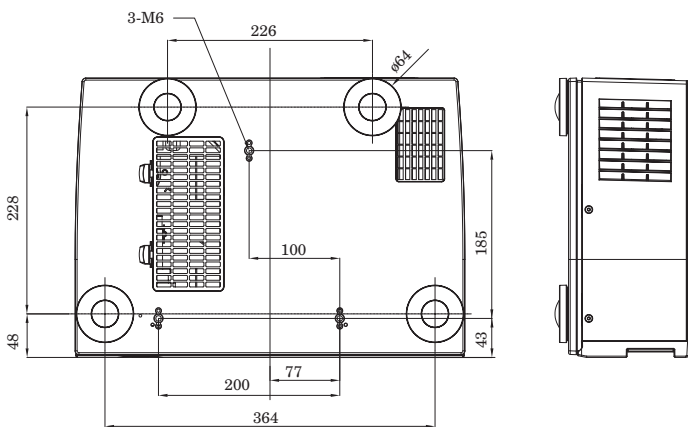

# Troubleshooting

Before asking for repair of the projector, check the following. If the symptom persists, stop using the projector, be sure to unplug the power plug, and then contact your dealer.

## No image appears on the screen.

Problem	Solution																												
Power can not be turned on.	<ul style="list-style-type: none"> <li>Check whether the indicators are on or off and how they are lighting.</li> </ul> <table border="1"> <thead> <tr> <th>LAMP</th> <th>TEMP</th> <th>POWER</th> <th>Solution</th> </tr> </thead> <tbody> <tr> <td></td> <td>○ Off</td> <td>○ Off</td> <td> <ul style="list-style-type: none"> <li>Connect the power cable to the projector.</li> <li>Plug the power plug in the wall outlet.</li> <li>Turn on the main power switch.</li> <li>Fit the lamp cover.</li> <li>When the projector is hot, turn off the POWER switch. Wait for the projector to cool down, and then turn on the power switch again.</li> </ul> </td> </tr> <tr> <td>○ Off</td> <td></td> <td>○ Blinking in red</td> <td> <ul style="list-style-type: none"> <li>After the POWER indicator stops blinking red, press the POWER button.</li> <li>If you turn on the main power switch when the inside of the projector is still hot, the lamp may not be able to turn on for about 90 seconds.</li> <li>After the lamp goes out, you cannot turn it on again for about two minutes.</li> </ul> </td> </tr> <tr> <td></td> <td></td> <td>○ Blinking in red</td> <td> <ul style="list-style-type: none"> <li>Replace the cooling fan. Contact your dealer for replacement.</li> </ul> </td> </tr> <tr> <td>○ Blinking in orange</td> <td></td> <td>○ On in red</td> <td> <ul style="list-style-type: none"> <li>After the TEMP indicator goes out, press the POWER button.</li> <li>Remove objects blocking the intake and/or exhaust vents, if any.</li> <li>Avoid the intake and/or exhaust vents from being exposed to hot air emitted from heating appliances.</li> </ul> </td> </tr> <tr> <td></td> <td>○ On in orange</td> <td>○ Blinking in red</td> <td> <ul style="list-style-type: none"> <li>Remove objects blocking the intake and/or exhaust vents, if any.</li> <li>Avoid the intake and/or exhaust vents from being exposed to hot air emitted from heating appliances.</li> </ul> </td> </tr> <tr> <td>☀ On in red</td> <td>○ Off</td> <td>○ Blinking in red</td> <td> <ul style="list-style-type: none"> <li>After the LAMP indicator goes out, press the POWER button. If the lamp does not turn on even after this procedure is repeated several times, replace the lamp. Contact your dealer for purchase of the lamp.</li> </ul> </td> </tr> </tbody> </table>	LAMP	TEMP	POWER	Solution		○ Off	○ Off	<ul style="list-style-type: none"> <li>Connect the power cable to the projector.</li> <li>Plug the power plug in the wall outlet.</li> <li>Turn on the main power switch.</li> <li>Fit the lamp cover.</li> <li>When the projector is hot, turn off the POWER switch. Wait for the projector to cool down, and then turn on the power switch again.</li> </ul>	○ Off		○ Blinking in red	<ul style="list-style-type: none"> <li>After the POWER indicator stops blinking red, press the POWER button.</li> <li>If you turn on the main power switch when the inside of the projector is still hot, the lamp may not be able to turn on for about 90 seconds.</li> <li>After the lamp goes out, you cannot turn it on again for about two minutes.</li> </ul>			○ Blinking in red	<ul style="list-style-type: none"> <li>Replace the cooling fan. Contact your dealer for replacement.</li> </ul>	○ Blinking in orange		○ On in red	<ul style="list-style-type: none"> <li>After the TEMP indicator goes out, press the POWER button.</li> <li>Remove objects blocking the intake and/or exhaust vents, if any.</li> <li>Avoid the intake and/or exhaust vents from being exposed to hot air emitted from heating appliances.</li> </ul>		○ On in orange	○ Blinking in red	<ul style="list-style-type: none"> <li>Remove objects blocking the intake and/or exhaust vents, if any.</li> <li>Avoid the intake and/or exhaust vents from being exposed to hot air emitted from heating appliances.</li> </ul>	☀ On in red	○ Off	○ Blinking in red	<ul style="list-style-type: none"> <li>After the LAMP indicator goes out, press the POWER button. If the lamp does not turn on even after this procedure is repeated several times, replace the lamp. Contact your dealer for purchase of the lamp.</li> </ul>
LAMP	TEMP	POWER	Solution																										
	○ Off	○ Off	<ul style="list-style-type: none"> <li>Connect the power cable to the projector.</li> <li>Plug the power plug in the wall outlet.</li> <li>Turn on the main power switch.</li> <li>Fit the lamp cover.</li> <li>When the projector is hot, turn off the POWER switch. Wait for the projector to cool down, and then turn on the power switch again.</li> </ul>																										
○ Off		○ Blinking in red	<ul style="list-style-type: none"> <li>After the POWER indicator stops blinking red, press the POWER button.</li> <li>If you turn on the main power switch when the inside of the projector is still hot, the lamp may not be able to turn on for about 90 seconds.</li> <li>After the lamp goes out, you cannot turn it on again for about two minutes.</li> </ul>																										
		○ Blinking in red	<ul style="list-style-type: none"> <li>Replace the cooling fan. Contact your dealer for replacement.</li> </ul>																										
○ Blinking in orange		○ On in red	<ul style="list-style-type: none"> <li>After the TEMP indicator goes out, press the POWER button.</li> <li>Remove objects blocking the intake and/or exhaust vents, if any.</li> <li>Avoid the intake and/or exhaust vents from being exposed to hot air emitted from heating appliances.</li> </ul>																										
	○ On in orange	○ Blinking in red	<ul style="list-style-type: none"> <li>Remove objects blocking the intake and/or exhaust vents, if any.</li> <li>Avoid the intake and/or exhaust vents from being exposed to hot air emitted from heating appliances.</li> </ul>																										
☀ On in red	○ Off	○ Blinking in red	<ul style="list-style-type: none"> <li>After the LAMP indicator goes out, press the POWER button. If the lamp does not turn on even after this procedure is repeated several times, replace the lamp. Contact your dealer for purchase of the lamp.</li> </ul>																										
No image appears on the screen.	<ul style="list-style-type: none"> <li>It may take about one minute for the lamp to light up.</li> <li>The lamp fails to light up on rare occasions. In such a case, wait for a few minutes and then try again.</li> <li>If the projector was turned off before the lamp was cooled down sufficiently last time, the fan may start rotating and the POWER button may not work after the main power switch is turned on. (In such a case, the POWER indicator turns on red and the TEMP indicator blinks orange.) After the fan stops rotating, press the POWER button to turn back on the POWER indicator.</li> <li>Check that the intake vent is clean.</li> <li>Check that the lamp cover is closed. (See Pages 30 and 31.)</li> <li>Check that the cables connected to the external devices are not broken.</li> <li>When an extension cable is being used, replace it with the supplied cable for check. When images are displayed correctly, add an RGB signal amplifier to the extension cable.</li> </ul>																												
Projected images suddenly disappear.	<ul style="list-style-type: none"> <li>This problem may occur when the intake vent and/or exhaust vents are blocked. (In such a case, the TEMP indicator turns on red and the POWER indicator blinks red.) → Remove the objects blocking the intake vent and/or exhaust vents and then carry out the following procedure.</li> </ul> <ol style="list-style-type: none"> <li>Wait for the intake fan and/or exhaust fan to stop. (Wait until the TEMP indicator goes out and the POWER indicator is lit red steadily.)</li> <li>Turn off the main power switch.</li> <li>Wait about 20 minutes.</li> <li>Turn on the main power switch.</li> <li>Press the POWER button. If the problem persists, attach the supplied cushion to the bottom surface of the projector. (See Page 11.)</li> </ol>																												

**Images are not displayed correctly.**

<b>Problem</b>	<b>Solution</b>
Projected images are distorted.	<ul style="list-style-type: none"> <li>Adjust the projector and the screen so that they are perpendicular to each other. (See Page 11.)</li> </ul>
Projected images are dark.	<ul style="list-style-type: none"> <li>Adjust <b>BRIGHTNESS</b> and <b>CONTRAST</b> in the <b>PICTURE</b> menu. (See Page 27.)</li> <li>Replace the lamp. (See Pages 30 and 31.)</li> </ul>
Projected images are blurred.	<ul style="list-style-type: none"> <li>Adjust the focus. (See Pages 16 and 20.)</li> <li>Check that the lens cap is removed.</li> <li>Clean the lens.</li> <li>Adjust <b>TRACKING</b> and <b>FINE SYNC</b> in the <b>SIGNAL SETTING</b> menu. (See Page 29.)</li> <li>Adjust <b>BRIGHTNESS</b> and <b>CONTRAST</b> in the <b>PICTURE</b> menu. (See Page 27.)</li> <li>Adjust the projector and the screen so that they are perpendicular to each other. (See Page 11.)</li> </ul>
White dots are seen on projected images. Black dots are seen on projected images.	<ul style="list-style-type: none"> <li>This symptom is normal for a DLP projector and is not a malfunction. (A very small number of pixels may stay lit or out, but such symptom is not a malfunction. Pixels of 99.99% or more are effective.)</li> </ul>
Rainbow effect is seen on projected images.	<ul style="list-style-type: none"> <li>This is due to color breaking noise that occurs in a DLP system and is not a malfunction.</li> </ul>
Fine streaks are seen on projected images.	<ul style="list-style-type: none"> <li>This is due to interference with the screen surface and is not a malfunction. Replace the screen or displace the focus a little.</li> </ul>
Projected images become wavy.	<ul style="list-style-type: none"> <li>Connect the plugs of the cables to external devices securely.</li> <li>Keep the projector away from devices that emit interfering radio waves.</li> </ul>
Hue is not appropriate.	<ul style="list-style-type: none"> <li>Check that <b>COMPONENT</b> in the <b>INSTALLATION</b> menu has been set correctly. (See Page 25.)</li> <li>Check that the cables connected to the external devices are not broken.</li> </ul>

**Others**

<b>Problem</b>	<b>Solution</b>
The exhaust vents emit warm air.	<ul style="list-style-type: none"> <li>This air comes out after cooling the inside of the projector. You may feel hot, but this is not a malfunction.</li> </ul>
Menus cannot be set.	<ul style="list-style-type: none"> <li>Being affected by noise, the microcomputer inside the projector may be working wrongly. → Turn off the power, wait for two minutes, and then turn it back on.</li> <li>When you cannot turn off the power, turn off the main power, leave the projector alone for at least 20 minutes, and then turn back on the power.</li> </ul>
Abnormal sound is heard.	<ul style="list-style-type: none"> <li>Because the color wheel spins at a high speed, metallic sounds may be heard in rare occasions. Such symptom is not a malfunction.</li> </ul>

**If the following problem occurs after the lamp is replaced, check the following first.**

<b>Problem</b>	<b>Solution</b>
The projector does not turn on.	<ul style="list-style-type: none"> <li>Fit the lamp cover securely. (See Pages 30 and 31.)</li> <li>Reset the lamp operating time. (See Page 31.)</li> </ul>

# Specifications

The specifications and outside appearance of the projector are subject to change without prior notice.

Model		HC2000	
Projection system		DLP™(Single-Chip DMD™) system	
Optical system		Mirror reflection system	
Mirror reflection system	Resolution	0.8" (Aspect ratio 16:9)	
	Projection lens	921600 dots (1280 x 720)	
Size	Focal distance	f= 28.3 - 38.2 mm	
Light-source lamp		250 W lamp	
Image size (Projection distance)		50" min. to 250" max. (Projection distance 1.75 to 8.75 m: WIDE end)	
Maximum number of display colors		16770000 (full-color display)	
Maximum resolution	Computer signal	Maximum resolution : 1600 x 1200 dots (Analog) / compressed Panel resolution : 1280 x 720 dots	
	Video signal	NTSC/PAL	
	Component signal	480i, 480p, 576i, 576p, 720p, 1080i Panel resolution : 1280 x 720 dots	
Computer input		[Signal type]	[Terminal type] [Line]
		Analog RGB	DVI 1
		Digital RGB	DVI 1
		(DVI terminal is used for both analog RGB and digital RGB.)	
		5-line RGB	BNC 1
Video input		[Signal type]	[Terminal type] [Line]
		Video input	RCA 1
		S-Video input	S 1
		Component video input	RCA 1
Control terminal/Others		RS-232C (D-SUB 9P) : For service person	
Operating temperatures		+41°F (+5°C) to +95°F (+35°C)	
Rated voltage		AC100 - 240V, 50/60Hz	
Power consumption		4A 350W	
Dimensions		430 mm (W) x 150 mm (V) x 307 mm (D) * Including legs	
Weight		7.8 kg	
Others	S-video input	Luminance signal : Vp-p=1.0 V 75Ω (negative sync) Chrominance signals : Vp-p=0.286 V 75Ω (burst signal)	
	Video input	Vp-p=1.0 V 75Ω (negative sync)	
	Component video input	YCbCr: Vp-p=1.0 V (Y) (negative sync) Vp-p=0.7 V (Cb, Cr)	
	Analog input (DVI/BNC)	RGB : Vp-p=0.7 V 75Ω (negative sync) YCbCr : Vp-p=1.0 V (Y) (negative sync) Vp-p=0.7 V (Cb, Cr) HD/CS : TTL-level (negative or positive polarity) VD : TTL-level (negative or positive polarity)	
	Digital input (DVI)	DVI interface (TMDS single link)	

## Replacement part (Option / Not included in the box)

Spare lamp VLT-D2010LP

## Type of connectable signals

Input signal				Screen size
Signal representation	Resolution	Horizontal sync frequency (kHz)	Vertical sync frequency (Hz)	Real display (H x V)
VGA	640 x 480	60	31.5	640 x 480
VGA	640 x 480	72	37.9	640 x 480
VGA	640 x 480	75	37.5	640 x 480
VGA	640 x 480	85	43.3	640 x 480
VGA	720 x 400	70	31.5	720 x 400
VGA	720 x 400	85	37.9	720 x 400
SVGA	800 x 600	56	35.2	800 x 600
SVGA	800 x 600	60	37.9	800 x 600
SVGA	800 x 600	72	48.1	800 x 600
SVGA	800 x 600	75	46.9	800 x 600
SVGA	800 x 600	85	53.7	800 x 600
XGA	1024 x 768	60	48.4	1024 x 720
XGA	1024 x 768	70	56.5	1024 x 720
XGA	1024 x 768	75	60.0	1024 x 720
XGA	1024 x 768	85	68.7	1024 x 720
SXGA	1280 x 1024	60	64.0	1280 x 720
SXGA	1280 x 1024	75	80.0	1280 x 720
SXGA	1280 x 1024	85	91.1	1280 x 720
UXGA	1600 x 1200	60	75.0	1280 x 720

\*1  
\*1  
\*1  
\*1  
\*1

\*1 ) Analog input only

### Important:

- The maximum resolution supported by this projector is 1280x720. Signals having a higher resolution than this are not projected with their original resolution.
- In the case of a signal having a resolution and sync frequency other than those described in the table above, it may be projected correctly by changing the resolution and frequency of the connected computer.
- The component input terminals of this projector do not support RGB signals.
- Nonconforming signals may not be projected correctly.
- Though it takes some time for an image to appear after a signal is input, such symptom is not a malfunction.
- This projector does not support 3-line signals (Sync-on-green signals).

## Connectors

RS-232C terminal  
(D-SUB 9P)

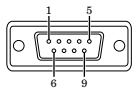

PIN No.	NAME	I/O
1	-	-
2	RXD	IN
3	TXD	OUT
4	-	-
5	GND	-
6	-	-
7	-	-
8	-	-
9	-	-

DVI terminal  
(DVI-D)

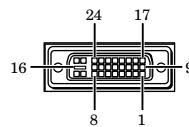

PIN NO.	STATUS	PIN NO.	STATUS
1	DATA 2-	13	-
2	DATA 2+	14	+5V Power
3	DATA 2 Shield	15	GND
4	-	16	Hot Plug Detect
5	-	17	DATA 0-
6	DDC Clock	18	DATA 0+
7	DDC Data	19	DATA 0 Shield
8	-	20	DATA 5-
9	DATA 1-	21	DATA 5+
10	DATA 1+	22	Clock Shield
11	DATA 1 Shield	23	Clock+
12	-	24	Clock-

DVI terminal  
(DVI-A)

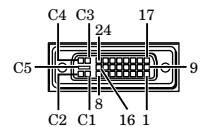

PIN NO.	STATUS
C1	ANALOG RED
C2	ANALOG GREEN
C3	ANALOG BLUE
C4	H Sync
C5	GND
6	DDC Clock
7	DDC Data
8	Analog Sync
14	+5V Power
15	GND
16	Hot Plug Detect

# MITSUBISHI Projector Contact Information

## North America

**MESCA** (Mitsubishi Electric Sales Canada Inc.)  
<http://www.mitsubishielectric.ca>  
Information Technologies Group, 4299 14th Avenue, Markham, Ontario L3R 0J2, Canada

Sales	Phone	:+1-(905) 475-7728
	Fax	:+1-(905) 475-7958
	E-mail	:projectors@mitsubishielectric.ca
Technical	Phone	:+1-(905) 475-7728
	Fax	:+1-(905) 475-7958
Customer Care	E-mail	:support@mitsubishielectric.ca

**MDEA** (Mitsubishi Digital Electronics America, Inc.)  
(Warranty Registration)  
<http://www.mitsubishi-presentations.com/>  
Presentation Products Division, 9351 Jeronimo Road, Irvine, CA 92618 U.S.A.

Phone	Main Line	:+1-(949) 465-6000
	Technical	:+1-(888) 307-0309
	Product Information	:+1-(888) 307-0312

Technical Support  
E-mail :tsupport@mdea.me.com

## Europe

**MEU-FRA** (Mitsubishi Electric Europe B.V. French Branch)  
25, Boulevard des Bouvets 92 741, Nanterre CEDEX, France

Sales	Phone	:+33 (0)1 55-68-55-07
	Fax	:+33 (0)1 55-68-57-31
Technical	Phone	:+33 (0)1 41-02-83-24
	Fax	:+33 (0)1 49-01-07-23

**MEU-GER** (Mitsubishi Electric Europe B.V. German Branch)  
<http://www.mitsubishi-evs.de/>  
Gothaer Strasse 8, 40880 Ratingen, Germany

**MEU-IR** (Mitsubishi Electric Europe B.V. Irish Branch)  
<http://www.mitsubishi.ie/>  
Westgate Business Park, Ballymount, Dublin 24, Ireland

Sales	Phone	:+353-(0)1-4198844
	Fax	:+353-(0)1-4564422
Technical	Phone	:+353-(0)1-4198807
	Fax	:+353-(0)1-4198895

**MEU-IT** (Mitsubishi Electric Europe B.V. Italian Branch)  
Centro Direzionale Colleoni, Palazzo Persero-Ingresso 2, Via Paracelso 12, 20041 Agrate Brianza, Italy

Sales	Phone	:+39-(0)39-60531
	Fax	:+39-(0)39-6053214
	E-mail	:info.projector@it.mee.com

**MEU-NL** (Mitsubishi Electric Europe B.V. Benelux Branch)  
<http://www.mitsubishi.nl/LCD/ProdFrame.html>  
Nijverheidsweg 23a, 3641 RP Mijdrecht, The Netherlands

Sales	Phone	:+31-297-282461
	Fax	:+31-297-283936
	E-mail	:info.lcd@nl.mee.com
Technical	Phone	:+31-297-282461
	Fax	:+31-297-283936
	E-mail	:info.lcd@nl.mee.com

**MEU** (MITSUBISHI ELECTRIC EUROPE B.V.)  
<http://www.mitsubishi-projector.ru/>  
Moscow Representative Office, 12/1 Goncharnaya St. 109240, Moscow, Russia

Sales	Phone	:+7 (095) 915 8602
	Fax	:+7 (095) 915 8603

**MEU-SP** (Mitsubishi Electric Europe B.V. Spanish Branch)  
<http://www.mitsubishielectric.es/>  
Ctra. de Rubi, 76-80, 08190 Sant Cugat del Valles, Barcelona, Spain

Sales	Phone	:+34-93.565.31.54
	Fax	:+34-93.589.43.88
	E-mail	:mitsubishi.profesional@sp.mee.com
Technical	Phone	:+34-93.586.27.51
	Fax	:+34-93.699.74.45
	E-mail	:mitsubishi.profesional@sp.mee.com

**MEU-SWE** (Mitsubishi Electric Europe B.V. Scandinavian Branch)  
Hammarbacken 14, Box 750, S-19127, Sollentuna, Sweden

Sales	Phone	:+46-(0)8-6251070
	Fax	:+46-(0)8-6251036
Technical	Phone	:+46-(0)8-6251052
	Fax	:+46-(0)8-6251036

**MEU-UK** (Mitsubishi Electric Europe)  
<http://www.mitsubishi.co.uk/evs/>  
Visual Information Systems Division, Travellers Lane, Hatfield, Hertfordshire, AL10 8XB

Sales	Phone	:+44 (1707) 278684
	Fax	:+44 (1707) 278541
	E-mail	:projector.info@meuk.mee.com
Technical	Phone	:+44 (870) 606 5008
	Fax	:+44 (1506) 431927
	E-mail	:projector.info@meuk.mee.com

**Russia** (Mitsubishi Electric Europe B.V. Moscow Representative Office)  
52, bldg.5, Kosmodamianskaya Nab, 113054, Moscow, Russian Federation

Sales	Phone	:+7 (095) 721 2070
	Fax	:+7 (095) 721 2071
Technical	Phone	:+7 (095) 721 2070
	Fax	:+7 (095) 721 2071

## Asia

**RIL** (Ryoden (Holdings) Ltd.)  
<http://www.ryoden.com.hk>

- Hong Kong Office  
15/F, Manulife Tower, 169 Electric Road, North Point, Hong Kong, China  
Technical Support  
Phone :+852 6510 1750  
Fax :+852 2887 8027
- Beijing Office  
9/F, Office Tower 1, Henderson Centre, 18 Jianguomennei Dajie, Dongcheng District, Beijing, 100005, China  
Sales & Technical Support  
Phone :+86 (10) 6518 2930  
Fax :+86 (10) 6518 2530
- Shanghai Office  
10/F, Shanghai Square Office Tower, 138 Huai Hai Zhong Road, Lu Wan District, Shanghai, 200021, China  
Sales & Technical Support  
Phone :+86 (21) 6327 2228  
Fax :+86 (21) 6327 4918
- Shenzhen Office  
Unit 01-04, 13/F, Building A, Tian An International Building, Renmin Road South, Shenzhen, 518005, China  
Sales & Technical Support  
Phone :+86 (755) 518 6386  
Fax :+86 (755) 218 4775
- Chengdu Office  
Block B-1, 23/F, Chuan Xin Mansion, 18 Section 2, Renmin Road South, Chengdu, 610016, China  
Sales & Technical Support  
Phone :+86 (28) 619 9730  
Fax :+86 (28) 619 9801

**REMECO** (Ryoden Merchandising Co., Ltd.)  
<http://www.mitsubishi-ryoden.com.hk>  
Units 5-10, 20th Floor, Tower I, Ever Gain Plaza, 88 Container Port Road, Kwai Chung, N.T., Hong Kong, China

Sales Support	Phone	:+852 2510 2119
	Fax	:+852 2510 463
Technical Support	Phone	:+852 2510 2188
Sales & Technical Support		
E-mail	:info.pav@remeco.meap.com	

**MEAP** (Mitsubishi Electric Asia Pte Ltd)  
<http://www.mitsubishielectric.com.sg>  
307 Alexandra Road, Mitsubishi Electric Building, 289245, Singapore

Main Line	Phone	:+65 6 473 2308
	Fax	:+65 6 475 9503
Sales & Technical Support		
E-mail	:peripherals@asia.meap.com	

**AMS** (Antah Melco Sales & Services Sdn Bhd  
(A Joint-Venture Company of Mitsubishi Electric Corporation))  
<http://www.antahmelco.com.my>  
6, Jalan 13/6, Petaling Jaya, Selangor Darul Ehsan, Malaysia

Main Line	Phone	:+603-7955 2088
	Fax	:+603-7956 3950
		:+603-7958 2576

Technical Support  
Phone :+603-7955 2088  
E-mail :anmelco@po.jaring.my  
Product Information  
Phone :+603-7955 2088

**ME-TWN** (Mitsubishi Electric Taiwan Co., Ltd.)  
<http://www.mitsubishi-electric.com.tw>  
9th Floor, 90 Sec. 6, Chung Shan N. Rd., Taipei, Taiwan

Sales Support	Phone	:+886 (0) 2 2832 8255
	Fax	:+886 (0) 2 2833 9813

**KYW** (Kang Yong Watana Co., Ltd.)  
<http://www.mitsubishi-kyw.in.th>  
28 Krungthep Kreetha Road, Huamark Bangkok, Bangkok, 10240, Thailand

Sales Support	Phone	:+66 (2) 731 6901
	Fax	:+66 (2) 379 4763

**STC** (Setsuyo Trading Co.Ltd. Seoul Branch)  
Dongseo Game Channel Bldg, 660-11, Deungchon-dong, Kangseo-ku, Seoul, Korea

Main Line	Phone	:+82 (0) 2 3665 4964
	Fax	:+82 (0) 2 3665 4965

## Oceania

**ME-AUST** (Mitsubishi Electric Australia)  
<http://www.mitsubishi-electric.com.au/prod.asp?prod=proj>  
348 Victoria Road, Rydalmere, N.S.W. 2116, Australia

Sales	Phone	:+(612)9684-7777
	Fax	:+(612)9898-0484
	E-mail	:ped@meaust.meap.com

**MENZ** (BDT Ltd)  
(Warranty Registration) <http://www.bdt.co.nz/projectors/warranty.asp>  
1 Parliament St, Lower Hutt, Wellington, New Zealand

Sales	Phone	:+64-(0)4-560-9100
	Fax	:+64-(0)4-560-9133
	E-mail	:help@bdt.co.nz
Technical	Phone	:+64-(0)4-560-9100
	Fax	:+64-(0)4-560-9133

Manufactured by Mitsubishi Electric Corporation  
1 Zusho Baba, Nagaokakyo-City, Kyoto Japan

 **MITSUBISHI ELECTRIC CORPORATION**

Printed in JAPAN