

DATA PROJECTOR

MODEL

# **XD470U/XD470U-G**

User Manual

# *XD470U*

# *XD470U-G*

This User Manual is important to you.  
Please read it before using your projector.

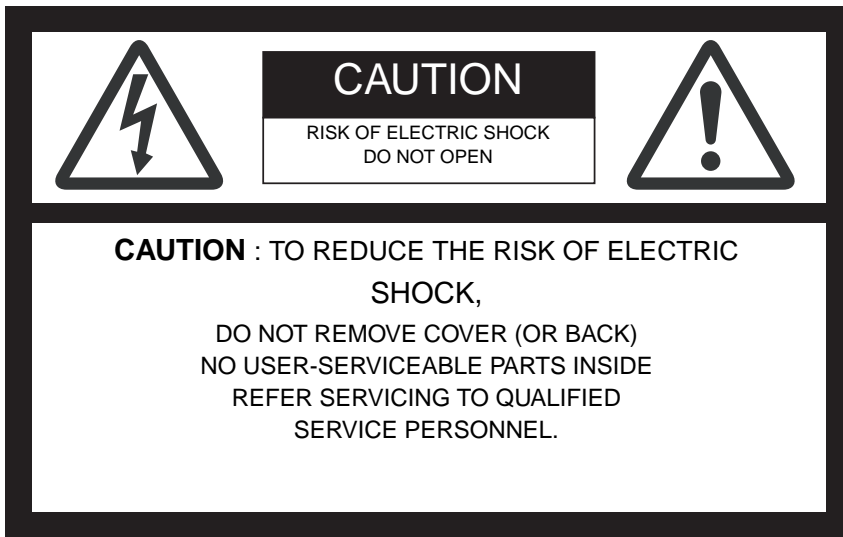

The lightning flash with arrowhead symbol within an equilateral triangle is intended to alert the user to the presence of uninsulated "dangerous voltage" within the product's enclosure that may be of sufficient magnitude to constitute a risk of electric shock.

The exclamation point within an equilateral triangle is intended to alert the user to the presence of important operating and maintenance (servicing) instructions in the literature accompanying the appliance.

**WARNING:**

TO PREVENT FIRE OR SHOCK HAZARD, DO NOT EXPOSE THIS APPLIANCE TO RAIN OR MOISTURE.

**CAUTION:**

TO PREVENT ELECTRIC SHOCK, DO NOT USE THIS (POLARIZED) PLUG WITH AN EXTENSION CORD, RECEPTACLE OR OTHER OUTLET UNLESS THE BLADES CAN BE FULLY INSERTED TO PREVENT BLADE EXPOSURE.

**NOTE:**

SINCE THIS PROJECTOR IS PLUGGABLE EQUIPMENT, THE SOCKET-OUTLET SHALL BE INSTALLED NEAR THE EQUIPMENT AND SHALL BE EASILY ACCESSIBLE.

**WARNING**

Use the attached specified power supply cord. If you use another power supply cord, it may cause interference with radio and television reception.

Use the attached RGB cable with this equipment so as to keep interference within the limit of an FCC Class B device.

This apparatus must be grounded.

**DO NOT LOOK DIRECTLY INTO THE LENS WHEN THE PROJECTOR IS IN THE POWER ON MODE.**

**CAUTION**

Not for use in a computer room as defined in the Standard for the Protection of Electronic Computer/Data Processing Equipment, ANSI/NFPA 75.

The attached power cord is to be used exclusively for this product. Never use them for other products.

**When using the projector in Europe:**

**COMPLIANCE NOTICE**

This Projector complies with the requirements of the EC Directive 89/336/EEC "EMC Directive" as amended by Directive 92/31/EEC and 93/68/EEC, and 2006/95/EC "Low Voltage Directive".

The electro-magnetic susceptibility has been chosen at a level that gains proper operation in residential areas, on business and light industrial premises and on small-scale enterprises, inside as well as outside of the buildings. All places of operation are characterized by their connection to the public low voltage power supply system.

**WARNING**

Use the attached RGB cable with this equipment so as to keep interference within the limits of an EN55022 Class B device.

Please follow WARNING instructions.



**Note:** This symbol mark is for EU countries only. This symbol mark is according to the directive 2002/96/EC Article 10 Information for users and Annex IV.

Your MITSUBISHI ELECTRIC product is designed and manufactured with high quality materials and components which can be recycled and reused.

This symbol means that electrical and electronic equipment, at their end-of-life, should be disposed of separately from your household waste.

Please, dispose of this equipment at your local community waste collection/recycling centre.

In the European Union there are separate collection systems for used electrical and electronic product.

Please, help us to conserve the environment we live in!

Important safeguards.....	4
Overview.....	6
Remote control .....	8
Installation .....	9
Basic connections.....	10
Preparation .....	12
Basic operation.....	13
Menu operation.....	15
Image adjustment .....	18
Advanced feature.....	20
Lamp replacement.....	22
Troubleshooting .....	23
Indicators .....	26
Specifications .....	27

### Declaration of Conformity

Model Number : XD470U/XD470U-G  
Trade Name : MITSUBISHI ELECTRIC  
Responsible party : Mitsubishi Digital Electronics America, Inc.  
9351 Jeronimo Road, Irvine, CA 92618 U.S.A  
Telephone number : +1-(949) 465-6000

This device complies with Part 15 of the FCC Rules. Operation is subject to the following two conditions:

- (1) this device may not cause harmful interference, and
- (2) this device must accept any interference received, including interference that may cause undesired operation.

### Trademark, Registered trademark

Macintosh is registered trademark of Apple Computer Inc.

DLP™, Digital Micromirror Device and DMD are all trademarks of Texas Instruments.

Other brand or product names are trademarks or registered trademarks of their respective holders.

# Important safeguards

Please read all these instructions regarding your projector and retain them for future reference. Follow all warnings and instructions marked on the projector.

1. Read instructions  
All the safety and operating instructions should be read before the appliance is operated.
2. Retain instructions  
The safety and operating instructions should be retained for future reference.
3. Warnings  
All warnings on the appliance and in the operating instructions should be adhered to.
4. Instructions  
All operating instructions must be followed.
5. Cleaning  
Unplug this projector from the wall outlet before cleaning it. Do not use liquid aerosol cleaners. Use a damp soft cloth for cleaning.
6. Attachments and equipment  
Never add any attachments and/or equipment without the approval of the manufacturer as such additions may result in the risk of fire, electric shock or other personal injury.
7. Water and moisture  
Do not use this projector near water or in contact with water.
8. Accessories  
Do not place this projector on an unstable cart, stand, tripod, bracket or table. Use only with a cart, stand, tripod bracket, or table recommended by the manufacturer or sold with the projector. Any mounting of the appliance should follow the manufacturer's instructions and should use a mounting accessory recommended by the manufacturer.



An appliance and cart combination should be moved with care. Quick stops, excessive force and uneven surfaces may cause the appliance and cart combination to overturn.

9. Ventilation  
Slots and openings in the cabinet are provided for ventilation, ensuring reliable operation of the projector and to protect it from overheating. Do not block these openings or allow them to be blocked by placing the projector on a bed, sofa, rug, or bookcase. Ensure that there is adequate ventilation and that the manufacturer's instructions have been adhered to.
10. Power sources  
This projector should be operated only from the type of power source indicated on the marking label. If you are not sure of the type of power, please consult your appliance dealer or local power company.
11. Power-cord protection  
Power-supply cords should be routed so that they are not likely to be walked on or pinched by items placed upon or against them. Pay particular attention to cords at plugs, convenience receptacles, and points where they exit from the appliance. Do not put the power cord under a carpet.

12. Overloading  
Do not overload wall outlets and extension cords as this can result in a fire or electric shock.
13. Objects and liquids  
Never push objects of any kind through openings of this projector as they may touch dangerous voltage points or short-out parts that could result in a fire or electric shock. Never spill liquid of any kind on the projector.
14. Servicing  
Do not attempt to service this projector yourself. Refer all servicing to qualified service personnel.
15. Damage requiring service  
Unplug this projector from the wall outlet and refer servicing to qualified service personnel under the following conditions:
  - (a) If the power-supply cord or plug is damaged.
  - (b) If liquid has been spilled, or objects have fallen into the projector.
  - (c) If the projector does not operate normally after you follow the operating instructions. Adjust only those controls that are covered by the operating instructions. An improper adjustment of other controls may result in damage and may often require extensive work by a qualified technician to restore the projector to its normal operation.
  - (d) If the projector has been exposed to rain or water.
  - (e) If the projector has been dropped or the cabinet has been damaged.
  - (f) If the projector exhibits a distinct change in performance - this indicates a need for service.
16. Replacement parts  
When replacement parts are required, be sure that the service technician has used replacement parts specified by the manufacturer or parts having the same characteristics as the original part. Unauthorized substitutions may result in fire, electric shock or other hazards.
17. Safety check  
Upon completion of any service or repair to this projector, ask the service technician to perform safety checks determining that the projector is in a safe operating condition.

**WARNING:****Unplug immediately if there is something wrong with your projector.**

Do not operate if smoke, strange noise or odor comes out of your projector. It may cause fire or electric shock. In this case, unplug immediately and contact your dealer.

**Never remove the cabinet.**

This projector contains high voltage circuitry. An inadvertent contact may result in an electric shock. Except as specifically explained in User Manual, do not attempt to service this product by yourself. Please contact your dealer when you want to fix, adjust, or inspect the projector.

**Do not modify the projector.**

It can lead to fire or electric shock.

**Do not keep using the damaged projector.**

If the projector is dropped and the cabinet is damaged, unplug the projector and contact your dealer for inspection. It may lead to fire if you keep using the damaged projector.

**Do not face the projection lens to the sun.**

It can lead to fire.

**Use correct voltage.**

If you use incorrect voltage, it can lead to fire.

**Do not place the projector on uneven surface.**

Place the projector on a level and stable surface only.

**Do not look into the lens when the projector is operating.**

It may hurt your eyes. Never let children look into the lens when the projector is on.

**Do not unplug the power cord during operation.**

It can lead to lamp breakage, fire, electric shock or other trouble. Wait for the fan to stop before unplugging the power cord.

**Do not touch the air outlet grilles and bottom plate.**

Do not touch them or put other equipment close to the air outlet grilles because they become hot during operation. The heated air outlet grilles and bottom plate may cause injury or damage to other equipment. Also, do not put the projector on a desk that is easily affected by heat.

**Do not look into the air outlet grilles when projector is operating.**

Heat, dust, etc. may blow out of them and hurt your eyes.

**Do not block the air inlet and outlet grilles.**

If they are blocked, heat may be generated inside the projector, causing deterioration in the projector quality and fire.

**Do not use flammable solvents (benzene, thinner, etc.) and flammable aerosols near the projector.**

Flammable substances may ignite causing fire or breakdown because the temperature inside the projector rises very high while the lamp is illuminating.

**Place of installation**

For safety's sake, do not use the projector at any place subjected to high temperature and high humidity. Please maintain an operating temperature, humidity, and altitude as specified below.

- Operating temperature: between +41°F (+5°C) and +95°F (+35°C)
- Operating humidity: between 30% and 90%
- Never put any heat-producing device under the projector to prevent the projector from being overheated.
- Do not install the projector at a place that is unstable or subject to vibration.
- Do not install the projector near any equipment that produces a strong magnetic field. Also refrain from installing the projector near any cable carrying a large amount of current.
- Place the projector on a solid, vibration-free surface. Otherwise it may fall, causing serious injury or damage.
- Do not stand the projector on its end. It may fall, causing serious injury or damage.
- Slanting the projector more than  $\pm 10^\circ$  (right and left) or  $\pm 15^\circ$  (front and rear) may cause trouble or explosion of the lamp.
- Do not place the projector near air-conditioning unit or heater to avoid the air outlet and inlet grilles from being exposed to hot air.

**COMPLIANCE NOTICE OF FCC**

This equipment has been tested and found to comply with the limits for a Class B digital device, pursuant to Part 15 of the FCC Rules. These limits are designed to provide reasonable protection against harmful interference in a residential installation. This equipment generates, uses and can radiate radio frequency energy and, if not installed and used in accordance with the instructions, may cause harmful interference to radio communications. However, there is no guarantee that interference will not occur in a particular installation. If this equipment does cause harmful interference to radio or television reception, which can be determined by turning the equipment off and on, the user is encouraged to try to correct the interference by one or more of the following measures:

- Reorient or relocate the receiving antenna.
- Increase the separation between the equipment and receiver.
- Connect the equipment into an outlet on a circuit different from that to which the receiver is connected.
- Consult the dealer or an experienced Radio / TV technician for help.

Changes or modifications not expressly approved by Mitsubishi could void the user's authority to operate this equipment.

**COMPLIANCE NOTICE OF INDUSTRY CANADA**

This Class B digital apparatus complies with Canadian ICES-003.

# Overview

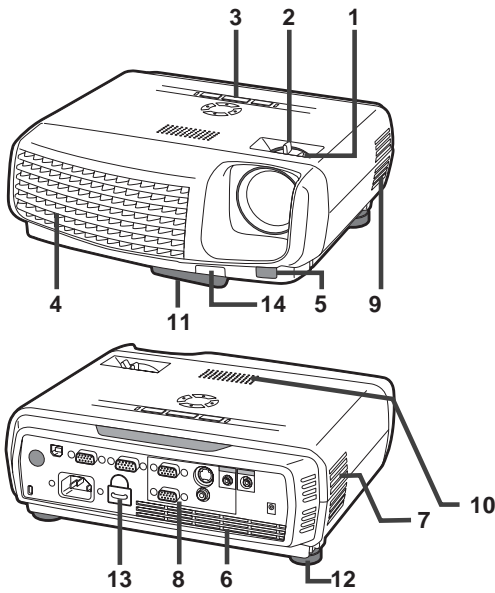

- 1 FOCUS ring
- 2 ZOOM ring
- 3 Control panel
- 4 Air outlet grille
- 5 Remote control sensor (Front)
- 6 Air inlet grille
- 7 Air inlet grille
- 8 Terminal board
- 9 Air inlet grille
- 10 Speaker
- 11 Adjustment feet (front)
- 12 Adjustment feet (rear)
- 13 Lock bar
- 14 Foot Adjustment button (Front)

## Control panel

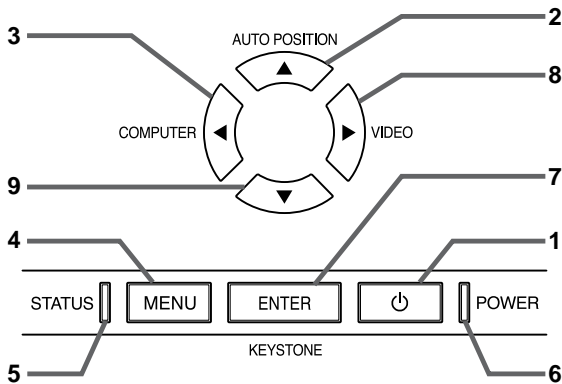

- 1 Power button
- 2 AUTO POSITION / ▲ button
- 3 COMPUTER / ◀ button
- 4 MENU button
- 5 STATUS indicator
- 6 POWER indicator
- 7 KEYSTONE/ENTER button
- 8 VIDEO / ▶ button
- 9 ▼ button

### Important:

- While the menu or the screen for the keystone adjustment or password entry is being displayed, the COMPUTER, VIDEO, and AUTO POSITION buttons function as the ◀, ▶, and ▲ buttons respectively.
- While the menu is on the screen, the KEYSTONE button functions as the ENTER button.

## Terminal board

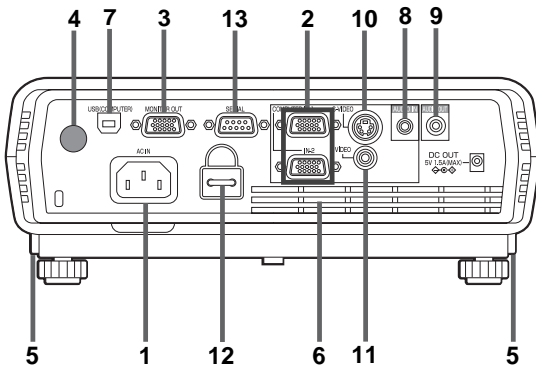

- 1 Power jack
- 2 COMPUTER IN terminal (1, 2) (Mini D-SUB 15-pin)
- 3 MONITOR OUT terminal (Mini D-SUB 15-pin)
- 4 Remote control sensor (Rear)
- 5 Foot adjustment buttons (Left/Right)
- 6 Air inlet grille
- 7 USB (PC) terminal
- 8 AUDIO IN terminal (Mini jack)
- 9 AUDIO OUT terminal (Mini jack)
- 10 S-VIDEO terminal
- 11 VIDEO terminal
- 12 Lock bar
- 13 SERIAL (RS-232C) terminal (D-SUB 9-pin)

## Bottom side

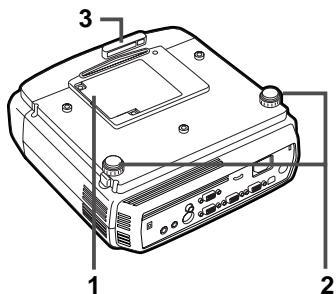

- 1 Lamp cover
- 2 Adjustment feet (rear)
- 3 Adjustment feet (front)

### Caution:

Do not replace the lamp immediately after using the projector because the lamp would be extremely hot and it may cause burns.

## Remote control

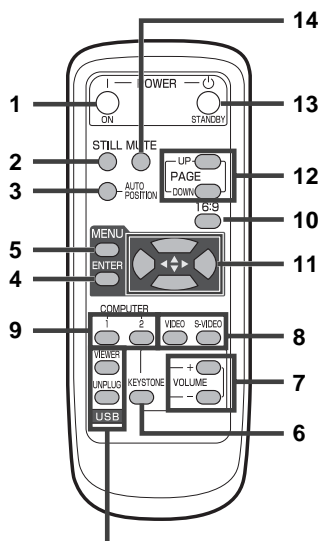

This model does not have this function.

- 1 ON button
  - 2 STILL button
  - 3 AUTO POSITION button
  - 4 ENTER button
  - 5 MENU button
  - 6 KEYSTONE button
  - 7 +, - (VOLUME) buttons
  - 8 VIDEO, S-VIDEO button
  - 9 COMPUTER (1, 2) button
  - 10 16 : 9 button
  - 11 Direction buttons
  - 12 PAGE UP / DOWN button
  - 13 OFF button
  - 14 MUTE button (Audio/Video)
- The + and - buttons are used in the KEYSTONE adjustment in addition to the volume control.

# Remote control

## Battery installation

Use two (AA, R6) size batteries.

1. Remove the back cover of the remote control by pushing the battery compartment door in the direction of the arrow.
2. Load the batteries making sure that they are positioned correctly (+ to +, and - to -).
  - Load the batteries from - spring side, and make sure to set them tightly.
3. Replace the back cover.

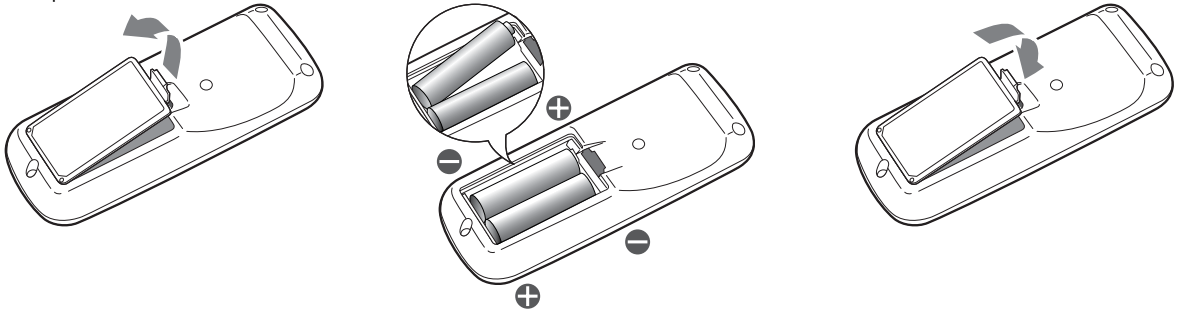

## Caution:

- Use of a battery of wrong type may cause explosion.
- Only Carbon-Zinc or Alkaline-Manganese Dioxide type batteries should be used.
- Dispose of used batteries according to your local regulations.
- Batteries may explode if misused. Do not recharge, disassemble, or dispose of in fire.
- Be sure to handle the battery according to the instructions.
- Load the battery with its positive (+) and negative (-) sides correctly oriented as indicated on the remote control.
- Keep batteries out of reach of children and pets.
- Remove the battery, if the remote control is not used for a long time.
- Do not combine a new battery with an old one.
- If the solution of batteries comes in contact with your skin or clothes, rinse with water. If the solution comes in contact with your eyes, rinse them with water and then consult your doctor.

## Operation range (of the remote control)

The maximum operation distance of the remote control is about 10 m (or about 32 feet) when the remote control is pointed at the remote control sensor of the projector. When the remote control is pointed to the screen, the distance from the remote control to the projector via the screen should be 5 m or less. However, the operation distance varies depending on the type of the screen used.

## Reception angle (vertical)

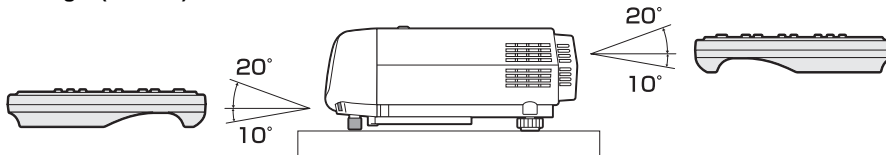

## Reception angle (horizontal)

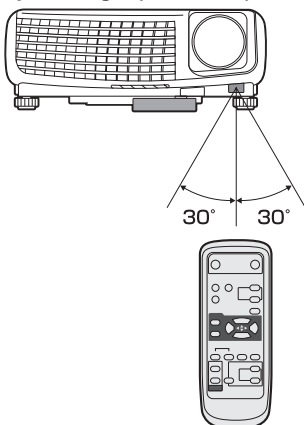

## Reception angle (vertical), ceiling mount

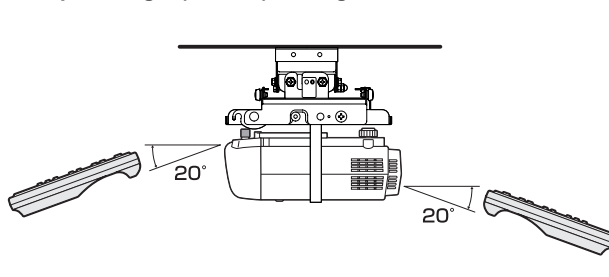

## Important:

- Do not expose the remote control sensor to direct sunlight or fluorescent. Keep a distance at least 2 m (6.5 feet) between the remote control sensor and the fluorescent light to ensure correct operation of the remote control.  
Inverted fluorescent light, if located near the projector, may interfere the remote control.
- When you use the remote control too close to the remote control sensor, the remote control may not work correctly.



# Installation

## Layout of the projector

Image size varies depending on the distance between the screen and the projector.

### Front projection

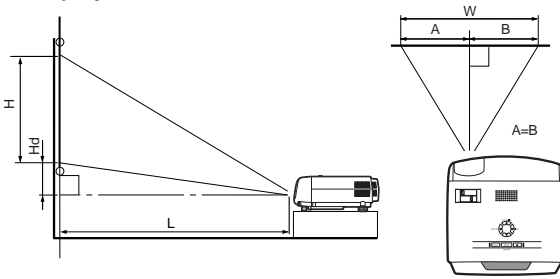

L : Between the screen and the front edge of the projector  
Hd : Height of the projected image

Screen						Distance from the screen : L				Hd	
Diagonal size		Width : W		Height : H		Shortest (WIDE)		Longest (TELE)			
inch	cm	inch	cm	inch	cm	inch	m	inch	m	inch	cm
40	102	32	81	24	61	50	1.3	61	1.5	3.5	8.8
60	152	48	122	36	91	76	1.9	91	2.3	5.2	13.3
80	203	64	163	48	122	101	2.6	121	3.1	7.0	17.7
100	254	80	203	60	152	126	3.2	151	3.8	8.7	22.1
150	381	120	305	90	229	189	4.8	227	5.8	13.1	33.2
200	508	160	406	120	305	252	6.4	302	7.7	17.4	44.2
250	635	200	508	150	381	315	8	378	9.6	21.8	55.3
300	762	240	610	180	457	378	9.6	-	-	26.1	66.3

The above figures are approximate and may be slightly different from the actual measurements.

### Front projection, ceiling mounting

For ceiling mounting, you need the ceiling mount kit designed for this projector. Ask a specialist for installation.

For details, consult your dealer.

- The warranty on this projector does not cover any damage caused by use of any non-recommended ceiling mount kit or installation of the ceiling mount kit in an improper location.

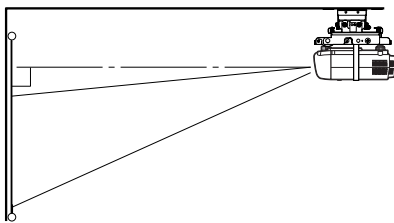

- When using the projector mounted on the ceiling, set IMAGE REVERSE in the INSTALLATION menu to MIRROR INVERT. See page 16.
- When the projector is mounted on the ceiling, images may appear darker than those projected in the case of tabletop mounting. This isn't a product malfunction.

### Rear projection

Ask a specialist for installation. For details, consult your dealer.

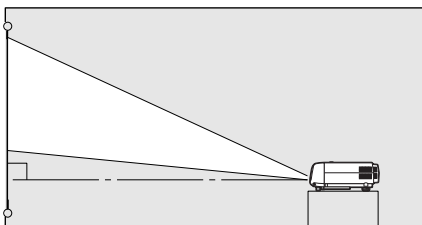

- For rear projection, set IMAGE REVERSE in the INSTALLATION menu to MIRROR. See page 16.

### Caution:

- Placing the projector directly on a carpet impairs ventilation by the fans, causing damage or failure. Put a hard board under the projector to facilitate ventilation.
- Place the projector at least 50 cm (or 20 inch) away from the wall to prevent the air inlet grille and the air outlet grilles that emit hot air from being blocked.
- Do not use the projector in the following locations and manners, which may cause fire or electric shock.
  - In a dusty or humid place.
  - In a sideways or upside-down position.
  - Near a heater.
  - In an oily, smoky, or damp place such as a kitchen.
  - In direct sunlight.
  - Where the temperature rises high, such as in a closed car.
  - Where the temperature is lower than +41°F (or +5°C) or higher than +95°F (or +35°C).

### Important:

- Do not apply force to the lens, because the lens may be damaged.
- We don't recommend using the projector at an altitude of 1500 meters or higher. Use at an altitude of 1500 meters or higher may affect the projector's life.

# Basic connections

This projector can be connected with various devices such as a VCR, video camera, videodisc player, and personal computer that have analog RGB output connectors.

## Important:

- Make sure that the connected device is turned off before starting connection.
- Plug in the power cords of the projector and the connected devices firmly. When unplugging, hold and pull the plug. Do not pull the cord.
- When the projector and the connected devices are located too close to each other, the projected image may be affected by their interference.
- See the owner's guide of each device for details about its connections.

## Projector + AV device

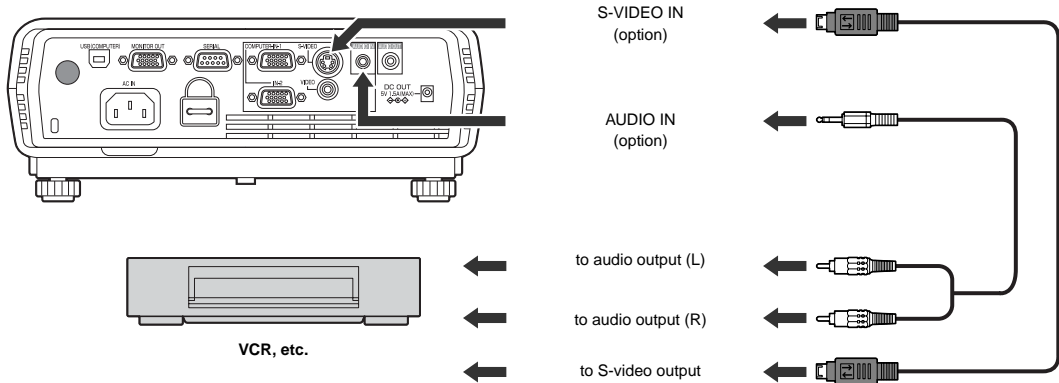

## Important:

- Match the colors of the video and audio plugs on the Audio cable with those of the terminals.
- Speaker output is mono.

## Projector + DVD player or HDTV decoder

Some DVD players have an output connector for 3-line fitting (Y, CB, CR). When connecting such DVD player with this projector, use the COMPUTER IN terminal.

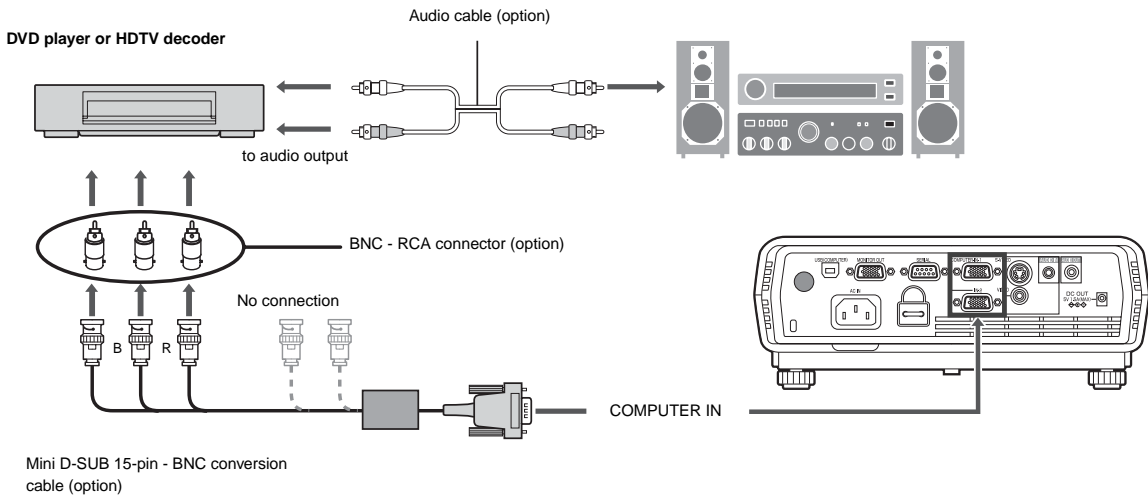

## Important:

- The terminal's names Y, PB, and PR are given as examples of when a HDTV decoder is connected.
- The terminal's names vary depending on the connected devices.
- Use a Mini D-SUB 15-pin - BNC conversion cable for connection.
- Image may not be projected correctly with some DVD players.
- When connecting a HDTV decoder having RGB output terminals, set COMPUTER INPUT to RGB in the SIGNAL menu.
- Speaker output is mono.

## Projector + Computer

### For computer with Mini D-SUB

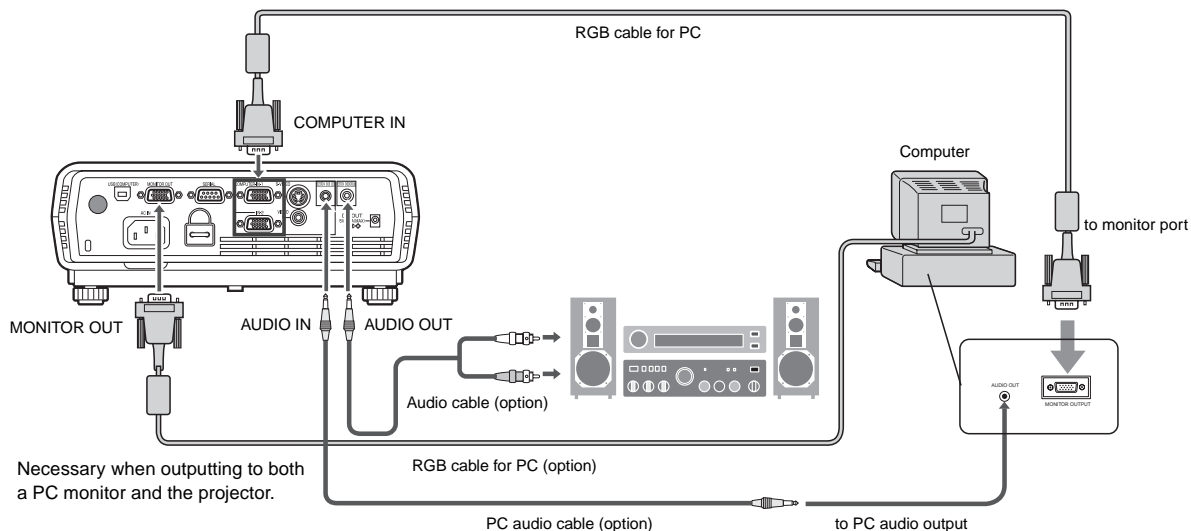

#### For analog connection:

1. Connect one end of the supplied RGB cable to the COMPUTER IN terminal (1, 2) of the projector.
2. Connect the other end of the RGB cable to the monitor port of the computer.

#### For monitor connection:

Connect the RGB cable from the monitor to the MONITOR OUT terminal of the projector.

#### Important:

- When you use a longer RGB cable instead of the provided cable, the image may not be projected correctly.
- Some computers require additional connectors or analog RGB output adapters to be connected with this projector. Contact your dealer for further information.
- This projector uses stereo pin jack for its audio input. Check the type of the audio output terminal of the connected computer and prepare a proper cable for connection. Some computers don't have the audio output terminal.
- Speaker output is mono.
- When the audio cable is connected to the AUDIO OUT terminal, the speaker output is muted.

#### For Macintosh

- If your Macintosh has no video port, a monitor output adapter is required. Contact your dealer for further information.
- Some Macintoshes require a MAC adapter for the RGB cable for connection with this projector. Contact your dealer for further information.

# Preparation

## Preparation for projection

1. Attach the provided power cord to the projector.
2. Plug the power cord in the wall outlet.
3. Remove the lens cap.

### Warning:

- Do not look into the lens directly when the projector is on.
- The lens cap is for protecting the lens. If you leave the lens cap on the lens with the projector turned on, it may be deformed because of heat build-up. Remove the lens cap when you turn on the projector.
- One of power cords for the U.S., Europe and U.K. is provided appropriately.
- This projector uses the power plug of three-pin grounding type. Do not remove the grounding pin from the power plug. If the power plug doesn't fit your wall outlet, ask an electrician to change the wall outlet.
- In case that the power cord for the U.S is provided with this projector, never connect this cord to any outlet or power supply using other voltages or frequencies than rated. If you want to use a power supply using other voltage than rated, prepare an appropriate power cord separately.
- Use 100-240 V AC 50/60 Hz to prevent fire or electric shock.
- Do not place any objects on the power cord or do not place the projector near heat sources to prevent damage to the power cord. If the power cord should be damaged, contact your dealer for replacement because it may cause fire or electric shock.
- Do not modify or alter the power cord. If the power cord is modified or altered, it may cause fire or electric shock.

### Caution:

- Plug in the power cord firmly. When unplugging, hold and pull the power plug, not the power cord.
- Do not plug in or out the power cord with your hand wet. It may cause electric shock.

## Adjustment of the projection angle

For the best projection, project images on a flat screen installed at 90 degrees to the floor. If necessary, tilt the projector using the two adjustment feet on the bottom of the projector.

## Using the adjustment feet (front)

1. Tilt up the projector to the appropriate angle.
2. Press the foot adjustment button (front).
3. Release the foot adjustment button (front) after fine adjusting a position of lengthwise direction of the image.

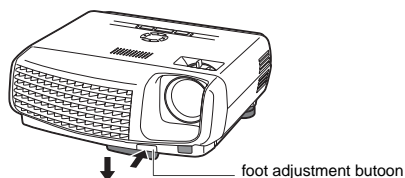

### After using the projector:

4. Put the adjustment feet (front) back into the projector by pressing the foot adjustment buttons.

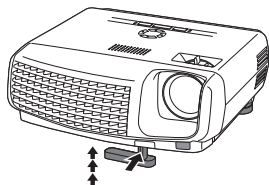

## Using the adjustment feet (rear)

1. Tilt up the projector to the appropriate angle.
2. Press the foot adjustment buttons next to the adjustment feet (rear), and the adjustment feet will come out.
3. Release the buttons to lock the adjustment feet (rear) to that position.
4. Rotate the adjustment feet (rear) for fine adjustment.

### After using the projector:

5. Put the adjustment feet (rear) back into the projector by pressing the foot adjustment buttons.

### Important:

- If necessary, rotate the adjustment feet (front) for fine adjustment.
- Install the screen on a flat wall at 90 degrees to the floor.
- Slanting the projector more than  $\pm 10^\circ$  (right and left) or  $\pm 15^\circ$  (front and rear) may cause trouble or explosion of the lamp. You can tilt the projector up to 7 degrees using the adjustment feet only.
- Images may not be projected in a shape of a regular rectangle or with its aspect ratio 4:3, depending on the installation conditions of the projector and the screen.
- To correct vertical keystone distortion, press the KEYSTONE button on the projector or the remote control to display KEYSTONE, and adjust the image by pressing the  $\blacktriangle$ ,  $\blacktriangledown$  button (or VOLUME +, - button on the remote control).

### In the following cases:



Press the  $\blacktriangledown$  (or -) button.

Press the  $\blacktriangle$  (or +) button.

### Important:

- When the keystone adjustment is carried out, the adjustment value is indicated. Note that this value doesn't mean a projection angle.
- The allowable range of the adjustment value in the keystone adjustment varies depending on the installation conditions.
- When the keystone adjustment takes effect, the resolution decreases. In addition, stripes may appear or straight lines may bend in images with complicated patterns. They are not due to product malfunctions.
- Noise may appear on the screen during the keystone adjustment because of the type of the video signal being projected and the setting values of the keystone adjustment. In such cases, set the keystone adjustment values in the range where the image is displayed without noise.
- When the keystone adjustment is carried out, the image may not be displayed correctly because of the type of input signal.

# Basic operation

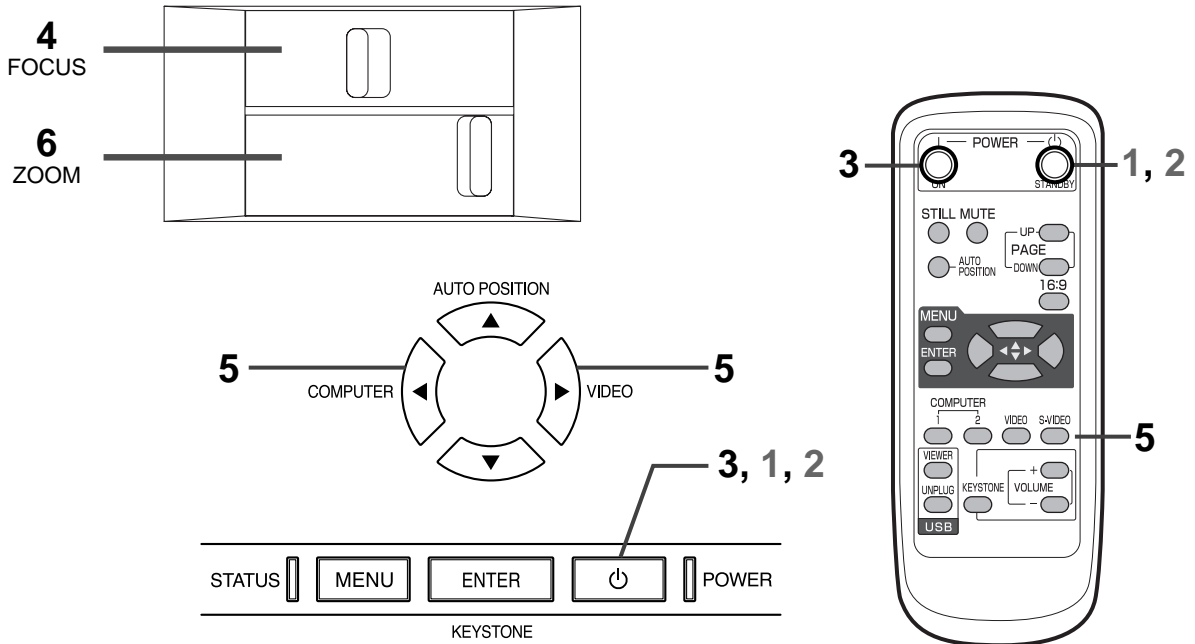

## Power-on

1. Turn on the device connected to the projector first.
2. Plug the power cord in the wall outlet.
  - The POWER indicator lights up.
  - If the power cord is unplugged from the wall outlet before the projector is cooled down completely after use, the fans may start rotating when the power cord is plugged in next time and the POWER button may not function. In this case, wait for the fans to stop and press the POWER button to light the indicator.
3. Press the POWER button on the control panel or the ON button on the remote control.
  - It may take about one minute for the lamp to light up.
  - The lamp occasionally fails to light up. Wait a few minutes and try to light the lamp again.
  - After the POWER button is pressed, the image may flicker before the lamp becomes stable. This is not a product malfunction.
  - Regardless of the setting of LAMP MODE in the INSTALLATION menu, the STANDARD lamp mode is activated by default whenever the projector is turned on. When LAMP MODE has been set to LOW, the lamp mode changes from STANDARD to LOW about one minute after turn-on.
5. Choose your desired external input source using the COMPUTER or VIDEO button.
  - The input source is switched from VIDEO to COMPUTER at the press of the COMPUTER button on the control panel.
  - The input source is switched between VIDEO and S-VIDEO at every press of the VIDEO button on the control panel.
  - The projector automatically selects the appropriate signal format. The selected signal format is displayed on the screen.
  - The COMPUTER and VIDEO buttons don't function while the menu is being displayed.
  - When COMPUTER is chosen as the source, images supplied from the computer may flicker. Press the ◀ or ▶ button on the remote control to reduce flicker, if it occurs.
  - To avoid permanently imprinting a fixed image onto your projector, please do not display the same stationary images for long period.
6. Adjust the image size by turning the zoom ring.
  - If necessary, adjust the focus and zoom again.

Condition	Indicator	STATUS	POWER
Stand-by		-	Red
When the lamp is on.		Green	Green

## Important:

- Do not cover the lens with the lens cap while the lamp is on. Do not strip off the aluminum sheet inside the lens cap.
  - The projector starts warming up when the POWER button is pressed. During the warm-up process, images may appear dark and no commands are accepted.
  - By blinking red, the STATUS indicator indicates that the lamp should be replaced soon. Replace the lamp when the STATUS indicator blinks red. (See page 23 and 26.)
  - Images may not be projected with good quality in an extremely hot or cold environment. (This is not a product malfunction.)
4. Adjust the focus by turning the focus ring.

## Basic operation (continued)

### Power-off

Use the following procedure to turn off the projector.

1. Press the POWER button on the control panel or the OFF button on the remote control.
  - The message "POWER OFF? YES : PRESS AGAIN" appears on the screen.
  - To cancel, press any button except the POWER button. (Some buttons on the remote control don't function for cancel.)
2. Press the POWER button on the control panel or the OFF button on the remote control within 10 seconds again.
  - The lamp will go out and the STATUS indicator will start blinking.
  - Though the lamp goes out at this second press of the POWER button (or OFF button), the air outlet fans continue operating for one minute to cool down the lamp. The STATUS indicator will stop blinking.
  - After stopping the air outlet fans, if the temperature inside the set is still high, the temperature sensor detects it and then the air outlet fans may start again.
3. Unplug the power cord.
  - The POWER indicator will go out.
  - If the power cord should be unplugged accidentally while either the air inlet fan or the air outlet fans are operating or the lamp is on, allow the projector to cool down for 10 minutes with the power off. To light the lamp again, press the POWER button (or OFF button). If the lamp doesn't light up immediately, repeat pressing the POWER button (or OFF button) two or three times. If it should still fail to light up, replace the lamp.

#### Notice:

- When storing the projector in the carrying case, the lens should face up.

### Instant Shut Down

You can turn off this projector just by unplugging the power cord without pressing the POWER button.

- Don't shut down the projector while the STATUS indicator is blinking after the lamp lights up because the lamp's life may be shortened.
- Don't turn the projector back on right after shutting it down because the lamp's life may be shortened. (Wait about 10 minutes before turning the projector back on.)
- Before shutting down the projector, be sure to close the menu screen. If you shut down the projector without closing the menu, the setting data of the menu may not be saved.

### AUTO POSITION button

When the image isn't projected in the right position with COMPUTER selected as the input source, follow the procedure below.

1. Project a bright image such as the "Recycle Bin" window on the full screen.
2. If the screen saver is running, turn it off.
3. Press the AUTO POSITION button.
  - If the image is still not in the right position, adjust the image position using the SIGNAL menu. See page 19.

### Volume from the speaker

Press the VOLUME + or - button to change the volume from the speaker.

The volume control bar will appear on the screen.

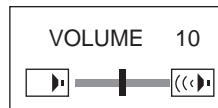

- The volume control bar will disappear about 10 seconds after the VOLUME button is released.
- The VOLUME buttons don't function while the menu selection bar or the menu is being displayed.
- When a high-level audio signal, such as a DVD audio signal, is supplied to the AUDIO IN terminal, the output from the speaker may be distorted.

### AV mute

The video and audio signals are temporarily muted when the MUTE button is pressed. To cancel muting, press the MUTE button again.

### ANAMORPHIC mode

When playing DVD discs containing data of letterboxed image, press the 16:9 button. Exit the ANAMORPHIC mode, by pressing the 16:9 button again.

#### Important:

- When a letterboxed image is kept displayed for a long time before displaying 4:3 image, the afterimages of the black bars may appear on the 4:3 image screen. Consult your dealer in this case.

#### Caution:

- After using the projector, wait one minute for the air outlet fans to stop. Then unplug the power cord from the wall outlet.
- The lamp can't be lit again for one minute after turned off for safety purpose. It will take another one minute for the STATUS indicator to go out. If you want to turn on the projector again, wait until the indicator goes out, and then press the POWER button.
- The air outlet fans rotate faster as the temperature around the projector rises.
- When the temperature around the projector rises high, the sign "TEMPERATURE!!" blinks red on the screen. If the temperature stays high, the lamp will go out automatically.

#### Important:

- Do not display a still picture for a long time because the afterimages may persist on the screen.

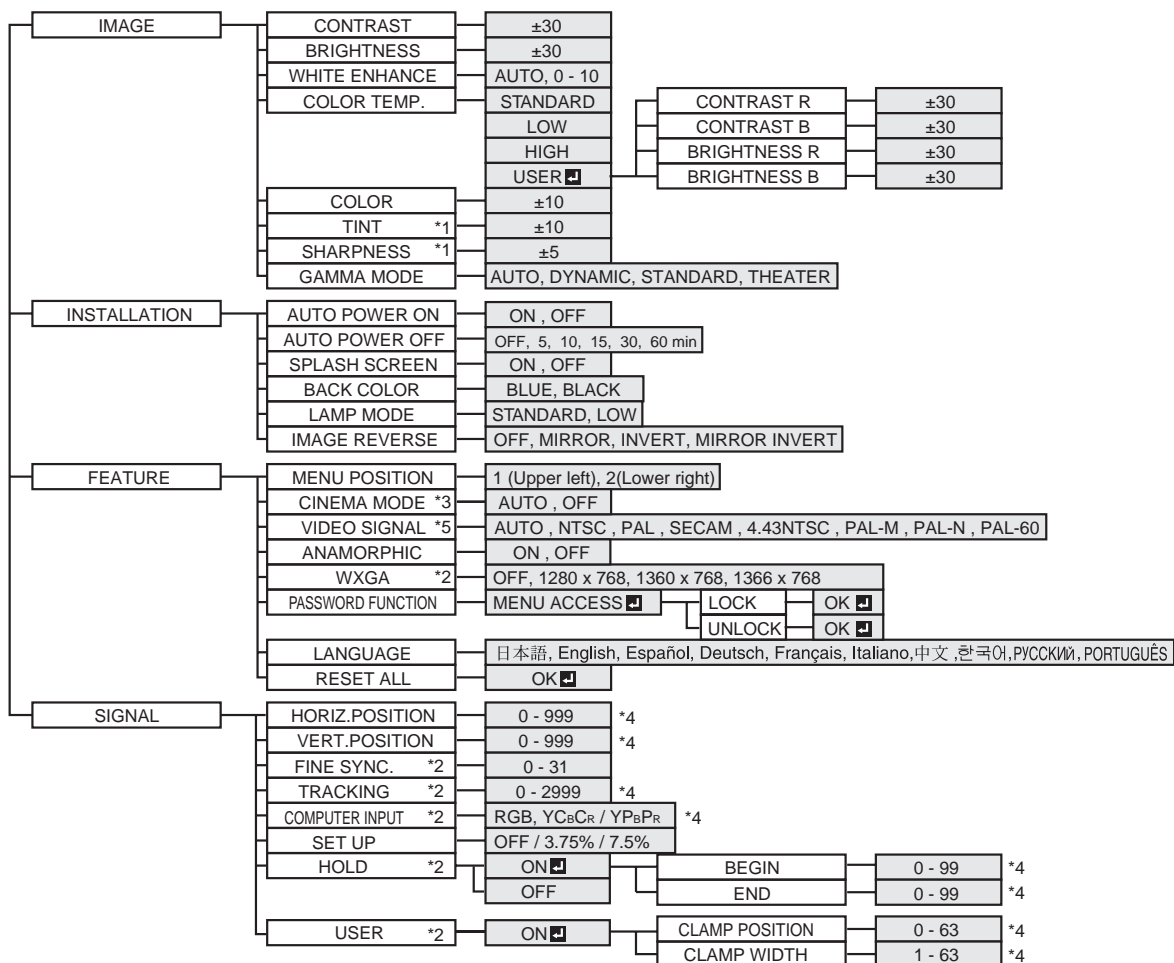

- \* 1: Not available with certain signals.
- \* 2: Not available when the source is a VIDEO or S-VIDEO signal.
- \* 3: Available only when the input signal is TV60, 480i.
- \* 4: Setting range differs depending on the input signals.
- \* 5: Available only when the source is a VIDEO or S-VIDEO signal.

## Basic operation

Several settings can be adjusted using the menu. OFF.

Example : Auto power off time setting

1. Press the MENU button.



2. Press the ◀ or ▶ button to select INSTALLATION.



3. Press the ENTER button (or ▼ button).

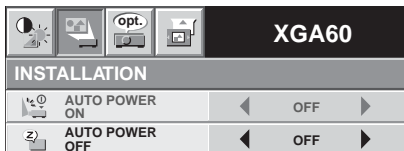

4. Press the ▲ or ▼ button to select AUTO POWER OFF.



5. Press the ◀ or ▶ button to adjust the auto power off time.



6. Exit the menu by pressing the MENU button several times.

### Important:

- When the button doesn't function, unplug the power cord from the wall outlet. Wait about 10 minutes, plug the power cord in, and try again.
- After selecting the items marked with , press the ENTER button.

# Menu operation (continued)

## 1 IMAGE

CONTRAST .....	Use to adjust the image contrast. The contrast becomes higher as the value increases.
BRIGHTNESS .....	Use to adjust the image brightness. The image becomes brighter as the value increases.
WHITE ENHANCE .....	Use to adjust the white level of the projected image. Select AUTO for normal use.
COLOR TEMP. ....	Use to adjust the color temperature. See page 18.
COLOR .....	Use to adjust the color intensity of the image.
TINT .....	Use to adjust the color balance of the image. The color balance shifts to green as the value increases and shifts to purple as the value decreases. (Available only when VIDEO or S-VIDEO is chosen as the source.) <ul style="list-style-type: none"> <li>When the TV50 (PAL, SECAM) signal is input, TINT can't be adjusted.</li> </ul>
SHARPNESS .....	Use to adjust the image sharpness. The image becomes sharp as the value increases. (Not available with certain signals.)
GAMMA MODE .....	When AUTO is selected, the appropriate gamma mode is automatically selected depending on the input signal. For normal use, select AUTO. Select DYNAMIC for computer sources. Select STANDARD for sport scenes and video sources. Select THEATER for film sources.

XGA60		
IMAGE		
CONTRAST	◀ 0 ▶	
BRIGHTNESS	◀ 0 ▶	
WHITE ENHANCE	◀ AUTO ▶	
COLOR TEMP.	◀ STANDARD ▶	
COLOR	◀ 0 ▶	
TINT	◀ 0 ▶	
SHARPNESS	◀ 0 ▶	
GAMMA MODE	◀ AUTO ▶	



## 2 INSTALLATION









AUTO POWER ON .....	When ON is chosen, the lamp is automatically lit when the power cord is plugged in the wall outlet. Choose ON when using the projector mounted on the ceiling. <ul style="list-style-type: none"> <li>The projector is in the stand-by mode when the lamp is off. Use the remote control to turn on the lamp.</li> </ul>
AUTO POWER OFF .....	Use to set the time elapsed before the projector enters the stand-by mode when there is no signal input from the source.
SPLASH SCREEN .....	Choose ON to display the splash screen when the power is turned on.
BACK COLOR .....	Use to select the background from among BLUE and BLACK, which will be displayed when there is no signal input from the source.
LAMP MODE .....	Use to change the brightness of the lamp. When LOW is chosen, the lamp brightness is kept low and the projector operating noise is reduced, resulting in a longer lamp replacement interval. <ul style="list-style-type: none"> <li>When the lamp mode is switched, the projected image may flicker. This is not a product malfunction.</li> <li>Do not change the setting of LAMP MODE frequently.</li> <li>When LAMP MODE has been set to LOW, the lamp mode changes from STANDARD to LOW about one minute after turn-on.</li> </ul>
IMAGE REVERSE .....	Use to reverse the projected image. Select MIRROR for rear projection with the tabletop-mounted projector. Select MIRROR INVERT for front projection with the ceiling-mounted projector.

XGA60		
INSTALLATION		
AUTO POWER ON	◀ OFF ▶	
AUTO POWER OFF	◀ OFF ▶	
SPLASH SCREEN	◀ ON ▶	
BACK COLOR	◀ BLUE ▶	
LAMP MODE	◀ STANDARD ▶	
IMAGE REVERSE	◀ OFF ▶	



### 3 FEATURE

- MENU POSITION ..... Use to select the position of the menu on the screen, 1.  (upper left) or 2.  (lower right).
- CINEMA MODE ..... When AUTO is selected, the film mode will be automatically activated when a film source signal is inputted. When OFF is selected, the film mode will not be activated.
- VIDEO SIGNAL..... When AUTO is selected, the appropriate video format is automatically selected depending on the input signal. If the image isn't displayed correctly, select the desired video format manually.
- ANAMORPHIC..... Select ON when playing DVD discs containing data of widescreen images.
- WXGA ..... See "Specifications" for details of the signal types that you can project correctly.  
Select OFF when the signal is 1280 x 800. (note ; Factory Preset is "OFF")  
Select the image size corresponding to the input signal when the input signal is 1280x768, 1360x768, or 1366x768

XGA60	
FEATURE	
 MENU POSITION	◀ 1.  ▶
 CINEMA MODE	◀ AUTO ▶
 VIDEO SIGNAL	◀ AUTO ▶
 ANAMORPHIC	◀ OFF ▶
 WXGA	◀ OFF ▶
 PASSWORD FUNCTION	MENU ACCESS <input type="checkbox"/>
 LANGUAGE	◀ English ▶
 RESET ALL	OK <input type="checkbox"/>







NOTE:

- Make sure the image size of the input signal from "Display Property" of your computer.
- It takes approx. 8 to 10 seconds to change the settings. You cannot change the settings during that time.

- PASSWORD FUNCTION ..... Use to change the mode of the password lock or to enable or cancel the password lock. See page 21 for details.
- LANGUAGE ..... Use to select the language used in the menu. (日本語 / English / Español / Deutsch / Français / Italiano / 中文 / 한국어 / РУССКИЙ / PORTUGUÊS).
- RESET ALL..... Use to reset the menu settings (except PASSWORD FUNCTION, and LANGUAGE ).
  - CINEMA MODE can be adjusted only when a TV50, TV60, 480i, 576i signal is being displayed.
  - When VIDEO SIGNAL is set to AUTO, the image may not be projected with correct colors. Change the setting of VIDEO SIGNAL depending on the input signal in such cases.



### 4 SIGNAL

- HORIZ. POSITION..... Use to adjust the horizontal position of the image.
- VERT. POSITION..... Use to adjust the vertical position of the image.
- FINE SYNC. .... Use to synchronize the projector with the PC input signal so that the image is not blurred.
- TRACKING..... Use to eliminate image noise such as wide stripes.
- COMPUTER INPUT ..... The projector adjusts its settings automatically when connected to a DVD player equipped with a component video output (Y, C<sub>B</sub>, C<sub>R</sub>). When the projector is connected with a device having an RGB terminal, choose RGB manually.
- SET UP ..... When OFF is selected, the black area becomes make lighter. When 3.75% or 7.5% is selected, the black area becomes thicker.
- HOLD ..... Use to adjust the image when flagging occurs near the top of the screen.

XGA60	
SIGNAL	
 HORIZ. POSITION	◀ 0 ▶
 VERT. POSITION	◀ 0 ▶
 FINE SYNC.	◀ 0 ▶
 TRACKING	◀ 0 ▶
 COMPUTER INPUT	◀ RGB ▶
 SET UP	◀ 7.5% ▶
 HOLD	◀ ON <input type="checkbox"/> ▶
USER	OK <input type="checkbox"/>

### 5 SIGNAL - USER (No need to adjust in normal use.)

- CLAMP POSITION/  
CLAMP WIDTH..... Use to correct solid white or solid black in the projected image.

USER	
 CLAMP POSITION	◀ 0 ▶
 CLAMP WIDTH	◀ 1 ▶

**Important:**

- You can set the IMAGE, SIGNAL, and SIGNAL-USER menus only when the signal is supplied.

# Image adjustment

## Image adjustment

You can adjust the image using the IMAGE menu.

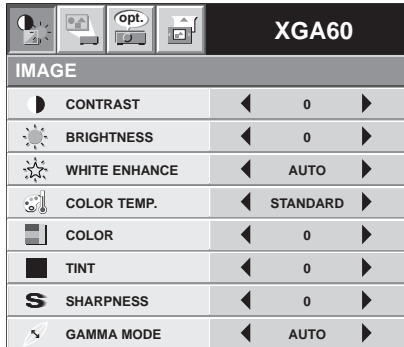

### To control the white-to-black level of the image :

Adjust CONTRAST in the IMAGE menu. Press the ▶ button to increase the contrast and the ◀ button to reduce it.

### To control the light level of the image :

Adjust BRIGHTNESS in the IMAGE menu. Press the ▶ button to lighten the image and the ◀ button to darken it.

### To determine the intensity of the color :

Adjust COLOR in the IMAGE menu. Press the ▶ button to increase the amount of color in the image and the ◀ button to decrease it.

### To adjust the red-green color balance of the image :

Adjust TINT in the IMAGE menu. Press the ▶ button to increase the amount of green in the image and the ◀ button to increase the amount of red in the image.

### To adjust the detail and clarity of the image :

Adjust SHARPNESS in the IMAGE menu. Press the ▶ button to sharpen the image and the ◀ button to soften the image.

## Color temperature

1. Select COLOR TEMP. in the IMAGE menu.
2. Press the ◀ or ▶ button to select USER .
3. Press the ENTER button.

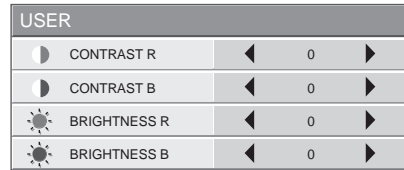

4. Press the ▲ or ▼ button to select the desired item.
5. Press the ◀ or ▶ button to adjust the selected item.
6. Repeat steps 4 and 5 for optimum adjustment results.
7. Exit the menu by pressing the MENU button several times.

### About color temperature

There are different kinds of white color. Color temperature is a way to show the differences in white.

White of which temperature is low appears reddish.

When the color temperature rises, white appears bluish. This projector adjusts this color temperature by changing the values of contrast blue and red.

To rise the color temperature:

Increase the CONTRAST B (blue) and decrease the CONTRAST R (red).

To reduce the color temperature:

Decrease the CONTRAST B (blue) and increase the CONTRAST R (red).

## Adjustment of the image from the computer

This projector adjusts the format of the video signal supplied from the computer. However, sometimes images are not projected correctly owing to the type of the computer used. When the image from the computer isn't projected correctly, press the AUTO POSITION button. (See page 14.) If the image isn't projected correctly yet, adjust the image from the computer using the menu.

XGA60		
<b>SIGNAL</b>		
HORIZ. POSITION	◀ 0 ▶	
VERT. POSITION	◀ 0 ▶	
FINE SYNC.	◀ 0 ▶	
TRACKING	◀ 0 ▶	
COMPUTER INPUT	◀ RGB ▶	
SET UP	◀ 7.5% ▶	
HOLD	◀ ON <input checked="" type="checkbox"/> ▶	
USER	OK <input checked="" type="checkbox"/>	

### To move the image horizontally :

Adjust HORIZ. POSITION in the SIGNAL menu. Press the ▶ button to move the image to the left. Press the ◀ button to move the image to the right.

### To move the image vertically :

Adjust VERT. POSITION in the SIGNAL menu. Press the ▶ button to move the image upward. Press the ◀ button to move the image downward.

### When the image flickers or the image is out of focus :

Adjust FINE SYNC. in the SIGNAL menu.

### When the top part of the image flags :

Change the setting of HOLD in the SIGNAL menu. Select ON , press the ENTER button, and adjust BEGIN or END to minimize the flagging.

USER		
CLAMP POSITION	◀ 0 ▶	
CLAMP WIDTH	◀ 1 ▶	

### When wide strips appear :

Adjust CLAMP POSITION or CLAMP WIDTH in the SIGNAL - USER menu.

### Important:

Do not change any of the settings in the SIGNAL-USER menu for normal use.

## Simple adjustment method

1. Select HORIZ. POSITION in the SIGNAL menu.
2. Press the ◀ or ▶ button to adjust the horizontal start position (or the left side of the image).
3. Select TRACKING in the SIGNAL menu.
4. Press the ◀ or ▶ button to adjust the horizontal end position (or the right edge of the image).
5. Repeat steps 1 to 4 for optimum adjustment results.
6. Select VERT. POSITION in the SIGNAL menu.
7. Press the ◀ or ▶ button to adjust the vertical start position (or the upper edge of the image).

# Advanced feature

---

## Still

To stop the motion in the image temporarily (or to display a still image):

Press the STILL button on the remote control.

- The image will freeze temporarily.

## To resume the motion in the image:

Press the STILL button on the remote control again.

## Important:

- Do not display a still picture for a long time because the afterimages may persist on the screen.

## Page-up and page-down

You can control the computer to page-up and page-down the presentation data using the remote control. Switch the pages using the PAGE UP or DOWN button on the remote control.

## Connection

To control the computer using the remote control, connect the projector with the computer as shown below.

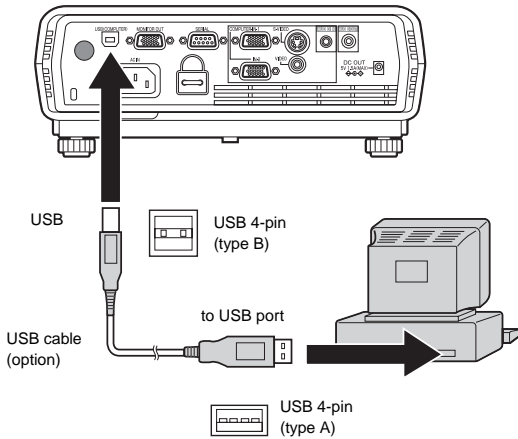

- When it is connected via USB, the "Page up/down" function works on the computer which supports USB connection as a standard function. (But this function may not work via USB connection on any computer.)
- Wait for the lamp to light up before connecting the USB cable.

## Password function

This projector is equipped with the password function that is designed for prevention of wrong operation by children and restriction on operation by other than specified users.

**MENU ACCESS** ..... All the buttons except for the POWER button on the projector are disabled. (The buttons on the remote control are enabled.) You can use this mode as a measure of prevention of wrong operation by children and restriction on operation by other than specified users.

### To enable the password function:

1. Display the FEATURE menu.
2. Press the ▲ or ▼ button to select PASSWORD FUNCTION.
3. Press the ENTER button.
  - The screen for setting the password function will appear.



- When the password has already been set, the mode won't be changed. In such cases, press the ENTER button to cancel the password function and try again.
4. Press the ENTER button.
    - The screen for entering a password will appear.

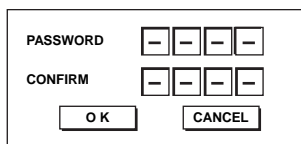

5. Press the ▲ or ▼ button to select a number from 0 to 9.
6. Press the ► button.
  - You can set the next digit.
7. Repeat steps 5 and 6 to set a four-digit password.
8. Enter the password again for confirmation using the same steps.
9. Select OK, and press the ENTER button.
  - If the entered passwords don't match, an error message will appear.
  - To cancel the procedure, select CANCEL, and press the ENTER button.
  - You can cancel the procedure by pressing the MENU button alternatively.

### To cancel the password function:

1. Display the FEATURE menu.
2. Press the ▲ or ▼ button to select PASSWORD FUNCTION.
3. Press the ENTER button.
  - The screen for canceling the password function will appear.

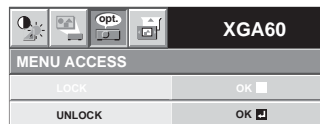

4. Press the ENTER button.
  - The screen for entering the password will appear.

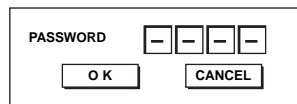

5. Press the ▲ or ▼ button to select a number from 0. to 9.
6. Press the ► button.
  - You can set the next digit.
7. Repeat steps 5 and 6 to enter the four-digit password.
8. Press the ► button, select OK, and press the ENTER button.
  - If you enter a wrong password, an error message will appear.
  - To cancel the procedure, press the ► button, select CANCEL, and press the ENTER button.
  - You can cancel the procedure by pressing the MENU button alternatively.

### Important:

- If you forget your password, keep pressing the MENU and ENTER buttons on the control panel at the same time to cancel the password function.

# Lamp replacement

This projector is equipped with a lamp to project images. This lamp is a consumable. It may burn out or its brightness may decrease during use. In such cases, replace the lamp with a new one as soon as possible. Be sure to replace the lamp with a new lamp separately sold that is exclusive to this projector. Contact your dealer for purchase of the lamp.

Spare lamp for XD470U/XD470U-G: VLT-XD470LP

## Caution:

- Do not remove the lamp immediately after using the projector. You may get burned because the lamp very hot after use.
- Before replacing the lamp, press the POWER button to turn off the lamp and wait for two minutes for lamp to cool down. Unplug the power cord from wall outlet and wait one hour for the lamp to cool down completely.
- Do not remove the lamp except for replacement. Careless handling can cause injury or fire.
- Do not touch the lamp directly. It may break and cause injury or burn.
- Be sure not to drop the lamp lid screw into the projector. Also be sure not to put metal or any flammable objects inside because it may cause fire or electric shock. If any objects should fall inside, unplug and contact your dealer.
- Install the lamp securely to prevent failure and fire.
- If the lamp should break, small glass fragments may fall out through the grilles and some may remain inside of the projector or the lamp box. When taking the lamp box out, be sure to turn over the projector and hold the handle of the lamp box to avoid injury due to the glass fragments.
- If the lamp should break, never shake the lamp box or hold it in front of your face after removing it. The glass fragments may fall out and cause injury to your eyes.
- When placing the projector upside down to replace the lamp or conduct maintenance, ensure that the projector is securely placed before working with it.

1. Reverse the projector gently.
2. Loosen the screws (a) using a Phillips screwdriver (+), and remove the lamp cover (b).
3. Loosen the screws (c) using a Phillips screwdriver (+).
4. Pull up the handle.
5. Pull out the lamp box by the handle while holding the projector.
  - Pull the lamp box out of the projector slowly. If it is pulled out quickly, the lamp may break scattering glass fragments.
  - Do not spill liquid on the removed lamp box or do not place it near any flammable object or where children can reach to prevent injury or fire.
6. Load a new lamp box securely into the projector in the right orientation.
7. Put the handle back to the original position.
  - Make sure that the handle is locked.
8. Tighten up the screws (c) using a Phillips screwdriver (+).

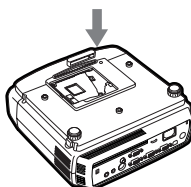
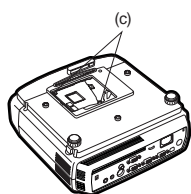
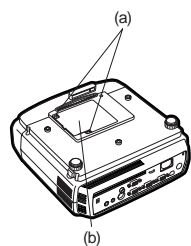

9. Tighten up the screw (a) using a Phillips screwdriver (+) to secure the lamp cover.

## Reset of the lamp operation time

Plug in the power cord, and reset the lamp operation time by keep pressing the ◀, ▶, and POWER buttons on the control panel at the same time.

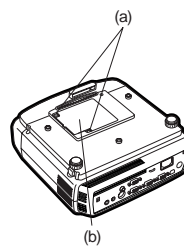

## Important:

- Unless these three buttons are pressed at the same time, the lamp operation time isn't reset.
- Make sure that the STATUS indicator is lit twice and the lamp operation time is reset successfully.
- The projector doesn't turn on if the lamp cover isn't attached securely.
- Be sure to reset the lamp operation time whenever you replace the lamp.
- Do not reset the lamp operation time unless you replace the lamp.

## Caution:

- The lamp is fragile. If it is broken, be careful not to cut yourself with glass fragments.
- Contact your dealer for a new lamp.

## Interval of lamp replacement

When the lamp shutdown notice is issued, the lamp replacement is recommended even if the lamp is lit normally. Decrease in luminescence and/or color brightness indicates that the lamp needs to be replaced. When the lamp operation time exceeds the time elapsed until the lamp shutdown notice<sup>\*1</sup> is issued, the indicator will blink alternately green and red while the lamp is lit (while the lamp is not lit, the indicator will blink red only) and the lamp replacement message will appear on the screen for one minute every time the lamp is turned on. When the lamp operation time exceeds the time elapsed until the lamp shutdown warning<sup>\*2</sup> is issued, the replacement message (LAMP EXCHANGE) will appear on the screen for one minute at fixed intervals<sup>\*4</sup> thereafter.

**When the lamp operation time exceeds the time elapsed until the lamp shutdown<sup>\*3</sup>, the projector automatically shuts off and can't be used until the lamp is replaced and the lamp operation time is reset.**

XD470U/XD470U-G	
<sup>*1</sup>	2250 Hours
<sup>*2</sup>	2850 Hours
<sup>*3</sup>	3000 Hours <sup>*5</sup>

The times above are when LAMP MODE of the INSTALLATION menu is set to LOW. When it is set to STANDARD, this duration will be shortened.

<sup>\*4</sup> These intervals vary depending on the lamp mode setting.

<sup>\*5</sup> When LAMP MODE is set to STANDARD, the time elapsed until the lamp shutdown will be shortened to 2000 hours.

























## Caution:

- This projector uses a lamp that contains mercury. Disposal of the lamp or the projector with the lamp may be regulated due to environmental considerations. For disposal or recycling information, please contact your local authorities or the Electronic Industries Alliance: [www.eiae.org](http://www.eiae.org). (For US only).

# Troubleshooting

The following offers solutions to some of the common problems you may encounter. We suggest that you consult this chart before contacting your dealer.

## Images aren't projected on the screen.

Problem	Cause and solution																				
<p>Power isn't turned on.</p>	<ul style="list-style-type: none"> <li>Check the states of the indicators.</li> </ul> <table border="1" data-bbox="536 316 1295 877"> <thead> <tr> <th>POWER</th> <th>STATUS</th> <th>Solution</th> </tr> </thead> <tbody> <tr> <td> Off</td> <td> Off</td> <td> <ul style="list-style-type: none"> <li>Connect the power cord to the projector.</li> <li>Plug the power cord into a wall outlet.</li> </ul> </td> </tr> <tr> <td rowspan="3"> Steady red</td> <td> Off</td> <td> <ul style="list-style-type: none"> <li>If any objects are blocking the air inlet or outlet grille, remove them and carry out the following.                             <ol style="list-style-type: none"> <li>Unplug the power cord from the wall outlet.</li> <li>Make sure that the projector has cooled off.</li> <li>Plug the power cord into the wall outlet.</li> <li>Press the POWER button.</li> </ol> </li> </ul> </td> </tr> <tr> <td> Blinking orange</td> <td> <ul style="list-style-type: none"> <li>If any objects are blocking the air inlet or outlet grille, remove them.</li> <li>Don't expose the air outlet grilles to hot air emitted from a heating appliance.</li> </ul> </td> </tr> <tr> <td> Blinking green</td> <td> <ul style="list-style-type: none"> <li>After the STATUS indicator stops blinking, press the POWER button.                             <ul style="list-style-type: none"> <li>If you unplug the power cord while the fan is rotating, the lamp may not turn on about one minute when you plug the power cord next time.</li> <li>The lamp can't turn on again for one minute after it goes out.</li> </ul> </li> <li>Press the POWER button several times.</li> </ul> </td> </tr> <tr> <td rowspan="2"> Blinking red / green</td> <td> Steady red</td> <td> <ul style="list-style-type: none"> <li>Replace the lamp. (The lamp is at the end of its life.)</li> </ul> </td> </tr> <tr> <td> Off</td> <td> <ul style="list-style-type: none"> <li>Attach the lamp cover on the bottom.</li> </ul> </td> </tr> <tr> <td></td> <td> <ul style="list-style-type: none"> <li>Unplug the power cord from the wall outlet and contact your dealer.</li> </ul> </td> </tr> </tbody> </table>	POWER	STATUS	Solution	 Off	 Off	<ul style="list-style-type: none"> <li>Connect the power cord to the projector.</li> <li>Plug the power cord into a wall outlet.</li> </ul>	 Steady red	 Off	<ul style="list-style-type: none"> <li>If any objects are blocking the air inlet or outlet grille, remove them and carry out the following.                             <ol style="list-style-type: none"> <li>Unplug the power cord from the wall outlet.</li> <li>Make sure that the projector has cooled off.</li> <li>Plug the power cord into the wall outlet.</li> <li>Press the POWER button.</li> </ol> </li> </ul>	 Blinking orange	<ul style="list-style-type: none"> <li>If any objects are blocking the air inlet or outlet grille, remove them.</li> <li>Don't expose the air outlet grilles to hot air emitted from a heating appliance.</li> </ul>	 Blinking green	<ul style="list-style-type: none"> <li>After the STATUS indicator stops blinking, press the POWER button.                             <ul style="list-style-type: none"> <li>If you unplug the power cord while the fan is rotating, the lamp may not turn on about one minute when you plug the power cord next time.</li> <li>The lamp can't turn on again for one minute after it goes out.</li> </ul> </li> <li>Press the POWER button several times.</li> </ul>	 Blinking red / green	 Steady red	<ul style="list-style-type: none"> <li>Replace the lamp. (The lamp is at the end of its life.)</li> </ul>	 Off	<ul style="list-style-type: none"> <li>Attach the lamp cover on the bottom.</li> </ul>		<ul style="list-style-type: none"> <li>Unplug the power cord from the wall outlet and contact your dealer.</li> </ul>
POWER	STATUS	Solution																			
 Off	 Off	<ul style="list-style-type: none"> <li>Connect the power cord to the projector.</li> <li>Plug the power cord into a wall outlet.</li> </ul>																			
 Steady red	 Off	<ul style="list-style-type: none"> <li>If any objects are blocking the air inlet or outlet grille, remove them and carry out the following.                             <ol style="list-style-type: none"> <li>Unplug the power cord from the wall outlet.</li> <li>Make sure that the projector has cooled off.</li> <li>Plug the power cord into the wall outlet.</li> <li>Press the POWER button.</li> </ol> </li> </ul>																			
	 Blinking orange	<ul style="list-style-type: none"> <li>If any objects are blocking the air inlet or outlet grille, remove them.</li> <li>Don't expose the air outlet grilles to hot air emitted from a heating appliance.</li> </ul>																			
	 Blinking green	<ul style="list-style-type: none"> <li>After the STATUS indicator stops blinking, press the POWER button.                             <ul style="list-style-type: none"> <li>If you unplug the power cord while the fan is rotating, the lamp may not turn on about one minute when you plug the power cord next time.</li> <li>The lamp can't turn on again for one minute after it goes out.</li> </ul> </li> <li>Press the POWER button several times.</li> </ul>																			
 Blinking red / green	 Steady red	<ul style="list-style-type: none"> <li>Replace the lamp. (The lamp is at the end of its life.)</li> </ul>																			
	 Off	<ul style="list-style-type: none"> <li>Attach the lamp cover on the bottom.</li> </ul>																			
	<ul style="list-style-type: none"> <li>Unplug the power cord from the wall outlet and contact your dealer.</li> </ul>																				
<p>Images aren't projected on the screen.</p>	<ul style="list-style-type: none"> <li>Cancel the AV mute by pressing the MUTE button.</li> <li>Remove the lens cap.</li> <li>The lamp sometimes takes about one minute to light up.</li> <li>On rare occasion, the lamp fails to light up. In such cases, wait a few minutes and try to light the lamp again.</li> <li>If the projector was turned off before the lamp cooled down completely, the fans may start rotating and the POWER button may not function when you plug the power cord into the wall outlet next time. Wait for the fans to stop and press the POWER button to turn on the lamp again.</li> <li>Check that the lamp cover are closed.</li> <li>Check that the cable connected to the external device isn't broken.</li> <li>When an extension cord is being used, replace it with the supplied cable and check whether images are projected correctly. If images are projected correctly, use an RGB signal amplifier along with the extension cord.</li> </ul>																				
<p>Images suddenly disappear.</p>	<ul style="list-style-type: none"> <li>The air inlet or outlet grille may be blocked. (In such cases, the STATUS indicator blinks orange.) → Remove the objects blocking the air inlet or outlet grille and carry out the following.             <ol style="list-style-type: none"> <li>Wait for the air inlet or outlet fan to stop (or wait for the STATUS indicator to go out.)</li> <li>Unplug the power cord from the wall outlet.</li> <li>Wait about 10 minutes.</li> <li>Plug the power cord into the wall outlet.</li> <li>Press the POWER button.</li> </ol> </li> <li>When the STATUS indicator is blinking red, it is indicating that the lamp should be replaced. Replace the lamp in this case.</li> <li>Check that AUTO POWER OFF has been set to OFF.</li> <li>If the lamp has deteriorated, it may go out after a while it illuminates.</li> </ul>																				
<p>"NO SIGNAL" is displayed.</p>	<ul style="list-style-type: none"> <li>Turn on the power of the connected device, or check whether there is something wrong with the connected device.</li> <li>Check whether the external device outputs signals. (Check this especially when the external device is a notebook computer.)</li> <li>Check that the cable connected to the external device isn't defective.</li> <li>Check that the projector is connected to the external device using the correct terminals.</li> <li>Check that the connected device is correctly selected as the input source.</li> <li>When an extension cord is being used, replace it with the supplied cable and check whether images are projected correctly. If images are projected correctly, use an RGB signal amplifier along with the extension cord.</li> </ul>																				

## Troubleshooting (continued)

### Images aren't projected correctly.

Problem	Cause and solution
Projected images are shaking. Projected images are displaced.	<ul style="list-style-type: none"> <li>• Check that the cable connected to the external device isn't intermittent.</li> <li>• Connect the cable's plug with the external device's connector firmly.</li> <li>• Press the AUTO POSITION button.</li> <li>• Some computers output out-of-spec signals on rare occasion. Adjust the SIGNAL menu. (See page 19.)</li> </ul>
Projected images are distorted.	<ul style="list-style-type: none"> <li>• Adjust the projector and the screen so that they are perpendicular to each other. (See page 12.)</li> </ul>
Projected images are dark.	<ul style="list-style-type: none"> <li>• Adjust BRIGHTNESS in the IMAGE menu. (See page 18.)</li> <li>• Replace the lamp. (See page 22.)</li> <li>• Remove the lens cap.</li> </ul>
Projected images are blurred.	<ul style="list-style-type: none"> <li>• Adjust the focus. (See page 13.)</li> <li>• Clean the lens.</li> <li>• Remove the lens cap.</li> <li>• Press the ◀ or ▶ button on the remote control to eliminate flicker.</li> <li>• Adjust BRIGHTNESS and CONTRAST in the IMAGE menu. (See page 18.)</li> <li>• Adjust the projector and the screen so that they are perpendicular to each other. (See page 12.)</li> </ul>
White dots are seen on projected images. Black dots are seen on projected images.	<ul style="list-style-type: none"> <li>• This symptom is normal for a DLP projector and is not a malfunction. (A very small number of pixels may stay lit or out, but such symptom is not a malfunction. Pixels of 99.99% or more are effective.)</li> </ul>
Rainbow blur appears in projected images.	<ul style="list-style-type: none"> <li>• This is due to color breaking noise that occurs in a DLP system and is not a malfunction.</li> </ul>
Fine streak pattern appears in projected images.	<ul style="list-style-type: none"> <li>• It occurs because of interference with the screen and isn't a product malfunction. Change the screen or readjust the focus of the projector.</li> </ul>
Projected images (and/or audio) appear wavy and distorted.	<ul style="list-style-type: none"> <li>• Connect the cable's plug with the external device's connector firmly.</li> <li>• Keep the projector away from equipment generating interfering radio waves.</li> <li>• When the keystone adjustment is carried out, the image may not be displayed correctly because of the type of input signal. This isn't a product malfunction. In this case, readjust the keystone so that the amount of keystone correction is as small as possible.</li> </ul>
Tint in projected images is incorrect.	<ul style="list-style-type: none"> <li>• Check that COMPUTER INPUT in the SIGNAL menu is correctly set. (See page 17.)</li> <li>• Check that the cable connected to the external device isn't broken.</li> </ul>
Different color tint.	<ul style="list-style-type: none"> <li>• When comparing images projected by two projectors, tints in the displayed images may be different because of variation between their optical components. This is not a malfunction.</li> <li>• When comparing the image projected by this projector with those displayed on the television or PC monitor, tints in the displayed images may be different because of difference in the range of color reproducibility. This is not a malfunction.</li> </ul>
Only the motion areas in the images supplied from the computer aren't displayed.	<ul style="list-style-type: none"> <li>• This is caused by the computer being used. Contact the manufacturer of your computer.</li> </ul>
Projected images are obscured.	<ul style="list-style-type: none"> <li>• Match the output resolution of your computer with the resolution of the projector. For the method to change the output resolution of the computer, contact the manufacturer of your computer. (See page 29.)</li> <li>• Some images and texts appear obscured during the keystone adjustment. In such cases, use the projector without applying the keystone adjustment. (See page 12.)</li> </ul>



## Others

Problem	Cause and solution
Hot air is emitted from the air outlet grilles.	<ul style="list-style-type: none"> <li>This air comes out as a result of cooling the inside of the projector. This isn't a product malfunction.</li> </ul>
No audio is output.	<ul style="list-style-type: none"> <li>Check that the volume isn't set to low.</li> </ul>
The menu can't be used.	<ul style="list-style-type: none"> <li>The microcomputers inside the projector may be wrongly operating because of noise.               <ul style="list-style-type: none"> <li>→ Press the POWER button to turn off the lamp and unplug the power cord from the wall outlet. Wait about 10 minutes, plug the power cord in, and try again.</li> </ul> </li> </ul>
"TEMPERATURE!!" is displayed.	<ul style="list-style-type: none"> <li>This indication appears when the ambient temperature rises high. When the ambient temperature stays high, the lamp goes out.               <ul style="list-style-type: none"> <li>→ Eliminate any causes of the rise in the ambient temperature.</li> </ul> </li> <li>This indication appears when the air inlet or outlet grille is blocked. When they are kept blocked, the lamp goes out.               <ul style="list-style-type: none"> <li>→ Remove the objects blocking the air inlet or outlet grille.</li> </ul> </li> </ul>
The  mark appears.	<ul style="list-style-type: none"> <li>This mark appears when ineffective operation is carried out. This isn't a product malfunction.</li> </ul>
The remote control doesn't function easily or at all.	<ul style="list-style-type: none"> <li>Check that the battery is loaded in the remote control or the battery isn't weak. (See page 8.)</li> <li>Check that the remote control sensor isn't exposed to direct sunlight or fluorescent light. (See page 8.)</li> <li>Use the remote control within its operation range. (See page 8.)</li> <li>Use the remote control at least 10 cm away from the projector.</li> </ul>
The buttons on the control panel (except for the POWER button) don't function.	<ul style="list-style-type: none"> <li>The password function is working.               <ul style="list-style-type: none"> <li>→ Cancel the password lock. (See page 21.)</li> </ul> </li> </ul>
Abnormal sound is heard.	<ul style="list-style-type: none"> <li>Because the color wheel spins at a high speed, metallic sounds may be heard in rare occasions. Such symptom is not a malfunction.</li> </ul>

### When the problems below occur after the lamp is replaced, check the following.

Problem	Cause and solution
The power isn't turned on.	<ul style="list-style-type: none"> <li>Attach the lamp cover on the bottom correctly.</li> <li>Reset the lamp operation time. (See page 22.)</li> </ul>
The STATUS indicator blinks.	<ul style="list-style-type: none"> <li>Reset the lamp operation time. (See page 22.)</li> </ul>

## Maintenance

### Warning:

Do not use flammable solvents (benzene, thinner, etc.) and flammable aerosols when cleaning the projector body and lens. Flammable substances may ignite causing fire or breakdown while the lamp is illuminating.

### Caution:

Be sure to turn off the lamp and unplug the power cord from the wall outlet before you perform any maintenance on the projector.

### Cleaning of the projector and the ventilation slots

Use a soft cloth to clean the projector and the ventilation grilles. When the grilles become dirty, wipe them with a soft cloth dampened with diluted mild detergent, and then wipe them with a dry cloth.

### To protect the surface of the projector from fading or deteriorating:

- Do not spray insecticide on or inside the projector.
- Do not use benzine or thinner to clean it.
- Do not let rubber or plastic materials contact with projector.

### Cleaning of the lens

Use a standard lens-cleaning brush or a piece of lens tissue dampened with lens cleaning fluid. The lens surface is fragile. Use only recommended, nonabrasive lens-cleaning materials. Do not touch the lens with your fingers.

# Indicators

This projector has two indicators, each of which shows the operation condition of the projector.

The following offer solutions to possible problems. If these problem persist, turn the projector off and consult your dealer.

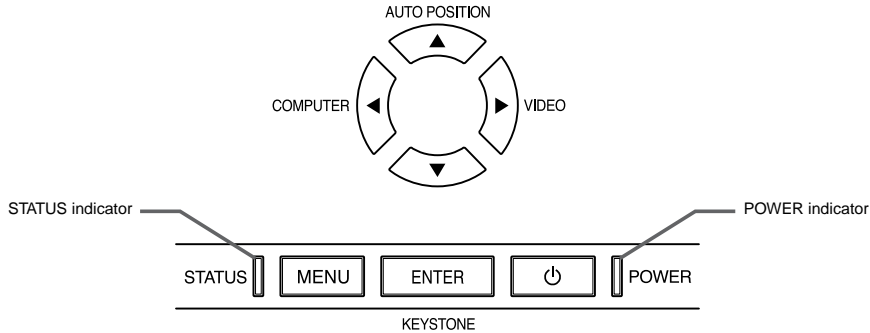

## Normal condition

POWER	STATUS	CONDITION	NOTE
 Steady red	 Off	Stand-by	
 Steady green	 Blinking green	Lamp stand-by (about 1 minute)	The POWER button cannot be used to switch between on and off.
 Steady green	 Steady green	The power is on. (Normal condition)	

## Abnormal condition

POWER	STATUS	CONDITION	POSSIBLE SOLUTION
 Steady green or Steady red	 Blinking orange	Abnormal temperature <ul style="list-style-type: none"> <li>The ventilation grilles is clogged with dust or dirt.</li> <li>The room temperature is high.</li> </ul>	<ul style="list-style-type: none"> <li>Clean the ventilation grilles.</li> <li>Relocate the projector to a cooler place.</li> </ul>
 Steady red	 Blinking green	The protection circuit is working or the lamp is in an abnormal condition.	<ul style="list-style-type: none"> <li>Wait until the STATUS indicator goes out, then press the POWER button.</li> <li>If the above solution is not effective, replace the lamp.</li> </ul>
 Steady green	 Blinking green/red	The lamp operation time exceeds the time elapsed until the lamp shutdown notice while the power is on. (See page 22.)	Replace the lamp. Change with a new lamp if this problem recurs.
 Steady red	 Blinking red	The lamp operation time exceeds the time elapsed until the lamp shutdown notice while the power is off. (See page 22.)	
 Steady red	 Steady red	The lamp operation time exceeds the time elapsed until the lamp shutdown. (See page 22.)	
 Blinking green/red	 Off	The lamp cover isn't closed.	Close the cover correctly.
 Blinking green/red	 Steady or Blinking	Abnormal.	Contact your dealer.

# Specifications

Type	DLP™ DATA projector	
Model	XD470U/XD470U-G	
Rated power supply	100 - 240 V AC, 50 / 60 Hz	
Rated input	3.8 A	
Display Technology	0.55-inch Single chip Digital Micromirror Device (DMD) with R,G,B,W color wheel Pixels 1024 x 768 = 786432 pixels	
Colors	16770000 colors	
Projection lens	F 2.4 - 2.6, f = 18 - 21.6 mm	
Light source lamp	280 W	
Picture size	40 - 300 inch (aspect ratio 4:3)	
PC compatibility	Resolution:640x400 (Expand) - 1024x768 (Real) - 1280x1024 (Compress) Sync on Green available	
Video compatibility	NTSC / NTSC 4.43 / PAL (including PAL-M, N) / SECAM, PAL-60 Component Video (DVD/HDTV) (480i, 576i, 480p, 576p, 1080i, 720p)	
Speaker	2 W Mono, Round type ø4.5 cm x 1	
S-video input	Luminance signal: 1.0 Vp-p 75 Ω (negative sync.) Chroma signal: 0.286 Vp-p 75 Ω (burst signal)	
Video input	1.0 Vp-p 75 Ω (negative sync.)	
Audio input	350 mVrms, 10 kΩ or more	
Analog RGB input	RGB: 0.7 Vp-p 75 Ω (negative sync.) YPbPr/YCbCr : Y:1.0 Vp-p (negative sync.) HD/CS : TTL level (positive or negative) VD : TTL level (positive or negative)	PbPr/CbCr:0.7 Vp-p
Control connector	Serial terminal (RS-232C) (D-SUB 9-pin) USB terminal (for Page Up/Down)	
Outside dimensions	261 x 102 x 265 mm (width x height x depth)	
Weight	Approx. 2.8 kg	
Length of power cord	114 inch (1.8 m)	
Temperature, humidity (performance guaranteed)	+41°F (+5°C) - +95°F (+35°C), 30 - 90%	

- The specifications and outside appearance of the projector are subject to change without prior notice.

## Specifications (continued)

### Connectors

COMPUTER IN/OUT (Mini D-SUB 15-pin)

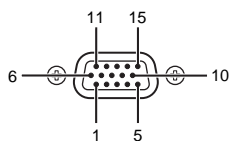

IN

OUT

pin No.	Spec.
1	R(RED)/CR
2	G(GREEN)/Y
3	B(BLUE)/CB
4	GND
5	GND
6	GND
7	GND
8	GND
9	DDC5V
10	GND
11	GND
12	DDC Data
13	HD/CS
14	VD
15	DDC Clock

pin No.	Spec.
1	R(RED)/CR
2	G(GREEN)/Y
3	B(BLUE)/CB
4	-
5	GND
6	GND
7	GND
8	GND
9	-
10	GND
11	-
12	-
13	HD/CS
14	VD
15	-

### Dimensional drawings (unit : mm)

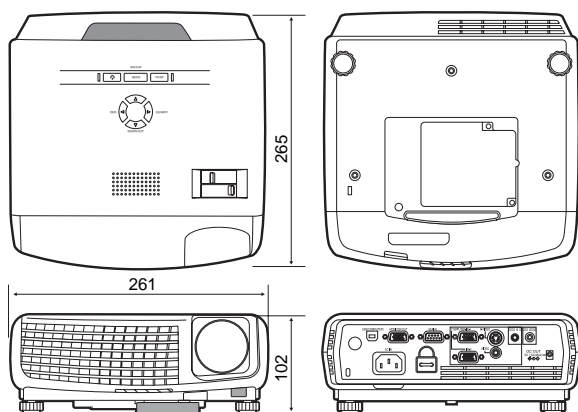

### What's included in the box

AC power cord	for US 02552-0063-01	1 Remote control
	for EU 02552-0066-01	1 Safety manual/Quick start up
	for UK 02552-0065-01	1 CD-ROM
1 RGB cable for PC	02552-0072-00	2 Battery
1 VIDEO cable	02552-0068-00	1 Lens cap
		1 Soft case

### Replacement part

(Option / Not included in the box)

Spare lamp for XD470U/XD470U-G

VLT-XD470LP

## Specification of RGB signals in each computer mode of the projector

Signal mode	resolution (H x V)	horizontal frequency (kHz)	vertical frequency (Hz)	XD470U/XD470U-G (H x V)
TV60, 480i(525i)	-	15.73	59.94	1024 x 768
TV50, 576i(625i)	-	15.63	50.00	1024 x 768
1080i 60 (1125i 60)	-	33.75	60.00	1024 x 576
1080i 50 (1125i 50)	-	28.13	50.00	1024 x 576
480p (525p)	-	31.47	59.94	1024 x 768
576p (625p)	-	31.25	50.00	1024 x 768
720p 60 (750p 60)	-	45.00	60.00	1024 x 576
720p 50 (750p 50)	-	37.50	50.00	1024 x 576
PC98	640 x 400	24.82	56.42	1024 x 640
CGA84	640 x 400	37.86	84.13	1024 x 640
CGA85	640 x 400	37.86	85.08	1024 x 640
VGA60	640 x 480	31.47	59.94	1024 x 768
VGA72	640 x 480	37.86	72.81	1024 x 768
VGA75	640 x 480	37.50	75.00	1024 x 768
VGA85	640 x 480	43.27	85.01	1024 x 768
SVGA56	800 x 600	35.16	56.25	1024 x 768
SVGA60	800 x 600	37.88	60.32	1024 x 768
SVGA72	800 x 600	48.08	72.19	1024 x 768
SVGA75	800 x 600	46.88	75.00	1024 x 768
SVGA85	800 x 600	53.67	85.06	1024 x 768
XGA60	1024 x 768	48.36	60.00	1024 x 768
XGA70	1024 x 768	56.48	70.07	1024 x 768
XGA75	1024 x 768	60.02	75.03	1024 x 768
XGA85	1024 x 768	68.68	85.00	1024 x 768
SXGA70a	1152 x 864	63.85	70.01	1024 x 768
SXGA75a	1152 x 864	67.50	75.00	1024 x 768
WXGA60	1280 x 768	47.77	59.87	1024 x 614
WXGA60a	1280 x 800	49.70	59.81	1024 x 640
WXGA60b	1360 x 768	47.71	60.01	1024 x 578
WXGA60c	1366 x 768	47.50	59.75	1024 x 575
SXGA60b	1280 x 960	60.00	60.00	1024 x 768
SXGA60	1280 x 1024	63.98	60.02	960 x 768
MAC13	640 x 480	35.00	66.67	1024 x 768
MAC16	832 x 624	49.72	74.55	1024 x 768
MAC19	1024 x 768	60.24	75.02	1016 x 768
MAC21	1152 x 870	68.59	74.96	1024 x 768
HP75	1024 x 768	62.94	74.92	1024 x 768
SUN66a	1152 x 900	61.85	66.00	984 x 768
SUN76a	1152 x 900	71.81	76.64	984 x 768

\*1 When you input the signals WXGA60, WXGA60b, or WXGA60c, select the supported image size from WXGA of the FEATURE menu. WXGA60a signal can be detected automatically.

### Important:

- Some computers aren't compatible with the projector.
- The projector's maximum resolution is 1024 x 768 pixels. It may not display images of higher resolutions than 1024 x 768 (or 800 x 600) correctly.
- Images with SYNC on G (Green) signal may jitter.
- Images with SYNC on G (Green) signal may be tinged with green.
- If the resolution and frequency of your computer aren't shown on the table, find the compatible resolution and frequency by changing the resolution of your computer.
- Set COMPUTER INPUT in the SIGNAL menu to RGB when inputting the HDTV signal as RGB signal.
- TV60 and TV50 are equivalent to 480i and 576i respectively. When these signals are supplied to the VIDEO or S-VIDEO signal, the signal mode is indicated as TV60 or TV50. When they are supplied to the COMPONENT terminal, the signal mode is indicated as 480i or 576i.

# MITSUBISHI Projector Contact Information

## North America

MESCA (Mitsubishi Electric Sales Canada Inc.)  
<http://www.mitsubishielectric.ca>  
 Information Technologies Group, 4299 14th Avenue,  
 Markham, Ontario L3R 0J2, Canada  
**Sales & Technical Inquiries**  
 Phone :+1-(800) 450-6487  
 Fax :+1-(905) 475-7958  
 E-mail :projectors@mitsubishielectric.ca  
**Customer Care**  
 E-mail :support@mitsubishielectric.ca

MDEA (Mitsubishi Digital Electronics America, Inc.)  
 (Warranty Registration)  
<http://www.mitsubishi-presentations.com/>  
 Presentation Products Division, 9351 Jeronimo Road,  
 Irvine, CA 92618 U.S.A  
**Sales & Inquiries**  
 Phone :+1(888) 307-0349 or +1(949)465-6000  
 E-mail :ppdinfo@mdea.com  
**Technical Inquiries**  
 Phone :+1-(888) 307-0309  
 E-mail :TSUPPORT@mdea.com

## Europe

MEU-FRA (Mitsubishi Electric Europe B.V French Branch)  
 25, Boulevard des Bouvets 92 741, Nanterre CEDEX,  
 France  
**Sales Inquiries**  
 Phone :+33 (0)1 55-68-55-53  
 Fax :+33 (0)1 55-68-57-31  
**Technical Inquiries**  
 Phone :+33 (0)1 55-68-56-42  
 Fax :+33 (0)1 55-68-57-31

MEU-GER (Mitsubishi Electric Europe B.V. German Branch)  
<http://www.mitsubishi-evs.de/>  
 Gothaer Strasse 8, 40880 Ratingen, Germany  
**Sales Inquiries**  
 Phone :0049 - 2102 - 486 9250  
 Fax :0049 - 2102 - 486 7320  
**Technical Inquiries**  
 Phone :0049 - 2102 - 486 1330  
 Fax :0049 - 2102 - 486 1340

MEU-IR (Mitsubishi Electric Europe B.V. Irish Branch)  
<http://www.mitsubishi.ie/>  
 Westgate Business Park, Ballymount, Dublin 24, Ireland  
**Sales Inquiries**  
 Phone :+353-1-4198807  
 Fax :+353-1-4198890  
**Technical Inquiries**  
 Phone :+353-1-4198808  
 Fax :+353-1-4198895

MEU-IT (Mitsubishi Electric Europe B.V. Italian Branch)  
 Centro Direzionale Colleoni, Palazzo Sirio, Viale Colleoni 7,  
 20041 Agrate Brianza, Italy  
**Sales & Technical Inquiries**  
 Phone :+39-(0)39-60531  
 Fax :+39-(0)39-6053214  
 E-mail :info.projector@it.mee.com

MEU-NL (Mitsubishi Electric Europe B.V. Benelux Branch)  
<http://www.mitsubishi.nl/LCD/ProdFrame.html>  
 Nijverheidsweg 23A, 3641 RP Mijdrecht, The Netherlands  
**Sales Inquiries**  
 Phone :+31-297-282461  
 Fax :+31-297-283936  
 E-mail :info@mitsubishi.nl  
**Technical Inquiries**  
 Phone :+31-297-282461  
 Fax :+31-297-283936  
 E-mail :info@mitsubishi.nl

Russia (Mitsubishi Electric Europe B.V Moscow  
 Representative Office)  
<http://www.mitsubishi-projector.ru/>  
 Moscow Representative Office, 52/5 Kosmodamianskaya  
 Nab., 115054, Moscow, Russia  
**Sales & Technical Inquiries**  
 Phone : (7095) 721-2068  
 Fax : (7095) 721-2071

MEU-SP (Mitsubishi Electric Europe B.V. Spanish Branch)  
<http://www.mitsubishielectric.es/>  
 Ctra. de Rubi, 76-80, 08173 Sant Cugat del Valles,  
 Barcelona, Spain  
**Sales Inquiries**  
 Phone :+34-93.565.31.54  
 Fax :+34-93.589.43.88  
 E-mail :mitsubishi.profesional@sp.mee.com  
**Technical Inquiries**  
 Phone :+34-93.586.27.51  
 Fax :+34-93.588.53.87  
 E-mail :mitsubishi.profesional@sp.mee.com

MEU-SWE (Mitsubishi Electric Europe B.V Scandinavian  
 Branch)  
 Hammarbacken 14, Box 750, S-19127, Sollentuna, Sweden  
**Sales Inquiries**  
 Phone :+46-(0)8-6251070  
 Fax :+46-(0)8-6251036  
**Technical Inquiries**  
 Phone :+46-(0)8-6251052  
 Fax :+46-(0)8-6251036

MEU-UK (Mitsubishi Electric Europe)  
<http://www.mitsubishi.co.uk/evs/>  
 Visual Information Systems Division, Travellers Lane,  
 Hatfield, Hertfordshire, AL10 8XB U.K.  
**Sales Inquiries**  
 Phone :+44 (1707) 278684  
 Fax :+44 (1707) 278541  
 E-mail :projector.info@meuk.mee.com  
**Technical Inquiries**  
 Phone :+44 (870) 606 5008  
 Fax :+44 (1506) 431927  
 E-mail :projector.info@meuk.mee.com

## Asia

CHINA (Mitsubishi Electric Air-Conditioning & Visual  
 Information Systems (Shanghai) Ltd.)  
 26/F., Oriental Center, 699 Nanjing Rd(W), Shanghai,  
 200041, China  
**Sales Inquiries**  
 Phone :+86(21) 5211-0882-3002  
 Fax :+86(21) 5211-0576  
**Technical Inquiries**  
 Phone :+86(21) 5211-0882-3020  
 Fax :+86(21) 5211-0576

HONG KONG (Mitsubishi Electric Ryoden Air-Conditioning &  
 Visual Information Systems (HongKong) Ltd.)  
 7th Floor, Manulife Tower, 169 Electric Road, North Point,  
 Hong Kong  
**Sales Inquiries**  
 Phone :+852-2510-1505  
 Fax :+852-2510-0463  
**Technical Inquiries**  
 Phone :+852-2422-0161  
 Fax :+852-2487-0181

SINGAPORE (Mitsubishi Electric Asia Pte. Ltd.)  
<http://www.mitsubishielectric.com.sg>  
 307, Alexandra Road, #05-01/02 Mitsubishi Electric  
 Building, Singapore 159943  
**Sales Inquiries**  
 Phone :+65-6473-2308  
 Fax :+65-6475-9503  
 E-mail :Peripherals@asia.meap.com  
**Technical Inquiries**  
 Phone :+65-6470-2666  
 Fax :+65-6475-9503

INDIA (Mitsubishi Electric Asia Pte. Ltd.)  
 307, Alexandra Road, #05-01/02 Mitsubishi Electric  
 Building, Singapore 159943  
**Sales Inquiries**  
 Phone :+65-6473-2308  
 Fax :+65-6475-9503  
 E-mail :Peripherals@asia.meap.com  
**Technical Inquiries**  
 Phone :+65-6470-2666  
 Fax :+65-6475-9503

INDONESIA (Mitsubishi Electric Asia Pte. Ltd.)  
 307, Alexandra Road, #05-01/02 Mitsubishi Electric  
 Building, Singapore 159943  
**Sales Inquiries**  
 Phone :+65-6473-2308  
 Fax :+65-6475-9503  
 E-mail :Peripherals@asia.meap.com  
**Technical Inquiries**  
 Phone :+65-6470-2666  
 Fax :+65-6475-9503

PHILIPPINES (Mitsubishi Electric Asia Pte. Ltd.)  
<http://www.mitsubishielectric.com.sg>  
 307, Alexandra Road, #05-01/02 Mitsubishi Electric  
 Building, Singapore 159943  
**Sales Inquiries**  
 Phone :+65-6473-2308  
 Fax :+65-6475-9503  
 E-mail :Peripherals@asia.meap.com  
**Technical Inquiries**  
 Phone :+65-6470-2666  
 Fax :+65-6475-9503

VIETNAM (Mitsubishi Electric Asia Pte. Ltd.)  
 307, Alexandra Road, #05-01/02 Mitsubishi Electric  
 Building, Singapore 159943  
**Sales Inquiries**  
 Phone :+65-6473-2308  
 Fax :+65-6475-9503  
 E-mail :Peripherals@asia.meap.com  
**Technical Inquiries**  
 Phone :+65-6470-2666  
 Fax :+65-6475-9503

STC (Setsuyo Astec Corporation Seoul Branch)  
 4F, Dongseo Game Channel Bldg, 660-11 Deungchon-Dong,  
 Kangseo-Ku, Seoul, Korea  
**Sales & Technical Inquiries**  
 Phone :+82-(0)2-2657-9841-3  
 Fax :+82-(0)2-2657-9900

MALAYSIA (Antah Melco Sales & Services Sdn. Bhd.)  
 6, Jalan 13/6 46860 Petaling Jaya Selangor, Darul Ehsan,  
 Malaysia  
**Sales & Technical Inquiries**  
 Phone :+60-(0)3-79552088 (Ext. 203)  
 Fax :+60-(0)3-79563950/+60-(0)3-79582576  
**Technical & Service Inquiries**  
 Phone :+60-(0)3-79552088 (Ext. 106)  
 Fax :+60-(0)3-79563950/+60-(0)3-79582576

ME-TWN (Mitsubishi Electric Taiwan Co., Ltd.)  
<http://www.MitsubishiElectric.com.tw>  
 11TH FL., 90 SEC. 6, CHUNG SHAN N. RD., TAIPEI, 111  
 R.O.C.  
**Sales & Technical Inquiries**  
 Phone :+886-2-2832-8255  
 Fax :+886-2-2833-9813

MKY (Mitsubishi Electric Kang Yong Watana Co., Ltd.)  
<http://www.mitsubishi-kyw.co.th/>  
 Road, Huamark Bangkokpi, Bangkok 10240, Thailand  
**Sales & Technical Inquiries**  
 Phone :+66-2-731-6841  
 Fax :+66-2-379-4763

## Oceania

ME-AUST (Mitsubishi Electric Australia)  
<http://www.mitsubishi-electric.com.au/prod.asp?prod=proj>  
 348 Victoria Road, Rydalmere, N.S.W. 2116, Australia Sales  
 & Technical Inquiries  
 Phone :+(612)9684-7777  
 Fax :+(612)9684-7208  
 E-mail :diamonddigital@meaust.meap.com  
**Technical Inquiries**  
 Phone :+(612)9684-7694  
 Fax :+(612)9684-7684  
 E-mail :service@meaust.meap.com

BDT (Black Diamond Technologies Ltd.)  
 (Warranty Registration) <http://www.bdt.co.nz/projectors/warranty.asp>  
 1 Parliament St, Lower Hutt, Wellington, New ZealandSales  
 Inquiries  
 Phone :+64-(0)4-560-9100  
 Fax :+64-(0)4-560-9133  
 E-mail :projectorsales@bdt.co.nz  
**Technical Inquiries**  
 Phone :+64-(0)4-560-9100  
 Fax :+64-(0)4-560-9133  
 E-mail :service@bdt.co.nz