

**EPSON**

# User's Guide

**Multimedia Projector**

**EMP-83/822**



**EMP-X5/S5**









## ■ Safety Indications

So that you can use the projector safely and correctly, symbols are applied in the documentation and on the projector to indicate possible harm to the user or to others and the risk of damage to property.

The indications and their meaning are as follows. Make sure you understand them properly before reading the guide.

 <b>Warning</b>	Indicates the possibility of death or serious injury if this symbol is ignored or if sufficient care is not taken.
 <b>Caution</b>	Indicates the possibility of injury or damage to property if this symbol is ignored or if sufficient care is not taken.

## ■ General Information Indications

<b>Attention</b>	Indicates procedures which may result in damage or injury if sufficient care is not taken.
	Indicates additional information and points which may be useful to know regarding a topic.
	Indicates a page where detailed information regarding a topic can be found.
	Indicates that an explanation of the underlined word or words in front of this symbol appears in the glossary of terms. See the "Glossary" section of the "Appendices".  <a href="#">p.65</a>
<b>Procedure</b>	Indicates operating methods and the order of operations. The procedure indicated should be carried out in the order of the numbered steps.
[ (Name) ]	Indicates the name of the buttons on the remote control or the control panel. Example: [Esc] button
"(Menu Name)"	Indicates configuration menu items. Example: "Image" - "Brightness"
	Indicates that the explanation continues on the following page. Clicking this symbol will display the following page.
	Indicates that the explanation is continued from the previous page. Clicking this symbol will display the previous page.

<b>Projector Features</b> .....	<b>4</b>
<b>Part Names and Functions</b> .....	<b>5</b>
Front/Top.....	5
Rear (EMP-83/822 Only).....	6
Rear (EMP-X5/S5 Only).....	7
Control Panel .....	8
Remote Control .....	10
Base .....	11

## Useful Functions

<b>Changing the Projected Image (Source Search)</b> .....	<b>13</b>
<b>Functions for Enhancing Projection</b> .....	<b>14</b>
Selecting the Projection Quality (Selecting Color Mode) .....	14
Hiding the Image and Sound Temporarily (A/V Mute) .....	15
Freezing the Image (Freeze).....	16
Changing the Aspect Ratio (Aspect).....	16
Enlarging Part of the Image (E-Zoom) .....	17
<b>Security Functions</b> .....	<b>18</b>
Managing Users (Password Protect) .....	18
Restricting Operation (Operation Lock).....	20
Anti-Theft Lock.....	21

## Configuration Menu

<b>Using the Configuration Menu</b> .....	<b>23</b>
<b>List of Functions</b> .....	<b>24</b>
Image Menu (EMP-83/822 Only) .....	24
Image Menu (EMP-X5/S5 Only).....	25
Signal Menu (EMP-83/822 Only) .....	26
Signal Menu (EMP-X5/S5 Only).....	27
Settings Menu .....	28
Extended Menu .....	29
Network Menu (EMP-83/822 Only) .....	31
Info Menu (Display Only).....	34
Reset Menu.....	35

## Troubleshooting

<b>Using the Help</b> .....	<b>37</b>
<b>Problem Solving</b> .....	<b>38</b>
Reading the Indicators .....	38
When the Indicators Provide No Help .....	41

## Appendices

<b>Installation Methods</b> .....	<b>49</b>
<b>Cleaning</b> .....	<b>50</b>
Cleaning the Projector's Surface .....	50
Cleaning the Lens.....	50
Cleaning the Air Filter and Air Intake Vent.....	50
<b>Replacing Consumables</b> .....	<b>51</b>
Replacing the Remote Control Batteries .....	51
Replacing the Lamp.....	52
Replacing the Air Filter .....	56
<b>Saving a User's Logo</b> .....	<b>57</b>
<b>Screen Size and Distance</b> .....	<b>59</b>
EMP-83/822/X5 .....	59
EMP-S5 .....	60
<b>Connecting to External Equipment</b> .....	<b>61</b>
Connecting to an External Monitor .....	61
Connecting to External Speakers (EMP-83/822 Only) .....	61
<b>Connecting a LAN Cable (EMP-83/822 Only)</b> .....	<b>62</b>
<b>Connecting a USB Cable (EMP-X5/S5 Only)</b> .....	<b>63</b>
<b>Optional Accessories and Consumables</b> .....	<b>64</b>
<b>Glossary</b> .....	<b>65</b>
<b>ESC/VP21 Commands</b> .....	<b>67</b>
Command List.....	67
Cable Layouts .....	67
Connecting a USB (EMP-X5/S5 Only).....	68
USB Connection Setup.....	68
<b>PJLink (EMP-83/822 Only)</b> .....	<b>69</b>
<b>List of Supported Monitor Displays</b> .....	<b>70</b>
<b>Specifications</b> .....	<b>71</b>
<b>Appearance</b> .....	<b>75</b>
<b>Index</b> .....	<b>76</b>

## Ease of use

### ■ The A/V mute slide makes it easy to project and store

You can stop and resume projection easily by opening and closing the A/V mute slide which makes giving clear presentations easier.

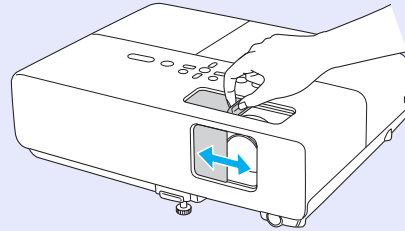

### ■ A single foot design means you do not have to make any difficult levelling adjustments

You can easily make height adjustments with one hand.

☞ *Quick Start Guide*

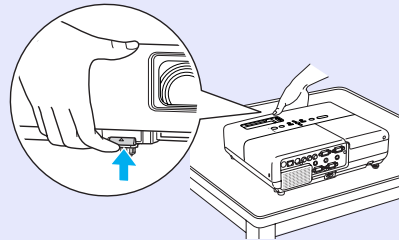

## Enhanced security functions

### ■ Password Protect to restrict and manage users

By setting a password you can restrict who can use the projector. ☞ [p.18](#)

### ■ Operation Lock restricts button operation on the control panel

You can use this to prevent people from changing projector settings without permission at events, in schools, and so on. ☞ [p.20](#)

### ■ Equipped with various anti-theft devices

The projector is equipped with the following security devices. ☞ [p.21](#)

- Security slot
- Security cable installation point

## Easy to handle

### ■ Direct power On/Off (EMP-83/822 only)

In places where power is managed centrally, such as in a conference room, the projector can be set to power on and off automatically when the power source to which the projector is connected is switched on or off.

### ■ No cool down delay

After turning the projector's power off, you can disconnect the projector's power cable without having to wait for the projector to cool down first.

## Front/Top

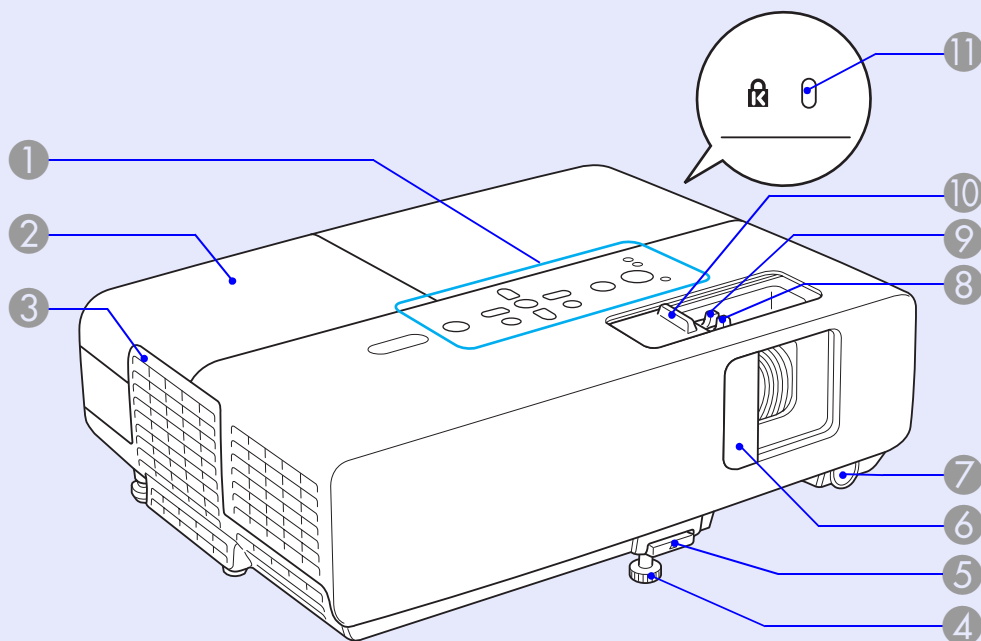

Name	Function
① <b>Control panel</b>	☞ p.8
② <b>Lamp cover</b>	Open this cover when replacing the projector's lamp. ☞ p.53
③ <b>Air exhaust vent</b>	<p><b>⚠ Caution</b></p> <p>Do not place objects that may become warped or otherwise affected by heat near the air exhaust vent and do not put your face or hands near the air exhaust vent while projection is in progress.</p>

Name	Function
④ <b>Front adjustable feet</b>	Extend and adjust the position of the projected image when the projector is placed on a surface such as a desk. ☞ <i>Quick Start Guide</i>
⑤ <b>Foot adjust lever</b>	Pull out the foot lever to extend and retract the front foot. ☞ <i>Quick Start Guide</i>
⑥ <b>A/V mute slide</b>	Slide shut when not using the projector to protect the lens. By closing during projection you can hide the image and the sound (A/V Mute). ☞ <i>Quick Start Guide, p.15</i>
⑦ <b>Remote receiver</b>	Receives signals from the remote control. ☞ <i>Quick Start Guide</i>
⑧ <b>Focus ring</b>	Adjusts the image focus. ☞ <i>Quick Start Guide</i>
⑨ <b>Zoom ring (EMP-83/822/X5 only)</b>	Adjusts the image size. ☞ <i>Quick Start Guide</i>
⑩ <b>A/V mute slide knob</b>	Slide the knob to open and close the A/V mute slide.
⑪ <b>Security slot (🔒)</b>	The security slot is compatible with the Microsaver Security System manufactured by Kensington. ☞ p.21

## Rear (EMP-83/822 Only)

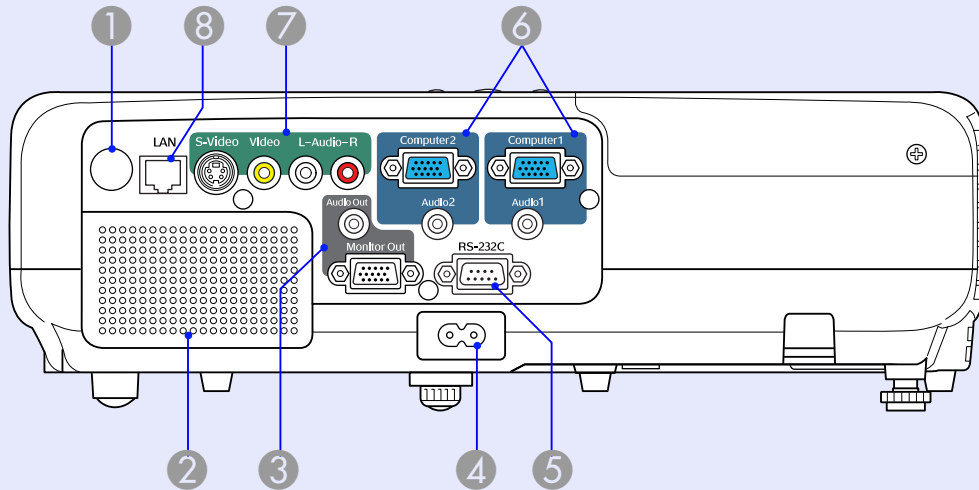

Name	Function
<b>1 Remote receiver</b>	Receives signals from the remote control. <a href="#">Quick Start Guide</a>
<b>2 Speaker</b>	
<b>3 Monitor Out port</b>	Outputs the image signal from the computer connected to the Computer1 input port to an external monitor. This is not available for <u>component video</u> signals or other signals being input to any port other than the Computer1 input port. <a href="#">p.61</a>
<b>Audio Out port</b>	Outputs the sound of the image currently being projected to external speakers. <a href="#">p.61</a>
<b>4 Power inlet</b>	Connects to the power cable. <a href="#">Quick Start Guide</a>

Name	Function
<b>5 RS-232C port</b>	When controlling the projector from a computer, connect it to the computer with an RS-232C cable. This port is for control use and should not normally be used. <a href="#">p.67</a>
<b>6 Computer1 input port</b>	For video signals from a computer and <u>component video</u> signals from other video sources.
<b>Audio1 input port</b>	Connect to the audio out port of the computer connected to the Computer1 input port.
<b>Computer2 input port</b>	For video signals from a computer and <u>component video</u> signals from other video sources.
<b>Audio2 input port</b>	Connect to the audio out port of the computer connected to the Computer2 input port. <a href="#">Quick Start Guide</a>
<b>7 S-Video input port</b>	For <u>S-video</u> signals from video sources.
<b>Video input port</b>	For <u>composite video</u> signals from video sources.
<b>Audio-L/R input port</b>	Connects to the audio out port of the equipment connected to the S-Video port or Video input port. <a href="#">Quick Start Guide</a>
<b>8 LAN port</b>	When a LAN cable is connected, you can monitor and control the projector over a LAN. <a href="#">p.62</a>

## Rear (EMP-X5/S5 Only)

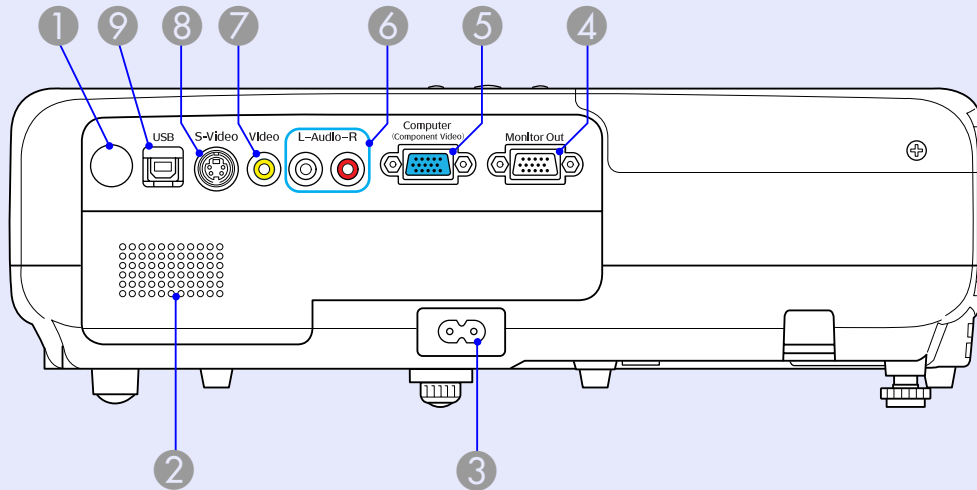

Name	Function
1 Remote receiver	Receives signals from the remote control. ☛ <i>Quick Start Guide</i>
2 Speaker	
3 Power inlet	Connects to the power cable. ☛ <i>Quick Start Guide</i>
4 Monitor Out port	Outputs the image signal from the computer connected to the Computer input port to an external monitor. This is not available for <u>component video</u> signals or other signals being input to any port other than the Computer input port. ☛ <a href="#">p.61</a>

Name	Function
5 Computer input port	For video signals from a computer and <u>component video</u> signals from other video sources.
6 Audio-L/R input port	Connects to the audio output port for the equipment you want to project from and inputs the audio. ☛ <i>Quick Start Guide</i>
7 Video input port	For <u>composite video</u> signals from video sources.
8 S-Video input port	For <u>S-video</u> signals from video sources.
9 USB port (Type B)	When showing a slide show in PowerPoint, you can use the projector's remote control to move to the next slide/previous slide if it is connected to a computer by a USB cable.* Also, you can use it as a control port when the projector is controlled by a computer. Even if the projector is connected to a computer by a USB cable, you cannot project the image on the computer. ☛ <a href="#">p.63</a>

\* Limited to computers with the following operating systems installed.  
Windows 98/98SE/2000/Me/XP Home Edition/XP Professional  
Macintosh: OS 8.6 to 9.2/10.1 to 10.3

## Control Panel

### ■ EMP-83/822/X5

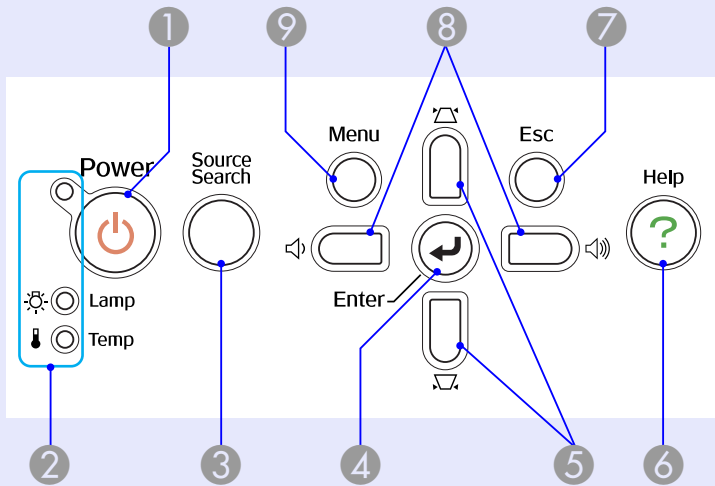

### ■ EMP-S5

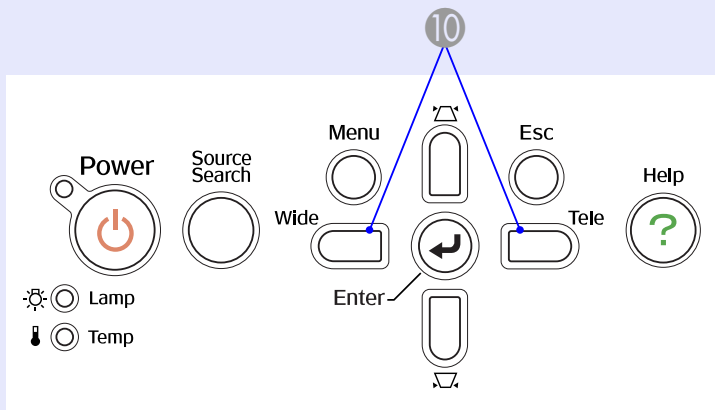

Buttons without numbers operate in the same way as in the figure above. See the numbers in the table for the figure above.



Name	Function
① [Power] button	Turns the projector power on or off. ☞ <i>Quick Start Guide</i>
② Status indicators	The color of the indicators and whether they are flashing or lit indicates the status of the projector. ☞ <a href="#">p.38</a>
③ [Source Search] button	Changes to the next input source that is connected to the projector and is sending an image. ☞ <a href="#">p.13</a>
④ [Enter] button	If pressed during projection of computer signal images, it automatically adjusts the tracking, synchronization, and position to project the optimum image. When a configuration menu or a help screen is displayed, it accepts and enters the current selection and moves to the next level. ☞ <a href="#">p.23</a>
⑤ [↖] [↗] buttons	Corrects keystone distortion. If pressed when a configuration menu or a help screen is displayed, these buttons select menu items and setting values. ☞ <i>Quick Start Guide</i> , <a href="#">p.23</a>
⑥ [Help] button	Displays and closes the help screen which shows you how to deal with problems if they occur. ☞ <a href="#">p.37</a>
⑦ [Esc] button	Stops the current function. If pressed when a configuration menu is displayed, it moves to the previous menu level. ☞ <a href="#">p.23</a>
⑧ [◀] [▶] buttons (EMP-83/822/X5 only)	Press to adjust the volume. If pressed when a configuration menu or a help screen is displayed, these buttons select menu items and setting values. ☞ <i>Quick Start Guide</i> , <a href="#">p.23</a>





Name	Function
9 <b>[Menu] button</b>	Displays and closes the configuration menu.  <a href="#">p.23</a>
10 <b>[Wide] [Tele] buttons (EMP-S5 only)</b>	Adjusts the image size. If pressed when a configuration menu or a help screen is displayed, these buttons select menu items and setting values.  <i>Quick Start Guide, <a href="#">p.23</a></i>



## Remote Control

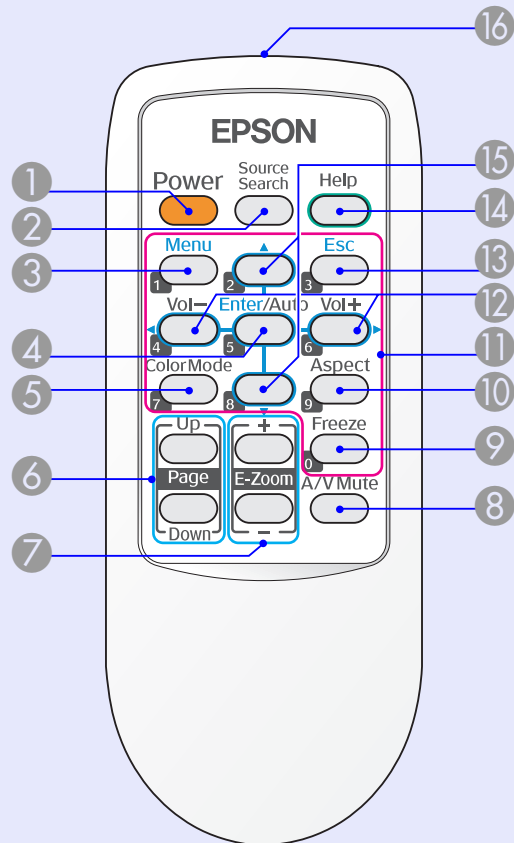

Illustrations show EMP-X5/S5.

Name	Function
① [Power] button	Turns the projector power on or off. ☞ <i>Quick Start Guide</i>
② [Source Search] button	Changes to the next input source that is connected to the projector and is sending an image.☞ p.13

Name	Function
③ [Menu] button	Displays and closes the configuration menu. ☞ p.23
④ [Enter/Auto] button	If pressed during projection of computer signal images, it automatically adjusts the tracking, synchronization, and position to project the optimum image.☞ p.26 When a configuration menu or a help screen is displayed, it accepts and enters the current selection and moves to the next level.☞ p.23
⑤ [Color Mode] button	Each time the button is pressed, the color mode changes.☞ p.14
⑥ [Page] button (Down) (Up) (EMP-X5/S5 only)	When showing a slide show in PowerPoint, you can use the projector's remote control to move to the next slide/previous slide if it is connected to a computer by a USB cable.* ☞ p.63
⑦ [E-Zoom] button (+) (-)	(+) Enlarges the image without changing the projection size. (-) Reduces parts of the image that have been enlarged using the [+] button.☞ p.17
⑧ [A/V Mute] button	Turns the video and audio on or off.☞ p.15
⑨ [Freeze] button	Images are paused or unpaused.☞ p.16
⑩ [Aspect] button	The <u>aspect ratio</u> changes each time the button is pressed.☞ p.16
⑪ Numeric buttons	Use these buttons when entering a password. ☞ p.19

\* Limited to computers with the following operating systems installed.  
Windows 98/98SE/2000/Me/XP Home Edition/XP Professional  
Macintosh: OS 8.6 to 9.2/10.1 to 10.3



Name	Function
12 <b>[Volume -] button</b> <b>[Volume +] button</b>	Press [Volume -] to lower the volume and press [Volume +] to raise the volume. If pressed when a configuration menu or a help screen is displayed, these buttons select menu items and setting values. ☛ <i>Quick Start Guide</i> , p.23
13 <b>[Esc] button</b>	Stops the current function. If pressed when a configuration menu is displayed, it moves to the previous level. ☛ p.23
14 <b>[Help] button</b>	Displays and closes the help screen which shows you how to deal with problems if they occur. ☛ p.37
15 <b>[▲] [▼] buttons</b>	If pressed when a configuration menu or a help screen is displayed, these buttons select menu items and setting values. ☛ p.23
16 <b>Remote control light-emitting area</b>	Outputs remote control signals. ☛ <i>Quick Start Guide</i>

### Base

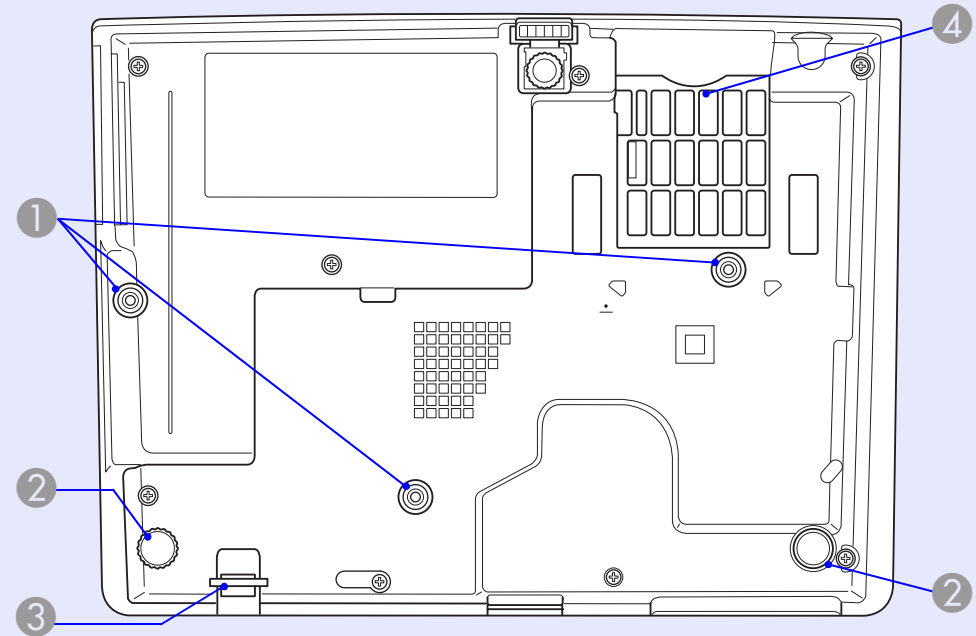

Name	Function
1 <b>Suspension bracket fixing points (3 points)</b>	Attach the optional ceiling mount here when suspending the projector from a ceiling. ☛ p.49, 64
2 <b>Rear foot (2 points)</b>	Turn to extend and retract to adjust the horizontal tilt. ☛ <i>Quick Start Guide</i>
3 <b>Security cable installation point</b>	Pass a commercially available anti-theft wire lock through here when you want to secure the projector to a fixed object. ☛ p.21
4 <b>Air filter (Air intake vent)</b>	This prevents dust and other foreign particles from getting inside the projector when air is drawn in. The projector displays a warning message when it is time to clean or replace the air filter. ☛ p.50, 56





# Useful Functions

This chapter explains useful functions for giving presentations and so on, and the security functions.

<b>Changing the Projected Image (Source Search) .....</b>	<b>13</b>
<b>Functions for Enhancing Projection .....</b>	<b>14</b>
• <b>Selecting the Projection Quality (Selecting Color Mode) .....</b>	<b>14</b>
• <b>Hiding the Image and Sound Temporarily (A/V Mute) .....</b>	<b>15</b>
• <b>Freezing the Image (Freeze).....</b>	<b>16</b>
• <b>Changing the Aspect Ratio (Aspect).....</b>	<b>16</b>
• <b>Enlarging Part of the Image (E-Zoom) .....</b>	<b>17</b>

<b>Security Functions .....</b>	<b>18</b>
• <b>Managing Users (Password Protect).....</b>	<b>18</b>
Type of Password Protect .....	18
Setting Password Protect.....	19
Entering the Password.....	20
• <b>Restricting Operation (Operation Lock).....</b>	<b>20</b>
• <b>Anti-Theft Lock .....</b>	<b>21</b>
Installing the wire lock.....	21

# Changing the Projected Image (Source Search)



The projector automatically detects signals being input from connected equipment, and the image being input from the equipment is projected. You can project the target image quickly because it skips input ports where no image is being input.

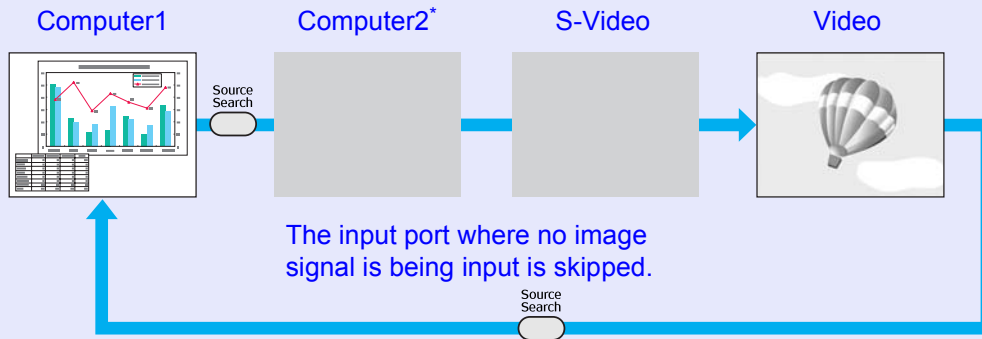

\* EMP-83/822 only

## Procedure

When your video equipment is connected, start playback before beginning this operation.

Using the remote control

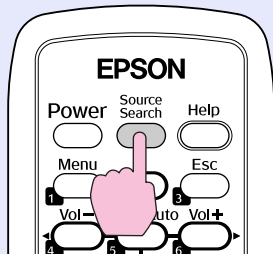

Using the control panel

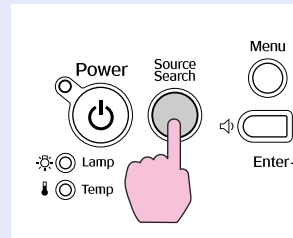

When two or more pieces of equipment are connected, press the [Source Search] button until the target image is projected.



The following screen showing the status of image signals is displayed when only the image that the projector is currently displaying is available, or when no image signal can be found. You can select the input port where the connected equipment you want to use is projecting. If no operation is performed after about 10 seconds, the screen closes.

For EMP-83/822

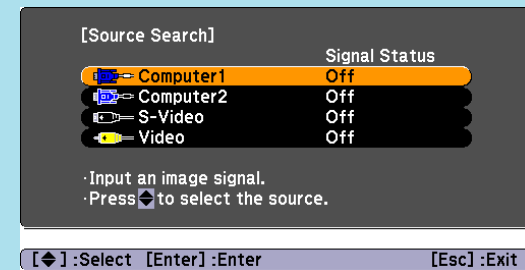

## Selecting the Projection Quality (Selecting Color Mode)

You can easily obtain the optimum image quality simply by selecting the setting that best corresponds to your surroundings when projecting. The brightness of the image varies depending on the mode selected.

Mode	Application
Game	Ideal for use in a bright room. This is the brightest mode and reproduces shadow tones well.
Presentation	Ideal for making presentations using color materials in a bright room.
Text	Ideal for making presentations using black-and-white materials in a bright room.
Theatre	Ideal for watching films in a dark room. This gives images a natural tone.
Photo	(When computer images are input) Ideal for projecting still pictures, such as photos, in a bright room. This makes images vivid and brings them into contrast.
Sports	(When component video, S-video, or composite video images are input) Ideal for watching TV programmes in a bright room. This makes images vivid and brings them to life.
sRGB	Ideal for images that conform to the sRGB color standard.
Blackboard	Even if you are projecting onto a blackboard (greenboard), this setting gives your images a natural tint, just like when projecting onto a screen.

### Procedure

Remote control

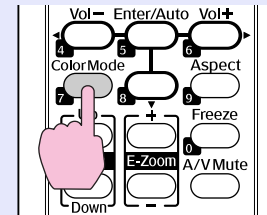

Each time you press the button, the color mode name is displayed on the screen and the color mode changes.

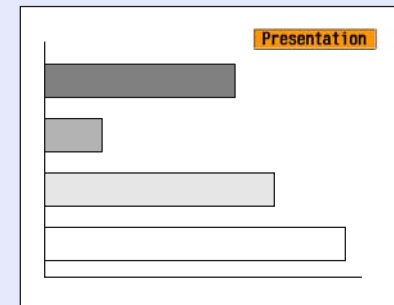

If you press the button while the color mode name is displayed on the screen, it changes to the next color mode.



*The color mode can also be set using "Color Mode" from the "Image" menu in the configuration menu. [p.24, 25](#)*

## Hiding the Image and Sound Temporarily (A/V Mute)

You can use this when you want to focus the audience's attention on what you are saying, or if you do not want to show details such as when you are changing between files during presentations from a computer.

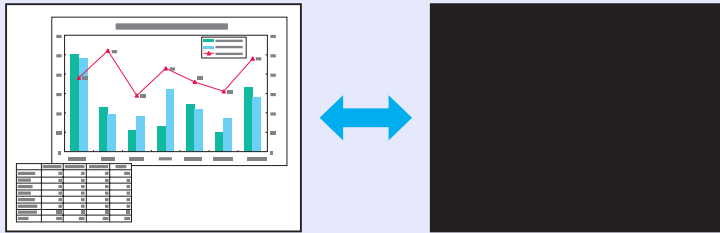

### Procedure

Remote control

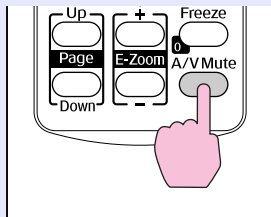

Projector

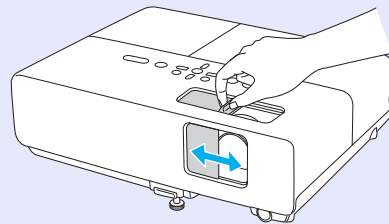

Each time you press the button, or the A/V mute slide is opened or closed, A/V Mute turns on or off.



- *If you use this function when projecting moving images, the images and sound continue to be played back by the source, and you cannot return to the point where A/V Mute was activated.*
- *From the remote control you can choose to display black, blue, or logo\* as the A/V mute display using the "Extended" - "Display" - "A/V Mute" setting in the configuration menu. p.29*
- *When the A/V mute slide is closed and A/V Mute begins, the power supply can be set to automatically turn off after about 30 minutes by setting "Extended" - "Operation" - "Lens Cover Timer" in the configuration menu. p.30*

\* Depending on the area of purchase, the User's Logo function may not be available for EMP-X5/S5.

## Freezing the Image (Freeze)

When the moving image on the screen is frozen, the image continues to project, so you can project a moving image one frame at a time like a still photo. Also, you can perform operations such as changing between files during presentations from a computer without projecting any images if the Freeze function is activated beforehand.

### Procedure

Remote control

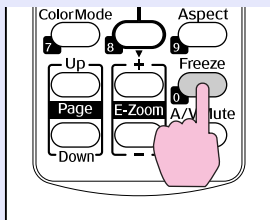

Each time you press the button, Freeze turns on or off.



- **Audio does not stop.**
- **The image source continues to play back the moving images even while the screen is frozen, so it is not possible to resume projection from the point where it was paused.**
- **If the [Freeze] button is pressed while the configuration menu or a help screen is displayed, the menu or help screen being displayed is cleared.**
- **Freeze still works while E-Zoom is being used.**

## Changing the Aspect Ratio (Aspect)

When video equipment is connected, images that have been recorded in digital video or onto DVDs can be viewed in 16:9 wide-screen format. You can change the aspect ratio for images in squeeze mode as follows.

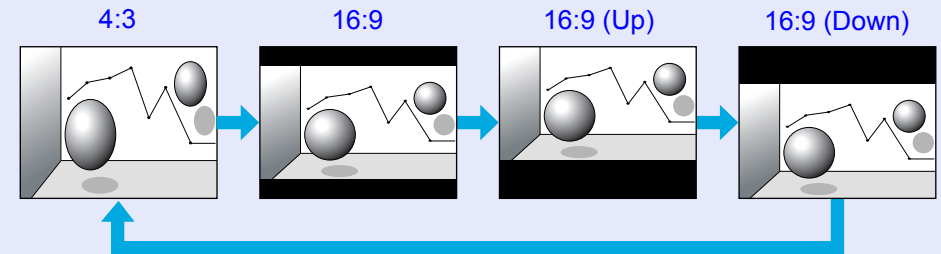

### Procedure

Remote control

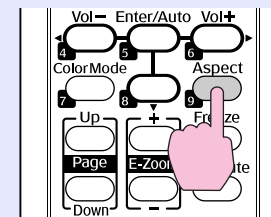

Each time you press the button, the aspect name is displayed on the screen and the aspect changes.

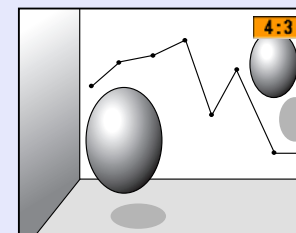



If you press the button while the aspect name is displayed on the screen, it changes to the next aspect mode.



*This can also be set using "Aspect" from the "Signal" menu in the configuration menu. [p.26](#)*

## Enlarging Part of the Image (E-Zoom)

This is useful when you want to expand images such as graphs and tables to see them in greater detail.

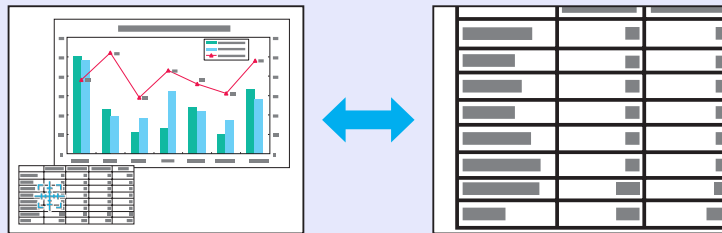

### Procedure

#### 1 Start E-Zoom.

Remote control

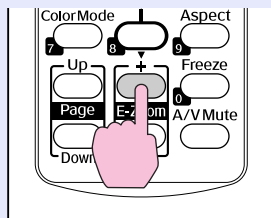

#### 2 Move the cross to the area of the image that you want to enlarge.

Remote control

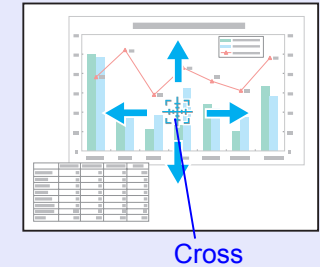
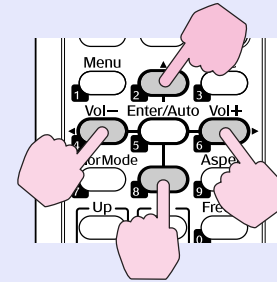

#### 3 Enlarge.

Remote control

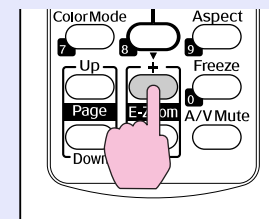

Each time the button is pressed, the area is expanded. You can expand quickly by holding the button down. You can reduce the enlarged image by pressing the [-] button. Press the [Esc] button to cancel.



- *The enlargement ratio appears on the screen. The selected area can be enlarged to between 1 to 4 times in 25 incremental steps.*
- *You can scroll the image by pressing [▲], [▼], [◀], or [▶].*

The projector has the following enhanced security functions.

- **Password Protect**  
You can limit who can use the projector.
- **Operation Lock**  
You can prevent people from changing the settings on the projector without permission.
- **Anti-Theft Lock**  
The projector is equipped with various types of anti-theft security devices.

- Settings for "Display Background", "Startup Screen", and "A/V Mute" are changed from "Display" in the configuration menu.

### 3 "Network Protect" (EMP-83/822 only)

When "Network Protect" is set to "On" setting changes for "Network" in the configuration menu are prohibited.

- \* Depending on the area of purchase, the User's Logo function may not be available for EMP-X5/S5. In that case, "User's Logo Protect" is not displayed.

## Managing Users (Password Protect)

When the Password Protect function is activated, people who do not know the password cannot use the projector to project images even if the projector power is on. Furthermore, the user's logo that is displayed when you turn on the projector cannot be changed. This acts as an anti-theft device as the projector cannot be used even if it is stolen. At the time of purchase the Password Protect function is not activated.

### ■ Type of Password Protect

The following three kinds of password protect settings can be made according to how the projector is being used.

#### 1. "Power On Protect"

When "Power On Protect" is "On", the password must be entered whenever the projector is turned on after it has been disconnected from the power supply to which it was connected the last time the password was entered. If the correct password is not entered, projection does not start.

#### 2 "User's Logo Protect"\*

When "User's Logo Protect" is set to "On" the following setting changes are prohibited.

- Capturing a user's logo

## ■ Setting Password Protect

Use the following procedure to set Password Protect.

### Procedure

- 1 Hold down the [Freeze] button for about five seconds.**

The password protect setting menu is displayed.

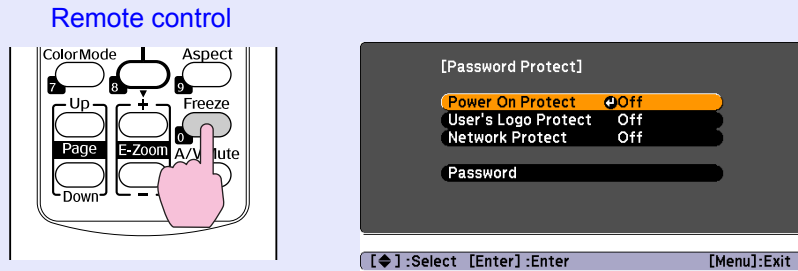

- *If Password Protect is already activated, you must enter the password. If the password is entered correctly, the password protect setting menu is displayed.*  
☞ *"Entering the Password" p.20*
- *When the password is set, stick the password protect sticker in a visible position on the projector as a further theft deterrent.*

- 2 Turn on "Power On Protect".**

- (1) Select "Power On Protect", and then press the [Enter] button.
- (2) Select "On", and then press the [Enter] button.
- (3) Press the [Esc] button.

- 3 Turn on "User's Logo Protect".\***

- (1) Select "User's Logo Protect", and then press the [Enter] button.
- (2) Select "On", and then press the [Enter] button.
- (3) Press the [Esc] button.

- 4 Turn on "Network Protect".**

- (1) Select "Network Protect", and then press the [Enter] button.
- (2) Select "On", and then press the [Enter] button.
- (3) Press the [Esc] button.

- 5 Set the password.**

- (1) Select "Password", and then press the [Enter] button.
- (2) When the message "Change the password?" is displayed, select "Yes" and then press the [Enter] button. The default setting for the password is "0000". Change this to your own desired password. If you select "No", the screen shown in step 1 is displayed again.
- (3) Enter a four digit number using the numeric buttons. The number entered is displayed as "\* \* \* \*". When you enter the fourth digit, the confirmation screen is displayed.

Remote control

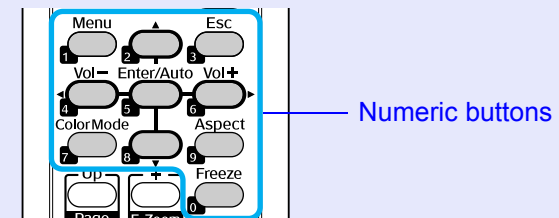

- (4) Re-enter the password.  
The message "Password accepted." is displayed.  
If you enter the password incorrectly, a message is displayed prompting you to re-enter the password.



\* Depending on the area of purchase, the User's Logo function may not be available for EMP-X5/S5. In that case, "User's Logo Protect" is not displayed.

## ■ Entering the Password



When the password entry screen is displayed, enter the password using the numeric buttons on the remote control.

### Procedure

#### Enter the password by using the numeric buttons.

When you enter the correct password, projection begins.

### Attention

- *If an incorrect password is entered three times in succession, the message "The projector's operation will be locked." is displayed for about five minutes, and then the projector switches to standby mode. If this happens, disconnect the power plug from the electrical outlet and then reinsert it and turn the projector's power back on. The projector displays the password entry screen again so that you can enter the correct password.*
- *If you have forgotten the password, make a note of the "Request Code: xxxxx" number that appears on the screen and contact the nearest address provided in the International Warranty Terms.*  
 **Inquiries**
- *If you continue to repeat the above operation and input the wrong password thirty times in succession, the following message is displayed and the projector does not accept any more password entries. "The projector's operation will be locked. Contact Epson as described in your documentation."*  **Inquiries**

## Restricting Operation (Operation Lock)

Do one of the following to lock the operation buttons on the control panel.

- **Full Lock**  
All of the buttons on the control panel are locked. You cannot perform any operations from the control panel, including turning the power on or off.
- **Operation Lock**  
All of the buttons on the control panel, except for the [Power] button, are locked.

This is useful at events or shows when you want to deactivate all buttons and only project, or at schools when you want to limit button operation. The projector can still be operated using the remote control.

### Procedure

1

Press the [Menu] button and select "Settings" - "Operation Lock" in the configuration menu.

 "Using the Configuration Menu" p.23

Using the remote control

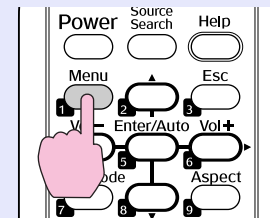

Using the control panel

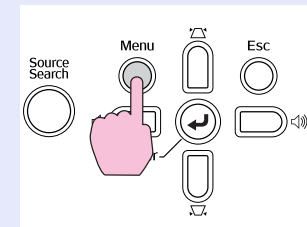

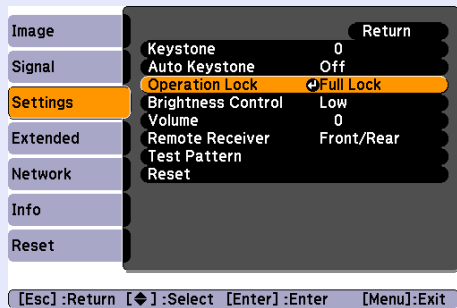

Check the buttons you can use and the operations they perform in the guide under the menu.

2

Select either "Full Lock" or "Operation Lock".

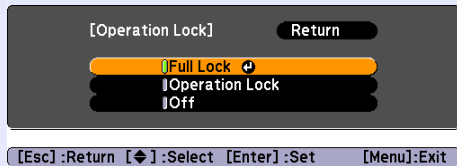

3

Select "Yes" when the confirmation message is displayed.

The control panel buttons are locked according to the setting you chose.



*You can release the control panel lock by one of the following two methods.*

- *From the remote control, select "Off" from "Settings" - "Operation Lock" in the configuration menu.*
- *When you press and hold down the [Enter] button on the control panel for about seven seconds, a message is displayed and the lock is released.*

## Anti-Theft Lock

As the projector is often setup on ceiling mounts and left in rooms unattended, it is possible that someone may try and take the projector, so the projector includes the following security devices.

- Security slot

The security slot is compatible with the Microsaver Security System manufactured by Kensington. You can find details about the Microsaver Security System on the Kensington homepage <http://www.kensington.com/>.

- Security cable installation point

A commercially available theft-prevention wire lock can be passed through the installation point to secure the projector to a desk or pillar.

### ■ Installing the wire lock

Pass an anti-theft wire lock through the installation point. See the documentation supplied with the wire lock for locking instructions.

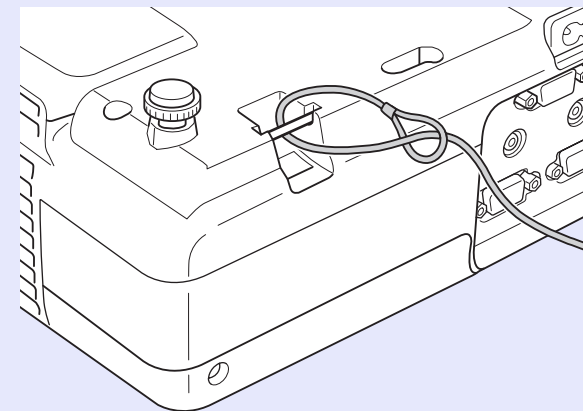



# Configuration Menu

This chapter explains how to use the configuration menu and its functions.

## Using the Configuration Menu ..... 23

## List of Functions ..... 24

- Image Menu (EMP-83/822 Only).....24
- Image Menu (EMP-X5/S5 Only) .....25
- Signal Menu (EMP-83/822 Only).....26
- Signal Menu (EMP-X5/S5 Only) .....27
- Settings Menu .....28
- Extended Menu .....29
- Network Menu (EMP-83/822 Only) .....31
- Info Menu (Display Only).....34
- Reset Menu .....35

## 1 Selecting from the top menu

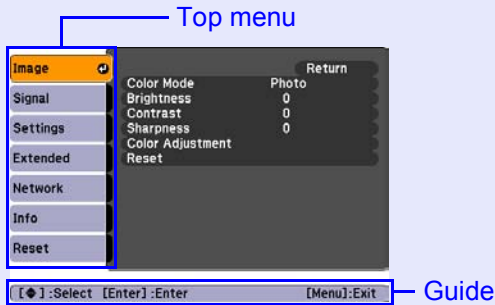

## 2 Selecting from the sub menu

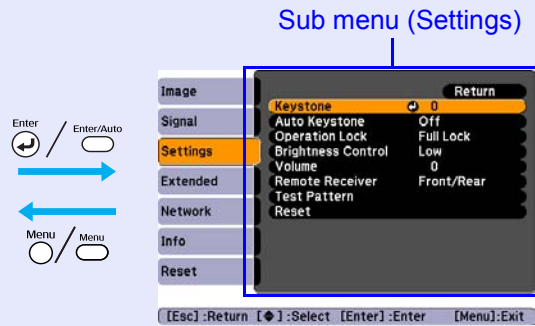

## 3 Changing the selected item

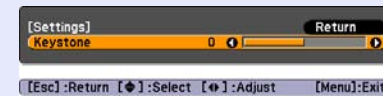

For EMP-83/822/X5



For EMP-S5



Select the setting to change

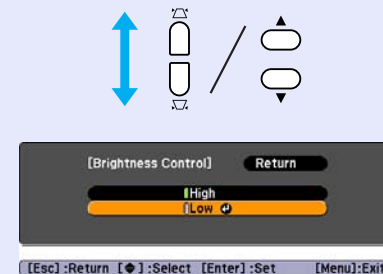

## 4 Exit

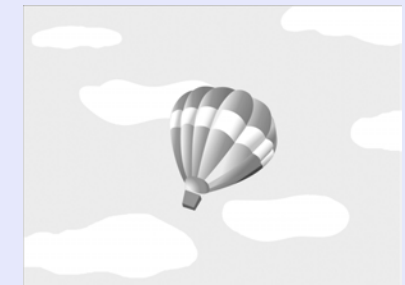

### Buttons used

Using the control panel

For EMP-83/822/X5      For EMP-S5

Using the remote control

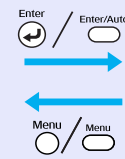
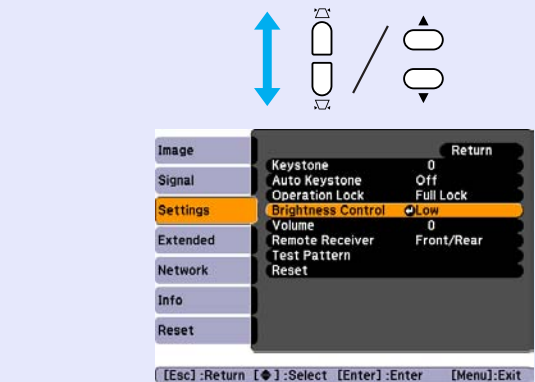

## Image Menu (EMP-83/822 Only)

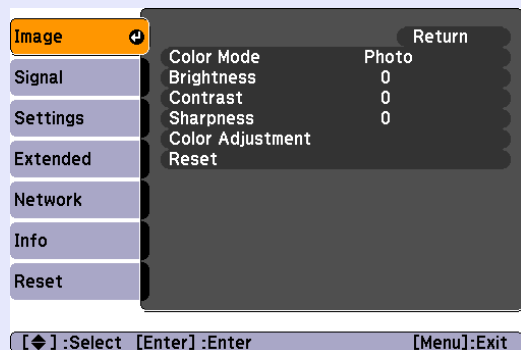

Items that can be set vary depending on the image signal currently being projected as shown in the following screen shots. Setting details are saved for each image signal.

### Computer image

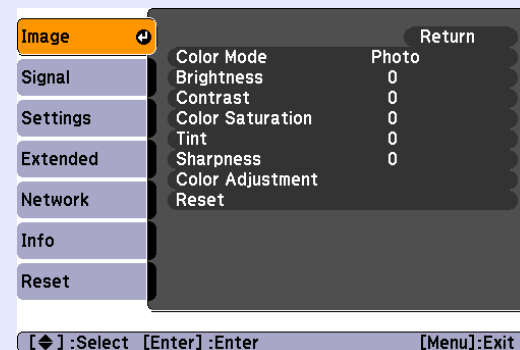

### Component video»/Composite video»/S-video»



Sub Menu	Function
Color Mode	You can select the quality of the image to suit your surroundings.  <a href="#">p.14</a>
Brightness	You can adjust the image brightness.
<u>Contrast</u> »»	You can adjust the difference between light and shade in the images.
Color Saturation	You can adjust the color saturation for the images.
Tint	(Adjustment is only possible when NTSC signals are being input if you use composite video/S-video.) You can adjust the image tint.
Sharpness	You can adjust the image sharpness.
Color Adjustment	You can make adjustments by choosing one of the following <b>Abs. Color Temp.:</b> You can adjust the overall tint of the image. You can adjust tints in 10 stages from 5000 K to 10000 K. When a high value is selected the image becomes tinged with blue, and when a low value is selected the image becomes tinged with red. <b>Red, Green, Blue:</b> You can adjust the saturation of each color individually. (This item cannot be selected if "sRGB" is selected as the "Color Mode" setting in the "Image" menu.)
Reset	You can reset all adjustment values in the "Image" menu to their default settings. To return all menu items to their default settings, see  <a href="#">p.35</a>



## Image Menu (EMP-X5/S5 Only)

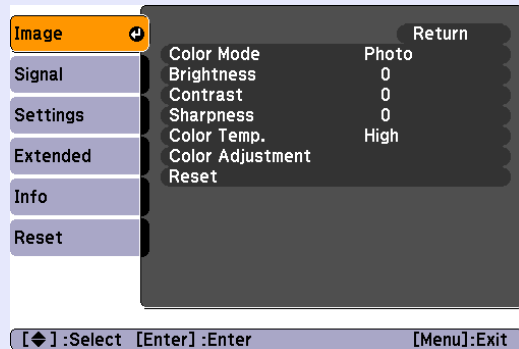

Items that can be set vary depending on the image signal currently being projected as shown in the following screen shots. Setting details are saved for each image signal.

### Computer image

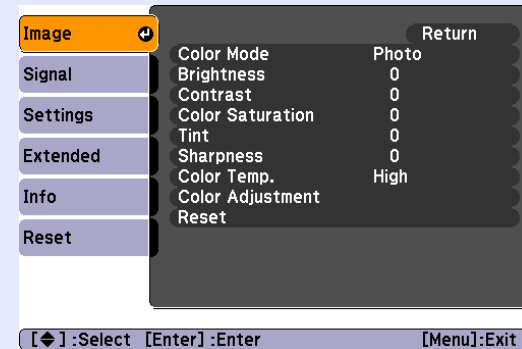

### Component video»/Composite video»/S-video»



Sub Menu	Function
Color Mode	You can select the quality of the image to suit your surroundings.  <a href="#">p.14</a>
Brightness	You can adjust the image brightness.
<u>Contrast</u> »	You can adjust the difference between light and shade in the images.
Color Saturation	You can adjust the color saturation for the images.
Tint	(Adjustment is only possible when NTSC signals are being input if you use composite video/S-video.) You can adjust the image tint.
Sharpness	You can adjust the image sharpness.
Color Temp.	You can adjust the overall tint of the image. When "High" is selected the image becomes tinged with blue, and when "Low" is selected the image becomes tinged with red. (This item cannot be selected if " <u>sRGB</u> »" is selected as the "Color Mode" setting in the "Image" menu.)
Color Adjustment	<b>Red, Green, Blue:</b> You can adjust the saturation of each color individually. (This item cannot be selected if " <u>sRGB</u> »" is selected as the "Color Mode" setting in the "Image" menu.)
Reset	You can reset all adjustment values in the "Image" menu to their default settings. To return all menu items to their default settings, see  <a href="#">p.35</a>

## Signal Menu (EMP-83/822 Only)

Items that can be set vary depending on the image signal currently being projected as shown in the following screen shots. Setting details are saved for each image signal.

### Computer image

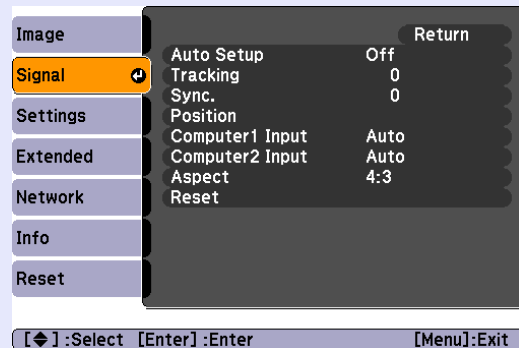



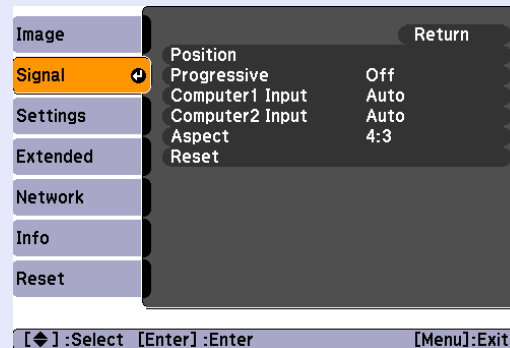

### Component video

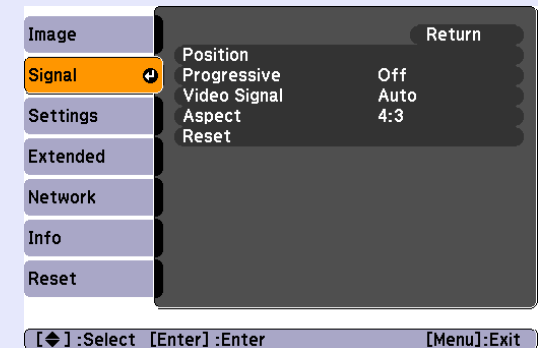

### Composite video/S-video



Sub Menu	Function
Auto Setup	You can select whether the image is automatically adjusted to the optimum state (On) or not (Off) when the input signal changes.  <a href="#">p.44</a>
Tracking	You can adjust computer images when vertical stripes appear in the images.  <a href="#">p.44</a>
Sync.	You can adjust computer images when flickering, fuzziness, or interference appear in the images.  <a href="#">p.44</a>
Position	You can adjust the display position up, down, left, and right so that all of the image is projected if a part of the image is missing.
Progressive	(Component video can only be adjusted when 480i/576i signals are being input) Off: IP conversion is carried out for each field in the screen. This is ideal for viewing images with a large amount of movement. On: <u>interlace</u> (i) signals are converted into <u>progressive</u> (p) signals. This is ideal for viewing still images.
Computer1 Input	You can select the input signal from the Computer1 input port or Computer2 input port. If set to "Auto" the input signal is set automatically according to the connected equipment.
Computer2 Input	If colors do not appear correctly when set to "Auto", select the appropriate signal according to the connected equipment.
Video Signal	If set to "Auto", video signals are recognized automatically. If interference appears in the image or a problem occurs such as no image is being projected when set to "Auto", select the appropriate signal according to the connected equipment.
Aspect	You can set the <u>aspect ratio</u> for projected images.  <a href="#">p.16</a>
Reset	You can reset all adjustment values in the "Signal" menu to their default settings, except for "Computer1 Input" and "Computer2 Input". To return all menu items to their default settings, see  <a href="#">p.35</a>

## Signal Menu (EMP-X5/S5 Only)

Items that can be set vary depending on the image signal currently being projected as shown in the following screen shots. Setting details are saved for each image signal.

### Computer image

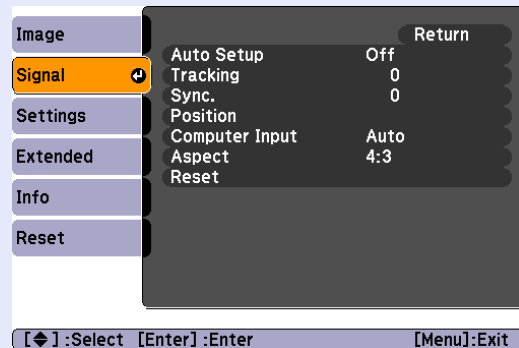



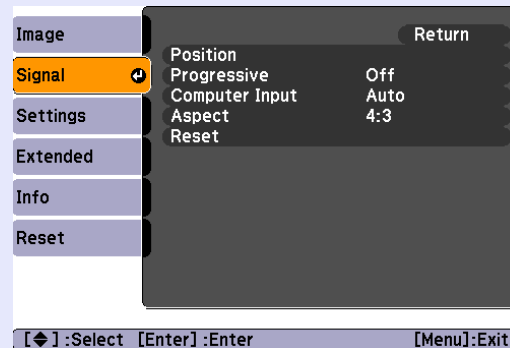

### Component video

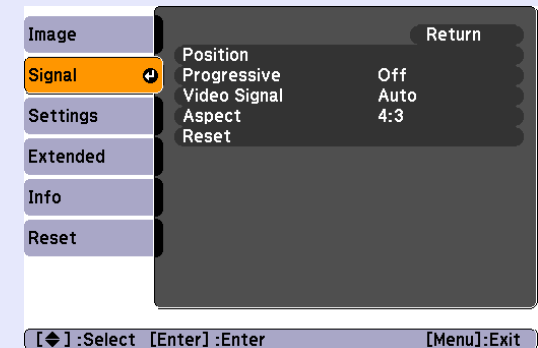

### Composite video/S-video



Sub Menu	Function
Auto Setup	You can select whether the image is automatically adjusted to the optimum state (On) or not (Off) when the input signal changes.  <a href="#">p.44</a>
Tracking	You can adjust computer images when vertical stripes appear in the images.  <a href="#">p.44</a>
Sync.	You can adjust computer images when flickering, fuzziness, or interference appear in the images.  <a href="#">p.44</a>
Position	You can adjust the display position up, down, left, and right so that all of the image is projected if a part of the image is missing.
Progressive	(Component video can only be adjusted when 480i/576i signals are being input) Off: IP conversion is carried out for each field in the screen. This is ideal for viewing images with a large amount of movement. On: <u>interlace</u> (i) signals are converted into <u>progressive</u> (p) signals. This is ideal for viewing still images.
Computer Input	You can select the input signal from the Computer input port. If set to "Auto" the input signal is set automatically according to the connected equipment. If colors do not appear correctly when set to "Auto", select the appropriate signal according to the connected equipment.
Video Signal	If set to "Auto", video signals are recognized automatically. If interference appears in the image or a problem occurs such as no image is being projected when set to "Auto", select the appropriate signal according to the connected equipment.
Aspect	You can set the <u>aspect ratio</u> for projected images.  <a href="#">p.16</a>
Reset	You can reset all adjustment values in the "Signal" menu to their default settings, except for "Computer Input". To return all menu items to their default settings, see  <a href="#">p.35</a>

## Settings Menu

### For EMP-83/822

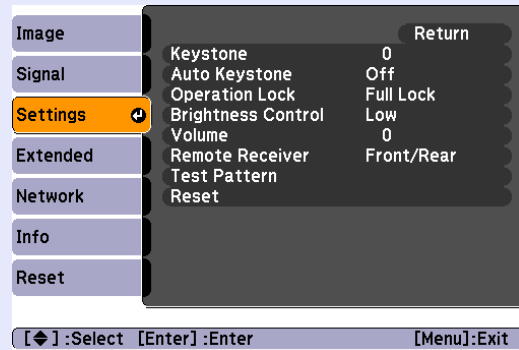



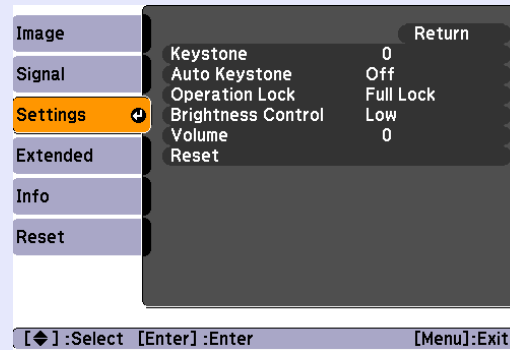

### For EMP-X5

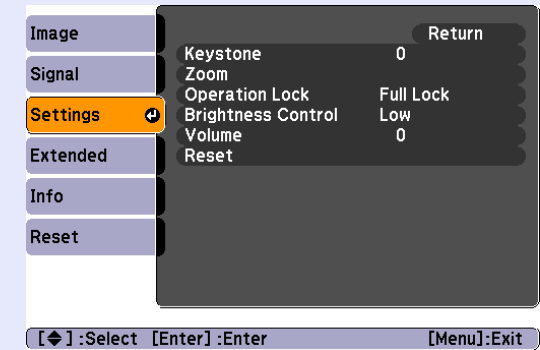

### For EMP-S5



Sub Menu	Function
Keystone	You can correct vertical keystone distortion in images.  <a href="#">Quick Start Guide</a>
Auto Keystone (EMP-83/822/X5 only)	Performs automatic keystone correction. (This can only be specified when "Front" is selected from "Extended" - "Projection".)
Zoom (EMP-S5 only)	Adjusts the image size.  <a href="#">Quick Start Guide</a> Wide: Larger Tele: Smaller
Operation Lock	You can use this to restrict operation of the projector's control panel.  <a href="#">p.20</a>
Brightness Control	You can set the lamp brightness to one of two settings. Select "Low" if the images being projected are too bright such as when projecting images in a dark room or onto a small screen. When "Low" is selected, the amount of electricity consumed and the lamp's operating life are changed as follows, and fan rotation noise during projection is reduced. Electrical consumption: about a 35 W decrease, lamp life: about 1.5 times longer
Volume	You can adjust the volume.
Remote Receiver (EMP-83/822 only)	You can limit the reception of the operation signal from the remote control. When you want to prohibit operation by remote control, or if the remote receiver has a fluorescent light too close to it , you can make settings to deactivate the remote receiver that you do not want to use or that is experiencing interference.
Test Pattern (EMP-83/822 only)	When the projector is setup, a test pattern is displayed so that you can adjust the projection without connecting other equipment. While the test pattern is displayed you can perform zoom adjustments, focus adjustments, and keystone correction. To cancel the test pattern, press the [Esc] button on the remote control or the control panel.
Reset	You can reset all adjustment values in the "Settings" menu to their default settings. To return all menu items to their default settings, see  <a href="#">p.35</a>

## Extended Menu

### For EMP-83/822

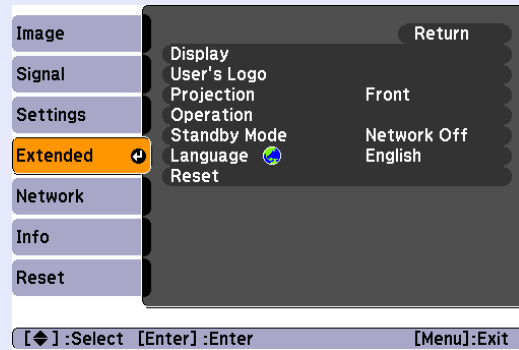

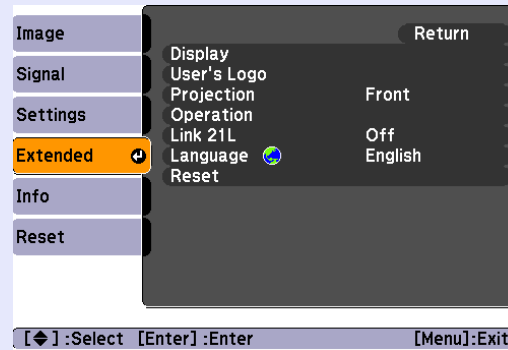

### For EMP-X5/S5

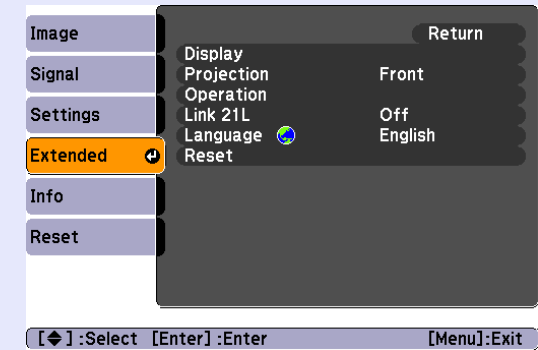

### For EMP-X5/S5 (Euro)



Sub Menu	Function
Display	<p>You can make settings related to the projector's display.</p> <p><b>Messages:</b> You can set whether to display (On) or not display (Off) the source name when you change the input source, the color mode name when you change the Color Mode, a message when no image signal is input, and so on.</p> <p><b>Display Background</b>*1: You can set the screen status for when no image signal is available to "Black", "Blue", or "Logo".</p> <p><b>Startup Screen</b>*1: You can set whether the startup screen (the image projected when starting the projector) is displayed (On) or not (Off).</p> <p><b>A/V Mute</b>*1: You can set the screen displayed during A/V Mute as "Black", "Blue", or "Logo".</p>
User's Logo*1	<p>You can change the user's logo that is displayed as a background and displayed during A/V Mute.  <a href="#">p.57</a></p>
Projection	<p>You can choose one of the following settings according to the way the projector is setup.  <a href="#">p.49</a></p> <p>Front "Front/Ceiling" "Rear" "Rear/Ceiling"</p> <p>You can change the setting as follows by pressing down the [A/V Mute] button on the remote control for about five seconds.</p> <p>Front ↔ "Front/Ceiling"</p> <p>Rear ↔ "Rear/Ceiling"</p>



Sub Menu	Function
Operation	<p><b>Direct Power On:</b> You can set whether Direct Power On is enabled (On) or disabled (Off). When it is set to "On" and the projector power cable is connected to an electrical outlet, be aware that sudden surges of electricity may cause the projector to turn on automatically.</p> <p><b>Sleep Mode:</b> When set to "On", this turns off the power automatically when no image signal is input and no operations are performed. Sleep mode is set to (Off) at the time of purchase, so do not forget to turn off the power after projecting.</p> <p><b>Sleep Mode Time:</b> When Sleep Mode is set to "On", you can set how long the projector should wait before turning off the power from 1 to 30 minutes.</p> <p><b>Lens Cover Timer:</b> When set to "On", this turns off the power automatically 30 minutes after the lens cover is closed. Lens Cover Timer is set to (On) at the time of purchase.</p> <p><b>High Altitude Mode:</b> Set this to "On" when using the projector above an altitude of 1500 m.</p>
Standby Mode (EMP-83/822 only)	<p>You can use network monitoring and control functions while the projector is in standby mode when this is set to "Network On". You can use <a href="#">SNMP</a> to monitor and control the status of the projector over the network, or by using the "EMP Monitor" software supplied with this product.</p>
<a href="#">Link 21L</a> (EMP-X5/S5 only)	<p>You can set whether to use the utility software EMP Link 21L (On) or not (Off). Set this to "On" and use it after installing the USB communication driver.</p>
Language	<p>You can set the language for message displays.</p>
Reset	<p>You can reset "Display<sup>*1</sup>" and "Operation<sup>*2</sup>" in the "Extended" menu to their default settings. To return all menu items to their default settings, see <a href="#">p.35</a></p>

\*1 When "User's Logo Protect" is set to "On" in "Password Protect", settings concerning user's logo cannot be changed. You can make changes after setting "User's Logo Protect" to "Off". [p.19](#)

Depending on the area of purchase, the User's Logo function may not be available for EMP-X5/S5. In that case, "User's Logo" is not displayed.



\*2 Except for "High Altitude Mode".

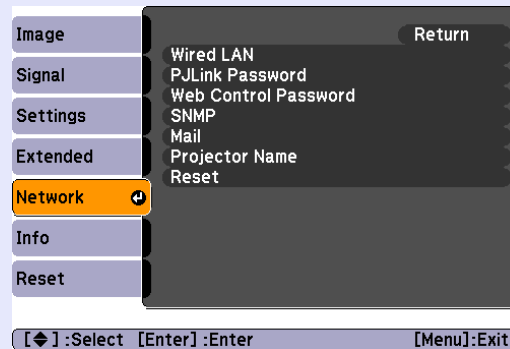

## Network Menu (EMP-83/822 Only)

When "Network Protect" is set to "On" in "Password Protect", a message is displayed and the settings cannot be changed. You can make changes after setting "Network Protect" to "Off".  [p.19](#)



Sub Menu	Function
Wired LAN	<p>You can make network settings.</p> <p><b>DHCP:</b> You can set whether to use DHCP (On) or not (Off). If this is set to "On" you cannot set any more addresses.</p> <p><b>IP Address:</b> You can input the IP address assigned to the projector.*<sup>1</sup> You can enter a number from 0 to 255 in each field of the address. However, the following IP addresses cannot be used. 0.0.0.0, 0.x.x.x, 127.x.x.x, 224.0.0.0 to 255.255.255.255 (where x is a number from 0 to 255)</p> <p><b>Subnet Mask:</b> You can input the Subnet Mask for the projector.*<sup>1</sup> You can enter a number from 0 to 255 in each field of the address. However, the following subnet masks cannot be used. 0 to 254.x.x.x. 255.255.255.255</p> <p><b>Gateway Address:</b> You can input the IP address for the gateway for the projector.*<sup>1</sup> You can enter a number from 0 to 255 in each field of the address. However, the following gateway addresses cannot be used. 0.0.0.0, 127.x.x.x, 224.0.0.0 to 255.255.255.255 (where x is a number from 0 to 255)</p> <p><b>MAC Address:</b> You can input the MAC Address for the projector.</p>
PJLink Password	<p>Enter a password to use when you access the projector using compatible PJLink software.*<sup>1</sup>  <a href="#">p.69</a></p> <p>You can enter up to 32 alphanumeric characters.</p>
Web Control Password	<p>Enter a password to use when making settings and controlling the projector using Web control.*<sup>1</sup> You can enter up to 8 alphanumeric characters.</p> <p>Web control is a computer function that allows you to set up and control the projector by using the Web browser on a computer on which EMP Monitor is running.  <a href="#">EMP Monitor Operation Guide</a></p>



Sub Menu	Function
SNMP▶▶	<p>You can make SNMP settings.</p> <p><b>Trap IP Address 1/Trap IP Address 2:</b> You can register up to two IP addresses for the SNMP trap notification destination. The IP address registered in "Trap IP Address 2" is used when the IP address in "Trap IP Address 1" cannot be accessed. To use SNMP to monitor the projector, you need to install the SNMP manager program on your computer. SNMP should be managed by a network administrator.</p>
Mail	<p>When this is set, you are notified by e-mail if a problem or warning occurs with the projector.*2</p> <p><b>Mail Notification:</b> You can set whether to be notified by mail (On) or not (Off).</p> <p><b>SMTP Server:</b> You can input the IP address for the SMTP server for the projector.*1</p> <p>You can enter a number from 0 to 255 in each field of the address. However, the following IP addresses cannot be used. 127.x.x.x, 224.0.0.0 to 255.255.255.255 (where x is a number from 0 to 255)</p> <p><b>Port Number:</b> You can input the port number for the SMTP server.*1</p> <p>The initial value is 25. You can input numbers between 1 to 65535.</p> <p><b>Destination Address 1/Destination Address 2/Destination Address 3:</b> You can enter*1 the destination mail address and the contents of the message to receive notification when a problem or warning occurs. You can register up to three destinations. You can enter up to 32 single-byte alphanumeric characters for the mail addresses.</p>
Projector Name	You can enter a name for the projector. When connected to a network, this name is used to identify the projector.
Reset	<p>You can reset all adjustment values in the "Network" menu to their default settings.</p> <p>To return all menu items to their default settings, see  p.35</p>

\*1 When inputting numbers and passwords, the following software keyboard is displayed. Tilt the [▲], [▼], [◀], and [▶] buttons on the remote control to move the cursor to the target key, and press the [Enter] button to input. After entering characters, press [Finish] on the keyboard to confirm your entry. Press [Cancel] on the keyboard to cancel your input.

Each time this key is selected, it sets and changes between upper case and lower case letters.

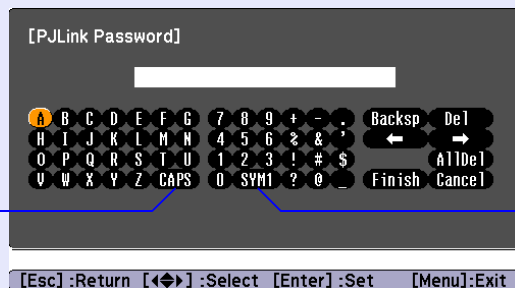

Each time this key is selected, it sets and changes the symbol keys for the section enclosed by the frame.

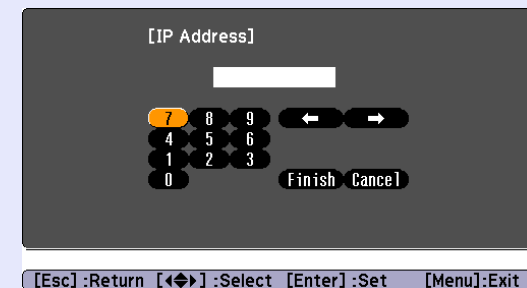



\*2 When the Mail Notification function is set to "On" and a problem or warning occurs with a projector, the following mail is sent.

Subject: EPSON Projector

First line: The name of the projector where the problem has occurred

Second line: The IP address set for the projector where the problem has occurred

Third line and on: Details of the problem

The details of the problem are listed line by line. The following table explains the details shown in the message.

For details on dealing with problems, see "Reading the Indicators".  [p.38](#)

Message	Cause
Internal error	Internal Error
Fan related error	Fan Error
Sensor error	Sensor Error
Lamp cover is open.	Lamp Cover Open
Lamp timer failure	Lamp Failure
Lamp out	Lamp Error
Internal temperature error	High Temp Error (Overheating)
High-speed cooling in progress	High Temp Warning
Lamp replacement notification	Replace Lamp
No-signal	No signal No image signal is being input to the projector. Check the connection status and the power supply to connected equipment.

A (+) or (-) will appear at the start of the message.

(+): A projector problem has occurred

(-): A projector problem has been dealt with



## Info Menu (Display Only)

Lets you check the status of the image signals being projected and the status of the projector. Items displayed vary depending on the image signal currently being projected as shown in the following screen shots.

### Computer image/Component video»

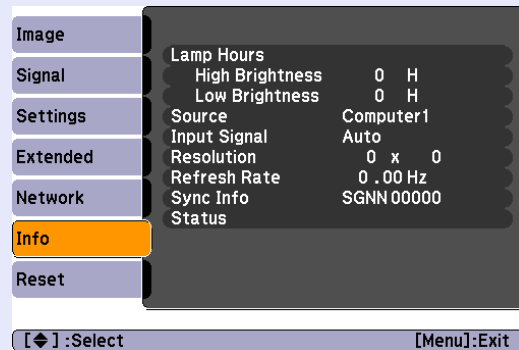

### Composite video»/S-video»

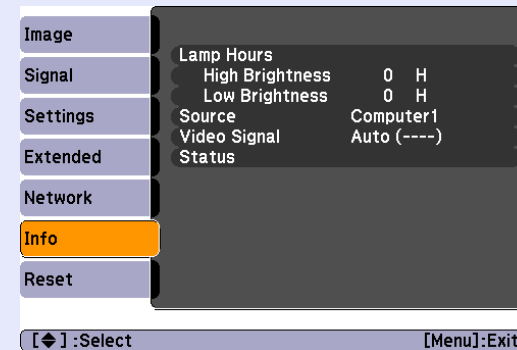

Sub Menu	Function
Lamp Hours	You can display the cumulative lamp operating time*. When it reaches the lamp warning time, the characters are displayed in yellow.
Source	You can display the input port name for the connected equipment currently being projected.
Input Signal	You can display the content of "Computer1" or "Computer2" set in the "Signal" menu according to the "Source".
Resolution	You can display the input resolution.
Video Signal	You can display the content of "Video Signal" set in the "Signal" menu.
<u>Refresh Rate</u> »	You can display the refresh rate.
<u>Sync</u> » Info	You can display the image signal information. This information may be needed if service is required.
Status	This is information about problems that have occurred on the projector. This information may be needed if service is required.

\* The cumulative use time is displayed as "0H" for the first 10 hours. After 10 hours or more, one hour is added for each subsequent hour.

## Reset Menu

### For EMP-83/822

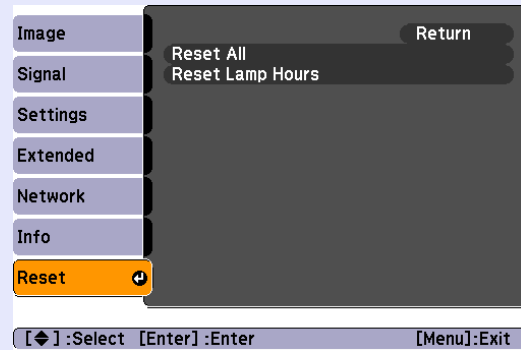

### For EMP-X5/S5

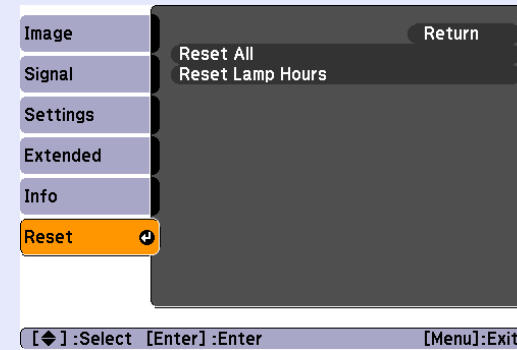

Sub Menu	Function
Reset All (EMP-83/822 only)	You can reset all items in all menus to their default settings. The following items are not reset to their defaults: "Computer1 Input", "Computer2 Input", "User's Logo", all items in "Network" menu, "Lamp Hours", and "Language".
Reset All (EMP-X5/S5 only)	You can reset all items in all menus to their default settings. The following items are not reset to their defaults: "Computer Input", "Zoom" (EMP-S5 only), "User's Logo*", "Lamp Hours", and "Language".
Reset Lamp Hours	You can clear the cumulative Lamp Hours use time, and return it to "0H". Reset it when you replace the lamp.

\* Depending on the area of purchase, the User's Logo function may not be available for EMP-X5/S5. In that case, "User's Logo" is not displayed.



# Troubleshooting

This chapter describes how to identify problems and what to do if a problem is found.

<b>Using the Help.....</b>	<b>37</b>
<b>Problem Solving .....</b>	<b>38</b>
• <b>Reading the Indicators.....</b>	<b>38</b>
⏻ Power indicator lights red .....	39
🔊 ⚠ Indicator is lit or flashing orange.....	40
• <b>When the Indicators Provide No Help .....</b>	<b>41</b>
Problems relating to images .....	42
Problems when projection starts.....	46
Other problems .....	46

If a problem occurs with the projector, Help uses on-screen displays to assist you in solving the problem.

## Procedure

- 1 Press the [Help] button.**  
The help screen is displayed.

Using the remote control

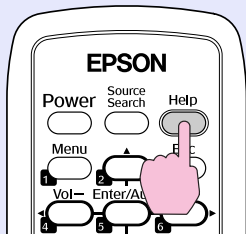

Using the control panel

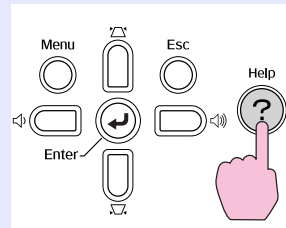

- 2 Select a menu item.**

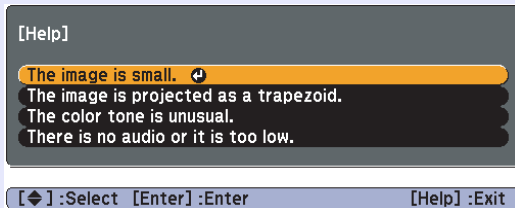

Using the remote control

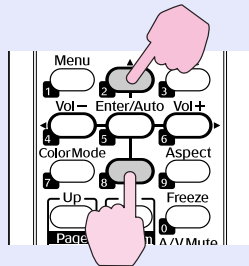

Using the control panel

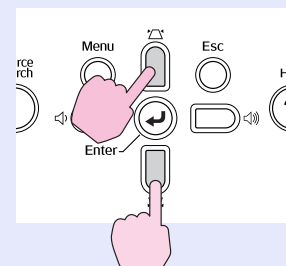

- 3 Confirm the selection.**

Using the remote control

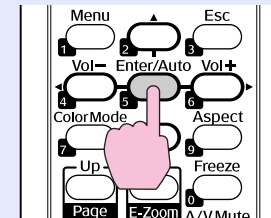

Using the control panel

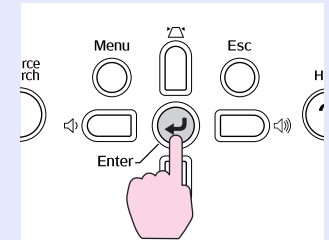

Questions and solutions are displayed as shown on the screen below.  
Press the [Help] button to exit Help.

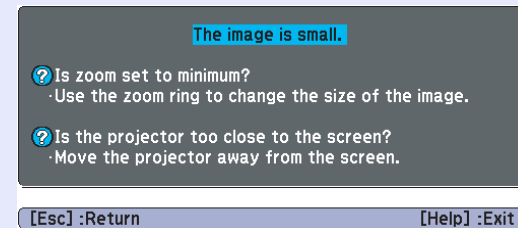

**If Help does not provide a solution to the problem, refer to "Problem Solving" (p.38).**

If you are having a problem with the projector, first check the projector's indicators and refer to "Reading the Indicators" below.  
If the indicators do not show clearly what the problem might be, refer to "When the Indicators Provide No Help".  [p.41](#)

## Reading the Indicators

The projector is provided with the following three indicators that indicate the operating status of the projector.

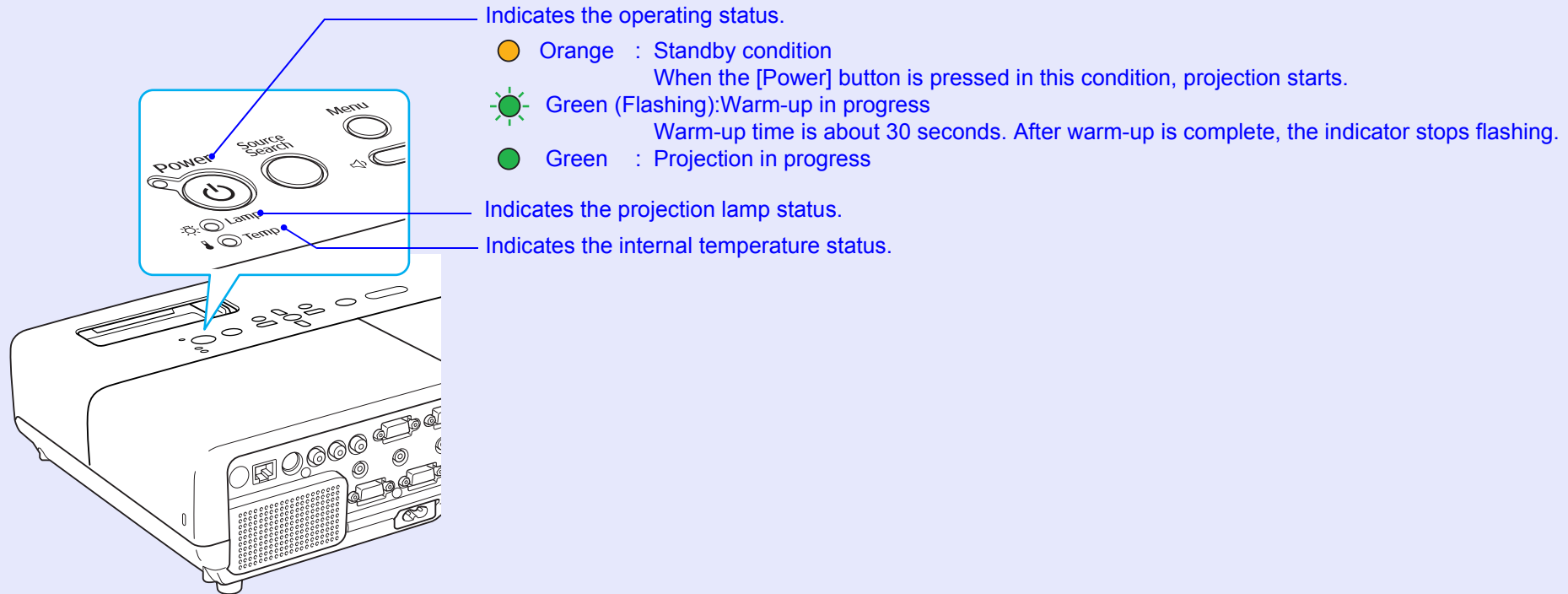

Refer to the following table to see what the indicators mean and how to remedy problems that they indicate.

If all indicators are off, check that the power cable is connected correctly and that the power is being supplied normally.

Sometimes, when the power cable is unplugged, the  indicator remains lit for a short period which is not a fault.

■ Power indicator lights red **Problem**

: Lit : Flashing: : Off

Status	Cause	Remedy or Status
Red Red Red	Internal Error	Stop using the projector, disconnect the power cable from the electrical outlet, and contact your local dealer or the nearest address provided in the <i>International Warranty Terms</i> . <a href="#">Inquiries</a>
Red  Red	Fan Error Sensor Error	Stop using the projector, disconnect the power cable from the electrical outlet, and contact your local dealer or the nearest address provided in the <i>International Warranty Terms</i> . <a href="#">Inquiries</a>
Red  Red	High Temp Error (overheating)	The lamp turns off automatically and projection stops. Wait for about five minutes. After about five minutes the projector switches to standby mode, so check the following two points. <ul style="list-style-type: none"> <li>• Check that the air filter and air exhaust vent are clear, and that the projector is not positioned against a wall.</li> <li>• If the air filter is clogged, clean or replace it.  <a href="#">p.50, 56</a></li> </ul> If the error continues after checking the points above, stop using the projector, disconnect the power cable from the electrical outlet, and contact your local dealer or the nearest address provided in the <i>International Warranty Terms</i> . <a href="#">Inquiries</a>
		When using at an altitude of 1500 m or more, set "High Altitude Mode" to "On". <a href="#">p.30</a>
Red Red 	Lamp Error Lamp Failure Lamp Cover Open	<p><b>Check the following two points.</b></p> <ul style="list-style-type: none"> <li>• Take out the lamp and check if it is cracked.  <a href="#">p.53</a></li> <li>• Clean the air filter.  <a href="#">p.50</a></li> </ul> <p><b>If it is not cracked</b> - Re-fit the lamp and turn on the power.  <b>If the error continues</b> - Replace the lamp with a new lamp and turn on the power.  <b>If the error continues</b> - Stop using the projector, disconnect the power cable from the electrical outlet, and contact your local dealer or the nearest address provided in the <i>International Warranty Terms</i>.  <a href="#">Inquiries</a></p> <p><b>If it is cracked</b> - Replace it with a new lamp, or contact your local dealer for further advice. If replacing the lamp yourself, be careful to avoid pieces of broken glass (you cannot continue projecting until the lamp is replaced).  <a href="#">Inquiries</a></p> <p>Check that the lamp cover and the lamp are securely installed.  <a href="#">p.53</a>                      If the lamp cover or the lamp is not securely installed, the lamp does not switch on.</p>
		When using at an altitude of 1500 m or more, set "High Altitude Mode" to "On". <a href="#">p.30</a>

■ Indicator is lit or flashing orange **Warning**

● : Lit : Flashing ○ : Off ◐ : Varies according to the projector status

Status	Cause	Remedy or Status
● Red ○ Orange	High Temp Warning	(This is not a problem. However, if the temperature rises too high again, projection stops automatically.) <ul style="list-style-type: none"> <li>• Check that the air filter and air exhaust vent are clear, and that the projector is not positioned against a wall.</li> <li>• If the air filter is clogged, clean or replace it.  p.50, 56</li> </ul>
◐ Orange ○	Replace Lamp	Replace it with a new lamp.  p.53 If you continue to use the lamp after the replacement period has passed, the possibility that the lamp may explode increases. Replace it with a new lamp as soon as possible.













- *If the projector is not operating properly, even though the indicators are all showing normal, refer to "When the Indicators Provide No Help" ( p.41).*
- *If an indicator is displaying a status not described in the tables, contact your local dealer or the nearest address provided in the International Warranty Terms. [Inquiries](#)*



## When the Indicators Provide No Help

If any of the following problems occur and the indicators do not offer a solution, refer to the pages given for each problem.



### Problems relating to images

- **No images appear**  [p.42](#)  
Projection does not start, the projection area is completely black, the projection area is completely blue, and so on.
- **Moving images are not displayed**  [p.42](#)  
Moving images being projected from a computer appear black and nothing is projected.
- **Projection stops automatically**  [p.42](#)
- **The message "Not supported." is displayed**  [p.43](#)
- **The message "No Signal." is displayed**  [p.43](#)
- **Images are fuzzy or out of focus**  [p.43](#)
- **Interference or distortion appears in images**  [p.44](#)  
Problems such as interference, distortion, or black & white checked patterns appear.
- **The image is truncated (large) or small, or the aspect is not suitable**  [p.44](#)  
Only part of the image is displayed, or the height and width ratios of the image are not correct, and so on.
- **Image colors are not right**  [p.45](#)  
The whole image appears purplish or greenish, images are black & white, colors appear dull, and so on.  
(Computer monitors and LCD screens have different color reproduction performance, so the colors projected by the projector and the colors appearing on the monitor may not necessarily match, but this is not a sign of a problem.)
- **Images appear dark**  [p.45](#)
- **Nothing appears on the external monitor**  [p.45](#)

### Problems when projection starts

- **Power does not turn on**  [p.46](#)



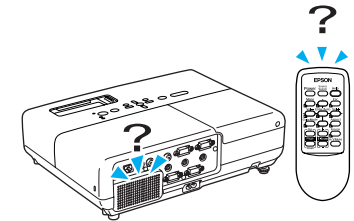

### Other problems

- **No sound can be heard or the sound is faint**  [p.46](#)
- **The remote control does not work**  [p.47](#)
- **Mail is not received even if a problem occurs with the projector (EMP-83/822 Only)**  [p.47](#)



■ Problems relating to images

■ No images appear

Check	Remedy
Did you press the [Power] button?	Press the [Power] button to turn the power on.
Are the indicators switched off?	The power cable is not connected correctly or power is not being supplied normally. Connect the projector's power cable correctly.  <i>Quick Start Guide</i> Check that your electrical outlet or power source is functioning correctly.
Is A/V Mute active?	Press the [A/V Mute] button on the remote control to cancel A/V Mute.  <a href="#">p.15</a>
Is the A/V mute slide closed?	Open the A/V mute slide.
Are the configuration menu settings correct?	Reset all of the settings.  "Reset"- "Reset All" <a href="#">p.35</a>
Is the projected image completely black? <b>Only when projecting computer images</b>	Some input images, such as screen savers, may be completely black.
Is the image signal format setting correct? <b>Only when projecting images from a video source</b>	Change the setting according to the signal for the connected equipment.  "Signal"- "Video Signal" <a href="#">p.26</a>

■ Moving images are not displayed

Check	Remedy
Is the computer's image signal being output to the LCD and the monitor? <b>Only when projecting images from a laptop computer or a computer with a built-in LCD screen</b>	Change the image signal to external output only.  Check your computer's documentation.

■ Projection stops automatically

Check	Remedy
Is "Sleep Mode" set to "On"?	Press the [Power] button to turn the power on. If you do not want to use "Sleep Mode", change the setting to "Off".  "Extended"- "Operation"- "Sleep Mode" <a href="#">p.30</a>

■ The message "Not supported." is displayed

Check	Remedy
Is the image signal format setting correct? <b>Only when projecting images from a video source</b>	Change the setting according to the signal for the connected equipment. 🖱️ "Signal"- "Video Signal" p.26
Do the image signal resolution and the refresh rate correspond to the mode? <b>Only when projecting computer images</b>	Refer to the computer's documentation for how to change the image signal resolution and the refresh rate output from the computer. 🖱️ "List of Supported Monitor Displays" p.70





■ The message "No Signal." is displayed

Check	Remedy
Are the cables connected correctly?	Check that all the cables required for projection are securely connected. 🖱️ <i>Quick Start Guide</i>
Is the correct input port selected?	Change the image by pressing the [Source Search] button on the remote control or the control panel. 🖱️ p.13
Is the power for the computer or video source turned on?	Turn the power on for the equipment.
Are the image signals being output to the projector? <b>Only when projecting images from a laptop computer or a computer with a built-in LCD screen</b>	If the image signals are only being output to the computer's LCD monitor or to the accessory monitor, you need to change the output to an external destination as well as the computer's own monitor. For some computer models, when the image signals are output externally, they no longer appear on the LCD monitor or accessory monitor. 🖱️ Computer's documentation, under a title such as "External output" or "Connecting an external monitor". If the connection is made while the power of the projector or computer is already turned on, the function [Fn] key that changes the computer's image signal to external output may not work. Turn the power for the computer and the projector off and then back on again. 🖱️ <i>Quick Start Guide</i>





■ Images are fuzzy or out of focus

Check	Remedy
Is the focus adjusted correctly?	Turn the focus ring to adjust the focus. 🖱️ <i>Quick Start Guide</i>
Is the projector at the correct distance?	For EMP-83/822/X5, the recommended projection distance for Wide ranges from 84 to 867 cm, and for Tele from 101 to 1041 cm. For EMP-S5, the recommended projection distance ranges from 87 to 1050 cm. Setup within this range. 🖱️ p.59
Is the Keystone adjustment value too large?	Lower the projection angle to reduce the amount of keystone correction. 🖱️ <i>Quick Start Guide</i>
Has condensation formed on the lens?	If the projector is suddenly taken from a cold environment to a warm environment, or if sudden ambient temperature changes occur, condensation may form on the surface of the lens, and this may cause the images to appear fuzzy. Set the projector up in the room about one hour before it is used. If condensation forms on the lens, turn the projector off and wait for the condensation to disappear.

■ Interference or distortion appear in images

Check	Remedy
Is the image signal format setting correct? <b>Only when projecting images from a video source</b>	Change the setting according to the signal for the connected equipment.  "Signal"- "Video Signal" <a href="#">p.26</a>
Are the cables connected correctly?	Check that all the cables required for projection are securely connected.  <a href="#">Quick Start Guide</a>
Is an extension cable being used?	If an extension cable is used, electrical interference may affect the signals. Use the cables supplied with the projector to check if the cables you are using may be causing the problem.
Is the correct resolution selected? <b>Only when projecting computer images</b>	Set the computer so that the signals being output are compatible with the projector.  "List of Supported Monitor Displays" <a href="#">p.70</a>  Computer documentation
Are the "Sync.▶▶" and "Tracking▶▶" settings adjusted correctly? <b>Only when projecting computer images</b>	Press the [Auto] button on the remote control or the [Enter] button on the control panel to perform automatic adjustment. If the images are not adjusted correctly after using automatic adjustment, you can make the adjustments from "Sync." and "Tracking" in the configuration menu.  "Signal"- "Tracking", "Sync." <a href="#">p.26</a>

■ The image is truncated (large) or small, or the aspect is not suitable

Check	Remedy
Is a wide panel computer image being projected? <b>Only when projecting computer images</b>	Press the [Aspect] button on the remote control to change the aspect mode in the order of "Normal", "4:3", and "16:9". Change the aspect mode according to the resolution.
Is the image still being enlarged by E-Zoom?	Press the [Esc] button on the remote control to cancel E-Zoom.  <a href="#">p.17</a>
Is "Position" adjusted correctly?	Press the [Auto] button on the remote control or the [Enter] button on the control panel to perform automatic adjustment of the computer image being projected. If the images are not adjusted correctly after using automatic adjustment, you can make the adjustments from "Position" in the configuration menu. Apart from computer image signals, you can adjust other signals while projecting by adjusting "Position" in the configuration menu.  "Signal"- "Position" <a href="#">p.26</a>
Is the computer set for dual display? <b>Only when projecting computer images</b>	If dual display is activated in the "Display Properties" of the computer's control panel, only about half of the image on the computer screen is projected. To display the entire image on the computer screen, turn off the dual display setting.  Computer video driver documentation
Is the correct resolution selected? <b>Only when projecting computer images</b>	Set the computer so that the signals being output are compatible with the projector.  "List of Supported Monitor Displays" <a href="#">p.70</a>  Computer documentation

**Image colors are not right**

Check	Remedy
Do the input signal settings match the signals from the connected device?	Change the following settings according to the signal for the connected equipment. When projecting images from equipment connected to Computer1, Computer, or Computer2 Input, see <a href="#">"Signal"- "Computer1/2 Input" p.26</a> When projecting images from equipment connected to Video or S-Video, see <a href="#">"Signal"- "Video Signal" p.26</a>
Is the image brightness adjusted correctly?	Adjust the "Brightness" setting in the configuration menu. <a href="#">"Image"- "Brightness" p.24</a>
Are the cables connected correctly?	Check that all the cables required for projection are securely connected. <a href="#">Quick Start Guide</a>
Is the " <u>Contrast</u> " setting adjusted correctly?	Adjust the "Contrast" setting in the configuration menu. <a href="#">"Image"- "Contrast" p.24</a>
Is the color adjusted correctly?	Adjust the "Color Adjustment" setting in the configuration menu. <a href="#">"Image"- "Color Adjustment" p.24</a>
Are the color saturation and tint adjusted correctly?	Adjust the "Color Saturation" and "Tint" settings in the configuration menu. <a href="#">"Image"- "Color Saturation", "Tint" p.24</a>
<b>Only when projecting images from a video source</b>	

**Images appear dark**





Check	Remedy
Are the image brightness and luminance adjusted correctly?	Adjust the "Brightness" and "Brightness Control" settings in the configuration menu. <a href="#">"Image"- "Brightness" p.24</a> <a href="#">"Settings"- "Brightness Control" p.28</a>
Is the " <u>Contrast</u> " setting adjusted correctly?	Adjust the "Contrast" setting in the configuration menu. <a href="#">"Image"- "Contrast" p.24</a>
Is the lamp due for replacement?	When the lamp is nearly ready for replacement, the images become darker and the color quality becomes poorer. When this happens, replace the lamp with a new lamp. <a href="#">p.52</a>

**Nothing appears on the external monitor**

Check	Remedy
Are images from a port other than the Computer1 or Computer Input port being projected?	The only images that can be displayed on an external monitor are computer images from the Computer1 or Computer Input port. <a href="#">p.61</a>



■ **Problems when projection starts**

■ **Power does not turn on**

Check	Remedy
Did you press the [Power] button?	Press the [Power] button to turn the power on.
Are the indicators switched off?	The power cable is not connected correctly or power is not being supplied normally. Connect the projector's power cable correctly.  <a href="#">Quick Start Guide</a> Check that your electrical outlet or power source is functioning correctly.
Do the indicators turn on and off when the power cable is touched?	There is probably a poor contact in the power cable, or the power cable may be defective. Reinsert the power cable. If this does not solve the problem, stop using the projector, disconnect the power cable from the electrical outlet, and contact your local dealer or the nearest address provided in the <i>International Warranty Terms</i> .  <a href="#">Inquiries</a>
Is the operation lock set to "Full Lock"?	When you press and hold down the [Enter] button on the control panel for about seven seconds, a message is displayed and the lock is released.  <a href="#">p.20</a>
Is the correct setting for the remote receiver selected? (EMP-83/822 only)	Check the "Remote Receiver" in the configuration menu.  "Settings"- "Remote receiver" <a href="#">p.28</a>
Was the power cable plugged back in immediately after Direct Power Off, or is the breaker turned off? (EMP-83/822 only)	When the operation to the left is performed when "Direct Power On" is set to "On", the power may not turn back on. Press the [Power] button to turn the power back on.

■ **Other problems**

■ **There is no audio or the audio is too low**

Check	Remedy
Is the audio source connected correctly?	Check that the cable is connected to the Audio port.
Is the volume adjusted to the minimum setting?	Adjust the volume so that sound can be heard.  <a href="#">Quick Start Guide</a>
Is A/V Mute active?	Press the [A/V Mute] button on the remote control to cancel A/V Mute.  <a href="#">p.15</a>
Is the audio cable's specification "No resistance"?	When using a commercially available audio cable, make sure it is labelled "No resistance".

■ The remote control does not work

Check	Remedy
Is the remote control light-emitting area pointing towards the remote receiver on the projector when it is operated?	Point the remote control towards the remote receiver. The operating angle for the remote control is about 30 horizontally, and about 15 vertically. ☛ <a href="#">Quick Start Guide</a>
Is the remote control too far from the projector?	The operating range for the remote control is about 6 m. ☛ <a href="#">Quick Start Guide</a>
Is direct sunlight or strong light from fluorescent lamps shining onto the remote receiver?	Set the projector up in a location where strong light does not shine onto the remote receiver. For EMP-83/822, set the remote receiver to "Off" from "Remote Receiver" in the configuration menu. ☛ "Settings"- "Remote receiver" <a href="#">p.28</a>
Is the correct setting for the remote receiver selected? (EMP-83/822 only)	Check the "Remote Receiver" in the configuration menu. ☛ "Settings"- "Remote receiver" <a href="#">p.28</a>
Are the batteries dead or have the batteries been inserted correctly?	Make sure the batteries are inserted correctly or replace the batteries with new ones if necessary. ☛ <a href="#">p.51</a>
Was a remote control button pressed for more than 30 seconds?	If any of the buttons on the remote control are pressed down for more than 30 seconds, the remote control stops sending signals (remote control's sleep mode). When the button is released, normal remote control operation resumes. This can prevent the batteries from running down accidentally because Sleep Mode operates when the remote control is stored in a bag or if an object is placed on top of it.

■ Mail is not received even if a problem occurs with the projector (EMP-83/822 Only)

Check	Remedy
Is "Standby Mode" set to "Network On"?	To use the Mail Notification function when the projector is in standby, set "Network On" from "Standby Mode" in the configuration menu. ☛ "Extended"- "Standby Mode" <a href="#">p.29</a>
Did a fatal problem occur and the projector come to a sudden stop?	When the projector comes to a sudden stop, mail cannot be sent. If the problem continues, contact your local dealer or the nearest address provided in the <i>International Warranty Terms</i> . ☛ <a href="#">Inquiries</a>
Is power being supplied to the projector?	Check that your electrical outlet or power source is functioning correctly.
Is the LAN cable connected correctly?	Check that the LAN cable is connected correctly. Reconnect it if it is not connected or it is not connected correctly. ☛ <a href="#">p.62</a>
Is "Mail" set correctly in the configuration menu?	Mail notification of problems is sent according to the "Mail" settings in the configuration menu. Check if it is set correctly. ☛ "Network Menu"- "Mail Menu" <a href="#">p.32</a>

# Appendices



This chapter provides information on maintenance procedures to ensure the best level of performance from the projector for a long time to come.

<b>Installation Methods .....</b>	<b>49</b>	<b>Optional Accessories and Consumables .....</b>	<b>64</b>
<b>Cleaning.....</b>	<b>50</b>	Optional accessories.....	64
• <b>Cleaning the Projector's Surface .....</b>	<b>50</b>	Consumables .....	64
• <b>Cleaning the Lens.....</b>	<b>50</b>	<b>Glossary .....</b>	<b>65</b>
• <b>Cleaning the Air Filter and Air Intake Vent .....</b>	<b>50</b>	<b>ESC/VP21 Commands .....</b>	<b>67</b>
<b>Replacing Consumables .....</b>	<b>51</b>	• <b>Command List .....</b>	<b>67</b>
• <b>Replacing the Remote Control Batteries .....</b>	<b>51</b>	• <b>Cable Layouts .....</b>	<b>67</b>
• <b>Replacing the Lamp .....</b>	<b>52</b>	Serial connection (EMP-83/822 Only) .....	67
Lamp replacement period .....	52	• <b>Connecting a USB (EMP-X5/S5 Only) .....</b>	<b>68</b>
How to replace the lamp.....	53	• <b>USB Connection Setup.....</b>	<b>68</b>
Resetting the lamp operating time.....	55	<b>PJLink (EMP-83/822 Only) .....</b>	<b>69</b>
• <b>Replacing the Air Filter .....</b>	<b>56</b>	Non-compatible commands .....	69
Air filter replacement period .....	56	Input names defined by PJLink and corresponding projector	
How to replace the air filter.....	56	connectors.....	69
<b>Saving a User's Logo .....</b>	<b>57</b>	Manufacturer name displayed for "Manufacture name	
<b>Screen Size and Distance .....</b>	<b>59</b>	information query" .....	69
• <b>EMP-83/822/X5 .....</b>	<b>59</b>	Model name displayed for "Product name information query" .....	69
• <b>EMP-S5 .....</b>	<b>60</b>	<b>List of Supported Monitor Displays .....</b>	<b>70</b>
<b>Connecting to External Equipment.....</b>	<b>61</b>	Computer image.....	70
• <b>Connecting to an External Monitor .....</b>	<b>61</b>	Component Video .....	70
• <b>Connecting to External Speakers (EMP-83/822 Only) ..</b>	<b>61</b>	Composite video/S-video.....	70
<b>Connecting a LAN Cable (EMP-83/822 Only) ...</b>	<b>62</b>	<b>Specifications .....</b>	<b>71</b>
<b>Connecting a USB Cable (EMP-X5/S5 Only) ....</b>	<b>63</b>	<b>Appearance.....</b>	<b>75</b>
		<b>Index.....</b>	<b>76</b>



The projector supports the following four different projection methods.

## Warning

- *A special method of installation is required when suspending the projector from a ceiling (ceiling mount). If it is not installed correctly, it could fall causing an accident and injury.*
- *If you use adhesives on the ceiling mount to prevent the screws from loosening, or if you use things such as lubricants or oils on the projector, the projector case may crack causing it to fall from its ceiling mount. This could cause serious injury to anyone under the ceiling mount and could damage the projector. When installing or adjusting the ceiling mount, do not use adhesives to prevent the screws from loosening and do not use oils or lubricants and so on.*

## Attention

*Do not use the projector on its side. This may cause malfunctions to occur.*

- *Project images from in front of the screen.  
(Front projection)*

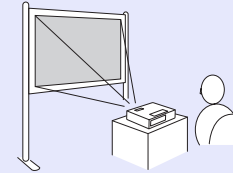

- *Project images from behind a translucent screen.  
(Rear projection)*

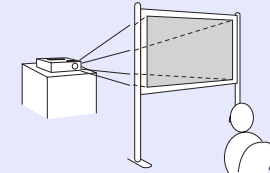

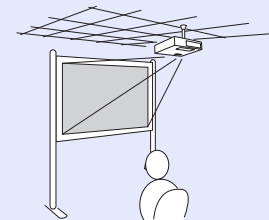

- *Suspend the projector from the ceiling and project images from in front of the screen.  
(Front/Ceiling projection)*

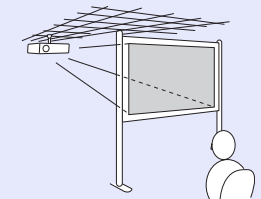

- *Suspend the projector from the ceiling and project images from behind a translucent screen.  
(Rear/Ceiling projection)*



- *An optional ceiling mount is required when suspending the projector from a ceiling.  
 p.64*
- *You can change the setting as follows by pressing down the [A/V Mute] button on the remote control for about five seconds.  
"Front" ↔ "Front/Ceiling"  
Set "Rear" or "Rear/Ceiling" in the configuration menu.  
 p.29*

You should clean the projector if it becomes dirty or if the quality of projected images starts to deteriorate.

## Cleaning the Projector's Surface

Clean the projector's surface by wiping it gently with a soft cloth. If the projector is particularly dirty, moisten the cloth with water containing a small amount of neutral detergent, and then firmly wring the cloth dry before using it to wipe the projector's surface.

### Attention

*Do not use volatile substances such as wax, alcohol, or thinner to clean the projector's surface. The quality of the case may change or become discolored.*

## Cleaning the Lens

Use a commercially available cloth for cleaning glasses to gently wipe the lens.

### Attention

*Do not rub the lens with harsh materials or subject the lens to shocks, as it can easily become damaged.*

## Cleaning the Air Filter and Air Intake Vent

Clean the air filter and the air intake vent when the following message is displayed.

"The projector is overheating. Make sure nothing is blocking the air vent, and clean or replace the air filter."  "How to replace the air filter" [p.56](#)

### Attention

*If dust collects on the air filter it can cause the internal temperature of the projector to rise, and this can lead to problems with operation and shorten the optical engine's service life. Clean the air filter immediately when the message is displayed.*

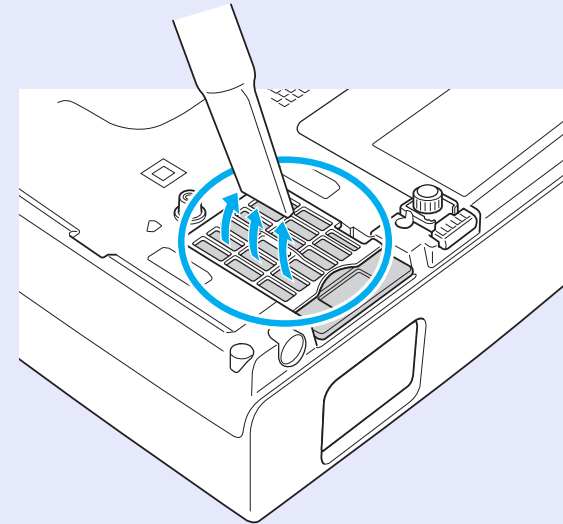

- *If a message is frequently displayed, even after cleaning, it is time to replace the air filter. Replace it with a new air filter.  [p.56](#)*
- *It is recommended that you clean these parts at least once every three months. Clean them more often than this if using the projector in a particularly dusty environment.*

This section explains how to replace the remote control batteries, the lamp, and the air filter.

## Replacing the Remote Control Batteries

If delays in the responsiveness of the remote control occur or if it does not operate after it has been used for some time, it probably means that the batteries are becoming flat. When this happens, replace them with new batteries. Have two spare AA-size manganese dry batteries ready to use when required.

### Attention

*Make sure you read the Safety Instructions/International Warranty Terms before handling the batteries.*  [Safety Instructions](#)

### Procedure

#### 1 Remove the battery cover.

While pushing the battery cover catch, lift the cover up.

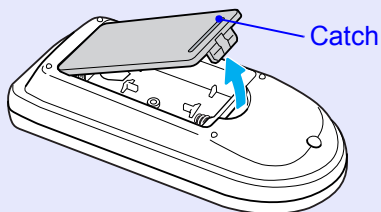

2

#### 2 Replace the old batteries with new batteries.

#### Caution

Check the positions of the (+) and (-) marks inside the battery holder to ensure the batteries are inserted the correct way.

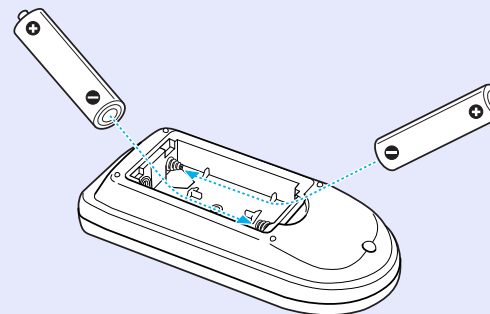

3

#### 3 Replace the battery cover.

Press the battery cover until it clicks into place.

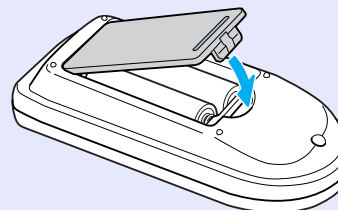

## Replacing the Lamp

### ■ Lamp replacement period

It is time to replace the lamp when:

- The message "Replace the lamp." is displayed.

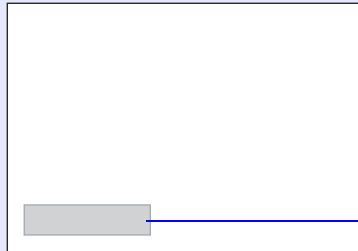

A message is displayed.

- The lamp indicator flashes orange.

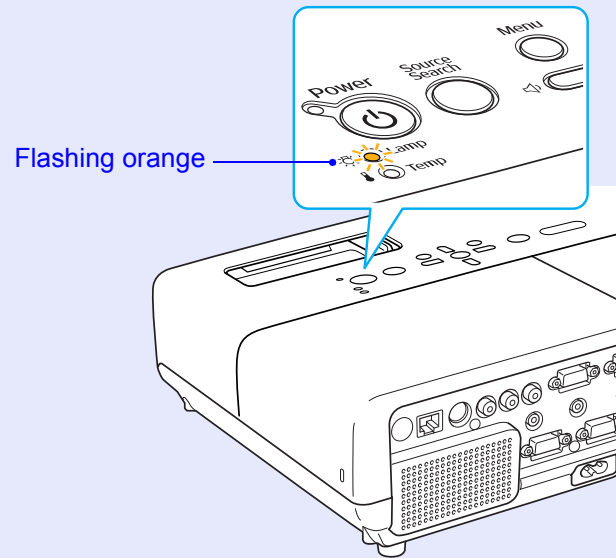

- The projected image gets darker or starts to deteriorate.

### Attention

- The lamp replacement message is set to appear after the following time periods in order to maintain the initial brightness and quality of the projected images.  "Brightness Control" p.28
  - When used continually at high brightness: About 2900 hours
  - When used continually at low brightness: About 3900 hours
- If you continue to use the lamp after the replacement period has passed, the possibility that the lamp may explode increases. When the lamp replacement message appears, replace the lamp with a new one as soon as possible, even if it is still working.
- Depending on the characteristics of the lamp and the way it has been used, the lamp may become darker or stop working before the lamp warning message appears. You should always have a spare lamp ready in case it is needed.

## ■ How to replace the lamp



### Warning

- *When replacing the lamp because it has stopped illuminating, there is a possibility that the lamp may be broken. If replacing the lamp of a projector which has been installed on the ceiling, you should always assume that the lamp is broken, and you should stand to the side of the lamp cover, not underneath it. Remove the lamp cover gently. Small pieces of glass may fall out when the lamp cover is opened. If pieces of glass get into your eyes or mouth, seek medical advice immediately.*

### Caution

- *When replacing the lamp because it has stopped illuminating, there is a possibility that the lamp may be broken. Wait until the lamp has cooled down sufficiently before removing the lamp cover. If the lamp is still hot, burns or other injuries may result. It takes about one hour after the power has been turned off for the lamp to be cool enough.*

### Procedure

-  **1** After you turn off the projector's power and the confirmation buzzer beeps twice, disconnect the power cable.
-  **2** Wait until the lamp has cooled down, then remove the lamp cover.

Loosen the lamp cover fixing screw with the screwdriver supplied with the new lamp or a + head screwdriver. Then slide the lamp cover straight forward and lift it to remove.

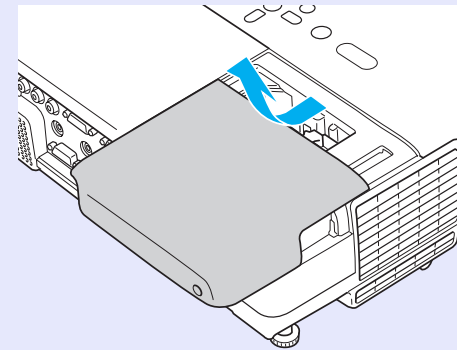
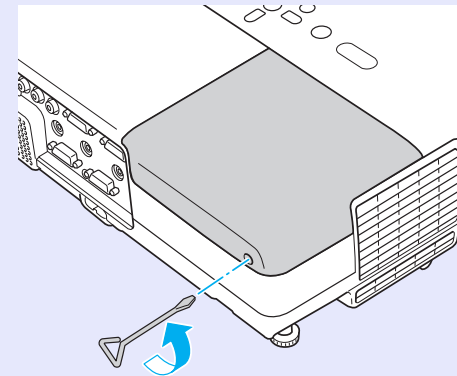

**3** Loosen the two lamp fixing screws.

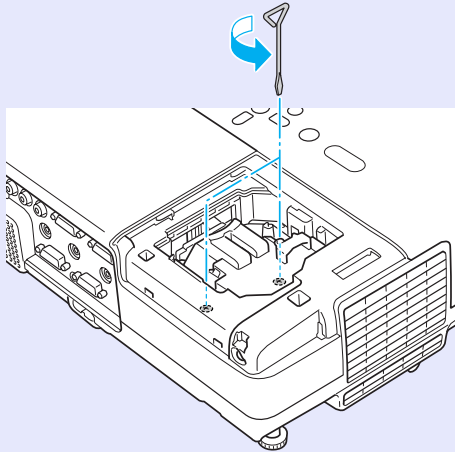

**4** Take out the old lamp.

If the lamp is cracked, replace it with a new lamp, or contact your local dealer for further advice. [Inquiries](#)

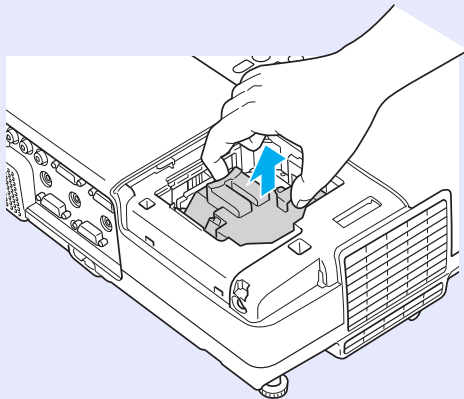

**5** Install the new lamp.

Insert the new lamp along the guide rail in the correct direction so that it fits in place, push down firmly at the location marked "PUSH", and once it is fully inserted tighten the two screws.

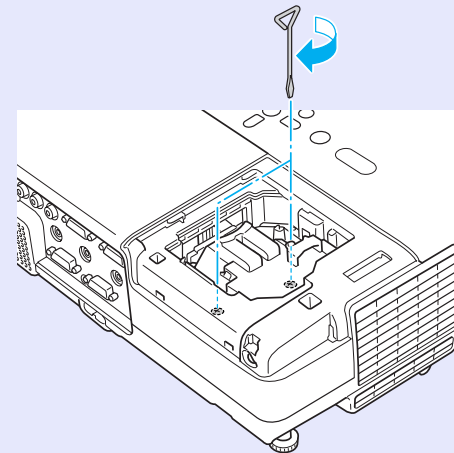
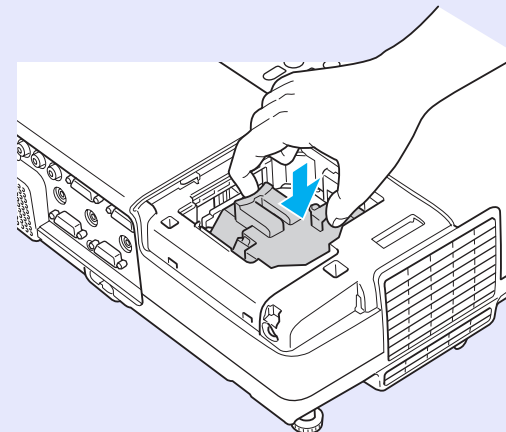

## 6 Replace the lamp cover.

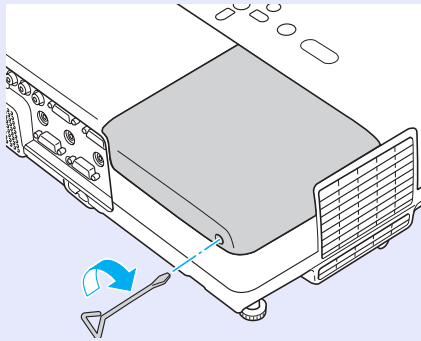

### Attention

- *Make sure you install the lamp securely. If the lamp cover is removed, the lamp turns off automatically as a safety precaution. If the lamp or the lamp cover is not installed correctly, the lamp does not turn on.*
- *This product includes a lamp component that contains mercury (Hg). Please consult your local regulations regarding disposal or recycling. Do not dispose of it with normal waste.*

## ■ Resetting the lamp operating time

The projector records how long the lamp is turned on and a message and indicator notify you when it is time to replace the lamp. After replacing the lamp, make sure you reset the lamp hours in the configuration menu.

☞ p.35



*Only reset the lamp operating time after the lamp has been replaced. Otherwise the lamp replacement period is not indicated correctly.*



## Replacing the Air Filter

### Air filter replacement period

It is time to replace the air filter when:

- The air filter is ripped.
- The message is displayed even though the air filter has been cleaned.

### How to replace the air filter

The air filter can be replaced even when the projector is suspended from a ceiling.

#### Procedure

**1** After you turn off the projector's power and the confirmation buzzer beeps twice, disconnect the power cable.

**2** Remove the air filter.  
Put your finger into the recess of the air filter and slide it forward to remove it.

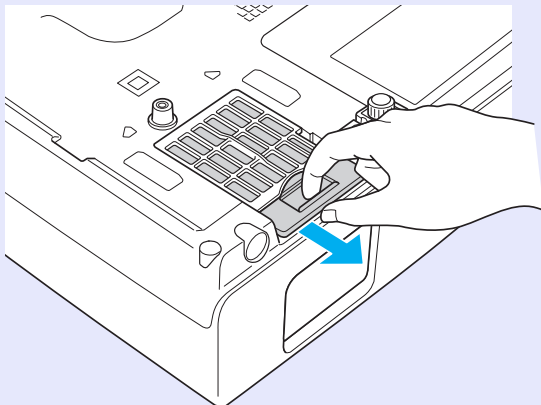

**3** Install the new air filter.

Slide the air filter in from the outside and push until it clicks into place.

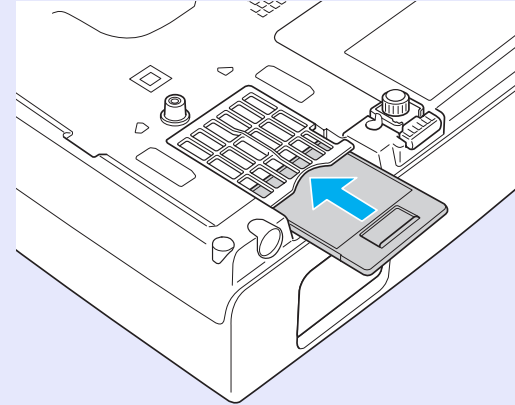

*Dispose of used air filters properly in accordance with your local regulations. Do not dispose of it with normal waste.*

*Material quality of the frame section: Polycarbonate, ABS resin*

*Material quality of the filter section: Polyurethane form*



You can save the image that is currently being projected as a user's logo.  
Depending on the area of purchase, the User's Logo function may not be available for EMP-X5/S5. In that case, the user's logo cannot be saved.



*When a user's logo is saved, the previous user's logo is erased.*

## Procedure

- 1 Project the image you want to use as the user's logo, and then press the [Menu] button.

Using the remote control

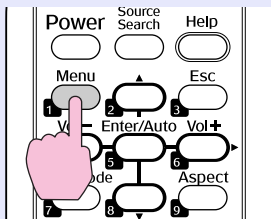

Using the control panel

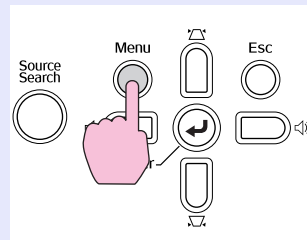

2

In the configuration menu, select "Extended"-  
"User's Logo".

☞ "Using the Configuration Menu" p.23

Check the buttons you can use and the operations they perform in the guide under the menu.

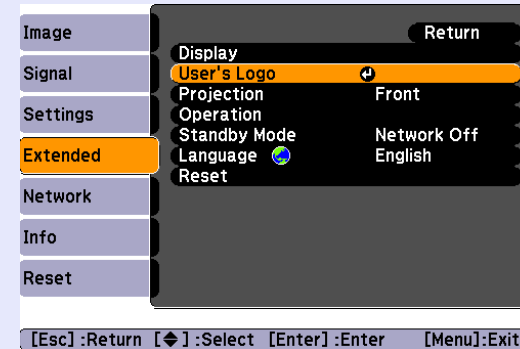

- If "User's Logo Protect" from "Password Protect" is set to "On", a message is displayed and the user's logo cannot be changed. You can make changes after setting "User's Logo Protect" to "Off". ☞ p.19
- If "User's Logo" is selected when Keystone, E-Zoom, Aspect, or Progressive are being performed, the function currently being performed is cancelled.

3

When "Choose this image as the User's Logo?" is displayed, select "Yes".



*When you press the [Enter] button on the remote control or the control panel, the screen size may change as it changes to the resolution of the image signal.*



- 4** Move the box to select the part of the image to use as the user's logo.

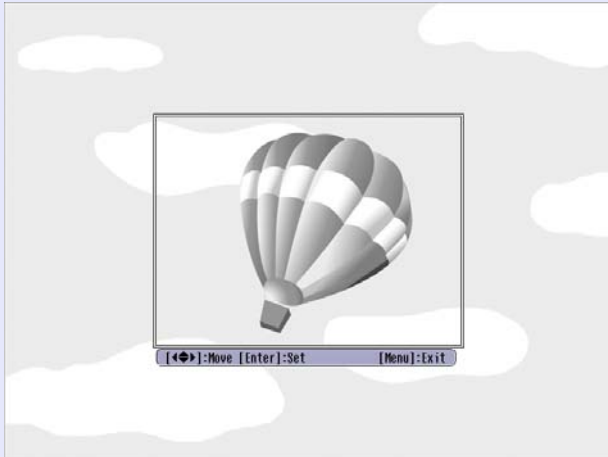

Using the remote control

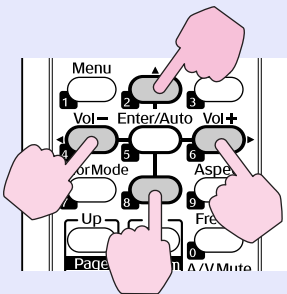

Using the control panel

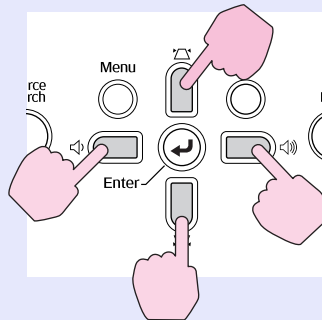

- 5** When "Select this image?" is displayed, select "Yes".
- 6** Select the zoom factor from the zoom setting screen.

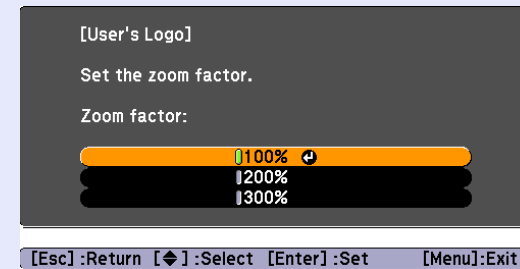

- 7** When the message "Save this image as the User's Logo?" is displayed, select "Yes".
- The image is saved. After the image has been saved, the message "Completed" is displayed.



- Saving the user's logo may take about 15 seconds. Do not use the projector or any connected equipment while it is saving. This may cause malfunctions to occur.
- Once a user's logo has been saved, the logo cannot be returned to the factory default.



You can save at up to 400 × 300 dots in size.



## EMP-83/822/X5

See the following table to choose the best position for your projector. The values are only a guide.

Units: cm (in.)

4:3 Screen Size		Projection Distance <b>A</b>		Offset <b>B</b>
		Minimum (Wide)	Maximum (Tele)	
30"	61 × 46 (24 × 18)	84 to 101 (33 to 40)		5 (1.9)
40"	81 × 61 (32 × 24)	113 to 136 (44 to 53)		6 (2.5)
50"	100 × 76 (39 × 30)	142 to 171 (56 to 67)		8 (3.1)
60"	120 × 90 (47 × 35)	171 to 206 (67 to 81)		10 (3.8)
80"	160 × 120 (63 × 47)	229 to 275 (90 to 108)		13 (5.0)
100"	200 × 150 (79 × 59)	287 to 345 (113 to 136)		16 (6.3)
120"	240 × 180 (94 × 71)	345 to 415 (136 to 163)		19 (7.5)
150"	300 × 230 (118 × 91)	432 to 519 (170 to 204)		24 (9.4)
200"	410 × 300 (161 × 118)	577 to 693 (227 to 273)		32 (12.5)
300"	610 × 460 (240 × 181)	867 to 1041 (341 to 410)		48 (18.8)

Units: cm (in.)

16:9 Screen Size		Projection Distance <b>A</b>		Offset <b>B</b> (When image position is off center)
		Minimum (Wide)	Maximum (Tele)	
30"	66 × 37 (26 × 15)	91 to 110 (36 to 43)		-1 (-0.4)
40"	89 × 50 (35 × 20)	123 to 148 (48 to 58)		-1 (-0.5)
50"	110 × 62 (43 × 24)	154 to 186 (61 to 73)		-2 (-0.7)
60"	130 × 75 (51 × 28)	186 to 224 (73 to 88)		-2 (-0.8)
80"	180 × 100 (71 × 39)	249 to 300 (98 to 118)		-3 (-1.1)
100"	220 × 120 (87 × 47)	312 to 376 (123 to 148)		-3 (-1.4)
120"	270 × 150 (106 × 59)	375 to 452 (148 to 178)		-4 (-1.6)
150"	330 × 190 (130 × 75)	470 to 565 (185 to 223)		-5 (-2.0)
200"	440 × 250 (173 × 98)	628 to 755 (247 to 297)		-7 (-2.7)
300"	660 × 370 (260 × 146)	944 (372)		-10 (-4.1)

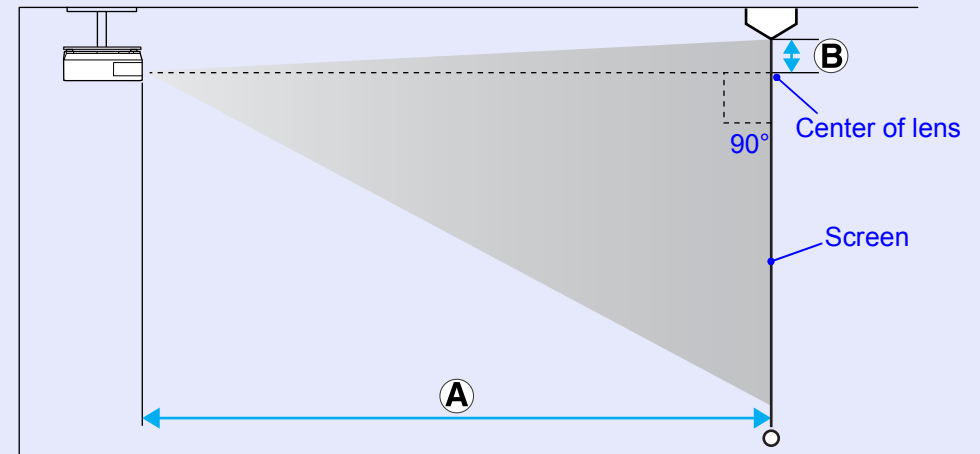
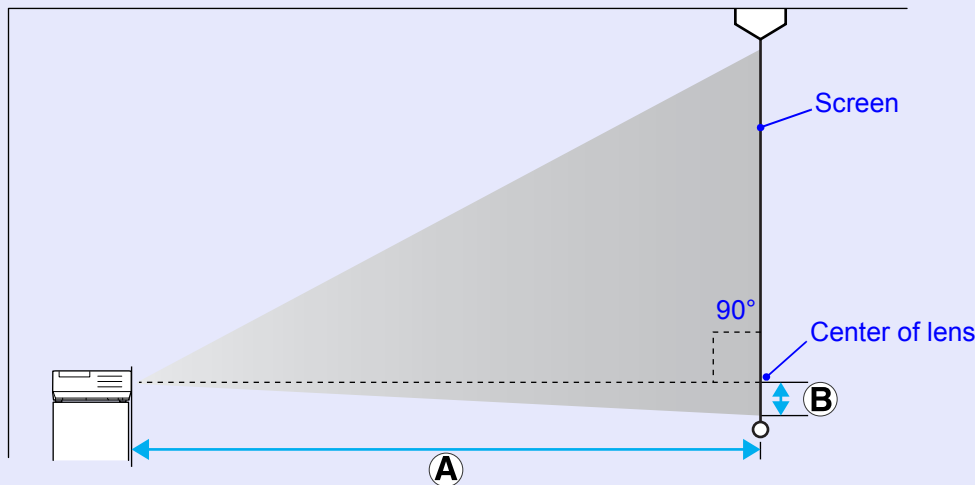

### EMP-S5

See the following table to choose the best position for your projector. The values are only a guide.

Units: cm (in.)

4:3 Screen Size		Projection Distance <b>A</b>		Offset <b>B</b> Wide to Tele
		Minimum (Wide)	Maximum (Tele)	
30"	61 × 46 (24 × 18)	87 to 119 (34 to 47)		4 to -2 (1.7 to -0.9)
40"	81 × 61 (32 × 24)	117 to 159 (46 to 63)		6 to -3 (2.3 to -1.1)
50"	100 × 76 (39 × 30)	147 to 200 (58 to 79)		7 to -4 (2.8 to -1.4)
60"	120 × 90 (47 × 35)	177 to 240 (70 to 95)		9 to -4 (3.4 to -1.7)
80"	160 × 120 (63 × 47)	237 to 321 (93 to 126)		11 to -6 (4.5 to -2.3)
100"	200 × 150 (79 × 59)	297 to 402 (117 to 158)		14 to -7 (5.7 to -2.9)
120"	240 × 180 (94 × 71)	357 to 483 (141 to 190)		17 to -9 (6.8 to -3.4)
150"	300 × 230 (118 × 91)	447 to 605 (176 to 238)		22 to -11 (8.5 to -4.3)
200"	410 × 300 (161 × 118)	597 to 807 (235 to 318)		29 to -15 (11.3 to -5.7)
300"	610 × 460 (240 × 181)	897 (353)		43 (17.0)

Units: cm (in.)

16:9 Screen Size		Projection Distance <b>A</b>		Offset <b>B</b> (When image position is off center) Wide to Tele
		Minimum (Wide)	Maximum (Tele)	
30"	66 × 37 (26 × 15)	95 to 129 (37 to 51)		-2 to -9 (-0.6 to -3.4)
40"	89 × 50 (35 × 20)	128 to 173 (50 to 68)		-2 to -11 (-0.8 to -4.5)
50"	110 × 62 (43 × 24)	160 to 218 (63 to 86)		-3 to -14 (-1.0 to -5.6)
60"	130 × 75 (51 × 28)	193 to 262 (76 to 103)		-3 to -17 (-1.2 to -6.8)
80"	180 × 100 (71 × 39)	258 to 350 (102 to 138)		-4 to -23 (-1.6 to -9.0)
100"	220 × 120 (87 × 47)	324 to 438 (127 to 172)		-5 to -29 (-2.0 to -11.3)
120"	270 × 150 (106 × 59)	389 to 526 (153 to 207)		-6 to -34 (-2.4 to -13.5)
150"	330 × 190 (130 × 75)	487 to 659 (192 to 259)		-8 to -43 (-3.0 to -16.9)
200"	440 × 250 (173 × 98)	651 to 879 (256 to 346)		-10 to -57 (-4.0 to -22.6)

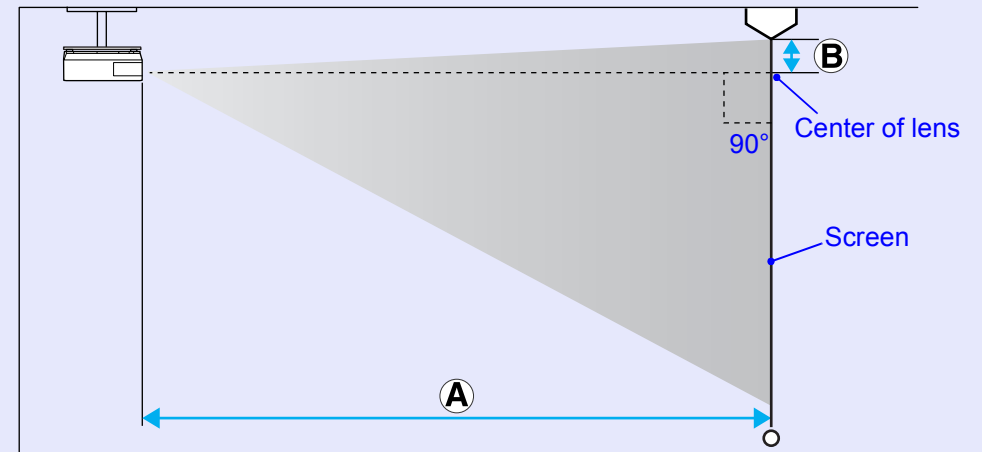
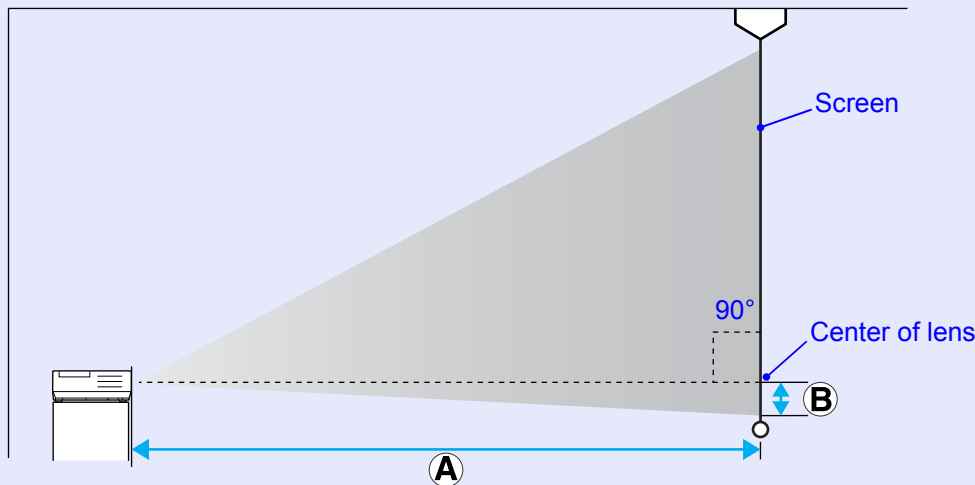

## Connecting to an External Monitor

Computer images being input to the Computer1 input port or the Computer Input port can be displayed on an external monitor and the screen at the same time when connected to the projector. This means that you can check projected images on an external monitor when giving presentations even if you cannot see the screen.

Connect to an external monitor using the cable supplied with the monitor.

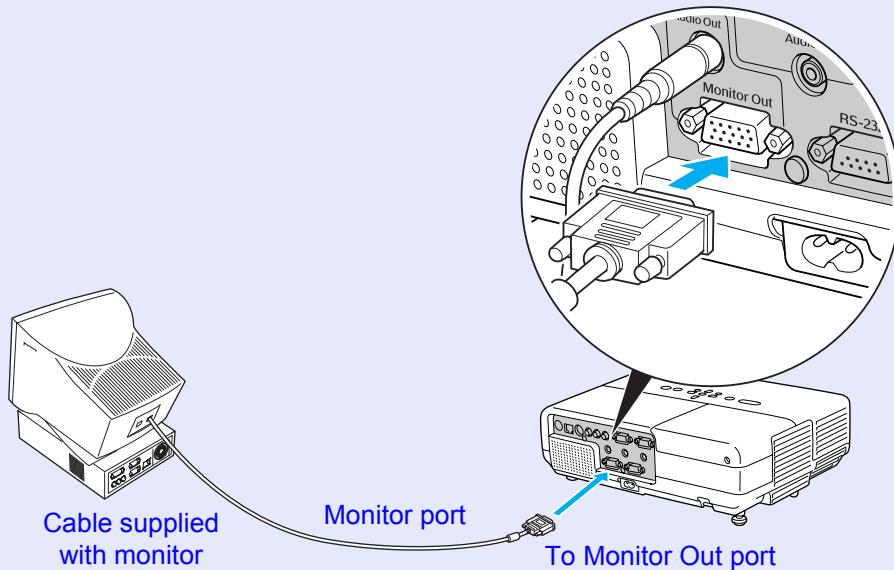

## Connecting to External Speakers (EMP-83/822 Only)

You can connect speakers with built-in amplifiers to the projector's Audio Out port to enjoy a fuller quality of sound.

Connect with a commercially available audio cable (pin plug ↔ 3.5 mm stereo mini plug and so on). Use an audio cable compatible with the connector on the external speakers.

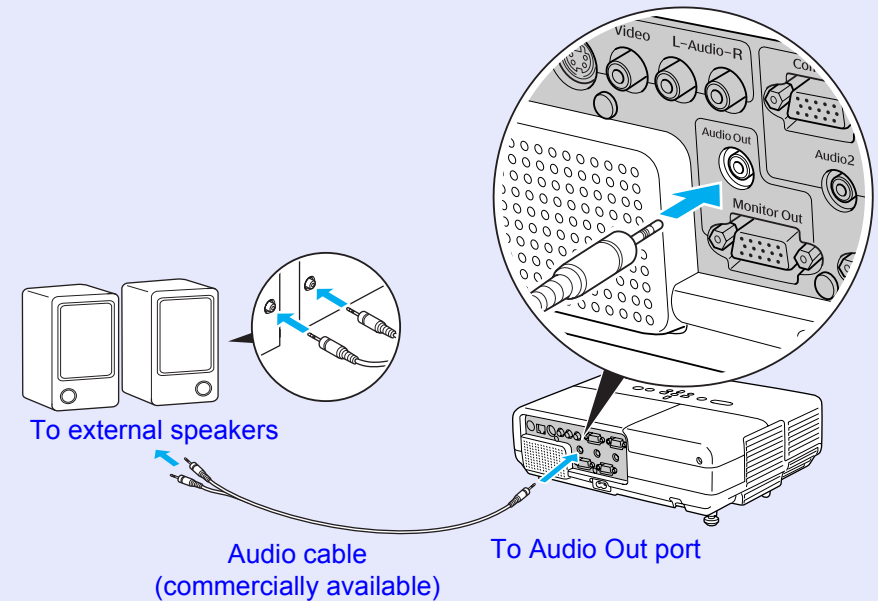

- *Component video signals and images connected to the Computer2 port, Video port, and S-Video port cannot be output to an external monitor.*
- *The setting gauge for Keystone, the configuration and help screen, and so on are not output to an external monitor.*



*When an audio cable plug is inserted in the Audio Out port, the audio changes to the external destination, and audio is no longer emitted from the projector's built-in speaker.*

# Connecting a LAN Cable (EMP-83/822 Only)



Connect with a commercially available 100baseTX or 10baseT type LAN cable.

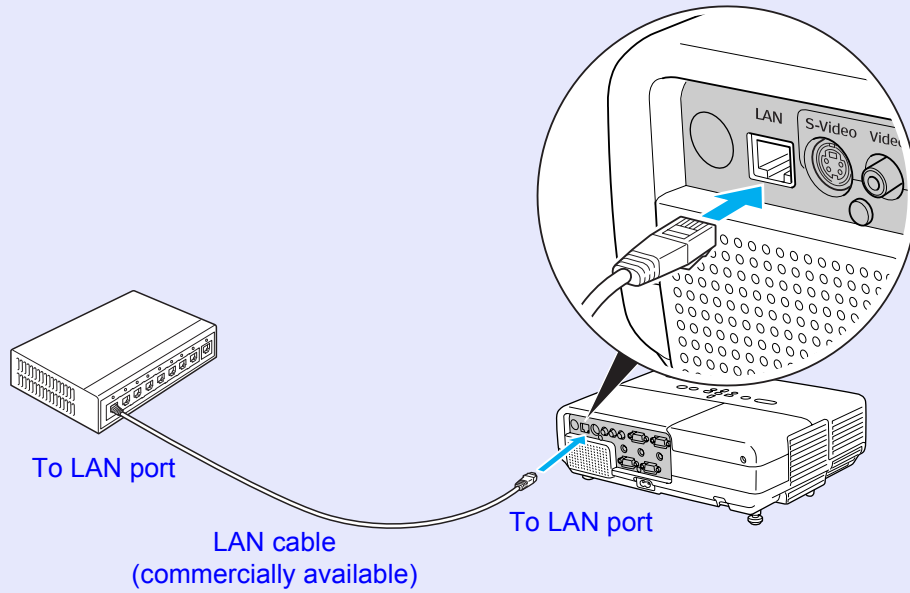

## Attention

*To prevent malfunctions, use a category 5 shielded LAN cable.*

# Connecting a USB Cable (EMP-X5/S5 Only)



Connect the **USB** port of a computer and the USBport (TypeB) on the rear of the projector with a commercially available USB cable.

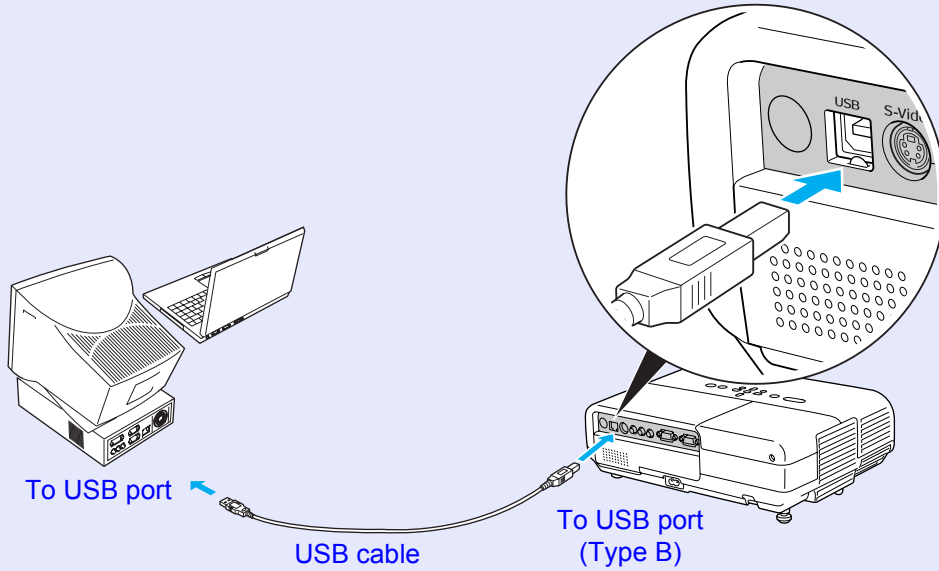

Prepare the following options and consumables. Purchase depending on usage. The following list of optional accessories is current as of March, 2007. Details of accessories are subject to change without notice and availability may vary depending on the country of purchase.

## ■ Optional accessories

### Soft carrying case ELPKS16B

Use this case if you need to travel with the projector.

60" portable screen ELPSC07

80" portable screen ELPSC08

100" screen ELPSC10

Portable roll-type screens ([Aspect ratio](#)▶▶ 4:3)

### 50" portable screen ELPSC06

A compact screen that can be carried easily. (Aspect ratio 4:3)

### HD-15 cable ELPKC02

(1.8 m - for mini D-Sub15-pin/mini D-Sub 15pin)

This is the same as the computer cable supplied with the projector.

### HD-15 cable ELPKC09

(3 m - for mini D-Sub15-pin/mini D-Sub 15pin)

### HD-15 PC cable ELPKC10

(20 m - for mini D-Sub15-pin/mini D-Sub 15pin)

Use one of these longer cables if the computer cable bundled with the product is too short.

### Component video cable ELPKC19

(3 m - for mini D-Sub 15-pin/RCA male×3)

Use to connect a [component video](#)▶▶ source

### Ceiling plate\* ELPFC03

Pipe 370 (370 mm silver)\* ELPFP04

Pipe 570 (570 mm silver)\* ELPFP05

Pipe 770 (770 mm silver)\* ELPFP06

### Ceiling mount (For use with the ceiling plate)\* ELPMB18

Use when installing the projector on a ceiling.

## ■ Consumables

Lamp unit (For EMP-X5/S5) ELPLP41

Lamp unit (For EMP-83/822) ELPLP42

Use as a replacement for used lamps.

Air filter (by 2) ELPAF13

Use as a replacement for used air filters.

\* A special method of installation is required to suspend the projector from a ceiling. Contact your dealer or the nearest address provided in the *International Warranty Terms* if you want to use this installation method.



This section briefly explains terms that are used with the projector and difficult terms that are not explained in the text of this guide. For details, refer to other commercially available publications.

Aspect ratio	The ratio between an image's length and its height. HDTV images have an aspect ratio of 16:9 and appear elongated. The aspect ratio for standard images is 4:3.
Component Video	A video signal which has the luminance component and color component separated to provide better image quality. Refers to images that consist of three independent signals: Y (luminance signal), Pb and Pr (color difference signals).
Composite video	Video signals that have the video brightness signals and color signals mixed together. The type of signals commonly used by household video equipment (NTSC, PAL, and SECAM formats). The carrier signal Y (luminance signal) and chroma (color) signal that are contained in the color bar are overlapped to form a single signal.
Contrast	The relative brightness of the light and dark areas of an image can be increased or decreased to make text and graphics stand out more clearly, or to make them appear softer. Adjusting this particular property of an image is called "contrast adjustment".
DHCP	An abbreviation of Dynamic Host Configuration Protocol, this protocol automatically assigns an <a href="#">IP address</a> to equipment connected to a network.
Dolby Digital	A sound format developed by Dolby Laboratories. Normal stereo is a 2-channel format that uses two speakers. Dolby Digital is a 6-channel (5.1-channel) system which adds to this a center speaker, two rear speakers, and a sub-woofer.
Gateway address	This is a server (router) for communicating across a network (subnet) divided according to <a href="#">subnet masks</a> .
HDTV	An abbreviation for High-Definition Television that refers to high-definition systems which satisfy the following conditions. <ul style="list-style-type: none"> <li>• Vertical resolution of 720p or 1080i or greater (p = <a href="#">progressive</a>, i = <a href="#">interlace</a>)</li> <li>• Screen <a href="#">aspect ratio</a> of 16:9</li> <li>• <a href="#">Dolby Digital</a> audio reception and playback (or output)</li> </ul>
Interlace	A method of image scanning whereby the image data is divided into fine horizontal lines that are displayed in sequence starting from left to right and then from top to bottom. The even-numbered lines and odd-numbered lines are displayed alternately.
IP address	A number to identify a computer connected to a network.
Progressive	A method of image scanning whereby the image data from a single image is scanned sequentially from top to bottom to create a single image.
Refresh rate	The light-emitting element of a display maintains the same luminosity and color for an extremely short time. Because of this, the image must be scanned many times per second to refresh the light-emitting element. The number of refresh operations per second is called the Refresh rate and is expressed in hertz (Hz).
SDTV	An abbreviation for Standard Definition Television that refers to standard television systems which do not satisfy the conditions for <a href="#">HDTV</a> High-Definition Television.
SNMP	An abbreviation for Simple Network Management Protocol, which is the protocol for monitoring and controlling devices such as routers and computers connected to a TCP/IP network.
SNMP Trap IP address	This is the <a href="#">IP address</a> for the destination computer used for error notification in SNMP



Squeeze mode	In this mode, wide-screen images in 16:9 mode are compressed in the horizontal direction so that they are stored on the recording medium as 4:3 images. When these images are played back by the projector in squeeze mode, they are restored to their original 16:9 format.
sRGB	An international standard for color intervals that was formulated so that colors that are reproduced by video equipment can be handled easily by computer operating systems (OS) and the Internet. If the connected source has an sRGB mode, set both the projector and the connected signal source to sRGB.
Subnet mask	This is a numerical value that defines the number of bits used for the network address on a divided network (subnet) from the IP address.
SVGA	A type of video signal with a resolution of 800 (horizontal) × 600 (vertical) dots that is used by IBM PC/AT-compatible computers.
S-Video	A video signal which has the luminance component and color component separated to provide better image quality. Refers to images that consist of two independent signals: Y (luminance signal) and C (color signal).
SXGA	A type of video signal with a resolution of 1280 (horizontal) × 1024 (vertical) dots that is used by IBM PC/AT-compatible computers.
Synchronization	The signals output from computers have a specific frequency. If the projector frequency does not match this frequency, the resulting images are not of a good quality. The process of matching the phases of these signals (the relative position of the crests and the troughs in the signal) is called Synchronization. If the signals are not synchronized, flickering, blurriness, and horizontal interference occur.
Tracking	The signals output from computers have a specific frequency. If the projector frequency does not match this frequency, the resulting images are not of a good quality. The process of matching the frequency of these signals (the number of crests in the signal) is called Tracking. If tracking is not carried out correctly, wide vertical stripes appear in the signal.
VGA	A type of video signal with a resolution of 640 (horizontal) × 480 (vertical) dots that is used by IBM PC/AT-compatible computers.
XGA	A type of video signal with a resolution of 1024 (horizontal) × 768 (vertical) dots that is used by IBM PC/AT-compatible computers.



## Command List

When the power ON command is transmitted to the projector, the power turns on and it enters warm-up mode. When the projector's power has turned on, a colon ":" (3Ah) is returned.

When a command is input, the projector executes the command and returns a ":", and then accepts the next command.

If the command being processed terminates due to a problem, an error message is output and a ":" is returned.

Item		Command	
Power ON/OFF	ON	PWR ON	
	OFF	PWR OFF	
Signal selection	Video	SOURCE 41	
	S-Video	SOURCE 42	
A/V Mute ON/OFF	ON	MUTE ON	
	OFF	MUTE OFF	
A/V Mute selection	Black	MSEL 00	
	Blue	MSEL 01	
	Logo	MSEL 02	
Item		Command	
		Computer1 Port	Computer2 Port
Signal selection	Computer (Auto)	SOURCE 1F	SOURCE 2F
	Computer	SOURCE 11	SOURCE 21
	Component Video	SOURCE 14	SOURCE 24

\* Add a Carriage Return (CR) code (0Dh) to the end of each command and transmit.

## Cable Layouts

### Serial connection (EMP-83/822 Only)

- Connector shape : D-Sub 9-pin (male)
- Projector input connector : RS-232C

<At the projector>



<At the computer>

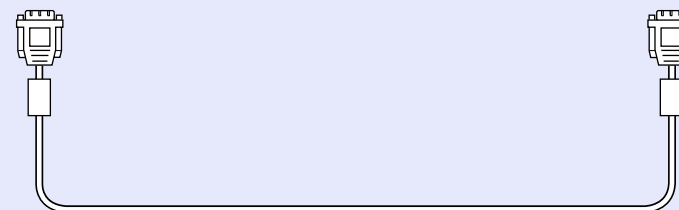
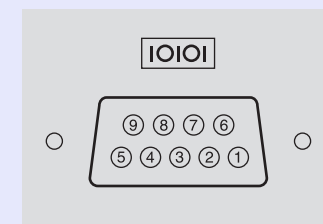

At the projector (PC serial cable) At the computer

GND	5	→	5	GND
RD	2	←	3	TD
TD	3	→	2	RD
DTR	4	→	6	DSR
DSR	6	←	4	DTR

Signal	Function
GND	Signal wire ground
TD	Transmit data
RD	Receive data
DSR	Data set ready
DTR	Data terminal ready

## Connecting a USB (EMP-X5/S5 Only)

Connector shape: USB (Type B)

<At the projector>

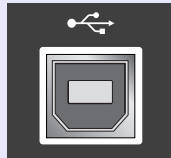

(Type B)

<At the computer>

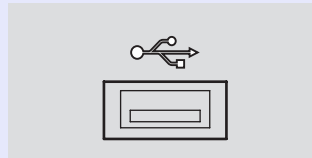

## USB Connection Setup

To control the projector using ESC/VP21 commands via a USB connection, the following preparations must be carried out.

### Procedure

- 1 Download the USB driver (USB-COM Driver) from the Epson Web site to your computer.**  
Go to <http://www.epson.com> and select the support section of your local Epson Web site.
- 2 Install the downloaded USB driver onto your computer.**  
Read the instructions displayed on the download screen.
- 3 Set "Extended"- "Link 21L" to "On" from the projector's configuration menu.**

PJLink Class 1 was established by the JBMIA (Japan Business Machine and Information System Industries Association) as a standard protocol for controlling network-compatible projector's as part of their efforts to standardize projector control protocols.

The projector complies with the PJLink Class 1 standard established by the JBMIA.

It complies with all commands except for the following commands defined by PJLink Class 1, and agreement was confirmed by the PJLink standard adaptability verification.

Refer to the JBMIA (Japan Business Machine and Information System Industries Association) Web site for more details on PJLink.

URL <http://pjlink.jbmia.or.jp/english/>

## ■ Manufacturer name displayed for "Manufacture name information query"

EPSON

## ■ Model name displayed for "Product name information query"

EMP-83

EMP-822

## ■ Non-compatible commands

	Function	PJLink Command
Mute settings	Image muting set	AVMT 11
	Image muting cancel	AVMT 10
	Audio muting set	AVMT 21
	Audio muting cancel	AVMT 20

## ■ Input names defined by PJLink and corresponding projector connectors

Input Connector	PJLink Command
Computer1 input	INPT 11
Computer2 input	INPT 12
Video input	INPT 21
S-Video input	INPT 22

## ■ Computer image

Signal	Refresh Rate <sup>▶▶</sup> (Hz)	Resolution (dots)	Number of Pixels Used Display Aspect is Resized (dots)
VGAEGA		640 × 350	1024 × 560
VGA <sup>▶▶</sup>	60/72/75/85, iMac* <sup>1</sup>	640 × 480	1024 × 768
SVGA <sup>▶▶</sup>	56/60/72/75/85, iMac* <sup>1</sup>	800 × 600	1024 × 768
XGA <sup>▶▶</sup>	60/70/75/85, iMac* <sup>1</sup>	1024 × 768	1024 × 768
SXGA <sup>▶▶</sup>	70/75/85	1152 × 864	1024 × 768
SXGA	60/75/85	1280 × 960	1024 × 768
SXGA	60/75/85	1280 × 1024	960 × 768
UXGA* <sup>2</sup>	60	1600 × 1200	1024 × 768
MAC13"		640 × 480	1024 × 768
MAC16"		832 × 624	1024 × 768
MAC19"		1024 × 768	1024 × 768
MAC19"	60	1024 × 768	1024 × 768
MAC21"		1152 × 870	1016 × 768
SDTV <sup>▶▶</sup> (480i)	60	720 × 480	1024 × 768
SDTV (576i)	50	720 × 576	1024 × 768
SDTV (480p)	60	720 × 480	1024 × 768
SDTV (576p)	50	720 × 576	1024 × 768
HDTV <sup>▶▶</sup> (720p)	50/60	1280 × 720	1024 × 576
HDTV (1080i)	50/60	1920 × 1080	1024 × 576

\*1 Connection is not possible if the equipment does not have a VGA output port.

\*2 EMP-S5 is not supported.

Even when signals other than those mentioned above are input, it is likely that the image can be projected.

However, not all functions may be supported.

## ■ Component Video

Signal	Refresh Rate <sup>▶▶</sup> (Hz)	Resolutions (dots)	
		Aspect Ratio <sup>▶▶</sup> 4:3	Aspect Ratio 16:9
SDTV <sup>▶▶</sup> (480i)	60	1024 × 768	1024 × 576
SDTV (576i)	50	1024 × 768	1024 × 576
SDTV (480p)	60	1024 × 768	1024 × 576
SDTV (576p)	50	1024 × 768	1024 × 576
HDTV <sup>▶▶</sup> (720p) 16:9	50/60	1024 × 768	1024 × 576
HDTV (1080i) 16:9	50/60	1024 × 768	1024 × 576

## ■ Composite video/S-video

Signal	Refresh Rate <sup>▶▶</sup> (Hz)	Resolutions (dots)	
		Aspect Ratio <sup>▶▶</sup> 4:3	Aspect Ratio 16:9
TV (NTSC)	60	1024 × 768	1024 × 576
TV (PAL, SECAM)	50	1024 × 768	1024 × 576

Product name	EMP-83/822	EMP-X5	EMP-S5
Dimensions	327 (W) × 92 (H) × 245 (D) mm		
Panel size	0.63"		0.55"
Display method	Polysilicon TFT active matrix		
Resolution	786,432 pixels XGA (1024 (W) × 768 (H) dots) × 3		480,000 pixels SVGA (800 (W) × 600 (H) dots) × 3
Focus adjustment	Manual		
Zoom adjustment	Manual (1 to 1.2)		Digital (1 to 1.35)
Lamp	UHE lamp, 170 W		
	Model No.: ELPLP42	Model No.: ELPLP41	
Max. audio output	7 W monaural	1 W monaural	
Speaker	1		
Power supply	100 to 240 V AC ±10%, 50/60 Hz 2.8 to 1.2 A		
Power consumption	100 to 120 V area	Operating: 248 W Standby power consumption (network invalid): 4.1 W Standby power consumption (network valid): 5.0 W	
	200 to 240 V area	Operating: 231 W Standby power consumption (network invalid): 5.8 W Standby power consumption (network valid): 7.0 W	
Operating altitude	Altitude 0 to 2286 m (0 to 7500 ft)		
Operating temperature	5 to 35°C (No condensation)		
Storage temperature	-10 to +60°C (No condensation)		
Mass	Approx 2.9 kg	Approx 2.7 kg	Approx 2.6 kg



Pixelworks DNX™ ICs are used in this projector.

Angle of tilt

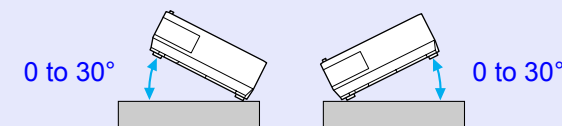

If you use the projector tilted at an angle of more than 30 it could be damaged and cause an accident.



Connectors	Computer1 input port	1	Mini D-Sub15-pin (female) blue	-
	Audio1 input port	1	Stereo mini jack	-
	Computer2 input port	1	Mini D-Sub15-pin (female) blue	-
	Audio2 input port	1	Stereo mini jack	-
	Computer input port	1	-	Mini D-Sub15-pin (female) blue
	Audio-L/R input port	1	-	RCA pin jack
	S-Video input port	1	Mini DIN 4-pin	
	Video input port	1	RCA pin jack	
	Audio-L/R input port	1	RCA pin jack	
	Monitor Out port	1	Mini D-Sub15-pin (female) black	
	Audio Out port	1	Stereo mini jack	
	RS-232C port	1	Mini D-Sub 9-pin (male)	
	LAN port	1	RJ45	-
	USB port (Type B)*	1	-	USB connector (Type B)

\* This supports USB2.0.

USB ports are not guaranteed to operate all devices that support USB.

Other detailed specifications, please access your location (country/area) from Epson homepage, <http://www.epson.com>





### Safety standards

USA: UL60950-1

Canada: CSA C22.2 No.60950-1

EU: The Low Voltage Directive  
(73/23/EEC)  
IEC/EN60950-1

This product is also designed for IT power distribution system with phase-to-phase voltage 230V.

### EMC standards

USA: FCC Part 15B Class B (DoC)

Canada: ICES-003 Class B

EU: The EMC Directive  
(89/336/EEC)  
EN55022, Class B  
EN55024  
IEC/EN61000-3-2  
IEC/EN61000-3-3

Australia/New Zealand: AS/NZS CISPR 22:2002 Class B

**DECLARATION of CONFORMITY**

According to 47CFR, Part 2 and 15  
Class B Personal Computers and Peripherals; and/or  
CPU Boards and Power Supplies used with Class B  
Personal Computers

We: Epson America, Inc.  
Located at: 3840 Kilroy Airport Way  
MS: 3-13  
Long Beach, CA 90806  
Tel: 562-290-5254

Declare under sole responsibility that the product identified herein, complies with 47CFR Part 2 and 15 of the FCC rules as a Class B digital device. Each product marketed, is identical to the representative unit tested and found to be compliant with the standards. Records maintained continue to reflect the equipment being produced can be expected to be within the variation accepted, due to quantity production and testing on a statistical basis as required by 47CFR 2.909. Operation is subject to the following two conditions : (1) this device may not cause harmful interference, and (2) this device must accept any interference received, including interference that may cause undesired operation.

Trade Name: EPSON

Type of Product: Projector

Model: EMP-83/822/X5/S5

**FCC Compliance Statement  
For United States Users**

This equipment has been tested and found to comply with the limits for a Class B digital device, pursuant to Part 15 of the FCC Rules. These limits are designed to provide reasonable protection against harmful interference in a residential installation. This equipment generates, uses, and can radiate radio frequency energy and, if not installed and used in accordance with the instructions, may cause harmful interference to radio or television reception. However, there is no guarantee that interference will not occur in a particular installation. If this equipment does cause interference to radio and television reception, which can be determined by turning the equipment off and on, the user is encouraged to try to correct the interference by one or more of the following measures.

- Reorient or relocate the receiving antenna.
- Increase the separation between the equipment and receiver.
- Connect the equipment into an outlet on a circuit different from that to which the receiver is connected.
- Consult the dealer or an experienced radio/TV technician for help.

**WARNING**

The connection of a non-shielded equipment interface cable to this equipment will invalidate the FCC Certification or Declaration of this device and may cause interference levels which exceed the limits established by the FCC for this equipment. It is the responsibility of the user to obtain and use a shielded equipment interface cable with this device. If this equipment has more than one interface connector, do not leave cables connected to unused interfaces. Changes or modifications not expressly approved by the manufacturer could void the user's authority to operate the equipment.

The external dimensions for EMP-83/822/X5/S5 are the same.

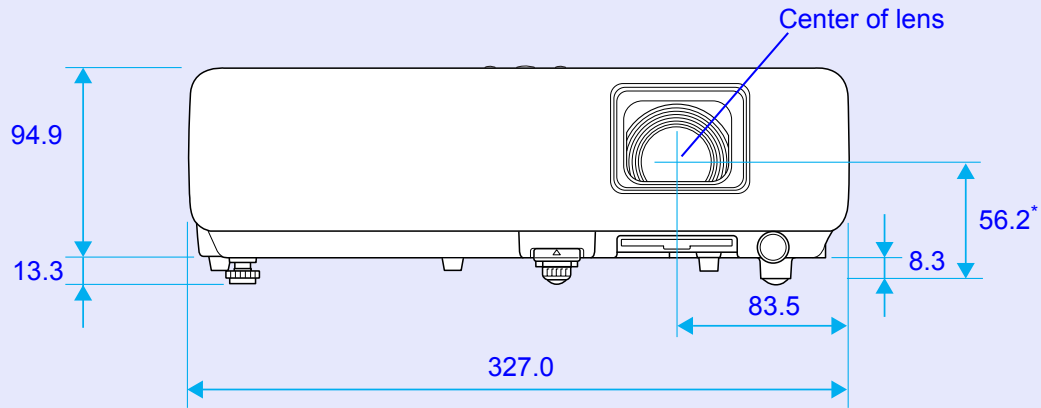

\* Distance from center of lens to suspension bracket fixing point

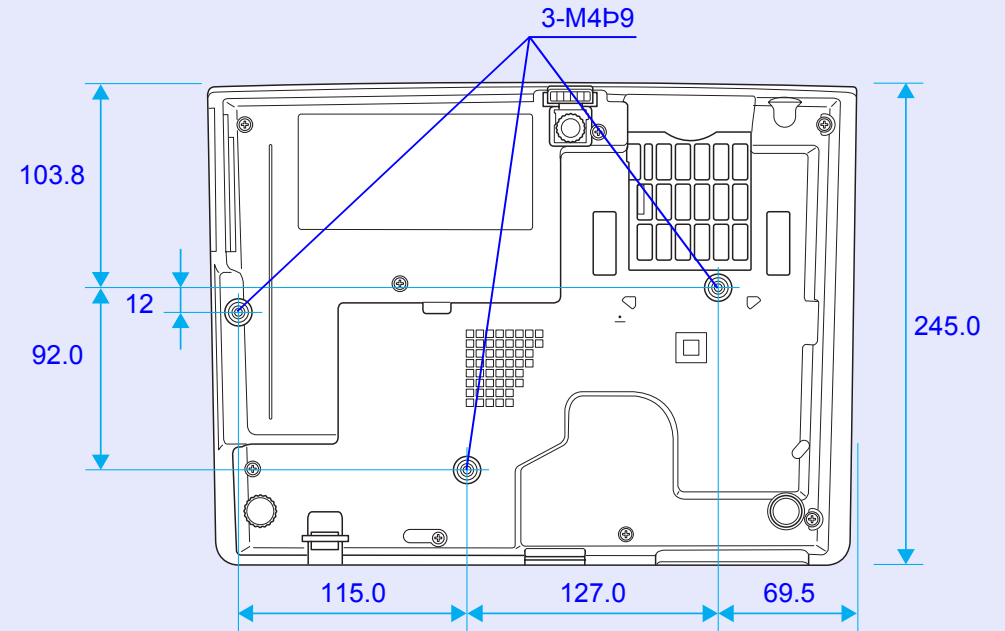

Units: mm

## A

A/V Mute	15
A/V mute slide	5
Abs. Color Temp.	25
Air exhaust vent	5
Air filter	11
Air filter replacement period	56
Air intake vent	11
Angle of tilt	71
Aspect ratio	16
Audio Out port	6
Audio-L/R input port	6, 7
Auto Setup	26, 27

## B

Blackboard	14
Brightness	24, 25
Brightness Control	28

## C

Ceiling	29
Cleaning the air filter and air intake vent	50
Cleaning the projector's surface	50
Color Adjustment	24, 25
Color Mode	14, 24, 25
Color Saturation	24, 25
Computer Input	27
Computer input port	7
Computer1 Input	26
Computer1 Port	6
Computer2 Input	26
Computer2 input port	6
Configuration menu	23
Connecting a LAN Cable	62
Connecting a USB Cable	63
Consumables	64
Contrast	24, 25
Control panel	8
Cross	17

## D

DHCP	31
Direct Power On	30
Display	29
Display Background	29

## E

Email Address 1/2/3 setting	32
ESC/VP21	67
Extended menu	29
External dimension diagram	75
External monitor	61
External speakers	61
E-zoom	17

## F

Focus ring	5
Freeze	16
Front	29
Front adjustable feet	5
Full lock	20

## G

Game	14
Gateway address	31
Glossary	65

## H

HDTV	70
Help function	37
High Altitude Mode:	30
How to replace the air filter	56
How to replace the lamp	53

## I

Image menu	24, 25
------------	--------

Indicators	38
Info menu	34
Input Signal	34
IP address	31

## K

Keystone	28
----------	----

## L

Lamp cover	5
Lamp Hours	34
Lamp indicator	38
Lamp replacement period	52
LAN port	6
Language	30
Low brightness	28

## M

MAC Address	31
Mail	32
Mail Notification	32
Menu	23
Messages	29
Monitor Out port	6, 7

## N

Network Menu	31
Network Protect	19
Numeric buttons	10

## O

Operating temperature	71
Operation	30
Operation Lock	20, 28
Optional accessories	64
Overheating	39



## P

Part names and functions .....	5
Password protect .....	18
Password protect sticker .....	19
Photo .....	14
PJLink .....	69
PJLink Password .....	31
Port Number .....	32
Position .....	26, 27
Power indicator .....	38
Power inlet .....	6, 7
Power on protect .....	18
Presentation .....	14
Problem solving .....	38
Progressive .....	26, 27
Projection .....	29
Projection distance .....	59
Projector Name .....	32

## R

Rear .....	29
Rear foot .....	11
Rear screen .....	49
Refresh Rate .....	34
Remote control .....	10
Remote control light-emitting area .....	11
Remote receiver .....	5, 6, 7
Replacing batteries .....	51
Request code .....	20
Reset All .....	35
Reset menu .....	35
Resetting the lamp operating time .....	35, 55
Resolution .....	34, 70
RS-232C port .....	6

## S

Screen size .....	59
Settings menu .....	28

Sharpness .....	24, 25
Signal menu .....	25
Sleep Mode .....	30
SMTP Server .....	32
SNMP .....	32
Software keyboard .....	32
Source .....	34
Source Search .....	8, 10
Speaker .....	61
Specifications .....	71
Sports .....	14
sRGB .....	14
Standby Mode .....	30
Startup Screen .....	29
Storage temperature .....	71
Sub Menu .....	23
Subnet mask .....	31
Supported monitor displays .....	70
Suspension bracket fixing points .....	11, 75
S-video port .....	6, 7
Sync Info .....	34
Synchronization .....	26, 27

## T

Temp indicator .....	38
Theater .....	14
Tint .....	24, 25
Top menu .....	23
Tracking .....	26, 27
Trap IP Address .....	32

## U

USB port .....	7
User's Logo* .....	57
User's Logo Protect* .....	18

## V

Video port .....	6, 7
------------------	------

Video Signal .....	26, 27, 34
Volume .....	28

## W

Warning mail .....	33
Web Control Password .....	31
Wide-screen projection .....	16
Wired LAN .....	31

## Z

Zoom ring .....	5
-----------------	---

\*Depending on the area of purchase, the User's Logo function may not be available for EMP-X5/S5. In that case, "User's Logo Protect" is not displayed.



All rights reserved. No part of this publication may be reproduced, stored in a retrieval system, or transmitted in any form or by any means, electronic, mechanical, photocopying, recording, or otherwise, without the prior written permission of Seiko Epson Corporation. No patent liability is assumed with respect to the use of the information contained herein. Neither is any liability assumed for damages resulting from the use of the information contained herein.

Neither Seiko Epson Corporation nor its affiliates shall be liable to the purchaser of this product or third parties for damages, losses, costs, or expenses incurred by the purchaser or third parties as a result of: accident, misuse, or abuse of this product or unauthorized modifications, repairs, or alterations to this product, or (excluding the U.S.) failure to strictly comply with Seiko Epson Corporation's operating and maintenance instructions.

Seiko Epson Corporation shall not be liable against any damages or problems arising from the use of any options or any consumable products other than those designated as Original Epson Products or Epson Approved Products by Seiko Epson Corporation.

The contents of this guide may be changed or updated without further notice.

Illustrations in this guide and the actual projector may differ.

#### General Notice:

Macintosh, Mac, and iMac are registered trademarks of Apple Computer, Inc.

IBM is a registered trademark of International Business Machines Corporation.

Windows, Windows NT, and PowerPoint are either registered trademarks or trademarks of Microsoft Corporation in the U.S and/or other countries.

Dolby is a trademark of Dolby Laboratories.

Pixelworks and DNX are trademarks of Pixelworks, Inc.

PJLink trademark is a trademark applied for registration or is already registered in Japan, the United States of America and other countries and areas.

Other product names used herein are also for identification purposes only and may be trademarks of their respective owners. Epson disclaims any and all rights in those marks.

This product uses open source software.