

Panasonic®

Operating Instructions Functional Manual

LCD Projector Commercial Use

Model No. **PT-VZ580**
PT-VW540
PT-VX610

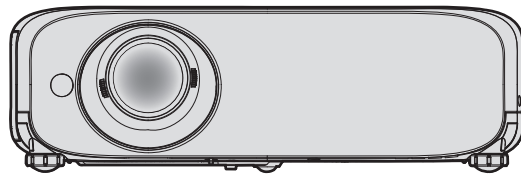

Thank you for purchasing this Panasonic product.

- Before operating this product, please read the instructions carefully, and save this manual for future use.
- Before using your projector, be sure to read “Read this first!” (➔ pages 4 to 12).

Contents

Read this first!	4	Operating with the remote control	48
		Using the AV mute function	48
		Using the mute function.....	48
		Adjusting the volume	48
		Using the freeze function.....	49
		Using the auto setup function.....	49
		Using the screen adjustment function	49
		Using the digital zoom function	50
		Using the FUNCTION button.....	50
		Using the presentation timer function.....	51
		Setting the ID number on the remote control	51
Chapter 1 Preparation		Chapter 4 Settings	
Precautions for use	16	On-screen menu	53
Cautions when transporting.....	16	Navigating through the menu	53
Cautions when installing.....	16	Main menu.....	54
Cautions when setting the projectors	17	Sub menu	55
Security	18	[PICTURE] menu	57
Early Warning Software.....	18	[PICTURE MODE].....	57
Storage.....	18	[CONTRAST].....	57
Disposal.....	18	[BRIGHTNESS].....	57
Cautions on use	19	[COLOR].....	57
Accessories	20	[TINT]	58
Optional accessories	21	[SHARPNESS]	58
About your projector	22	[COLOR TEMPERATURE].....	58
Remote control	22	[GAMMA].....	59
Projector body	23	[IRIS]	59
Preparing the remote control	26	[DAYLIGHT VIEW].....	59
Inserting and removing batteries	26	[DIGITAL CINEMA REALITY]	59
When using the system with multiple projectors ..	26	[NOISE REDUCTION].....	60
Attaching the lens cap	27	[TV-SYSTEM]	60
		[RGB/YC _B C _R] / [RGB/YP _B P _R]	60
		[RGB-SYSTEM].....	61
Chapter 2 Getting Started		[POSITION] menu	62
Setting up	29	[REALTIME KEYSTONE]	62
Installation mode	29	[SCREEN ADJUSTMENT]	62
Parts for ceiling mount (optional).....	30	[SHIFT]	65
Screen size and throw distance	30	[DOT CLOCK].....	66
Connecting	34	[CLOCK PHASE].....	66
Before connecting	34	[OVER SCAN]	67
Connecting example: AV equipment	35	[ASPECT]	67
Connecting example: Computers	36	[FRAME LOCK]	68
Chapter 3 Basic Operations		[LANGUAGE] menu	69
Switching on/off the projector	38	Switching the display language	69
Connecting the power cord	38	[DISPLAY OPTION] menu	70
Power indicator.....	38	[COLOR ADJUSTMENT].....	70
Switching on the projector	39	[COLOR CORRECTION]	71
When the initial setting screen is displayed.....	40	[ON-SCREEN DISPLAY].....	71
Making adjustments and selections	42	[HDMI SIGNAL LEVEL].....	73
Switching off the projector	42		
Direct power off function.....	43		
Projecting	44		
Selecting the image input for projection	44		
How to adjust the state of the image	45		
Adjusting adjustable feet	46		
Adjusting the projection position with the optical axis shift function.....	47		

[CLOSED CAPTION SETTING] (Only for NTSC input)	73
[SCREEN SETTING]	74
[STARTUP LOGO]	74
[AUTO SETUP SETTING]	75
[SIGNAL SEARCH]	75
[BACK COLOR]	75
[P-TIMER]	75
[OTHER FUNCTIONS]	76
[PROJECTOR SETUP] menu	78
[STATUS]	78
[COMPUTER2 SELECT]	78
[PROJECTOR ID]	78
[INITIAL START UP]	79
[PROJECTION METHOD]	79
[LAMP POWER]	79
[ECO MANAGEMENT]	80
[EMULATE]	81
[FUNCTION BUTTON]	82
[AUDIO SETTING]	82
[TEST PATTERN]	83
[FILTER COUNTER]	84
[DC OUT]	85
[INITIALIZE ALL]	85
[SECURITY] menu	86
[PASSWORD]	86
[PASSWORD CHANGE]	86
[TEXT DISPLAY]	87
[TEXT CHANGE]	87
[MENU LOCK]	87
[MENU LOCK PASSWORD]	87
[CONTROL DEVICE SETUP]	88
[NETWORK] menu	89
[WIRED LAN]	89
[PROJECTOR NAME]	89
[NETWORK CONTROL]	89
[NETWORK STATUS]	90
[INITIALIZE]	90

Chapter 5 Operation of Function	
Network connection	92
Connecting via wired LAN	92
Web control function	94
Computer that can be used for setting	94
Accessing from the web browser	94
Chapter 6 Maintenance	
Lamp and temperature indicators	110
When an indicator lights up	110
Maintenance/replacement	111
Before performing maintenance/replacement	111
Maintenance	111
Replacement	113
Troubleshooting	117
Chapter 7 Appendix	
Technical information	119
PJLink protocol	119
Control commands via LAN	120
<SERIAL IN> terminal	122
[MENU LOCK PASSWORD] operations	125
List of compatible signals	126
Specifications	128
Dimensions	131
Ceiling mount bracket safeguards	132
Index	133

Read this first!

WARNING: THIS APPARATUS MUST BE EARTHED.

WARNING: To prevent damage which may result in fire or shock hazard, do not expose this appliance to rain or moisture.
This device is not intended for use in the direct field of view at visual display workplaces. To avoid incommoding reflections at visual display workplaces this device must not be placed in the direct field of view.
The equipment is not intended for used at a video workstation in compliance BildscharbV.

The sound pressure level at the operator position is equal or less than 70 dB (A) according to ISO 7779.

WARNING:

1. Remove the plug from the mains socket when this projector is not in use for a prolonged period of time.
2. To prevent electric shock, do not remove cover. No user serviceable parts inside. Refer servicing to qualified service personnel.
3. Do not remove the earthing pin on the mains plug. This apparatus is equipped with a three prong earthing type mains plug. This plug will only fit an earthing-type mains socket. This is a safety feature. If you are unable to insert the plug into the mains socket, contact an electrician. Do not defeat the purpose of the earthing plug.

WARNING:

This equipment is compliant with Class A of CISPR32.
In a residential environment this equipment may cause radio interference.

WARNING: TO REDUCE THE RISK OF FIRE OR ELECTRIC SHOCK, DO NOT EXPOSE THIS PRODUCT TO RAIN OR MOISTURE.

WARNING: RISK OF ELECTRIC SHOCK. DO NOT OPEN.



Indicated on the projector



The lightning flash with arrowhead symbol, within an equilateral triangle, is intended to alert the user to the presence of uninsulated “dangerous voltage” within the product’s enclosure that may be of sufficient magnitude to constitute a risk of electric shock to persons.



The exclamation point within an equilateral triangle is intended to alert the user to the presence of important operating and maintenance (servicing) instructions in the literature accompanying the product.

WARNING: TURN THE POWER OFF AND DISCONNECT THE POWER PLUG FROM THE WALL OUTLET BEFORE REPLACING THE LAMP UNIT.



WARNING: Do not look at the light emitted from the lens while the projector is being used.



Indicated on the projector

WARNING: Do not place objects in front of the lens while the projector is being used.



Indicated on the projector

Read this first!

CAUTION: To assure continued compliance, follow the attached installation instructions. This includes using the provided power cord and shielded interface cables when connecting to computer or peripheral devices. Also, any unauthorized changes or modifications to this equipment could void the user's authority to operate this device.

This is a device to project images onto a screen, etc., and is not intended for use as indoor lighting in a domestic environment.

Directive 2009/125/EC

CAUTION (North/Middle/South America)

This equipment is equipped with a three-pin grounding-type power plug. Do not remove the grounding pin on the power plug. This plug will only fit a grounding-type power outlet. This is a safety feature. If you are unable to insert the plug into the outlet, contact an electrician. Do not defeat the purpose of the grounding plug.

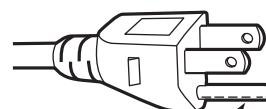

Do not remove

WARNING (USA and Canada)

- Not for use in a computer room as defined in the Standard for the Protection of Electronic Computer/Data Processing Equipment, ANSI/NFPA 75.
- For permanently connected equipment, a readily accessible disconnect device shall be incorporated in the building installation wiring.
- For pluggable equipment, the socket-outlet shall be installed near the equipment and shall be easily accessible.

NOTIFICATION (Canada)

This class A digital apparatus complies with Canadian ICES-003.

Contains mercury / Contenu avec mercure

For more information on safe handling procedures, the measures to be taken in case of accidental breakage and safe disposal options visit:

ec.gc.ca/mercure-mercury/.

Dispose of or recycle in accordance with applicable laws.

Pour plus de renseignements sur les procédures de manutention sécuritaire, les mesures à prendre en cas de bris accidentel et les options d'élimination sécuritaire visitez:

ec.gc.ca/mercure-mercury/.

Mettez au rebut ou recyclez conformément aux lois applicables.

NOTIFICATION (USA)

- This product has a High Intensity Discharge (HID) lamp that contains mercury. Disposal may be regulated in your community due to environmental considerations. For disposal or recycling information, please visit Panasonic website: <http://www.panasonic.com/environmental> or call 1-888-769-0149.

FCC NOTICE (USA)

Verification

Model Number: PT-VZ580, PT-VW540, PT-VX610
Trade Name: Panasonic
Responsible Party: Panasonic Corporation of North America
Address: Two Riverfront Plaza, Newark, NJ 07102-5490
General Contact: <http://www.panasonic.com/support>
Projector Contact: <https://panasonic.net/cns/projector/>

This device complies with Part 15 of the FCC Rules. Operation is subject to the following two conditions: (1) This device may not cause harmful interference, and (2) this device must accept any interference received, including interference that may cause undesired operation.

Caution:

This equipment has been tested and found to comply with the limits for a Class A digital device, pursuant to Part 15 of the FCC Rules. These limits are designed to provide reasonable protection against harmful interference when the equipment is operated in a commercial environment. This equipment generates, uses and can radiate radio frequency energy and, if not installed and used in accordance with the instructions manual, may cause harmful interference to radio communications. Operation of this equipment in a residential area is likely to cause harmful interference in which case the user will be required to correct the interference at his own expense.



FCC Warning:

To assure continued compliance, follow the attached installation instructions. This includes using the provided power cord and shielded interface cables when connecting to computer or peripheral devices. Also, any unauthorized changes or modifications to this equipment could void the user's authority to operate this device.

IMPORTANT: THE MOULDED PLUG

FOR YOUR SAFETY, PLEASE READ THE FOLLOWING TEXT CAREFULLY.

This appliance is supplied with a moulded three pin mains plug for your safety and convenience. A 13 amp fuse is fitted in this plug. Should the fuse need to be replaced, please ensure that the replacement fuse has a rating of 13 amps and that it is approved by ASTA or BSI to BS1362.

Check for the ASTA mark  or the BSI mark  on the body of the fuse.

If the plug contains a removable fuse cover, you must ensure that it is refitted when the fuse is replaced. If you lose the fuse cover, the plug must not be used until a replacement cover is obtained. A replacement fuse cover can be purchased from an Authorised Service Center.

If the fitted moulded plug is unsuitable for the mains socket in your home, then the fuse should be removed and the plug cut off and disposed of safely. There is a danger of severe electrical shock if the cut off plug is inserted into any 13 amp socket.

If a new plug is to be fitted, please observe the wiring code as shown below.

If in any doubt, please consult a qualified electrician.

WARNING: THIS APPLIANCE MUST BE EARTHED.

IMPORTANT: The wires in this mains lead are coloured in accordance with the following code:

Green - and - Yellow:	Earth
Blue:	Neutral
Brown:	Live

As the colours of the wire in the mains lead of this appliance may not correspond with the coloured markings identifying the terminals in your plug, proceed as follows.

The wire which is coloured GREEN - AND - YELLOW must be connected to the terminal in the plug which is marked with the letter E or by the Earth symbol  or coloured GREEN or GREEN - AND - YELLOW.

The wire which is coloured BLUE must be connected to the terminal in the plug which is marked with the letter N or coloured BLACK.

The wire which is coloured BROWN must be connected to the terminal in the plug which is marked with the letter L or coloured RED.

How to replace the fuse: Open the fuse compartment with a screwdriver and replace the fuse.

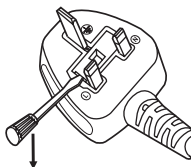

Importer's name and address within the European Union

Panasonic Marketing Europe GmbH

Panasonic Testing Centre

Winsbergring 15, 22525 Hamburg, Germany

WARNING:

■ POWER

The wall outlet or the circuit breaker shall be installed near the equipment and shall be easily accessible when problems occur. If the following problems occur, cut off the power supply immediately.

Continued use of the projector in these conditions will result in fire or electric shock.

- If foreign objects or water get inside the projector, cut off the power supply.
- If the projector is dropped or the cabinet is broken, cut off the power supply.
- If you notice smoke, strange smells or noise coming from the projector, cut off the power supply.

Please contact an Authorized Service Center for repairs, and do not attempt to repair the projector yourself.

During a thunderstorm, do not touch the projector or the cable.

Electric shocks can result.

Do not do anything that might damage the power cord or the power plug.

If the power cord is used while damaged, electric shocks, short-circuits or fire will result.

- Do not damage the power cord, make any modifications to it, place it near any hot objects, bend it excessively, twist it, pull it, place heavy objects on top of it or wrap it into a bundle.

Ask an Authorized Service Center to carry out any repairs to the power cord that might be necessary.

Completely insert the power plug into the wall outlet and the power connector into the projector terminal.

If the plug is not inserted correctly, electric shocks or overheating will result.

- Do not use plugs which are damaged or wall outlets which are coming loose from the wall.

Do not use anything other than the provided power cord.

Failure to observe this will result in fire or electric shocks. Please note that if you do not use the provided power cord to ground the device on the side of the outlet, this may result in electric shocks.

Clean the power plug regularly to prevent it from becoming covered in dust.

Failure to observe this will cause a fire.

- If dust builds up on the power plug, the resulting humidity can damage the insulation.
- If not using the projector for an extended period of time, pull the power plug out from the wall outlet.

Pull the power plug out from the wall outlet and wipe it with a dry cloth regularly.

Do not handle the power plug and power connector with wet hands.

Failure to observe this will result in electric shocks.

Do not overload the wall outlet.

If the power supply is overloaded (ex., by using too many adapters), overheating may occur and fire will result.

■ ON USE/INSTALLATION

Do not place the projector on soft materials such as carpets or sponge mats.

Doing so will cause the projector to overheat, which can cause burns, fire or damage to the projector.

Do not set up the projector in humid or dusty places or in places where the projector may come into contact with oily smoke or steam.

Using the projector under such conditions will result in fire, electric shocks or deterioration of components. Oil may also distort the plastic and the projector could fall such as when mounted on the ceiling.

Do not install this projector in a place which is not strong enough to take the full weight of the projector or on top of a surface which is sloped or unstable.

Failure to observe this will cause projector to fall down or tip over the projector, and severe injury or damage could result.

Installation work (such as ceiling mount bracket) should only be carried out by a qualified technician.

If installation is not carried out and secured correctly, it can cause injury or accidents, such as electric shocks.

- Be sure to use the wire provided with the ceiling mount bracket as an extra safety measure to prevent the projector from falling down. (Install in a different location to the ceiling mount bracket.)

Do not cover the air intake/exhaust ports.

Doing so will cause the projector to overheat, which can cause fire or damage to the projector.

- Do not place the projector in narrow, badly ventilated places.
- Do not place the projector on cloth or papers, as these materials could be drawn into the air intake port.
- Provide at least 1 m (39-3/8") of space between any walls or objects and the exhaust port, and at least 50 cm (19-11/16") of space between any walls or objects and the intake port.

WARNING:

Do not place your hands or other objects close to the air exhaust port.

Doing so will cause burns or damage your hands or other objects.

- Heated air comes out of the air exhaust port. Do not place your hands or face, or objects which cannot withstand heat close to this port.

Do not look at and place your skin into the lights emitted from the lens while the projector is being used.

Doing so can cause burns or loss of sight.

- Strong light is emitted from the projector's lens. Do not look at or place your hands directly into this light.
- Be especially careful not to let young children look into the lens. In addition, turn off the power and disconnect the power plug when you are away from the projector.

Never attempt to remodel or disassemble the projector.

High voltages can cause fire or electric shocks.

- For any inspection, adjustment and repair work, please contact an Authorized Service Center.

Do not allow metal objects, flammable objects, or liquids to enter inside of the projector. Do not allow the projector to get wet.

Doing so may cause short circuits or overheating, and result in fire, electric shock, or malfunction of the projector.

- Do not place containers of liquid or metal objects near the projector.
- If liquid enters inside of the projector, consult your dealer.
- Particular attention must be paid to children.

Use the ceiling mount bracket specified by Panasonic.

Using the ceiling mount bracket other than the specified one will result in falling accidents.

- Attach the supplied safety cable to the ceiling mount bracket to prevent the projector from falling down.

■ ACCESSORIES

Do not use or handle the batteries improperly, and refer to the following.

Failure to observe this will cause burns, batteries to leak, overheat, explode or catch fire.

- Do not use unspecified batteries.
- Do not charge dry cell batteries.
- Do not use chargeable batteries.
- Do not disassemble dry cell batteries.
- Do not heat the batteries or place them into water or fire.
- Do not allow the + and – terminals of the batteries to come into contact with metallic objects such as necklaces or hairpins.
- Do not store or carry batteries together with metallic objects.
- Store the batteries in a plastic bag and keep them away from metallic objects.
- Make sure the polarities (+ and –) are correct when inserting the batteries.
- Do not use a new battery together with an old battery or mix different types of batteries.
- Do not use batteries with the outer cover peeling away or removed.

Do not allow children to reach the batteries.

Accidentally swallowing them can cause physical harm.

- If swallowed, seek medical advice immediately.

If the battery fluid leaks, do not touch it with bare hands, and take the following measures if necessary.

- Battery fluid on your skin or clothing could result in skin inflammation or injury.
Rinse with clean water and seek medical advice immediately.
- Battery fluid coming in contact with your eyes could result in loss of sight.
In this case, do not rub your eyes. Rinse with clean water and seek medical advice immediately.

Do not remove unspecified screws during the lamp unit replacement.

Doing so can cause electric shocks, burns, or injury.

Do not disassemble the lamp unit.

If the lamp breaks, it could cause injury.

WARNING:

Lamp replacement

The lamp has high internal pressure. If improperly handled, an explosion and severe injury or accidents will result.

- The lamp can easily explode if struck against hard objects or dropped.
- Before replacing the lamp unit, be sure to turn the power off and to disconnect the power plug from the wall outlet. Electric shocks or explosions can result if this is not done.
- When replacing the lamp, turn the power off and allow the lamp to cool for at least 1 hour before handling it otherwise it can cause burns.

Remove the depleted batteries from the remote control promptly.

- Leaving them in the unit may result in fluid leakage, overheating, or explosion of the batteries.

CAUTION:

■ POWER

When disconnecting the power cord, be sure to hold the power plug and power connector.

If the power cord itself is pulled, the lead will become damaged, and fire, short-circuits or serious electric shocks will result.

When not using the projector for an extended period of time, disconnect the power plug from the wall outlet.

Failure to do so may result in fire or electric shock.

Disconnect the power plug from the wall outlet before carrying out any cleaning and replacing the unit.

Failure to do so may result in electric shock.

■ ON USE/INSTALLATION

Do not place heavy objects on top of the projector.

Failure to observe this will cause the projector to become unbalanced and fall, which could result in damage or injury. The projector will be damaged or deformed.

Do not put your weight on this projector.

You could fall or the projector could break, and injury will result.

- Be especially careful not to let young children stand or sit on the projector.

Do not place the projector in extremely hot locations.

Doing so will cause the outer casing or internal components to deteriorate, or result in fire.

- Take particular care in locations exposed to direct sunlight or near stoves.

Do not install the projector in a location where salt pollution or corrosive gas may occur.

- Doing so may result in falling due to corrosion. Also, it may result in malfunctions.

Do not stand in front of the lens while the projector is being used.

Doing so can cause damage and burns to clothing.

- Strong light is emitted from the projector's lens.

Do not place objects in front of the lens while the projector is being used.

Doing so can cause fire, damage to an object, or malfunction of the projector.

- Strong light is emitted from the projector's lens.

Always disconnect all cables before moving the projector.

Moving the projector with cables still attached can damage the cables, which will cause fire or electric shocks to occur.

When mounting the projector on the ceiling, keep mounting screws and power cord from contact with metal parts inside the ceiling.

Contact with metal parts inside the ceiling can cause electric shocks.

Never plug headphones and earphones into <VARIABLE AUDIO OUT> terminal.

Excessive sound pressure from earphones and headphones can cause hearing loss.

Do not project an image with the lens cap attached.

Doing so can cause fire.

CAUTION:

■ **ACCESSORIES**

Do not use the old lamp unit.

If used it could cause lamp explosion.

If the lamp has broken, ventilate the room immediately. Do not touch or bring your face close to the broken pieces.

Failure to observe this will cause the user to absorb the gas which was released when the lamp broke and which contains nearly the same amount of mercury as fluorescent lamps, and the broken pieces will cause injury.

- If you believe that you have absorbed the gas or that the gas has got into your eyes or mouth, seek medical advice immediately.
- Ask your dealer about replacing the lamp unit and check the inside of the projector.

When not using the projector for an extended period of time, remove the batteries from the remote control.

Failure to observe this will cause the batteries to leak, overheat, catch fire or explode, which may result in fire or contamination of surrounding area.

Do not open the desiccant bag, or do not eat the contents.

If swallowed the contents of the desiccant bag accidentally, it may cause bad result to your body.

- If the desiccant gets into your eyes or mouth, immediately rinse with clean water and seek medical advice.
- Be especially careful not to let children reach the desiccant.

■ **MAINTENANCE**

Do not attach the air filter unit while it is wet.

Doing so may result in electric shock or malfunctions.

- After you clean the air filter units, dry them thoroughly before reattaching them.

Ask your dealer about cleaning inside the projector once a year.

Continuous use while dust is accumulated inside the projector may result in fire.

- For cleaning fee, ask your dealer.

To remove the battery

1. Press the guide and lift the cover.

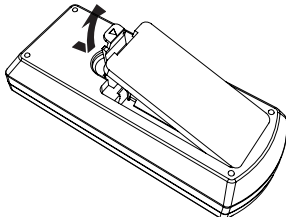

2. Remove the batteries.

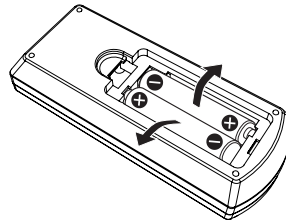

Brazil Only Brasil Apenas

Manuseio de baterias usadas



BRASIL

Após o uso, as pilhas e /ou baterias deverão ser entregues ao estabelecimento comercial ou rede de assistência técnica autorizada.

Cobrir os terminais positivo (+) e negativo (-) com uma fita isolante adesiva, antes de depositar numa caixa destinada para o recolhimento. O contato entre partes metálicas pode causar vazamentos, gerar calor, romper a blindagem e produzir fogo. (Fig. 1)

Fig. 1
Como isolar os terminais

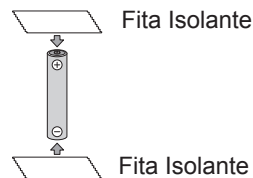

Não desmonte, não remova o invólucro, nem amasse a bateria. O gás liberado pela bateria pode irritar a garganta, danificar o lacre do invólucro ou o vazamento provocar calor, ruptura da blindagem e produzir fogo devido ao curto circuito dos terminais. Não incinere nem aqueça as baterias, elas não podem ficar expostas a temperaturas superiores a 100 °C (212 °F). O gás liberado pela bateria pode irritar a garganta, danificar o lacre do invólucro ou o vazamento provocar calor, ruptura da blindagem e produzir fogo devido ao curto circuito dos terminais provocado internamente.

Evite o contato com o líquido que vazar das baterias. Caso isto ocorra, lave bem a parte afetada com bastante água. Caso haja irritação, consulte um médico.

Remoção das baterias

1. Pressione a guia e levante a tampa.

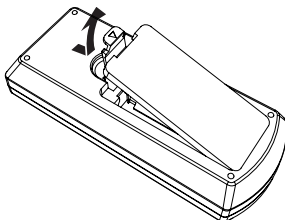

2. Remova as baterias.

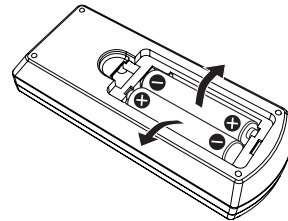

■ Trademarks

- The terms HDMI and HDMI High-Definition Multimedia Interface, and the HDMI Logo are trademarks or registered trademarks of HDMI Licensing Administrator, Inc. in the United States and other countries.
- PJLink™ is a trademark or pending trademark in Japan, the United States, and other countries and regions.
- RoomView, Crestron RoomView are registered trademarks of Crestron Electronics, Inc, and Crestron Connected™ and Fusion RV are trademarks of Crestron Electronics, Inc.
- Windows, Internet Explorer and Microsoft Edge are registered trademarks or trademarks of Microsoft Corporation in the United States and other countries.
- Mac, Mac OS and Safari are trademarks of Apple Inc., registered in the United States and other countries.
- Adobe, Adobe Flash Player and Adobe Reader are trademarks or registered trademarks of Adobe Systems Inc. in the United States and/or other countries.
- Some of the fonts used in the on-screen menu are Ricoh bitmap fonts, which are manufactured and sold by Ricoh Company, Ltd.
- Other names, company names or product names used in these operating instructions are the trademarks or registered trademarks of their respective holders.
Please note that the operating instructions do not include the ® and ™ symbols.

■ Illustrations in these operating instructions

- Note that illustrations of the projector and screens may differ from the ones you actually see.
- The illustrations displayed on the computer screen may differ depending on the computer type and its operating system.

■ Page references

- Reference pages in this manual are indicated as: (➡ page 00).

■ Term

- In this manual, the “Wireless remote control unit” accessory is referred to as the “Remote control”.

Features of the Projector

Excellent Basic Performance

- ▶ Unique optical system, lamp dimming system and the DAYLIGHT VIEW function allow you to project a good-quality image even in a bright room.
- ▶ It has many useful functions such as compact design for portability and multiple input interface etc.

Easy Setup

- ▶ The adoption of 1.6x optical zoom and the lens shift function ensures highly flexible setup of the projector.
- ▶ KEYSTONE, CORNER CORRECTION and CURVED CORRECTION functions allow easy correction of various image distortions occurred in the installation location.

Maintenance cost down

- ▶ The long life lamp with new lamp driving system and the water wash enabled long life filter have greatly reduced the maintenance time and the cost.

Quick Steps

For details, refer to the corresponding pages.

1. **Set up your projector.**
(➡ page 29)



2. **Connect with external devices.**
(➡ page 34)



3. **Connect the power cord.**
(➡ page 38)



4. **Power on.**
(➡ page 39)



5. **Make initial settings.**
(➡ page 40)

- Take this step when you power on for the first time after purchasing the projector.



6. **Select the input signal.**
(➡ page 44)



7. **Adjust the image.**
(➡ page 45)

Chapter 1 Preparation

This chapter describes things you need to know or check before using the projector.

Precautions for use

Cautions when transporting

- When transporting the projector, hold it securely by its bottom and avoid excessive vibration and impacts. Doing so may damage the internal parts and result in malfunctions.
- Do not transport the projector with the adjustable feet extended. Doing so may damage the adjustable feet.

Cautions when installing

■ Do not set up the projector outdoors.

The projector is designed for indoor use only.

■ Do not use under the following conditions.

- Places where vibration and impacts occur such as in a car or vehicle: Doing so may damage the internal parts and result in malfunctions.
- Location close to sea or where corrosive gas may occur: the projector may fall due to corrosion. Also, failure to do so may shorten the life of the components and result in malfunction.
- Near the exhaust of an air conditioner: Depending on the conditions of use, the screen may fluctuate in rare cases due to the heated air from the air exhaust port or the hot or cooled air. Make sure that the exhaust from the projector or other equipment, or the air from the air conditioner does not blow toward the front of the projector.
- Places with sharp temperature fluctuations such as near lights (studio lamps): Doing so may shorten the life of the luminous lamp, or result in deformation of the outer case due to heat, which may cause malfunction. Make sure to observe the operating temperature range of the projector.
- Near high-voltage power lines or near motors: Doing so may interfere with the operation of the projector.

■ Be sure to ask a specialized technician or your dealer when installing the product to a ceiling.

This requires an optional ceiling mount bracket. Be sure to use the Projector Mount Bracket together with the ceiling mount bracket for high ceilings or low ceilings.

Model No.:

- ① ET-PKL100H (for high ceilings), ET-PKV400B (Projector Mount Bracket)
- ② ET-PKL100S (for low ceilings), ET-PKV400B (Projector Mount Bracket)

■ Focus adjustment

The projection lens is thermally affected by the light from the light source, making the focus unstable in the period just after switching on the power. It is recommended that the images are projected continuously for at least 30 minutes before the focus is adjusted.

■ Do not install the projector at elevations of 2 700 m (8 858') or higher above sea level.

■ Do not use the projector in a location that the ambient temperature exceed 40 °C (104 °F).

Using the projector in a location that the altitude is too high or the ambient temperature is too high may shorten the life of the components or result in malfunctions.

The upper limit of the operating temperature of the projector varies depending on the altitudes of the operating environment.

When using it at altitudes below 1 200 m (3 937') above sea level: 0 °C (32 °F) ~ 40 °C (104 °F)

When using it at altitudes between 1 200 m (3 937') and 2 700 m (8 858') above sea level: 0 °C (32 °F) ~ 30 °C (86 °F)

■ Do not tilt the projector or place it on its side.

Do not tilt the projector body more than approximately ± 30 degrees longitudinally or ± 15 degrees laterally. Over tilting may result in shortening the life of the components.

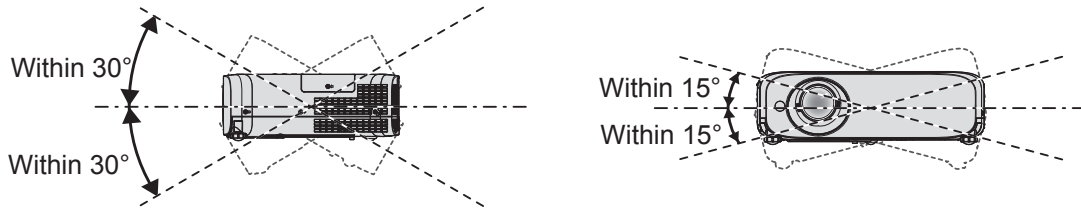

Cautions when setting the projectors

- Use the adjustable feet only for the floor standing installation and for adjusting the angle. Using them for other purposes may damage the projector.
- When installing the projector with a method other than the floor installation using the adjustable feet or the ceiling installation, use the four screw holes for ceiling mount (as shown in the figure) to fix the projector to the mount. For details about the screw hole position for ceiling mount, refer to “Screw hole specifications for ceiling mount” (➔ page 132).

(Screw diameter: M4, tapping depth inside the projector: 8 mm (5/16"), torque: 1.25 ± 0.2 N·m)

In such case, make sure that there is no clearance between the screw holes for ceiling mount on the projector bottom and the setting surface by inserting spacers (metallic).

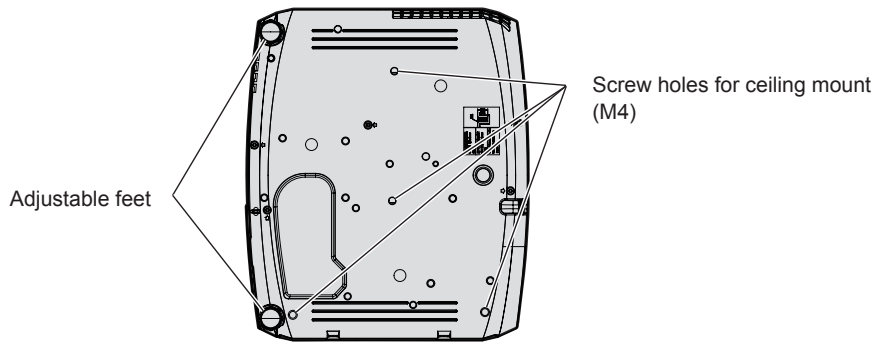

Positions of screw holes for ceiling mount and adjustable feet

- Do not stack the projectors.
- Do not use the projector supported by its top.
- Do not block the ventilation ports (intake and exhaust) of the projector.
- Avoid heating and cooling air from the air conditioning system directly blow to the ventilation ports (intake and exhaust) of the projector.

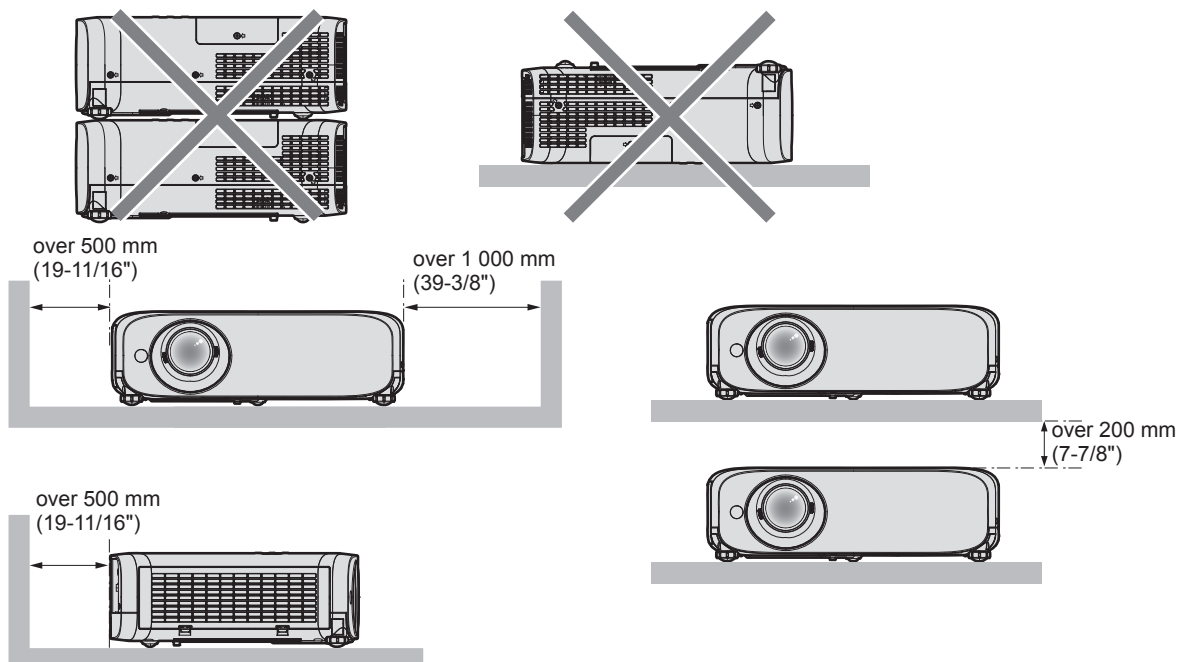

- Do not install the projector in a confined space.
When placing the projector in a confined space, a ventilation and/or air conditioning system is required. Exhaust heat may accumulate when the ventilation is not enough, triggering the protection circuit of the projector.
- Panasonic takes no responsibility for any damage to the product caused by an inappropriate choice of location for installing the projector, even if the warranty period of the product has not expired.

Security

When using this product, take safety measures against the following incidents.

- Personal information being leaked via this product
- Unauthorized operation of this product by a malicious third party
- Interfering or stopping of this product by a malicious third party

Take sufficient security measures.

- Make your password as difficult to guess as possible.
- Change your password periodically. The password can be set in the [SECURITY] menu → [PASSWORD CHANGE].
- Panasonic Corporation or its affiliate company never inquires a password directly to a customer. Do not tell your password in case you receive such an inquiry.
- The connecting network must be secured by firewall or others.
- Set a password for web control function appropriately and restrict the users who can log in. The password for the web control function can be set on the [Change password] page of the web control screen.

Early Warning Software

The projector supports “Early Warning Software”, which monitors the status of the display devices (projector or flat panel display) and the peripheral devices inside an intranet, and notifies of abnormality of such equipment and detects signs of possible abnormality. Also, maintenance can be performed in advance, because this software gives notification of approximate time to replace consumables of the display, to clean each part of the display, and to replace the components of the display.

Depending on the type of license, the number of displays that can be registered for monitoring varies. Limited to the first 90 days after installation in a computer, it is possible to register up to 2048 units of displays free of charge.

Download the software from the Panasonic website (<https://panasonic.net/cns/projector/pass/>). It is necessary to register and login to PASS^{*1} to download.

*1 PASS: Panasonic Professional Display and Projector Technical Support Website

Visit the Panasonic website (<https://panasonic.net/cns/projector/pass/>) for details.

Storage

When storing the projector, keep it in a dry room.

Disposal

To dispose of the product, ask your local authorities or dealer for correct methods of disposal.

The luminous lamp contains mercury. When disposing of used lamp units, contact your local authorities or dealer for correct methods of disposal.

Cautions on use

■ To get a good picture quality

In order to view a beautiful image in higher contrast, prepare an appropriate environment. Draw curtains or blinds over windows and turn off any lights near the screen to prevent outside light or light from indoor lamps from shining onto the screen.

■ Do not touch the surface of the projector lens with your bare hands.

If the surface of the lens becomes dirty from fingerprints or anything else, this will be magnified and projected onto the screen.

It is recommended to attach the supplied lens cap to the projection lens when you do not use the projector.

■ LCD panel

The LCD panel is precision-made. Note that in rare cases, pixels could be missing or always lit. Note that such phenomena do not indicate malfunction.

If still images are projected for a long time, a residual image may remain on the LCD panel. In this case, project the all white screen for over an hour. Note that the residual image may not disappear.

■ Optical parts

When the operating environment temperature is high or in environments where lots of dust, cigarette smoke, etc. is present, the replacement cycle of the LCD panel, polarizing plate and other optical parts may be shorter even if used for less than one year. Consult your dealer for details.

■ Luminous lamp

The light source of the projector is a high-pressure mercury lamp.

A high-pressure mercury lamp has the following characteristics.

- The luminance of the luminous lamp will decrease by duration of usage.
- The luminous lamp may burst with a loud sound or have its service life shortened because of shock, chipping, or degradation due to cumulative runtime.
- The luminous lamp life varies greatly depending on individual differences and usage conditions. In particular, continuous use for 12 hours or more and frequent off/on switching of the power greatly deteriorate the luminous lamp and affect the luminous lamp life.
- In rare cases, the luminous lamp burst shortly after the projection.
- The risk of bursting increases when the luminous lamp is used beyond its replacement cycle. Make sure to replace the lamp unit according to the proper replacement time ("When to replace the lamp unit" (➡ page 114) and "How to replace the lamp unit" (➡ page 115))
- If the luminous lamp bursts, gas contained inside of the luminous lamp is released in a form of smoke.
- It is recommended to store replacement lamps for contingency.

■ Computer and external device connections

When connecting a computer or an external device, read this manual carefully regarding the use of power cords and shielded cables as well.

Accessories

Make sure the following accessories are provided with your projector. Numbers enclosed < > show the number of accessories.

Wireless remote control unit <1>
(N2QAYA000088)

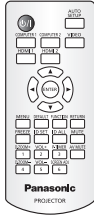

CD-ROM <1>
(1JK1VZ580)

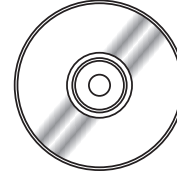

Power cord
(TXFSX02UXRZ)

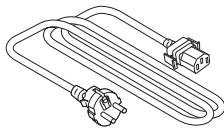

(TXFSX02UYAZ)

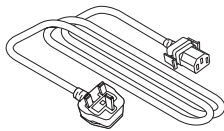

(TXFSX02UFEZ)

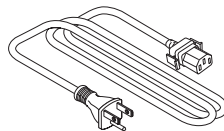

AAA/R03 or AAA/LR03 battery <2>

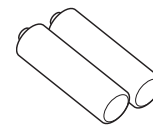

(for remote control unit)

String <1>
(6103504711)

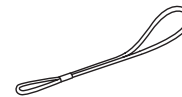

(for lens cap)

RGB signal cable <1>
(K1HY15YY0012)

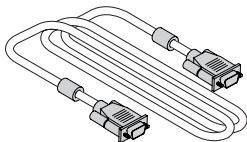

Lens cap <1>
(TKKL5573)
(For PT-VZ580)

(TKKL5577)
(For PT-VW540 and
PT-VX610)



(Attached to the projector at the time of purchase)

Attention

- After unpacking the projector, discard the power cord cap and packaging material properly.
- Do not use the supplied power cord for devices other than this projector.
- For lost accessories, consult your dealer.
- Store small parts in an appropriate manner, and keep them away from young children.

Note

- The type and number of the power cord depend on the country in which you purchased the product.
- The model numbers of accessories are subject to change without prior notice.

Contents of the supplied CD-ROM

The contents of the supplied CD-ROM are as follow.

Instruction / list (PDF)	Operating Instructions	
	Operating Instructions – Multi Monitoring & Control Software	
	Operating Instructions – Logo Transfer Software	
	List of Compatible Device Models	This is a list of projectors that are compatible with the software contained in the CD-ROM and their restrictions.
Software	Multi Monitoring & Control Software (Windows)	This software allows you to monitor and control multiple displays (projector or flat panel display) connected to the LAN.
	Logo Transfer Software (Windows)	This software allows you to transfer original images, such as company logos to be displayed when projection starts, to the projector.

Note

- The “List of Compatible Device Models” for the flat panel display compatible with the “Multi Monitoring & Control Software” can be downloaded from the Panasonic website (<https://panasonic.net/cns/prodisplays/>).

Optional accessories

Options	Model No.
Ceiling Mount Bracket	ET-PKL100H (for high ceilings), ET-PKL100S (for low ceilings), ET-PKV400B (Projector Mount Bracket)
Replacement Lamp Unit	ET-LAV400
Replacement Filter Unit	ET-RFV410
Early Warning Software (Basic license/3-year license)	ET-SWA100 Series*1

*1: The suffix of the Model No. differs according to the license type.

Note

- The model numbers of optional accessories are subject to change without prior notice.

About your projector

Remote control

■ Front

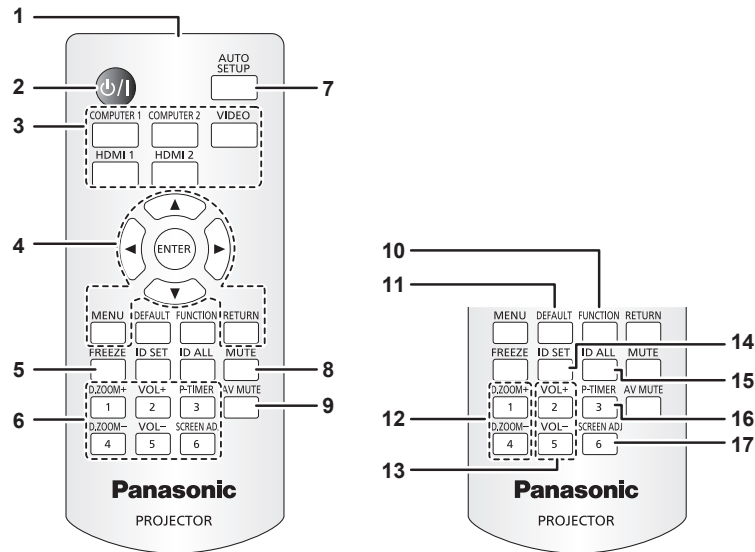

- 1 Remote control signal transmitter**
- 2 Power <⏻/⏻> button (⏻ standby / ⏻ power on)**
Sets the projector to the state where the projector is switched off (standby mode). Also starts projection when the power is switched off (standby mode).
- 3 Input selection buttons (<COMPUTER 1> / <COMPUTER 2> / <VIDEO> / <HDMI 1> / <HDMI 2>)**
Switches the input signal to project. (➡ page 44)
- 4 <MENU> button / <RETURN> button / ▲▼◀▶ buttons / <ENTER> button**
Used to operate the menu screen. (➡ page 53)
The ▲▼◀▶ buttons are also used to enter password or characters for [SECURITY].
- 5 <FREEZE> button**
Pauses the projected image and mute the audio temporarily. (➡ page 49)
- 6 Number (<1> - <6>) buttons**
Used for entering an ID number in a multiple projector environment or a password.
- 7 <AUTO SETUP> button**
Used to perform automatic adjustment while projecting the image. (➡ page 49)
- 8 <MUTE> button**
Used to temporarily mute the projector. (➡ page 48)
- 9 <AV MUTE> button**
Used to turn off the audio and video temporarily. (➡ page 48)
- 10 <FUNCTION> button**
Assigns a frequently used operation as a shortcut button. (➡ page 50)
- 11 <DEFAULT> button**
Resets the content of the sub-menu to the factory default. (➡ page 54)
- 12 <D.ZOOM +> button / <D.ZOOM -> button**
Zooms in and out the images. (➡ page 50)
- 13 <VOL +> button / <VOL -> button**
Adjusts the volume level of the built-in speaker or the audio output. (➡ page 48)
- 14 <ID SET> button**
Sets the ID number of the remote control in a multiple projector environment. (➡ page 26)
- 15 <ID ALL> button**
Used to simultaneously control all the projectors with one remote control when using multiple projectors. (➡ page 26)
- 16 <P-TIMER> button**
Operates the presentation timer function. (➡ page 51)
- 17 <SCREEN ADJ> button**
Corrects the distortion of the projected image. (➡ page 49)

Attention

- Do not drop the remote control.
 - Avoid contact with liquids.
 - Do not attempt to modify or disassemble the remote control.
 - Please observe the following contents that are described on the back of the remote control unit (see the picture below).
 - Do not use a new battery together with an old battery.
 - Do not use unspecified batteries.
 - Make sure the polarities (+ and -) are correct when inserting the batteries.
- In addition, please read the contents that are related to batteries in the "Read this first!".

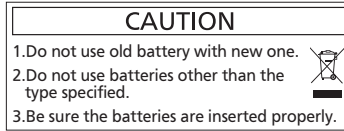

Caution label at the back of the remote control

Note

- The remote control can be used within a distance of about 7 m (22'11-5/8") if pointed directly at the remote control signal receiver. The remote control can control at angles of up to $\pm 30^\circ$ vertically and $\pm 30^\circ$ horizontally, but the effective control range may be reduced.
- If there are any obstacles between the remote control and the remote control signal receiver, the remote control may not operate correctly.
- You can operate the projector by reflecting the remote control signal on the screen. The operating range may differ due to the loss of light caused by the properties of the screen.
- When the remote control signal receiver is lit with a fluorescent light or other strong light source, the projector may become inoperative. Set the projector as far from the luminous source as possible.

Projector body

■ Front

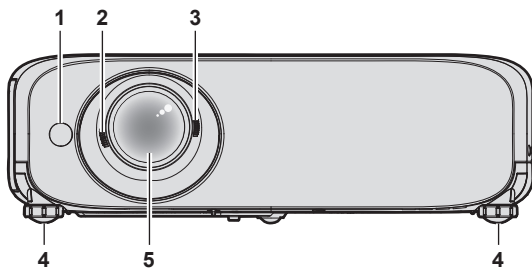

■ Side

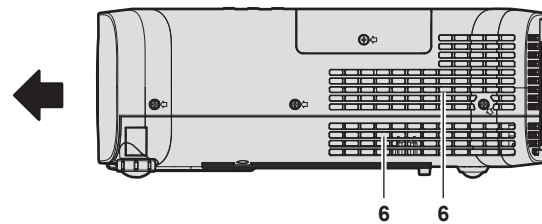

■ Rear

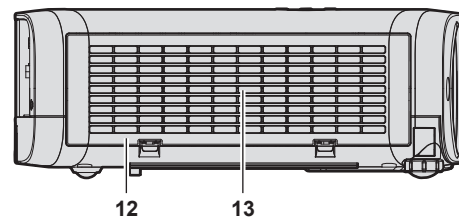
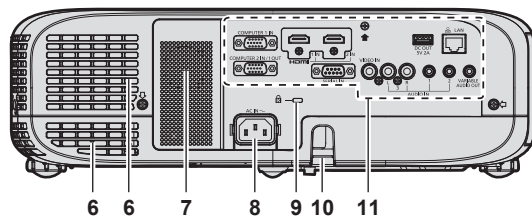

← : Projection direction

WARNING

Keep your hands and other objects away from the air exhaust port.

- Keep your hands and face away.
- Do not insert your fingers.
- Keep heat-sensitive objects away.

Heated air from the air exhaust port can cause burns, injury, or deformations.

- 1 Remote control signal receiver
- 2 Focus Lever
Adjusts the focus.
- 3 Zoom Lever
Adjusts the zoom.

- 4 Adjustable feet
Adjusts the projection angle.
- 5 Projection Lens
- 6 Air exhaust port
- 7 Speaker
- 8 <AC IN> terminal
Connects the supplied power cord.
- 9 Security slot
This security slot is compatible with the Kensington security cables.
- 10 Burglar hook port
Attaches a burglar prevention cable, etc.
- 11 Connecting terminals (➡ page 25)
- 12 Air filter cover
The air filter unit is inside.
- 13 Air intake port

■ Top

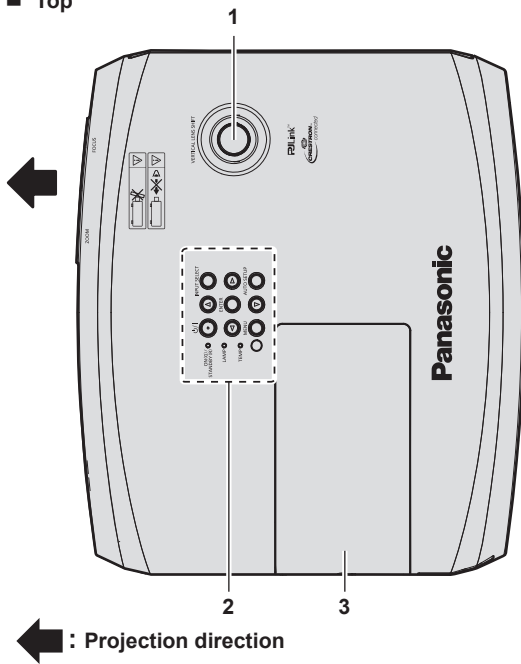

■ Bottom

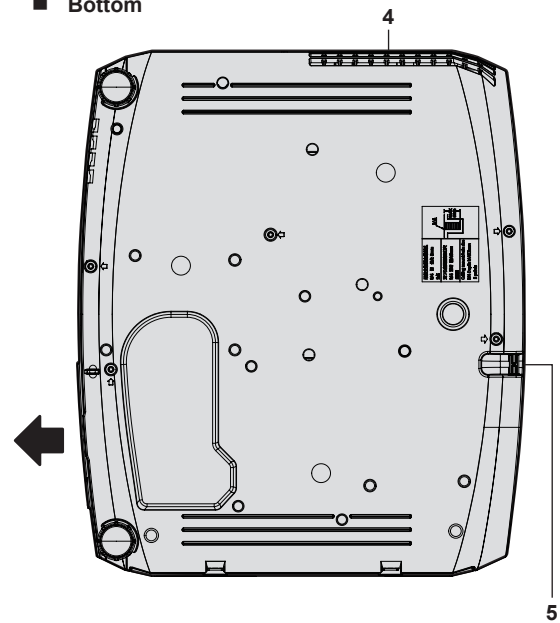

- 1 **Vertical lens shift dial**
Adjusts the projecting position in the vertical direction (vertical shift).
- 2 **Control panel and Indicators** (➔ page 24)
- 3 **Lamp cover**
The luminous lamp is inside.

- 4 **Air exhaust port**
- 5 **Burglar hook port**
Attaches a burglar prevention cable, etc.

Attention

- Do not block the ventilation ports (intake and exhaust) of the projector.

■ **Control panel and Indicators**

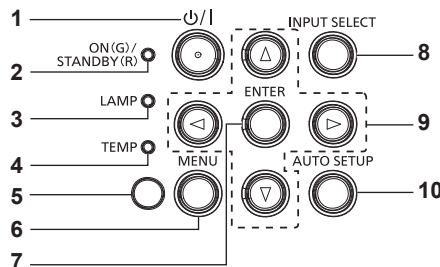

- 1 **Power button <power icon>** (power icon Standby / | Power on)
Sets the projector to the state where the projector is switched off (standby mode). Also starts projection when the power is switched off (standby mode).
- 2 **Power indicator <ON(G)/STANDBY(R)>**
Displays the status of the power.
- 3 **Lamp indicator <LAMP>**
Displays the status of the luminous lamp.
- 4 **Temperature indicator <TEMP>**
Displays the status of the internal temperature.
- 5 **Ambient luminance sensor** (➔ page 59)
- 6 **<MENU> button**
Displays or hides the main menu. (➔ page 53)
When the sub menu is displayed, pressing it will return to the previous screen.
- 7 **<ENTER> button**
Determines and executes an item in the menu screen.
- 8 **<INPUT SELECT> button**
Switches the input signal to project. (➔ page 44)
- 9 **▲▼◀▶ buttons**
Used to select the menu screen items, switch the setting or adjust the level.
Also used to enter a password in the [SECURITY] menu or enter characters.
- 10 **<AUTO SETUP> button**
Used to automatically adjust with auto setup function while projecting the image. (➔ page 49)

■ Connecting terminals

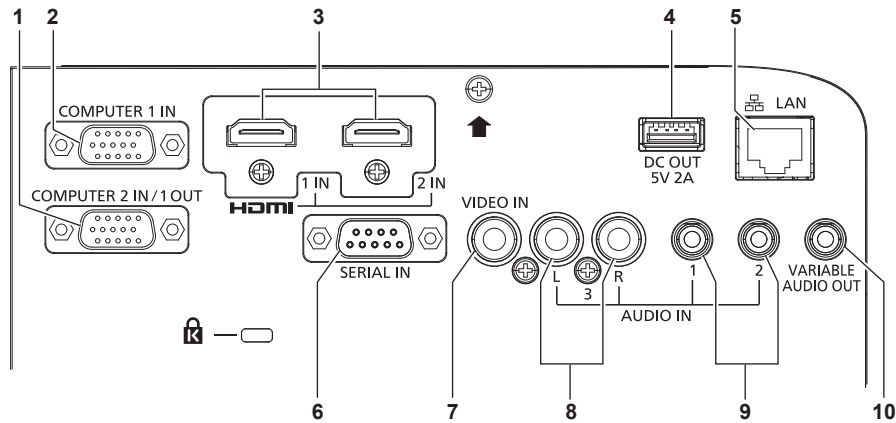

- | | |
|--|---|
| <p>1 <COMPUTER 2 IN/1 OUT> terminal
This is the terminal to input RGB signals or $Y C_B C_R / Y P_B P_R$ signals. It can also output the signals input from <COMPUTER 1 IN> terminal to an external device.</p> <p>2 <COMPUTER 1 IN> terminal
This is the terminal to input RGB signals or $Y C_B C_R / Y P_B P_R$ signals.</p> <p>3 <HDMI 1 IN> terminal / <HDMI 2 IN> terminal
These are the terminals to input HDMI signal.</p> <p>4 <DC OUT> terminal
This is the USB terminal only used for power supply (DC 5 V, maximum 2 A).
This can be used when a power is needed to be supplied to a wireless display adaptor, etc.</p> <p>5 <LAN> terminal
This is the LAN terminal to connect to the network.</p> | <p>6 <SERIAL IN> terminal
This is the RS-232C compatible terminal to externally control the projector by connecting a computer.</p> <p>7 <VIDEO IN> terminal
This is the terminal to input video signals.</p> <p>8 <AUDIO IN 3> terminal
This is the terminal to input audio signals.
Left input <L> and right input <R> are provided for the <AUDIO IN 3> terminal.</p> <p>9 <AUDIO IN 1> terminal / <AUDIO IN 2> terminal
These are the terminals to input audio signals.</p> <p>10 <VARIABLE AUDIO OUT> terminal
This is the terminal to output the input audio signal.</p> |
|--|---|

Attention

- When a LAN cable is directly connected to the projector, the network connection must be made indoors.

Preparing the remote control

Inserting and removing batteries

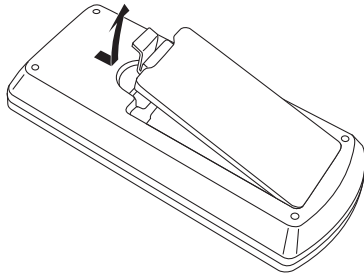

Fig. 1

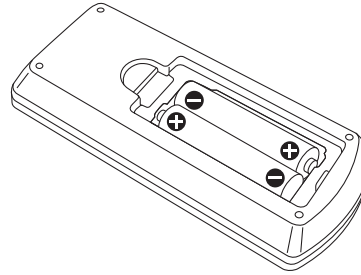

Fig. 2

- 1) Open the cover. (Fig. 1)
- 2) Insert batteries and close the cover (insert the "⊖" side first). (Fig. 2)
 - When removing the batteries, perform the steps in reverse order.

When using the system with multiple projectors

When you use the system with multiple projectors, you can operate all the projectors simultaneously or each projector individually by using single remote control, if a unique ID number is assigned to each projector.

When you want to set the ID number, at first you need to complete the Initial setting, and then after setting the ID number of the projector, set the ID number on the remote control. About Initial setting, please refer to "When the initial setting screen is displayed" (➔ page 40).

The factory default ID number of the unit (the projector and the remote control) is set to [ALL], you can control with this setting. If necessary, please set the ID number to the remote control and the projector. About how to set the ID number of the remote control, please refer to "Setting the ID number of the remote control" (➔ page 51).

Note

- Set the ID number of the projector from the [PROJECTOR SETUP] menu → [PROJECTOR ID].

Attaching the lens cap

When moving this projector or while not using it over an extended period of time, it is recommended to attach the lens cap to avoid contaminating the lens.

To prevent loss of the lens cap, please attach the lens cap with the string of accessories according to the following procedures.

- 1) Thread the thinner end of the string through the hole on the lens cap.

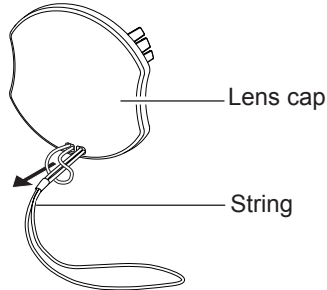

- 2) Thread the other side (the side with larger ring) of the string through the hole at the bottom of the projector and fasten it.

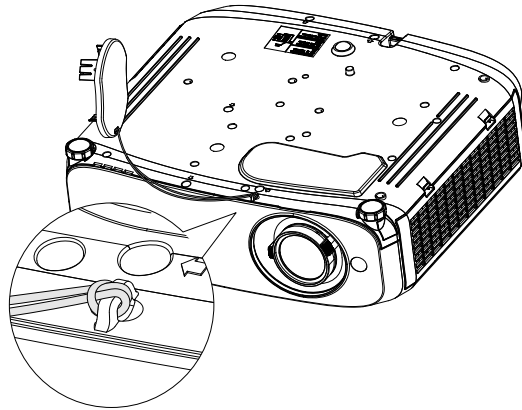

Chapter 2 Getting Started

This chapter describes things you need to do before using the projector such as the setup and connections.

Setting up

Installation mode

There are four ways to set up the projector. Set the [PROJECTOR SETUP] menu → [PROJECTION METHOD] (→ page 79) depending on the installation mode.

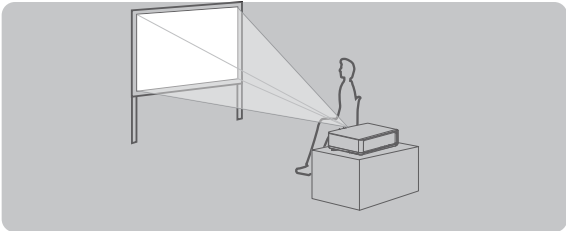
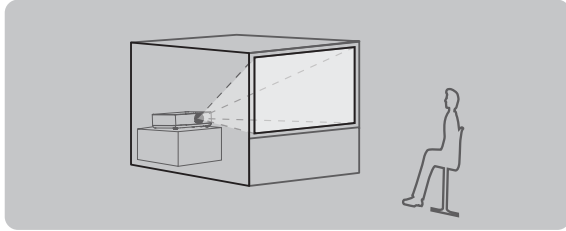
Setting on a desk/floor and projecting forward		Setting on a desk/floor and projecting from rear (Using the translucent screen)	
			
Menu item	Method	Menu item	Method
[PROJECTOR METHOD]	[AUTO] or [FRONT/DESK]	[PROJECTOR METHOD]	[REAR/DESK]

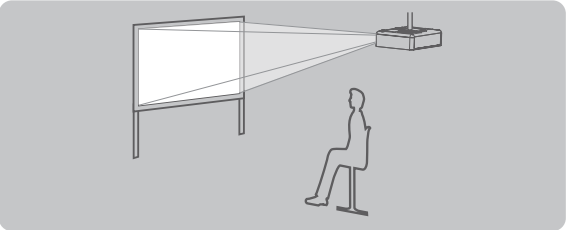
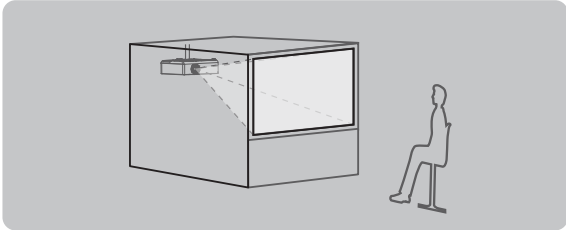
Mounting on the ceiling and projecting forward		Mounting on the ceiling and projecting from rear (Using the translucent screen)	
			
Menu item	Method	Menu item	Method
[PROJECTOR METHOD]	[AUTO] or [FRONT/CEILING]	[PROJECTOR METHOD]	[REAR/CEILING]

Note

- The projector has a built-in angle sensor. The attitude of the projector is automatically detected by setting the [PROJECTOR SETUP] menu → [PROJECTION METHOD] to [AUTO]. For rear projection, set the [PROJECTION METHOD] to [REAR/DESK] or [REAR/CEILING].

■ Angle sensor

The range of installation posture detected by the projector's built-in angle sensor is as follows.

In case of [AUTO], when the projector is placed with the top side upward within $\pm 30^\circ$ from the horizontal plane, it will switch to [FRONT/DESK] automatically; when the projector is placed with the top side downward within $\pm 30^\circ$ from the horizontal plane, it will switch to [FRONT/CEILING] automatically. Although it is detected as [FRONT/DESK] even when it exceeds $\pm 30^\circ$ with respect to the horizontal plane, do not use such installation posture in this range.

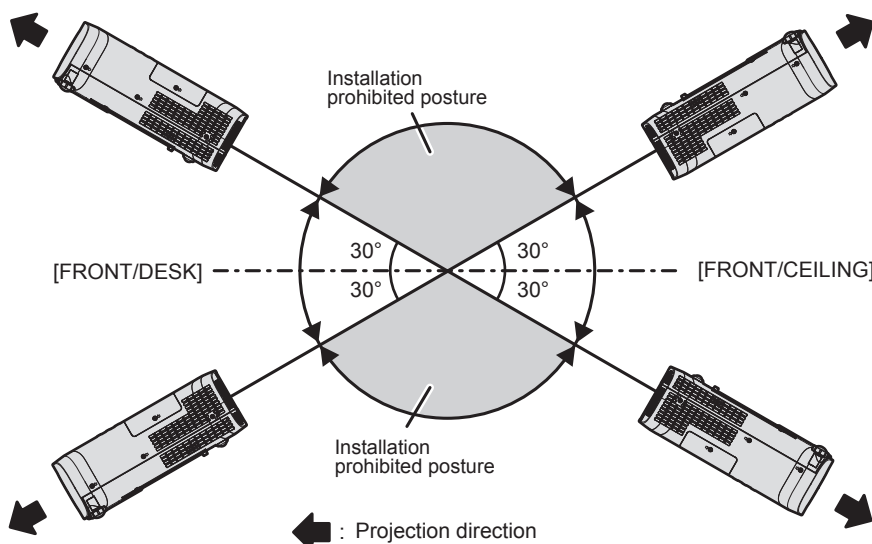

Attention

- The angle sensor cannot detect whether it is the “Installation prohibited posture” in the above figure. Do not use the projector tilted at an angle that exceeds $\pm 30^\circ$ from the horizontal plane. It may reduce the life of the components. (➔ page 16)

Parts for ceiling mount (optional)

This requires an optional ceiling mount bracket. Be sure to use the Projector Mount Bracket together with the ceiling mount bracket for high ceilings or low ceilings.

Model No.:

- ① **ET-PKL100H (for high ceilings), ET-PKV400B (Projector Mount Bracket)**
- ② **ET-PKL100S (for low ceilings), ET-PKV400B (Projector Mount Bracket)**

- Use only the ceiling mount brackets specified for this projector.
- Refer to the Installation Instructions for the ceiling mount bracket when you install the bracket and the projector.

Attention

- To ensure projector performance and security, installation of the ceiling mount bracket must be carried out by your dealer or a qualified technician.

Screen size and throw distance

Refer to the screen size and projection distances to install the projector. Image size and image position can be adjusted in accordance with the screen size and screen position.

- Following illustration is prepared on the assumption that the projected image size and position have been aligned to fit full in the screen.

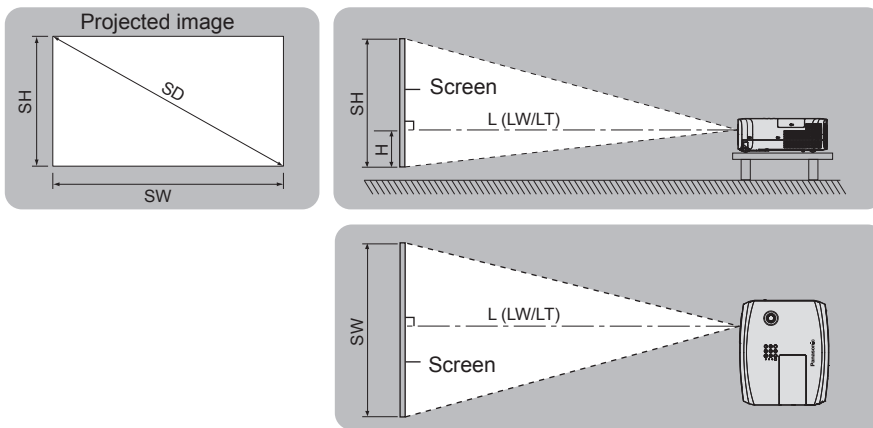

(Unit: m)

L (LW/LT) *1	Projection distance
SH	Image height
SW	Image width
H	Distance from the center of lens to the image lower end
SD	Projected image size

*1 LW : Minimum distance
 LT : Maximum distance

Attention

- Before installing, please read “Precautions for Use”. (➔ page 16)

[SCREEN ADJUSTMENT] projection range

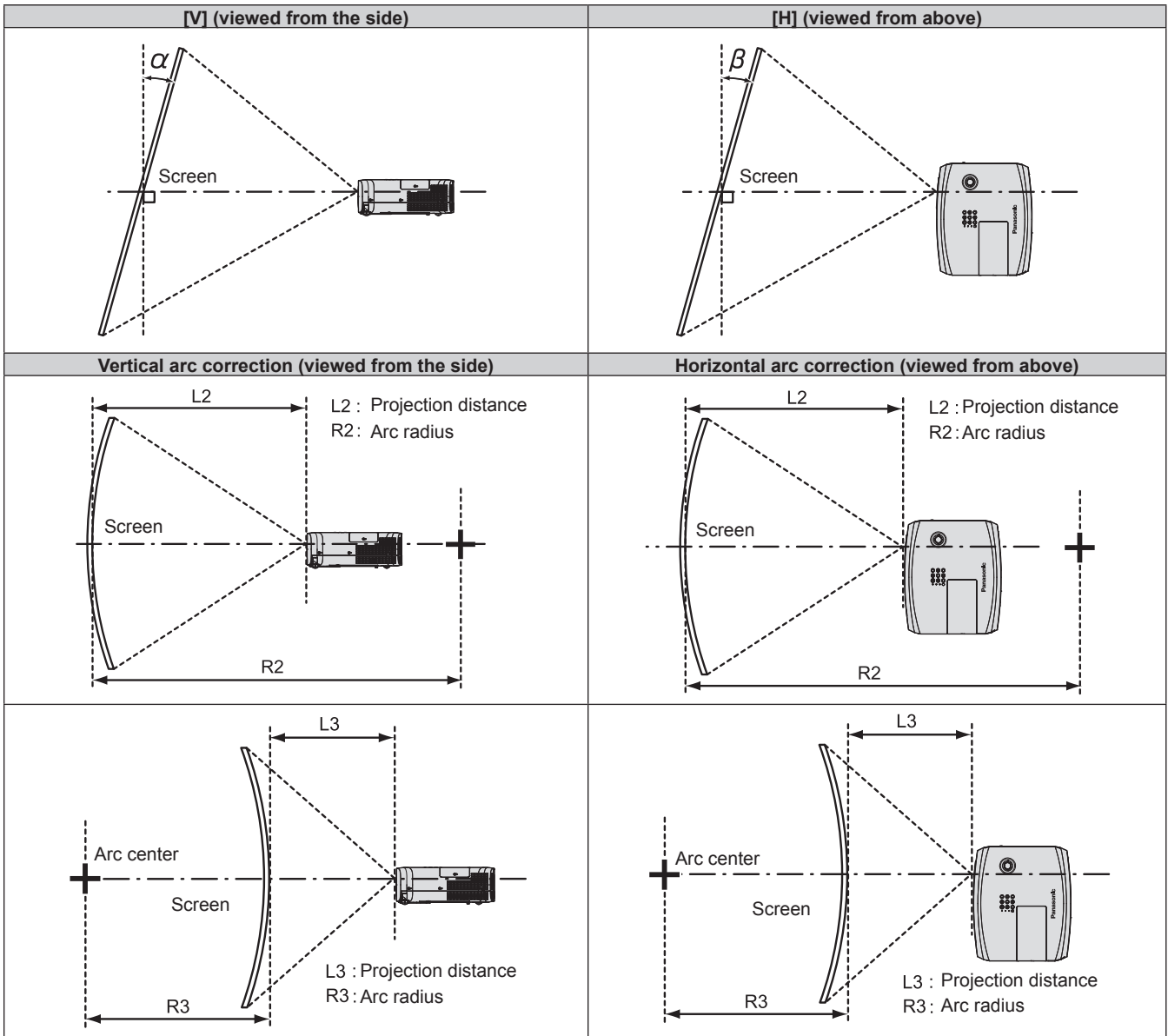

Model No.	Only [KEystone] used*1		[KEystone] and [CURVED CORRECTION] used together				Only [CURVED CORRECTION] used	
	Vertical keystone correction angle α (°)	Horizontal keystone correction angle β (°)	Vertical keystone correction angle α (°)	Horizontal keystone correction angle β (°)	Min. value of R2/L2	Min. value of R3/L3	Min. value of R2/L2	Min. value of R3/L3
PT-VZ580	±25	±30	±20	±15	1.4	2.9	0.7	1.6
PT-VW540	±35	±35	±20	±15	1.4	2.9	0.7	1.6
PT-VX610	±35	±35	±20	±15	1.4	2.9	0.7	1.6

*1 When the [KEystone] is corrected in both [V] and [H], the correction cannot be made if the total correction angle exceeds 55°.

Note

- When [SCREEN ADJUSTMENT] is used, the focus may not be able to match the whole screen as correction increases.
- The curved screen should be in the shape of a circular arc part of a perfect circle.

Projection distance

An error of $\pm 5\%$ may occur to the projection distance as described.

Also, it is corrected to become smaller than the specified image size when [SCREEN ADJUSTMENT] is used.

For PT-VZ580

(Unit: m)

Projection size Screen diagonal (SD)	16:10 aspect ratio			16:9 aspect ratio			4:3 aspect ratio		
	Minimum distance (LW)	Maximum distance (LT)	Distance from the lens center to the image lower end (H)	Minimum distance (LW)	Maximum distance (LT)	Distance from the lens center to the image lower end (H)	Minimum distance (LW)	Maximum distance (LT)	Distance from the lens center to the image lower end (H)
0.76 (30")	0.68	1.12	0.022 ~ 0.201	0.70	1.15	0.002 ~ 0.186	0.78	1.27	0.025 ~ 0.228
1.02 (40")	0.93	1.51	0.030 ~ 0.270	0.95	1.55	0.003 ~ 0.250	1.05	1.71	0.034 ~ 0.306
1.27 (50")	1.16	1.89	0.037 ~ 0.337	1.19	1.94	0.004 ~ 0.311	1.32	2.14	0.042 ~ 0.381
1.52 (60")	1.39	2.26	0.045 ~ 0.403	1.43	2.33	0.005 ~ 0.372	1.58	2.57	0.051 ~ 0.456
1.78 (70")	1.64	2.66	0.052 ~ 0.472	1.69	2.73	0.005 ~ 0.436	1.86	3.01	0.059 ~ 0.534
2.03 (80")	1.87	3.03	0.060 ~ 0.538	1.93	3.12	0.006 ~ 0.497	2.12	3.44	0.068 ~ 0.609
2.29 (90")	2.12	3.43	0.067 ~ 0.607	2.18	3.52	0.007 ~ 0.561	2.40	3.88	0.076 ~ 0.687
2.54 (100")	2.35	3.80	0.075 ~ 0.673	2.42	3.91	0.008 ~ 0.622	2.67	4.31	0.085 ~ 0.762
3.05 (120")	2.83	4.57	0.090 ~ 0.808	2.91	4.70	0.009 ~ 0.747	3.21	5.18	0.102 ~ 0.915
3.81 (150")	3.54	5.72	0.112 ~ 1.010	3.64	5.88	0.012 ~ 0.933	4.01	6.48	0.127 ~ 1.143
5.08 (200")	4.73	7.64	0.150 ~ 1.346	4.86	7.85	0.015 ~ 1.245	5.36	8.65	0.169 ~ 1.524
6.35 (250")	5.92	9.56	0.187 ~ 1.683	6.09	9.83	0.019 ~ 1.556	6.71	10.83	0.212 ~ 1.905
7.62 (300")	7.11	11.48	0.224 ~ 2.019	7.31	11.80	0.023 ~ 1.867	8.05	13.00	0.254 ~ 2.286

For PT-VW540

(Unit: m)

Projection size Screen diagonal (SD)	16:10 aspect ratio			16:9 aspect ratio			4:3 aspect ratio		
	Minimum distance (LW)	Maximum distance (LT)	Distance from the lens center to the image lower end (H)	Minimum distance (LW)	Maximum distance (LT)	Distance from the lens center to the image lower end (H)	Minimum distance (LW)	Maximum distance (LT)	Distance from the lens center to the image lower end (H)
0.76 (30")	0.68	1.12	0.022 ~ 0.201	0.70	1.15	0.002 ~ 0.186	0.77	1.27	0.025 ~ 0.228
1.02 (40")	0.92	1.51	0.030 ~ 0.270	0.94	1.55	0.003 ~ 0.250	1.04	1.71	0.034 ~ 0.306
1.27 (50")	1.15	1.88	0.037 ~ 0.337	1.18	1.94	0.004 ~ 0.311	1.31	2.14	0.042 ~ 0.381
1.52 (60")	1.38	2.26	0.045 ~ 0.403	1.42	2.32	0.005 ~ 0.372	1.57	2.56	0.051 ~ 0.456
1.78 (70")	1.62	2.65	0.052 ~ 0.472	1.67	2.72	0.005 ~ 0.436	1.84	3.00	0.059 ~ 0.534
2.03 (80")	1.86	3.03	0.060 ~ 0.538	1.91	3.11	0.006 ~ 0.497	2.10	3.43	0.068 ~ 0.609
2.29 (90")	2.10	3.42	0.067 ~ 0.607	2.16	3.51	0.007 ~ 0.561	2.38	3.87	0.076 ~ 0.687
2.54 (100")	2.33	3.79	0.075 ~ 0.673	2.39	3.90	0.008 ~ 0.622	2.64	4.30	0.085 ~ 0.762
3.05 (120")	2.80	4.56	0.090 ~ 0.808	2.88	4.69	0.009 ~ 0.747	3.18	5.17	0.102 ~ 0.915
3.81 (150")	3.51	5.70	0.112 ~ 1.010	3.61	5.86	0.012 ~ 0.933	3.98	6.46	0.127 ~ 1.143
5.08 (200")	4.69	7.61	0.150 ~ 1.346	4.82	7.83	0.015 ~ 1.245	5.31	8.62	0.169 ~ 1.524
6.35 (250")	5.87	9.52	0.187 ~ 1.683	6.03	9.79	0.019 ~ 1.556	6.65	10.78	0.212 ~ 1.905
7.62 (300")	7.05	11.43	0.224 ~ 2.019	7.24	11.75	0.023 ~ 1.867	7.98	12.95	0.254 ~ 2.286

For PT-VX610

(Unit: m)

Projection size	4:3 aspect ratio			16:9 aspect ratio			16:10 aspect ratio		
	Screen diagonal (SD)	Minimum distance (LW)	Maximum distance (LT)	Distance from the lens center to the image lower end (H)	Minimum distance (LW)	Maximum distance (LT)	Distance from the lens center to the image lower end (H)	Minimum distance (LW)	Maximum distance (LT)
0.76 (30")	0.69	1.14	0.046 ~ 0.228	0.75	1.24	- 0.012 ~ 0.186	0.73	1.21	0.008 ~ 0.201
1.02 (40")	0.94	1.54	0.061 ~ 0.306	1.02	1.68	- 0.017 ~ 0.250	0.99	1.63	0.011 ~ 0.270
1.27 (50")	1.17	1.92	0.076 ~ 0.381	1.28	2.09	- 0.021 ~ 0.311	1.24	2.04	0.013 ~ 0.337
1.52 (60")	1.41	2.30	0.091 ~ 0.456	1.54	2.51	- 0.025 ~ 0.372	1.49	2.44	0.016 ~ 0.403
1.78 (70")	1.65	2.70	0.107 ~ 0.534	1.81	2.94	- 0.029 ~ 0.436	1.76	2.86	0.019 ~ 0.472
2.03 (80")	1.89	3.08	0.122 ~ 0.609	2.06	3.36	- 0.033 ~ 0.497	2.01	3.27	0.022 ~ 0.538
2.29 (90")	2.14	3.48	0.137 ~ 0.687	2.33	3.80	- 0.037 ~ 0.561	2.27	3.69	0.024 ~ 0.607
2.54 (100")	2.37	3.87	0.152 ~ 0.762	2.59	4.21	- 0.041 ~ 0.622	2.52	4.10	0.027 ~ 0.673
3.05 (120")	2.86	4.65	0.183 ~ 0.915	3.11	5.07	- 0.050 ~ 0.747	3.03	4.93	0.032 ~ 0.808
3.81 (150")	3.58	5.81	0.229 ~ 1.143	3.90	6.33	- 0.062 ~ 0.933	3.79	6.16	0.040 ~ 1.010
5.08 (200")	4.78	7.76	0.305 ~ 1.524	5.21	8.45	- 0.083 ~ 1.245	5.06	8.22	0.054 ~ 1.346
6.35 (250")	5.98	9.70	0.381 ~ 1.905	6.52	10.57	- 0.104 ~ 1.556	6.34	10.29	0.067 ~ 1.683
7.62 (300")	7.18	11.65	0.457 ~ 2.286	7.82	12.70	- 0.124 ~ 1.867	7.61	12.35	0.081 ~ 2.019

Projection distance formulas

To use a projected image size not listed in this manual, check the projected image size SD (m) and use the respective formula to calculate the value.

The unit of all the formulae is m. (Values obtained by the following calculation formulae contain a slight error.)

When calculating the value using image size designation (value in inches), multiply the value in inches by 0.0254 and substitute it into SD in the formula.

For PT-VZ580

Aspect ratio		16:10	16:9	4:3
Screen height (SH)		= 0.530 × SD	= 0.490 × SD	= 0.6 × SD
Screen width (SW)		= 0.848 × SD	= 0.872 × SD	= 0.8 × SD
Projection distance (L)	Minimum (LW)	= 0.9371 × SD - 0.0294	= 0.9632 × SD - 0.0294	= 1.0609 × SD - 0.0294
	Maximum (LT)	= 1.5103 × SD - 0.0319	= 1.5523 × SD - 0.0319	= 1.7098 × SD - 0.0319

For PT-VW540

Aspect ratio		16:10	16:9	4:3
Screen height (SH)		= 0.530 × SD	= 0.490 × SD	= 0.6 × SD
Screen width (SW)		= 0.848 × SD	= 0.872 × SD	= 0.8 × SD
Projection distance (L)	Minimum (LW)	= 0.9286 × SD - 0.0295	= 0.9544 × SD - 0.0295	= 1.0512 × SD - 0.0295
	Maximum (LT)	= 1.5041 × SD - 0.0272	= 1.5459 × SD - 0.0272	= 1.7027 × SD - 0.0272

For PT-VX610

Aspect ratio		4:3	16:9	16:10
Screen height (SH)		= 0.6 × SD	= 0.490 × SD	= 0.530 × SD
Screen width (SW)		= 0.8 × SD	= 0.872 × SD	= 0.848 × SD
Projection distance (L)	Minimum (LW)	= 0.9461 × SD - 0.0295	= 1.0307 × SD - 0.0295	= 1.0028 × SD - 0.0295
	Maximum (LT)	= 1.5324 × SD - 0.0272	= 1.6696 × SD - 0.0272	= 1.6244 × SD - 0.0272

Connecting

Before connecting

- Before connecting, carefully read the operating instructions for the external device to be connected.
- Turn off the power switch of the devices before connecting cables.
- Take note of the following points before connecting the cables. Failure to do so may result in malfunctions.
 - When connecting a cable to the projector or an external device connected to the projector, touch any nearby metallic objects to eliminate static electricity from your body before performing work.
 - Do not use unnecessarily long cables to connect to the projector or a device connected to the projector. The longer the cable, the more it is susceptible to noise. Since using a cable while it is wound makes it act like an antenna, it is more susceptible to noise.
 - When connecting cables, connect GND first, then insert the connecting terminal of the connecting device straightly.
- If any connection cable is not supplied with the device, or if no optional cable is available for connection of the device, prepare a necessary system connection cable to suit the device.
- Video signals from the video devices containing too much jitter may cause the images on the screen to randomly wobble or wafture. In this case, a time base corrector (TBC) must be connected.
- The projector supports VIDEO signals, YC_BC_R/YP_BP_R signals, analog RGB signals (synchronous signals are TTL level), and digital signal.
- Some computer models or graphics cards are not compatible with the projector.
- When using long cables to connect each equipment to the projector, there is a possibility that the image will not be output correctly unless a cable compensator is used.
- For details on what video signals the projector supports, refer to “List of compatible signals”. (➡ page 126)

<COMPUTER 1 IN> terminal / <COMPUTER 2 IN/1 OUT> terminal pin assignments and signal names

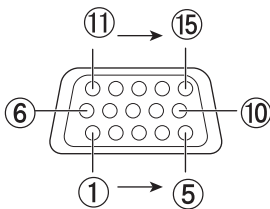
Outside view	Pin No.	Signal names	Pin No.	Signal names
	①	R/P _R	⑨	+5V
	②	G/Y	⑩	GND
	③	B/P _B	⑪	GND
	④	—	⑫	DDC data
	⑤	GND	⑬	HD/SYNC
	⑥	GND	⑭	VD
	⑦	GND	⑮	DDC clock
	⑧	GND		

<HDMI 1 IN> terminal / <HDMI 2 IN> terminal pin assignments and signal names

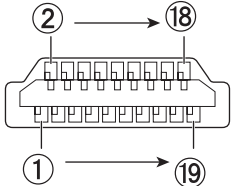
Outside view	Pin No.	Signal names	Pin No.	Signal names
 <p>Even-numbered pins ② to ⑱</p> <p>Odd-numbered pins ① to ⑱</p>	①	T.M.D.S data 2+	⑪	T.M.D.S clock shield
	②	T.M.D.S data 2 shield	⑫	T.M.D.S clock -
	③	T.M.D.S data 2-	⑬	CEC
	④	T.M.D.S data 1+	⑭	—
	⑤	T.M.D.S data 1 shield	⑮	SCL
	⑥	T.M.D.S data 1-	⑯	SDA
	⑦	T.M.D.S data 0+	⑰	DDC/CEC GND
	⑧	T.M.D.S data 0 shield	⑱	+5V
	⑨	T.M.D.S data 0-		Hot plug detection
	⑩	T.M.D.S clock +		

Connecting example: AV equipment

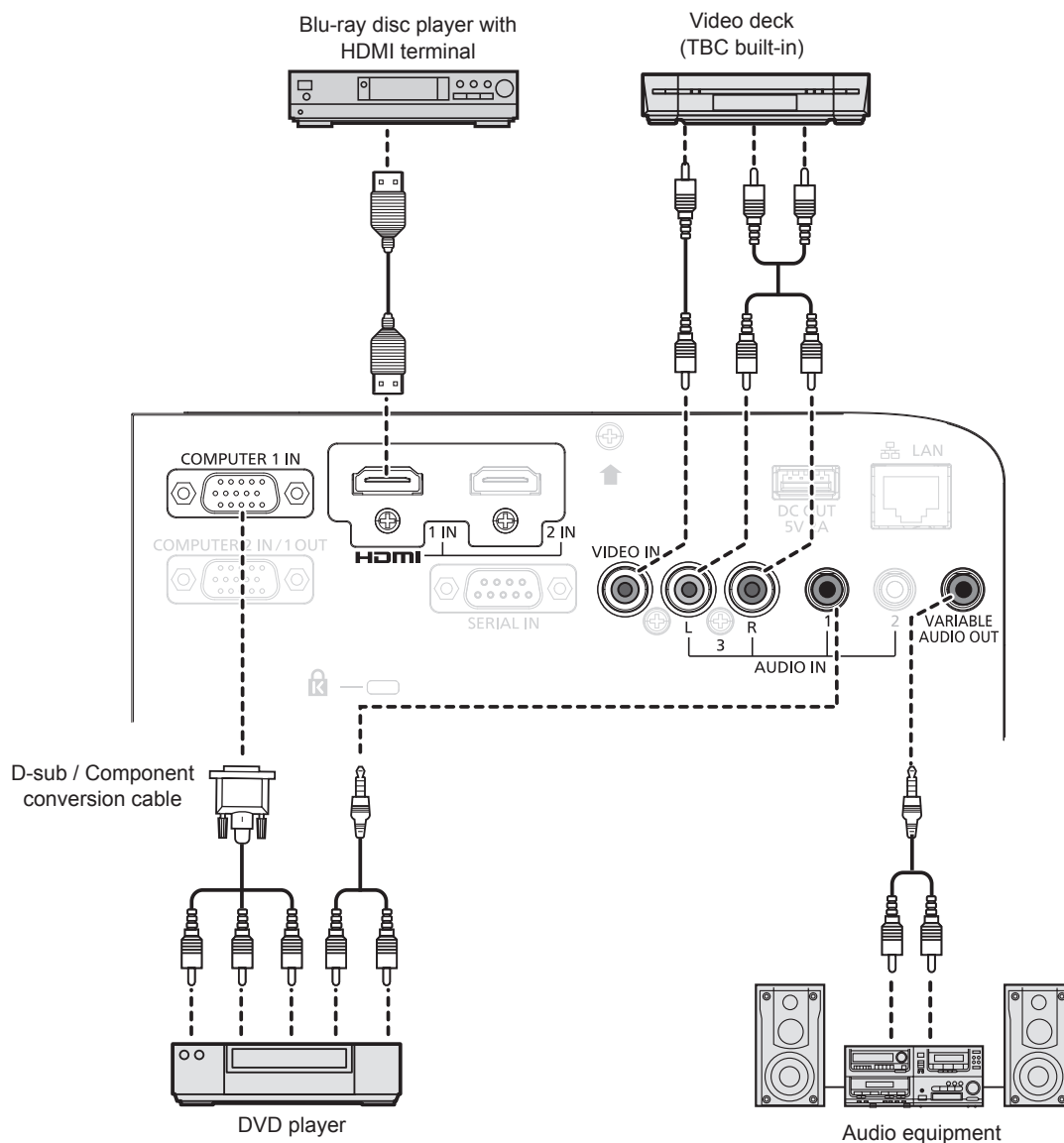

Attention

- Always use one of the following when connecting a VCR.
 - A VCR with built-in time base corrector (TBC).
 - A time base corrector (TBC) between the projector and the VCR.
- If nonstandard burst signals are connected, the image may be distorted. In such case, connect the time base corrector (TBC) between the projector and the external devices.

Note

- For an HDMI cable, use an HDMI High Speed cable that conforms to HDMI standards. If a cable that does not conform to HDMI standards is used, images may be interrupted or may not be displayed.
- The <HDMI 1 IN> terminal /<HDMI 2 IN> terminal can be connected to an external device with the DVI-D terminal by using an HDMI/DVI conversion cable. However, this may not function properly for some external devices, and image may not be projected.
- This projector does not support the VIERA Link (HDMI).
- To output the signal input to the <COMPUTER 1 IN> terminal from the <COMPUTER 2 IN/1 OUT> terminal, set the [PROJECTOR SETUP] menu → [COMPUTER2 SELECT] to [COMPUTER 1 OUT].
- To output audio, properly set the [PROJECTOR SETUP] menu → [AUDIO SETTING] → [AUDIO IN SELECT].
- When the <VARIABLE AUDIO OUT> terminal is connected with cable, the sound will not be output from the built-in speaker.

Connecting example: Computers

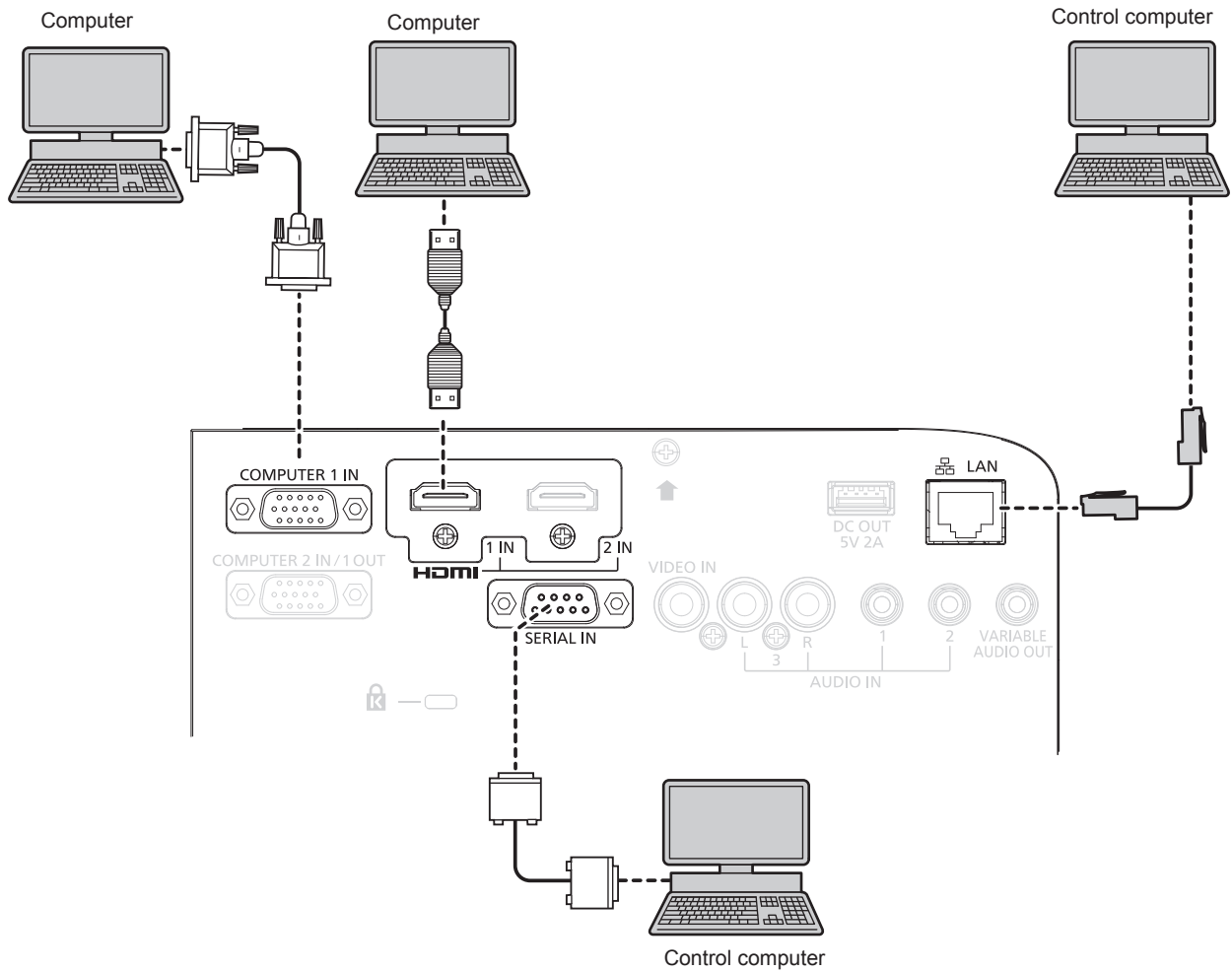

Attention

- When connecting the projector to a computer or an external device, use the power cord supplied with each device and commercially available shielded cables.

Note

- For the HDMI cable, use an HDMI High Speed cable that conforms to the HDMI standards. If a cable that does not conform to the HDMI standards is used, images may be interrupted or may not be projected.
- If you operate the projector using the computer with the resume feature (last memory), you may have to reset the resume feature to operate the projector.
- To output the signal input to the <COMPUTER 1 IN> terminal from the <COMPUTER 2 IN/1 OUT> terminal, set the [PROJECTOR SETUP] menu → [COMPUTER2 SELECT] to [COMPUTER1 OUT].

Chapter 3 Basic Operations

This chapter describes basic operations to start with.

Switching on/off the projector

Connecting the power cord

Make sure that the supplied power cord is securely fixed to the projector body to prevent it from being removed easily.

Use the power cord matching with the power supply voltage and the shape of the outlet.

For details of power cord handling, refer to "Read this first!". (➡ page 4)

Attaching the power cord

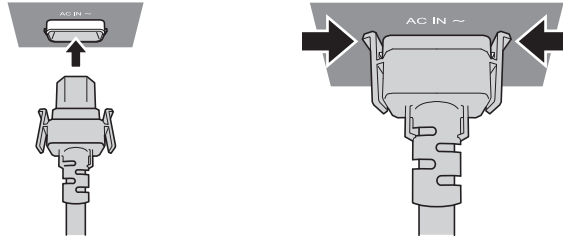

- 1) Check the shapes of the <AC IN> terminal on the back of the projector body and the power cord connector and insert the plug completely in the correct direction (until you hear the side tabs click in place).

Removing the power cord

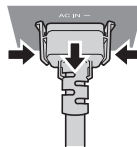

- 1) Confirm that the projector is in standby mode, and remove the power plug from the outlet.
- 2) Remove the power cord connector from the <AC IN> terminal of the projector body while pressing the side tabs.

Power indicator

Displays the status of the power. Check the <ON(G)/STANDBY(R)> status of the power indicator before operating the projector.

Power indicator <ON(G)/STANDBY(R)>

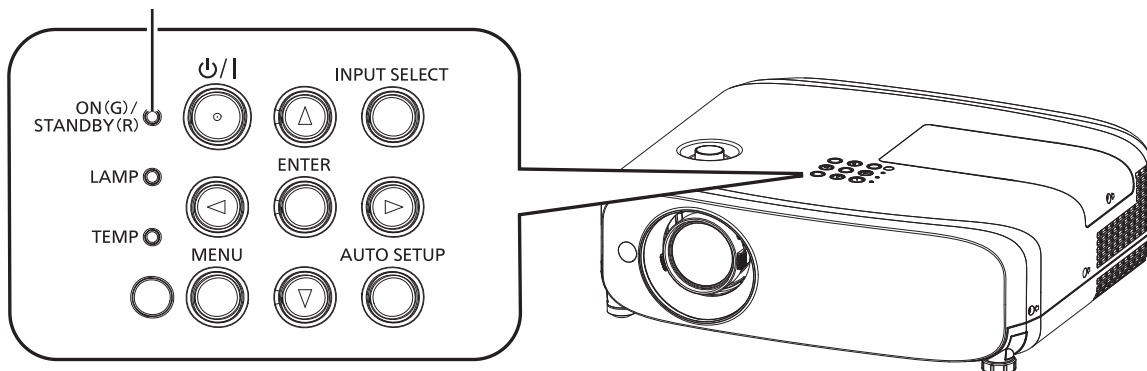

Indicator status		Projector status
Off		The power plug is not connected to the outlet.
Red	Lit	The power is switched off (in standby mode). Projection will start when the power <⏻/ > button is pressed. <ul style="list-style-type: none"> The setting of the projector is as follows. <ul style="list-style-type: none"> The [PROJECTOR SETUP] menu → [ECO MANAGEMENT] → [STANDBY MODE] is set to [ECO]. The projector may not operate when the lamp indicator <LAMP> or the temperature indicator <TEMP> is blinking. (➔ page 110)
	Blinking ^{*1}	The power is switched off (in standby mode). Projection will start when the power <⏻/ > button is pressed. <ul style="list-style-type: none"> The setting of the projector is as follows. <ul style="list-style-type: none"> The [PROJECTOR SETUP] menu → [ECO MANAGEMENT] → [STANDBY MODE] is set to [NORMAL]. The projector may not operate when the lamp indicator <LAMP> or the temperature indicator <TEMP> is blinking. (➔ page 110)
Green	Lit	Projecting.
	Blinking ^{*2}	The luminous lamp is turned off. The luminous lamp lights when a signal is input or a button operation is performed. <ul style="list-style-type: none"> The setting of the projector is as follows. <ul style="list-style-type: none"> The [PROJECTOR SETUP] menu → [ECO MANAGEMENT] → [POWER MANAGEMENT] is set to [READY].
	Blinking ^{*3}	The projector is preparing to project. The projector will project image after a while.
Orange	Lit	The projector is preparing to be switched off. The power will be switched off after a while. (Changes to the standby mode.)

*1 The indicator flashes in the cycle: 2.75 seconds (light) → 0.25 seconds (off)

*2 The indicator flashes in the cycle: 2.0 seconds (light) → 2.0 seconds (off)

*3 The indicator flashes in the cycle: 0.5 seconds (light) → 0.5 seconds (off)

Note

- While the power indicator <ON (G)/STANDBY (R)> lights in orange, the fan is running to cool the projector.
- For about 90 seconds after the projector is switched off, the luminous lamp does not light up even if the power is switched on. Turn on the power again after the power indicator <ON (G)/STANDBY (R)> lights/blinks in red.
- The projector consumes power even in standby mode (power indicator <ON (G)/STANDBY (R)> lights/blinks in red). Refer to “Power consumption” (➔ page 128) for the power consumption.

Switching on the projector

Before switching on the projector, make sure all the other devices are correctly connected (➔ page 34) and the lens cap is removed beforehand.

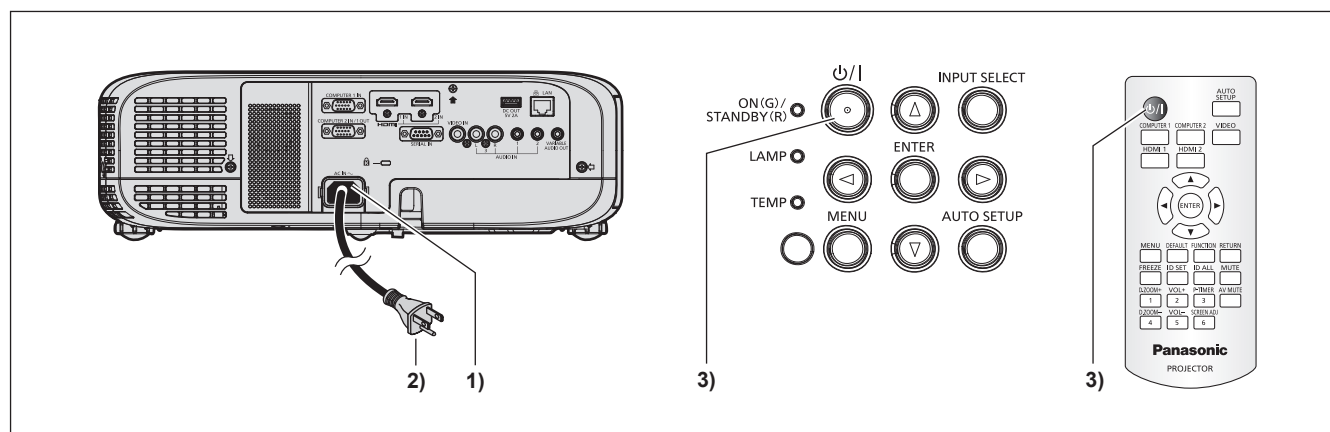

- 1) Connect the power cord to the projector.**
- 2) Connect the power plug to an outlet.**
 - The power indicator <ON(G)/STANDBY(R)> lights/blinks, and the projector will enter the standby mode.
- 3) Press the power <⏻/|> button.**
 - The power indicator <ON(G)/STANDBY(R)> lights in green and the image is soon projected on the screen.

Attention

- Be sure to remove the lens cap before starting projection.

Note

- If the [PROJECTOR SETUP] menu → [ECO MANAGEMENT] → [STANDBY MODE] is set to [ECO] (▶ page 81), it may take approximately ten seconds longer before the projector starts projecting after the power is turned on, compared with when [NORMAL] is set.
- If the [PROJECTOR SETUP] menu → [ECO MANAGEMENT] → [STANDBY MODE] is set to [NORMAL], it may take approximately one minute to enable the network function after connecting the power cord to the outlet.

When the initial setting screen is displayed

When the projector is switched on for the first time after purchase or the [PROJECTOR SETUP] menu → [INITIALIZE ALL] is executed, the [INITIAL SETTING] screen is displayed after the projection starts. Set them in accordance with circumstances. In other occasions, you can change the settings by menu operations. When the [INITIAL SETTING] screen is displayed, you can return to the previous screen by pressing the <MENU> button.

Note

- When the projector is used for the first time, in order to clearly display the menu screen, it may be necessary to adjust the focus lever and the zoom lever in the projection lens area of the projector (▶ page 23). For details, refer to “How to adjust the state of the image” (▶ page 45).

Initial setting (display language)

Select the language to show on the screen.

After the initial setting, you can change the display language from the [LANGUAGE] menu.

- 1) Press ▲▼◀▶ to select the display language.



- 2) Press the <ENTER> button to proceed to the following initial setting.

Initial setting (projector setup)

If necessary, change the setting of each item.

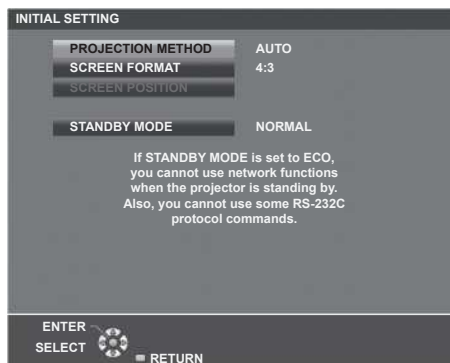

- 1) Press ▲▼ to select an item.

Item	Description
[PROJECTION METHOD]	Set [PROJECTION METHOD] depending on the installation mode.
[SCREEN FORMAT]	Set the aspect ratio of the image.
[SCREEN POSITION]	Set the display position of the image.
[STANDBY MODE]	Set the operation mode during standby.

- 2) **Press ◀▶ to switch the setting.**
 - When all settings are completed, proceed to Step 3).
- 3) **Press the <ENTER> button.**
 - Confirm the setting value and complete the initial setting.

Setting [PROJECTION METHOD]

If the screen display is upside down or is reversed, please change the settings, refer to “Installation mode” (➔ page 29). After initialization, You can change the settings from the [PROJECTOR SETUP] menu → [PROJECTION METHOD].

- 1) **Press ▲▼ to select the [PROJECTION METHOD].**
- 2) **Press ◀▶ to switch the settings.**
 - When set to [AUTO], the built-in angle sensor detects the orientation of the projector and automatically switches to [FRONT/DESK] or [FRONT/CEILING]. Normally, set to [AUTO].
 - To project from the rear of the screen, select [REAR/DESK] or [REAR/CEILING] (using a translucent screen).

Setting [SCREEN FORMAT] and [SCREEN POSITION]

Set the image aspect ratio and display position according to the screen being used. When the initial setting is complete, you can change the setting from the [DISPLAY OPTION] menu → [SCREEN SETTING] → [SCREEN FORMAT]/[SCREEN POSITION].

- 1) **Press ▲▼ to select the [SCREEN FORMAT].**
- 2) **Press ◀▶ to select the aspect ratio.**
- 3) **Press ▲▼ to select the [SCREEN POSITION].**
 - In the following cases, the [SCREEN POSITION] cannot be changed.
 - For PT-VZ580 and PT-VW540, [SCREEN FORMAT] is set to [16:10].
 - For PT-VX610, [SCREEN FORMAT] is set to [4:3].
- 4) **Press ◀▶ to select the image position.**
 - Select from [CENTER]/[LEFT]/[RIGHT] or [CENTER]/[UPPER]/[LOWER].

Setting [STANDBY MODE]

Set the operating mode at standby. When the initial setting is complete, you can change the setting from the [PROJECTOR SETUP] menu → [ECO MANAGEMENT] → [STANDBY MODE].

- 1) **Press ▲▼ to select [STANDBY MODE].**
- 2) **Press ◀▶ to select the operation mode.**
 - The factory default setting is [NORMAL], which enables the network function even in standby mode.
 - To lower the power consumption level during standby, set to [ECO].

Making adjustments and selections

It is recommended that images are projected continuously for at least 30 minutes before the focus is adjusted.

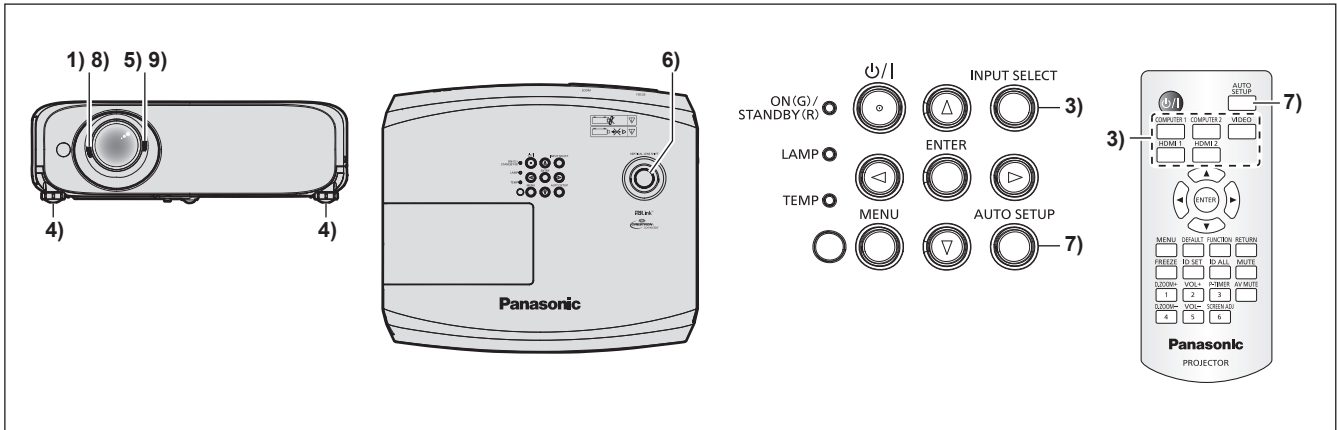

- 1) Roughly adjust the focus of the image with the focus lever. (➡ page 45)
- 2) Change the settings of the [PROJECTOR SETUP] menu → [PROJECTION METHOD] depending on the installation mode. (➡ page 29)
 - Refer to “Navigating through the menu” (➡ page 53) for the operation of the menu screen.
- 3) Press the input selection buttons on the remote control or the <INPUT SELECT> button on the control panel to select the input signal. (➡ page 44)
 - The buttons that can be used on the remote control are as follows.
 <COMPUTER 1> button, <COMPUTER 2> button, <VIDEO> button, <HDMI 1> button, and <HDMI 2> button
- 4) Adjust the front, back and sideway tilt of the projector with the adjustable feet. (➡ page 46)
- 5) Adjust the size of the image to match the screen with the zoom lever.
- 6) Adjust the vertical projection position with the vertical lens shift dial.
- 7) If the input signal is an analog RGB signal, press the <AUTO SETUP> button.
- 8) Adjust the focus again with the focus lever.
- 9) Adjust the size of the image to match the screen with the zoom lever again.

Note

- When the projector is switched on for the first time after purchase or the [PROJECTOR SETUP] menu → [INITIALIZE ALL] is executed, the [INITIAL SETTING] screen is displayed after projection starts. Refer to “When the initial setting screen is displayed” (➡ page 40).

Switching off the projector

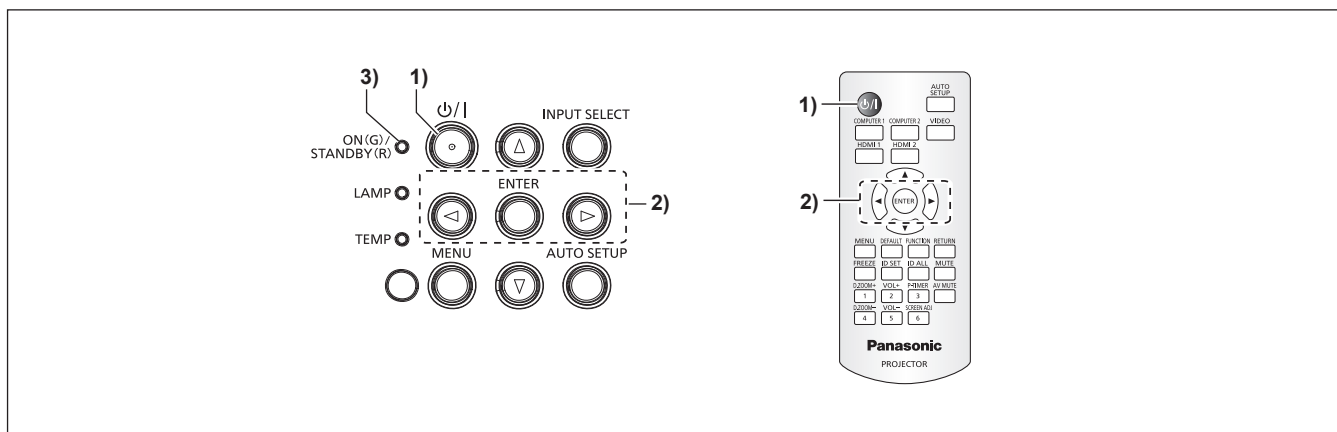

- 1) Press the power <⏻/|> button.
 - The [POWER OFF] confirmation screen is displayed.

- 2) Press ◀▶ to select [OK], and press the <ENTER> button.
(Or press the power <⏻/|> button again.)
 - Projection of the image will stop, and the power indicator <ON(G)/STANDBY(R)> on the projector lights in orange. (The fans keep running.)
- 3) Wait until the power indicator <ON(G)/STANDBY(R)> on the projector lights or blinks in red.
 - The projector enters standby mode when the power indicator <ON(G)/STANDBY(R)> lights or blinks in red.
- 4) Disconnect the plug of the power cord from the outlet.

Note

- While the power indicator <ON(G)/STANDBY(R)> is lighting in orange, the luminous lamp is being cooled down and the projector cannot be turned on. Wait until the power indicator <ON(G)/STANDBY(R)> starts lighting or blinking in red to turn on the projector again.
- **Even if the power is turned off by pressing the power <⏻/|> button, the projector consumes power if the power plug is connected to the outlet.**
When the [PROJECTOR SETUP] menu → [ECO MANAGEMENT] → [STANDBY MODE] is set to [ECO], use of some functions is restricted, but the power consumption during standby can be conserved.

Direct power off function

When the plug is disconnected from the outlet or the power is turned off by the circuit breaker in the ceiling mount case while the projection is going on, the projector can respond with direct power off function. Therefore, it is also safe in case a power outage occurs or the power cord is pulled out immediately after the projector is switched off.

Attention

- Do not disconnect the power cord from the wall outlet or turn off the circuit breaker switch in about 1 minute after the lamp is lit. Doing so may cause the lamp fail to light while you powering on the projector next time, or result in premature deterioration of the luminous lamp.

Note

- If the [PROJECTOR SETUP] menu → [INITIAL STARTUP] is set to [LAST MEMORY] and the projector was turned off by using the circuit breaker directly while projecting during the last time of use, the power indicator <ON(G)/STANDBY(R)> will light in green a while after the circuit breaker is turned on, and then projection of the image will start.
- If the projector is shut down with the direct power off function, it may take longer than usual to be ready for projection when the projector is switched on the next time.

Projecting

Check the connections of the external devices (➔ page 34) and connection of the power cord (➔ page 38) and then power on the projector (➔ page 39) to start projecting. Select the image and adjust the state of the image.

Selecting the image input for projection

Switch the image input for projection. Method to switch the input is as follows.

- Press the input selection buttons on the remote control and directly specify the input to project.
- Press the <INPUT SELECT> button on the control panel to display the input guide and select the input to be projected.

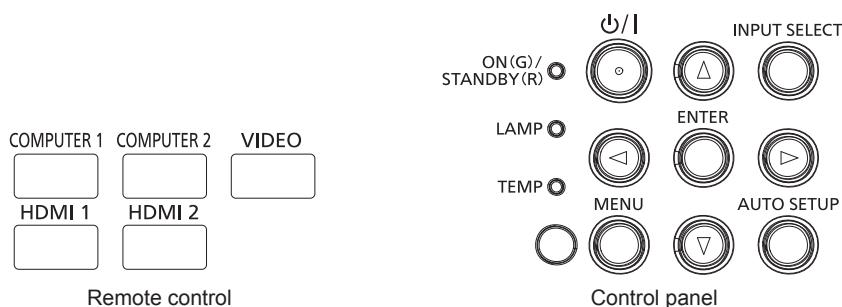

Switching the input directly with the remote control

The input for projection can be switched by directly specifying it with the input selection button on the remote control.

- 1) Press the input selection buttons (<COMPUTER 1>, <COMPUTER 2>, <VIDEO>, <HDMI 1>, <HDMI 2>).

Remote control buttons	Input	Usage
<COMPUTER 1>	COMPUTER 1	Switches the input to COMPUTER 1. Displays the image signals input via the <COMPUTER 1 IN> terminal.
<COMPUTER 2>	COMPUTER 2	Switches the input to COMPUTER 2. Displays the image signals input via the <COMPUTER 2 IN/1 OUT> terminal.
<VIDEO>	VIDEO	Switches the input to VIDEO. Displays the image signals input via the <VIDEO IN> terminal.
<HDMI 1>	HDMI 1	Switches the input to HDMI 1. Displays the image signals input via the <HDMI 1 IN> terminal.
<HDMI 2>	HDMI 2	Switches the input to HDMI 2. Displays the image signals input via the <HDMI 2 IN> terminal.

- When switching inputs, the input guide for detailed or simple display is temporarily displayed. For the input guide, refer to “Switching the input with the control panel” (➔ page 45) or the [DISPLAY OPTION] menu → [ON-SCREEN DISPLAY] → [INPUT GUIDE].

Attention

- Images may not be projected properly depending on the external device, or the Blu-ray disc or DVD disc, to be played back. Set the following menu items according to the input signal.
 - [PICTURE] menu → [TV-SYSTEM]
 - [PICTURE] menu → [RGB/YC_BC_R]
 - [PICTURE] menu → [RGB/YP_BP_R]
 - [PICTURE] menu → [RGB-SYSTEM]
- Confirm the aspect ratio of the projection screen and the image, and switch to an optimum aspect ratio from the [POSITION] menu → [ASPECT].

Note

- Set the [PROJECTOR SETUP] menu → [COMPUTER2 SELECT] to [COMPUTER2 IN] when a signal is to be input to the <COMPUTER 2 IN/1 OUT> terminal. When [COMPUTER2 SELECT] is set to [COMPUTER1 OUT], it cannot switch to COMPUTER 2 input.
- If one of COMPUTER 1 / COMPUTER 2 / HDMI 1 / HDMI 2 input is selected and no signal is input, the following screen is displayed. Check the output setting of your computer.

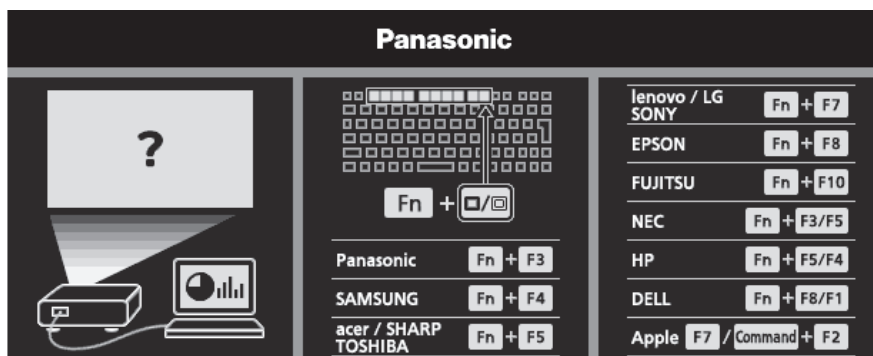

Switching the input with the control panel

The input can be switched with the <INPUT SELECT> button on the control panel
 After pressing the <INPUT SELECT> button, the detailed or simple input guide is displayed.

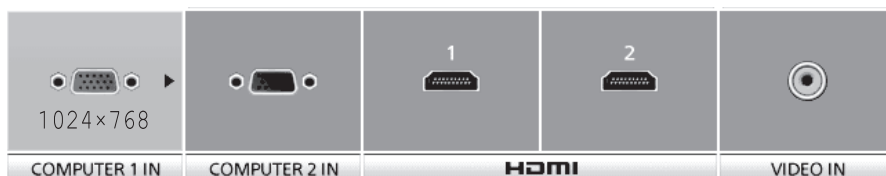

Detailed input guide example



Simple input guide example

1) Press the <INPUT SELECT> button on the control panel.

- The input guide is displayed.

2) Press the <INPUT SELECT> button again.

- Every time you press the <INPUT SELECT> button, the inputs are switched in the following order. COMPUTER1 → COMPUTER2 → HDMI1 → HDMI2 → VIDEO → COMPUTER1 → ...
- When the detailed input guide is displayed, you can select the input with the ◀▶ buttons on the control panel or on the remote control.

Note

- You can switch the detailed/simple input guide by setting the [DISPLAY OPTION] menu → [ON-SCREEN DISPLAY] → [INPUT GUIDE].
- When the [DISPLAY OPTION] menu → [ON-SCREEN DISPLAY] → [INPUT GUIDE] is set to [OFF], the input guide is not displayed.

How to adjust the state of the image

If the projected image or the position is not correct when the positioning of the projector and the screen is correctly installed, adjust the projection angle, zoom, focus and vertical shift.

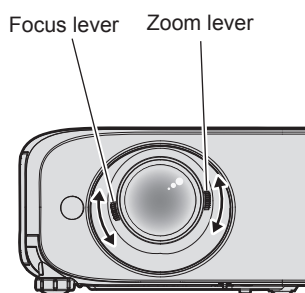

Fig. 1

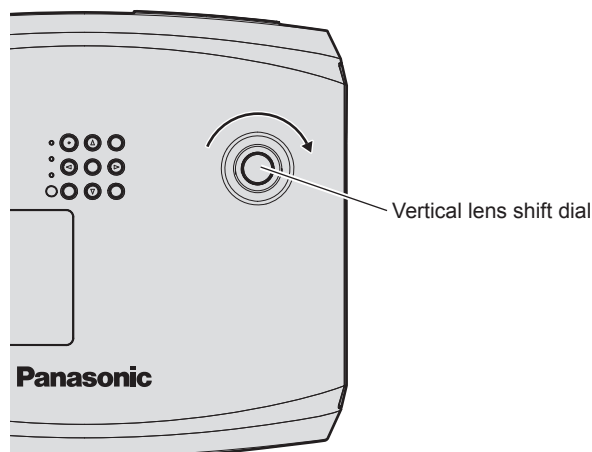

Fig. 2

1) Adjust the projection angle.

- Place the projector on a level surface and make its front side parallel to the screen surface so that the projection screen is rectangular.
- If the projector is facing downward with respect to the screen, extend the adjustable feet and adjust the projected image so that the projected image is rectangular. For details, refer to “Adjusting adjustable feet”. (➔ page 46)

2) Adjust the zoom and the focus. (Fig. 1)

- Operate the zoom lever to adjust the projected image size to fit the screen.
- Operate the focus lever to adjust the focus.

3) Adjust the vertical shift. (Fig. 2)

- Turn the vertical lens shift dial and adjust the vertical projection position on the screen. For details, refer to “Adjusting the projection position with the optical axis shift function”. (➔ page 47)

Note

- It is recommended that the images are projected continuously for at least 30 minutes before the focus is adjusted.
- When the focus is adjusted, the projection screen size also changes slightly. Depending on the image projection situation, repeat Steps 1) to 3) to adjust to the best projection condition.
- Adjust from the [POSITION] menu → [SCREEN ADJUSTMENT] when the projected image is distorted.

Adjusting adjustable feet

By pressing the adjustable feet lock with your finger, the adjustable feet lock is released and becomes free. It will be locked when you release the finger. Lift the front side of the projector while pressing the adjustable feet lock with your finger, and release your finger until the projection position is aligned. If fine adjustment of the projection position is necessary, adjust the adjustable feet by turning them. Turn the adjustable feet counterclockwise as shown in the figure to extend them. Also, turning them clockwise will return to the original status.

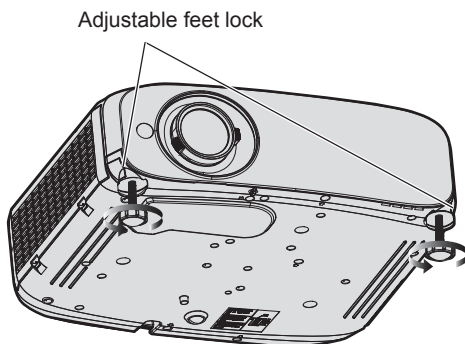

Maximum adjustable range
Adjustable feet : 34 mm (1-11/32") each

Attention

- Heated air is expelled from the air exhaust port. Do not touch the air exhaust port directly when adjusting the adjustable feet while using the projector. (➔ page 23)

Note

- When turning the adjustable feet clockwise until a click sound is heard, the adjustable feet change to its minimum length.

Adjusting the projection position with the optical axis shift function

This projector is equipped with vertical optical axis shift function. The projection position can be adjusted in the range shown in the following figure with the optical axis shift function based on the position of the projected screen in the home position (standard projection position).

When the projector is installed on the desk, the projected image will move upward if you turn the vertical lens shift dial clockwise and will move downward if you turn it counterclockwise.

The following figure shows the adjustment range when the projector is installed on the desk.

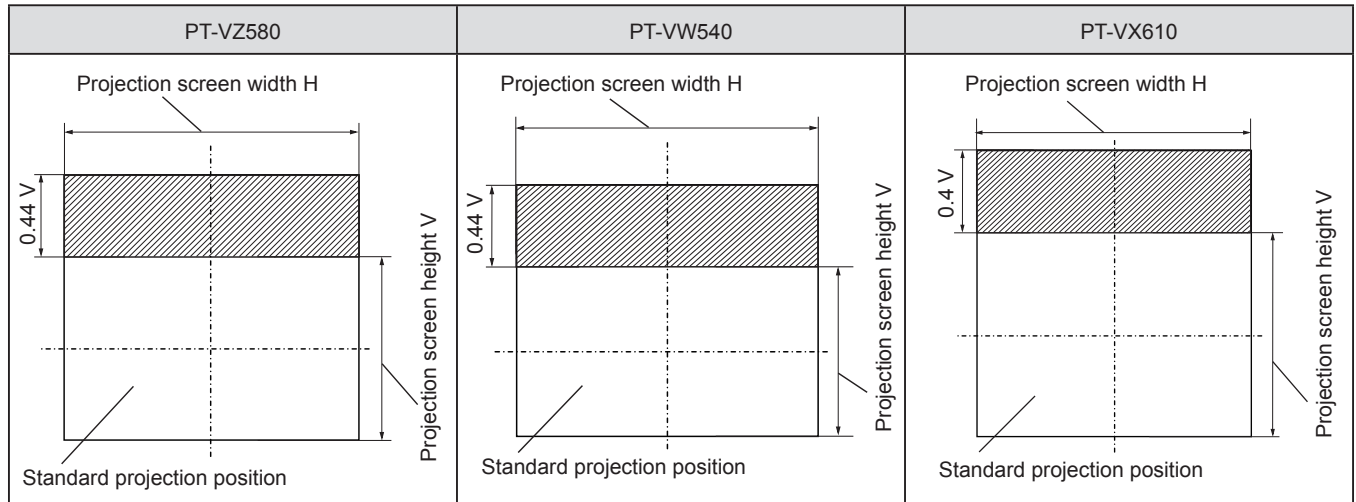

Note

- The standard projection position indicates the projection screen position in the state without vertical shift adjustment. At this time, the vertical lens shift dial is fully turned counterclockwise.

Operating with the remote control

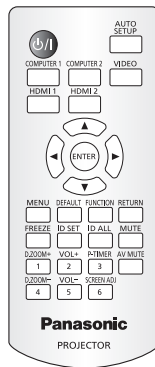

Using the AV mute function

If the projector is not used for a certain period of time during meeting breaks or preparations, for example, it is possible to turn off the audio and image temporarily.

AV MUTE



- 1) Press the <AV MUTE> button.
 - The image and audio turn off.
- 2) Press the <AV MUTE> button again.
 - The image and audio turn on.

Using the mute function

This button allows you to turn off the audio output temporarily.

MUTE



- 1) Press the <MUTE> button.
 - The audio turns off.
- 2) Press the <MUTE> button again.
 - The audio turns on.

Adjusting the volume

You can control the volume of the built-in speaker and audio output.

VOL+



VOL-



buttons

- 1) Press the <VOL -> button / <VOL +> button.

<VOL +>	Increases the volume.
<VOL ->	Decreases the volume.

Note

- You can also operate with ◀▶ on the control panel.

Using the freeze function

You can freeze the projected image and mute the sound temporarily, regardless of the playback status of the external device.

FREEZE



button

- 1) **Press the <FREEZE> button.**
 - The image is paused and the audio is muted.
- 2) **Press the <FREEZE> button again.**
 - The image resumes and the audio is output.

Note

- [FREEZE] is displayed at the lower left of the projection screen in freeze status.

Using the auto setup function

The automatic setup function can be used to automatically adjust the dot clock, clock phase, and image position when the analog RGB signals consisting of bitmap images such as computer signal are input. It is recommended to input an image with bright white borders at the edges and high-contrast black and white characters when the automatic adjustment is being performed. Images including half tones like photos and computer graphics are not suitable.

AUTO
SETUP



button

- 1) **Press the <AUTO SETUP> button.**

Note

- You can also use this function with the <AUTO SETUP> button on the control panel.
- The clock phase may shift even if the automatic adjustment is performed. In such a case, adjust the [POSITION] menu → [CLOCK PHASE]. (➔ page 66)
- When the input signal is a blurred-edge image or a dark image, it may not be able to be adjusted correctly even if the automatic adjustment is performed. In this case, adjust the following settings.
 - [POSITION] menu → [DOT CLOCK] (➔ page 66)
 - [POSITION] menu → [CLOCK PHASE] (➔ page 66)
 - [POSITION] menu → [SHIFT] (➔ page 65)
- Automatic adjustment may not be performed depending on the computer model and input signal.
- Images may be disrupted for a few seconds during automatic adjustment, but it is not a malfunction.
- Automatic adjustment can be canceled by pressing any button on the remote control during the automatic adjustment operation.
- If the automatic setup function is used while moving images are being input, the adjustment may not be performed properly even for a signal that can use automatic setup.

Using the screen adjustment function

The [SCREEN ADJUSTMENT] menu can be displayed.

You can correct the distortion of the projected image that occurs when the projector is installed tilted or when the screen is tilted or curved.

SCREEN ADJ



button

- 1) **Press the <SCREEN ADJ> button.**
 - The [SCREEN ADJUSTMENT] screen is displayed.
- 2) **Press ▲▼ to switch the item.**

[KEYSTONE]	Adjusts any trapezoidal distortion in the projected image.
[CONNER CORRECTION]	Adjusts any distortion in the four corners of the projected image.
[CURVED CORRECTION]	Adjusts any curved distortion in the projected image.

3) Press the <ENTER> button.

- The [KEYSTONE] screen, the [CORNER CORRECTION] screen or the [CURVED CORRECTION] screen is displayed.

Note

- To adjust [KEYSTONE], [CORNER CORRECTION] or [CURVED CORRECTION], press ▲▼ to select the item to adjust. Press the <ENTER> button to show the individual adjustment screen and adjust with ▲▼◀▶.
- When an individual adjustment screen is displayed, pressing the <ENTER> button can switch to another adjustment screen.
- Only one of the [KEYSTONE], [CORNER CORRECTION] or [CURVED CORRECTION] can be enabled. If the items of [KEYSTONE], [CORNER CORRECTION] or [CURVED CORRECTION] have been adjusted, the adjusted values of the items will be reset when the other items are adjusted.

Using the digital zoom function

(Only for still image-based signals input)
You can enlarge the projected images.

D.ZOOM+



D.ZOOM-



buttons

1) Press the <D.ZOOM -> button / <D.ZOOM +> button.

- The image with the center part enlarged 1.5 times is displayed.

2) Press the <RETURN> button.

- The digital zoom function is canceled.
- You can also cancel with the <MENU> button.

Note

- When using the digital zoom function, the magnification can be set from 1.0x to 3.0x with 0.1 increments when the <D.ZOOM -> button / <D.ZOOM +> button is pressed.
- When the image enlarged to 1.1 to 3.0 times is displayed, the enlarged area can be moved by pressing ▲▼◀▶.
- When the freeze function is being used, the digital zoom function is disabled.
- The digital zoom function may not work properly depending on the input signals.

Using the FUNCTION button

Some frequently used menu items can be assigned to the <FUNCTION> button on the remote control so that it can be used as a shortcut button.

FUNCTION



button

1) Press the <FUNCTION> button.

Assigning functions to the <FUNCTION> button

1) Press the <MENU> button to display the menu items (main menu, sub menu, or details menu) to be assigned.

- Refer to “Navigating through the menu” (➡ page 53) for the operation of the menu.

2) Press and hold the <FUNCTION> button for three seconds or more.

Note

- After the setting, the assigned menu items will be displayed as [ASSIGNED FUNCTION] in the operation guide under the menu.
- To cancel the function assignment, use the [PROJECTOR SETUP] menu → [FUNCTION BUTTON] (➡ page 82).

Using the presentation timer function

You can operate the presentation timer.

Presentations, etc. can be performed while checking the elapsed time or time remaining in the preset time.

P-TIMER



- 1) **Press the <P-TIMER> button.**
 - The count is started.
- 2) **Press the <P-TIMER> button again.**
 - The count is stopped.

Note

- The elapsed time or the remaining time is displayed at the lower right of the projected image when using the presentation timer function.
- The count will be resumed from interruption when the <P-TIMER> button is pressed.
- The presentation timer function will be terminated by pressing the <P-TIMER> button for over three seconds.
- For details about the setting of the presentation timer function, refer to the [DISPLAY OPTION] menu → [P-TIMER] (➔ page 75).

Setting the ID number on the remote control

When you use the system with multiple projectors, you can operate all the projectors simultaneously or each projector individually by using single remote control, if unique ID number is assigned to each projector. After setting the ID number of the projector, set the same ID number to the remote control.

The factory default ID number of the projector is set to [ALL]. When using a single projector, press the <ID ALL> button on the remote control. Also, you can control a projector by pressing the <ID ALL> button on the remote control even if you do not know the projector ID.

ID SET ID ALL



- 1) **Press the <ID SET> button on the remote control.**
- 2) **Within five seconds, press the one-digit ID number set on the projector using the number (<1> - <6>) buttons.**
 - If you press the <ID ALL> button, you can control the projectors regardless of the ID number setting of the projector.

Attention

- Since the ID number of the remote control can be set without the projector, do not press the <ID SET> button on the remote control carelessly. If the <ID SET> button is pressed and no number (<1> - <6>) buttons are pressed within five seconds, the ID number returns to its original value before the <ID SET> button was pressed.
- The ID number set on the remote control will be stored unless it is set again. However, it will be erased if the remote control is left with dead batteries. Set the same ID number again when the batteries are replaced.

Note

- Set the ID number of the projector from the [PROJECTOR SETUP] menu → [PROJECTOR ID].

Chapter 4 Settings

This chapter describes the settings and adjustments you can make using the on-screen menu.

On-screen menu

The on-screen menu (menu screen) is used to perform various settings and adjustments of the projector.

Navigating through the menu

Operating procedure

MENU
 button

- 1) Press the <MENU> button on the remote control or the control panel.
 - The main menu screen appears.

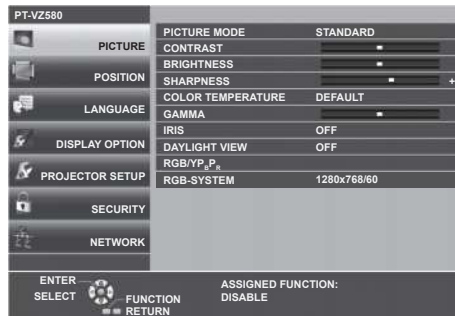

- 2) Press ▲▼ to select an item from the main menu.
 - The selected item is highlighted in yellow.

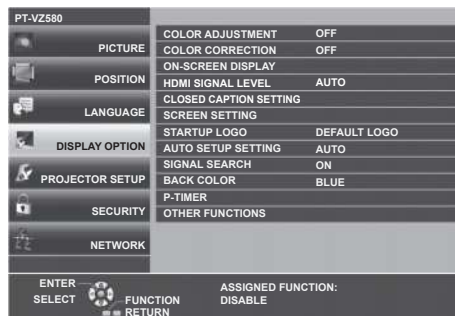

- 3) Press the <ENTER> button.
 - You can operate the sub-menus of the selected main menu.

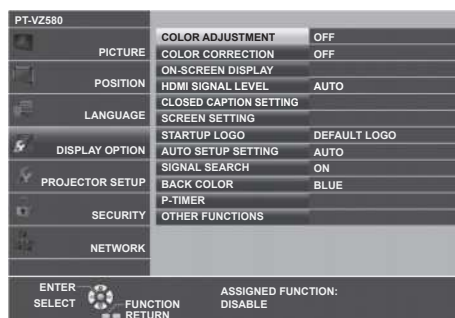

- 4) Press ▲▼ to select the desired sub-menu item, press ◀▶ or the <ENTER> button to switch or adjust settings.
 - Depending on the item, each time you press the ◀▶ button, items are switched in order as shown below.

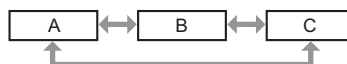

- Depending on the item, each time you press the ◀▶ button, the individual adjustment screen with a bar scale is displayed as shown below.



Note

- Pressing the <MENU> button while the menu screen is displayed will return the previous menu. You can operate in the same way by pressing the <RETURN> button.
- Some items may not be adjusted or used depending on the selected signals or input signals to the projector. The menu items that cannot be adjusted or used are shown in gray characters, and they cannot be selected.
- Some items can be adjusted even if signals are not input.
- Individual adjustment screen disappears automatically if no operation is performed within approximately five seconds.
- For menu items, refer to “Main menu” (➔ page 54) and “Sub menu” (➔ page 55).

Resetting adjustment values to the factory default

If the <DEFAULT> button on the remote control is pressed, the values adjusted in the menu items are restored to the factory default settings.

DEFAULT



button

1) Press the <DEFAULT> button on the remote control.







Note

- You cannot reset all the settings to the factory default at a time.
- To reset all the settings adjusted in the sub-menu item to the factory default at a time, execute the [PROJECTOR SETUP] menu → [INITIALIZE ALL].
- Some items cannot be reset by pressing the <DEFAULT> button on the remote control. Adjust these items individually.

Main menu

The main menu consists of the following seven menu items.

When a main menu item is selected, the cursor moves to its sub menu.

	Main-menu item	Page
	[PICTURE]	57
	[POSITION]	62
	[LANGUAGE]	69
	[DISPLAY OPTION]	70
	[PROJECTOR SETUP]	78
	[SECURITY]	86
	[NETWORK]	89

Sub menu

You can set and adjust the items in each submenu.

[PICTURE]

Sub-menu item	Factory default	Page
[PICTURE MODE]	[STANDARD]	57
[CONTRAST]	[0]	57
[BRIGHTNESS]	[0]	57
[COLOR]	[0]	57
[TINT]	[0]	58
[SHARPNESS]	[0]	58
[COLOR TEMPERATURE]	[DEFAULT]	58
[GAMMA]	[0]	59
[IRIS]	[OFF]	59
[DAYLIGHT VIEW]	[ON]	59
[DIGITAL CINEMA REALITY]	[ON]	59
[NOISE REDUCTION]	[OFF]*1	60
[TV-SYSTEM]	[AUTO]	60
[RGB/Y _B P _R] / [RGB/Y _B C _R]	[AUTO]	60
[RGB-SYSTEM]	[1280x768/60]*2	61

*1 It depends on the [PICTURE MODE].

*2 It depends on the input signal.

[POSITION]

Sub-menu item	Factory default	Page
[REALTIME KEYSTONE]	[ON]	62
[SCREEN ADJUSTMENT]	-	62
[SHIFT]	-	65
[DOT CLOCK]	[0]	66
[CLOCK PHASE]	[0]	66
[OVER SCAN]	[0]*1	67
[ASPECT]	[NORMAL]*1	67
[FRAME LOCK]	[ON]	68

*1 It depends on the input signal.

[LANGUAGE]

Details (→ page 69)

[DISPLAY OPTION]

Sub-menu item	Factory default	Page
[COLOR ADJUSTMENT]	[OFF]	70
[COLOR CORRECTION]	[OFF]	71
[ON-SCREEN DISPLAY]	-	71
[HDMI SIGNAL LEVEL]	[AUTO]	73
[CLOSED CAPTION SETTING]	-	73
[SCREEN SETTING]	-	74
[STARTUP LOGO]	[DEFAULT LOGO]	74
[AUTO SETUP SETTING]	[AUTO]	75
[SIGNAL SEARCH]	[ON]	75
[BACK COLOR]	[BLUE]	75
[P-TIMER]	-	75
[OTHER FUNCTIONS]	-	76

[PROJECTOR SETUP] 

Sub-menu item	Factory default	Page
[STATUS]	-	78
[COMPUTER2 SELECT]	[COMPUTER2 IN]	78
[PROJECTOR ID]	[ALL]	78
[INITIAL START UP]	[LAST MEMORY]	79
[PROJECTION METHOD]	[AUTO]	79
[LAMP POWER]	[NORMAL]	79
[ECO MANAGEMENT]	-	80
[EMULATE]	[DEFAULT]	81
[FUNCTION BUTTON]	-	82
[AUDIO SETTING]	-	82
[TEST PATTERN]	-	83
[FILTER COUNTER]	-	84
[DC OUT]	[ON]	85
[INITIALIZE ALL]	-	85

[SECURITY] 

Sub-menu item	Factory Default	Page
[PASSWORD]	[OFF]	86
[PASSWORD CHANGE]	-	86
[TEXT DISPLAY]	[OFF]	87
[TEXT CHANGE]	-	87
[MENU LOCK]	[OFF]	87
[MENU LOCK PASSWORD]	-	87
[CONTROL DEVICE SETUP]	-	88

[NETWORK] 

Sub-menu item	Factory default	Page
[WIRED LAN]	-	89
[PROJECTOR NAME]	-	89
[NETWORK CONTROL]	[ON]	89
[NETWORK STATUS]	-	90
[INITIALIZE]	-	90

Note

- Some items may not be adjusted or used for certain signal formats to be input to the projector.
The menu items that cannot be adjusted or used are shown in gray characters, and they cannot be selected.
- Sub-menu items and factory default settings differ depending on the selected input.

[PICTURE] menu

On the menu screen, select [PICTURE] from the main menu, and select an item from the submenu. Refer to “Navigating through the menu” (➔ page 53) for the operation of the menu screen.

[PICTURE MODE]

You can switch to the desired picture mode most suitable for the image source and the environment in which the projector is used.

- 1) Press ▲▼ to select [PICTURE MODE].
- 2) Press ◀▶ or the <ENTER> button.
 - The [PICTURE MODE] individual adjustment screen is displayed.
- 3) Press ◀▶ to switch the items.
 - The items will switch each time you press the button.

[STANDARD]	The picture becomes suitable for movie-based images in general.
[DYNAMIC]	The picture becomes suitable for use in bright areas.
[BLACKBOARD]	The picture becomes suitable for projecting on a black board.
[WHITE BOARD]	The picture becomes suitable for projecting on a white board.
[CINEMA]*1	The picture becomes suitable for movie contents.
[NATURAL]*2	The picture becomes suitable for use in a dark room.

*1 Only for the movie-based signals.

*2 Only for the still image signals.

[CONTRAST]

You can adjust the contrast of the colors.

- 1) Press ▲▼ to select [CONTRAST].
- 2) Press ◀▶ or the <ENTER> button.
 - The [CONTRAST] individual adjustment screen is displayed.
- 3) Press ◀▶ to adjust the level.

Operation	Adjustment	Adjustment range
Press the ▶ button.	The screen becomes brighter.	-32 ~ +32
Press the ◀ button.	The screen becomes darker.	

Attention

- Adjust [BRIGHTNESS] first when you need to adjust [BRIGHTNESS] and [CONTRAST].

[BRIGHTNESS]

You can adjust the dark (black) part of the projected image.

- 1) Press ▲▼ to select [BRIGHTNESS].
- 2) Press ◀▶ or the <ENTER> button.
 - The [BRIGHTNESS] individual adjustment screen is displayed.
- 3) Press ◀▶ to adjust the level.

Operation	Adjustment	Adjustment range
Press the ▶ button.	Increases the brightness of the dark (black) parts of the screen.	-32 ~ +32
Press the ◀ button.	Reduces the brightness of the dark (black) parts of the screen.	

[COLOR]

(Only for movie-based signal input)

You can adjust the color saturation of the projected image.

- 1) Press ▲▼ to select [COLOR].

- 2) Press ◀▶ or the <ENTER> button.
 - The [COLOR] individual adjustment screen is displayed.
- 3) Press ◀▶ to adjust the level.

Operation	Adjustment	Adjustment range
Press the ▶ button.	Deepens colors.	-32 ~ +32
Press the ◀ button.	Weakens colors.	

[TINT]

(Only for movie-based signal input except PAL / PAL-M / PAL-N / PAL60 / SECAM)
You can adjust the skin tone in the projected image.

- 1) Press ▲▼ to select [TINT].
- 2) Press ◀▶ or the <ENTER> button.
 - The [TINT] individual adjustment screen is displayed.
- 3) Press ◀▶ to adjust the level.

Operation	Adjustment	Adjustment range
Press the ▶ button.	Adjusts skin tone toward greenish color.	-32 ~ +32
Press the ◀ button.	Adjusts skin tone toward reddish purple.	

[SHARPNESS]

You can adjust the sharpness of the projected image.

- 1) Press ▲▼ to select [SHARPNESS].
- 2) Press ◀▶ or the <ENTER> button.
 - The [SHARPNESS] individual adjustment screen is displayed.
- 3) Press ◀▶ to adjust the level.

Operation	Adjustment	Adjustment range
Press the ▶ button.	Contours become sharper.	0 ~ +15
Press the ◀ button.	Contours become softer.	

Note

- [SHARPNESS] will be invalid when [DAYLIGHT VIEW] is set to [AUTO] or [ON].

[COLOR TEMPERATURE]

You can switch the color temperature if the white areas of the projected image are bluish or reddish.

- 1) Press ▲▼ to select [COLOR TEMPERATURE].
- 2) Press ◀▶ or the <ENTER> button.
 - The [COLOR TEMPERATURE] individual adjustment screen is displayed.
- 3) Press ◀▶ to switch the item.
 - The items will switch each time you press the button.

[DEFAULT]	Factory default setting.
[HIGH]	Becomes a bluish image. Select this when the white areas of the projected image are reddish.
[LOW]	Becomes a reddish image. Select this when the white areas of the projected image are bluish.

Note

- When the [DISPLAY OPTION] menu → [COLOR ADJUSTMENT] is set to other than [OFF], [COLOR TEMPERATURE] is fixed to [DEFAULT].

[GAMMA]

You can adjust contrast balance.

- 1) Press ▲▼ to select [GAMMA].
- 2) Press ◀▶ or the <ENTER> button.
 - The [GAMMA] individual adjustment screen is displayed.
- 3) Press ◀▶ to adjust the level.

Operation	Adjustment	Adjustment range
Press the ▶ button.	The midtones become brighter.	-8 ~ +7
Press the ◀ button.	The midtones become darker.	

[IRIS]

By automatically adjusting the aperture according to the image, it makes an image of optimum contrast.

- 1) Press ▲▼ to select [IRIS].
- 2) Press ◀▶ or the <ENTER> button.
 - The [IRIS] individual adjustment screen is displayed.
- 3) Press ◀▶ to switch the item.
 - The items will switch each time you press the button.

[OFF]	No aperture correction.
[ON]	Corrects the aperture.

[DAYLIGHT VIEW]

You can correct the image to the optimal vividness even if it is projected under a bright light.

- 1) Press ▲▼ to select [DAYLIGHT VIEW].
- 2) Press ◀▶ or the <ENTER> button.
 - The [DAYLIGHT VIEW] individual adjustment screen is displayed.
- 3) Press ◀▶ to switch the item.
 - The items will switch each time you press the button.

[ON]	Corrects the vividness of the image.
[OFF]	No correction.
[AUTO]	Detects the brightness of the installation environment with the luminance sensor, and automatically corrects the vividness of the image.

Note

- [DAYLIGHT VIEW] cannot be set to [AUTO] when the [PROJECTOR SETUP] menu → [PROJECTION METHOD] is set to [REAR/DESK] or [REAR/CEILING].
- The luminance may not be detected correctly when an object is placed on top of the projector, blocking the luminance sensor. In such a case, this function may not operate properly even if it is set to [AUTO].

[DIGITAL CINEMA REALITY]

When inputting the following signals, it performs cinema processing to improve the vertical resolution and the image quality.

480/60i, 576/50i, 1080/60i, 1080/50i signals and VIDEO signal

- 1) Press ▲▼ to select [DIGITAL CINEMA REALITY].
- 2) Press ◀▶ or the <ENTER> button.
 - The [DIGITAL CINEMA REALITY] individual adjustment screen is displayed.

3) Press ◀▶ to switch the item.

- The items will switch each time you press the button.

[OFF]	Performs no cinema processing.
[ON]	Performs cinema processing.

[NOISE REDUCTION]

(Only for VIDEO signal input)

You can reduce noises when the input image is degraded and noise is occurring in the image signal.

1) Press ▲▼ to select [NOISE REDUCTION].

2) Press ◀▶ or the <ENTER> button.

- The [NOISE REDUCTION] individual adjustment screen is displayed.

3) Press ◀▶ to switch the item.

- The items will switch each time you press the button.

[OFF]	No correction.
[ON]	Reduces noises.

Attention

- When this is set for an input signal with less noise, the image may look different from what it originally was. In such a case, set it to [OFF].

[TV-SYSTEM]

(Only for VIDEO signal input)

The projector will automatically detect the input signal, but you can set the color system manually when an unstable signal is input. Set the color system matching the input signal.

1) Press ▲▼ to select [TV-SYSTEM].

2) Press ◀▶ or the <ENTER> button.

- The [TV-SYSTEM] individual adjustment screen is displayed.

3) Press ◀▶ to switch the item.

- The items will switch each time you press the button.
- Select among [AUTO], [NTSC], [NTSC4.43], [PAL], [PAL-M], [PAL-N], [PAL60] and [SECAM].
- Set it to [AUTO] normally. (Setting [AUTO] will automatically select [NTSC], [NTSC4.43], [PAL], [PAL-M], [PAL-N], [SECAM], or [PAL60].)

[RGB/YC_BC_R] / [RGB/YP_BP_R]

The projector will automatically detect the input signal, but you can set the system format manually when an unstable signal is input. Set the system format matching the input signal.

1) Press ▲▼ to select [RGB/YC_BC_R] or [RGB/YP_BP_R].

2) Press ◀▶ or the <ENTER> button.

- The [RGB/YC_BC_R] or [RGB/YP_BP_R] individual adjustment screen is displayed.

3) Press ◀▶ to switch the item.

- The items will switch each time you press the button.
- Normally it is set to [AUTO]. If it cannot project properly with [AUTO], set it to [RGB], [YC_BC_R] or [YP_BP_R] according to the input signal.

Terminal	System format	
<COMPUTER 1 IN> terminal / <COMPUTER 2 IN/1 OUT> terminal	480/60i, 576/50i, 480/60p, 576/50p	Select [AUTO], [RGB] or [YC _B C _R]
	Other movie-based image signals	Select [AUTO], [RGB] or [YP _B P _R]
<HDMI 1 IN> terminal / <HDMI 2 IN> terminal	480/60i, 576/50i, 480/60p, 576/50p	Select [AUTO], [RGB] or [YC _B C _R]
	Other image signals	Select [AUTO], [RGB] or [YP _B P _R]

Note

- For details of the image signals that can be used with the projector, refer to “List of compatible signals” (➔ page 126).
- This may not operate properly for some connected external devices.

[RGB-SYSTEM]

(Only for analog RGB signal input)

The projector automatically detects the input signal, but the images may not be displayed properly depending on the input signal. In that case, select the item according to the input signal.

- 1) Press ▲▼ to select [RGB-SYSTEM].
- 2) Press the <ENTER> button.
 - The [RGB-SYSTEM] screen is displayed.
- 3) Press ▲▼ to select the signal and press the <ENTER> button.
 - The selectable items differ depending on the input signal.

Items	Resolution (dots)	Scanning frequency		Dot clock frequency (MHz)
		Horizontal (kHz)	Vertical (Hz)	
[1280x768/60]	1 280 x 768	47.7	60.0	80.1
[1366x768/60]	1 366 x 768	47.7	60.0	84.7
[1400x1050/60]	1 400 x 1 050	65.2	60.0	122.6
[1680x1050/60]	1 680 x 1 050	65.2	60.0	147.1
[1440x900/50]	1 440 x 900	46.3	50.0	87.4
[1600x900/50]	1 600 x 900	46.3	50.0	97.0
[1440x900/60]	1 440 x 900	55.9	60.0	106.5
[1600x900/60]	1 600 x 900	55.9	60.0	119.0

Note

- It may not work properly for some connected external devices.

[POSITION] menu

On the menu screen, select [POSITION] from the main menu, and select an item from the submenu. Refer to “Navigating through the menu” (➔ page 53) for the operation of the menu screen.

[REALTIME KEYSTONE]

The projector can correct the vertical trapezoidal distortion automatically when the projector is installed tilted.

- 1) Press ▲▼ to select [REALTIME KEYSTONE].
- 2) Press ◀▶ or the <ENTER> button.
 - The [REALTIME KEYSTONE] individual adjustment screen is displayed.
- 3) Press ◀▶ to switch the item.

[ON]	Enables the automatic realtime keystone correction.
[OFF]	Disables the automatic realtime keystone correction.

Note

- Depending on the installation situation, the trapezoidal distortion may not be able to fully corrected. In this case, perform the adjustment in the [POSITION] menu → [SCREEN ADJUSTMENT].
- [REALTIME KEYSTONE] cannot be set when the [PROJECTOR SETUP] menu → [PROJECTION METHOD] is set to [FRONT/CEILING] or [REAR/CEILING].

[SCREEN ADJUSTMENT]

Correct the distortion when the projector is installed as tilted or the screen is tilted or curved.

- 1) Press ▲▼ to select [SCREEN ADJUSTMENT].
- 2) Press the <ENTER> button.
 - The [SCREEN ADJUSTMENT] screen is displayed.
- 3) Press ▲▼ to select one item to adjust.

[KEYSTONE]	Adjusts when the projected image is distorted as trapezoid.
[CORNER CORRECTION]	Adjusts when the four corners of the projected image are distorted.
[CURVED CORRECTION]	Adjusts when the projected image is curved distortion.

- 4) Press the <ENTER> button.
 - The [KEYSTONE] screen, [CORNER CORRECTION] screen or the [CURVED CORRECTION] screen is displayed.

Note

- Only one item of [KEYSTONE], [CORNER CORRECTION] and [CURVED CORRECTION] can be enabled. If you perform the setting of [KEYSTONE], [CORNER CORRECTION] or [CURVED CORRECTION] and then perform the setting of the other items, the value of the previous items will be reset.
- The image quality will deteriorate as the correction amount of [SCREEN ADJUSTMENT] increases, making focusing difficult. Install the projector so that the correction amount is as small as possible.
- When adjustments are performed with [SCREEN ADJUSTMENT], the image size also changes.

Setting [KEYSTONE]

- 1) Press ▲▼ to select [SCREEN ADJUSTMENT].
- 2) Press the <ENTER> button.
 - The [SCREEN ADJUSTMENT] screen is displayed.
- 3) Press ▲▼ to select [KEYSTONE].
- 4) Press the <ENTER> button.
 - The [KEYSTONE] screen is displayed.

- 5) Press ▲▼ to select one item to adjust.
- 6) Press the <ENTER> button.
 - The individual adjustment screen of the selected item is displayed.
 - If you select [LENS THROW RATIO] or [BALANCE] in Step 5), you can also press ◀▶ to display the individual adjustment screen.
- 7) Press ◀▶ to adjust.
 - Press ▲▼◀▶ to adjust when [KEYSTONE] is selected in Step 5).

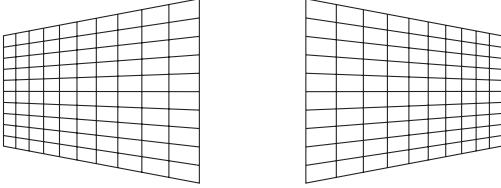
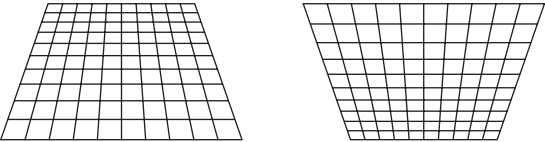
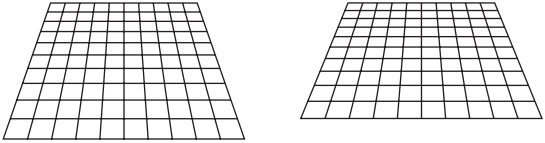
[LENS THROW RATIO]	Set the throw ratio. The adjustable range is 0.9 ~2.3. Select a value close to the value obtained by dividing the actual projection distance by the projection screen width.
[KEYSTONE]	[H] 
	[V] 
[BALANCE]	

Note

- Pressing the <ENTER> button while the individual adjustment screen is displayed can switch to the individual adjustment screen of other items.

Setting [CORNER CORRECTION]

- 1) Press ▲▼ to select [SCREEN ADJUSTMENT].
- 2) Press the <ENTER> button.
 - The [SCREEN ADJUSTMENT] screen is displayed.
- 3) Press ▲▼ to select [CORNER CORRECTION].
- 4) Press the <ENTER> button.
 - The [CORNER CORRECTION] screen is displayed.
- 5) Press ▲▼ to select the item to adjust.
- 6) Press the <ENTER> button.
 - The individual adjustment screen of the selected item is displayed.
- 7) Press ▲▼◀▶ to adjust.

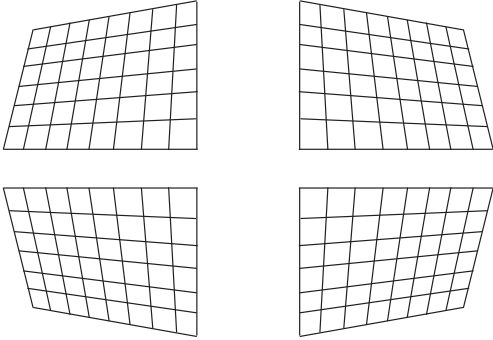
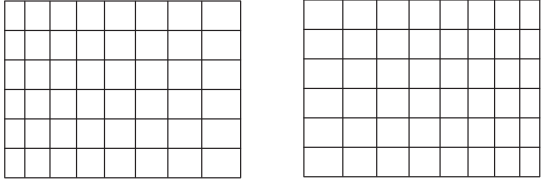
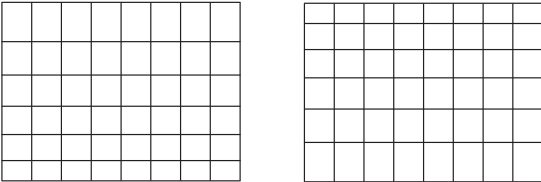
<p>[UPPER LEFT] [UPPER RIGHT] [LOWER LEFT] [LOWER RIGHT]</p>	
<p>[LINEARITY]</p>	<p>[H]</p> 
	<p>[V]</p> 

Note

- Pressing the <ENTER> button while the individual adjustment screen is displayed can switch to the individual adjustment screen of other items.
- Depending on the correction amount, the image aspect ratio may change.

Setting [CURVED CORRECTION]

- 1) Press ▲▼ to select [SCREEN ADJUSTMENT].
- 2) Press the <ENTER> button.
 - The [SCREEN ADJUSTMENT] screen is displayed.
- 3) Press ▲▼ to select [CURVED CORRECTION].
- 4) Press the <ENTER> button.
 - The [CURVED CORRECTION] screen is displayed.
- 5) Press ▲▼ to select the item to adjust.
- 6) Press the <ENTER> button.
 - The individual adjustment screen of the selected item is displayed.
 - You can also display the individual adjustment screen by pressing ◀▶ button when [LENS THROW RATIO], [BALANCE], or [MAINTAIN ASPECT RATIO] is selected in Step 5).
- 7) Press ◀▶ to adjust.
 - You can press ▲▼◀▶ to adjust when [KEystone] or [ARC] is selected in Step 5).

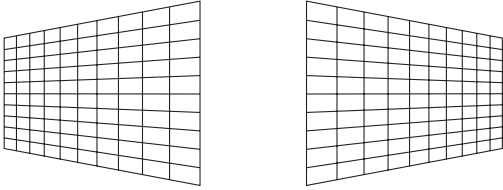
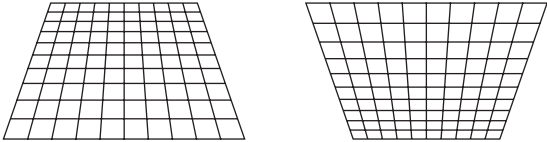
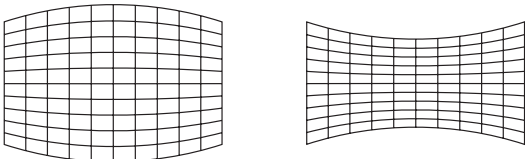
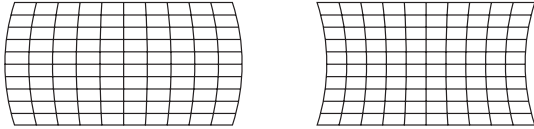
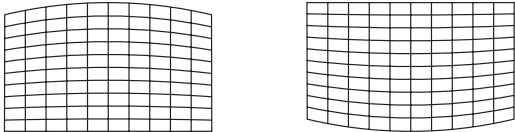
[LENS THROW RATIO]	Set the throw ratio. The adjustable range is 0.9 ~ 2.3. Select a value close to the value obtained by dividing the actual projection distance by the projection screen width.	
[KEYSTONE]	[H]	
	[V]	
[ARC]	[H]	
	[V]	
[BALANCE]		
[MAINTAIN ASPECT RATIO]	To adjust without changing the aspect ratio, set it to [ON].	

Note

- Pressing the <ENTER> button while the individual adjustment screen is displayed can switch to the individual adjustment screen of other items.

[SHIFT]

(Only for COMPUTER1 / COMPUTER2 signal input)

Move the image position vertically or horizontally if the image position projected on the screen is shifted even when the relative position of the projector and the screen is installed correctly.

- 1) Press ▲▼ to select [SHIFT].
- 2) Press the <ENTER> button.
 - The [SHIFT] screen is displayed.
- 3) Press ▲▼◀▶ to adjust the position.

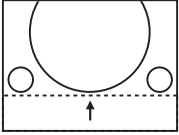
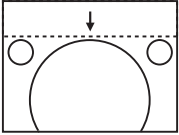
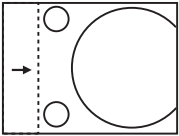
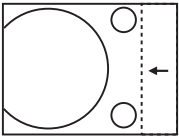
Orientation	Operation	Adjustment	
Vertical (up and down) adjustment.	Press the ▲ button.	The image position moves up.	
	Press the ▼ button.	The image position moves down.	
Horizontal (right and left) adjustment.	Press the ► button.	The image position moves to the right.	
	Press the ◀ button.	The image position moves to the left.	

Note

- Depending on the input signal, if the adjustment of [SHIFT] exceeds the effective adjustment range of the input signal, the position of the image cannot be changed. Adjust within the effective adjustment range.

[DOT CLOCK]

(Only for COMPUTER1 signal input / COMPUTER2 signal input)

Adjust to reduce noise generated when projecting vertical stripes.

When projecting a striped pattern, periodic stripes (noise) may occur. In this case, adjust so that the noise is the least.

- 1) Press ▲▼ to select [DOT CLOCK].
- 2) Press ◀▶ or the <ENTER> button.
 - The [DOT CLOCK] individual adjustment screen is displayed.
- 3) Press ◀▶ to adjust.
 - The adjustment values are [-32] to [+32].

Attention

- Set it before adjusting [CLOCK PHASE].

[CLOCK PHASE]

(Only for COMPUTER1 input / COMPUTER2 input)

You can adjust to achieve an optimal image when there is a flickering image or smeared outlines.

- 1) Press ▲▼ to select [CLOCK PHASE].
- 2) Press ◀▶ or the <ENTER> button.
 - The [CLOCK PHASE] individual adjustment screen is displayed.
- 3) Press ◀▶ to adjust the value.
 - Adjustment value will change between [0] and [+31]. Adjust so that the amount of interference is at a minimum.

Note

- Certain signals may not be adjustable.
- Optimal value may not be achieved if the output from the input computer is unstable.
- To project an image signal with dot clock frequency with 162 MHz or higher, noise may not disappear even if [CLOCK PHASE] is adjusted.

[OVER SCAN]

(Only for movie-based signal input)

Use this function when characters or pictures are cropped near the periphery of the projected image.

- 1) Press ▲▼ to select **[OVER SCAN]**.
- 2) Press ◀▶ or the <ENTER> button.
 - The **[OVER SCAN]** individual adjustment screen is displayed.
- 3) Press ◀▶ to adjust the level.
 - The adjustment values are [0] to [+3].

[ASPECT]

You can switch the aspect ratio of the image.

The aspect ratio is switched within the screen range selected in the [DISPLAY OPTION] menu → [SCREEN SETTING] → [SCREEN FORMAT]. Set [SCREEN FORMAT] first. (➡ page 74)

- 1) Press ▲▼ to select **[ASPECT]**.
- 2) Press ◀▶ or the <ENTER> button.
 - The **[ASPECT]** individual adjustment screen is displayed.
- 3) Press ◀▶ to switch the item.
 - The items will switch each time you press the button.

[NORMAL]	Displays images without changing the aspect ratio of the input signals.
[AUTO]*1	Identifies the identification signal of the aspect ratio incorporated in the image signal, automatically switches to the optimum aspect ratio and displays it.
[WIDE]	Displays images with the aspect ratio converted to 16:9 when standard signals*2 are input. Display images without changing the aspect ratio of the input signal when wide-screen signals*3 are input.
[H FIT]	Displays images with the full width of the screen range selected in [SCREEN FORMAT]. When signals have the aspect ratio vertically greater than the screen aspect ratio selected in [SCREEN FORMAT], the images are displayed with the top and bottom parts cut off.
[V FIT]	Displays images with the full height of the screen range selected in [SCREEN FORMAT]. When signals have the aspect ratio horizontally greater than the screen aspect ratio selected in [SCREEN FORMAT], the images are displayed with the right and left parts cut off.
[FULL]	Displays images to the full screen range selected in [SCREEN FORMAT]. If the aspect ratio of the input signal is different from the aspect ratio of the screen range, it is converted to the screen aspect ratio selected in [SCREEN FORMAT] and displayed.
[NATIVE]	Displays images without changing the resolution of the input signals.

*1 Only for video signal (NTSC) input.

*2 Standard signals are input signals with an aspect ratio of 4:3 or 5:4.

*3 Wide-screen signals are input signals with an aspect ratio of 16:10, 16:9 or 15:9.

Note

- Some size modes are not available for certain types of input signals.
- The image size may be switched abnormally when [AUTO] is selected, set to [NORMAL] or [WIDE] according to the input signal.
- If an aspect ratio which is different from the aspect ratio for the input signals is selected, the images will appear differently from the originals. Be careful of this when selecting the aspect ratio.
- If using the projector in places such as cafes or hotels to display programs for a commercial purpose or for public presentation, note that adjusting the aspect ratio or using the zoom function to change the screen images may be an infringement of the rights of the original copyright owner for that program under copyright protection laws. Take care when using a function of the projector such as the aspect ratio adjustment and zoom function.
- If conventional (normal) 4:3 images which are not wide-screen images are displayed on a wide screen, the edges of the images may not be visible or they may become distorted. Such images should be viewed as with an aspect ratio of 4:3 in the original format intended by the creator of the images.

[FRAME LOCK]

(Only for still image signals input)

The frame lock function can be set for some signals.

- 1) Press ▲▼ to select [FRAME LOCK].
- 2) Press ◀▶ or the <ENTER> button.
 - The [FRAME LOCK] individual adjustment screen is displayed.
- 3) Press ◀▶ to switch the item.
 - The items will switch each time you press the button.

[ON]	The frame is locked. Synchronizes the displayed image to the vertical scanning frequency of the input signal.
[OFF]	The frame lock function is turned off. Set to [OFF] if you are concerned about flickering.

[LANGUAGE] menu

On the menu screen, select [LANGUAGE] from the main menu, and select an item from the submenu. Refer to “Navigating through the menu” (➔ page 53) for the operation of the menu screen.

Switching the display language

You can select the language of the on-screen display.

- 1) Press ▲▼ to select the display language, and press the <ENTER> button.

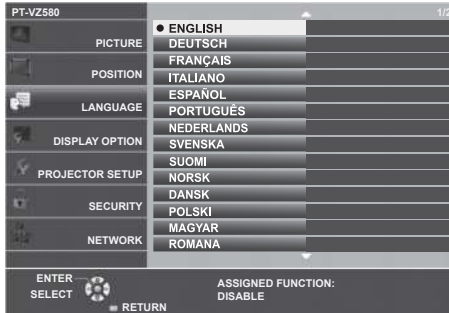

- Various menus, settings, adjustment screens, control button names, etc., are displayed in the selected language.
- The language can be changed to English, German, French, Italian, Spanish, Portuguese, Dutch, Swedish, Finnish, Norwegian, Danish, Polish, Hungarian, Romanian, Czech, Russian, Turkish, Arabic, Kazakh, Vietnamese, Korean, Chinese, Japanese and Thai.

Note

- The on-screen display language is set to English in the factory default setting as well as when the [PROJECTOR SETUP] menu → [INITIALIZE ALL] is executed.

[DISPLAY OPTION] menu

On the menu screen, select [DISPLAY OPTION] from the main menu, and select an item from the submenu. Refer to “Navigating through the menu” (➔ page 53) for the operation of the menu screen.

[COLOR ADJUSTMENT]

Correct the color difference between projectors when multiple projectors are used simultaneously.

- 1) Press ▲▼ to select [COLOR ADJUSTMENT].
- 2) Press ◀▶ to switch the item.
 - The items will switch each time you press the button.

[OFF]	Color adjustment is not carried out.
[3COLORS]	Adjusts the three colors [RED], [GREEN], or [BLUE] and the white [GAIN]. For details of this mode, refer to “Adjusting [3COLORS]” (➔ page 70).
[6COLORS]	Adjusts [WHITE LEVEL] and the six colors [RED], [GREEN], [BLUE], [CYAN], [MAGENTA] or [YELLOW]. For details, refer to “Adjusting [6COLORS]” (➔ page 70).

Adjusting [3COLORS]

- 1) Press ▲▼ to select [COLOR ADJUSTMENT].
- 2) Press ◀▶ to select [3COLORS].
- 3) Press the <ENTER> button.
 - The [3COLORS] screen is displayed.
- 4) Press ▲▼ to select [RED], [GREEN], [BLUE] or [WHITE].
- 5) Press the <ENTER> button.
 - The [3COLORS:RED], [3COLORS:GREEN], [3COLORS:BLUE] or [3COLORS:WHITE] screen is displayed.
 - By setting [AUTO TESTPATTERN] to [ON], the test pattern for the selected color is displayed.
- 6) Press ▲▼ to select [RED], [GREEN] or [BLUE].
 - [GAIN] can be adjusted when [WHITE] is selected in Step 4).
- 7) Press ◀▶ to adjust.
 - The adjustment value changes between 0^{*1} and 2 048.

*1 The lower limit varies depending on the adjusting color.

Note

- Operation when correcting the adjustment color
 When correction color red is changed: Red is added to or subtracted from the adjustment color.
 When correction color green is changed: Green is added to or subtracted from the adjustment color.
 When correction color blue is changed: Blue is added to or subtracted from the adjustment color.
- This adjustment should be carried out by a person who is familiar with the projector or by a service person because a high level of skill is required to make a successful adjustment.
- Pressing the <DEFAULT> button on the remote control will restore the factory default settings for all items.
- When [COLOR ADJUSTMENT] is set to [3COLORS], [COLOR CORRECTION] is fixed to [OFF] and the [PICTURE] menu → [COLOR TEMPERATURE] is fixed to [DEFAULT].

Adjusting [6COLORS]

- 1) Press ▲▼ to select [COLOR ADJUSTMENT].
- 2) Press ◀▶ to select [6COLORS].
- 3) Press the <ENTER> button.
 - The [6COLORS] screen is displayed.
- 4) Press ▲▼ to select [WHITE LEVEL].

- 5) Press the <ENTER> button.
 - The [WHITE LEVEL] screen is displayed.
 - By setting [AUTO TESTPATTERN] to [ON], the test pattern for white is displayed.
- 6) Press ▲▼ to select [RED], [GREEN] or [BLUE].
- 7) Press ◀▶ to adjust.
 - The adjustment value changes between 128 and 512.
- 8) Press the <MENU> button.
 - The [6COLORS] screen is displayed.
- 9) Press ▲▼ to select [RGBCMY].
- 10) Press the <ENTER> button.
 - The [RGBCMY] screen is displayed.
- 11) Press ▲▼ to select [RED], [GREEN], [BLUE], [CYAN], [MAGENTA] or [YELLOW].
- 12) Press the <ENTER> button.
 - The [RGBCMY:RED], [RGBCMY:GREEN], [RGBCMY:BLUE], [RGBCMY:CYAN], [RGBCMY:MAGENTA] or [RGBCMY:YELLOW] screen is displayed.
 - By setting [AUTO TESTPATTERN] to [ON], the test pattern for the selected color is displayed.
- 13) Press ▲▼ to select [RED], [GREEN] or [BLUE].
- 14) Press ◀▶ to adjust.
 - The adjustment value changes between 0^{*1} and 512^{*1}.

*1 The lower and upper limits vary depending on the adjusting color.

Note

- When adjusting [6COLORS], follow the order from [WHITE LEVEL] to [RGBCMY]. If [WHITE LEVEL] is adjusted after [RGBCMY], you need to adjust the [RGBCMY] again.
- Operation when correcting the adjustment color
 When correction color red is changed: Red is added to or subtracted from the adjustment color.
 When correction color green is changed: Green is added to or subtracted from the adjustment color.
 When correction color blue is changed: Blue is added to or subtracted from the adjustment color.
- This adjustment should be carried out by a person who is familiar with the projector or by a service person because a high level of skill is required to make a successful adjustment.
- Pressing the <DEFAULT> button on the remote control will restore the factory default settings for all items.
- When [COLOR ADJUSTMENT] is set to [6COLORS], [COLOR CORRECTION] is fixed to [OFF] and the [PICTURE] menu → [COLOR TEMPERATURE] is fixed to [DEFAULT].

[COLOR CORRECTION]

Colors can be adjusted and registered for each input signal format.

- 1) Press ▲▼ to select [COLOR CORRECTION].
- 2) Press ◀▶ to switch the item.
 - The items will switch each time you press the button.

[OFF]	Standard setting
[USER]	For each of the following three signal formats: VIDEO, RGB, and YP _B P _R /YC _B C _R , six colors of red, green, blue, cyan, magenta, and yellow can be adjusted and registered. Press the <ENTER> button to set the details. Adjustment is possible within the range of -32 - +32.

Note

- When [COLOR ADJUSTMENT] is set to other than [OFF], [COLOR CORRECTION] is fixed to [OFF] and cannot be set.

[ON-SCREEN DISPLAY]

Set the on-screen display.

Setting [INPUT GUIDE]

Set the input guide to be displayed when switching the input. The input guide screen shows the currently selected input and input signal names.

- 1) Press ▲▼ to select [ON-SCREEN DISPLAY].
- 2) Press the <ENTER> button.
 - The [ON-SCREEN DISPLAY] screen is displayed.
- 3) Press ▲▼ to select [INPUT GUIDE].
- 4) Press ◀▶ to switch the item.
 - The items will switch each time you press the button.

[DETAILED]	Display the name of input terminal graphically, and display the input signal name or resolution of the selected input terminal.
[OFF]	Disables the input guide.
[SIMPLE]	Display the name of selected input terminal and input signal.

Note

- When it is set to [DETAILED], you can select the input with ▲▼◀▶ on the control panel or the remote control while the input guide is displayed.

Setting [OSD POSITION]

Set the position of the menu screen (OSD). In conjunction with this setting, the display position of the individual adjustment screen also changes.

- 1) Press ▲▼ to select [ON-SCREEN DISPLAY].
- 2) Press the <ENTER> button.
 - The [ON-SCREEN DISPLAY] screen is displayed.
- 3) Press ▲▼ to select [OSD POSITION].
- 4) Press ◀▶ to switch the item.
 - The items will switch each time you press the button.

Items	Menu screen (OSD)	Individual adjustment screen
[CENTER]	Sets it to the center of the screen.	It is displayed at the center of the screen.
[UPPER LEFT]	Sets it to the upper left of the screen.	It is displayed at the upper screen.
[UPPER RIGHT]	Sets it to the upper right of the screen.	It is displayed at the upper screen.
[LOWER LEFT]	Sets it to the lower left of the screen.	It is displayed at the lower screen.
[LOWER RIGHT]	Sets it to the lower right of the screen.	It is displayed at the lower screen.

Setting [OSD SIZE]

(Only for PT-VZ580)

Set the size of the menu screen (OSD).

- 1) Press ▲▼ to select [ON-SCREEN DISPLAY].
- 2) Press the <ENTER> button.
 - The [ON-SCREEN DISPLAY] screen is displayed.
- 3) Press ▲▼ to select [OSD SIZE].
- 4) Press ◀▶ to switch the item.

[NORMAL]	Use this setting normally.
[DOUBLE]	The menu screen is displayed with the font size twice as much as set in [NORMAL]. The menu screen size is doubled both vertically and horizontally.

[WARNING MESSAGE]

Set the display/hide of the warning message.

- 1) Press ▲▼ to select [ON-SCREEN DISPLAY].
- 2) Press the <ENTER> button.
 - The [ON-SCREEN DISPLAY] screen is displayed.
- 3) Press ▲▼ to select [WARNING MESSAGE].
- 4) Press ◀▶ to switch the item.
 - The items will switch each time you press the button.

[ON]	Displays the warning message.
[OFF]	Hides the warning message.

Note

- When [WARNING MESSAGE] is set to [OFF], the warning message will not be displayed on the projected image even if a warning status such as "TEMPERATURE WARNING" is detected. The prompting message for filter replacement/maintenance or lamp unit replacement will not be displayed either.

[HDMI SIGNAL LEVEL]

Switch the setting when the external equipment is connected to the <HDMI 1 IN> terminal / <HDMI 2 IN> terminal of the projector and the image is not projected correctly.

- 1) Press ▲▼ to select [HDMI SIGNAL LEVEL].
- 2) Press ◀▶ to switch the item.
 - The items will switch each time you press the button.

[AUTO]	Sets the signal level automatically.
[64-940]	Select when the HDMI terminal of an external device (such as a blu-ray player) is connected to the <HDMI 1 IN> terminal / <HDMI 2 IN> terminal.
[0-1023]	Select when the DVI terminal output of an external device (such as a computer) is connected to the <HDMI 1 IN> terminal / <HDMI 2 IN> terminal via a conversion cable or similar cable. Select also when the HDMI terminal output of a computer or other device is connected to the <HDMI 1 IN> terminal / <HDMI 2 IN> terminal.

Note

- The optimal setting varies depending on the output setting of the connected external device. Refer to the operation instruction of the external device regarding the output of the external device.
- The displayed signal level is assumed when the input is 30 bits.

[CLOSED CAPTION SETTING] (Only for NTSC input)

Set the closed caption.

Selecting the closed caption display

- 1) Press ▲▼ to select [CLOSED CAPTION SETTING].
- 2) Press the <ENTER> button.
 - The [CLOSED CAPTION SETTING] screen is displayed.
- 3) Press ▲▼ to select [CLOSED CAPTION].
- 4) Press ◀▶ to switch the item.
 - The items will switch each time you press the button.

[OFF]	Closed captions are not displayed.
[ON]	Closed captions are displayed.

- When [ON] is selected, proceed to Step 5).
- 5) When the confirmation screen is displayed, select [OK], and press the <ENTER> button.

Setting the closed caption mode

- 1) Press ▲▼ to select [CLOSED CAPTION SETTING].
- 2) Press the <ENTER> button.
 - The [CLOSED CAPTION SETTING] screen is displayed.
- 3) Press ▲▼ to select [MODE].
- 4) Press ◀▶ to switch the item.
 - The items will switch each time you press the button.

[CC1]	Displays CC1 data.
[CC2]	Displays CC2 data.
[CC3]	Displays CC3 data.
[CC4]	Displays CC4 data.

Note

- Closed caption is a function that displays text information of video signals mainly used in North America. Captions may not be displayed depending on the connected devices or contents being played back.
- [CLOSED CAPTION SETTING] can only be selected if an NTSC signal is input.
- If [CLOSED CAPTION SETTING] is set to [ON], the brightness of image may be changed according to the external devices or the used content of the closed caption corresponding connection.
- If a closed caption signal of the selected mode is input, the security message is not displayed even when the [SECURITY] menu → [TEXT DISPLAY] is set to [ON].
- Closed captions are not displayed when the menu screen is displayed.

[SCREEN SETTING]

Set the screen size.

When changing the aspect of a projected image, correct to the optimum image position for the set screen. Set as necessary for the screen in use.

- 1) Press ▲▼ to select [SCREEN SETTING].
- 2) Press the <ENTER> button.
 - The [SCREEN SETTING] screen is displayed.
- 3) Press ▲▼ to select [SCREEN FORMAT].
- 4) Press ◀▶ to switch the [SCREEN FORMAT] item.
 - The items will switch each time you press the button.

Model No.	[SCREEN FORMAT]	The available items to set when [SCREEN POSITION] is selected
PT-VZ580 PT-VW540	[16:10]	Cannot be set.
	[16:9]	Three items of [CENTER], [UPPER] and [LOWER] can be selected for vertical position.
	[4:3]	Three items of [CENTER], [LEFT] and [RIGHT] can be selected for horizontal position.
PT-VX610	[4:3]	Cannot be set.
	[16:10]	Three items of [CENTER], [UPPER] and [LOWER] can be selected for vertical position.
	[16:9]	Three items of [CENTER], [UPPER] and [LOWER] can be selected for vertical position.

- 5) Press ▲▼ to select [SCREEN POSITION].
 - In the following cases, the [SCREEN POSITION] cannot be set.
 - For PT-VZ580 and PT-VW540, if [SCREEN FORMAT] is set to [16:10].
 - For PT-VX610, if [SCREEN FORMAT] is set to [4:3].
- 6) Press ◀▶ to set the screen position.

[STARTUP LOGO]

Set the logo display when the power is turned on.

- 1) Press ▲▼ to select [STARTUP LOGO].
- 2) Press ◀▶ to switch the item.
 - The items will switch each time you press the button.

[DEFAULT LOGO]	Displays the Panasonic logo.
[USER LOGO]	Displays the image registered by the user.
[OFF]	Disables the startup logo display.

Note

- The startup logo will disappear in approximately 30 seconds.
- To create/register the [USER LOGO] image, use “Logo Transfer Software” included in the supplied CD-ROM.

[AUTO SETUP SETTING]

Set the automatic execution of AUTO SETUP.

Dot clock, clock phase and image position can be adjusted automatically without pressing the <AUTO SETUP> button each time when unregistered signals are input frequently at meetings, etc.

- 1) Press ▲▼ to select [AUTO SETUP SETTING].
- 2) Press ◀▶ to switch the item.
 - The items will switch each time you press the button.

[AUTO]	If the image being projected changes to an unregistered signal, the auto setup is automatically performed.
[BUTTON]	Enables the auto setup function only when the <AUTO SETUP> button is pressed.

[SIGNAL SEARCH]

Set to enable/disable the signal search function.

If the signal search function is enabled, the input with input signal is automatically selected when the power is turned on and the projection is started. In addition, if the <AUTO SETUP> button is pressed when the currently selected input has no signal, it automatically switches to the input with input signal.

- 1) Press ▲▼ to select [SIGNAL SEARCH].
- 2) Press ◀▶ to switch the item.
 - The items will switch each time you press the button.

[ON]	Enables the input detection function.
[OFF]	Disables the input detection function.

[BACK COLOR]

Set the display of the projected screen when there is no signal input.

- 1) Press ▲▼ to select [BACK COLOR].
- 2) Press ◀▶ to switch the item.
 - The items will switch each time you press the button.

[BLUE]	Displays the entire projection area in blue.
[BLACK]	Displays the entire projection area in black.
[DEFAULT LOGO]	Displays the Panasonic logo.
[USER LOGO]	Displays the image registered by the user.

Note

- To create/register the [USER LOGO] image, use “Logo Transfer Software” included in the supplied CD-ROM.

[P-TIMER]

Set and operate the presentation timer function.

Setting the mode

- 1) Press ▲▼ to select [P-TIMER].
- 2) Press the <ENTER> button.
 - The [P-TIMER] screen is displayed.
- 3) Press ▲▼ to select [MODE].
- 4) Press ◀▶ to switch the item.
 - The items will switch each time you press the button.

[COUNT UP]	Displays the elapsed time since the count was started.
[COUNT DOWN]	Displays the remaining time of the time set by [TIMER].

Setting the countdown timer

- 1) Press ▲▼ to select [P-TIMER].
- 2) Press the <ENTER> button.
 - The [P-TIMER] screen is displayed.
- 3) Press ▲▼ to select [TIMER].
- 4) Press ◀▶ to set the time.
 - The time can be set in 1-minute increments from 1 to 180 minutes.
 - The factory default value is 10 minutes.

Note

- [TIMER] can be set when [MODE] is set to [COUNT DOWN].

Using the presentation timer

- 1) Press ▲▼ to select [P-TIMER].
- 2) Press the <ENTER> button.
 - The [P-TIMER] screen is displayed.
- 3) Press ▲▼ to select the item, and press the <ENTER> button.

[START]	The count is started.
[STOP]	The count is stopped.
[RESTART]	The count is resumed.
[RESET]	The count is reset.
[EXIT]	The presentation timer function is ended.

- When [START] or [RESTART] is selected, the elapsed time or the remaining time is displayed at the lower right of the projected image.
- When [STOP] is selected, the elapsed time or the remaining time when the count was stopped is displayed at the lower right of the projected image.

Note

- Presentation timer operations are also possible by the <P-TIMER> button on the remote control. (➔ page 51)
- The security message set in the [SECURITY] menu → [TEXT DISPLAY] (➔ page 87) is not displayed when the elapsed time or remaining time is displayed.
- The elapsed time or remaining time is not displayed when the menu screen is displayed.
- The start time becomes "000:00" when [MODE] is set to [COUNT UP].
- The start time becomes the value set at [TIMER] when [MODE] is set to [COUNT DOWN].
- The time gauge turns clockwise when [COUNT UP] is set, and turns counterclockwise when [COUNT DOWN] is set.

[OTHER FUNCTIONS]

The same function can be realized by operating the menu as an alternative of operating the remote control button.

Using the freeze function

The projected image is paused temporarily and the sound is stopped regardless of the playback of the external equipment.

- 1) Press ▲▼ to select [OTHER FUNCTIONS].
- 2) Press the <ENTER> button.
 - The [OTHER FUNCTIONS] screen is displayed.
- 3) Press ▲▼ to select [FREEZE].
- 4) Press the <ENTER> button.
 - The image is paused and the sound is turned off.

Note

- Press the <FREEZE> button again in freeze status, the paused image is played and the sound is output.
- [FREEZE] is displayed at the lower left of the projection screen in freeze status.

Using the AV mute function

Turn off the audio and video output when the projector is not used for a certain period of time, such as during the meeting breaks or preparations.

- 1) Press ▲▼ to select [OTHER FUNCTIONS].
- 2) Press the <ENTER> button.
 - The [OTHER FUNCTIONS] screen is displayed.
- 3) Press ▲▼ to select [AV MUTE].
- 4) Press the <ENTER> button.
 - The image and the sound are turned off.

Note

- When the power <⏻/|> button is pressed during AV mute, the AV mute is canceled, and the image and sound is output.

Using the digital zoom function

(Only for the still image signals.)

This function can enlarge the projected image.

- 1) Press ▲▼ to select [OTHER FUNCTIONS].
- 2) Press the <ENTER> button.
 - The [OTHER FUNCTIONS] screen is displayed.
- 3) Press ▲▼ to select [DIGITAL ZOOM].
- 4) Press the <ENTER> button.
 - The image with the center part magnified 1.5 times is displayed, and the [DIGITAL ZOOM] individual adjustment screen is displayed.
- 5) Press ◀▶ to adjust the magnification.
 - The magnification can be adjusted from 1.0 to 3.0 times with increments of 0.1.
- 6) Press the <ENTER> button.
 - The operation guide is displayed at the lower left of the screen.
- 7) Press ▲▼◀▶ to move the enlarged part.
 - The image cannot be moved if the magnification is 1.0.

Note

- Press <MENU> button in digital zoom status, the digital zoom function is canceled.
- The digital zoom function is disabled when the freeze function is in use.
- Depending on the input signal, the digital zoom may not work.

[PROJECTOR SETUP] menu

On the menu screen, select [PROJECTOR SETUP] from the main menu, and select an item from the submenu. Refer to “Navigating through the menu” (➔ page 53) for the operation of the menu screen.

[STATUS]

Display the status of the projector.

- 1) Press ▲▼ to select [STATUS].
- 2) Press the <ENTER> button.
 - The [STATUS] screen is displayed.

[SIGNAL]	[NAME]	Displays the name of input signal.	
	[FREQUENCY]	Displays the scanning frequency of input signal.	
[RUNTIME]*1	[PROJECTOR]	Displays the actual usage time of projector.	
	[LAMP (ET-LAV400)]	[ECO1]	Displays the luminous lamp runtime in actual time when [LAMP POWER] is set to [ECO1].
		[ECO2]	Displays the luminous lamp runtime in actual time when [LAMP POWER] is set to [ECO2].
		[NORMAL]	Displays the luminous lamp runtime in actual time when [LAMP POWER] is set to [NORMAL].
[SERIAL NUMBER]	[PROJECTOR]	Displays the serial number of the projector.	
[VERSION]	[MAIN]	Displays the main version of the firmware of the projector.	
	[SUB]	Displays the sub version of the firmware of the projector.	

*1 The following conversion is required to calculate the rough estimate for lamp unit replacement.

Formula for lamp unit replacement time (rough estimate)
$A \times 1 + B \times 5/6 + C \times 5/7$ <ul style="list-style-type: none"> • A : The luminous lamp runtime when [LAMP POWER] is set to [NORMAL] • B : The luminous lamp runtime when [LAMP POWER] is set to [ECO1] • C : The luminous lamp runtime when [LAMP POWER] is set to [ECO2]

Note

- For the network status, refer to the [NETWORK] menu → [NETWORK STATUS]. (➔ page 90)
- The model number of the optional replacement lamp unit is subject to change without prior notice.

[COMPUTER2 SELECT]

Switch the input/output of the <COMPUTER 2 IN/1 OUT> terminal.

- 1) Press ▲▼ to select [COMPUTER2 SELECT].
- 2) Press ◀▶ to switch the item.
 - The items will switch each time you press the button.

[COMPUTER2 IN]	Select when <COMPUTER 2 IN/1 OUT> terminal is used as COMPUTER 2 input.
[COMPUTER1 OUT]	Select when the signal input from the <COMPUTER 1 IN> terminal is output from the <COMPUTER 2 IN / 1 OUT> terminal.

Note

- When COMPUTER2 input is selected, [COMPUTER2 SELECT] cannot be set.
- You cannot switch to COMPUTER 2 input when [COMPUTER2 SELECT] is set to [COMPUTER1 OUT].
- When set to [COMPUTER1 OUT], the signal input to the <COMPUTER 1 IN> terminal is output from the <COMPUTER 2 IN / 1 OUT> terminal regardless of the selected input.

[PROJECTOR ID]

The projector has an ID number setting function that can be used when multiple projectors are used side by side to enable simultaneous control or individual control via a single remote control.

- 1) Press ▲▼ to select [PROJECTOR ID].
- 2) Press the <ENTER> button.
 - The [PROJECTOR ID] screen is displayed.

3) Press ▲▼ to select a projector ID.

- To select one item among [ALL] and [1] ~ [6].

[ALL]	Select when controlling projectors without specifying an ID number.
[1] ~ [6]	Select when specifying an ID number to control individual projector.

4) Press the <ENTER> button.

- [PROJECTOR ID] is set.

Note

- To specify an ID number for individual control, the ID number of a remote control must match the ID number of the projector.
- When the ID number is set to [ALL], the projector will operate regardless of the ID number specified during remote control or computer control.
If multiple projectors are set up side by side with ID set to [ALL], you cannot control a projector separately by specifying a different ID number.
- Refer to “Setting the ID number on the remote control” (➔ page 51) for how to set the ID number on the remote control.

[INITIAL START UP]

Set the startup method when the projector is switched on after connecting the power plug to outlet .

1) Press ▲▼ to select [INITIAL START UP].

2) Press ◀▶ to switch the item.

- The items will switch each time you press the button.

[LAST MEMORY]	Starts up in the status that before removing the power plug from the outlet or turning off the circuit breaker.
[STANDBY]	Starts up in the standby mode.
[ON]	Starts the projection immediately.

[PROJECTION METHOD]

Set the projection method in accordance with the installation status of the projector.

Change the projection method if the screen display is upside down or inverted.

1) Press ▲▼ to select [PROJECTION METHOD].

2) Press ◀▶ to switch the projection method.

- The items will switch each time you press the button.

[AUTO]	Detects the projector’s posture with built-in angle sensor, then switches to [FRONT/DESK] or [FRONT/CEILING]. Usually it is set to [AUTO] when projecting in front of the screen..
[FRONT/DESK]	When installing the projector on the desk, etc., in front of the screen.
[FRONT/CEILING]	When installing the projector in front of the screen with the Ceiling Mount Bracket (optional).
[REAR/DESK]	When installing the projector on the desk, etc., behind the screen (with a translucent screen).
[REAR/CEILING]	When installing the projector behind the screen (with a translucent screen) with the Ceiling Mount Bracket (optional).

Note

- Refer to “Angle sensor” (➔ page 29) for details on the range of the installation attitude that can be detected by the built-in angle sensor.

[LAMP POWER]

Switch the luminance of the luminous lamp according to the operating environment of the projector or the purpose.

1) Press ▲▼ to select [LAMP POWER].

2) Press ◀▶ to switch the item.

- The items will switch each time you press the button.

[NORMAL]	Select when high luminance is required.
[ECO1]	Select when multiple projectors are used side by side. By using in combination with the adjustment in the [DISPLAY OPTION] menu → [COLOR ADJUSTMENT] or [COLOR CORRECTION], it is possible to suppress image appearance variations between projectors.
[ECO2]	Select when high luminance is not required.

Note

- The projector can consume less power, extend the luminous lamp life longer and produce less operation noise when set from [NORMAL] to [ECO1] or from [ECO1] to [ECO2].
- [LAMP POWER] cannot be set when the test pattern is displayed.

[ECO MANAGEMENT]

This function optimizes the luminous lamp power according to the operating status and reduces power consumption.

Setting [AUTO POWER SAVE]

Set whether or not to enable the three functions, [AMBIENT LIGHT DETECTION], [SIGNAL DETECTION] and [AV MUTE DETECTION].

- 1) Press ▲▼ to select [ECO MANAGEMENT].
- 2) Press the <ENTER> button.
 - The [ECO MANAGEMENT] screen is displayed.
- 3) Press ▲▼ to select the [AUTO POWER SAVE].
- 4) Press ◀▶ to switch the [AUTO POWER SAVE].

[ON]	Enables the energy conservation setting.
[OFF]	Disables the energy conservation setting.

- 5) Press ▲▼ to select one item.

[AMBIENT LIGHT DETECTION]	Adjusts the power of the luminous lamp according to the brightness of the installation location.
[SIGNAL DETECTION]	Lowers the power of the luminous lamp when there is no signal.
[AV MUTE DETECTION]	Lowers the power of the luminous lamp in AV mute.

- 6) Press ◀▶ to switch the item.
 - The items will switch each time you press the button.

[ON]	Enables above setting.
[OFF]	Disables above setting.

Note

- The lamp power cannot decrease automatically in the following cases:
 - When the luminous lamp is just turned on or [LAMP POWER] is just set
- When [AUTO POWER SAVE] is set to [OFF], settings of [AMBIENT LIGHT DETECTION], [SIGNAL DETECTION], [AV MUTE DETECTION] are unavailable.
- When objects, etc. are placed on top of the projector, the luminance sensor may be blocked, therefore the brightness cannot be detected correctly. The projector may not work properly even [AMBIENT LIGHT DETECTION] is set to [ON].

Setting [POWER MANAGEMENT]

Set the operation of the power management function when there is no signal input for a certain period of time.

- 1) Press ▲▼ to select [ECO MANAGEMENT].
- 2) Press the <ENTER> button.
 - The [ECO MANAGEMENT] screen is displayed.
- 3) Press ▲▼ to select [POWER MANAGEMENT].
- 4) Press ◀▶ to switch the item.
 - The items will switch each time you press the button.

[SHUT DOWN]	The countdown timer is displayed after 30 seconds without input signal. The luminous lamp turns off and cools down when the time set in [TIMER] has elapsed, then the projector enters into standby status.
[OFF]	Power management function is off.
[READY]	The countdown timer is displayed after 30 seconds without input signal. The luminous lamp will turn off and enter into standby status after cooling down when the time set in [TIMER] has elapsed. The luminous lamp will be turned on and enter into projection state if any signal is input or any button is pressed during standby mode.

- 5) Press ▲▼ to select [TIMER].
- 6) Press ◀▶ to switch the time to be set.
 - The set time is switched each time you press the button.
 - You can set the time until the luminous lamp turns off with the power management function from 5 minutes to 120 minutes in increments of 5 minutes.

Setting [STANDBY MODE]

Set the power consumption during standby.

- 1) Press ▲▼ to select [ECO MANAGEMENT].
- 2) Press the <ENTER> button.
 - The [ECO MANAGEMENT] screen is displayed.
- 3) Press ▲▼ to select [STANDBY MODE].
- 4) Press ◀▶ to switch the item.
 - The items will switch each time you press the button.

[NORMAL]	Select this item to use the network function during standby.
[ECO]	Select this item to reduce power consumption during standby.

Note

- When [STANDBY MODE] is set to [NORMAL], the network function can be used during standby.
- When [STANDBY MODE] is set to [ECO], the network function and audio output function cannot be used during standby. Also, some RS-232C commands cannot be used.
- When set to [ECO], it may take approx. 10 seconds longer before the projector starts projecting after the power is turned on, compared with when set to [NORMAL].
- When set to [NORMAL], it may take approx. 1 minute to enable the network function after connecting the power cord.
- The setting of [STANDBY MODE] cannot be returned to the factory default even if the [PROJECTOR SETUP] menu → [INITIALIZE ALL] (➔ page 85) is executed.

[EMULATE]

When controlling the projector on a computer via the <SERIAL IN> terminal, set use of control commands on a previously purchased Panasonic projector. This allows the control software for an existing Panasonic projector to be inherited and used.

- 1) Press ▲▼ to select [EMULATE].
- 2) Press the <ENTER> button.
 - The [EMULATE] screen is displayed.
- 3) Press ▲▼ to select the desired item.

[DEFAULT]	VZ585N series, VW545N series, VX615N series, VZ580 series, VW540 series, VX610 series, VZ575N series, VW535N series, VX605N series, VZ570 series, VW530 series, VX600 series, VX60, VX50, EZ590 series, EZ57, EW650 series, EW550 series, EX620 series, EX520 series, FZ570 series, FW530 series, FX500 series, VZ470 series, VW355N series, VX425N series, VW350 series, VX420 series, EZ580 series, EW640 series, EX610 series, EW540 series, EX510 series, VW345N series, VX415N series, VW340Z, VX410Z, VX42Z, VX406EA, VX46EA, EZ770 series, EW730 series, EX800 series, RZ475 series, RZ470 series, RW430 series, RZ370 series, RW330 series
[D3500]	D3500 series
[D4000]	D4000 series
[D/W5k SERIES]	D5700 series, DW5100 series, D5600 series, DW5000 series, D5500 series
[D/WIZ6k SERIES]	DZ870 series, DW830 series, DX100 series, DZ780 series, DW750 series, DX820 series, DZ770 series, DW740 series, DX810 series, DZ680 series, DW640 series, DX610 series, DW730 series, DX800 series, DZ6710 series, DZ6700 series, DW6300 series, D6000 series, D5000 series, DZ570 series, DW530 series, DX500 series, RZ970 series, RW930 series, RX110 series, RZ770 series, RZ660 series, RW730 series, RW620 series, RZ670 series, RW630 series, RZ575 series, RZ570 series
[L730 SERIES]	L730 series, L720 series, L520 series
[L780 SERIES]	L780 series, L750 series
[L735 SERIES]	L735 series
[L785 SERIES]	L785 series
[F/W SERIES]	FW430 series, FX400 series, FW300 series, F300 series, F200 series, FW100 series, F100 series

[LZ370]	LZ370 series
[LB/W SERIES]	LB3 series, LB2 series, LB1 series, ST10 series, LB90 series, LW80NT series, LB80 series, LB78 series, LB75 series
[VX500 SERIES]	VW435N series, VW440 series, VW430 series, VX505N series, VX510 series, VX500 series, VW330 series, VX400NT series, VX400 series, VX41 series
[EZ570 SERIES]	EZ570 series, EW630 series, EW530 series, EX600 series, EX500 series
[VW431D]	VW431D series

4) Press the <ENTER> button.

[FUNCTION BUTTON]

The function assigned to the <FUNCTION> button of the remote control is displayed. You can also release the assigned setting.

Releasing assigned function to the <FUNCTION> button

- 1) Press ▲▼ to select [FUNCTION BUTTON].
- 2) Press the <ENTER> button.
 - The [FUNCTION BUTTON] screen is displayed.
- 3) Press the <ENTER> button.
- 4) When the confirmation screen is displayed, press ◀▶ to select [OK] and press the <ENTER> button.

Note

- You can also cancel the assigned settings by displaying the on-screen menu, selecting the menu item to be canceled (main menu, submenu, or details menu), and then pressing the <FUNCTION> button for at least three seconds.

[AUDIO SETTING]

You can perform detailed audio setting.

Adjusting the volume

- 1) Press ▲▼ to select [AUDIO SETTING].
- 2) Press the <ENTER> button.
 - The [AUDIO SETTING] screen is displayed.
- 3) Press ▲▼ to select [VOLUME].
- 4) Press ◀▶ to adjust the level.

Operation	Adjustment	Range
Press the ▶ button.	Increases the volume.	0 ~ +63
Press the ◀ button.	Decreases the volume.	

Setting the mute status

- 1) Press ▲▼ to select [AUDIO SETTING].
- 2) Press the <ENTER> button.
 - The [AUDIO SETTING] screen is displayed.
- 3) Press ▲▼ to select [MUTE].
- 4) Press ◀▶ to switch the item.

[OFF]	Audio is output.
[ON]	Audio is muted.

Setting the audio output during standby

- 1) Press ▲▼ to select [AUDIO SETTING].
- 2) Press the <ENTER> button.
 - The [AUDIO SETTING] screen is displayed.
- 3) Press ▲▼ to select [IN STANDBY MODE].
- 4) Press ◀▶ to switch the item.
 - The items will switch each time you press the button.

[OFF]	Disables audio output in the standby mode.
[ON]	Enables audio output in the standby mode.

Note

- When the [PROJECTOR SETUP] menu → [ECO MANAGEMENT] → [STANDBY MODE] is set to [ECO], audio cannot be output during standby.
- When [IN STANDBY MODE] is set to [ON], you can adjust the volume with the <VOL-> button / <VOL+> button on the remote control or the ◀▶ buttons on the control panel during standby.

Setting the audio input from the connected device

Choose the audio input terminal for each input signal.

- 1) Press ▲▼ to select [AUDIO SETTING].
- 2) Press the <ENTER> button.
 - The [AUDIO SETTING] screen is displayed.
- 3) Press ▲▼ to select the items of [AUDIO IN SELECT] to set.

[COMPUTER1]	Set the audio output for COMPUTER1 input.
[COMPUTER2]	Set the audio output for COMPUTER2 input.
[VIDEO]	Set the audio output for VIDEO input.
[HDMI1]	Set the audio output for HDMI1 input.
[HDMI2]	Set the audio output for HDMI2 input.

- 4) Press ◀▶ to switch the item.
 - The sub items will switch each time you press the button.

[AUDIO IN 1]	Audio connected to the <AUDIO IN 1> terminal is output during projection of image from the set input terminal.
[AUDIO IN 2]	Audio connected to the <AUDIO IN 2> terminal is output during projection of image from the set input terminal.
[AUDIO IN 3]	Audio connected to the <AUDIO IN 3> terminal is output during projection of image from the set input terminal.
[HDMI1 AUDIO IN] ^{*1}	Audio input to HDMI1 is output.
[HDMI2 AUDIO IN] ^{*2}	Audio input to HDMI2 is output.

*1 Only for HDMI1 input.

*2 Only for HDMI2 input.

[TEST PATTERN]

Displays the test pattern built-in to the projector.

The settings such as [CONTRAST] or [BRIGHTNESS] that can be set from the [PICTURE] menu will not be reflected in the test pattern. Make sure to perform various adjustments with input signals displayed.

- 1) Press ▲▼ to select [TEST PATTERN].
- 2) Press the <ENTER> button.
 - The ALL WHITE test pattern is displayed.
- 3) Press ◀▶ to switch the test pattern.
 - The test pattern will switch each time you press the button.

All white	The test pattern is displayed together with the operation guide of [PATTERN SELECT]. Select your desired test pattern.
Color bar (Vertical)	
Color bar (Horizontal)	
Cross	
Cross (Inversion)	
Cross hatch	

Note

- Some adjustment menus such as the [POSITION] menu → [SCREEN ADJUSTMENT] and the [DISPLAY OPTION] menu → [COLOR ADJUSTMENT] can be set even when the test pattern is displayed.
- The setting of the [LAMP POWER] is disabled when the test pattern is displayed.
- If [TEST PATTERN] is assigned to the <FUNCTION> button on the remote control, the cross hatch pattern will be displayed after pressing the <FUNCTION> button.

[FILTER COUNTER]

This function is used to check the usage time of the air filter or set the cleaning/replacement cycle of the air filter. Also, you can reset the air filter usage time.

1) Press ▲▼ to select [FILTER COUNTER].

2) Press the <ENTER> button.

- The [FILTER COUNTER] screen is displayed.

[FILTER COUNTER]	Displays the usage time of the air filter.
[TIMER]	Sets the cleaning/replacement cycle of the air filter.
[FILTER COUNTER RESET]	Resets the air filter usage time.

Setting [TIMER]

If you want to regularly clean/replace the air filter, set its cycle time. When the air filter usage time reaches the set time, a message of “FILTER COUNTER has reached the set time” prompting you to clean/replace the air filter is displayed on the projection screen.

1) Press ▲▼ to select [FILTER COUNTER].

2) Press the <ENTER> button.

- The [FILTER COUNTER] screen is displayed.

3) Press ▲▼ to select [TIMER].

4) Press ◀▶ to switch the item.

- The items will switch each time you press the button.

[OFF]	Select not to display the message.
[1000H] - [7000H]	Select to display the message. You can set the cleaning/replacement cycle of the air filter in increments of 1000 hours.

Setting [FILTER COUNTER RESET]

Resets the usage time of the air filter.

1) Press ▲▼ to select [FILTER COUNTER].

2) Press the <ENTER> button.

- The [FILTER COUNTER] screen is displayed.

3) Press ▲▼ to select [FILTER COUNTER RESET].

4) Press the <ENTER> button.

5) When the confirmation screen is displayed, press ◀▶ to select [OK] and then press the <ENTER> button.

- The display of [FILTER COUNTER] changes to “0H”.

[DC OUT]

This function can be used to supply power by the <DC OUT> terminal.

- 1) Press ▲▼ to select [DC OUT].
- 2) Press ◀▶ to switch the item.
 - The items will switch each time you press the button.

[ON]	Power is supplied to an external device connected to the <DC OUT> terminal.
[OFF]	Power is not supplied to an external device connected to the <DC OUT> terminal.

Note

- Power supply is ceased in standby mode even when [DC OUT] is set to [ON].
- If [DC OUT] is set to [ON] and a device which exceeds the rated power (DC 5 V, maximum 2 A) is connected to the projector, the projector detects an error and ceases the power supply to the device. In such case, [ERROR] is displayed on the [DC OUT] screen. When [ERROR] appears, remove the device and then switch off and on the power of the projector.

[INITIALIZE ALL]

Return various setting values to their factory default settings.

- 1) Press ▲▼ to select [INITIALIZE ALL].
- 2) Press the <ENTER> button.
- 3) When the [INITIALIZE ALL] screen is displayed, press ◀▶ to select [OK] and then press the <ENTER> button.
- 4) When the power off confirmation screen is displayed after a while, press the <ENTER> button.
 - The operations except for powering off are disabled.

Note

- When the [SECURITY] menu → [PASSWORD] is set to [ON], the [PASSWORD] screen will be displayed after selecting [INITIALIZE ALL] and pressing the <ENTER> button. Enter the security password set for the projector and continue your desired operation.
- The projector will enter the standby status to reflect the setting values when [INITIALIZE ALL] is executed.
- Even if [INITIALIZE ALL] is performed, the settings of the following items cannot be initialized.
 - [STANDBY MODE]
 - [EMULATE]
 - [FILTER COUNTER]
 - [NETWORK]
- To initialize the settings of [NETWORK], perform the [NETWORK] menu → [INITIALIZE].
- When [INITIALIZE ALL] is executed, the [INITIAL SETTING] screen is displayed when the projection starts next time.

[SECURITY] menu

On the menu screen, select [SECURITY] from the main menu, and select an item from the submenu. Refer to “Navigating through the menu” (➔ page 53) for the operation of the menu screen.

- When the projector is used for the first time
Initial password: Press ▲▶▼◀▲▶▼◀ in order, and press the <ENTER> button.

Attention

- When you select the [SECURITY] menu and press the <ENTER> button, entering a password is required. Enter the preset password and then continue operations of the [SECURITY] menu.
- When the password has been changed previously, enter the changed password, and press the <ENTER> button.

Note

- The entered password is displayed with "*" mark on the screen.
- An error message is displayed on the screen when the entered password is incorrect. Re-enter the correct password.

[PASSWORD]

Sets the security password entry.

If the security password entry is enabled, the [PASSWORD] screen will be displayed and the security password is required for the following cases.

- Connect the power plug to the outlet and turn the power on.
- Execute the [PROJECTOR SETUP] menu → [INITIALIZE ALL].
- Execute the [NETWORK] menu → [INITIALIZE].

1) Press ▲▼ to select [PASSWORD].

2) Press ◀▶ to switch the item.

- The items will switch each time you press the button.

[OFF]	Disables the security password entry.
[ON]	Enables the security password entry.

Note

- The factory default setting or the setting after executing the [PROJECTOR SETUP] menu → [INITIALIZE ALL] is set to [OFF]. Set it to [ON] if necessary.
- The security password input when turning on the power is not enabled until turning off the power supply and plugging the power plug into the outlet after setting it to [ON]. If the entered password is incorrect when the power is turned on, the operation will be restricted to the power <⏻/> button.

[PASSWORD CHANGE]

Change the security password.

1) Press ▲▼ to select [PASSWORD CHANGE].

2) Press the <ENTER> button.

- The [PASSWORD CHANGE] screen is displayed.

3) Press ▲▼◀▶ or number buttons (<1>-<6>) to set the password.

- Up to eight button operations can be set.

4) Press the <ENTER> button.

5) Re-enter the password for the confirmation.

6) Press the <ENTER> button.

Note

- The entered password is displayed with "*" mark on the screen.
- Change the password periodically and make it hard to guess.
- If numbers have been used for the security password, the security password will need to be initialized again if the remote control is lost. Consult your dealer for the initialization method.

[TEXT DISPLAY]

Overlap the security message (text) over the projecting image.

- 1) Press ▲▼ to select [TEXT DISPLAY].
- 2) Press ◀▶ to switch the item.
 - The items will switch each time you press the button.

[OFF]	The security message will not be displayed.
[ON]	Displays the text set at the [SECURITY] menu → [TEXT CHANGE].

[TEXT CHANGE]

Register or change the displayed text when [TEXT DISPLAY] is set to [ON].

- 1) Press ▲▼ to select [TEXT CHANGE].
- 2) Press the <ENTER> button.
 - The [TEXT CHANGE] screen is displayed.
- 3) Press ▲▼◀▶ to select the text, and press the <ENTER> button to enter the text.
- 4) Press ▲▼◀▶ to select [OK], and press the <ENTER> button.
 - The text is changed.

[MENU LOCK]

Display the menu by the <MENU> button and set whether or not to enable menu operations.

- 1) Press ▲▼ to select [MENU LOCK].
- 2) Press ◀▶ to switch the item.
 - The items will switch each time you press the button.

[OFF]	Enables menu operations.
[ON]	Disables menu operations.

Note

- The factory default setting or the setting after executing the [PROJECTOR SETUP] menu → [INITIALIZE ALL] is set to [OFF]. Set it to [ON] if necessary.
- When [MENU LOCK] is set to [ON], the [MENU LOCK PASSWORD] screen is displayed after pressing the <MENU> button. After entering the set menu lock password, the menu operation is enabled. In this case, the menu operation will remain enabled until the projector enters into standby mode.

[MENU LOCK PASSWORD]

Change the menu lock password.

- 1) Press ▲▼ to select [MENU LOCK PASSWORD].
- 2) Press the <ENTER> button.
 - The [MENU LOCK PASSWORD] screen is displayed.
- 3) Press ▲▼◀▶ to select the text, and press the <ENTER> button to enter the text.
 - Up to 16 characters can be input.
- 4) Press ▲▼◀▶ to select [OK], and press the <ENTER> button.
 - To cancel, select [CANCEL].

Attention

- The initial password is "AAAA" for the factory default setting or after executing the [PROJECTOR SETUP] menu → [INITIALIZE ALL].
- Change the password periodically and make it hard to guess.

[CONTROL DEVICE SETUP]

Enable/disable the button operations on the control panel and the remote control.

- 1) Press ▲▼ to select [CONTROL DEVICE SETUP].
- 2) Press the <ENTER> button.
 - The [CONTROL DEVICE SETUP] screen is displayed.
- 3) Press ▲▼ to select one item between [CONTROL PANEL] and [REMOTE CONTROLLER].

[CONTROL PANEL]	You can limit the control method to the control panel.
[REMOTE CONTROLLER]	You can limit the control method to the remote control.

- 4) Press ◀▶ to switch between [ENABLE] and [DISABLE].
 - You can limit the control method to the control panel or the remote control.

[ENABLE]	Enable the operation of all buttons.
[DISABLE]	Disable the operation of all buttons.

- When you change [ENABLE] to [DISABLE], proceed to Step 5).
- 5) When the confirmation screen is displayed, press ◀▶ to select [OK], and then press the <ENTER> button.

Note

- When a button operation is performed on the device set to [DISABLE] , the [PASSWORD] screen is displayed. To continue operations, enter the security password.
- The [PASSWORD] screen will disappear when there is no operation for approx. 10 seconds.
- If the operations of both [CONTROL PANEL] and [REMOTE CONTROLLER] are set to [DISABLE], the projector cannot be turned off (cannot enter standby).
- Even when you set button operations on the remote control to be disabled, operations of the <ID ALL> and <ID SET> buttons on the remote control are enabled.

[NETWORK] menu

On the menu screen, select [NETWORK] from the main menu, and select an item from the submenu. Refer to “Navigating through the menu” (➔ page 53) for the operation of the menu screen.

[WIRED LAN]

Perform the connection settings to use wired LAN.

- 1) Press ▲▼ to select [WIRED LAN].
- 2) Press the <ENTER> button.
 - The [WIRED DETAILED SETUP] screen is displayed.
- 3) Press ▲▼◀▶ to select an item, and change the setting according to the menu operation instructions.

[DHCP]	[ON]	Set when a DHCP server exists in the network to which the projector is connected and the IP address is obtained automatically.
	[OFF]	Set when a DHCP server does not exist in the network to which the projector is connected and you need to specify the IP address.
[IP ADDRESS]	Enter the IP address when [DHCP] is set to [OFF].	
[SUBNET MASK]	Enter the subnet mask when [DHCP] is set to [OFF].	
[DEFAULT GATEWAY]	Enter the default gateway address when [DHCP] is set to [OFF].	
[DNS1]	Enter the preferred DNS server address when [DHCP] is set to [OFF].	
[DNS2]	Enter the alternate DNS server address when [DHCP] is set to [OFF].	

- 4) After the setting, select [OK] and press the <ENTER> button.

Note

- For the setting content of each item, consult your network administrator.
- When using the projector with [DHCP] set to [ON], confirm that the DHCP server is running.

■ Factory default settings

- Following setting has been made as a factory default.

[DHCP]	[OFF]
[IP ADDRESS]	192.168.10.100
[SUBNET MASK]	255.255.255.0
[DEFAULT GATEWAY]	192.168.10.1
[DNS1] / [DNS2]	(Blank)

[PROJECTOR NAME]

You can change the projector name. Enter the host name if it is required to use a DHCP server.

- 1) Press ▲▼ to select [PROJECTOR NAME].
- 2) Press the <ENTER> button.
 - The [PROJECTOR NAME CHANGE] screen is displayed.
- 3) Select characters with the ▲▼◀▶ buttons and press the <ENTER> button to enter the projector name.
 - You can enter up to eight characters.
- 4) After entering the projector name, press ▲▼ to select [OK] and press the <ENTER> button.

[NETWORK CONTROL]

Set up the control method of the network.

- 1) Press ▲▼ to select [NETWORK CONTROL].
- 2) Press the <ENTER> button.
 - The [NETWORK CONTROL] screen is displayed.
- 3) Press ▲▼ to select an item and press ◀▶ to change the setting.

[WEB CONTROL]	Set to [ON] to control with the web browser.
[PJLink CONTROL]	Set to [ON] to control with the PJLink protocol.
[COMMAND CONTROL]	Set to [ON] to control with the <SERIAL IN> terminal control command format (➔ page 124). Refer to "Control commands via LAN" (➔ page 120).
[COMMAND PORT]	Set the port number used for command control.
[Crestron Connected(TM)]	Set to [ON] to control with Crestron Connected™ of Crestron Electronics, Inc.
[AMX D. D.]	Set to [ON] to control with the controller of AMX Corporation. Setting this function to [ON] enables detection through "AMX Device Discovery". For details, visit the website of AMX Corporation. URL http://www.amx.com/

4) Press ▲▼ to select [OK] and press the <ENTER> button.

[NETWORK STATUS]

Displays the network status.

- 1) Press ▲▼ to select [NETWORK STATUS].
- 2) Press the <ENTER> button.
 - The [NETWORK STATUS] screen is displayed.

[WIRED LAN]	Displays the network information of the wired LAN that set on the projector.	
	[DHCP]	Displays the usage state of the DHCP server.
	[IP ADDRESS]	Displays the IP address.
	[SUBNET MASK]	Displays the subnet mask.
	[DEFAULT GATEWAY]	Displays the default gateway.
	[DNS1]	Displays the address of the preferred DNS server.
	[DNS2]	Displays the address of the alternate DNS server.
[MAC ADDRESS]	Displays the MAC address of wired LAN.	

[INITIALIZE]

This function is used to return various setting values of [NETWORK] to the factory default value.

- 1) Press ▲▼ to select [INITIALIZE].
- 2) Press the <ENTER> button.
- 3) When the [INITIALIZE] screen is displayed, press ◀▶ to select [OK] and then press the <ENTER> button.

Note

- If the [SECURITY] menu → [PASSWORD] is set to [ON], the [PASSWORD] screen will be displayed when [INITIALIZE] is selected and the <ENTER> button is pressed. Continue your operation after entering the security password set for the projector.

Chapter 5 Operation of Function

This chapter describes the operation methods of some functions.

Network connection

This projector has network function that allows the following by connecting a computer.

- **WEB control**

By accessing the projector from a computer, you can perform setting, adjustment, status display, etc. of the projector. Refer to “Web control function” (➔ page 94) for details.

- **Multi Monitoring & Control Software**

“Multi Monitoring & Control Software” is used to monitor and control multiple display devices (projector or flat panel display) connected via LAN.

Refer to the Operating Instructions of the “Multi Monitoring & Control Software” in the supplied CD-ROM for details.

- **Early Warning Software**

“Early Warning Software” is used to monitor the status of the display devices (projector or flat panel display) or the peripheral device within the intranet, and to notify the problem or to detect the sign of possible problem of the device.

Visit the Panasonic website (<https://panasonic.net/cns/projector/pass/>) for details.

- **PJLink**

Operation or status query of the projector can be performed from a computer with the PJLink protocol. Refer to “PJLink protocol” (➔ page 119) for details.

- **Command control**

Operation or status query of the projector can be performed from a computer with the control commands. Refer to “Control commands via LAN” (➔ page 120) for details.

Connecting via wired LAN

Example of a network connection

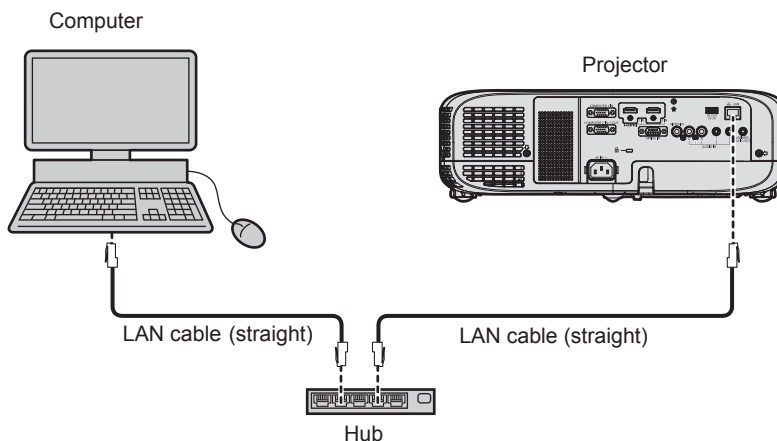

Attention

- When a LAN cable is directly connected to the projector, cabling must be made indoors.

Note

- A LAN cable is required to use the wired LAN function.
- Use a straight or crossover LAN cable that is compatible with CAT5 or higher. Either the straight or the crossover cable, or both cables can be used depending on the system configuration, check with your network administrator. The projector identifies the type of the cable (straight or crossover) automatically.
- Use a LAN cable of 100 m (328'1") or shorter.

Projector settings

- 1) **Connect the projector to a computer using a LAN cable.**
- 2) **Turn on the power of the projector.**
- 3) **Select the [NETWORK] menu → [WIRED LAN] from the main menu and press the <ENTER> button.**

4) Perform the detailed setting of [WIRED LAN].

- For details, Refer to “[WIRED LAN]”. (➡ page 89)

Note

- Consult your network administrator before connecting to an existing network.

■ Factory default setting

- Following setting has been made as a factory default.

[DHCP]	[OFF]
[IP ADDRESS]	192.168.10.100
[SUBNET MASK]	255.255.255.0
[DEFAULT GATEWAY]	192.168.10.1
[DNS1] / [DNS2]	(Blank)

Operating the computer

1) Turn on the power of the computer.

2) Perform the network setting following the instruction of your network administrator.

- If the projector is in factory default setting, you can use it as it is if the network setting of the computer is as follows.

[IP ADDRESS]	192.168.10.101
[SUBNET MASK]	255.255.255.0
[DEFAULT GATEWAY]	192.168.10.1

Web control function

Using Web control functions, you can perform the following operations from a computer.

- Setting and adjustment of the projector
- Displaying projector status
- Sending E-mail messages when there is a problem with the projector

The projector supports “Crestron Connected™”, and the following application software of Crestron Electronics, Inc. can be used.

- RoomView Express
- Fusion RV
- RoomView Server Edition

Note

- Communication with an E-mail server is required to use the E-mail function. Confirm that the E-mail can be used beforehand.
- “Crestron Connected™” is a system of Crestron Electronics, Inc. that collectively manages and controls devices on multiple systems connected to a network using a computer.
- For details of “Crestron Connected™”, refer to the website of Crestron Electronics, Inc. (English only)

URL <http://www.crestron.com>

To download “RoomView Express”, go to the website of Crestron Electronics, Inc. (English only)

URL <http://www.crestron.com/getroomview>

Computer that can be used for setting

A web browser is required to use the web control function. Confirm that your web browser can be used beforehand.

OS	Compatible web browser
Windows	Internet Explorer 11.0
Mac OS	Safari 8.0/9.0/10.0

Note

- You cannot operate the [Crestron Connected (TM)] page when using Microsoft Edge. Clicking the [Crestron Connected (TM)] button will freeze the web browser.

Accessing from the web browser

- 1) Start up the web browser on the computer.
- 2) Enter the IP address set on the projector into the URL entry field of the web browser.
- 3) Enter the user name and the password.
 - The factory default setting of the user name is user1 (user rights)/admin1 (administrator rights) and the password is panasonic (single-byte characters in lower case).

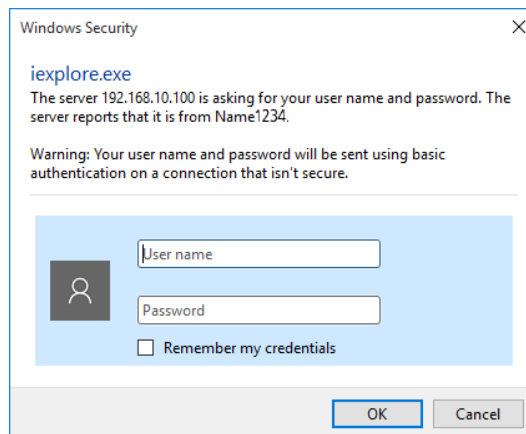

4) Click the [OK] button.

- The [Projector status] page is displayed.



Note

- If you use a web browser to control the projector, set the [NETWORK] menu → [NETWORK CONTROL] → [WEB CONTROL] to [ON].
- Do not start up multiple web browsers at the same time to make setting or control. Also, do not set or control the projector from multiple computers.
- Change the password first. (➡ page 105)
- Access will be locked for few minutes when an incorrect password is entered three times consecutively.
- Some items on the projector setting page use the Javascript function of the web browser. The projector may not be able to be controlled properly if this function is disabled on the browser settings.
- If the screen for the web control is not displayed, consult your network administrator.
- While updating the screen for the web control, the screen may appear white for a moment, but it is not a malfunction.
- Illustrations of computer screens

The actual size or display of the screens in this manual may differ depending on the type of the OS, the web browser or the computer you use.

Available functions per account

The administrator rights allow use of all functions. There is a limitation in the rights that can be used with the user rights. Select the rights depending on the purpose.

The function that has ✓ in the administrator rights/user rights column indicates that it can be operated with that rights.

Item	Function	Administrator rights	User rights	Page
[Status]	[Projector status]	✓	✓	96
	Check error information page	✓	✓	97
	[Network status]	✓	✓	97
[Projector control]	[Basic control]	✓	✓	98
	[Detail control]	✓	✓	98
[Detailed set up]	[Network config]	✓	—	99
	[Ping test]	✓	—	100
	[ECO management set up]	✓	—	100
	[E-mail set up]	✓	—	101
	[Authentication set up]	✓	—	102
	[Command port set up]	✓	—	104
[Change password]	User name for [Administrator]	✓	—	105
	User name for [User]	✓	—	106
	Password for [Administrator]	✓	—	105
	Password for [User]	✓	✓	106
[Crestron Connected(TM)]	Operation page	✓	—	107
	[Tools]	✓	—	107
	[Info]	✓	—	108
	[Help]	✓	—	108

Description of each item



- 1 **Page tab**
Switches pages by clicking this item.
- 2 **[Status]**
The status of the projector is displayed by clicking this item.
- 3 **[Projector control]**
The [Projector control] page is displayed by clicking this item.
- 4 **[Detailed set up]**
The [Detailed set up] page is displayed by clicking this item.
- 5 **[Change password]**
The [Change password] page is displayed by clicking this item.
- 6 **[Crestron Connected(TM)]**
The control page of Crestron Connected™ is displayed by clicking this item.

[Status] page

Click [Status] → [Projector status].

Display the status of the projector for the following items.

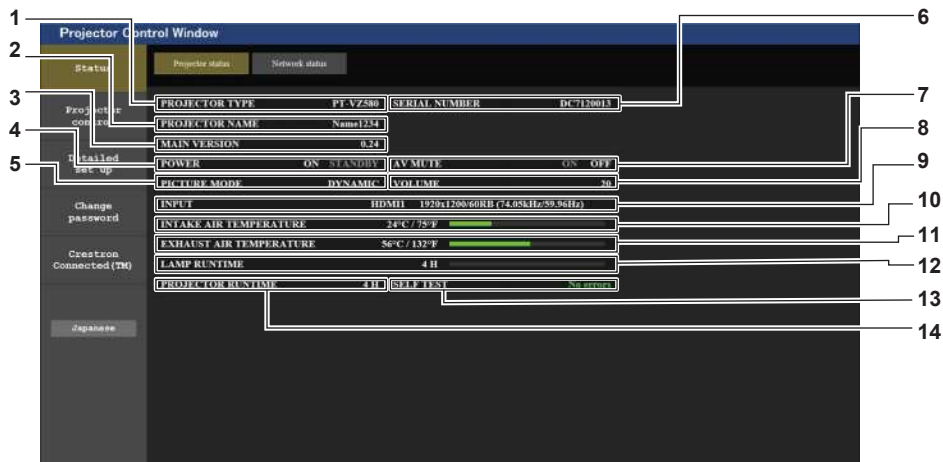

- 1 **[PROJECTOR TYPE]**
Displays the type of the projector.
- 2 **[PROJECTOR NAME]**
Displays the name set in the projector.
- 3 **[MAIN VERSION]**
Displays the firmware version of the projector.
- 4 **[POWER]**
Displays the status of the power.
- 5 **[PICTURE MODE]**
Displays the status of the picture mode.
- 6 **[SERIAL NUMBER]**
Displays the serial number of the projector.
- 7 **[AV MUTE]**
Displays the AV mute status.
([ON]: the AV mute function is enabled;
[OFF]: the AV mute function is disabled).
- 8 **[VOLUME]**
Displays the volume status.
- 9 **[INPUT]**
Displays the status of the selected input.
- 10 **[INTAKE AIR TEMPERATURE]**
Displays the status of the air intake temperature of the projector.
- 11 **[EXHAUST AIR TEMPERATURE]**
Displays the status of the exhaust air temperature of the projector.
- 12 **[LAMP RUNTIME]**
Displays the runtime of the luminous lamp (converted value).
- 13 **[SELF TEST]**
Displays the self-diagnosis information.
- 14 **[PROJECTOR RUNTIME]**
Displays the runtime of the projector.

Error information page

When [Error (Detail)] or [Warning (Detail)] is displayed in the [SELF TEST] display field of the [Projector status] screen, click it to display the content of the error/warning.

- The projector may go into the standby status to protect the projector depending on the contents of the error.

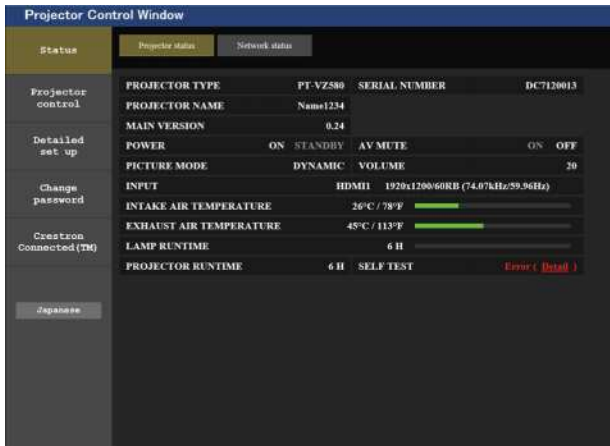

1 Self-diagnosis result display

Displays the item check results.

[OK]:

Indicates that operation is normal.

[FAILED]:

Indicates that there is a problem.

[WARNING]:

Indicates that there is a warning.

■ [FAILED] items displayed when a problem occurs

Parameter	Description
[FAN]	Trouble has occurred in the fan or its drive circuit. Consult your dealer.
[FAN(INTAKE1)]	Trouble has occurred in the intake fan 1.
[FAN(INTAKE2)]	Trouble has occurred in the intake fan 2.
[FAN(INTAKE3)]	Trouble has occurred in the intake fan 3.
[FAN(LAMP)]	Trouble has occurred in the luminous lamp cooling fan.
[FAN(EXHAUST)]	Trouble has occurred in the exhaust fan.
[FAN(POWER)]	Trouble has occurred in the power fan.
[INTAKE AIR TEMPERATURE]	The environment temperature is too high. Use under the proper operating environment temperature*1.
[EXHAUST AIR TEMPERATURE]	The environment temperature is too high or the air exhaust port may be blocked. Use under the proper operating environment temperature*1 and check that the air exhaust port is not blocked.
[DC OUT]	The device which exceeds the rated power (DC 5 V, maximum 2 A) is connected to the projector. Remove the device and then switch off and on the power of the projector.
[LAMP REMAIN TIME]	The luminous lamp runtime has exceeded the prescribed cumulative time, and it is now time to replace the lamp unit.
[LAMP STATUS]	The luminous lamp has failed to light. Wait a short while for the luminous lamp to cool off, and then turn on the power.
[APERTURE (CONTRAST-SHUTTER)]	Trouble has occurred in the contrast shutter circuitry. Consult your dealer.
[AIR FILTER]	There is too much dust accumulated in the air filter unit. Turn off the projector and unplug the power plug from the wall outlet, then maintain the air filter unit.

*1 For the operating environment temperature of the projector, refer to “Operating environment temperature” (➡ page 129).

[Network status] page

Click [Status] → [Network status].

The current network setting status is displayed.

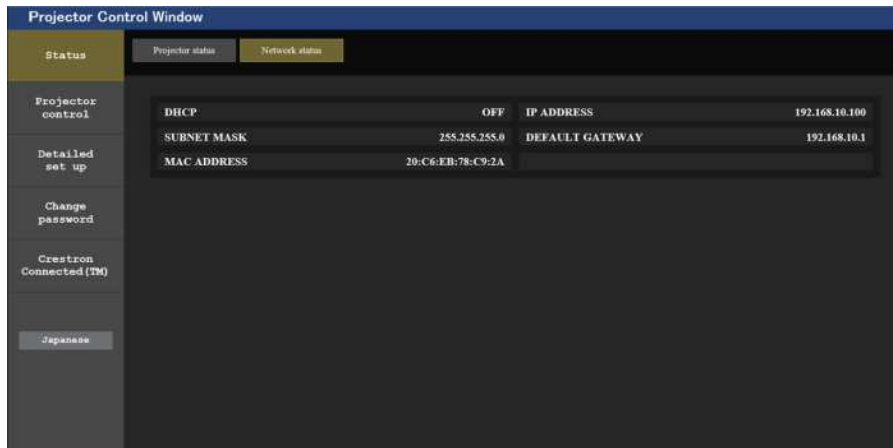

[Basic control] page

Click [Projector control] → [Basic control].

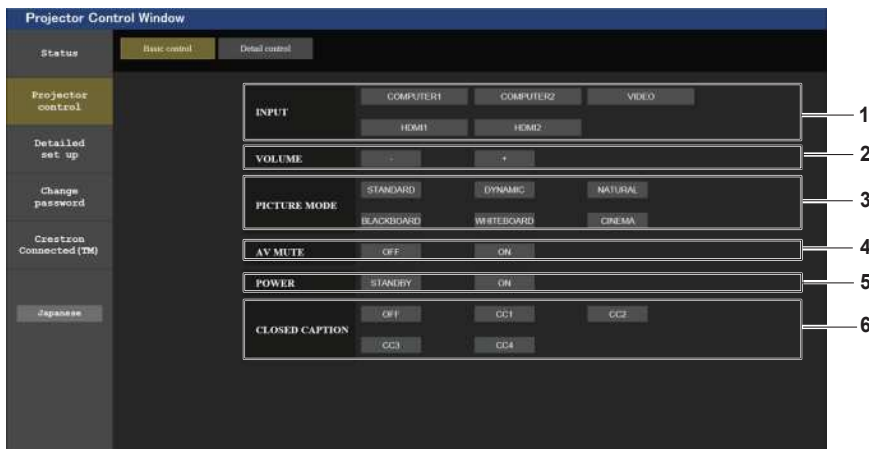

- 1 **[INPUT]**
Switches the image input to be projected.
- 2 **[VOLUME]**
Adjusts the volume level.
- 3 **[PICTURE MODE]**
Switches the picture mode.
- 4 **[AV MUTE]**
Switches the status of AV mute ([ON]: the AV mute function is enabled; [OFF]: the AV mute function is disabled).
- 5 **[POWER]**
Turns on/off the power.
- 6 **[CLOSED CAPTION]**
Switches the closed caption mode.

[Detail control] page

Click [Projector control] → [Detail control].



1 [POSITION]

Perform the following operations.

- Perform the auto setup adjustment.
For details, refer to “Using the auto setup function” (➡ page 49).
- Perform the keystone adjustment.
For details, refer to “Setting [KEYSTONE]” (➡ page 62) under the [POSITION] menu → [SCREEN ADJUSTMENT].
- Adjust the image position.
For details, refer to the [POSITION] menu → [SHIFT] (➡ page 65).

2 [PICTURE]

Adjusts the image quality related items.
For details, refer to “[PICTURE] menu” (➡ page 57).

[Network config] page

Click [Detailed set up] → [Network config].

1) Click [Network config].

- The [CAUTION!] screen is displayed.

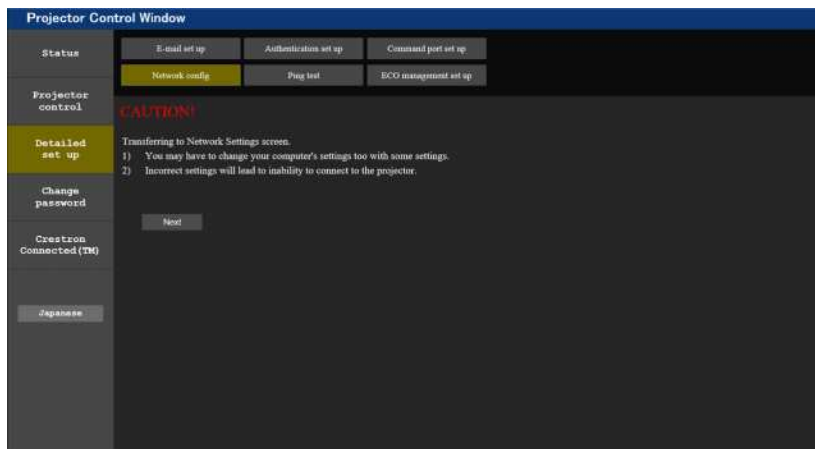

2) Click [Next].

- The current settings are displayed.

3) Click the [Change] button.

- The setting change screen is displayed. Perform the settings according to the screen instructions.

Description of each item

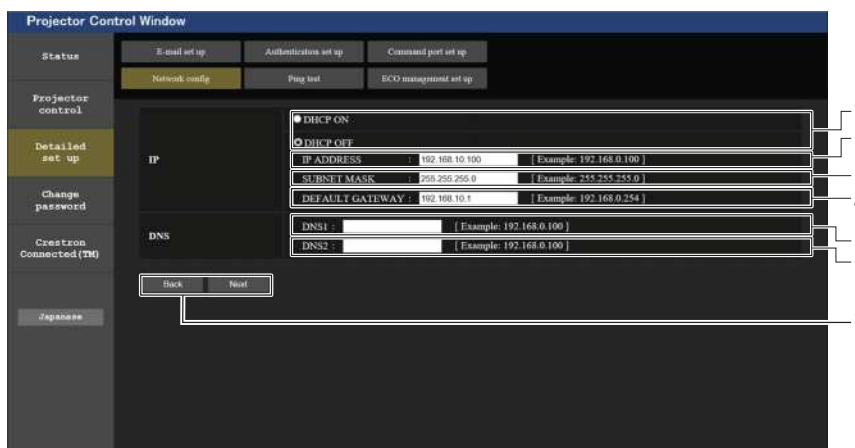

1 [DHCP ON], [DHCP OFF]

To enable the DHCP client function, set to [DHCP ON].

2 [IP ADDRESS]

Enter the IP address when not using a DHCP server.

3 [SUBNET MASK]

Enter the subnet mask when not using a DHCP server.

4 [DEFAULT GATEWAY]

Enter the default gateway address when not using a DHCP server.

5 [DNS1]

Enter the DNS1 server address.

Permissible characters for the entry of DNS1 server address (preferred):

Numbers (0 - 9), period (.)

(Example: 192.168.0.253)

6 [DNS2]

Enter the DNS2 server address.

Permissible characters for the entry of DNS2 server address (alternate):

Numbers (0 - 9), period (.)

(Example: 192.168.0.254)

7 [Back], [Next]

Click the [Back] button to return to the original screen.

The current settings are displayed by pressing the [Next] button.

Click the [Submit] button to update the settings.

Note

- When you use the “Back” and “Forward” functions of the browser, a warning message “Page has Expired” may appear. In that case, click [Network config] again since the following operation will not be guaranteed.
- Changing LAN settings while connected to the LAN may cause the connection to cut out.

[Ping test] page

Check whether the mail server, POP server, DNS server, etc. is connected to the network.

Click [Detailed set up] → [Ping test].

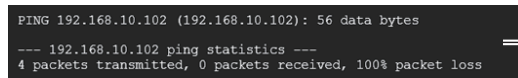
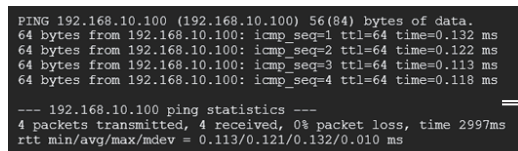
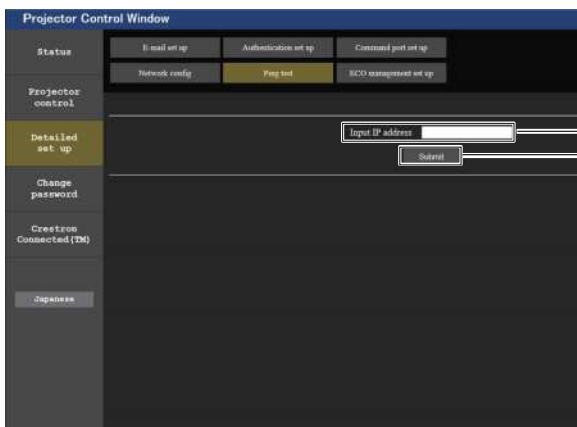

1 [Input IP address]

Enter the IP address of the server to be tested.

2 [Submit]

Executes the connection test.

3 Example of display when the connection has succeeded

4 Example of display when the connection has failed

[ECO management set up] page

Settings related to the ECO management function of the projector can be made.

Click [Detailed set up] → [ECO management set up].

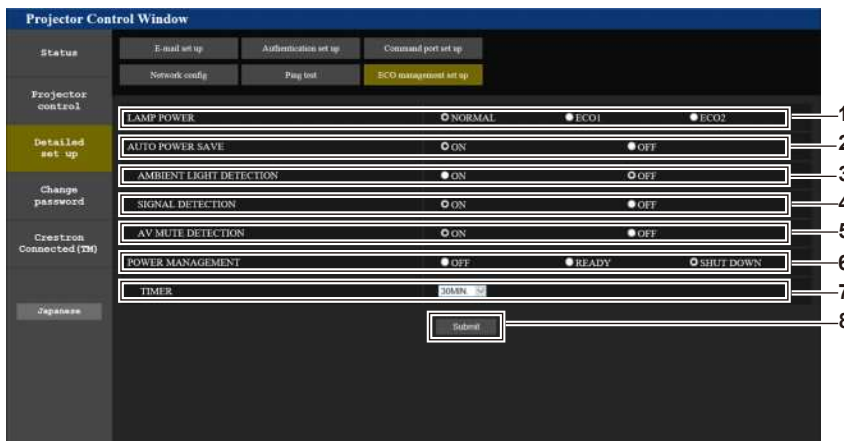

- 1 **[LAMP POWER]**
Select the [LAMP POWER] setting.
- 2 **[AUTO POWER SAVE]**
Select [ON] to set [AMBIENT LIGHT DETECTION], [SIGNAL DETECTION], and [AV MUTE DETECTION].
- 3 **[AMBIENT LIGHT DETECTION]**
Enable ([ON])/disable ([OFF]) the ambient light detection function.
- 4 **[SIGNAL DETECTION]**
Enable ([ON])/disable ([OFF]) the signal detection function.
- 5 **[AV MUTE DETECTION]**
Enable ([ON])/disable ([OFF]) the AV mute detection function.
- 6 **[POWER MANAGEMENT]**
Select the [POWER MANAGEMENT] setting.
- 7 **[TIMER]**
Select the time until the luminous lamp is turned off when the power management function is activated.
- 8 **[Submit]**
Updates the setting.

Note

- For details of each setting item on the [ECO management set up] page, refer to the [PROJECTOR SETUP] menu → [ECO MANAGEMENT]. (➡ page 80)

[E-mail set up] page

When there is a problem or the runtime of a luminous lamp reaches a set value, an E-mail can be sent to the preset E-mail addresses (up to two addresses).
Click [Detailed set up] → [E-mail set up].

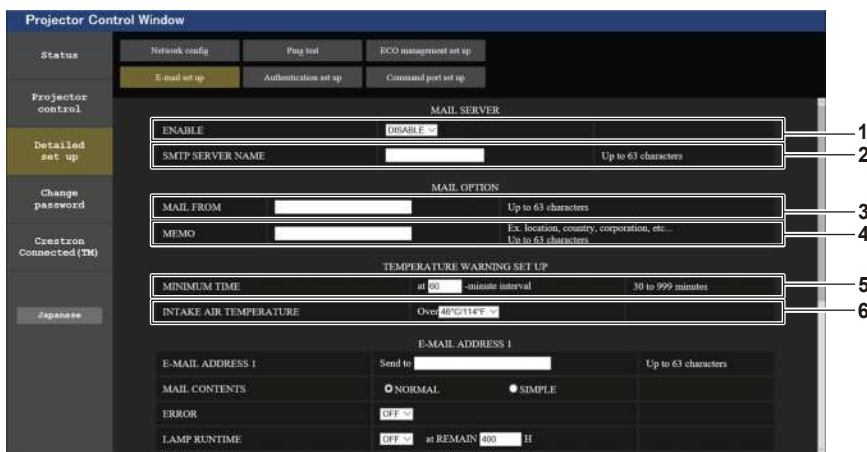

- 1 **[ENABLE]**
Select [Enable] to use the E-mail function.
- 2 **[SMTP SERVER NAME]**
Enter the IP address or the server name of the E-mail server (SMTP). To enter the server name, the DNS server needs to be set up.
- 3 **[MAIL FROM]**
Enter the E-mail address of the projector. (Maximum 63 characters in single byte)
- 4 **[MEMO]**
Enter information such as the location of the projector that notifies the sender of the E-mail. (Maximum 63 characters in single byte)
- 5 **[MINIMUM TIME]**
Change the minimum interval for the temperature warning E-mail. The default value is 60 minutes. In this case, another E-mail will not be sent within 60 minutes after sending the temperature warning E-mail even if it reaches the warning temperature.
- 6 **[INTAKE AIR TEMPERATURE]**
Change the temperature setting for the temperature warning mail. A temperature warning E-mail is sent when the temperature exceeds this value.

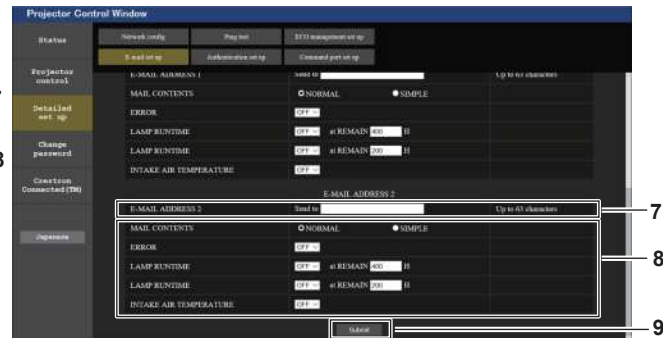
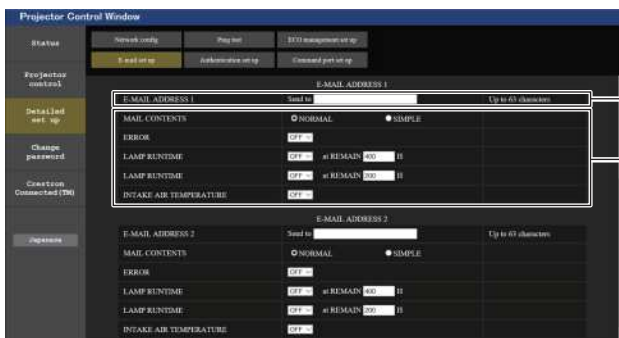

- 7 **[E-MAIL ADDRESS 1]/[E-MAIL ADDRESS 2]**
Enter the E-mail address to be sent. Leave [E-MAIL ADDRESS 2] blank when two E-mail addresses are not to be used.
- 8 **Settings of the conditions to send E-mail**
Select the conditions to send E-mail.
[MAIL CONTENTS]:
Select either [NORMAL] or [SIMPLE].
[ERROR]:
Send an E-mail when an error occurred in the self-diagnosis.

- [LAMP RUNTIME]:**
An E-mail message is sent when the remaining lamp on time for the luminous lamp has reached the value set at the right field.
- [INTAKE AIR TEMPERATURE]:**
Send an E-mail when the air intake temperature has reached the value set at the above field.

- 9 **[Submit]**
Update the settings and send it through E-mail.

[Authentication set up] page

Set the authentication items when POP authentication or SMTP authentication is necessary to send an E-mail. Click [Detailed set up] → [Authentication set up].

- 1 **[Auth]**
Select the authentication method specified by your Internet service provider.
- 2 **[SMTP Auth]**
Set when the SMTP authentication is selected.
- 3 **[POP server name]**
Enter the POP server name.
Allowed characters:
Alphanumerics (A - Z, a - z, 0 - 9)
Minus sign (-) and period (.)
- 4 **[User name]**
Enter the user name for the POP server or the SMTP server.
- 5 **[Password]**
Enter the password for the POP server or the SMTP server.
- 6 **[SMTP server port]**
Enter the port number of the SMTP server.
(Normally 25)
- 7 **[POP server port]**
Enter the port number of the POP server.
(Normally 110)
- 8 **[Submit]**
Update the settings.

Contents of mail sent

Example of E-mail sent when E-mail is set

The following E-mail is sent when the E-mail settings have been made.

```
=== Panasonic projector report(CONFIGURE) ===
Projector Type       : PT-VZ580
Serial No           : SH1234567
----- E-mail setup data -----
TEMPERATURE WARNING SETUP
MINIMUM TIME        at [ 60] minutes interval
INTAKE AIR TEMPERATURE Over [ 32degC / 89degF ]

ERROR               [ OFF ]
LAMP RUNTIME        [ OFF ]   at REMAIN [ 400] H
LAMP RUNTIME        [ OFF ]   at REMAIN [ 200] H
INTAKE AIR TEMPERATURE [ OFF ]

----- check system -----
FAN                 [ OK ]
INTAKE AIR TEMPERATURE [ OK ]
EXHAUST AIR TEMPERATURE [ OK ]
LAMP REMAIN TIME    [ OK ]
LAMP STATUS         [ OK ]
APERTURE (CONTRAST-SHUTTER) [ OK ]
AIR FILTER          [ OK ]

(Error code 00 00 00 00 00 00 00 00)

Intake air temperature : 31 degC / 87 degF
Exhaust air temperature : 37 degC / 98 degF

PROJECTOR RUNTIME      750 H

LAMP NORMAL           100 H
LAMP ECO1              420 H
LAMP ECO2              420 H
LAMP REMAIN           4250 H

----- Current status -----
MAIN VERSION          1.00
SUB VERSION           1.00
LAMP STATUS           LAMP=ON
INPUT                 RGB
SIGNAL NAME           ---
SIGNAL FREQUENCY     ---kHz / ---Hz

----- Wired Network configuration -----
DHCP Client          OFF
IP address           192.168.10.100
MAC address          04:20:9A:00:00:00

----- Memo -----
```

Example of E-mail sent for an error

The following E-mail is sent when an error has occurred.

```

=== Panasonic projector report(ERROR) ===
Projector Type       : PT-VZ580
Serial No           : SH1234567
----- check system -----
FAN                 [ OK ]
INTAKE AIR TEMPERATURE [ OK ]
EXHAUST AIR TEMPERATURE [ OK ]
LAMP REMAIN TIME    [ OK ]
LAMP STATUS         [ FAILED ]
APERTURE (CONTRAST-SHUTTER) [ OK ]
AIR FILTER          [ OK ]

(Error code 00 00 00 00 01 00 00 08)

Intake air temperature : 31 degC / 87 degF
Exhaust air temperature : 37 degC / 98 degF

PROJECTOR RUNTIME      750 H

LAMP NORMAL           100 H
LAMP ECO1             420 H
LAMP ECO2             420 H
LAMP REMAIN           4250 H

----- Current status -----
MAIN VERSION          1.00
SUB VERSION           1.00
LAMP STATUS           LAMP=ON
INPUT                 RGB

----- Wired Network configuration -----
DHCP Client           OFF
IP address            192.168.10.100
MAC address           04:20:9A:00:00:00

----- Memo -----

```

[Command port set up] page

Set the port number used for command control.
 Click [Detailed set up] → [Command port set up].

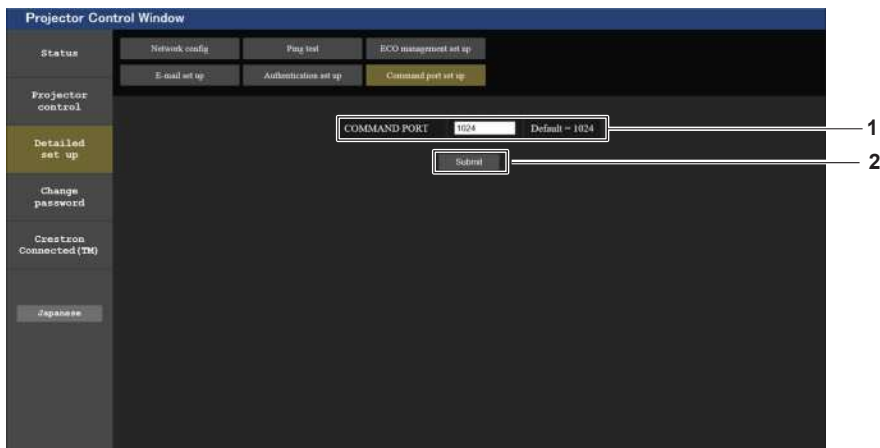

1 [COMMAND PORT]

Set the port number used for command control.

2 [Submit]

Update the settings.

[Change password] page

Click [Change password].

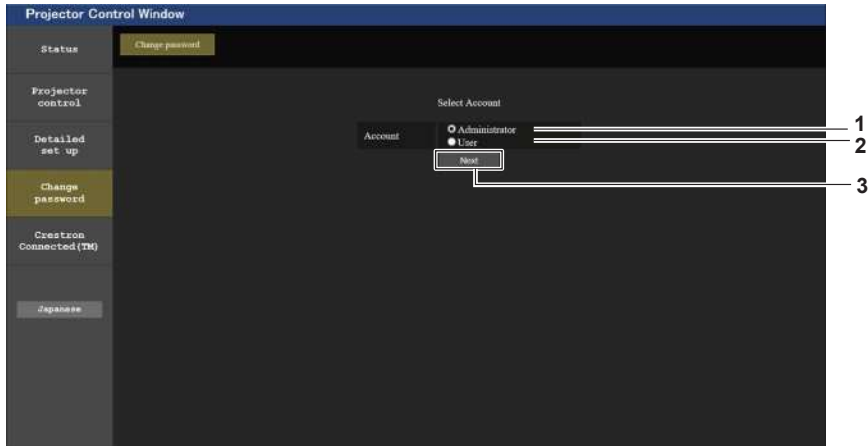

1 [Administrator]

Used to change the setting of [Administrator].

3 [Next]

Displays the password setting change screen.

2 [User]

Used to change the setting of [User].

[Administrator] account

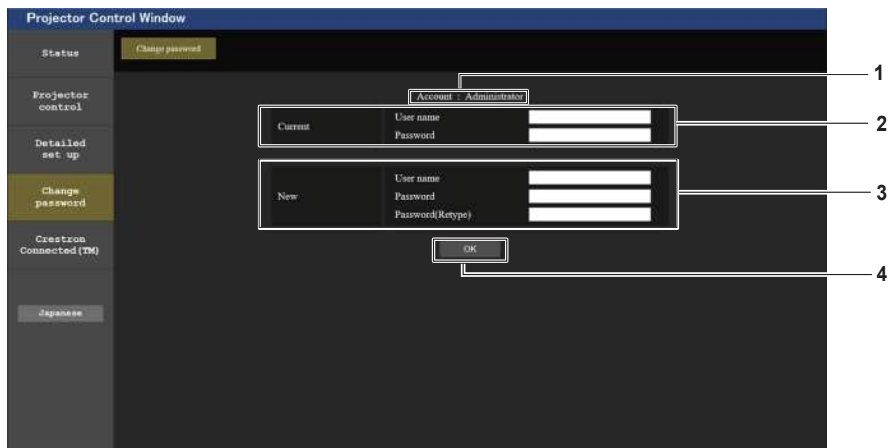

1 [Account]

Displays the account to change.

2 [Current]

[User name]:
Enter the user name before the change.

[Password]:
Enter the current password.

3 [New]

[User name]:
Enter the desired new user name.
(Maximum 16 characters in single byte)

[Password]:

Enter the desired new password.
(Maximum 16 characters in single byte)

[Password (Retype)]:

Enter the desired new password again.

4 [OK]

Confirm the change of password.

[User] account

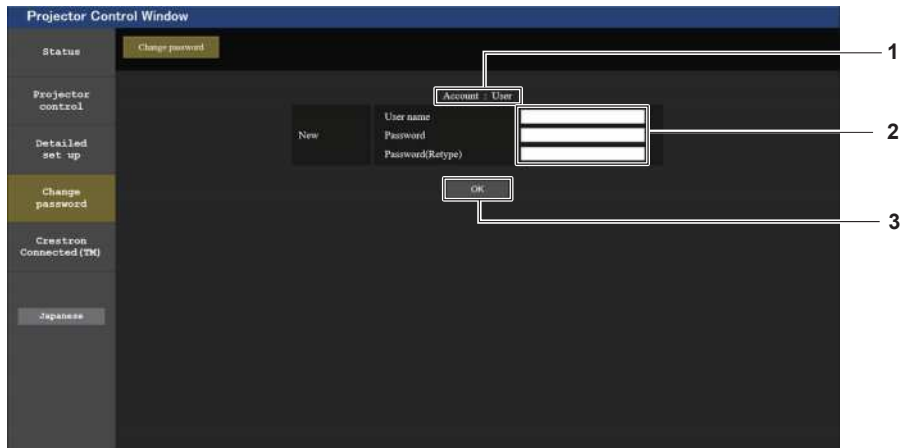

- | | |
|---|--|
| <p>1 [Account]
Displays the account to change.</p> <p>2 [New]
[User name]:
Enter the desired new user name.
(Maximum 16 characters in single byte)</p> | <p>[Password]:
Enter the desired new password. (Maximum 16 characters in single byte)</p> <p>[Password (Retype)]:
Enter the desired new password again.</p> <p>3 [OK]
Confirm the change of password.</p> |
|---|--|

[Change password] (For user rights)

Only the change of password is enabled under the user rights.

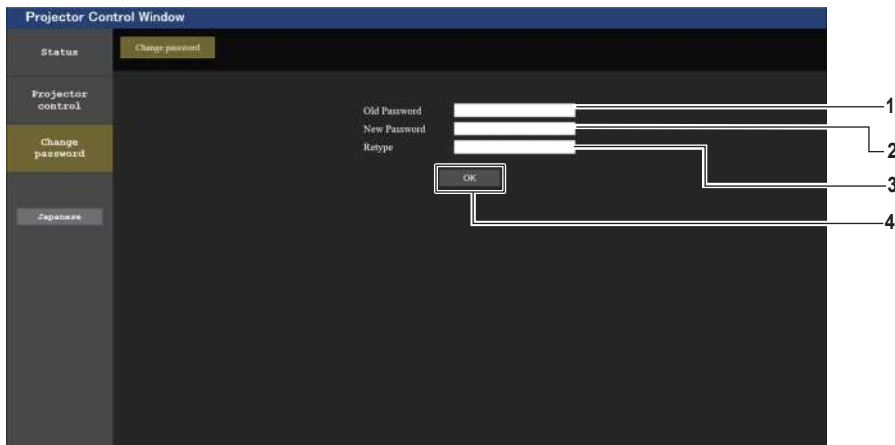

- | | |
|--|---|
| <p>1 [Old Password]
Enter the current password.</p> <p>2 [New Password]
Enter the desired new password. (Maximum 16 characters in single byte)</p> | <p>3 [Retype]
Enter the desired new password again.</p> <p>4 [OK]
Confirm the change of password.</p> |
|--|---|

Note

- To change the account of the administrator, you must enter the [User name] and [Password] in [Current].

[Crestron Connected(TM)] page

The projector can be monitored/controlled with Crestron Connected™.

To start the Crestron Connected™ control page from the web control screen, you need to access with the administrator rights. (For user rights, the [Crestron Connected(TM)] button is not displayed on the web control screen.)

The control page of Crestron Connected™ is displayed by clicking [Crestron Connected(TM)].

It is not displayed if Adobe® Flash® Player is not installed on the computer used, or the browser used does not support Flash. In that case, click [Back] on the control page to go back to the previous page.

Note

- If Microsoft Edge is used, you cannot operate the [Crestron Connected(TM)] page. Clicking the [Crestron Connected(TM)] button will freeze the web browser.

Operation page



- | | |
|---|---|
| <p>1 [Tools], [Info], [Help]
Tabs for selecting the setting, information, or help page of the projector.</p> <p>2 [POWER]
Turns on/off the power.</p> <p>3 [VOL DOWN], [AV MUTE], [VOL UP]
Adjusts the volume.
Switches on/off the AV mute function.</p> | <p>4 [Input Select]
Controls input selection.
Not available when the power of the projector is turned off.</p> <p>5 Menu screen control buttons
Navigates the menu screen.</p> <p>6 Freeze/image quality adjustment
Controls items related to freeze/image quality.</p> <p>7 [Back]
Returns to the previous page.</p> |
|---|---|

[Tools] page

Click [Tools] on the control page.

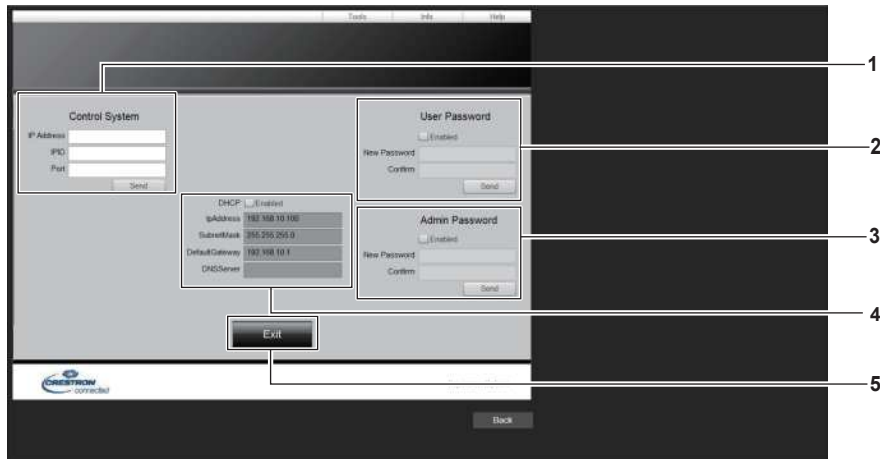

- | | |
|--|--|
| <p>1 [Control System]
Set the information required for communicating with the controller to be connected with the projector.</p> <p>2 [User Password]
Set the user rights password for the Crestron Connected™ control page.</p> <p>3 [Admin Password]
Set the administrator rights password for the Crestron Connected™ control page.</p> <p>4 Network status
Displays the settings of wired LAN.</p> | <p>[DHCP]
Displays the current setting.</p> <p>[IpAddress]
Displays the current setting.</p> <p>[SubnetMask]
Displays the current setting.</p> <p>[DefaultGateway]
Displays the current setting.</p> <p>[DNSServer]
Displays the current setting.</p> <p>5 [Exit]
Returns to the control page.</p> |
|--|--|

[Info] page

Click [Info] on the control page.

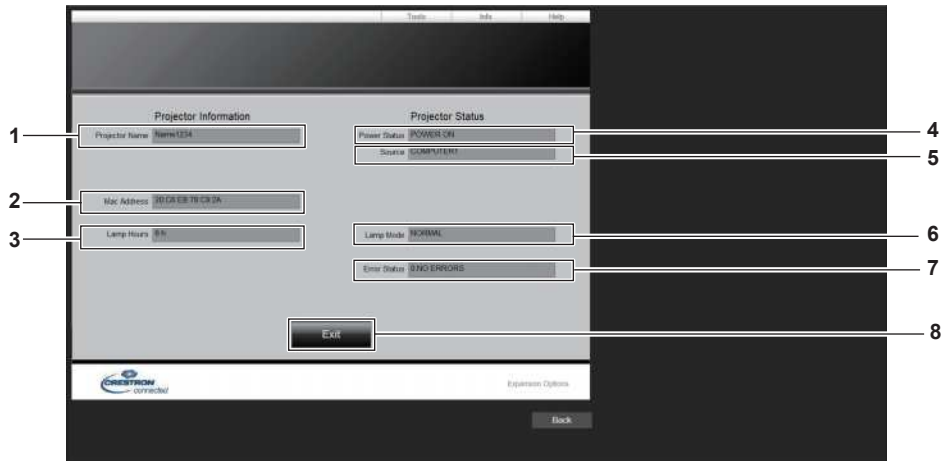

1 [Projector Name]

Displays the projector name.

2 [Mac Address]

Displays the MAC address.

3 [Lamp Hours]

Displays the runtime of the luminous lamp (converted value).

4 [Power Status]

Displays the status of the power.

5 [Source]

Displays the selected input.

6 [Lamp Mode]

Displays the setting status of [LAMP POWER].
(➡ page 79)

7 [Error Status]

Displays the error status.

8 [Exit]

Returns to the control page.

[Help] page

Click [Help] on the control page.

The [Help Desk] window is displayed.

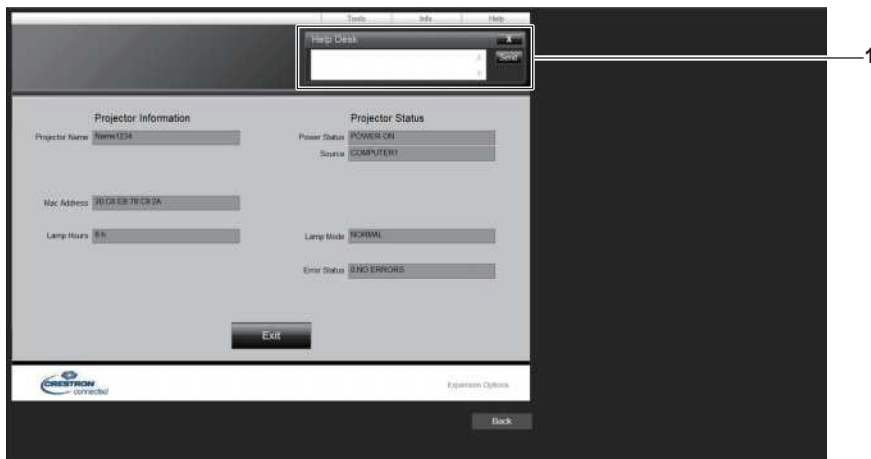

1 [Help Desk]

Send/receive messages to/from an administrator who uses Crestron Connected™.

Chapter 6 Maintenance

This chapter describes methods of inspection when there are problems, maintenance and replacement of the units.

Lamp and temperature indicators

When an indicator lights up

If a problem should occur inside the projector, the lamp indicator <LAMP> and the temperature indicator <TEMP> will inform you by lighting or blinking. Check the status of the indicators and remedy the indicated problems as follows.

Attention

- Before you take a remedial measure, follow the procedure of switching the power off indicated in “Switching off the projector”. (➔ page 42)

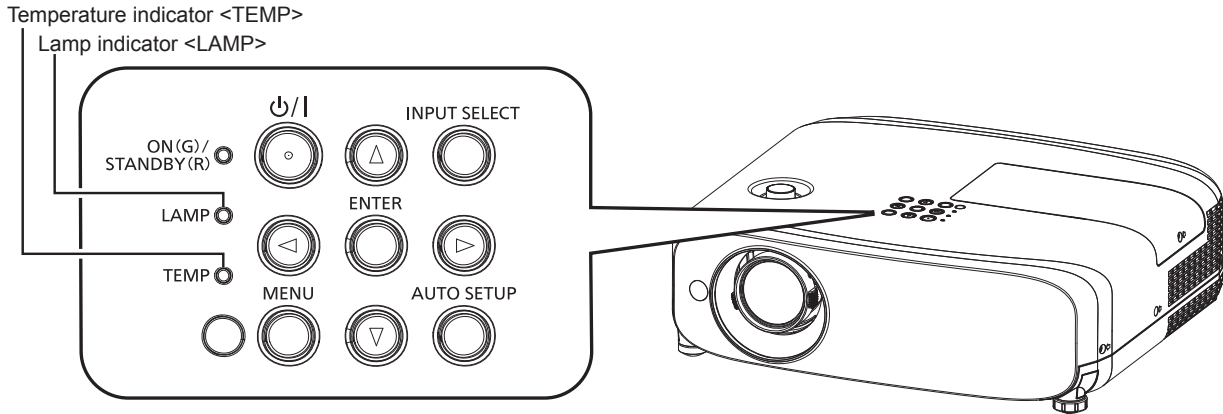

Lamp indicator <LAMP>

Indicator status	Lighting in red	Blinking in red	
Status	Time to replace the lamp unit. (➔ page 114)	A problem is detected in the luminous lamp or the luminous lamp power supply for the lamp.	
Check	<ul style="list-style-type: none"> • Was [REPLACE LAMP] displayed when you turned on the power? • The indicator lights up when the runtime of the lamp unit has reached 4 800 hours (when [LAMP POWER] is set to [NORMAL]). 	<ul style="list-style-type: none"> • Have you turned on the power again immediately after turning it off? 	<ul style="list-style-type: none"> • Some error has occurred in the lamp circuit. Check for fluctuation (or drop) in the source voltage.
Remedy	<ul style="list-style-type: none"> • Replace the lamp unit. 	<ul style="list-style-type: none"> • Wait a while until the luminous lamp cools off, and then turn on the power. 	<ul style="list-style-type: none"> • Turn off the projector, and unplug the AC power cord, and consult your dealer.

Note

- If the lamp indicator <LAMP> is still lighting or blinking after taking the preceding measures, ask your dealer for repair.
- The lamp indicator <LAMP> lights in green while the projector is in projection mode if there is no notification by lighting or blinking in red.

Temperature indicator <TEMP>

Indicator status	Lighting in red	Blinking in red	Blinking in red (Slow)
Status	The air filter is clogged, internal temperature is high (warning).	The air filter is clogged, internal temperature is high (standby status).	The projector detects an abnormal condition and cannot be turned on.
Check	<ul style="list-style-type: none"> • Is the air intake/exhaust port blocked? • Is the room temperature high? • Is the air filter unit dirty? 		—
Remedy	<ul style="list-style-type: none"> • Remove any objects that are blocking the air intake/ exhaust port. • Install the projector in a location with an ambient temperature of 0 °C (32 °F) to 40 °C (104 °F)*1. • Do not use the projector at high altitudes of 2 700 m (8 858') or higher above sea level. • Clean or replace the air filter unit. (➔ page 115) 		<ul style="list-style-type: none"> • If the projector is turned off again, unplug the AC power cord and contact the dealer or the service center for service and checkup.

*1 When using the projector at high altitudes (between 1 200 m (3 937') and 2 700 m (8 858') above sea level), the operating environment temperature should be between 0 °C (32 °F) and 30 °C (86 °F).

Note

- If the temperature indicator <TEMP> is still lighting or blinking after taking the preceding measures, ask your dealer for repair.
- When the projector is used with the [PROJECTOR SETUP] menu → [LAMP POWER] set to [NORMAL], the [LAMP POWER] will be forcibly switched to [ECO1] to protect the projector if the operating environment temperature exceeds 35 °C (95 °F).

Maintenance/replacement

Before performing maintenance/replacement

- Make sure to turn off the power before maintaining the projector or replacing the unit.
- When switching off the projector, make sure to follow the procedures in “Switching off the Projector”. (▶ page 42)

Maintenance

Outer case

Wipe off dirt and dust with a soft, dry cloth.

- If the dirt is persistent, soak the cloth with water and wring it thoroughly before wiping. Dry off the projector with a dry cloth.
- Do not use benzene, thinner, or rubbing alcohol, other solvents, or household cleaners. Doing so may deteriorate the outer case.
- When using chemically treated dust cloths, follow the instructions written on its packaging.

Lens front surface

Wipe off dirt and dust from the front surface of the lens with a soft clean cloth.

- Do not use a cloth that is fluffy, dusty, or soaked with oil/water.
- Since the lens is fragile, do not use excessive force when wiping the lens.

Attention

- The lens is made of glass. Impacts or excessive force when wiping may scratch its surface. Handle with care.

Air filter unit

This section describes the maintenance of the air filter unit that is installed as standard on the projector.

The air filter unit is the same as the optional Replacement Filter Unit (Model No.: ET-RFV410).

In the following cases, remove the air filter unit and check the clogging condition of the air filter. If the air filter is clogged, clean the air filter unit.

- A temperature warning message is displayed on the projection screen.
- The temperature indicator <TEMP> lights in red in the projection state.
- The temperature indicator <TEMP> blinks in red in the standby state.
- The message of “FILTER COUNTER has reached the set time.” that prompts to perform maintenance of the air filter unit is displayed on the projection screen.

Attention

- Make sure to turn off the power before performing maintenance of the air filter. (▶ pages 38, 42)
- Make sure that the projector is stable, and perform the maintenance in a safe place even if the filter falls accidentally.

Note

- Check the usage time of the air filter in the [PROJECTOR SETUP] menu → [FILTER COUNTER].
- Air filter replacement is recommended after washing the air filter two times for recycling.
- The air filter performance after washing may be reduced compared with its initial performance.
- The time until the air filter is clogged varies greatly depending on the usage environment.

Removing the air filter unit

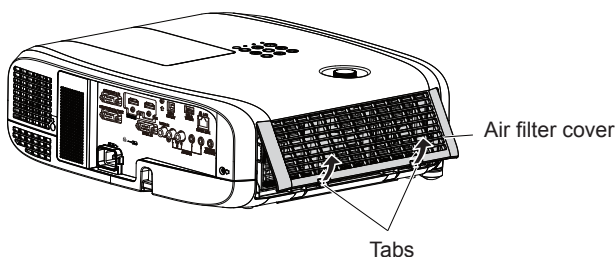

Fig. 1

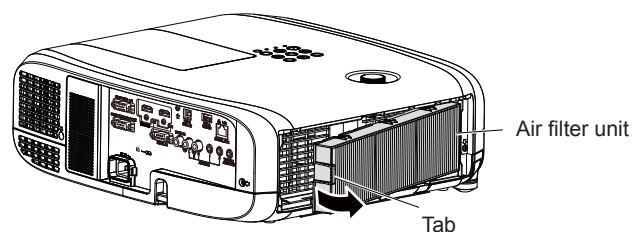

Fig. 2

1) Turn off the projector.

- When switching off the projector, make sure to follow the procedures in “Switching off the projector” (➔ page 42).

2) Remove the air filter cover. (Fig. 1)

- Push the tabs of the air filter cover upward as shown in the figure, remove them from the hooks of the projector and open it in the direction of the arrow in the figure.

3) Remove the air filter unit. (Fig. 2)

- Put your finger on the tab on the left side of the air filter unit, open it in the direction of the arrow shown in the figure and remove it.
- After removing the air filter unit, remove the foreign objects and dust in the air filter unit compartment if there are any.
- After removing the air filter unit, proceed to “Performing maintenance of the air filter unit” (➔ page 112).

Note

- When using the projector, be sure to attach the air filter unit. If it is not attached, the projector will suck in dirt and dust causing a malfunction.
-

Performing maintenance of the air filter unit

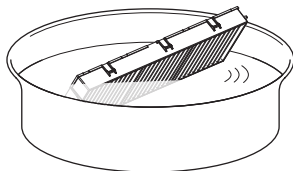

Fig. 1

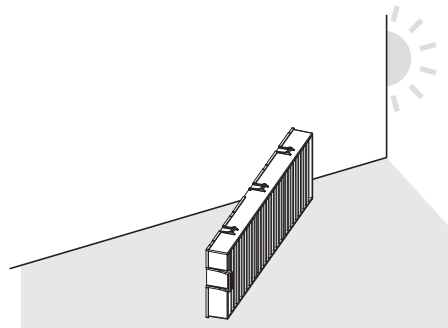

Fig. 2

1) Wash the air filter unit. (Fig. 1)

- i) Soak the air filter unit in cold or warm water and then lightly rinse it.
 - Do not use cleaning tools such as brushes.
 - When rinsing, hold the frame of the air filter unit without putting strong pressure on the filter.
- ii) Rinse the air filter unit two or three times with fresh water.
 - Insufficient rinsing may result in odors.

2) Dry the air filter unit. (Fig. 2)

- Let the air filter unit naturally dry off in a well-ventilated place where there is little dust and is not exposed to direct sunlight.
- Do not dry using drying devices such as dryers.
- After the air filter unit is dried, proceed to “Attaching the air filter unit” (➔ page 113).

Attention

- After washing the air filter unit, dry it thoroughly before attaching it back to the projector. Attaching a wet unit will cause an electric shock or malfunction.
- Do not disassemble the air filter unit.

Note

- Replace the air filter unit with a new optional Replacement Filter Unit (Model No.: ET-RFV410) if it is damaged or if the dirt does not come off even after washing

Attaching the air filter unit

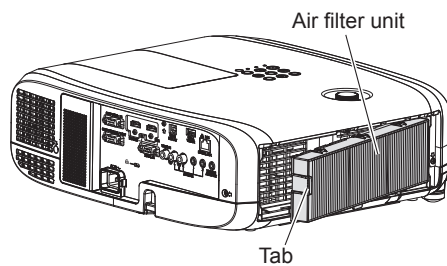

Fig. 1

1) Attach the air filter unit to the projector. (Fig. 1)

- Hold the air filter unit with the tab on the left side as shown in the figure, attach it from the right side, and push the tab until it clicks.
- Do not press on the crease part of the air filter when pressing into place.

2) Attach the air filter cover to the projector.

- Perform in the reverse order of the Step 2) of “Removing the air filter unit” (➡ page 111) to close the air filter cover. Make sure to press the air filter cover firmly until it clicks into place.
- When the air filter unit is attached to the projector, proceed to the “Resetting the air filter counter” (➡ page 113).

Note

- When using the projector, be sure to attach the air filter unit. If it is not attached, the projector will suck in dirt and dust causing a malfunction.

Resetting the air filter counter

1) Turn on the projector.

2) Press the <MENU> button on the remote control or the control panel.

- The main menu screen is displayed.

3) Press ▲▼ to select [PROJECTOR SETUP].

4) Press the <ENTER> button.

- The [PROJECTOR SETUP] screen is displayed.

5) Press ▲▼ to select [FILTER COUNTER].

6) Press the <ENTER> button.

- The [FILTER COUNTER] screen is displayed.

7) Press ▲▼ to select [FILTER COUNTER RESET] and press the <ENTER> button.

8) When the confirmation screen is displayed, press ◀▶ to select [OK], then press the <ENTER> button.

- The [PROJECTOR SETUP] menu → [FILTER COUNTER] → [FILTER COUNTER] is displayed as “0H”.

Note

- When the projector is used without resetting the filter counter, the actual filter usage time (counter numeric value) will not be able to be confirmed.

Replacement

Lamp unit

The lamp unit is a consumable component. Refer to “When to replace the lamp unit” (➡ page 114) for details about the replacement cycle.

When purchasing the optional Replacement Lamp Unit (Model No.: ET-LAV400), consult your dealer.

It is recommended to replace the lamp unit by a professional technician. Consult your dealer for details.

Warning

Replace the lamp unit after the lamp has cooled (after waiting at least one hour).
The high temperature inside the cover will cause burns.

Notes on the replacement of the lamp unit

- A Phillips screwdriver is required when replacing the lamp unit.
- Since the luminous lamp is made of glass, it may burst if dropped or hit with a hard object. Handle with care.
- Do not disassemble or modify the lamp unit.
- When replacing the lamp unit, be sure to hold it by the handle because its surface is pointed and its shape is protruded.
- The lamp may rupture. Replace the lamp unit carefully so that the glass fragments of the lamp do not scatter. While attaching the projector to the ceiling, do not work right under the lamp unit or do not conduct work while your face is near the lamp unit.
- The lamp contains mercury. When disposing of used lamp units, contact your local authorities or dealer for correct methods of disposal.

Attention

- Panasonic takes no responsibility for any damage or malfunction of the product resulting from use of lamp units which are not manufactured by Panasonic. Use only specified lamp units.



Note

- The model numbers of accessories and optional accessories are subject to change without prior notice.

When to replace the lamp unit

The lamp unit is a consumable component. Since its brightness gradually decreases over time, it is necessary to replace the lamp unit regularly. The estimated duration before replacement is 5 000 hours, but the lamp may go off before reaching to 5 000 hours, depending on the characteristics of the individual lamp, usage conditions, and the installation environment. It is recommended that the Replacement Lamp Unit be prepared earlier.

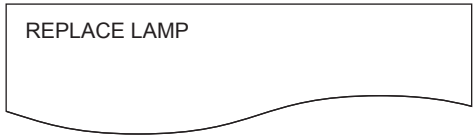
If you continue to use the lamp unit after 5 000 hours has elapsed, the lamp turns off automatically after approximately 10 minutes, as it may cause malfunction of the projector.

	On-screen display	Lamp indicator <LAMP>
		
Over 4 800 hours	The message is displayed for 30 seconds. If you press any button on the control panel or the remote control within 30 seconds, the message disappears.	Lights in red (even in stand-by mode).
Over 5 000 hours	The message remains displayed until you press any button.	

Note

- To predict the lamp unit replacement time, convert the runtime of [NORMAL], [ECO1] and [ECO2], which are set from the [PROJECTOR SETUP] menu → [LAMP POWER], to the equivalent runtime of [[NORMAL] respectively. After checking the runtime of [NORMAL], [ECO1] and [ECO2] displayed in the [PROJECTOR SETUP] menu → [STATUS] → [RUNTIME] → [LAMP (ET-LAV400)], calculate the converted runtime by referring to "Formula for lamp unit replacement time (rough estimate)". (➡ page 78)
- The lamp unit replacement time of 5 000 hours is a rough guideline instead of a guarantee.

How to replace the lamp unit

Attention

- When the projector is mounted on a ceiling, do not work with your face close to the lamp unit.
- When replacing the lamp unit, do not remove or loosen the screws other than specified.
- Attach the lamp unit and the lamp cover securely.

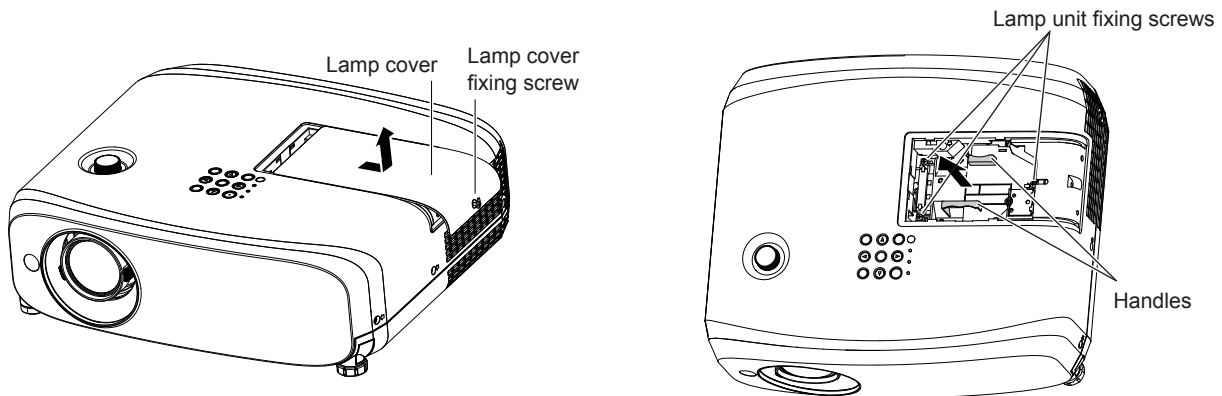

Fig. 1

Fig. 2

- 1) After turning off the projector, remove the plug from the outlet.**
 - Wait at least one hour and make sure the lamp unit and surroundings have cooled down.
- 2) Remove the lamp cover. (Fig. 1)**
 - Turn the lamp cover fixing screw (×1) with the Phillips screwdriver in the counterclockwise direction until it turns freely, slowly slide the lamp cover in the direction of the arrow, and then remove it.
- 3) Remove the lamp unit. (Fig. 2)**
 - Turn the lamp unit fixing screws (×3) with a Phillips screwdriver in the counterclockwise direction until it turns freely, and remove lamp unit.
 - Hold the handle of the lamp unit and take it straight out.
 - Do not remove screws other than the lamp unit fixing screws.
- 4) Press in the new lamp unit while paying attention to the insertion position.**
 - If it is difficult to install the lamp unit, remove and reinstall it. The connector part may be damaged if it is pressed by force.
- 5) Use a Phillips screwdriver to firmly tighten the lamp unit fixing screws (x3).**
 - Make sure to attach the lamp unit securely.
- 6) Attach the lamp cover.**
 - i) Perform Step 2) in the reverse order to attach the lamp cover.
 - ii) Use a Phillips screwdriver to firmly tighten the lamp cover fixing screw (x1).
 - Make sure to attach the lamp cover slowly and securely.

Note

- When you replace the lamp unit with a new one, the projector resets the runtime of the lamp unit automatically.

Air filter unit

If dirt does not come off even after the air filter unit is cleaned, it is time for the unit to be replaced. The Replacement Filter Unit (Model No.: ET-RFV410) is an optional accessory. To purchase the product, consult your dealer.

Attention

- Make sure to turn off the power before replacing the filter. (➔ page 42)
- Make sure that the projector is stable, and perform the maintenance in a safe place even if the filter falls accidentally.

Note

- The replacement cycle of the air filter unit varies greatly depending on the usage environment.

How to replace the air filter unit

- 1) **Remove the air filter unit.**
 - Refer to “Removing the air filter unit” (➡ page 111).
- 2) **Install the optional Replacement Filter Unit (Model No.: ET-RFV410) to the projector.**
 - Refer to “Attaching the air filter unit” (➡ page 113).
- 3) **Reset the air filter counter.**
 - Refer to “Resetting the air filter counter” (➡ page 113).

Attention

- When switching on the projector, make sure that the air filter unit is attached. If it is not attached, the projector will suck in dirt and dust causing a malfunction.
- If the projector is used without resetting the filter counter, the actual filter usage time (counter numeric value) will not be able to be confirmed.

Troubleshooting

Please check following points. For details, refer to the corresponding pages.

Problem	Points to be checked	Reference page
Power does not turn on.	<ul style="list-style-type: none"> Is the power plug firmly connected to the outlet? Is the wall outlet supplying electricity? Have the circuit breakers tripped? Is the lamp indicator <LAMP> or temperature indicator <TEMP> lit or blinking? Is the lamp cover attached securely? 	— — — 110 115
No image appears.	<ul style="list-style-type: none"> Are connections to external devices correctly performed? Is the input selection setting correct? Is the [BRIGHTNESS] adjustment setting at a minimum? Is the external device that is connected to the projector working properly? Is the AV mute function activated? 	34 44 57 — 48, 77
Image is fuzzy.	<ul style="list-style-type: none"> Is the lens cap still attached? Is the lens focus set correctly? Is the projection distance appropriate? Is the lens dirty? Is the projector installed perpendicular to the screen? 	27 45 30 19 —
Color is pale or grayish.	<ul style="list-style-type: none"> Is [COLOR] or [TINT] adjusted correctly? Is the external device connected to the projector adjusted correctly? Is the RGB signal cable damaged? 	57 — —
Audio is not output.	<ul style="list-style-type: none"> Is the external device connected correctly to the audio input terminal? Is the volume set to the minimum level? Is the AV mute function activated? Is the mute function activated? Is the audio input selection in [AUDIO SETTING] set correctly? Is the cable connected to the <VARIABLE AUDIO OUT> terminal? If connected, the built-in speaker will not output audio. 	34, 36 48, 82 48, 76 48, 82 82 34, 36
Remote control does not work.	<ul style="list-style-type: none"> Are the batteries depleted? Is the polarity of the batteries set correctly? Are there any obstructions between the remote control and the remote control signal receiver of the projector? Is the remote control used beyond its effective operation range? Is the remote control subject to influences from fluorescent light, etc. Is the [REMOTE CONTROLLER] setting in [CONTROL DEVICE SETUP] set to [DISABLE]? Is the ID number setting operation correct? 	— 26 23 23 23 88 51
Buttons on the control panel do not work.	<ul style="list-style-type: none"> Is the [CONTROL PANEL] setting in [CONTROL DEVICE SETUP] set to [DISABLE]? 	88
Image does not display correctly.	<ul style="list-style-type: none"> Is there a problem with the video tape or other image sources on the external devices to output images? Is the signal input incompatible with the projector? 	— 126
Image from a computer does not appear.	<ul style="list-style-type: none"> Is the cable too long? (For D-Sub cables, the cable length should be 10 m (32'10") or shorter.) Is the external video output on the laptop computer set correctly? (Ex.: The external output settings may be switched by pressing the "Fn" + "F3" or "Fn" + "F10" simultaneously. Since the method varies depending on the computer type, refer to the user manual provided with your computer.) 	— 45
Video from HDMI compatible device does not appear or it appears jumbled.	<ul style="list-style-type: none"> Is the HDMI cable securely connected? Turn the power of the projector and the external device off and on. Is the signal input incompatible with the projector? 	34 — 126
Audio from HDMI compatible device is not output.	<ul style="list-style-type: none"> Set to the linear PCM audio for the connected devices. 	—

Attention

- If the problem persists, after confirming the contents of the table, consult your dealer.

Chapter 7 Appendix

This chapter describes specifications for the projector.

Technical information

PJLink protocol

The network function of the projector supports PJLink class 1, and the PJLink protocol can be used to perform projector setting and projector status query operations from a computer.

Control commands

The following table lists the PJLink protocol commands that can be used to control the projector.

- × characters in tables are non-specific characters.

Command	Control details	Parameter / return string	Remark		
POWR	Power supply control	0 1	Standby Power on		
POWR?	Power supply query	0 1 2 3	Standby Power on Preparing for switching off the projector Warm-up		
INPT	Input selection	11 12 21 31 32	COMPUTER 1 COMPUTER 2 VIDEO HDMI1 HDMI2		
INPT?	Input selection query				
AVMT	AV mute control	30	AV mute function disabled (off)		
AVMT?	AV mute status query	31	AV mute function enabled (on)		
ERST?	Error status query	xxxxxx	1st byte	Indicates fan errors, and returns 0 or 2	<ul style="list-style-type: none"> • 0 = No error is detected • 1 = Warning • 2 = Error
			2nd byte	Indicates lamp errors, and returns 0 – 2	
			3rd byte	Indicates temperature errors, and returns 0 – 2	
			4th byte	Returns 0	
			5th byte	Indicates filter errors, and returns 0 – 2	
			6th byte	Indicates other errors, and returns 0 or 2	
LAMP?	Luminous lamp status query	xxxxxx	1st number (1 – 5 digits) : Luminous lamp runtime 2nd number: 0 = Luminous lamp off, 1 = Luminous lamp on		
INST?	Input selection list query	11 12 21 31 32			
NAME?	Projector name query	xxxxx	Returns the name set in [PROJECTOR NAME] of [NETWORK].		
INF1?	Manufacturer name query	Panasonic	Returns manufacturer name.		
INF2?	Model name query	VZ580 VW540 VX610	Returns model name.		
INF0?	Other information query	xxxxx	Returns information such as version number.		
CLSS?	Class information query	1	Returns class for PJLink.		

PJLink security authentication

The password used for PJLink is the same as that of the password set for web control.

When using the projector without security authentication, do not set a password for web control.

- For specifications related to PJLink, refer to the website of Japan Business Machine and Information System Industries Association.

URL <http://pjlink.jbmia.or.jp/english/>

Control commands via LAN

You can also control via the <LAN> terminal by using the control command format via the <SERIAL IN> terminal. For examples of the available commands, refer to “Control commands” (➡ page 124).

When WEB Control administrator rights password is set (Protect mode)

Connecting method

1) Obtain the IP address and port number (Initial set value = 1024) of the projector and make a request for connection to the projector.

- Acquire the IP address from the menu screen of the projector, and the port number from the WEB control page.

IP address	Obtain from the [NETWORK] menu → [NETWORK STATUS]
Port No.	Obtain from the WEB control → [Detailed set up] → [Command port set up] page → [COMMAND PORT]

2) Check the response from the projector.

	Data section	Blank	Mode	Blank	Random number section	Termination symbol
Command example	“NTCONTROL” (ASCII string)	‘ ’ 0x20	‘1’ 0x31	‘ ’ 0x20	“zzzzzzzz” (ASCII code hexadecimal number)	(CR) 0x0d
Data length	9 bytes	1 byte	1 byte	1 byte	8 bytes	1 byte

- Mode: 1 = Protect mode
- Example: Response during protect mode (random number section is undefined value)
“NTCONTROL 1 23181e1e” (CR)

3) Generate a 32-byte hash value from the following data using MD5 algorithm.

- “xxxxxx:yyyyy:zzzzzzzz”

xxxxxx :	Administrator rights user name for WEB CONTROL (Default user name is “admin1”)
yyyyy :	Password of above administrator rights user (Default password is “panasonic”)
zzzzzzzz :	8-byte random number obtained in Step 2)

Command data format

It is the data format used for sending and receiving commands.

■ Transmitted data

	Header			Data section	Termination symbol
Command example	Hash value (Refer to “Connecting method” above)	‘0’ 0x30	‘0’ 0x30	Control command (ASCII string)	(CR) 0x0d
Data length	32 bytes	1 byte	1 byte	Undefined length	1 byte

- Example: Transmission of power supply status acquisition command (hash value is calculated from default user name, password, and acquired random number)
“dbdd2dabd3d4d68c5dd970ec0c29fa6400QPW” (CR)

■ Received data

	Header		Data section	Termination symbol
Command example	‘0’ 0x30	‘0’ 0x30	Control command (ASCII string)	(CR) 0x0d
Data length	1 byte	1 byte	Undefined length	1 byte

- Example: The projector is powered on
“00001” (CR)

■ Error response

	String	Details	Termination symbol
Message	"ERR1"	Undefined control command	(CR) 0x0d
	"ERR2"	Out of parameter range	
	"ERR3"	Busy state or no-acceptable period	
	"ERR4"	Timeout or no-acceptable period	
	"ERR5"	Wrong data length	
	"ERRA"	Password mismatch	
Data length	4 bytes	—	1 byte

Note

- The projector automatically disconnects from the network immediately after sending the command. Such specifications are made from the viewpoint of security, such as prevention of illegal operation of the projector by a malicious third party. To send commands continuously, make a request for network connection every time. For details, see "Communication flow between the server and the client (➔ page 122).

When WEB Control administrator rights password is not set (Non-protect mode)

Note

- Use the non-protect mode only in a dedicated system which can be used by the network administrator only. If you operate in an intranet that may be used by a third party, use the protect mode.

Connecting method

1) Obtain the IP address and port number (Initial set value = 1024) of the projector and make a request for connection to the projector.

- Acquire the IP address from the menu screen of the projector, and the port number from the WEB control page.

IP address	Obtain from the [NETWORK] menu → [NETWORK STATUS]
Port No.	Obtain from the WEB control → [Detailed set up] → [Command port set up] page → [COMMAND PORT]

2) Check the response from the projector.

	Data section	Blank	Mode	Termination symbol
Command example	"NTCONTROL" (ASCII string)	' '	'0' 0x30	(CR) 0x0d
Data length	9 bytes	1 byte	1 byte	1 byte

- Mode: 0 = Non-protect mode
- Example: Response during non-protect mode
"NTCONTROL 0" (CR)

Command data format

It is the data format used for sending and receiving commands.

■ Transmitted data

	Header		Data section	Termination symbol
Command example	'0' 0x30	'0' 0x30	Control command (ASCII string)	(CR) 0x0d
Data length	1 byte	1 byte	Undefined length	1 byte

- Example: Transmission of power supply status acquisition command
"00QPW" (CR)

■ Received data

	Header		Data section	Termination symbol
Command example	'0' 0x30	'0' 0x30	Control command (ASCII string)	(CR) 0x0d
Data length	1 byte	1 byte	Undefined length	1 byte

- Example: The projector is in standby status
"00000" (CR)

■ Error response

	String	Details	Termination symbol
Message	"ERR1"	Undefined control command	(CR) 0x0d
	"ERR2"	Out of parameter range	
	"ERR3"	Busy state or no-acceptable period	
	"ERR4"	Timeout or no-acceptable period	
	"ERR5"	Wrong data length	
	"ERRA"	Password mismatch	
Data length	4 bytes	—	1 byte

Note

- The projector automatically disconnects from the network immediately after sending the command. Such specifications are made from the viewpoint of security, such as prevention of illegal operation of the projector by a malicious third party. To send commands continuously, make a request for network connection every time and send it. For details, see "Communication flow between the server and the client" (➔ page 122).

Communication flow between the server and the client

When sending / receiving commands via LAN, refer to the communication flow shown below.

Server: the projector

Client: the control device such as a computer

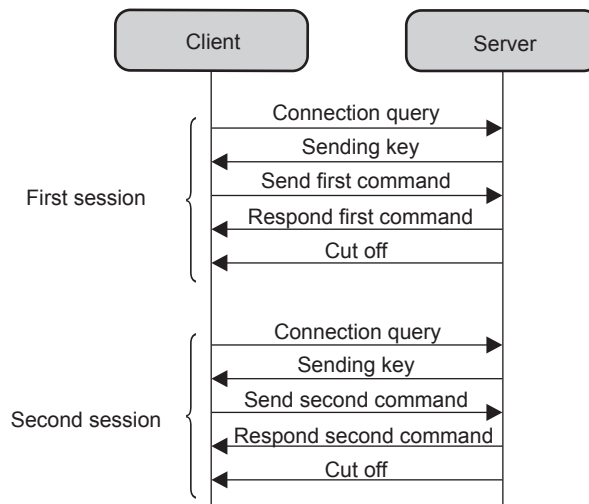

<SERIAL IN> terminal

The <SERIAL IN> terminal of the projector conforms with RS-232C so that the projector can be connected to and controlled from a computer.

Connection

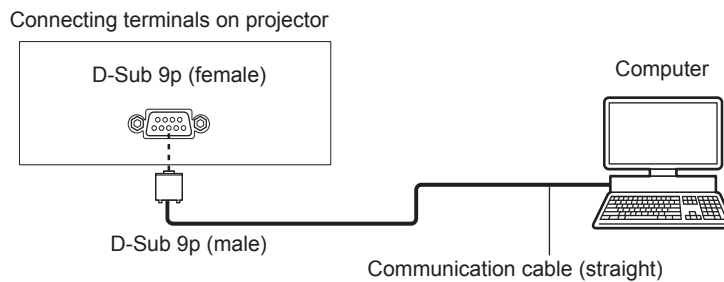

Pin assignments and signal names

D-Sub 9-pin (female) Outside view	Pin No.	Signal name	Contents
	①	—	NC
	②	TXD	Transmitted data
	③	RXD	Received data
	④	—	NC
	⑤	GND	Earth
	⑥	—	NC
	⑦	CTS	Connected internally
	⑧	RTS	
	⑨	—	NC

Communication conditions (Factory default)

Signal level	RS-232C-compliant
Sync. method	Asynchronous
Baud rate	9 600 bps
Parity	None
Character length	8 bits
Stop bit	1 bit
X parameter	None
S parameter	None

Basic format

Transmission from the computer starts with STX, then the ID, command, parameter, and ETX are sent in this order. Add parameters according to the details of control.

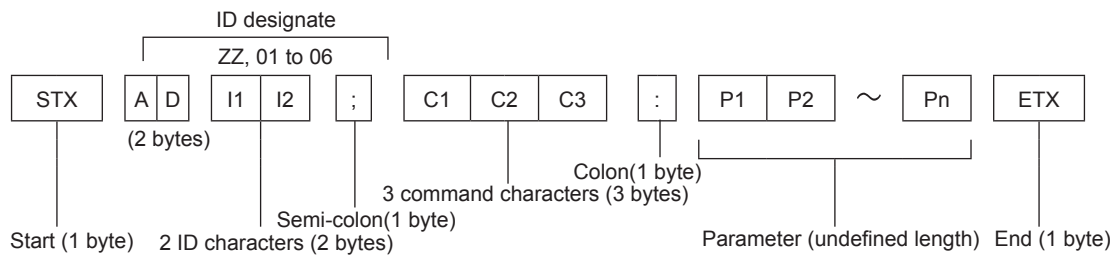

Basic format (with sub command)

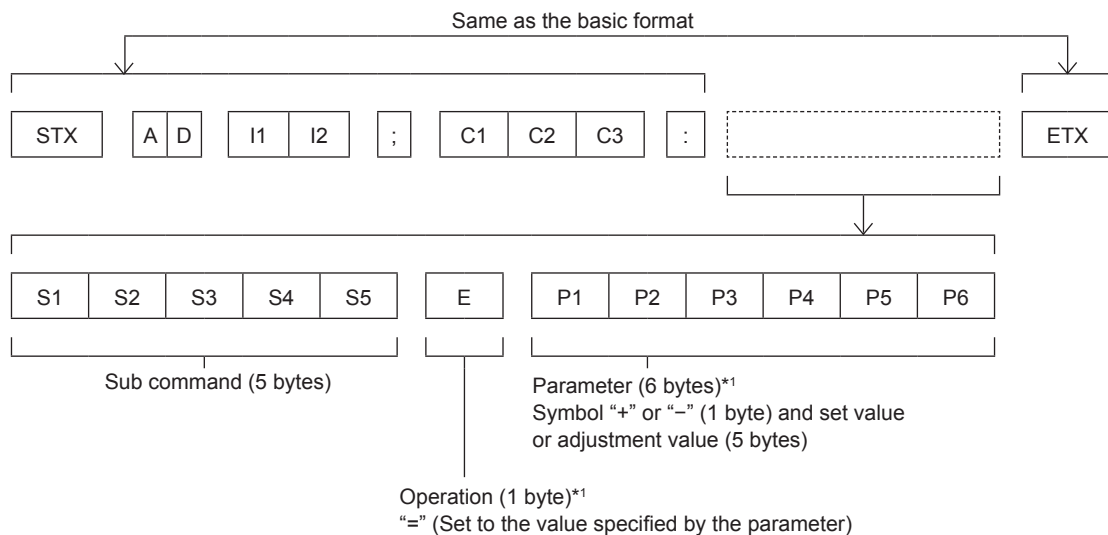

*1 When transmitting a command which does not need a parameter, the operation (E) and parameter are not necessary.

Attention

- If a command is transmitted after the luminous lamp starts illuminating, there may be a delay in response or the command may not be executed. Try sending or receiving any command after 60 seconds.
- When transmitting multiple commands, be sure to wait until 0.5 seconds has elapsed after receiving the response from the projector before sending the next command. When transmitting a command which does not need a parameter, a colon (:) is not necessary.

Note

- If a command cannot be executed, the “ER401” response is sent from the projector to the computer.
- If an invalid parameter is sent, the “ER402” response is sent from the projector to the computer.
- ID transmission in RS-232C supports ZZ (ALL) and 01 to 06.
- If a command is sent with a specified ID, a response will be sent to the computer only in the following cases.
 - It matches the projector ID
 - When [PROJECTOR ID] (➔ page 78) on the projector is [ALL]
- STX and ETX are character codes. STX shown in hexadecimal is 02, and ETX shown in hexadecimal is 03.

Cable specifications

When connected to a computer

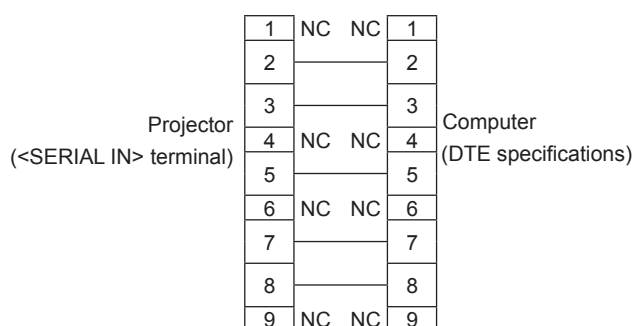

Control command

The following table lists the commands that can be used to control the projector using a computer.

■ Projector control command

Command	Control details	Parameter / return string	Remarks
PON	Power on	—	To check if the power is on, use the “Power query” command.
POF	Power off		
IIS	INPUT selection	VID RG1 RG2 HD1 HD2	VIDEO COMPUTER1 COMPUTER2 HDMI1 HDMI2
OFZ	Freeze	0 1	Freeze function disabled (off) Freeze function enabled (on)
AUU	Volume up	—	—
AUD	Volume down		
DZU	D. ZOOM up	—	—
DZD	D. ZOOM down		
OSH	AV mute function	0 1	AV mute function disabled (off) AV mute function enabled (on)
QPW	Power query	000 001	Standby Power on
Q\$\$	Luminous lamp condition query	0 1 2 3	Stand-by Luminous lamp ON control active Luminous lamp ON Luminous lamp OFF control active

[MENU LOCK PASSWORD] operations

To initialize your password, consult your distributor.

List of compatible signals

The following table specifies the type of signals compatible with the projectors.
This projector supports the signal with ✓ in the compatible signal column.

- Symbols that indicate formats are as follows.

- V : VIDEO
- R : RGB
- Y : YC_BC_R/YP_BP_R
- H : HDMI

- Input corresponding to each item in the plug and play column is as follows.

- COMPUTER: COMPUTER1 / COMPUTER2 input
- HDMI: HDMI1 / HDMI2 input

Signal name	Display resolution (dots)	Scanning frequency		Dot clock frequency (MHz)	Format	Plug and play*1	
		H (kHz)	V (Hz)			COMPUTER	HDMI
NTSC/NTSC4.43/ PAL-M/PAL60	720 x 480i	15.7	59.9	—	V	—	—
PAL/PAL-N/SECAM	720 x 576i	15.6	50.0	—	V	—	—
480/60i	720 x 480i	15.7	59.9	13.5	R/Y	—	—
576/50i	720 x 576i	15.6	50.0	13.5	R/Y	—	—
480/60i	720 (1 440) x 480i ²	15.7	59.9	27.0	H	—	—
576/50i	720 (1 440) x 576i ²	15.6	50.0	27.0	H	—	—
480/60p	720 x 480	31.5	59.9	27.0	R/Y/H	—	✓
576/50p	720 x 576	31.3	50.0	27.0	R/Y/H	—	✓
720/60p	1 280 x 720	45.0	60.0	74.3	R/Y/H	—	✓
720/50p	1 280 x 720	37.5	50.0	74.3	R/Y/H	—	✓
1080/60i	1 920 x 1 080i	33.8	60.0	74.3	R/Y/H	—	✓
1080/50i	1 920 x 1 080i	28.1	50.0	74.3	R/Y/H	—	✓
1080/24p	1 920 x 1 080	27.0	24.0	74.3	R/Y/H	—	✓
1080/24sF	1 920 x 1 080i	27.0	48.0	74.3	R/Y/H	—	—
1080/25p	1 920 x 1 080	28.1	25.0	74.3	R/Y/H	—	—
1080/30p	1 920 x 1 080	33.8	30.0	74.3	R/Y/H	—	—
1080/60p	1 920 x 1 080	67.5	60.0	148.5	R/Y/H	—	✓
1080/50p	1 920 x 1 080	56.3	50.0	148.5	R/Y/H	—	✓
640 x 400/70	640 x 400	31.5	70.1	25.2	R/H	—	—
640 x 400/85		37.9	85.1	31.5	R/H	—	—
640 x 480/60	640 x 480	31.5	59.9	25.2	R/H	✓	✓
640 x 480/67		35.0	66.7	30.2	R/H	—	—
640 x 480/73		37.9	72.8	31.5	R/H	✓	✓
640 x 480/75		37.5	75.0	31.5	R/H	✓	✓
640 x 480/85		43.3	85.0	36.0	R/H	—	—
800 x 600/56	800 x 600	35.2	56.3	36.0	R/H	✓	✓
800 x 600/60		37.9	60.3	40.0	R/H	✓	✓
800 x 600/72		48.1	72.2	50.0	R/H	✓	✓
800 x 600/75		46.9	75.0	49.5	R/H	✓	✓
800 x 600/85		53.7	85.1	56.3	R/H	—	—
832 x 624/75	832 x 624	49.7	74.6	57.3	R/H	✓	✓
1024x768/50	1 024 x 768	39.6	50.0	51.9	R/H	—	—
1024x768/60		48.4	60.0	65.0	R/H	✓	✓
1024x768/70		56.5	70.1	75.0	R/H	✓	✓
1024x768/75		60.0	75.0	78.8	R/H	✓	✓
1024x768/82		65.5	81.6	86.0	R/H	—	—
1024x768/85		68.7	85.0	94.5	R/H	—	—
1024x768/100		81.4	100.0	113.3	R/H	—	—
1152 x 864/60	1 152 x 864	53.7	60.0	81.6	R/H	—	—
1152 x 864/75		67.5	75.0	108.0	R/H	—	—
1152 x 864/85		77.1	85.0	119.7	R/H	—	—
1152 x 870/75	1 152 x 870	68.7	75.1	100.0	R/H	✓	✓

Chapter 7 Appendix - Technical information

Signal name	Display resolution (dots)	Scanning frequency		Dot clock frequency (MHz)	Format	Plug and play*1	
		H (kHz)	V (Hz)			COMPUTER	HDMI
1280 x 720/50	1 280 x 720	37.1	49.8	60.5	R/H	—	—
1280 x 720/60		44.8	59.9	74.5	R/H	—	—
1280 x 768/60 ³	1 280 x 768	47.7	60.0	80.1	R/H	—	—
1280 x 768/60		47.8	59.9	79.5	R/H	—	—
1280 x 768/75		60.3	74.9	102.3	R/H	—	—
1280 x 768/85		68.6	84.8	117.5	R/H	—	—
1280 x 800/50		41.3	50.0	68.0	R/H	—	—
1280 x 800/60	1 280 x 800	49.7	59.8	83.5	R/H	✓*4	✓*4
1280 x 800/75		62.8	74.9	106.5	R/H	—	—
1280 x 800/85		71.6	84.9	122.5	R/H	—	—
1280 x 960/60		1 280 x 960	60.0	60.0	108.0	R/H	—
1280 x 1024/60	1 280 x 1 024	64.0	60.0	108.0	R/H	—	—
1280 x 1024/75		80.0	75.0	135.0	R/H	✓	✓
1280 x 1024/85		91.1	85.0	157.5	R/H	—	—
1366 x 768/50	1 366 x 768	39.6	49.9	69.0	R/H	—	—
1366 x 768/60 ³		47.7	60.0	84.7	R/H	—	—
1366 x 768/60		47.7	59.8	85.5	R/H	—	—
1400 x 1050/60 ³	1 400 x 1 050	65.2	60.0	122.6	R/H	—	—
1400 x 1050/60		65.3	60.0	121.8	R/H	—	—
1400 x 1050/75		82.2	75.0	155.9	R/H	—	—
1440 x 900/50 ³	1 440 x 900	46.3	50.0	87.4	R/H	—	—
1440 x 900/60 ³		55.9	60.0	106.5	R/H	—	—
1440 x 900/60		55.9	59.9	106.5	R/H	—	—
1600 x 900/50 ³	1 600 x 900	46.3	50.0	97.0	R/H	—	—
1600 x 900/60 ³		55.9	60.0	119.0	R/H	—	—
1600 x 1200/60	1 600 x 1 200	75.0	60.0	162.0	R/H	✓	✓
1680 x 1050/50	1 680 x 1 050	54.1	50.0	119.5	R/H	—	—
1680 x 1050/60 ³		65.2	60.0	147.1	R/H	—	—
1680 x 1050/60		65.3	60.0	146.3	R/H	—	—
1920 x 1080/50	1 920 x 1 080	55.6	49.9	141.5	R/H	—	—
1920 x 1080/60 ⁵		66.6	59.9	138.5	R/H	—	—
1920 x 1080/60 ⁶		67.2	60.0	173.0	R	—	—
1920 x 1200/50	1 920 x 1 200	61.8	49.9	158.3	R/H	—	—
1920 x 1200/60 ⁵		74.0	60.0	154.0	R/H	✓*7	✓*7
1920 x 1200/60 ⁶		74.6	59.9	193.3	R	—	—

*1 Signal with ✓ in the plug and play column is a signal described in the EDID (extended display identification data) of the projector. The signal that does not have ✓ in the plug and play column can also be input if it is described in the format column. The resolution may not be selected in the computer even if the projector is compatible with the signal that does not have ✓ in the plug and play column.

*2 Pixel-Repetition signal (dot clock frequency 27.0 MHz) only

*3 When inputting appropriate analog signal, it can be displayed by making the setting suitable for the signal from the [PICTURE] menu → [RGB-SYSTEM]. For digital signal, the [RGB-SYSTEM] setting is unnecessary.

*4 Only for PT-VW540

*5 VESA CVT-RB (Reduced Blanking)-compliant

*6 Samples the pixels in the image processing circuit and displays the image.

*7 Only for PT-VZ580

Note

- A signal with a different resolution is converted to the number of display dots. The number of display dots is as follows.
 - PT-VZ580: 1 920 x 1 200
 - PT-VW540: 1 280 x 800
 - PT-VX610: 1 024 x 768
- The “i” at the end of the resolution indicates an interlaced signal.
- When interlaced signals are connected, flickering may occur on the projected image.
- Even the above signals exist, some image signals recorded in special method may not be displayed.

Specifications

The specifications of this projector are as follows.

Power supply		120 V ~ (120 V alternating current), 50 Hz/60 Hz (For North America) 100 V - 240 V ~ (100 V - 240 V alternating current), 50 Hz/60 Hz (For other countries)	
Power consumption		PT-VZ580	400 W (3.8 A) for North America 410 W (4.7 A - 2.0 A) for other countries
		PT-VW540, PT-VX610	385 W (3.6 A) for North America 400 W (4.5 A - 2.0 A) for other countries
Power consumption (during standby)		When [STANDBY MODE] is set to [ECO]	approx. 0.3 W for North America approx. 0.5 W for other countries
		When [STANDBY MODE] is set to [NORMAL] and [IN STANDBY MODE] of [AUDIO SETTING] is set to [OFF]: approx. 8 W	
LCD panel	Size	PT-VZ580	1.63 cm (0.64") (aspect ratio 16 : 10)
		PT-VW540	1.63 cm (0.64") (aspect ratio 16 : 10)
		PT-VX610	1.6 cm (0.63") (aspect ratio 4 : 3)
	Display system	Translucent screen LCD panel 3 panels, 3 primary color system	
	Drive system	Active matrix	
Number of pixels	PT-VZ580	2 304 000 pixels (1 920 x 1 200 dots) x 3 panels	
	PT-VW540	1 024 000 pixels (1 280 x 800 dots) x 3 panels	
	PT-VX610	786 432 pixels (1 024 x 768 dots) x 3 panels	
Lens		PT-VZ580	Manual zoom: 1.6x Focus : F 1.6 - 2.12, f 15.30 mm - 24.64 mm
		PT-VW540, PT-VX610	Manual zoom: 1.6x Focus : F 1.6 - 1.9, f 15.31 mm - 24.64 mm
Luminous lamp		280 W, UHM lamp	
Light output *1		PT-VZ580	5 000 lm
		PT-VW540	5 500 lm
		PT-VX610	5 500 lm
		(When [PICTURE MODE] is set to [DYNAMIC], [LAMP POWER] is set to [NORMAL], [DAYLIGHT VIEW] is set to [OFF], and [AUTO POWER SAVE] is set to [OFF])	
Center to corner zone ratio*1		85 %	
Contrast ratio *1		16 000:1 (When [PICTURE MODE] is set to [DYNAMIC], [LAMP POWER] is set to [NORMAL], [IRIS] is set to [ON], [DAYLIGHT VIEW] is set to [OFF], and [AUTO POWER SAVE] is set to [OFF])	
Color system		7 (NTSC, NTSC4.43, PAL, PAL-N, PAL-M, SECAM, PAL60)	
Projected image size		0.76 m - 7.62 m (30"-300")	
image aspect ratio		PT-VZ580, PT-VW540	16:10
		PT-VX610	4:3
Projection method		[FRONT/CEILING], [FRONT/DESK], [REAR/CEILING], [REAR/DESK]	
Speaker		4.0 cm, round, x 1	
Maximum usable volume output		10 W (monaural)	
Power cord length		2.0 m (78-3/4")	
Outer case		Molded plastic	
Outer color		White	
Dimensions	Width	389 mm (15-5/16")	
	Height	125 mm (4-29/32") (with legs at shortest position)	
	Depth	332 mm (13-1/16")	
Weight		Approx. 4.8 kg (10.6 lbs.) *2	
Noise level *1		When [LAMP POWER] is set to [NORMAL]: 37 dB	
		When [LAMP POWER] is set to [ECO1]: 35 dB	
		When [LAMP POWER] is set to [ECO2]: 29 dB	

Chapter 7 Appendix - Specifications

Operating environment	Operating environment temperature	0 °C (32 °F) to 40 °C (104°F) ^{3,4}
	Operating environment humidity	20 % to 80 % (no condensation)
Remote control	Power supply	DC 3 V (AAA/R03 or AAA/LR03 battery x 2)
	Operation range	Within approx. 7 m (22'11") (when operated directly in front of signal receiver)
	Weight	63 g (2.22 ozs.) (including batteries)
	Dimension	Width: 44 mm (1-23/32"), Length: 105 mm (4-1/8"), Height: 20.5 mm (13/16")

*1 Measurement, measuring conditions and method of notation all comply with ISO/IEC 21118:2012 international standards.

*2 This is an average value. It may differ depending on individual product.

*3 The operating environment temperature becomes 0 °C (32 °F) to 30 °C (86 °F) when using at a sea level between 1 200 m (3 937') ~ 2 700 m (8 858').

*4 When the projector is used with the [PROJECTOR SETUP] menu → [LAMP POWER] set to [NORMAL], the [LAMP POWER] will be forcibly switched to [ECO1] to protect the projector if the operating environment temperature exceeds 35 °C (95 °F).

Note

- The part numbers of accessories and separately sold components are subject to change without notice.

■ Connecting terminals

<COMPUTER 1 IN>	1 set, high-density D-Sub 15 p (female) RGB signal 0.7 V [p-p] 75 Ω (When G-SYNC: 1.0 V [p-p] 75 Ω) HD/SYNC TTL high impedance, automatic positive/negative polarity compatible VD TTL high impedance, automatic positive/negative polarity compatible Y_BP_R signal Y: 1.0 V [p-p] including synchronization signal, P _B P _R : 0.7 V [p-p] 75 Ω
<COMPUTER 2 IN/ 1 OUT>	1 set, high-density D-Sub 15 p (female), monitor output compatible RGB signal 0.7 V [p-p] 75 Ω (When G-SYNC: 1.0 V [p-p] 75 Ω) HD/SYNC TTL high impedance, automatic positive/negative polarity compatible VD TTL high impedance, automatic positive/negative polarity compatible Y_BP_R signal Y: 1.0 V [p-p] including synchronization signal, P _B P _R : 0.7 V [p-p] 75 Ω
<VIDEO IN>	1 set, pin jack 1.0 V [p-p] 75 Ω
<HDMI 1 IN> / <HDMI 2 IN>	2 sets, HDMI 19 pin, HDCP and Deep Color compatible Audio signal Linear PCM (Sampling frequency: 48 kHz/44.1 kHz/32 kHz)
<AUDIO IN 1> / <AUDIO IN 2>	2 sets, M3 stereo mini jack, 0.5 V [rms], input impedance 22 kΩ and more
<AUDIO IN 3>	1 set, Pin jack x 2 (L-R), 0.5 V [rms], input impedance 22 kΩ and more
<VARIABLE AUDIO OUT>	1 set, M3 stereo mini jack, monitor output and stereo compatible, 0 V [rms] to 2.0 V [rms] variable, output impedance 2.2 kΩ and less
<SERIAL IN>	1 set, D-sub 9 pin (female), RS-232C compliant, for computer control use
<LAN>	1 set, RJ-45, for network connection, PLink compatible, 10Base-T/100Base-TX
<DC OUT>	1 set, USB connector (type A), for power supply (DC 5 V, maximum 2 A)

■ **Compatible signals**

For details of the types of video signals that can be used with the projector, refer to “List of compatible signals” (➡ page 126).

VIDEO signal input
Horizontal: 15.73 kHz Vertical: 59.94 Hz, Horizontal: 15.63 kHz Vertical: 50 Hz
RGB signal input
<ul style="list-style-type: none"> • Signal resolution: 640 x 400 to 1 920 x 1 200 • Dot clock frequency: 162 MHz or less • PIAS (Panasonic Intelligent Auto Scanning) mode
Y_CC_R/Y_PP_R signal input
<ul style="list-style-type: none"> • Signal resolution: 480i/576i to 1 920 x 1 080 • Dot clock frequency: 148.5 MHz or less • HD/SYNC and VD terminals do not support 3 value SYNC.
HDMI signal input
<ul style="list-style-type: none"> • Moving image signal resolution: 480i^{*1}/576i^{*1} to 1 920 x 1 080 • Still image signal resolution: 640 x 400 to 1 920 x 1 200 (non-interlace) • Dot clock frequency: 25 MHz to 162 MHz

*1 Only for Pixel-Repetition signal (Dot clock frequency is 27.0 MHz)

Dimensions

Unit: mm (inch)

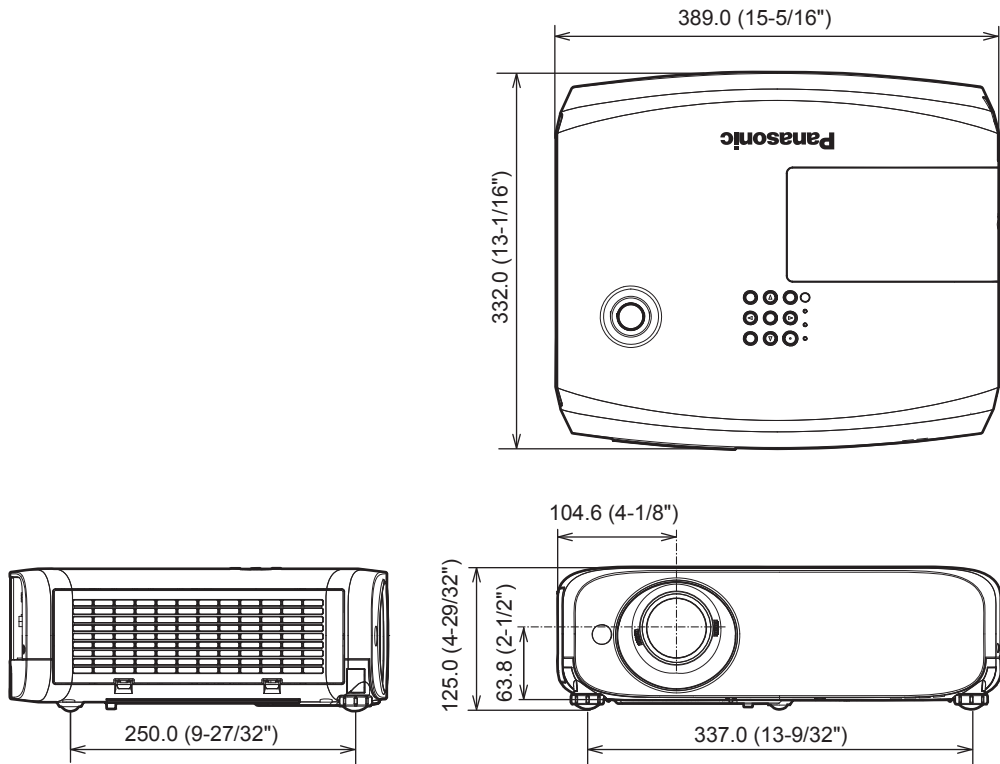

* Actual dimension may differ by product.

Ceiling mount bracket safeguards

- When installing the projector to a ceiling, be sure to use the specified optional Ceiling Mount Bracket.
 - Model No. of ceiling mount bracket:**
 - ① ET-PKL100S (for low ceilings); ET-PKV400B (Projector mount bracket)
 - ② ET-PKL100H (for high ceilings); ET-PKV400B (Projector mount bracket)
- When installing the projector, attach the drop-prevention kit included with the Ceiling Mount Bracket.
- Ask a qualified technician to do the installation work such as mounting the projector on the ceiling.
- Panasonic takes no responsibility for any damage to the projector resulting from use of a ceiling mount bracket not manufactured by Panasonic or the inappropriate choice of location for installation, even if the warranty period of the projector has not expired.
- Unused products must be removed promptly by a qualified technician.
- Use a torque screwdriver or Allen torque wrench to tighten bolts to their specified tightening torques. Do not use electric screwdrivers or impact screwdrivers.
- Read the Installation Instructions for the Ceiling Mount Bracket for details.
- The model numbers of accessories and optional accessories are subject to change without prior notice.

■ Screw hole specifications for ceiling mount (Bottom view)

Unit: mm (inch)

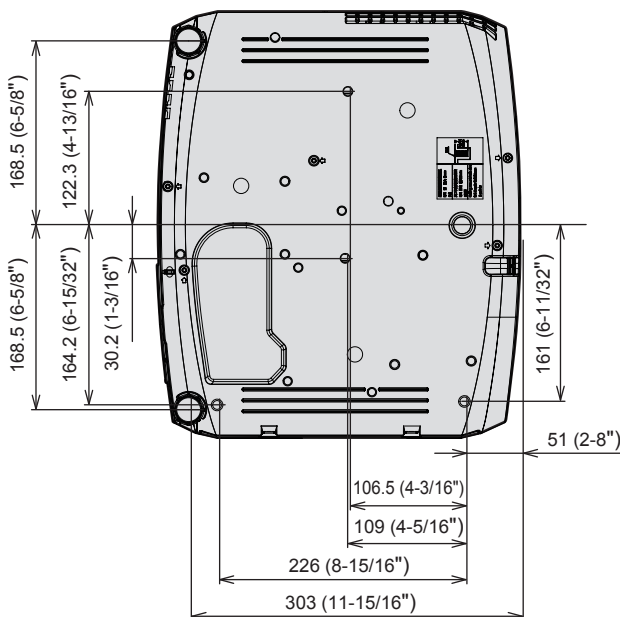
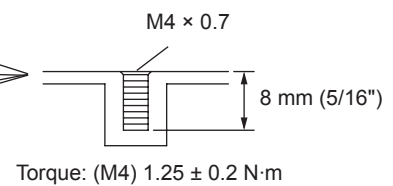
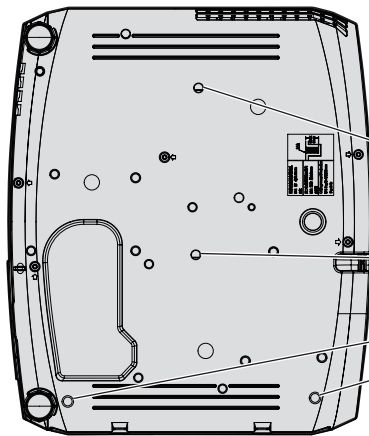

Index

- A**
- Accessing from the web browser94
 - Accessories20
 - <AC IN> terminal23, 38
 - [ASPECT]67
 - Attaching the lens cap27
 - [AUDIO SETTING]82
 - <AUTO SETUP> button
 - Projector body24, 49
 - Remote control22, 49
 - [AUTO SETUP SETTING]75
 - <AV MUTE> button
 - Remote control22, 48
- B**
- [BACK COLOR]75
 - Basic operations by using the remote control48
 - [BRIGHTNESS]57
- C**
- Cautions on use19
 - CD-ROM21
 - Ceiling mount bracket safeguards132
 - [CLOCK PHASE]66
 - [CLOSED CAPTION SETTING]73
 - [COLOR]57
 - [COLOR ADJUSTMENT]70
 - [COLOR CORRECTION]71
 - [COLOR TEMPERATURE]58
 - <COMPUTER 1> button
 - Remote control22
 - <COMPUTER 2> button
 - Remote control22
 - [COMPUTER2 SELECT]78
 - Connecting34
 - Connecting the power cord38
 - [CONTRAST]57
 - [CONTROL DEVICE SETUP]88
 - [Crestron Connected(TM)]106
- D**
- [DAYLIGHT VIEW]59
 - [DC OUT]85
 - <DEFAULT> button
 - Remote control22, 54
 - [DIGITAL CINEMA REALITY]59
 - Dimensions131
 - [DISPLAY OPTION]70
 - Disposal18
 - [DOT CLOCK]66
 - <D.ZOOM +/-> buttons
 - Remote control22, 50
- E**
- Early Warning Software18
 - [ECO MANAGEMENT]80
 - [EMULATE]81
 - <ENTER> button
 - Projector body24
 - Remote control22
- F**
- [FILTER COUNTER]84
 - [FRAME LOCK]68
 - <FREEZE> button
 - Remote control22, 49
 - <FUNCTION> button
 - Remote control22, 50
 - [FUNCTION BUTTON]82
- G**
- [GAMMA]59
- H**
- <HDMI 1> button
 - Remote control22
 - <HDMI 2> button
 - Remote control22
 - [HDMI SIGNAL LEVEL]73
- I**
- <ID ALL> button
 - Remote control22, 51
 - <ID SET> button
 - Remote control22, 51
 - [INITIALIZE]90
 - [INITIALIZE ALL]85
 - [INITIAL START UP]79
 - <INPUT SELECT> button
 - Projector body24
 - Installation mode29
 - [IRIS]59
- L**
- Lamp indicator24, 110
 - [LAMP POWER]79
 - [LANGUAGE]69
 - List of compatible signals126
- M**
- Main menu54
 - Maintenance/replacement111
 - <MENU> button
 - Projector body24
 - Remote control22
 - [MENU LOCK]87
 - [MENU LOCK PASSWORD]87, 125
 - Menu Navigation53
 - <MUTE> button
 - Remote control22, 48
- N**
- [NETWORK]89
 - Network connection92
 - [NETWORK CONTROL]89
 - [NETWORK STATUS]90
 - [NOISE REDUCTION]60
 - Number buttons
 - Remote control22
- O**
- [ON-SCREEN DISPLAY]71
 - Optional accessories21
 - [OTHER FUNCTIONS]76
 - [OVER SCAN]67
- P**
- [PASSWORD]86
 - [PASSWORD CHANGE]86
 - [PICTURE]57
 - [PICTURE MODE]57
 - PJLink protocol119
 - [POSITION]62
 - Power button
 - Projector body24
 - Remote control22
 - Power indicator24, 38
 - Precautions for use16
 - Projecting44
 - [PROJECTION METHOD]79
- Projector body23
- [PROJECTOR ID]78
 - [PROJECTOR NAME]89
 - [PROJECTOR SETUP]78
 - [P-TIMER]75
 - <P-TIMER> button
 - Remote control22, 51
- R**
- Read this first!4
 - [REALTIME KEYSTONE]62
 - Remote control22
 - <RETURN> button
 - Remote control22
 - [RGB-SYSTEM]60
 - [RGB/Y_PP_r] / [RGB/YC_BC_r]60
- S**
- <SCREEN ADJ> button
 - Remote control22, 49
 - [SCREEN ADJUSTMENT]62
 - [SCREEN SETTING]74
 - Security18
 - [SECURITY]86
 - <SERIAL IN> terminal122
 - Setting up29
 - [SHARPNESS]58
 - [SHIFT]65
 - [SIGNAL SEARCH]75
 - Specifications128
 - [STARTUP LOGO]74
 - [STATUS]78
 - Storage18
 - Sub menu55
 - Switching off the projector42
 - Switching on/off the projector38
 - Switching on the projector39
- T**
- Temperature indicator24, 110
 - [TEST PATTERN]83
 - [TEXT CHANGE]87
 - [TEXT DISPLAY]87
 - [TINT]58
 - Troubleshooting117
 - [TV-SYSTEM]60
- V**
- <VIDEO> button
 - Remote control22
 - <VOL +/-> button
 - Remote control48
- W**
- [WIRED LAN]89

Disposal of Old Equipment and Batteries

Only for European Union and countries with recycling systems



These symbols on the products, packaging, and/or accompanying documents mean that used electrical and electronic products and batteries must not be mixed with general household waste. For proper treatment, recovery and recycling of old products and used batteries, please take them to applicable collection points in accordance with your national legislation.

By disposing of them correctly, you will help to save valuable resources and prevent any potential negative effects on human health and the environment.

For more information about collection and recycling, please contact your local municipality. Penalties may be applicable for incorrect disposal of this waste, in accordance with national legislation.



Note for the battery symbol (bottom symbol)

This symbol might be used in combination with a chemical symbol. In this case it complies with the requirement set by the Directive for the chemical involved.

Information on Disposal in other Countries outside the European Union

These symbols are only valid in the European Union.

If you wish to discard these items, please contact your local authorities or dealer and ask for the correct method of disposal.

Product Information (for Turkey only)



AEEE Yönetmeliğine Uygundur.

Eski Ekipman ve Bataryaların İşlenmesi.

Sadece geri dönüşüm sistemleri olan Avrupa Birliği ve ülkeleri için geçerlidir.

Ürünler, ambalaj ve/veya ekli belgeler üzerindeki bu semboller kullanılmış elektrik ve elektronik ürünlerin ve pillerin genel ev atığı ile karıştırılmaması gerektiğini ifade eder.

Eski ürünlerin ve pillerin toplanması ve geri kazanılması için bu atıkları lütfen yasayla belirlenmiş olan uygun toplama merkezlerine teslim ediniz.

Bu atıkların doğru işlenmesiyle, değerli kaynakların korunmasına ve insan sağlığı ve çevreye olası negatif etkilerinin engellenmesine yardımcı olabilirsiniz.

Atıkların toplanması ve geri dönüşümü için detaylı bilgi için lütfen bağlı olduğunuz yerel yönetimlerle iletişime geçiniz.

Atıkların atılmasıyla ilgili yanlış uygulamalar yasayla belirlenmiş olan cezalara sebebiyet verebilir.

Panasonic Corporation

Web Site: <https://panasonic.net/cns/projector/>

© Panasonic Corporation 2017

Panasonic System Communications Company of North America

5th Floor, Two Riverfront Plaza, Newark, NJ 07102-5490

TEL: (877) 803 - 8492

Panasonic Canada Inc.

5770 Ambler Drive, Mississauga, Ontario L4W 2T3

TEL: (905) 624 - 5010