

# EIKI

---

## OWNER'S MANUAL

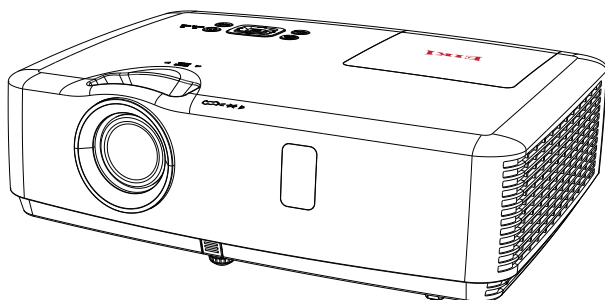

EK-103X

---

## Features and Design

---

This Projector is designed with the most advanced technology for portability, durability, and ease of use. This projector utilizes built-in multimedia features, a palette of 10.7 million colors, and matrix liquid crystal display (LCD) technology.

### **Simple Computer System Setting**

---

The projector has the Multi-scan system to conform to almost all computer output signals quickly. Up to WUXGA resolution can be accepted.

### **Useful Functions for Presentations**

---

The digital zoom function allows you to focus on the crucial information during a presentation.

### **Lamp Control**

---

Brightness of the projection lamp can be selected.

### **Logo Function**

---

The Logo function allows you to customize the screen logo.

### **Multilanguage Menu Display**

---

The screen menu of the projector is available in 26 languages: English, German, French, Italian, Spanish, Polish, Swedish, Dutch, Portuguese, Japanese, Simplified Chinese, Traditional Chinese, Korean, Russian, Arabic, Turkey, Finland, Norway, Denmark, Indonesia, Hungary, Czech Republic, Kazakhstan, Vietnamese, Thai, Farsi.

### **Helpful Maintenance Functions**

---

Lamp and filter maintenance functions provide for better and proper maintenance of the projector.

### **Security Function**

---

The Security function helps you to ensure security of the projector. With the Key lock function, you can lock the operation on the top control or remote control. PIN code lock function prevents unauthorized use of the projector.

### **Auto Setup Function**

---

This function enables input source search, auto pc adjust by simple pressing the AUTO button.

### **Colorboard Function**

---

At the time of simple projection on the colored wall, you can get the close color image to the color image projected on a white screen by selecting the similar color to the wall color from the preset four colors.

### **Power Management**

---

The Power management function reduces power consumption and maintains the lamp life.

### **Closed Caption**

---

This is a printed version of the program sound or other information displayed on the screen. You can turn on the feature and switch the channels.

✓ *Note:*

- *The screen menu and pictures in the manual may slightly differ from the real product.*
- *The manual is subject to change without prior notice.*

# Contents

Features and Design .....	2	Color adjust .....	30
Contents .....	3	Image Mode .....	30
Safety Instructions .....	4	Color adjust (Computer).....	31
Safety Guide .....	5	Color adjust (Video,S-video,Component) .....	32
Air circulation .....	6	Setting .....	33
Moving the projector .....	6	On start .....	33
Installing the projector properly.....	6	Standby mode.....	33
Compliance.....	7	High land.....	34
Accessories .....	8	Lamp control .....	34
Part names and functions.....	9	Cooling fast.....	34
Front.....	9	Closed Caption .....	35
Back.....	9	Key lock .....	35
Bottom.....	9	HDMI setup.....	36
Terminals .....	10	Expand .....	37
Top control and Indicators .....	11	Language.....	37
Remote control.....	12	Auto setup.....	37
Install remote control batteries.....	13	Keystone .....	38
Operating range .....	13	Logo .....	39
Installation .....	14	Security.....	40
Positioning the projector .....	14	Power management .....	41
Adjustable foot .....	14	Filter counter .....	41
Connecting to computer (Digital and analog RGB) .....	15	Test Pattern .....	42
Connecting to video equipment (Video, S-Video) .....	16	Factory default .....	42
Connecting the AC power cord .....	17	Lamp counter reset.....	42
Basic operation.....	18	Information.....	43
Turn on the projector .....	18	Maintenance and cleaning.....	44
Turn off the projector.....	19	WARNING indicator.....	44
Adjust zoom and focus.....	20	Cleaning the filter.....	45
Auto setup function.....	20	Filter counter reset.....	45
Keystone .....	20	Clean the projector lens.....	46
Remote control operation.....	21	Clean the cabinet.....	46
Input select.....	23	Replace the lamp.....	47
How to operate the screen menu.....	24	Order Replacement lamp.....	48
Menu bar.....	25	Appendix.....	49
Display .....	26	Troubleshooting .....	49
Auto PC adj.....	26	Menu Tree.....	51
Fine sync.....	26	Indicator and projector state .....	54
H Position.....	26	Compatible computer specifications .....	55
V Position.....	26	Technical Specifications .....	56
H.Size .....	26	Configurations of terminals .....	57
Aspect.....	27	Content of hazardous substances and elements.....	58
Project Way.....	27	Dimensions .....	58
Menu Position .....	28	PIN code memorandum.....	59
Background Display.....	28		
System.....	29		

# Safety Instructions

Please read this manual completely before installing and operating the projector.

The projector provides many convenient features and functions. Proper operation may enable you to fully utilize the features and keep it in good condition. Otherwise, it will not only shorten the service life of the unit, but also may cause malfunction, a fire, or other accidents.

If your projector cannot work properly, please read this manual again, check the operating methods and cable connection, and try the solutions in the part of Troubleshooting. If the problem still exists, contact the dealer or the service center.

The lamp of the projector is a wearing part. The luminance may decrease after a period of operation and be weaker than that of a new lamp. This is normal. Please strictly follow the steps in Turning on the unit and Turning off the unit to turn on/off the projector, and the requirements in Maintaining and cleaning the projector to service and clean the projector regularly. Otherwise the high temperature residual heat may not radiate, greatly shorten the service life of the projector and lamp, or even damage them within a short period.

<div style="display: inline-block; background-color: black; color: white; padding: 5px; text-align: center; font-weight: bold; margin: 0 10px;"> <b>Caution</b>  <b>ELECTRIC SHOCK</b>  <b>DO NOT OPEN</b> </div>
<p><b>CAUTION:</b>  <b>TO REDUCE THE RISK OF ELECTRIC SHOCK, DO NOT REMOVE COVER (OR BACK). NO USER SERVICEABLE PARTS INSIDE EXCEPT LAMP REPLACEMENT. REFER SERVICING TO QUALIFIED SERVICE PERSONNEL.</b></p>
<p> THIS SYMBOL INDICATES THAT DANGEROUS VOLTAGE CONSTITUTING A RISK OF ELECTRIC SHOCK IS PRESENT WITHIN THIS UNIT.</p>
<p> THIS SYMBOL INDICATES THAT THERE ARE IMPORTANT OPERATING AND MAINTENANCE INSTRUCTIONS IN THE USER'S MANUAL WITH THIS UNIT.</p>

#### FOR EU USERS

The symbol mark and recycling systems described below apply to EU countries and do not apply to countries in other areas of the world.

Your product is designed and manufactured with high quality materials and components which can be recycled and/or reused.

The symbol mark means that electrical and electronic equipment, batteries and accumulators, at their end of life, should be disposed of separately from your household waste.

Note:

If a chemical symbol is printed beneath the symbol mark, this chemical symbol means that the battery or accumulator contains a heavy metal at a certain concentration. This will be indicated as follows: Hg: mercury, Cd: cadmium, Pb: lead. In the European Union there are separate collection systems for used electrical and electronic equipment, batteries and accumulators.

Please dispose of them correctly at your local community waste collection/recycling centre. Please help us to conserve the environment we live in!



## Safety precautions

- Caution:**
- The projector must be grounded.
  - Do not expose the projector to raindrops or high humidity to avoid a fire or electric shock.
- This projector produces intense light from the projection lens. Avoid staring directly into the lens, otherwise eye damage could be caused. Be especially careful that children do not stare directly into the beam.
  - Place the projector in a proper position. Otherwise it may result in fire hazard.
  - Leave an appropriate space from the top, sides, and back of the shell in order to ventilate and cool down the projector. The figures below indicate the minimum distance to be left. It must be satisfied if the projector is placed in sealed environment like a cabinet.

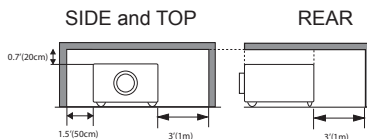

- Do not cover the vent of the projector. Poor radiation may shorten the service life or even cause dangers.
- Remove the AC power plug if the projector is not to be used for a long time.
- Do not project the same image for a long time; otherwise, a residual image may appear on the LCD panel due to its characteristic.



**Caution:**

Do not set the projector in greasy, wet, or smoky conditions such as in a kitchen, to prevent a malfunction or accident. If the projector comes in contact with oil or chemicals, it may become deteriorated.

Read and keep this manual for future reference.

The mains plug/appliance coupler is used as disconnect device, the disconnect device shall remain readily operable.



**Caution:**

### Contains mercury

For more information on safe handling procedures, the measures to be taken in case of accidental breakage and safe disposal options

visit: [ec.gc.ca/mercure-mercury/](http://ec.gc.ca/mercure-mercury/)

Dispose of or recycle in accordance with applicable laws.

# Safety Guide

All the safety and operating instructions should be read before the product is operated.

Read all of the instructions given here and retain them for later use. Unplug this projector from AC power supply before cleaning. Do not use liquid or aerosol cleaners.

Use a damp cloth for cleaning.

Follow all warnings and instructions marked on the projector.

For added protection to the projector during a lightning storm, or when it is left unattended and unused for long periods of time, unplug it from the wall outlet. This will prevent damage due to lightning and power line surges.

Do not expose this unit to rain or use near water... for example, in a wet basement, near a swimming pool, etc...

Do not use attachments not recommended by the manufacturer as they may cause hazards.

Do not place this projector on an unstable cart, stand, or table. The projector may fall, causing serious injury to a child or an adult, and serious damage to the projector.

Use only with a cart or stand recommended by the manufacturer, or sold with the projector. Wall or shelf mounting should follow the manufacturer's instructions, and should use a mounting kit approved by the manufacturers.

An appliance and cart combination should be moved with care. Quick stops, excessive force, and uneven surfaces may cause the appliance and cart combination to overturn.



Slots and openings in the back and bottom of the cabinet are provided for ventilation, to ensure reliable operation of the equipment and to protect it from overheating.

The openings should never be covered with cloth or other materials, and the bottom opening should not be blocked by placing the projector on a bed, sofa, rug, or other similar surface. This projector should never be placed near or over a radiator or heat register.

This projector should not be placed in a built-in installation such as a book case unless proper ventilation is provided.

Never push objects of any kind into this projector through cabinet slots as they may touch dangerous voltage points or short out parts that could result in a fire or electric shock. Never spill liquid of any kind on the projector.

Do not install the projector near the ventilation duct of air-conditioning equipment.

This projector should be operated only from the type of power source indicated on the marking label. If you are not sure of the type of power supplied, consult your authorized dealer or local power company.

Do not overload wall outlets and extension cords as this can result in fire or electric shock. Do not allow anything to rest on the power cord. Do not locate this projector where the cord may be damaged by persons walking on it.

Do not attempt to service this projector yourself as opening or removing Covers may expose you to dangerous voltage or other hazards. Refer all servicing to qualified service personnel.

Unplug this projector from wall outlet and refer servicing to qualified service personnel under the following conditions:

- When the power cord or plug is damaged or frayed.
- If liquid has been spilled into the projector.
- If the projector has been exposed to rain or water.
- If the projector does not operate normally by following the operating instructions. Adjust only those controls that are covered by the operating instructions as improper adjustment of other controls may result in damage and will often require extensive work by a qualified technician to restore the projector to normal operation.
- If the projector has been dropped or the cabinet has been damaged.
- When the projector exhibits a distinct change in performance-this indicates a need for service.

When replacement parts are required, be sure the service technician has used replacement parts specified by the manufacturer that have the same characteristics as the original part. Unauthorized substitutions may result in fire, electric shock, or injury to persons.

Upon completion of any service or repairs to this projector, ask the service technician to perform routine safety checks to determine that the projector is in safe operating condition.

## Information for users in the European Union

This is a device to project images onto a screen, etc., and is not intended for use as indoor lighting in a domestic environment. Directive 2009/125/EC.

## NOTE FOR CUSTOMERS IN THE US

 LAMP(S) INSIDE THIS PRODUCT CONTAIN MERCURY AND MUST BE RECYCLED OR DISPOSED OF ACCORDING TO LOCAL STATE OR FEDERAL LAWS.

## Safety Guide

### Air circulation

Vents in the cabinet are provided for ventilation. To ensure reliable operation of the product and to protect it from overheating, these openings must not be blocked or covered.



#### Caution

Hot air is exhausted from the exhaust vent. When using or installing the projector, the following precautions should be taken.

- Do not put any flammable objects, or spray can near the projector. Hot air is exhausted from the air vents.
- Keep the exhaust vent at least 1m away from any objects.
- Do not touch a peripheral part of the exhaust vent, especially screws and metallic part. This area will become hot while the projector is being used.
- Do not put anything on the projector. Objects put on the cabinet will not only get damaged but also may cause fire hazard by heat.
- Cooling fans are provided to cool down the projector.
- The fan's running speed is changed according to the temperature inside the projector.

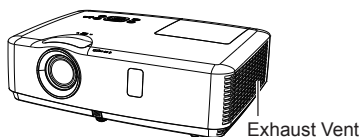

Exhaust Vent

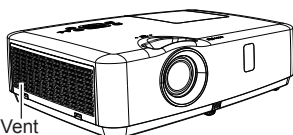

Air Intake Vent

### Moving the projector

When moving the projector, take care of the lens and retract the adjustable feet to prevent damage to the lens and cabinet.



#### Caution in moving or transporting the projector

- Do not drop or bump the projector, otherwise damages or malfunctions may result.
- When carrying the projector, use a suitable carrying case.

- Do not transport the projector by courier or any other transport service in an unsuitable transport case. This may cause damage to the projector. For more information about transporting the projector by courier or any other transport service, consult your dealer.
- Do not put the projector in a case before it is cooled enough.

### Installing the projector properly

Please set the projector on nearly-level. Be sure to install the projector properly. Improper installation may reduce the lamp lifetime and even cause a fire hazard.

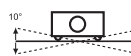
 Do not roll the projector over 10° from side to side.

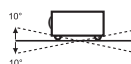
 Do not pitch the projector more than 10° backward and forward.



Do not point the projector up to project an image.



Do not point the projector down to project an image.



Do not put the projector on either side to project an image.

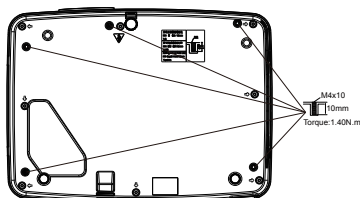

#### Caution in ceiling installation the projector

- Only qualified personal is authorized for ceiling installation.
- We are not responsible for the hurt and damage caused by ceiling bracket that purchased from unauthorized dealer even in warranty period.
- Remove the ceiling bracket immediately while not use.
- While installing, torque screwdriver is suggested, don't use electric or impact-type screwdriver.
- Please read the manual of bracket for details.

# Compliance

## FCC Caution

Note: This equipment has been tested and found to comply with the limits for a Class B digital device, pursuant to Part 15 of the FCC Rules. These limits are designed to provide reasonable protection against harmful interference in a residential installation. This equipment generates, uses, and can radiate radio frequency energy, and if not installed and used in accordance with the instructions, may cause harmful interference to radio communications. However, there is no guarantee that interference will not occur in a particular installation. If this equipment does cause harmful interference to radio or television reception, which can be determined by turning the equipment off and on, the user is encouraged to try to correct the interference by one or more of the following measures:

- Reorient or relocate the receiving antenna.
  - Increase the separation between the equipment and receiver.
  - Connect the equipment into an outlet on a circuit different from that to which the receiver is connected.
  - Consult the dealer or an experienced radio/TV technician for help.
- Use of shielded cable is required to comply with class B limits in Subpart B of Part 15 of FCC Rules. Do not make any changes or modifications to the equipment unless otherwise specified in the instructions. If such changes or modifications should be made, you could be required to stop operation of the equipment.

Model Number : EK-100 series

Trade Name : EIKI

Responsible party : EIKI International, Inc.

Address : 30251 Esperanza Rancho Santa Margarita CA 92688-2132

Telephone No. : 800-242-3454 (949-457-0200)

## AC Power Cord Requirement

The AC Power Cord supplied with this projector meets the requirement for use in the country you purchased it.

### AC Power Cord for the United States and Canada:

AC Power Cord used in the United States and Canada is listed by the Underwriters Laboratories (UL) and certified by the Canadian Standard Association (CSA).

AC Power Cord has a grounding-type AC line plug. This is a safety feature to be sure that the plug will fit into the power outlet. Do not try to defeat this safety feature. Should you be unable to insert the plug into the outlet, contact your electrician.

### AC Power Cord for the United Kingdom:

This cord is already fitted with a moulded plug incorporating a fuse, the value of which is indicated on the pin face of the plug. Should the fuse need to be replaced, an ASTA approved BS 1362 fuse must be used of the same rating, marked thus  $\diamond$ . If the fuse cover is detachable, never use the plug with the cover omitted. If a replacement fuse cover is required, ensure it is of the same colour as that visible on the pin face of the plug (i.e. red or orange). Fuse covers are available from the Parts Department indicated in your User Instructions.

If the plug supplied is not suitable for your socket outlet, it should be cut off and destroyed.

The end of the flexible cord should be suitably prepared and the correct plug fitted.

**WARNING : A PLUG WITH BARED FLEXIBLE CORD IS HAZARDOUS IF ENGAGED IN A LIVE SOCKET OUTLET.**

The Wires in this mains lead are coloured in accordance with the following code:

Green-and-yellow . . . . . Earth  
Blue . . . . . Neutral  
Brown . . . . . Live

As the colours of the wires in the mains lead of this apparatus may not correspond with the coloured markings identifying the terminals in your plug proceed as follows:

The wire which is coloured green-and-yellow must be connected to the terminal in the plug which is marked by the letter E or by the safety earth symbol  $\perp$  or coloured green or green-and-yellow.

The wire which is coloured blue must be connected  $\perp$  to the terminal which is marked with the letter N or coloured black.

The wire which is coloured brown must be connected to the terminal which is marked with the letter L or coloured red.

**WARNING: THIS APPARATUS MUST BE EARTHED.**

**THE SOCKET-OUTLET SHOULD BE INSTALLED NEAR THE EQUIPMENT AND EASILY ACCESSIBLE.**

---

# Accessories

---

AC Power cord

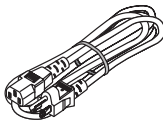

VGA cable

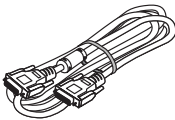

Remote control with batteries  
(AAA or LR3)



Quick start guide

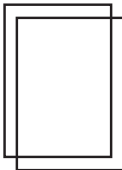

Safety Information

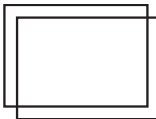



## Part names and functions

### Front

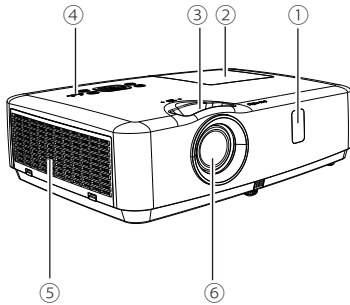

- ① Remote control receiver
- ② Lamp cover
- ③ Focus adjust ring
- ④ Top control panel and indicator
- ⑤ Filter
- ⑥ Projector Lens

### Back

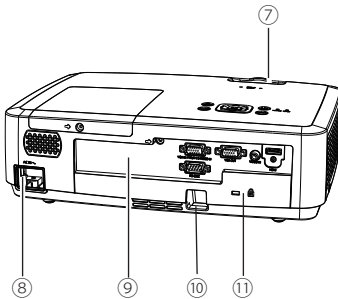

- ⑦ Zoom adjust ring
- ⑧ AC cord connector
- ⑨ Terminals
- ⑩ Anti-theft bar
- ⑪ Kensington Security Slot

### Bottom

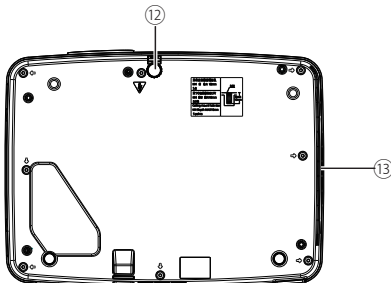

- ⑫ Adjustable foot
- ⑬ Exhaust vent



### Caution

*Hot air is exhausted from the exhaust vent. Do not put heat-sensitive objects near this side.*

## Part names and functions

### Terminals

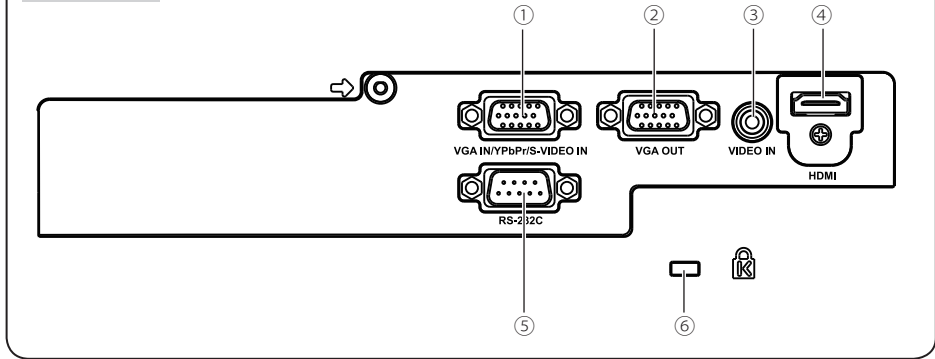

① **VGA IN/YPbPr/S-VIDEO IN**

This is the terminal to input RGB, YPbPr or S-video signals.

② **VGA OUT**

Output the analog signal from ① to other monitor.

③ **VIDEO IN**

This is the terminal to input video signals.

④ **HDMI**

This is the terminal to input HDMI signals.

⑤ **RS-232C**

When using RS232 to control the projector, please connect the serial control line to this terminal.

⑥ **Kensington Security Slot**

This slot is for a Kensington lock used to deter theft of the projector.

\* Kensington is a registered trademark of ACCO Brands Corporation

## Part names and functions

### Top control and Indicators

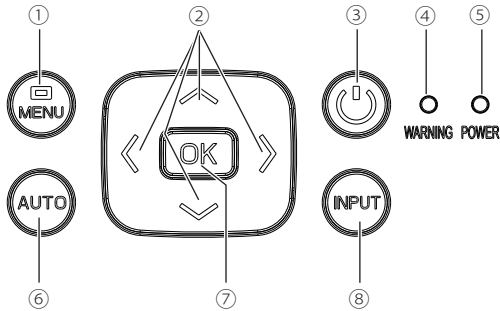

#### ① MENU

Open or close the screen menu.

#### ② ▲▼◀▶

- Select an item or adjust the value in the screen menu.
- Select the image display area in digital zoom + mode.

#### ③ POWER

Turn on/off the projector.

#### ④ WARNING indicator(Refer to Page 54)

- It flashes red when the internal projector temperature is beyond the operating temperature range.
- It lights red when the power supply of the projector is abnormal.

#### ⑤ POWER indicator(Refer to Page 54)

- It lights red when the projector is in stand-by mode.
- It lights green during normal operations.
- It flashes green in the Power management mode.
- It flashes red during fans cooling.

#### ⑥ AUTO

Perform various settings configured automatically, including the "Input search" and "Auto PC adj.".

#### ⑦ OK

- Enter menu operation.
- Execute the selected item.

#### ⑧ INPUT

Select an input source.

## Part names and functions

### Remote control

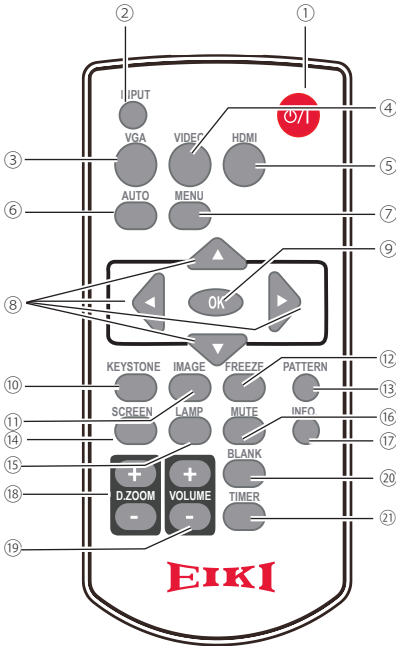

- ① **POWER**  
Turn on or turn off the projector.
- ② **INPUT**  
Open or close the input source menu.
- ③ **VGA**  
Select "Computer 1" as input source.
- ④ **VIDEO**  
Select "Video" as input source.
- ⑤ **HDMI**  
Select "HDMI" as input source.
- ⑥ **AUTO**  
Enter auto setup adjust mode.
- ⑦ **MENU**  
Open or close the screen menu.
- ⑧ **▲▼◀▶ button**  
- Select an item or adjust the value in the screen menu.  
- Select the image display area in digital zoom + mode.
- ⑨ **OK**  
Enter the menu or select an item in the menu.
- ⑩ **KEYSTONE**  
Correct the keystone distortion.
- ⑪ **IMAGE**  
Select the image mode.
- ⑫ **FREEZE**  
Freeze the projected image.
- ⑬ **PATTERN**  
Set the internal test image.
- ⑭ **SCREEN**  
Select the screen size.
- ⑮ **LAMP**  
Select the lamp mode.
- ⑯ **MUTE**  
This function is not available for this model.
- ⑰ **INFO.**  
Display the projector information.
- ⑱ **D.ZOOM + / -**  
Digital zoom in / zoom out the image.
- ⑲ **VOLUME + / -**  
This function is not available for this model.
- ⑳ **BLANK**  
Temporarily close the image on the screen.
- ㉑ **TIMER**  
Enable the timer function.

## Part names and functions

### Install remote control batteries

- ① Open the battery cover.



- ② Install new batteries.

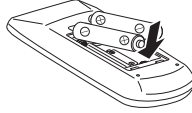

Two AAA batteries  
For correct polarity  
(+ and -), be sure  
battery terminals  
are in contact  
with pins in the  
compartment.

- ③ Put the cover back.

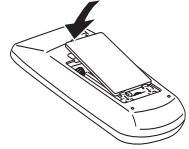

To ensure safe operation, please observe the following precautions:

- Use two (2) AAA or LR3 type alkaline batteries.
- Always replace batteries in sets.
- Do not use a new battery with a used battery.
- Avoid contact with water or liquid matter.
- Do not expose the remote control to moisture or heat.
- Do not drop the remote control.
- If the battery has leaked in the remote control, carefully wipe the case clean and install new batteries.
- Risk of explosion if two batteries are replaced by an incorrect type.
- Dispose of used batteries according to the instructions on the battery or local regulations or guides.

### Operating range

Point the remote control toward the remote control receivers on the projector when pressing any button.

The maximum operating range for the remote control is about 5 meters and 60 degrees.

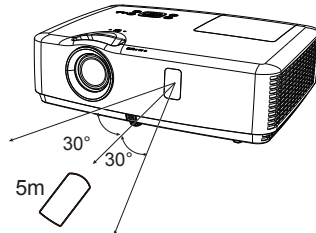

# Installation

## Positioning the projector

✓ Note:

- The brightness in a room has a great influence on picture quality. It is recommended to limit the ambient lighting in order to get the best image.
- All measurements are approximate and may vary from the actual sizes.

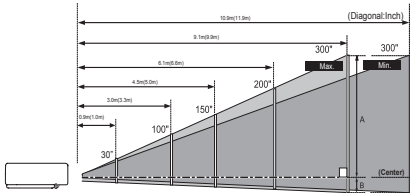

✓ Note:

The data in "( )" is the project distance for 16:9 aspect ratio.

### 4:3

Screen size (WxH)mm	30"	100"	150"	200"	300"
4:3 aspect ratio	610x457	2032x1524	3048x2286	4064x3048	6096x4572
Maximum	0.9m	3.0m	4.5m	6.1m	9.1m
Minimum	1.1m	3.6m	5.5m	7.3m	10.9m

### 16:9

Screen size (WxH)mm	30"	100"	150"	200"	300"
16:9 aspect ratio	664x374	2214x1245	3321x1868	4428x2491	6641x3736
Maximum	1.0m	3.3m	5.0m	6.6m	9.9m
Minimum	1.2m	4.0m	6.0m	7.9m	11.9m

## Adjustable foot

The projector can be adjusted up to 40 mm (10 degree) with the adjustable foot.

Rotate the adjustable foot to lift the projector to a certain height. During lifting, rotate the foot clockwise.

To lower or retract the adjustable foot, rotate the foot counterclockwise.

Keystone distortion of projected images can be corrected by manually, remote control operation or menu operation.

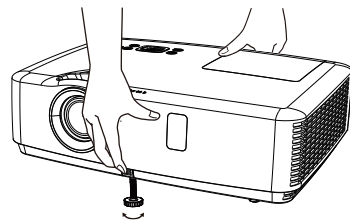

Adjustable foot

## Installation

### Connecting to computer (Digital and analog RGB)

Cables used for connection:

- VGA cable
- HDMI cable\*

- Serial cable(crossover type)\*

(\*=Cables are not supplied with the projector)

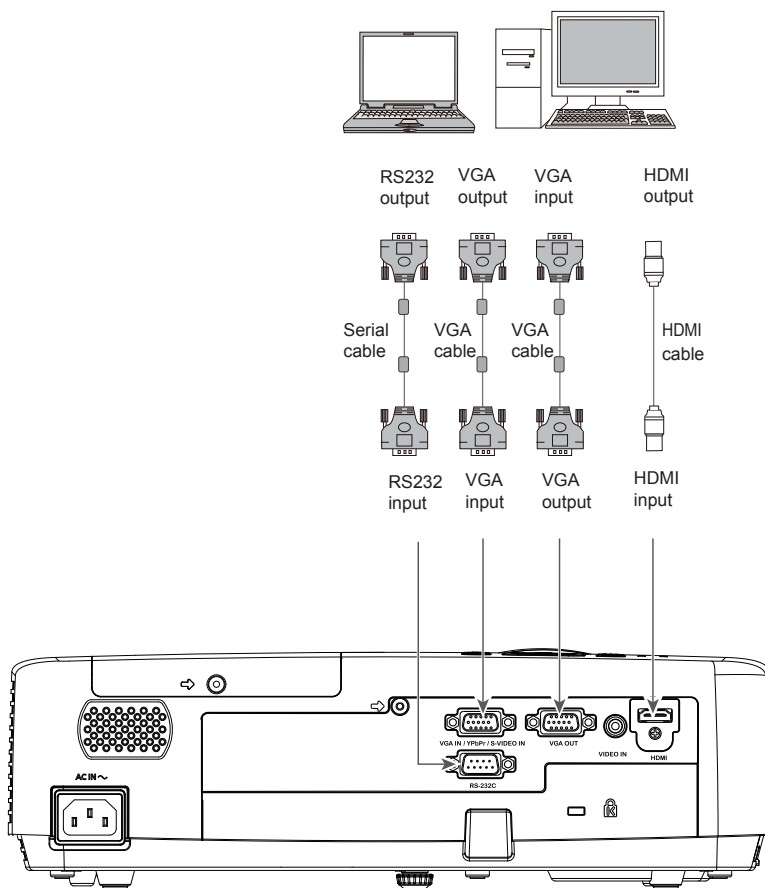

*Unplug the power cords of both the projector and external equipment from the AC outlet before connecting the cables.*

## Installation

### Connecting to video equipment (Video, S-Video)

Cables used for connection:

- S-video cable\*\*
- Video cable\*
- Component conversion cable\*\*

(\*=Cables are not supplied with the projector)

\*\*=Dedicated cable is required and can be ordered through your dealer)

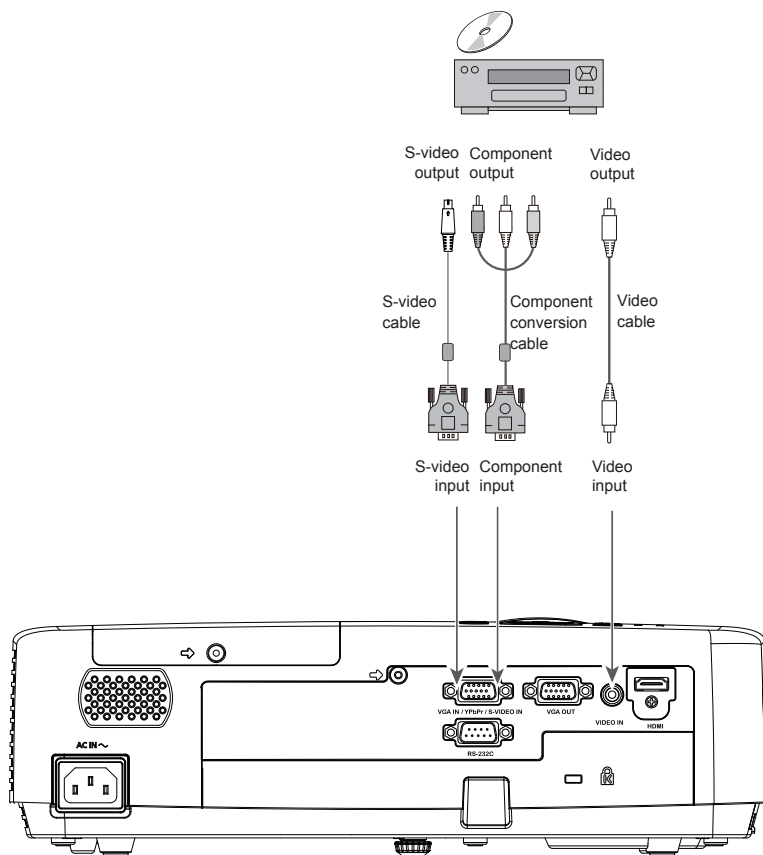

*Unplug the power cords of both the projector and external equipment from the AC outlet before connecting the cables.*



## Installation

### Connecting the AC power cord

This projector uses nominal input voltages of 100–240V AC and it automatically applies to different input voltages. It is designed to work with a single-phase power system having a grounded neutral conductor. To reduce the risk of electrical shock, do not plug into any other type of power system. If you are not sure of the type of power being supplied, consult your authorized dealer or service station. Connect the projector with all peripheral equipment before turning it on.

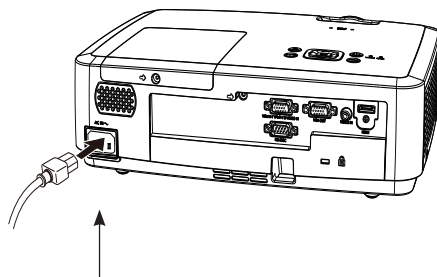

Connect the AC power cord (supplied) to the projector.



Note:

The AC outlet should be near this equipment and must be easily accessible.

✓ Note:

For safety, unplug the AC power cord when the projector is not in use. When the projector is connected to an outlet with AC power cord, it is in stand-by mode and consumes a little electric power.

#### Note on the power cord

AC power cord must meet the requirements of the country where you use the projector. Confirm the AC plug type with the chart below and proper AC power cord must be used. If the supplied AC power cord does not match your AC outlet, contact your sales dealer.

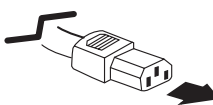
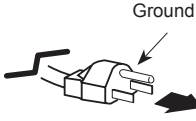
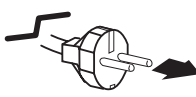
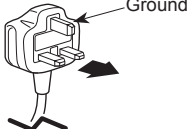
Projector side	AC outlet side		
	For the U.S.A. and Canada	For Continental Europe	For the U.K.
 To power cord connector on your projector.	 To the AC outlet.	 To the AC outlet.	 To the AC outlet.

✓ Note:

- Using incorrect power cord may influence the product performance, or even cause hazards like an electric shock or fire. To ensure the product performance and security, please apply the cable of the same model with the original one.

## Basic operation

### Turn on the projector

1. Complete peripheral connections (with a computer, video, etc.) before turning on the projector.
2. Connect the projector's AC power cord into the AC outlet. The POWER indicator turns red.
3. Press the POWER button on the top control or on the remote control. The POWER indicator becomes green and the cooling fans start to work. The preparation display appears on the screen.
4. If the projector is locked with a PIN code, a PIN code input dialog box appears. Enter the PIN code as instructed below.

✓ Note:

- When the logo select is set to be "Off", the logo will not be displayed on the screen. (See page 39)

Enter a PIN code

Press the OK button, press ◀▶ button to select a number and press the OK button to enter it to the PIN code box, then number changes to "\*", automatically move the cursor to next box. If you fixed an incorrect number, press MENU button to reset it again. Repeat the steps to complete entering a three-digit number.

After entering the three-digit number, automatically move the cursor to "Set", press the OK button then you can start to operate the projector.

If you entered an incorrect "PIN code", the number (\*\*\*) turn red. PIN code will be reset within one second automatically, Enter the correct PIN code all over again.

What is PIN code?

PIN (Personal Identification Number) code is a security code that allows the person who knows it to operate the projector. Setting the PIN code can prevent unauthorized use of the projector. A PIN code consists of a three-digit number. Refer to the PIN code lock function in the "Expand" "Security" menu on page 40 for PIN code lock operation of the projector.

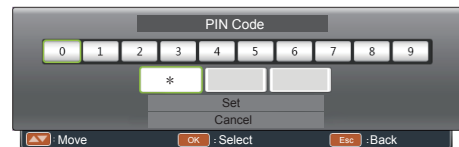

Move the cursor to "Set", and press "OK".



**Caution on handling the PIN code**  
If you forget your PIN code, the projector can no longer be started. Take a special care in setting a new PIN code. Write down the number in a column on page 59 of this manual and keep it properly. Should the PIN code be missing or forgotten, consult your dealer or service center.

## Basic operation

### Turn off the projector

1. Press the POWER button on the top control or on the remote control, and "Power off?" appears on the screen.
2. Then, press the POWER button again in 4 seconds. The POWER indicator starts to flash red, and the cooling fans keep running (You can select the fan noise and running speed). Now you can unplug the AC power cord after the fans stop running. Otherwise, the service life of the projector will be affected or the projector will not be turned on or turn on abnormal.
3. When the projector has cooled down enough to be turned on again, the POWER indicator stops flashing.

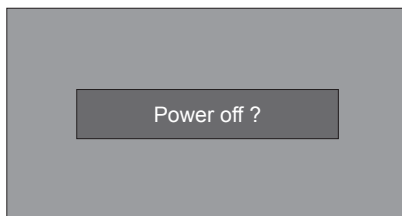

"Power off ?" disappears after 4 seconds.

 *To maintain the lamp life, once you turn the projector on, wait at least 5 minutes before turning it off.*

 *Do not operate the projector continuously without reset. Continuous use may result in shortening the lamp life. Turn off the projector and let it standby for about an hour in every 24 hours.*

✓ *Note:*

- *When the On start function is "On" , this projector is turned on automatically by connecting the AC power cord to an AC outlet .*
- *The running speed of cooling fans is changed according to the temperature inside the projector.*
- *Do not put the projector in a case before it is cooled enough.*
- *If the POWER indicator flashes or emits a red light, see page 54.*
- *While the POWER indicator is flashing, the lamp is being cooled down and the projector cannot be turned on. Wait until the POWER indicator turns red to turn on the projector again.*
- *The fan rotation will terminate directly if the AC power cord is unplugged immediately after the projector is turned off.*
- *The projector can be turned on after the POWER indicator turns red. The waiting time to restart will be shortened when the normal power-off processing for fan cooling is completed, comparing with the time the AC power cord is immediately unplugged after the power-off.*

## Basic operation

### Adjust zoom and focus

Rotate the ZOOM ring to zoom in or zoom out the image.

Rotate the FOCUS ring to adjust the focus of the image.

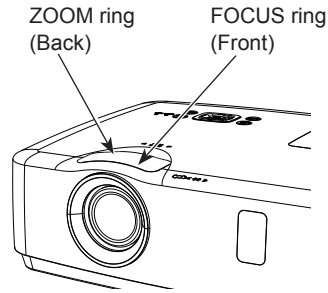

### Auto setup function

This function is available just by pressing the AUTO button on the remote control or top control.

The system then automatically performs various settings in the "Expand" menu, including "Input search" and "Auto PC adj."

### Keystone

If a projected image has keystone distortion, follow the steps below to manually correct the keystone distortion.

Press KEYSTONE button on the remote control. The Keystone screen will displayed, press ▲▼ to adjust the image.

#### V Keystone

Adjusts when the vertical trapezoid of the projected image is distorted.

### V Keystone



- The arrows are white when there is no correction.
- The arrows that are used for correction turns red.
- Press ▲▼ button long time, the arrows turn red and can be adjusted quickly
- The arrows disappear at the maximum correction.
- If you press the KEYSTONE button on the remote control once again while the keystone dialog box is being displayed, the keystone adjustment is canceled.
- The adjustable range can be limited depending on the input signal.

#### Top control



#### Remote control

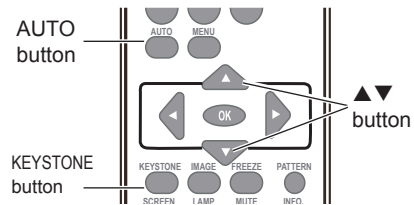

## Basic operation

### Remote control operation

Using the remote control for some frequently used operations is advisable. Just pressing one of the buttons enables you to quickly without calling up the screen menu.

#### **FREEZE** button

Press FREEZE button on the remote control, video will be paused and the audio is muted. The icon is displayed on the screen during Freeze. Press FREEZE button again, the video playback resumes and the audio is unmuted.

#### **IMAGE** button

Press IMAGE button on the remote control to select the image mode you want. (Dynamic / Standard / Cinema / Blackboard (Green) / Colorboard / User Image)

#### **LAMP** button

Press LAMP button to select a lamp mode to change the brightness of the screen.

- 💡 Normal ...Normal brightness.
- 💡 ECO ..... Lower brightness, reducing the lamp power consumption and extending the lamp life.

#### **INFO** button

Press INFO button on the remote control to display the projector information.

Remote control

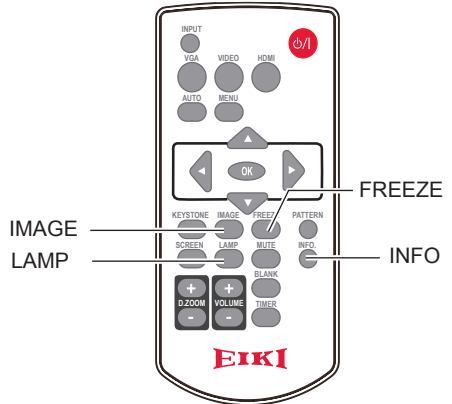

✓ *Note:*

*See the next page for the description of other buttons.*

## Basic operation

### BLANK button

Press BLANK button on the remote control to black out the image. To restore to normal, press the BLANK button again or press any other button.

The screen changes each time you press the button as follows:

Black out → Normal → Black out → Normal ...



“Blank” disappears after 2 seconds if there is no other button operation.

### TIMER button

Press TIMER button. The timer display “00:00” appears on the screen and the timer starts to count time (00:00–59:59).

To stop the Timer, press TIMER button. Press TIMER button again, and then the Timer display disappears.



Timer display

### SCREEN button

Press SCREEN button on the remote control to select the screen size you want.  
(Normal / Wide / Full)

### D.ZOOM+ button

Press D.ZOOM+ button, the on-screen menu will disappear while the information on digital zoom + appears.

Press ▲▼◀▶ to move the image horizontally and vertically.

The moving is effective only when the image is larger than the size of the screen.

### D.ZOOM- button

Press D.ZOOM- button, the on-screen menu will disappear while the information on digital zoom appears.

To return to normal size, select “SCREEN” button on the remote control to adjust screen size.

Remote control

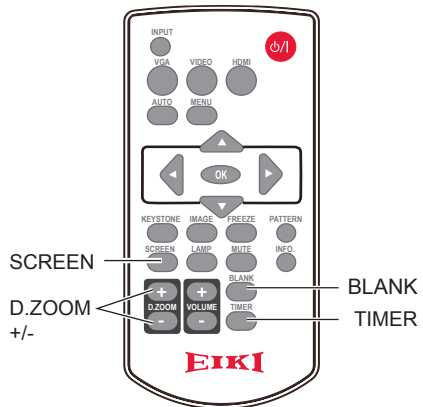

✓ Note:

- D.ZOOM doesn't work when the screen size is Full.

## Basic operation

### Input select

#### Direct Operation

Press VGA, VIDEO or HDMI on the remote control as input source.

#### Menu operation

1 Press INPUT button on the top control or remote control to display the input select menu.

2 Press ▲▼ button to select VGA, HDMI, Component, Video or S-video, then press the OK button.

#### Remote control

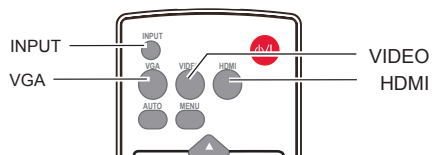

#### Top control

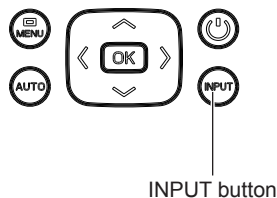

#### VGA

When input source is from computer connected to VGA terminal with VGA cable, please select "VGA"..

#### HDMI

When input source is from equipment connected to HDMI terminal with HDMI cable, please select "HDMI".

#### Component

Select it when the input source is from the video equipment connected to YPbPr terminal.

#### Video

Select it when the video input signal is connected to VIDEO IN terminal.

#### S-video

Select it when the video input signal is connected to S-VIDEO IN terminal.

#### Input select menu

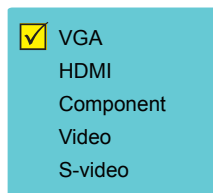

#### ✓Note:

- When the "Input search" function is set to "On" in the "Auto setup" function, press AUTO button, the input signal will be searched automatically.

## Basic operation

### How to operate the screen menu

The projector can be adjusted or set via the on-screen menu. Each main menu can be divided into several levels of submenus, and submenus are also divided into several levels of submenus.

For each adjustment and setting procedure, refer to the respective sections in this manual.

- 1 Press the MENU button on the remote control or top control to display the screen menu.
- 2 Press ▲▼ buttons to select an entry in the main menu and then press the OK button to enter the submenu.
- 3 Press ▲▼ buttons to select an item, and then press the OK button to set or enter the submenu.
- 4 Press ▲▼ buttons to adjust settings or switch among the items. Press the OK button for corresponding operation.
- 5 Press ◀ button on the remote control or top control to go back to the previous menu. Press MENU button again to exit the screen menu.

### Top control

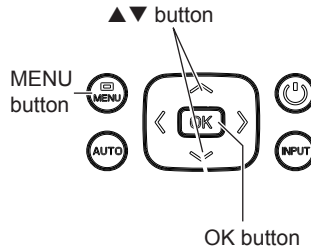

### Remote control

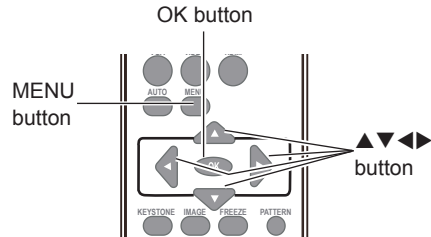

### Screen menu

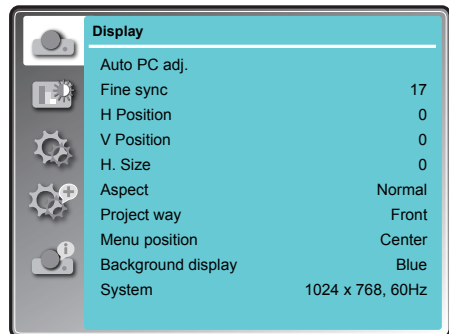



## Basic operation

### Menu bar

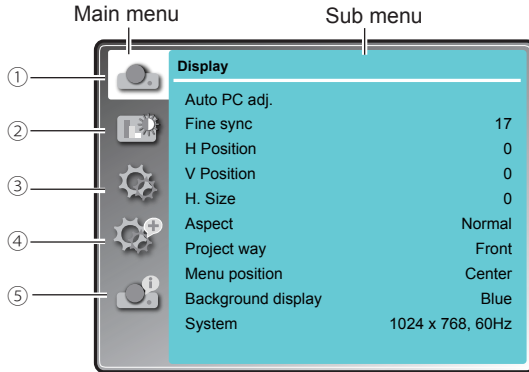

#### ① Display

- Adjust computer parameters to match with VGA input signal format: **Auto PC adj.**, **Fine sync**, **H Position**, **V Position** and **H.Size**.
- **Aspect: Normal** and **Wide**.
- **Project way**: select a project way among **Front**, **Rear**, **Ceiling/Front**, and **Ceiling/Rear**,
- **Menu position**: set the menu's position on the screen.
- **Background display**: set the background display color.
- **System**: select a system signal format to match the input source.

#### ② Color adjust

- **Image mode**: the available image modes are **Standard**, **Dynamic**, **User Image**, **Colorboard**, **Blackboard(Green)** or **Cinema**.
- Image color adjust:  
If a computer is selected as a signal source, the following image adjusting options are available: **Contrast**, **Brightness**, **Color temp.**, **White balance (R/G/B)** and **Sharpness**.  
If video equipment is selected as a signal source, the following image adjusting options are available: **Contrast**, **Brightness**, **Color**, **Tint**, **White balance (R/G/B)** and **Sharpness**.

#### ③ Setting

Configure basic operation settings of the projector: **On start**, **Standby mode**, **High land**, **Lamp control**, **Cooling fast**, **Closed caption**, **Key lock** and **HDMI setup**.

#### ④ Expand

Configure expand operation settings of the projector: **Language**, **Auto setup**, **Keystone**, **Logo**, **Security**, **Power management**, **Filter counter**, **Test Pattern**, **Factory default** and **Lamp counter**.

#### ⑤ Info.

The system information of the projector.

# Display

## Auto PC adj.

Auto PC Adjustment function is provided to automatically adjust Fine sync, Horizontal, Vertical and H.Size to conform to your computer.

Menu operation

Auto PC adj.

1. Press MENU button on the remote control or top control to display screen menu. Press ▲▼ button to select "Display", then press the OK button.
2. Press ▲▼ button to select "Auto PC adj.", then press the OK button. "Please wait" will be displayed on the screen, the Auto PC adj. function will be executed.

Auto PC adj. Menu

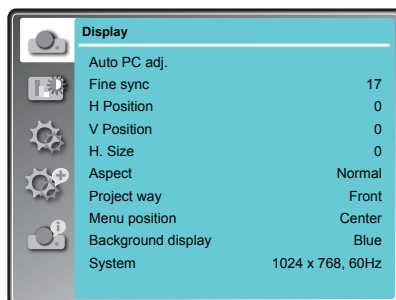

## Fine sync

You can cut off flicker from the image displayed by pressing ▲▼ to adjust the value.(from 0 to 31).

## H Position

Press ▲▼ to adjust the horizontal image position.

## V Position

Press ▲▼ to adjust the vertical image position.

## H.Size

This function is used to adjust and minimize the effect of interference caused by projection of patterns consisting of vertical stripes.

The projection of the vertical striped pattern may cause cyclic patterns (noise). Adjust to minimize the amount of interference.(From -15 to +15).

H.Size must be set before adjust Fine sync.

√ Note:

*The adjustment of Fine sync, H Position, V Position and H.Size is only for computer signal input.*

√ Note:

- The projector executes the Auto PC adj. automatically when the computer signals input the projector for the first time.
- Automatic adjustment may not work depending on the model of the computer and the input signal.
- The Auto PC adj. cannot be operated when 480i, 576i, 480p, 576p, 720p 1080i or 1080p is selected in the "Display" menu → "System", or when the signal is coming from the HDMI terminal.

# Display

## Aspect

You can set a screen size to fit the image while maintaining the aspect ratio of the input signal.

1. Press ▲▼ to select "Aspect" and then press the OK button.
2. Press ▲▼ button to select the item, then press the OK button.

### Normal

Projects the image at the maximum size while maintaining the aspect ratio of the input signal.

### Wide

Projects the image at 16:9 aspect ratio.

### Full

To provide an image to fit the screen.

### Advanced (PC input only)

Adjust the proportion and position of the screen manually.

## Aspect menu

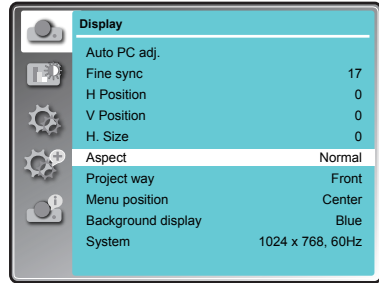

## Project Way

This function is used to set the project way.

- 1 Press MENU button on the remote control to display screen menu. Press ▲▼ button to select "Display", then press the OK button.
- 2 Press▲▼ button to select "Project way", press the OK button.
- 3 Press▲▼ button to select the item you want to set, press the OK button.

### Front

Projects to front screen when projector is front standing.

### Rear

Projects to rear screen when projector is front standing.

### Ceiling/Front

Projects to front screen when projector is in ceiling state.

### Ceiling/Rear

Projects to rear screen when projector is in ceiling state.

## Project way menu

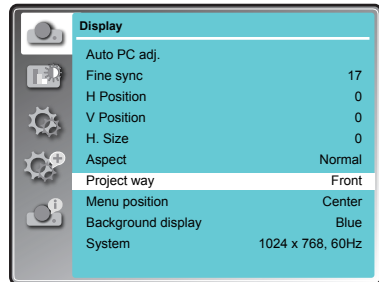

# Display

## Menu Position

This function is used to change the position of screen menu.

- 1 Press MENU button on the remote control to display screen menu. Press ▲▼ button to select "Display", then press the OK button.
- 2 Press ▲▼ button to select "Menu position", press the OK button.
- 3 Press ▲▼ button to select the item you want to set, press the OK button.

### Upper left

Menu locates on upper left of the screen.

### Upper right

Menu locates on upper right of the screen.

### Center

Menu locates at the center of the screen.

### Lower left

Menu locates on lower left of the screen.

### Lower right

Menu locates on lower right of the screen.

## Menu position

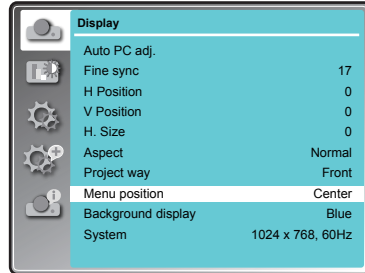

Display	
Auto PC adj.	
Fine sync	17
H Position	0
V Position	0
H. Size	0
Aspect	Normal
Project way	Front
Menu position	Center
Background display	Blue
System	1024 x 768, 60Hz

## Background Display

This function is used to select the screen background of the projector when there is no signal detected.

- 1 Press MENU button on the remote control or top control to display screen menu. Press ▲▼ button to select "Display", then press the OK button.
- 2 Press ▲▼ button to select "Background display", press the OK button.
- 3 Press ▲▼ button to select the item you want to set, press the OK button.

**Black** .... Select black background.

**Blue** ..... Select blue background.

## Background display

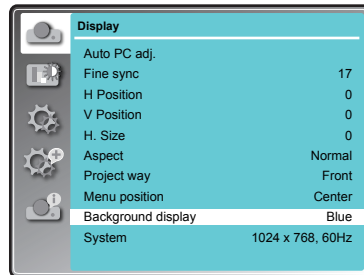

Display	
Auto PC adj.	
Fine sync	17
H Position	0
V Position	0
H. Size	0
Aspect	Normal
Project way	Front
Menu position	Center
Background display	Blue
System	1024 x 768, 60Hz

# Display

## System

### Computer system select

The projector automatically tunes to various types of computers with its function of Multi-scan system and Auto PC Adjustment. If a computer is selected as a signal source, the projector automatically detects the signal format and tunes to project proper images without any additional setting.

One of the following messages may appear:

Auto

When the projector cannot recognize the connected signal conforming to the provided computer system, Auto is displayed on the System menu box and the Auto PC Adj. function works to display proper images. If the image is not projected properly, a manual adjustment is required.

-----

There is no signal input from computer. Check the connection between your computer and projector.

### Select computer system manually

The system can also be selected manually.

- 1 Press MENU button on the remote control or on top control to display the screen menu. Press **▲▼** button to select the "Display" icon, and press the OK button.
- 2 Press **▲▼** button to select "System" and press the OK button.
- 3 Press **▲▼** button to select your required system, and then press the OK button.

✓ *Note:*

*When HDMI is selected, System menu for computer is disable.*

### Video or S-video

#### Auto

The projector automatically detects an incoming video system, and adjusts itself to optimize its performance. When Video System is PAL-M, PAL-N or PAL60, select the system manually.

#### **PAL/SECAM/NTSC/NTSC4.43/PAL-M/PAL-N/PAL60**

If the projector cannot reproduce proper video images, select a specific broadcast signal format from PAL, SECAM, NTSC, NTSC 4.43, PAL-M, PAL-N and PAL60.

### System menu

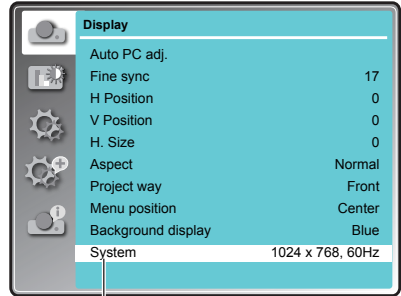

System

### System for computer signal

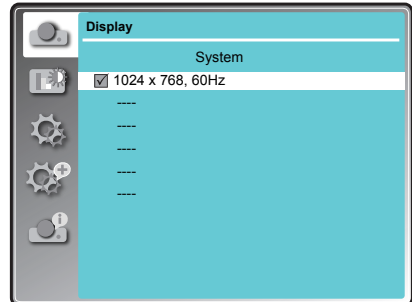

### System for Video or S-video signal

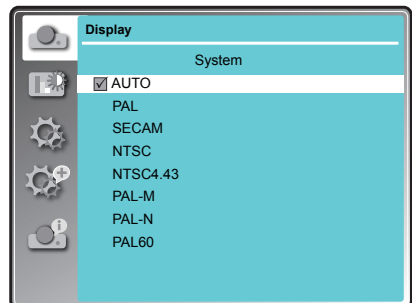

# Color adjust

Color adjust menu is used to set the image mode and adjust the image.

- 1 Press MENU button on the remote control or top control to display screen menu. Press ▲▼ button to select "Color adjust", then press the OK button.
- 2 Press▲▼ button to select the item you want to set, press the OK button.
- 3 Press▲▼ button to adjust the item, then press the OK button.

## Image Mode

Direct operation

Press IMAGE button on the remote control to select the image mode.

Menu operation

- 1 Press MENU button on the remote control or top control to display screen menu. Press ▲▼ button to select "Color adjust" menu, then press the OK button.
- 2 Press▲▼ button to select "Image mode", press the OK button.
- 3 Press▲▼ button to select the item you want to set, press the OK button.

Remote control

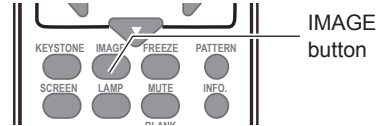

Image mode (Computer)

A screenshot of a television screen displaying the "Color adjust" menu. The menu is titled "Color adjust" and has a light blue background. On the left side, there are icons for a camera, a TV, a gear, a gear with a plus sign, and a gear with a minus sign. The menu items and their values are as follows:

Color adjust	
Image mode	Standard
Contrast	32
Brightness	32
Color temp.	Mid
Red	32
Green	32
Blue	32
Sharpness	8

### Dynamic

The light output is maximized for use in bright areas.

### Standard

The picture becomes suitable for moving images in general.

### Cinema

For watching movies with multiple gray scale levels.

### Blackboard (Green)

For viewing the image projected on a blackboard (green) by enhancing the image quality. This is mainly effective on a green colored board instead of a black colored board.

### Colorboard

For images projected onto a red, blue, yellow, or green wallpaper.

### User Image

Image quality preset by the user in the Image adjustment menu.

## Color adjust

### Color adjust (Computer)

- 1 Press MENU button on the remote control or top control to display screen menu. Press ▲▼ button to select "Color adjust", then press the OK button.
- 2 Press▲▼ button to select the item you want to set, press the OK button.
- 3 Press▲▼ button to adjust the data.

#### Contrast

Press ▼ to decrease the contrast and ▲ to increase it.

#### Brightness

Press ▼ to decrease the brightness and ▲ to increase it.

#### Color temp.

Press▲▼ to select color temperature.( Low, Mid and High )

#### Red (White balance)

Press ▼ to lighten the red tone and ▲ to deepen it.

#### Green (White balance)

Press ▼ to lighten the green tone and ▲ to deepen it.

#### Blue (White balance)

Press ▼ to lighten the blue tone and ▲ to deepen it.

#### Sharpness

Press ▼ to decrease the sharpness of the image and ▲ to increase it.

### Color adjust (Computer)

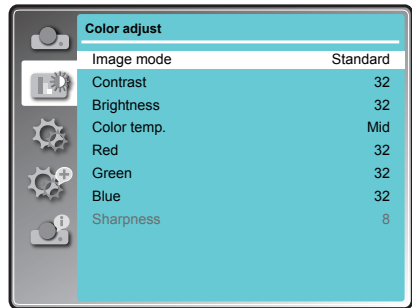

## Color adjust

### Color adjust (Video,S-video,Component)

- 1 Press MENU button on the remote control or top control to display screen menu. Press ▲▼ button to select "Color adjust", then press the OK button.
- 2 Press▲▼ button to select the item you want to set, press the OK button.
- 3 Press▲▼ button to adjust the data.

#### Contrast

Press ▼ to decrease the contrast and ▲ to increase it.

#### Brightness

Press ▼ to decrease the brightness and ▲ to increase it.

#### Color

Press ▼ to decrease the chroma and ▲ to increase it.

#### Tint

Press ▲▼ to select the appropriate tone for the image.

#### Red (White balance)

Press ▼ to lighten the red tone and ▲ to deepen it.

#### Green (White balance)

Press ▼ to lighten the green tone and ▲ to deepen it.

#### Blue (White balance)

Press ▼ to lighten the blue tone and ▲ to deepen it.

#### Sharpness

Press ▼ to decrease the sharpness of an image and ▲ to increase it.

### Color adjust (Video,S-video, Component)

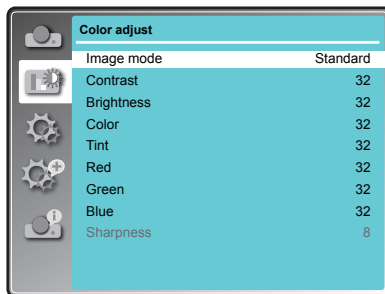

Color adjust	
Image mode	Standard
Contrast	32
Brightness	32
Color	32
Tint	32
Red	32
Green	32
Blue	32
Sharpness	8

√ Note:

- Signal input "Video", "S-video" or "Component", "Tint" is in grey, it is disable.
- If you only adjust projector to "Video", "S-video" or "Component", "Sharpness" is disable.



# Setting

The projector has "Setting" menu that allows you to set the other various functions described as follows.

- 1 Press MENU button on the remote control or top control to display screen menu. Press ▲▼ button to select "Setting", then press the OK button.
- 2 Press ▲▼ button to select the item you want to set, press the OK button.
- 3 Press ▲▼ button to adjust the item, then press the OK button.

## Setting menu

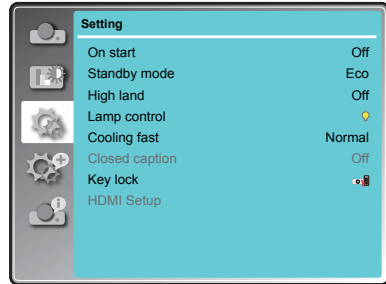

## On start

Enable the projector to be turned on automatically just by connecting the AC power cord to an outlet when this function is set to On.

### On

Start the projection immediately, enter countdown display.

### Off

Start up in the standby mode.

## On start

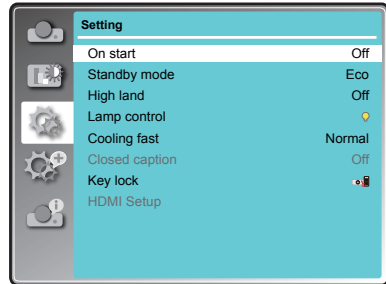

## Standby mode

This function is available when operating the projector via network.

Press ▲▼ button to select the item below:

### Eco.

Restrict some functions in the standby mode to reduce power consumption. In this case, you cannot use network functions and some RS-232C commands.

### Normal

Do not restrict network function and serial communication function even in the standby mode.

## Standby mode

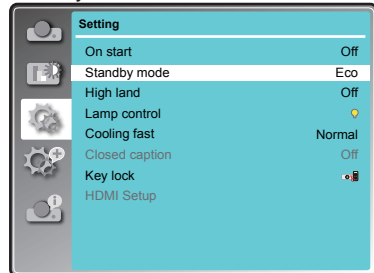

# Setting

## High land

Enable to control the fan through the Setting menu.

You can select the running speed of the fan according to the altitude of the location where the projector is installed.

### Off

Normal speed. Set it so if the projector is operated at a lower altitude.

### On

Faster than Off. Set it so if the projector is operated at a higher altitude as fans will produce weaker effects.

✓ *Note:*

*Please set High land "On" when operating the projector higher than 1400 meters.*

## High land

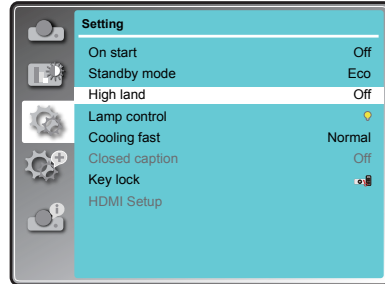

## Lamp control

Change the brightness of the screen.

Normal .... Normal brightness.

Eco ..... Lower brightness, reducing power consumption and extending the lamp life.

## Lamp control

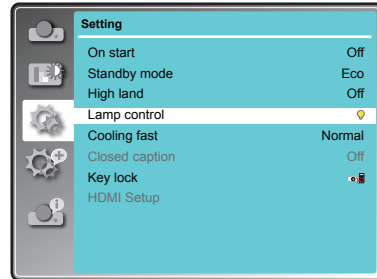

## Cooling fast

This function provides the following options in the cooling fans' operation after turning off the projector.

### Normal (90 sec)

Normal cooling speed.

### 60 sec

Faster and louder than Normal, cooling time is shorter.

### 0 sec

Enable you directly unplug the AC power cord after turning off the projector, no need waiting for cooling.

## Cooling fast

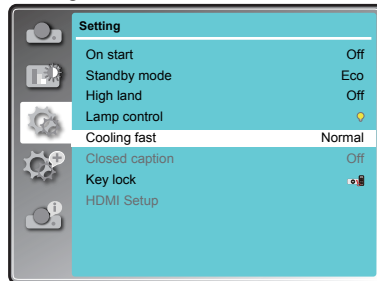

✓ *Note:*

*When it is set to "0 sec", you cannot restart the projector immediately after the power-off. The lamp remains high temperature and needs to be cooled, so it takes longer time than usual for the lamp to light up again.*

## Setting

### Closed Caption

Allows the subtitle to be displayed for the audio contents or other information. If the input source contains closed caption, you can enable this function and change the channel. Press ▲▼ to select Off, CC1, CC2, CC3 or CC4.

✓Note:

- The icon of Closed Caption is displayed in grey when it is disable.
- Closed caption is disable when screen menu or Timer displayed on screen.

### Closed Caption

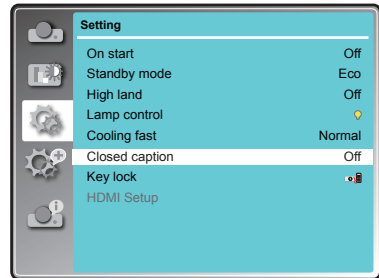

### Key lock

This function allows you to use the Key lock to set the security for the projector operation. Select "Key lock" and press the OK button, then press ▲▼ button to select the item you want.

### Key lock

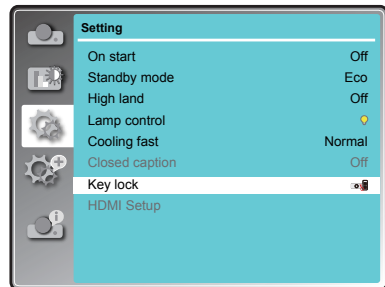

 Off ..... Unlock.

 **Projector**

Lock the operation of the top control. To unlock, use the remote control.

 **Remote Control**

Lock the operation of the remote control. To unlock, use the top control.

If the top control accidentally becomes locked and you do not have the remote control nearby or there is something wrong with your remote control, contact the dealer where you purchased the projector or the service center.

## Setting

### HDMI setup

When the external equipment is connected to "HDMI" terminal, if the image is not projected properly, please select the settings from the HDMI Setup menu.

- 1 Press the MENU button to display the screen menu. Press ▲▼ button to select the "Setting" menu icon. Press the OK to enter the submenu entry.
- 2 Press ▲▼ button to select "HDMI setup" and then press the OK button.
- 3 Press ▲▼ button to switch the item

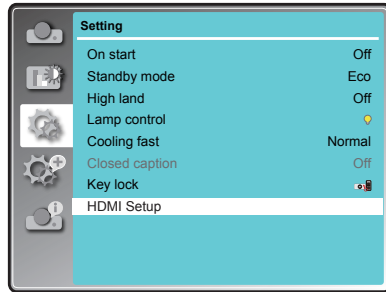

64-940 ..... Select when the HDMI terminal of an external device (such as a blu-ray player) is connected to the "HDMI" terminal.

0-1023 ..... Select when the DVI-D terminal output of an external device (such as a computer) is connected to the "HDMI" terminal via a conversion cable or similar cable. Select also when the HDMI terminal output of a computer or other device is connected to the "HDMI" terminal.

✓ *Note:*

*The optimal setting varies depending on the output setting of the connected external device. Refer to the operation instruction of the external device regarding the output of the external device.*

# Expand

The projector has Expand menu that allows you to set the other various expand functions described as follows.

- 1 Press MENU button on the remote control to display screen menu. Press ▲▼ button to select "Expand", then press the OK button.
- 2 Press ▲▼ button to select the item you want to set, press the OK button.
- 3 Press ▲▼ button to adjust the item, then press the OK button.

## Language

This projector provides multi-language screen menu.

You can press▲▼ button to select the language you want.

26 languages: English, German, French, Italian, Spanish, Polish, Swedish, Dutch, Portuguese, Japanese, Simplified Chinese, Traditional Chinese, Korean, Russian,Arabic, Turkey, Finland, Norway, Denmark, Indonesia, Hungary, Czech Republic, Kazakhstan, Vietnamese, Thai, Farsi.

## Expand menu

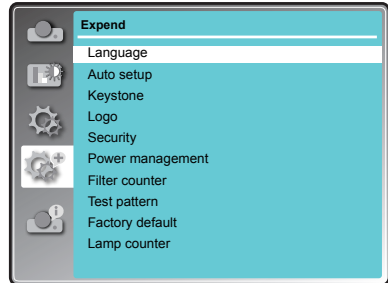

## Auto setup

Press AUTO button on the remote control to execute "Input search" and "Auto PC adj." functions.

### Input search

Allows you to automatically detect input signals. It stops when a signal is found. Press ▲▼ button to select an option below:

- On ..... Enabled. This function is used to detect input signals automatically and stops when finding a signal.
- Off ..... Disabled.

### Auto PC adj.

- On ..... Press the AUTO button on the remote control or top control to enable Auto PC adj. function automatically.
- Off ..... Cancel Auto PC adj. function.

## Auto setup

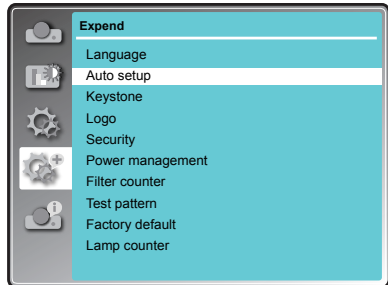

### ✓ Note:

- "Input search" and "Auto PC Adj." cannot be set to "Off" at the same time. At least one of them is set to "On".

## Expand

### Keystone

This function is used to store or reset the keystone correction when the AC power cord is unplugged.

- 1 Press MENU button on the remote control to display screen menu. Press ▲▼ button to select "Expand", then press the OK button.
- 2 Press▲▼ button to select "Keystone", press the OK button.
- 3 Press▲▼ button to select the item you want to set, press the OK button.

#### Keystone

Sets whether or not to keep the keystone correction after turn off the projector or plug out the power cord.

Store .... The keystone correction will be kept when plug out the power cord or turn off the projector.

Reset .... When "Standby mode" is set to "Eco", plug out the power cord or turn off the projector, the keystone correction will be canceled. When "Standby mode" is set to "Normal", plug out the power cord, the keystone correction will be canceled; turn off the projector, the keystone correction will be kept.

#### V Keystone

Adjust when the vertical trapezoid of the projected image is distorted.

Reduce the upper width with ▲ button.

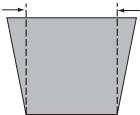

Reduce the lower width with ▼ button.

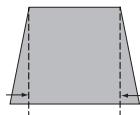

#### ✓ Note:

- The white arrows indicate that there is no correction.
- A red arrow indicates the direction of correction.
- An arrow disappears at the maximum correction.
- Correcting up to  $\pm 30^\circ$  for the tilt in the vertical direction is available for adjustments with "Keystone". However, the image quality will degrade and it will get harder to focus with more correction. Install the projector so that the correction will be as small as possible.
- Screen size will also change when "V Keystone" is used to perform various adjustments.
- Aspect ratio of the image size may shift depending on the correction.

Keystone menu

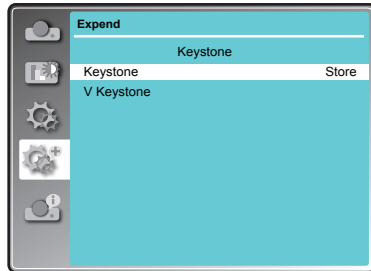

## Expand

### Logo

This function allows you to customize the screen logo with Logo select, Capture, Logo PIN code lock and Logo PIN code change functions.

#### Logo Select

This function decides on the starting-up display from following options.

- Default .... Show the factory-set logo.
- User.....Show the image captured by user.
- Off ..... Show the countdown display only.

#### Capture

You can capture a projected image as start logo . Select "Capture" and press the OK button on remote control or control panel. Confirmation dialog box appears, select "Yes" to start capturing.

#### Logo

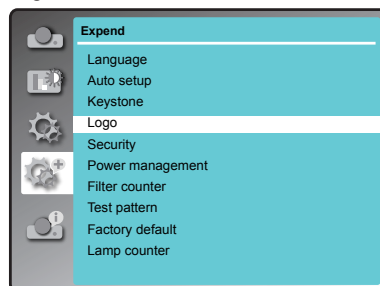

#### Logo PIN code Lock

This function prevents an unauthorized person from changing the screen logo.

**Off** .....The screen logo can be changed freely from the Logo menu.

**On** .....The screen logo cannot be changed without a Logo PIN code.

If you want to change the Logo PIN code lock setting, press the OK button and the Logo PIN code dialog box appears. Enter a Logo PIN code by following the steps below.

Press OK button to enter the PIN code. Press ◀▶ button to select a number, and then press the OK button to enter this number, the cursor automatically move to next box. If you fixed an incorrect number, press MENU button to reset it again.

Repeat this step to complete entering a three-digit number.

After entering the three-digit number, the cursor automatically move to "Set", and press the OK button, then you can start to operate the projector.

If you entered an incorrect PIN code, the number (\*\*\*) turn red, it will be reset automatically within one second. Enter the correct PIN code all over again.

#### Logo PIN code change

You can change the Logo PIN code (three number). Press the OK button to select Logo PIN code change. Logo Pin code dialog box appears, press ◀▶ button to enter the correct PIN code. The New Logo PIN code input dialog box appears. Set a new Logo PIN code, confirmation box appears, select Yes to set the new Logo Pin code.

Be sure to note the new Logo PIN code and keep it on hand. If you lost the number, you could no longer change the Logo PIN code setting.

#### CAUTION:

**WHEN YOU HAVE CHANGED THE LOGO PIN CODE, WRITE DOWN THE NEW PIN CODE IN COLUMN OF THE LOGO PIN CODE NO. MEMO ON PAGE 59, AND KEEP IT SECURELY. SHOULD THE LOGO PIN CODE BE LOST OR FORGOTTEN, THE LOGO PIN CODE SETTING CAN NO LONGER BE CHANGED.**

## Expand

### Security

This function allows you to use the PIN code lock and PIN code change functions to set the security for the projector operation.

#### PIN code lock

This function prevents the projector from being operated by unauthorized persons and provides the following setting options for security.

**Off** .... Unlocked.

**On** .... Enter the PIN code every time turning on the projector. If you want to change PIN code lock setting or PIN code, you must enter the PIN code. The default PIN code is "111".

If you want to change the PIN code lock setting, press the OK button, then PIN code dialog box appears.

Press ◀▶ button to select a number, and then press the OK button to enter this number, the cursor automatically move to next box. If you fixed an incorrect number, press MENU button to reset it again.

Repeat this step to complete entering a three-digit number.

After entering the three-digit number, the cursor automatically move to "Set", and press the OK button, then you can change the PIN code lock setting.

If you entered an incorrect PIN code, the number (\*\*\*) turn red, it will be reset automatically within one second. Enter the correct PIN code all over again.

#### PIN code change

The PIN code can be changed to three-digit number. Press ▲▼ button to select PIN code change. Pin code dialog box appears, Press ◀▶ button to enter the correct code. The New PIN code input dialog box appears. Set a new PIN code.

### Security

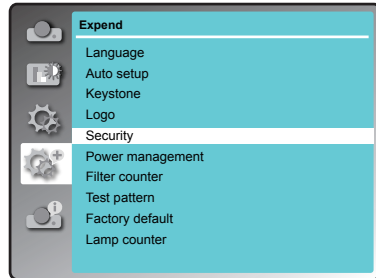

#### CAUTION:

**WHEN YOU HAVE CHANGED THE LOGO PIN CODE, WRITE DOWN THE NEW PIN CODE IN COLUMN OF THE LOGO PIN CODE NO. MEMO ON PAGE 59, AND KEEP IT SECURELY. SHOULD THE LOGO PIN CODE BE LOST OR FORGOTTEN, THE LOGO PIN CODE SETTING CAN NO LONGER BE CHANGED.**



## Expand

### Power management

For reducing power consumption as well as maintaining the lamp life, the Power management function turns off the projection lamp when the projector is not operated for a certain period. Select one of the following options:

#### Ready

When the lamp has been fully cooled down, the POWER indicator changes to green blinking. In this condition, the projection lamp will be turned on if the input signal is reconnected or any button on the remote control or top control is pressed.

#### Shut down

When the lamp has been fully cooled down, the power will be turned off.

#### Off

Power management function is off.

#### Timer

If the input signal is interrupted and no button is pressed for more than 30 seconds, the timer display with No signal appears. It starts the countdown until the lamp is turned off. Press ▲▼ button to set the Timer(1~30min.)

#### Ready countdown

Set the time that ready status transfers to standby status automatically.(0-30min. 0 Min: not transfer automatically)

*In ready status, press POWER button to switch to standby status, and press any other button to turn on the projector.*

### Filter counter

This function is used to set a frequency for filter cleaning.

When the projector reached a specified time between cleanings, a Filter warning icon appears on the screen, notifying the cleaning is necessary. After cleaning the filter, be sure to select RESET and set the timer. The Filter warning icon will not turn off until the filter counter is reset.

#### Filter counter

Display the using time of the filter.

#### Timer

Set the time to display the warning icon.

#### Filter counter reset

Reset the filter counter.

#### Filter check

Enable / disable filter check function.

### Power management



Time left before Lamp is off.

✓ Note:

*Factory default: "Timer: 5 min",  
"Ready countdown: 5 min".*

### Filter counter

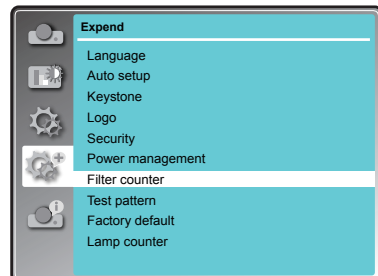

## Expand

### Test Pattern

This function is used to set the internal test signal: Gray scale 1, Gray scale 2, Gray scale 3, Gray scale 4, Color bar, Red, Green, Blue, Cross hatch, White, Black and Raster gray.

When you get into the Test Pattern mode, press MENU to get back the selection page of Test Pattern.

### Test Pattern

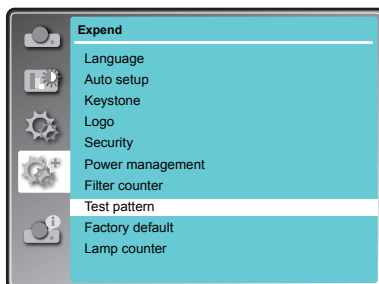

### Factory default

This function returns all setting values except for the User logo, PIN code lock, Logo PIN code lock, Lamp counter and Filter counter to the factory default settings.

### Factory default

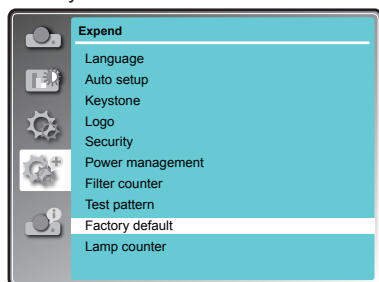

### Lamp Counter Reset

This function resets the counter of Lamp usage hours. Please be sure to reset the lamp counter after replacing the lamp. WARNING indicator turns Off and the lamp replacement icon disappears after reset the lamp counter.

Press < MENU > button on the remote controller or on the top control panel to display the OSD menu. Press ▲▼ button to select the Expand menu, then press <OK> or ► button.

- 1) Press ▲▼ button to select [Lamp counter] menu.
- 2) Press <OK > button.
- 3) Press ▲▼ button to select [Lamp counter reset], then press <OK> button.
- 4) " Lamp replacement counter reset ? " conformation box appear.
- 5) Select "Yes" and Press <OK> button.

### Lamp counter

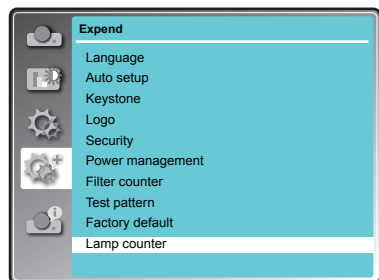

# Information

The information menu is used to detect the signal of the projected image and the running state.

## Menu operation

Press the MENU button on the remote control or the top control to display the screen menu. Press ▲▼ to select Info., the information menu will appear as the right picture.

The information below will be displayed in the information menu.

## Input

The selected input source is displayed.

## H-sync freq .

The horizontal frequency of the input signal is displayed in KHz or - - - -KHz when no signal is detected.

## V-sync freq .

The vertical frequency of the input signal is displayed in Hz or - - - - Hz when no signal is detected.

## Lamp status

The setting status of "Lamp control" is displayed.

## Lamp counter

The usage time of the lamp is displayed.

## Power management

The setting status of "Power management" is displayed.

## Image mode

The setting status of "Image mode" is displayed.

info. menu

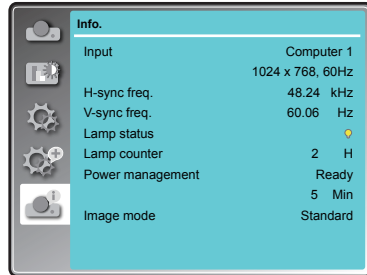

## Maintenance and cleaning

### WARNING indicator

The WARNING indicator shows the state of the function which protects the projector. Check the state of the WARNING indicator to take proper maintenance.

#### The projector is shut down and the WARNING indicator is flashing red.

When the temperature inside the projector exceeds the normal temperature, the projector is automatically shut down to protect internal components. The WARNING indicator is blinking while the projector is being cooled down. When the projector has cooled down enough (to its normal operating temperature), it can be turned on again by pressing the POWER button.

✓ *Note:*

*The WARNING indicator continues to blink even after the temperature inside the projector returns to normal. When the projector is turned on again, the WARNING indicator stops blinking.*

Check the items below:

- Did you provide appropriate space for the projector to be ventilated?  
Check the installing condition to see if ventilation slots are not blocked.
- Has the projector been installed near the duct or vent of an airconditioning?  
Move the installation of the projector away from the duct or vent.
- Are the air filters clean? Clean the air filters periodically.

#### The projector is shut down and the WARNING indicator lights red.

When the projector detects an abnormal condition, it is automatically shut down to protect the internal components and the WARNING indicator lights red. In this case, unplug the AC power cord and plug it, and then turn on the projector once again to verify operation. If the projector cannot be turned on and the WARNING indicator lights red, unplug the AC power cord and contact the service station for servicing and maintenance.

WARNING indicator

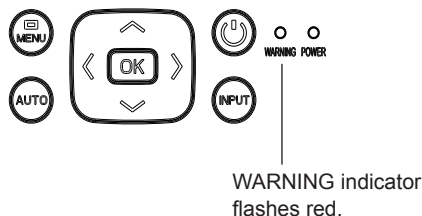

WARNING indicator

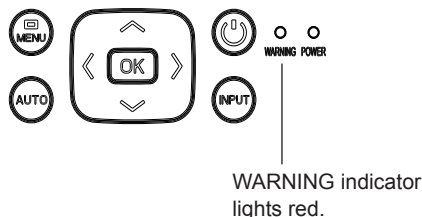

**Caution**

Do not leave the projector with the AC power cord connected under an abnormal condition. It may result in fire or electric shock.

## Maintenance and cleaning

### Cleaning the filter

The air filter prevents dust from accumulating on the surface of the optical elements inside the projector. Should the air filter become clogged with dust particles, it will reduce cooling fans' effectiveness and may result in a buildup of internal heat and adversely affects the life of the projector. If the Filter warning icon appears on the screen, the air filter should be cleaned immediately. Clean the air filter following the steps below.

- 1 Turn off the projector, and unplug the AC power cord from the AC outlet.
- 2 Remove the air filter.
- 3 Gently clean the filter with a brush.
- 4 Reinstall the filter into the projector properly.

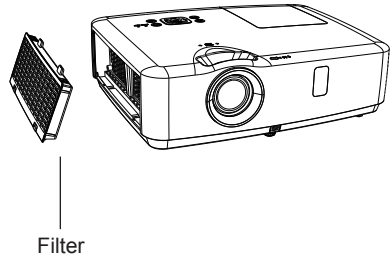

#### Caution

Do not operate the projector with the air filter removed. Dust may accumulate on the optical elements, degrading picture quality. Do not put any small objects into the air intake vents. Otherwise, it may result in malfunction of the projector.

#### Recommendation

We recommend avoiding dusty/smoky environments when you operate the projector. Usage in these environments may cause poor image quality.

When you use the projector under dusty or smoky conditions, dust may accumulate on the lens, LCD panels, or optical elements inside the projector. When the symptoms above are noticed, contact your authorized dealer or service station for proper cleaning.

### Filter counter reset

Be sure to reset the filter counter after cleaning or replacing the filter.

1. Press Menu on the remote control to display the screen menu. Press ▲▼ to select "Expand", then press the OK button.
2. Press ▲▼ to select "Filter counter", and then press the OK button. Press ▲▼ to select "Filter counter reset" and press the OK button, "Filter counter Reset?" appears on screen, select "Yes" to continue.
3. When another dialog box pops up, select "Yes" to reset the filter.

## Maintenance and cleaning

---

### Clean the projector lens

Unplug the AC power cord before cleaning.

Gently wipe the projection lens with a cleaning cloth that contains non-abrasive camera lens cleaner, or use a lens cleaning paper or commercially available air blower to clean the lens.

Avoid using an excessive amount of cleaner. Abrasive cleaners, solvents, or other harsh chemicals might scratch the surface of lens.

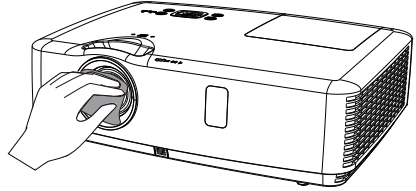

### Clean the cabinet

Unplug the AC power cord before cleaning.

Gently wipe the projector surface with a soft dry cleaning cloth. When the cabinet is heavily soiled, use a small amount of mild detergent and finish with a soft dry cleaning cloth. Avoid using an excessive amount of cleaner. Abrasive cleaners, solvents, or other harsh chemicals might scratch the surface of the cabinet.

When the projector is not in use, put the projector in a pouch to protect it from dust and scratches.

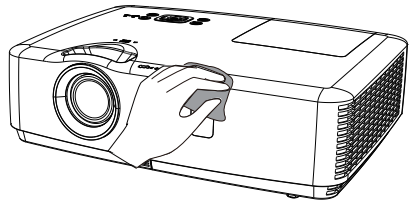

## Maintenance and cleaning

### Replace the lamp

When the projection lamp of the projector reaches its end of life, the Lamp replacement icon appears on the screen. Replace the lamp with a new one of the same type promptly. The timing when the lamp replacement icon appears is depending on the lamp mode.

Lamp replacement icon

Lamp replacement



#### CAUTION

As temperature inside the projector is high, you should cool the projector for at least 45 minutes before you open the lamp cover.



#### CAUTION

When the lamp isn't illuminated, it may indicate that the lamp has been damaged. When you replace the lamp in a projector installed on the ceiling, you should stand beside the lamp cover other than under it; for the broken glass may fall down to hurt you. To do that, remove the lamp cover gently to avoid being hurt by falling debris. If debris drops into your eyes or mouth, you should see the doctor immediately.



#### CAUTION

For the sake of safety, only use the lamp of the same model. Never drop the lamp onto the ground nor touch the glass bulb! The glass can shatter and hurt.

#### To replace the lamp, follow the steps below:

1. Power off the projector and unplug the power cord. Then let the projector cool for at least 45 minutes.
2. Loosen the screw on the lamp cover to remove the cover.
3. Make sure the lamp is well protected and remove three screws. Hold the handle to take out the lamp.
4. Install a new lamp with the same model and tighten the four screws. Make sure the installation is correct. Put lamp cover in place and then tighten the screw.
5. Plug the AC power cord and power on the projector.

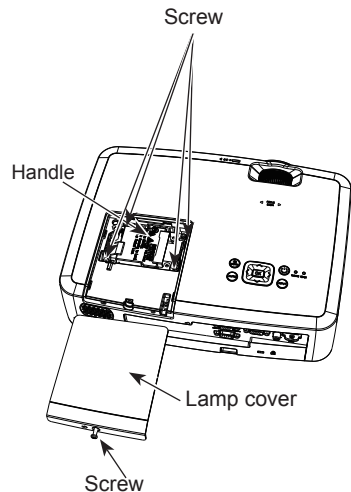

## Maintenance and cleaning

### **Order Replacement lamp**

Replacement lamp can be ordered through your dealer. When ordering a projection lamp, give the following information to the dealer.

**Replacement Lamp Model No.: 23040052**



### **LAMP HANDLING PRECAUTIONS**

This projector uses a high-pressure lamp which must be handled carefully and properly. Improper handling may result in accidents, injury, or create a fire hazard.

- Lamp life may differ from lamp to lamp and according to the environment of use. There is no guarantee of the same life for each lamp. Some lamps may fail or terminate their life in a shorter period of time than other similar lamps.
- If the projector indicates that the lamp should be replaced, i.e., if the the Lamp replacement icon appears, replace the lamp with a new one IMMEDIATELY after the projector has cooled down. (Follow carefully the instructions in the Lamp Replacement section of this manual.) Continuous use of the lamp with the WARNING indicator lighted may increase the risk of lamp explosion.
- A Lamp may explode as a result of vibration, shock or degradation as a result of hours of use as its lifetime draws to an end. Risk of explosion may differ according to the environment or conditions in which the projector and lamp are being used.

### **IF A LAMP EXPLODES, THE FOLLOWING SAFETY PRECAUTIONS SHOULD BE TAKEN .**

If a lamp explodes, disconnect the projector's AC plug from the AC outlet immediately. Contact an authorized service station for a checkup of the unit and replacement of the lamp. Additionally, check carefully to ensure that there are no broken shards or pieces of glass around the projector or coming out from the cooling air circulation holes. Any broken shards found should be cleaned up carefully. No one should check the inside of the projector except those who are authorized trained technicians and who are familiar with projector service. Inappropriate attempts to service the unit by anyone, especially those who are not appropriately trained to do so, may result in an accident or injury caused by pieces of broken glass.



# Appendix

## Troubleshooting

Before calling your dealer or service center for assistance, check the items below once again.

- Make sure you have properly connected the projector to peripheral equipment.
- Make sure all equipment is connected to the AC outlet and the power is turned on.
- If the projector does not project an image when it is connected to a PC, restart the PC.

<b>Problems</b>	<b>- Solutions</b>
No power	<ul style="list-style-type: none"><li>- Plug the power cord of the projector into the AC power outlet.</li><li>- Check whether the POWER indicator lights red.</li><li>- Only when the POWER indicator lights red you can power on the projector again.</li><li>- Check the WARNING indicator. If it is blinking red, the projector can not be powered on. (Page 54)</li><li>- Check the projection lamp.</li><li>- Unlock the "Key lock" function. (Page 35)</li></ul>
No initial displaying	<ul style="list-style-type: none"><li>- Make sure that Logo function is not set to "Off". (Page 39)</li></ul>
Initial displaying is inconsistent with factory defaults	<ul style="list-style-type: none"><li>- Make sure that Logo function is not set to "Off" or "User". (Page 39)</li></ul>
Input signals are automatically switched (can't be switched)	<ul style="list-style-type: none"><li>- Properly adjust the Input search function.</li></ul>
Ambiguous images	<ul style="list-style-type: none"><li>- Adjust the focus.</li><li>- Set a more proper projection distance.</li><li>- Check whether the lens needs to be cleaned.</li><li>- When moved from an environment with low temperature to the one with higher temperature, water will be condensed on the lens. If so, you have to wait till the condensed water disappears.</li></ul>
Image turns over leftward/ rightward	<ul style="list-style-type: none"><li>- Check the function of "Ceiling/rear". (Page 27)</li><li>- Check the function of "Ceiling".(Page 27)</li></ul>
Image turns over upward/ downward	
Image not bright enough	<ul style="list-style-type: none"><li>- Check whether the contrast or brightness is adjusted correctly. (Page 31-32)</li><li>- Check whether the Image mode is properly selected. (Page 30)</li><li>- Check the function of lamp brightness adjusting. (Page 34)</li></ul>
No image	<ul style="list-style-type: none"><li>- Check the connection between Computer or video equipment and the projector.</li><li>- Check whether the signal from Computer is correct. If connected to certain laptops, the settings of their video adapters need to be changed. You can refer to the operating instructions of the Computer for such modification.</li><li>- Images can show up only about 20 seconds after the projector is powered on.</li><li>- Check the input signal, color system, video system or Computer system mode.</li><li>- Make sure that the temperature doesn't exceed the permitted operating temperature(41°F-104°F [5°C - 40°C] ).</li><li>- If BLANK function is enabled, no image will appear on the screen. You can then press the BLANK button or other button on the remote control.</li></ul>

## Appendix

---

---

The color is abnormal	- Check the input signal, color system, video system or computer system mode. - Make sure that Blackboard is not selected in Image Mode menu.
Auto PC adj. function does not work.	- Check the Input signal. Auto PC adj. function can not work when 480p, 576p, 720p, 480i, 576i, 1080i or 1080p is selected.
The Settings cannot be saved after turning off the projector.	- Make sure you have selected "store" after you changed the settings. Some settings can't be saved if "store" is not selected.
Power management function does not work.	- Power management function can not work while Freeze or Blank function is running.
Logo function does not work.	- Check connections and input source.
Auto setup function does not work.	- Make sure no function in the Auto setup menu is set to "Off". - Make sure "On" is not chosen in the Ceiling function.
The image is distorted or disappears.	- Check and adjust "Screen" menu.
PIN code dialog box appears at start-up	- PIN code lock is being set.
The remote control does not work.	- Check the batteries. - Make sure no obstruction is between the projector and the remote control. - Make sure you are not too far from the projector when using the remote control. Maximum operating range is 5 m. - Unlock the Key lock function in the Setting menu for the remote control.
Indicators light or flash.	- Refer to Indicators and projector condition to check the status of the projector.
Exclamatory mark appears on the screen.	- Your operation is invalid. Operate correctly.
Top control cannot be operated.	- Unlock the Key lock in Setting -> Key lock.
Unable to unlock the Logo PIN code, Key lock or PIN code lock.	- Contact the dealer or the service center.

---

---



### Warning:

High voltages are used to operate this projector. Do not attempt to open the cabinet.

If problems still persist after following all operating instructions, contact the dealer where you purchased the projector or the service center. Specify the model number and explain about the problem. We will advise you how to obtain service.

## Appendix

### Menu Tree

Main menu	Sub menu	Setting	Note
Display	Auto PC adj.		
	Fine sync	0 to 31	
	H Position	-5 to +5	
	V Position	-5 to +5	
	H.Size	-15 to +15	In different signal, H.Size range will different
	Aspect	Normal Wide Full Advanced (PC input only)	
	Projection	Front Rear Ceiling/Front Ceiling/Rear	
	Menu positon	Upper left Upper right Center Lower left Lower right	
	Background display	Black Blue	
	System		Auto 1080p 1080i 1035i 720p 575p 575i 480p 480i
Auto PAL SECAM NTSC NTSC4.43 PAL-M PAL-N PAL60			S-video Input Video Input
Color adjust	Image mode	Dynamic Standard Cinema Blackboard(Green) Colorboard User Image	

## Appendix

Main menu	Sub menu	Setting	Note
Color adjust	Contrast	0-63	Computer input
	Brightness	0-63	
	Color temp.	High/Mid/Low	
	Red	0-63	
	Green	0-63	
	Blue	0-63	
	Sharpness	0-15	
	Contrast	0-63	Component Input S-video Input Video Input
	Brightness	0-63	
	Color	0-63	
	Tint	0-63	
	Red	0-63	
	Green	0-63	
	Blue	0-63	
Sharpness	0-15		
Setting	On start	On/Off	
	Standby mode	Normal/Eco	
	High land	On/Off	
	Lamp control	Normal/Eco	
	Cooling fast	Normal/60 sec/0 sec	
	Closed caption	Off, CC1,CC2,CC3, CC4	
	Key lock	Off, Projector, Remote control	
	HDMI setup	64-940 0-1023	
Expand	Language	English, German, French, Italian, Spanish, Polish, Swedish, Dutch, Portugese, Japanese, Simplified Chinese, Traditional Chinese, Korea, Russian, Arabic, Turkish, Finnish, Norwegian, Danish, Indonesian, Hungarian, Czech, Kazak, Vietnamese, Thai, Farsi	26 Languages

## Appendix

Main menu	Sub menu	Setting		Note	
Expand	Auto setup	Input search	On/Off		
		Auto PC adj.	On/Off		
	Keystone	Keystone	Store/Reset		
	Logo	Logo select	Default/User/Off		
		Capture			
		Logo PIN code lock	On/Off		
		Logo PIN code change			
	Security	PIN code lock	On/Off		
		PIN code change			
	Power management	Ready Shut down Off Timer Ready countdown			
	Filter counter	Filter counter Timer Filter counter reset Filter check			
	Test Pattern	Off, Gray scale1(1-4), Colorbar, Red, Green, Blue, Cross hatch, White, Black, Raster gray			
	Factory default				
Lamp counter	Lamp counter Lamp counter reset				
Info.	Input				
	H-sync freq.				
	V-sync freq.				
	Lamp status				
	Lamp counter				
	Power management				
	Image mode				

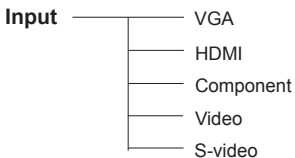

## Appendix

### Indicator and projector state

Check the indicator to know about the state of projector.

Indicator		State of projector
WARNING (Red)	POWER (Green/Red/ Yellow)	
○	○	Your projector is in Off status (without AC power supply).
○	●	Your projector is in standby status. Press Standby button to turn it on.
○	●	Your projector is in normal status.
○	●	It is ready for standby or the lamp is cooling. You may power on your projector only after the lamp is fully cooled and the POWER light indicator stops flashing.
○	●	Your projector is in Ready mode.
●	●	Your projector cannot power on, as its internal temperature is too high. You may power it on after it is fully cooled, temperature backs to normal, and the POWER light indicator turns red.
●	●	Your projector detects lamp abnormality and switches into standby mode.
●	●	Your projector detects the temperature abnormality and switches into standby mode.
○	●	Your projector detects power abnormality.
○	●	Your projector detects fan abnormality.
●	●	Your projector detects its usage time $\geq$ the life of the projector -300H when the projector usage time $< 1.1$ times the life of the projector.
●	●	Your projector detects its usage time $\geq 1.1$ times the life of the projector.

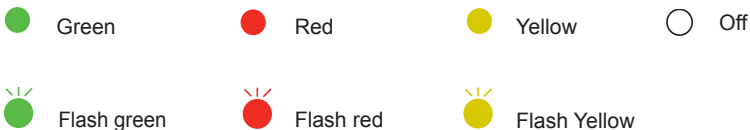

\* When the lamp reaches the end of its life, the LAMP indicator lights Yellow. In this case, replace the lamp with a new one promptly.

## Appendix

### Compatible computer specifications

Your projector is designed to accept every analog computer signal below Dot Clock 160MHz and digital computer signal below Dot Clock 150MHz.

See table below for details on resolution and relevant frequency.:

Input	Signal format	Resolution	Frequency (Hz)
VGA	VGA	640x480	60
		640x480	68
		640x480	72
		640x480	75
		640x480	85
	SVGA	800x600	56
		800x600	60
		800x600	72
		800x600	75
		800x600	85
	MAC 16	832x624	75
	XGA	1024x768	60
		1024x768	70
		1024x768	75
		1024x768	85
	MXGA	1152x864	75
	WXGA	1280x768	60
		1280x768	75
		1280x768	85
		1280x800	60
		1280x800	75
		1280x800	85
	QVGA	1366x768	60
		1280x960	60
		1280x960	85
		1280x1024	60
	SXGA	1280x1024	75
		1280x1024	85
SXGA+	1400x1050	60	
	1400x1050	75	
UXGA	1600x1200	60	
WSXGA+	1680x1050	60	
WUXGA	1920x1200	60	
Component	480i	720x480i	60
	576i	720x576i	50
	483p	720x483p	60
	576p	720x576p	50
	720p	1280x720	50
	720p	1280x720	60
	1080i	1920x1080i	50
	1080i	1920x1080i	60

Input	Signal format	Resolution	Frequency (Hz)
HDMI	VGA	640x480	60
		640x480	68
		640x480	72
		640x480	75
		640x480	85
	SVGA	800x600	56
		800x600	60
		800x600	72
		800x600	75
		800x600	85
	MAC 16	832x624	75
	XGA	1024x768	60
		1024x768	70
		1024x768	75
		1024x768	85
	XGA+	1152x864	75
	WXGA	1280x768	60
		1280x768	75
		1280x768	85
		1280x800	60
		1280x800	75
		1280x800	85
	QVGA	1366x768	60
		1280x960	60
		1280x960	85
		1280x1024	60
	SXGA	1280x1024	75
		1280x1024	85
SXGA+	1400x1050	60	
	1400x1050	75	
UXGA	1600x1200	60	
WSXGA+	1680x1050	60	
WUXGA	1024x768 1280x800	60	
Video/S-video	NTSC	NTSC	-
	PAL	PAL	-
	SECAM	SECAM	-
	NTSC4.43	NTSC4.43	-
	PAL-M	PAL-M	-
	PAL-N	PAL-N	-
	PAL-60	PAL-60	-

# Appendix

## Technical Specifications

LCD system	0.63" TFT, active matrix, 3-panel
LCD resolution	1024X768
<u>Compatible signals</u>	
Color standard	PAL, SECAM, NTSC, NTSC4.43, PAL-M, PAL-N and PAL60
HDTV signal	480i, 480p, 576i, 576p, 720p, 1080i and 1080p
Scanning frequency	Horizontal frequency: 15 –100 KHz; Vertical frequency: 48 – 85 Hz
<u>Optical elements</u>	
Image size (diagonal lines)	30"-300"
Projection distance	0.9m-9.1m(W) 1.1m-10.9m(T)
Lens	F=1.6-1.76, f=19.158-23.018mm; Manual zooming and focusing; Zoom Ratio: 1.2x optics
Lamp Consumption(W)	218W
<u>Terminal</u>	
VGA IN/YPbPr/S-VIDEO IN	Mini D-sub 15 pin x1
VGA OUT	Mini D-sub 15 pin x1
HDMI	HDMI x1
RS-232	D-sub 9 pin x1
Composit Video	RCA x1
<u>Power</u>	
Voltage and power consumption	AC 100–240 V, 50/60 Hz / 180 W (Eco), 270 W (Normal)
Fuse	250V/10A
<u>Operating Environment</u>	
Operating temperature	41°F-104°F (5°C - 40°C)
Storage Temperature	-4°F-140°F (-20°C - 60°C)
High land	1400 m - 2700 m
<u>Remote control</u>	
Battery	AAA or LR3 1.5V ALKALINE TYPE x 2
Operating Range	16.4' (5 m)/±30
Dimensions	50mm (W) x 18mm (H) x 110mm (D)
Net Weight	50g (including batteries)
<u>Mechanical properties</u>	
Dimensions (W×H×D )	347.0mmx109.0mmx257.0mm(Not including protrusion)
Net Weight	3.2Kg
Adjustable foot	40mm
<u>Accessories</u>	
	AC Power Cord, Remote Control & battery, VGA Cable Quick Start Guide, Safety Information

- The specification is subject to change without prior notice.
- Liquid crystal panel is made on the basis of high standard, where 99.99% of the pixels are effective.  
Due to the nature of the liquid crystal panel, a fraction of the pixels (0.01% or less) may be ineffective.



## Appendix

### Configurations of terminals

#### VGA IN terminal pin assignments and signal names

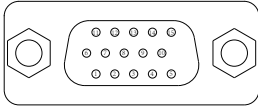

1	R/Pr/S-C	9	+5V
2	G/Y/S-Y	10	GND
3	B/Pb/-	11	GND
4	-----	12	DDC data
5	GND	13	HD/SYNC
6	GND	14	VD
7	GND	15	DDC clock
8	GND		

✓ Note:

The Pin 1, 2 and 3 (Pr, Y, Pb): for YCbCr/YPbPr signal.

The Pin 1 and 2 (S-C, S-Y): for S-Video signal.

#### VGA OUT terminal pin assignments and signal names

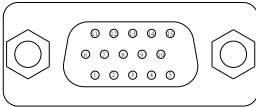

1	R	9	NC
2	G	10	GND
3	B	11	-----
4	-----	12	DDC data
5	GND	13	HD/SYNC
6	GND	14	VD
7	GND	15	DDC clock
8	GND		

#### RS232 terminal (D-SUB-9 pin)

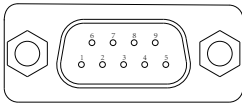

1	-----
2	RXD
3	TXD
4	-----
5	GND
6	-----
7	-----
8	-----
9	-----

#### HDMI terminal pin assignments and signal names

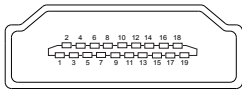

1	T.M.D.S data2+	11	T.M.D.S clock shield
2	T.M.D.S data2 shield	12	T.M.D.S clock-
3	T.M.D.S data2-	13	CEC
4	T.M.D.S data1+	14	-----
5	T.M.D.S data1 shield	15	SCL
6	T.M.D.S data1-	16	SDA
7	T.M.D.S data0+	17	DDC/CEC GND
8	T.M.D.S data0 shield	18	+5V
9	T.M.D.S data0-	19	Hot plug detection
10	T.M.D.S clock+		

## Appendix

### Content of hazardous substances and elements

Name of parts	Hazardous substances and elements					
	Pb	Hg	Cd	Cr6+	PBB	PBDE
Optical parts*	×	○	○	○	○	○
Electric parts**	×	○	○	○	○	○
Cabinet, mechanical parts	×	○	○	○	○	○
Lamp unit	×	×	○	○	○	○
Batteries	○	○	○	○	○	○
Others(Remote control, cable and other parts)	×	○	○	○	○	○
Package	○	○	○	○	○	○

This table is formulated in accordance with SJ/T 11364.

○: It means that contents of hazardous substances in all homogeneous materials in this part don't exceed "Required Limitations" specified in GB/T26572.

×: It means that contents of hazardous substances in at least one homogeneous material in this part exceed "Required Limitations" specified in GB/T26572.

Note:

\* : Optical parts includes optical lens, monitor, reflection lens ect.

\*\* : Electric parts includes PCB, internal wires, fans, power supply, sensors etc.

### Dimensions

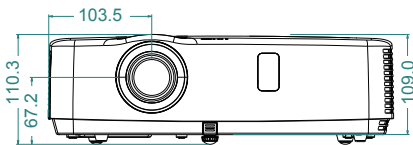

Unit: mm

↙ Screw Holes for Ceiling Mount  
Screw: M4  
Depth: 10.0

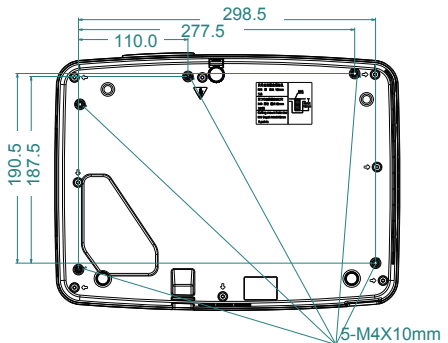
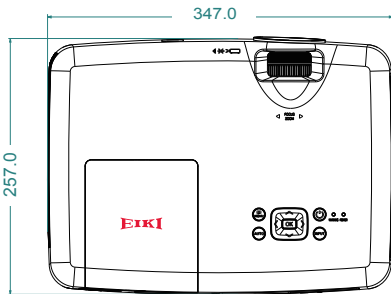

## Appendix

### PIN code memorandum

Write down the PIN code in the blank below and keep it. If you forgot or lost the number and unable to operate the projector, contact the service center.

PIN code lock

Factory default PIN code 111\*

--	--	--

Logo PIN code Lock No.

Factory default PIN code 111\*

--	--	--

\*If this 3-digit number is changed,  
the factory default number will be ineffective.

# EIKI

## **U.S.A.**

---

EIKI International, Inc.  
30251 Esperanza  
Rancho Santa Margarita  
CA 92688-2132, U.S.A.  
Tel: +1 800-242-3454  
+1 949-457-0200  
Fax: +1 800-457-3454  
+1 949-457-7878  
E-Mail: usa@eiki.com

## **Deutschland & Österreich**

---

EIKI Deutschland GmbH  
Am Frauwald 12  
65510 Idstein, Deutschland  
Tel: +49 6126-9371-0  
Fax: +49 6126-9371-11  
E-Mail: info@eiki.de

## **China**

---

EIKI (Shanghai) Co., Ltd.  
LAKESIDE OASIS MIDDLE RING  
BUSINESS CENTRE  
Block 1, Room 606,  
1628, Jin Sha Jiang Road  
Shanghai, 200333, CHINA  
China  
Tel: +86 21-3251-3993  
Service Hot line: +86 21-3251-3995  
Fax: +86 21-3251-3997  
E-mail: info@eiki-china.com

## **Oceania**

---

EIKI AUSTRALIA PTY LTD  
Level 5, 11 Queens Road,  
Melbourne, Victoria 3004, Australia  
Tel: +61 03-8530-7048  
Fax: +61 03-9820-5834  
E-Mail: sales@eiki.net.au

## **Canada**

---

EIKI CANADA  
Eiki International, Inc.  
Canadian Branch  
9170 County Road 93, Suite 304,  
Midland, ON, L4R 4K4, Canada  
Tel: +1 800-563-3454  
+1 705-527-4084  
E-Mail: canada@eiki.com

## **Eastern Europe**

---

EIKI CZECH SPOL. s.r.o.  
Nad Cementárnou 1163/4a  
Praha 4, Podolí, 147 00  
Czech Republic  
Tel: +420 241-410-928  
+420 241-403-095  
Fax: +420 241-409-435  
E-Mail: info@eiki.cz

## **South East Asia**

---

EIKI Industrial (M) Sdn Bhd  
No. 11, Nouvelle Industrial Park,  
Lorong Teknologi B, Taman Sains  
Selangor 1, Kota Damansara PJU5,  
47810 Petaling Jaya,  
Selangor Darul Ehsan, Malaysia  
Tel: +60 3-6157-9330  
Fax: +60 3-6157-1320  
E-Mail: sales@eiki.my

## **Japan & Worldwide**

---

EIKI Industrial Company Limited.  
6-23 Teramoto, Itami-shi, Hyogo,  
664-0026, Japan  
Tel: +81 72-782-7492  
Fax: +81 72-781-5435

**World Wide Website <http://www.eiki.com>**