

# EPSON®

**MEDIA PROJECTOR**  
ULTI EDIA

## EMP-8200/8200NL

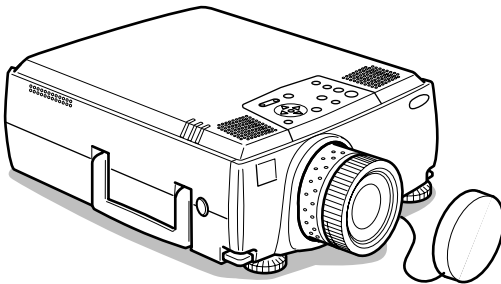

Before use

Installation

Connections

Projection

Useful Functions

Adjustments and  
setting

Using the projector  
software

Troubleshooting









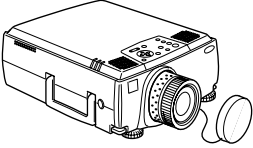
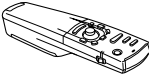

Maintenance

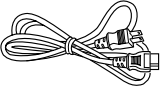
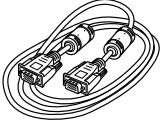
Others

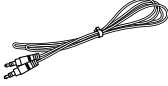
## Owner's Manual

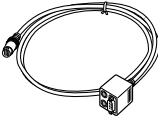
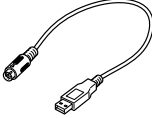
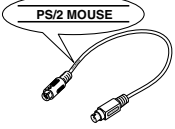
# Accessory Verification

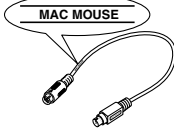
Check to confirm that the following items are included in the package when removing the projector and accessories from the box. Contact your dealer if any items are found to be missing.

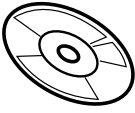
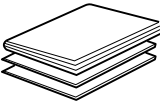
<ul style="list-style-type: none"> <li>· Projector</li> <li>· Lens cover with string</li> </ul> 	<ul style="list-style-type: none"> <li>· Remote control</li> </ul> 	<ul style="list-style-type: none"> <li>· Two alkaline dry cells for the remote control</li> </ul> 	
<ul style="list-style-type: none"> <li>· Power cord</li> </ul> 	<ul style="list-style-type: none"> <li>· Computer cable (mini D-Sub 15-pin/mini D-Sub 15-pin)</li> </ul> 	<ul style="list-style-type: none"> <li>· Computer cable (mini D-Sub 15-pin/5BNC)</li> </ul> 	<ul style="list-style-type: none"> <li>· Audio cable</li> </ul> 
<ul style="list-style-type: none"> <li>· RCA video cable (Yellow)</li> </ul> 	<ul style="list-style-type: none"> <li>· RCA audio cable (Red/White)</li> </ul> 	<ul style="list-style-type: none"> <li>· Main cable</li> </ul> 	<ul style="list-style-type: none"> <li>· USB mouse cable</li> </ul> 
<ul style="list-style-type: none"> <li>· PS/2 mouse cable</li> </ul> 	<ul style="list-style-type: none"> <li>· Serial mouse cable</li> </ul> 	<ul style="list-style-type: none"> <li>· Mac mouse cable</li> </ul> 	<ul style="list-style-type: none"> <li>· Mac serial cable</li> </ul> 
<ul style="list-style-type: none"> <li>· PC serial cable</li> </ul> 	<ul style="list-style-type: none"> <li>· Projector software CD-ROM</li> </ul> 	<ul style="list-style-type: none"> <li>· Safety Instructions/World-Wide Warranty Terms</li> <li>· Owner's Manual (this document)</li> <li>· Quick Reference Guide</li> </ul> 	

# About the Manuals and Notations Used

---

## Types of Manual

The documentation for your EPSON projector is divided into the following three manuals. The manuals cover the following topics.

### Safety Instructions/World-Wide Warranty Terms

This manual contains information on using the projector safely, and also includes World-Wide Warranty Terms and a troubleshooting check sheet.

Be sure to read this manual thoroughly before using the projector.

### Owner's Manual (this manual)

This Owner's Manual contains information on installing the projector, basic operation, using the projector menus, troubleshooting and maintenance.

### Quick Reference Guide

Contains an overview of the most commonly-used projector functions for easy reference. You should keep this Quick Reference Guide near the projector at all times and refer to it before starting presentations and while using the projector in order to check details of operation.

---

## Symbol Displays

### ● Safety-related displays

A variety of picture displays have been used in this manual and on the actual product to ensure that the projector is used correctly and safely in order to prevent risks to users and other people, and to prevent damage to property. Explanations for these displays are provided below. Ensure that they are fully understood before reading this manual.



**Warning**

Displays details that may result in death or injury if ignored.



**Caution**

Displays details that may result in injury or damage to property if ignored.

### ● General information

**Point:** Includes supplementary explanations and useful tips.

(see page xx) : Indicates reference pages

\*: Indicates that an explanation of the word or words in front of this symbol appears in the "Terminology." Refer to the "Terminology."(see page 88)

- Usage of the terms "this unit" and "this projector" in this manual  
The terms "this unit" and "this projector" appear regularly in this manual, and these terms also cover the accessories supplied with the projector and other optional products.
- The projection distances, illustrations and screen sizes apply to when the standard lens is in use.

# Contents

## About the Manuals and Notations Used **1**

---

Types of Manual .....	1
Symbol Displays .....	1

## Parts, Names and Operations **6**

---

Projector .....	6
Remote Control .....	10
Range of Remote Control Operations .....	13
Inserting the Remote Control Batteries .....	14

## Installation Procedure **15**

---

Installation Example .....	15
Screen Size and Projection Distance .....	16
Projection Angles .....	17

## Connecting the projector to a computer **18**

---

Eligible Computers .....	18
In the case of the mini D-Sub 15 pin .....	20
In the case of 5BNC (when connected to the second computer) .....	22
In the case of DVI-D* .....	23
Sound Connection .....	24
Connecting External Monitors .....	25
Connecting Up the Mouse (wireless mouse function) .....	26

## Connecting Video Equipment **28**

---

In the case of composite image signals .....	28
In the case of S image signals .....	28
In the case of component (color differential*) image signals .....	29
In the case of RGB image signals .....	30

## Projection **31**

---

Preparations .....	31
Commencing Projection .....	32

<b>Ending</b>	<b>35</b>
<hr/>	
<b>Adjusting the Projection Position</b>	<b>37</b>
<hr/>	
Feet Adjustments .....	37
<b>Adjusting the projection size</b>	<b>38</b>
<hr/>	
Zoom Adjustment .....	38
Keystone Adjustment .....	38
<b>Picture Quality Adjustment</b>	<b>39</b>
<hr/>	
Focus Adjustment .....	39
Auto Adjustment (when projecting computer images) .....	39
Tracking Adjustments (when projecting computer images) .....	40
Synchronization Adjustments (when projecting computer images) .....	40
Calling Out Adjustment Values (when projecting computer images) .....	40
<b>Introduction of Functions</b>	<b>41</b>
<hr/>	
<b>Useful Functions</b>	<b>42</b>
<hr/>	
Help Function .....	42
<b>Projection Cutting</b>	<b>44</b>
<hr/>	
A/V Mute Function .....	44
Freeze Function .....	44
<b>Switching Image Sizes</b>	<b>45</b>
<hr/>	
<b>Enlarging Images (E-Zooming function)</b>	<b>47</b>
<hr/>	

---

**Effect Function** **48**

---

Cursor/Stamp .....	48
Box .....	48
Spotlight .....	49
Bar .....	50
Canceling Effects .....	50

---

**P in P Function** **51**

---

---

**Volume Adjustment** **52**

---

---

**Menu Configuration** **53**

---

Menu Items .....	53
------------------	----

---

**Menu Operations** **55**

---

Operation Method .....	55
Setting Items .....	57
User Logo Registration .....	62

---

**Introduction of Projector Software** **64**

---

Outline of Projector Software .....	64
-------------------------------------	----

---

**Computer Connections** **65**

---

Serial Connections .....	65
--------------------------	----

---

**Installation** **67**

---

Operating Environment .....	67
Installation .....	68
Reading the User's Guide .....	69

---

**Troubleshooting** **70**

---

Operation Indicator .....	70
Lamp Indicator .....	71
Temperature Indicator .....	72

---

**When the Indicators Provide No Help** **73**

---

The image is not projected .....	73
The image is unclear .....	75
The image is cut up (Large)/Small .....	77
The image color is bad .....	77
The image is dark .....	78
No sound .....	78
The remote control won't work .....	79
Cannot end (after the [Power] button has been pressed) ..	79
EMP Link V will not function .....	80

---

**Cleaning the Projector, Cleaning the Lens,  
Cleaning the Air Filter** **81**

---

Cleaning the Projector .....	81
Cleaning the Lens .....	81
Cleaning the Air Filter .....	82

---

**Replacing the Air Filter** **83**

---

Replacement Method .....	83
--------------------------	----

---

**Replacing the Lamp** **84**

---

Replacement Method .....	85
Resetting the Lamp Illumination Time .....	86

---

**Optional Parts** **87**

---

---

**Terminology** **88**

---

---

**Specifications** **90**

---

---

**Index** **92**

---

# Parts, Names and Operations

## Projector

### ● Front Panel

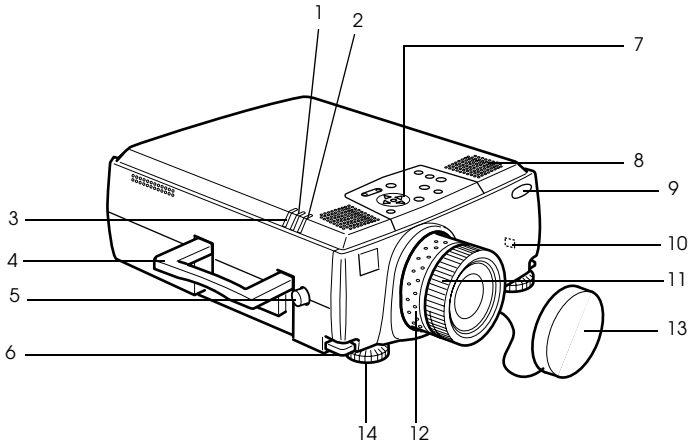

- 1 Lamp indicator
- 2 Operation indicator
- 3 Temperature indicator
- 4 Handle
- 5 Lens shift knob
- 6 Foot adjust lever
- 7 Operation panel
- 8 Speaker
- 9 Remote control light-receiving area
- 10 Theft-protection lock (see page 88)
- 11 Focus ring
- 12 Zoom ring
- 13 Lens cover
- 14 Front foot



● **Back Panel**

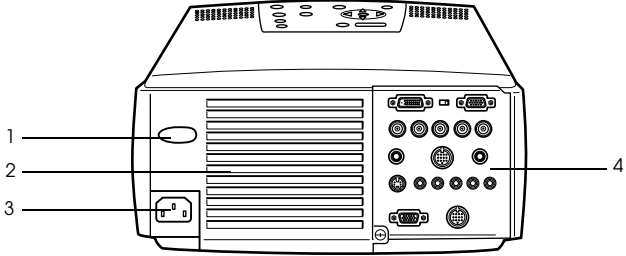

**1 Remote control light-receiving area**

**2 Fan**

**3 Power inlet**

**4 I/O port**

● **Rear Panel**

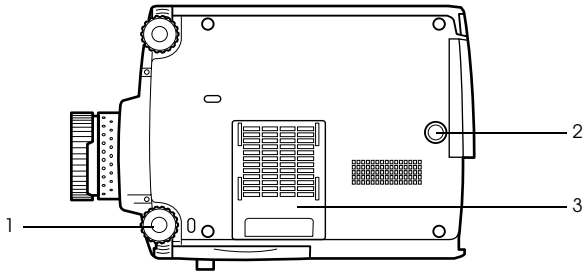

**1 Front foot**

**2 Rear foot**

**3 Air filter (suction inlet)**

## ● Operation Panel

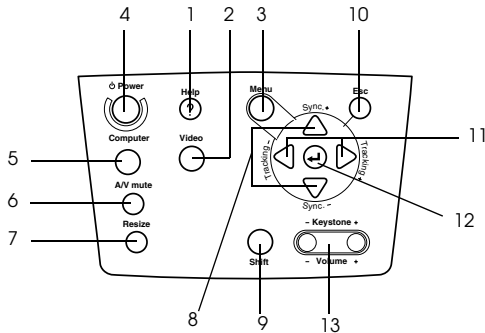

### 1 [Help] button (see page 42)

Displays the methods of solving problems. Press this button when trouble occurs.

### 2 [Video] button (see page 33)

Switches the images between video images (Video), S video (S-Video) and component video (BNC (YCbCr, YPbPr)).

### 3 [Menu] button (see page 55)

Displays and cancels the menu.

### 4 [Power] button (see page 32, 35)

Switches the power supply on and off.

### 5 [Computer] button (see page 33)

Switches images between the Computer 1 image and BNC (RGB).

### 6 [A/V Mute] button (see page 44)

Temporarily erases the image and sound. Projection is resumed when this button is pressed once more or when the volume control is adjusted or when the menu is displayed. A user logo can also be set up for projection when in the mute mode.

### 7 [Resize] button (see page 45)

Switches between the window display and the resizing display when computer images are being projected. Switches the aspect ratio between 4:3 and 16:9 when video images are being projected.

### 8 [Sync] button (see page 40)

Makes the necessary adjustments when the screen is out of focus or flickering. This button functions as the up and down key when the menu or help text is being displayed.

### 9 [Shift] button (see page 52)

Adjusts the volume when pressed simultaneously with the [Volume (Keystone)] button.

### 10 [Esc] button (see page 56)

Ends functions that are currently in use. Returns the screen to the previous stage when this is pressed during menu and help text display.

### 11 [Tracking] button (see page 40)

Performs the necessary adjustments when stripes appear on the screen. Moves left and right when this is pressed during menu and help text display.

### 12 [↵(Enter)] button (see page 39, 42, 55)

- Sets the menu item and moves onto the lower stage.
- Optimizes the computer image when the menu or help text is not displayed. (Switches the input resolution across to [Auto] when set for [Manual]).

### 13 [Keystone] button (see page 38)

Performs the necessary adjustments when the screen distorts into a trapezoid shape.

## ● I/O Ports

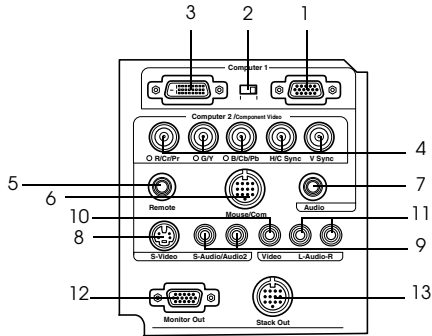

### 1 Computer 1-mini D-Sub 15 port

Inputs the computer's analog image signals.

### 2 Change-over switch

Switches the valid port for Computer 1 across to either mini D-Sub15 (analog) or DVI-D (digital). Operate the switch with the tip of a ballpoint pen or other pointed object.

### 3 Computer 1-DVI-D port

Inputs the computer's digital image signals.

### 4 Computer 2-BNC port

· R/Cr/Pr · G/Y · B/Cb/Pb · H/C Sync · V Sync

Inputs the computer's BNC image signals, the A/V equipment's component image signals (color differential signal\*) or the RGB image signals.

### 5 Remote port

Connects the optional remote control receiver (ELPST04).

### 6 Mouse/Com port

Establishes a connection with the computer when the projector software that is supplied is to be used or when the remote control is used as a wireless mouse.

### 7 Audio port

Inputs the audio signals from the computer and A/V equipment connected to the Computer 1 port.

### 8 S-Video port

Inputs the A/V equipment's S image signals.

### 9 S-Audio/Audio 2 port

Inputs the audio signals from the computer and A/V equipment connected to the BNC port or the S-Video port.

Outputs only the sound for connected computers and A/V equipment.

### 10 Video port

Inputs the the A/V equipment's component image signals.

### 11 L-Audio-R port

Inputs the the A/V equipment's sound signals.

### 12 Monitor Out port

Outputs the projected image signals to an external monitor (not output when the input comes from the DVI-D port.)

### 13 Stack Out port

This is used during stack projection\*.

# Remote Control

## ● Front Panel

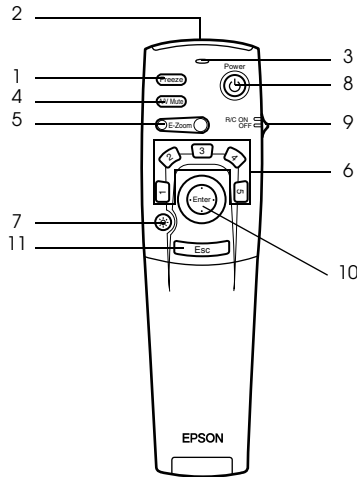

### 1 [Freeze] button (see page 44)

Temporarily freezes the image. Press this button once more to cancel the freeze mode.

### 2 Remote control light-emitting area

Outputs the remote control signals.

### 3 Indicator

Illuminated when the remote control signals are being output.

### 4 [A/V Mute] button (see page 44)

Temporarily erases the images and sound. Projection will be resumed if this button is pressed once more or the volume is adjusted. A user logo can be set up for projection when in the mute mode.

### 5 [E-Zoom] button (see page 47, 51)

Enlarges the image with the E-Zoom function. Enlarges the sub-screen when using P in P images. Press the [Esc] key to cancel this mode.

### 6 [Effect] button (see page 48)

Executes the allocated effect function. Press the [Esc] key to cancel this mode.

### 7 [Light] button

The remote control buttons will be illuminated for approximately ten seconds.

### 8 [Power] button (see page 32, 35)

Switches the power supply to the projector on and off.

### 9 [R/C ON OFF] switch (see page 32, 36)

Switches the remote control on and off. The remote control cannot be used for operations when this switch is not set at [ON].

### 10 [Enter] button (see page 27, 42, 55)

- Sets the menu item when pressed, and then moves onto the lower stage. Becomes a cursor key to select the menu items when moved up, down, left or right.
- This function operates as a left-hand click on the mouse when computer images are being projected. The pointer will move when this button is moved up, down, left or right.

## 11 [Esc] button (see page 27, 56)

- Ends the function being used. Returns to the previous stage when the menu or help text is being displayed.
- This function operates as a right-hand click on the mouse when computer images are being projected.

## ● Inside of the Cover

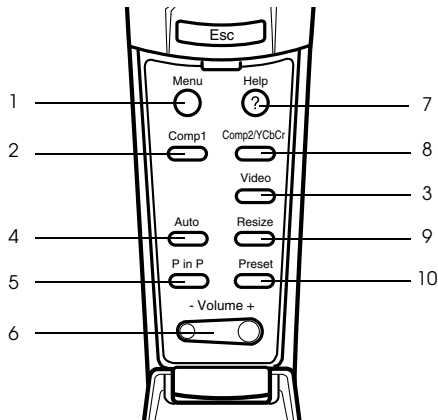

### 1 [Menu] button (see page 55)

Displays and ends the menu.

### 2 [Comp1] button (see page 33)

Switches across to the image from Computer 1 port. (Switches across to the DVI-D image when the switch is set at the left-hand side.)

### 3 [Video] button (see page 33)

Switches between video images (Video) and S-video images (S-Video).

### 4 [Auto] button (see page 39)

Optimizes the computer image.

### 5 [P in P] button (see page 51)

Displays the video image within the computer image or the video image as a sub-screen. This function is cancelled by pressing this button once again.

### 6 [Volume] button (see page 52)

Adjusts the volume.

### 7 [Help] button (see page 42)

Displays the method of solving problems. Press this button when trouble occurs.

### 8 [Comp2/YCbCr] button (see page 33)

Switches between the images from the BNC port.

### 9 [Resize] button (see page 45)

Switches between the window display and the resizing display when computer images are being projected. Switches the aspect ratio between 4:3 and 16:9 when video images are being projected.

### 10 [Preset] button (see page 40)

Calls out the preset computer input settings.

● **Rear Panel**

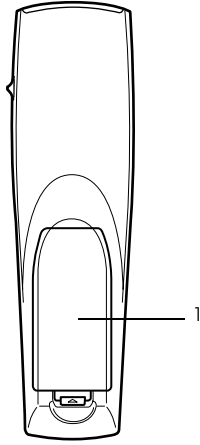

**1 Battery cover**

## Range of Remote Control Operations

Depending on the distance and angle from the main unit's light receiving area, there are cases where the remote control will not function. Ensure that the remote control is used within the following conditions:

● **Operable distance: Approximately 10 meters**

● **Operable range:**

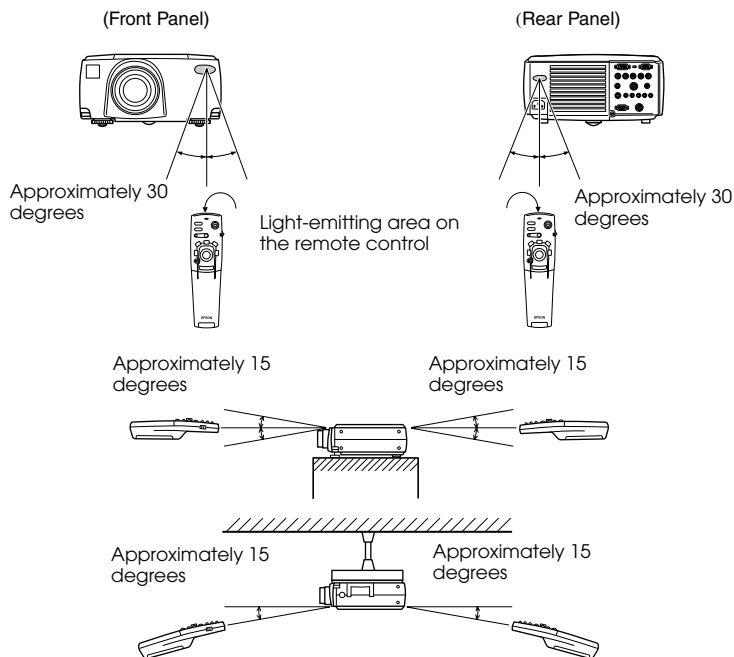

### Point

- Ensure that the [R/C ON OFF] switch is set at [ON] when using the remote control.
- Aim the remote control at the projector's light-receiving area.
- There are cases where the operable distance (approximately 10 meters) of the remote control is diminished when signals are reflected off screens depending on the type of screen in use.
- Ensure that sunlight and florescent lighting is not shone directly into the projector's light-receiving area.
- If the remote control will not function or malfunctions, there is a possibility that the batteries need changing. In this event, replace the batteries accordingly.
- Use the optional remote control receiver if it is to be used at a distance of 10m or more.

## Inserting the Remote Control Batteries

The remote control batteries are inserted in accordance with the following procedure:

### ⚠ Caution

Ensure that unused batteries of the same type are used.

#### **1** Remove the battery cover.

Apply pressure to the clip holding the battery cover, and then lift it upwards.

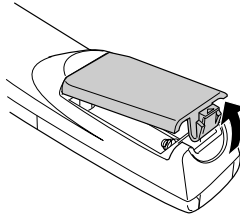

#### **2** Insert the batteries.

Ensure that the batteries are aligned correctly with the "+" and "-" labels on the remote control.

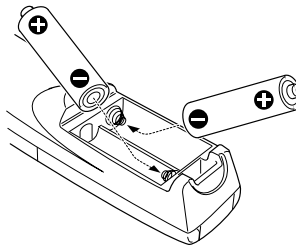

#### **3** Replace the cover.

Apply pressure to the battery cover until it clicks firmly into place.

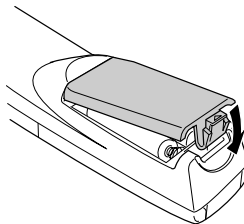

---

#### **Point**

- Specified batteries: Two alkaline dry cells LR6 (AA).
  - The batteries should be replaced approximately once every three months when used for thirty minutes per day.
-



# Installation Procedure

Determines the projection angle and projection distance to ensure the most suitable screen display.

## ⚠ Caution

- Do not block the ventilation outlet at the back of the projector or the air filter (suction inlet) on the rear panel.
- There are cases where material or paper get sucked onto the air filter on the rear panel when the projector is in use, so attention must be paid to prevent this.
- Do not place the projector in a location where it is subject to the direct air flow from air conditioners or heaters.
- When the projector is to be placed near a wall, ensure that there is at least 20cm of space between the wall and the projector.
- Do not cover the projector with table cloths or other material.

## Installation Example

The projector may be installed in locations that conform to the installation conditions and projection methods.

### Viewing projected images from the front

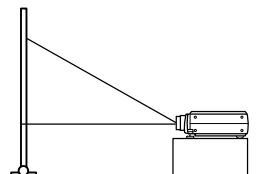
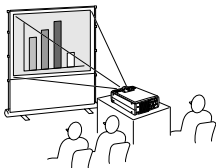

### Viewing projected images from the front with a ceiling suspended projector

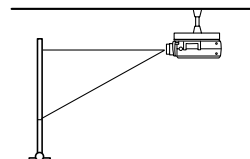
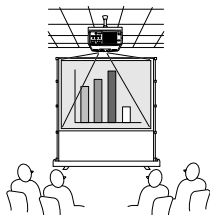

Use the optional ceiling suspension unit and set the ceiling suspension parameter to [ON]. ([see page 61](#))

### Viewing images projected onto half-transparent screens from the rear

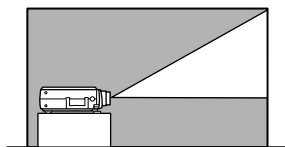
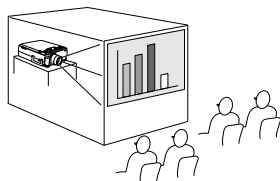

- Set the rear parameter to [ON]. ([see page 61](#))
- Ceiling suspension is also possible with the use of the optional ceiling suspension unit.

# Screen Size and Projection Distance

Determines the distance that the screen must be from the lens in order to obtain the required screen size.

The projector's standard lens is approximately a 1.3x zoom lens and the largest screen size is about 1.3 times the size of the smallest screen.

Using the following table for reference purposes, install the projector so that the screen size is smaller than the screen.

Screen Size	Approximate Projection Distance
30-inch (61×46cm)	1.1m to 1.4m (3.6ft. to 4.6ft.)
40-inch (81×61cm)	1.5m to 1.8m (4.8ft. to 6.2ft.)
60-inch (120×90cm)	2.3m to 2.8m (7.3ft. to 9.4ft.)
80-inch (160×120cm)	3.0m to 3.8m (9.8ft. to 12.6ft.)
100-inch (200×150cm)	3.8m to 4.8m (12.3ft. to 15.8ft.)
200-inch (410×300cm)	7.6m to 9.7m (24.8ft. to 31.9ft.)
300-inch (610×460cm)	11.4m to 14.6m (37.3ft. to 48.1ft.)

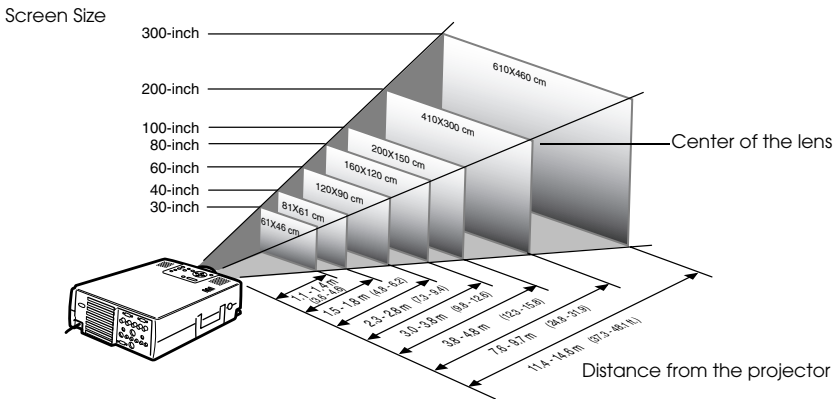

## Point

- The projection distances listed above are the distances when the standard lens is in use. If optional lenses are to be used, refer to the relevant instruction manuals for further details.
- The screen size will become smaller when the trapezoid correction function is used.

# Projection Angles

Placing the projector with the center of the lens at an exact right-angle to the screen will provide optimal projection. Pay attention to the angle of projection when placing the projector in position.

## When viewing from the side

\*\* The projection position can be moved up and down by turning the lens shift knob.

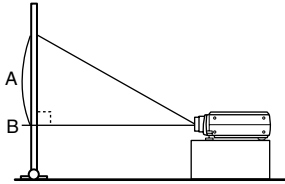

A:B 10: Becomes 0

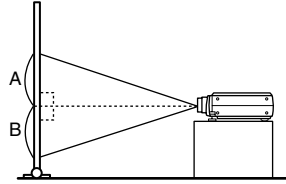

A:B 5: Becomes 5

## When viewing from the top or bottom

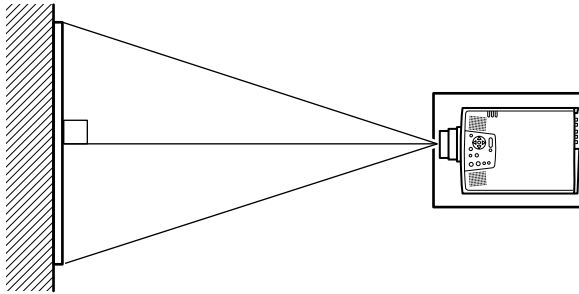

---

## Point

Although the projection position can be adjusted with the foot adjust lever (see page 37), there are cases where the screen will distort into a trapezoid shape. In this event, adjust the trapezoid distortion with the trapezoid correction function. (see page 38)

Upward 30°

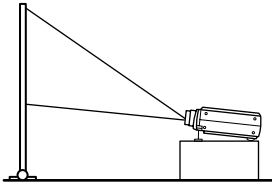

Downward 30°

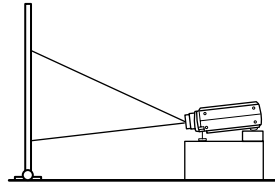

# Connecting the projector to a computer

Switch off the power supply to the projector and computer before attempting to make the connection.

## Eligible Computers

There are computers with which connections cannot be established and computers that cannot be used for projection purposes even though a connection has been established. First of all, it is necessary to confirm that a connection can be established with the computer in use.

### ● Conditions for eligible computers

#### Condition #1: The computer must be fitted with an image signal output port

Check to ascertain that the computer is fitted with ports that will output image signals, such as the "RGB Port", the "Monitor Port" and the "Video Port". If you have trouble confirming this, refer to chapter on external monitor connections in the computer's instruction manual.

There are computers, such as combined computer / monitor models and laptop models, that do not allow connections or for which optional external output ports must be purchased.

#### Point

Depending on the computer, there are cases when it is necessary to switch the image signal output with the connection key (≡□, etc.) and the settings.

NEC	Panasonic	Toshiba	IBM	SONY	FUJITSU	Macintosh
[Fn]+[F3]	[Fn]+[F3]	[Fn]+[F5]	[Fn]+[F7]	[Fn]+[F7]	[Fn]+[F10]	The control panel monitor and sound to be set to mirroring after rebooting.

The table shown above provides examples for certain products. Refer to the computer's instruction manual for further details.

#### Condition #2: The resolution and frequency of the computer must be within the boundaries listed in the chart on the next page.

Projection will not be possible if the computer does not support the output image signal resolutions and frequencies shown in the chart on the next page (there are cases where projection is possible, but vivid projection will not be possible).

Confirm the image signal resolution and frequency with the computer's instruction manual.

There are also computers available that allow the output resolution to be amended. In this case, amend the parameters to fit within the ranges shown in the chart on the next page.

Signal	Refresh Rate (Hz)	Resolution (Dots)	Pixels (dots) Used During Resizing Display (Resize On)	Pixels (dots) Used During Real Display (Resize Off)	Remarks
PC98		640×400	1024×640	640×400	
VGACGA		640×400	1024×640	640×400	
VGAEGA		640×350	1024×560	640×350	
VGA	60	640×480	1024×768	640×480	
VESA	72/75/85/100/120	640×480	1024×768	640×480	
SVGA	56/60/72/75/85/100/120	800×600	1024×768	800×600	
XGA	43i/60/70/75/85/100	1024×768	1024×768	1024×768	
SXGA	70/75/85	1152×864	1024×768	1152×864	Virtual (Partial) Display
SXGA	60/75/85	1280×960	1024×768	1280×960	Virtual (Partial) Display
SXGA	43i/60/75/85	1280×1024	960×768	1280×1024	Virtual (Partial) Display
SXGA+		1400×1050	996×746	1400×1050	Virtual (Partial) Display
		1440×1080	1024×768	1440×1080	
UXGA	48i/60/65/70/75/80/85	1600×1200	1024×768	1600×1200	Virtual (Partial) Display
MAC13		640×480	1024×768	640×480	
MAC16		832×624	1024×768	832×624	
MAC19		1024×768	1024×768	1024×768	
MAC21		1152×870	1016×768	1152×870	Virtual (Partial) Display
iMAC		640×480	1024×768	640×480	
		800×600	1024×768	800×600	
		1024×768	1024×768	1024×768	
NTSC			1024×768	1024×576	4:3 ↔ 16:9, Selectable
PAL			1024×768	1024×576	4:3 ↔ 16:9, Selectable
SECAM			1024×768	1024×576	4:3 ↔ 16:9, Selectable
SDTV (525i)	60		1024×768 (4 : 3)	1024×576 (16 : 9)	
HDTV (750P)	60			1024×576 (16 : 9)	
HDTV (1125i)	60			1024×576 (16 : 9)	

## In the case of the mini D-Sub 15 pin

### ⚠ Caution

- Switch off the power supply to the projector and computer before attempting to make the connection. Failure to observe this may result in damage.
- Confirm the shape of the cable connector and the shape of the port before making the connection. Applying excessive force when the direction or shape of the connector and port differ may result in defects and damage to the equipment.

- Connect the computer's monitor port to the Computer 1-mini D-Sub 15 port on the projector with the computer cable supplied.
- Set the switch to the analog setting (right-hand side) with the tip of a ballpoint pen or other pointed object.

### ● When the monitor port is the mini D-Sub 15 pin

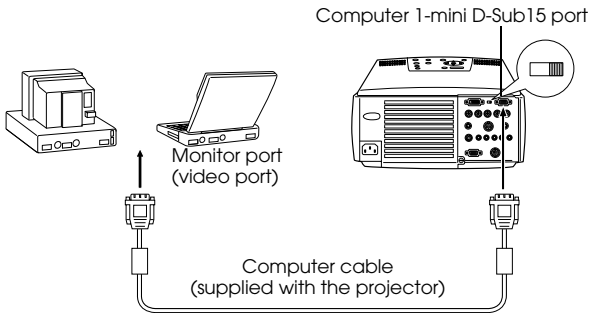

## ● When the monitor port is the 5BNC

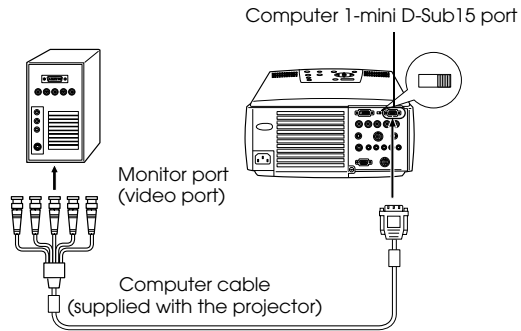

### Point

- Do not bind the power cable and the computer cable together. Failure to observe this may result in malfunctions.
- An adapter may be required when making the connection depending on the shape of the computer's port. Refer to the computer instruction manual for further details.
- There are cases where the optional Mac desktop adapter and Mac monitor adapter are required when connecting up to a Macintosh.
- It is possible to establish connections with both the Computer 1 port and the Computer 2 port when two computers are to be connected.

## ● When the monitor port is 13w3

The Computer 1 port is also connected to the mini D-Sub 15 port with the use of the conversion cable when the 13w3 port is used for connecting the computer's monitor port to a work station.

- The projector's computer 1-mini D-Sub 15 port is connected to the computer's monitor port (13w3) with the 13w3 ↔ mini D-Sub 15 cable (available on the open market).
- Set the switch to the analog setting (right-hand side) with the tip of a ballpoint pen or other pointed object.

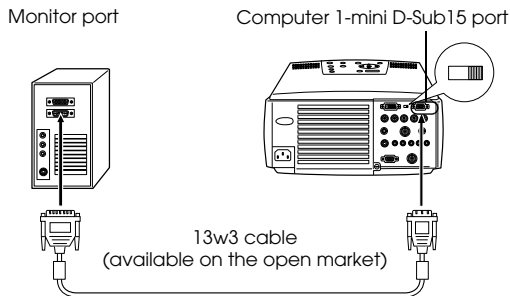

---

## In the case of 5BNC (when connected to the second computer)

Connects the computer's monitor port to the projector's Computer 2-BNC port with the computer cable supplied.

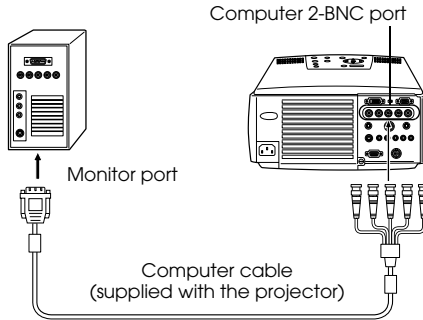

---

### Point

- Set the BNC parameter to [RGB] when establishing the connection. ([see page 59](#))
- Make the connection with the 5BNC ↔ 5BNC cable (available on the open market) when the computer's monitor port is 5BNC.
- Connections can be made to both computer 1 port and computer 2 port when two computers are to be connected.

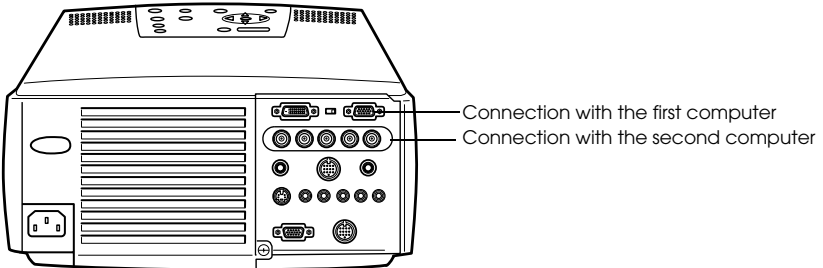



---

## In the case of DVI-D\*

Digital signals are output to the projector without amendment if the computer has a standard DVI-compliant digital video card or video output port.

- Connect the computer's digital output port to the projector's computer 1-DVI-D port with the optional digital video cable. Select the cable in accordance with the shape of the computer's port (DVI-D/DFP).
- Set the switch to the digital setting (left-hand side) with the tip of a ballpoint pen or other pointed object.

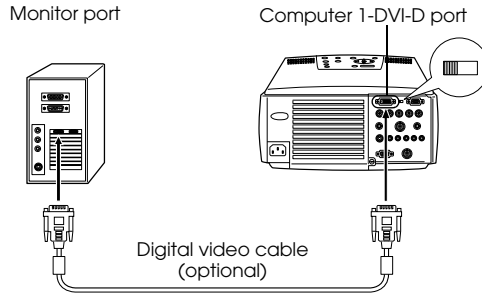

### Point

There are cases where the computer must be set up in order to switch the computer output to the DVI-D. Refer to the instruction manual for the computer for further details.

---

---

## Sound Connection

The projector is equipped with two built-in speakers capable of outputting a maximum of 3W, and it is also possible to output computer sound from the projector's speakers.

### ● Connecting the computer to Computer 1

Connect the projector's Audio port (stereo mini jack) to the computer's audio output port with the audio cable supplied.

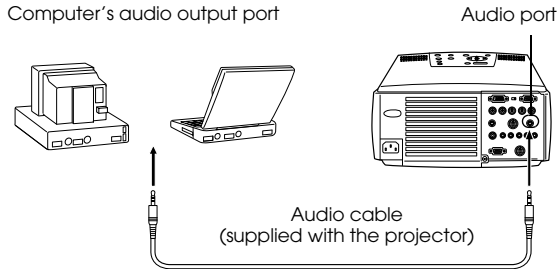

### ● Connecting the computer to Computer 2

Connect the computer's audio output port to the projector's S-Audio/ Audio 2 port (RCA pin jack) with the RCA audio cable (sold on the open market).

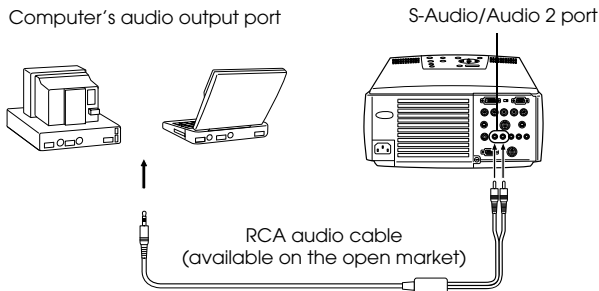

---

#### Point

The audio signals output the selected image's sound.

---

---

## Connecting External Monitors

It is possible to display the image projected with the projector onto a computer simultaneously. Connect the projector's monitor out port to the computer monitor with the cable attached to the monitor.

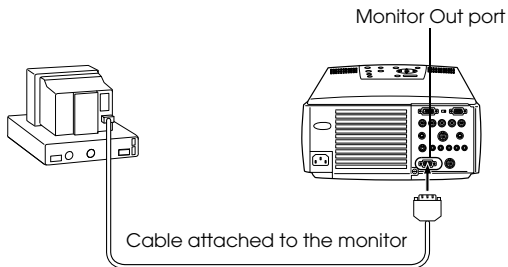

---

### Point

- There are cases where the optional Mac desktop adapter and Mac monitor adapter are required when connecting up to a Macintosh.
  - Images cannot be displayed on external monitors when the computer is connected to the DVI-D port.
-

## Connecting Up the Mouse (wireless mouse function)

This enables the computer's mouse pointer to be operated with the remote control in the same way as a wireless mouse.

Connect the projector's Mouse/Com port to the computer's mouse port with the mouse cable and main cable.

Computer	Mouse to use	Mouse cable to use
PC/AT DOS/V	PS/2 mouse	PS/2 mouse cable (supplied)
	Serial mouse	Serial mouse cable (supplied)
	USB mouse	USB mouse cable (supplied)
Macintosh	Macintosh mouse	Mac mouse cable (supplied)
	USB mouse	USB mouse cable (supplied)

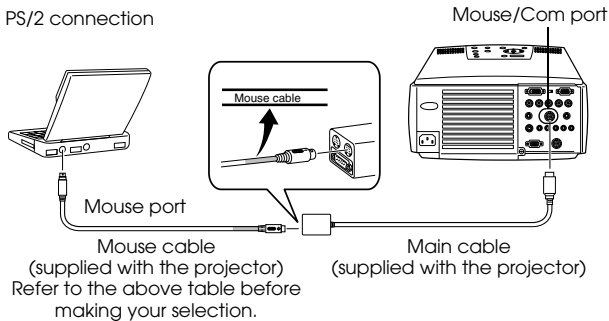

### Point

- Only the USB standard mounted model supports USB Mouse Cable connections. In the case of Windows, only the Windows 98/2000 preinstalled model is supported. Operations cannot be guaranteed on upgraded Windows 98/2000 environments. Operating systems 9.0 to 9.1 are supported for Macintosh machines. There are cases where the wireless mouse function cannot be used with both Windows and Macintosh, depending on the OS version.
- Only a computer mouse connected to the Mouse/Com port can be used.
- The mouse cannot be used when the effect function is in progress.
- There are cases where the computer must be set up. Refer to the instruction manual for the computer for further details.
- Switch off the power to the projector and computer before making the connection.
- It is necessary to reboot the computer if it does not work.

Perform the following mouse operations after the connection has been established:

Left click -----Press the [Enter] button.

Right click -----Press the [Esc] button.

Mouse pointer movement----Tilt the remote control [Enter] button

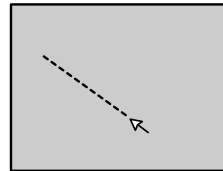
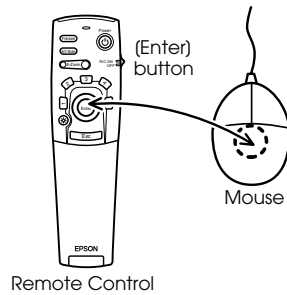
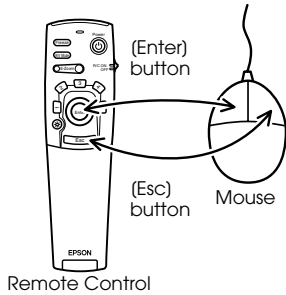

**Point**

- The operations will be reversed if the left/right button functions of the mouse have been amended with the computer.
- The mouse cannot be used when the Effect, P in P and E-Zoom functions are in use.

# Connecting Video Equipment

Switch off the power supply to the projector and video equipment prior to attempting to make the connection.

---

## Point

The audio signals output the selected image's sound.

---

---

## In the case of composite image signals

- Connect the projector's Video port to the video equipment with the supplied RCA video cable (Yellow).
- Connect the L-Audio-R port with the RCA audio cable supplied (red/white) to output sound from the projector's speakers.

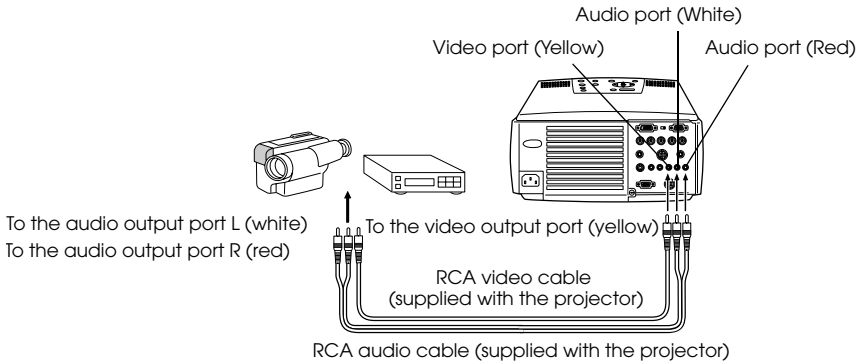

---

## In the case of S image signals

- Connect the projector's S-Video Port to the video equipment with the S-Video cable (available on the open market).
- Connect the supplied RCA audio cable (Red/White) to the S-Audio/ Audio 2 port if the sound is to be output from the projector's speakers.

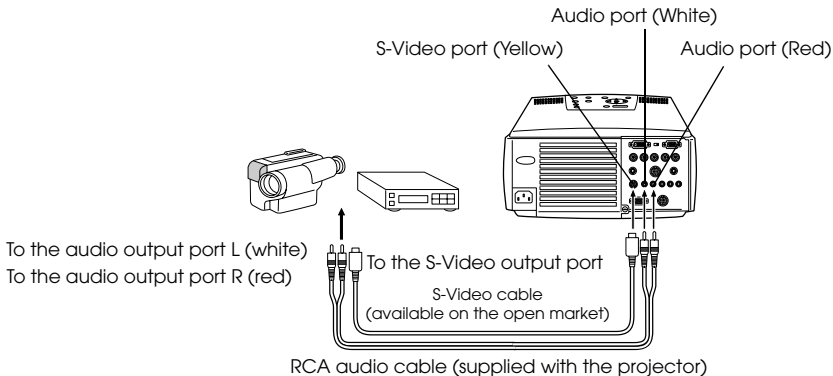

## In the case of component (color differential\*) image signals

- Connect the projector's Computer 2-BNC port to the video equipment with the component image cable (available on the open market) so that the following table is supported.

Video equipment	R-Y(Cr)	Y	B-Y(Cb)
Projector	R/Cr/Pr	G/Y	B/Cb/Pb

- Connect the S-Audio/Audio 2 port with the RCA audio cable supplied (red/white) to output sound from the projector's speakers.

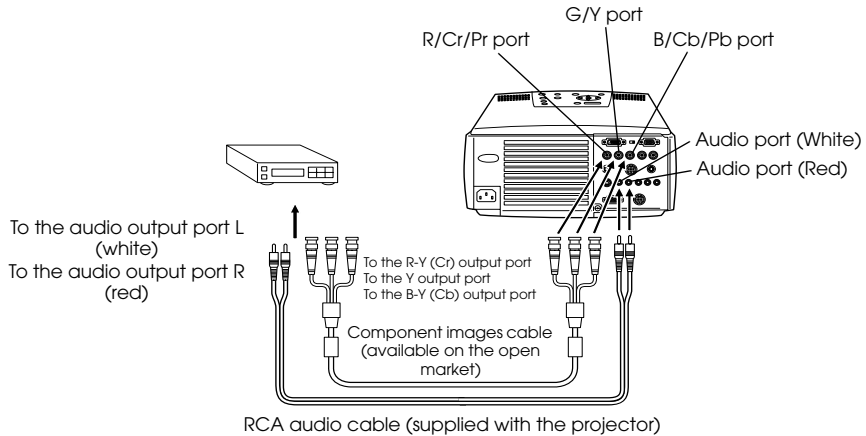

### Point

- A conversion connector (available on the open market) is required on the projector's BNC port when a component image cable is connected. Align the connector on the video side with the port on the user's video equipment.
- Set the BNC parameter to [YCbCr] when the connection has been established. (see page 59)

---

## In the case of RGB image signals

- Connect the projector's Computer 2-BNC port to the video equipment with the component image cable (available on the open market).
- Connect the supplied RCA audio cable (Red/White) to the S-Audio/Audio 2 port if the sound is to be output from the projector's speakers.

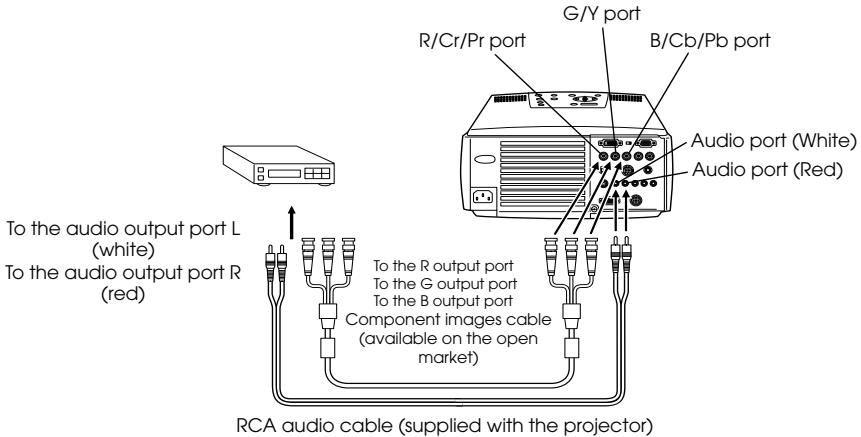

---

### Point

- Purchase the component image cable so that one end matches the BNC type port on the projector and the other matches the port on the video equipment.
  - Set the BNC parameter to [RGB] when the connection has been established. ([see page 59](#))
-



# Projection

Images can be projected after all connections have been completed.

## Preparations

### ⚠ Warning

- Never look directly into the lens once the power supply has been switched on. Failure to observe this may result in the powerful light damaging eyesight.
- Ensure that the power cord supplied is used. The use of cables other than the one supplied may result in the outbreak of fire or electric shocks.

### ⚠ Caution

Do not perform any projection tasks with the lens cover attached. Failure to observe this may result in the cover becoming malformed due to heat.

**1** Connect the projector to a computer and video equipment. (see page 18, 28)

**2** Remove the lens cover.

**3** Attach the supplied power cord to the projector.

Check to confirm the shape of the projector's power inlet and power connector, align the connector in the correct direction, and then insert it as far as it will go.

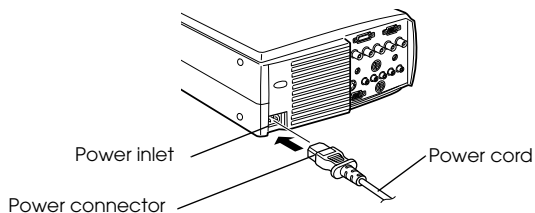

**4** Plug the power plug into the power socket.

The operation indicator will be illuminated in orange.

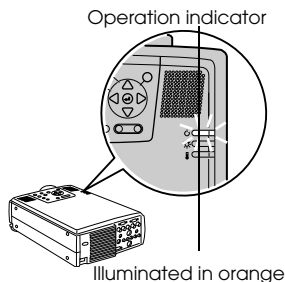

### Point

Button operations are not possible when the operation indicator is blinking in orange.

# Commencing Projection

## 1 Press the [Power] button to turn on the power supply.

The operation indicator will begin to blink in green, and projection will be started.

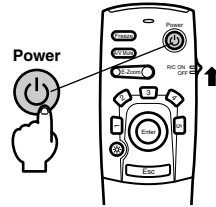
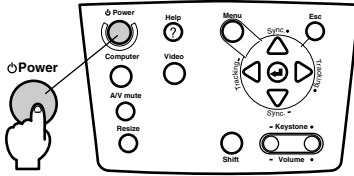

Set the R/C ON OFF switch to (ON) first of all when using the remote control

The operation indicator will blink and then be illuminated in green after approximately thirty seconds.



A message stating (No image signals input) will be displayed when no image signals have been input.  
(Depending on the setting, this may not be displayed. (see page 59))

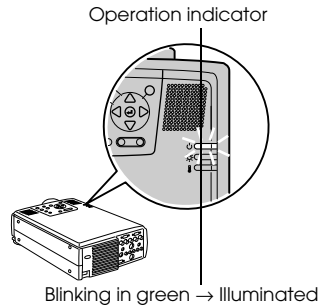

---

### Point

Button operations are not possible when the operation indicator is blinking in green.

---

## 2 Select the port to which the connection has been made when more than one item of equipment has been connected.

Press the port button connected to the computer or video equipment to switch the input source.

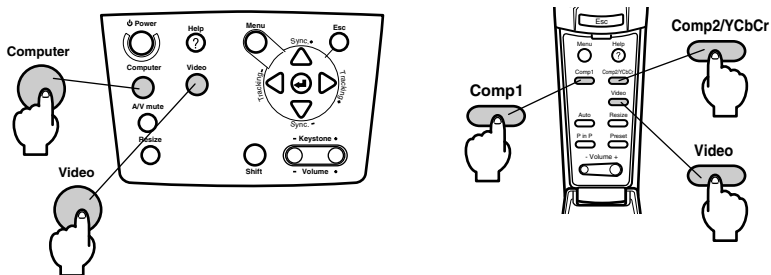

Connected Port	Button to Select		Display at the top right-hand corner of the screen
	Main Unit	Remote Control	
Computer 1 port	[Computer] (will change when- ever pressed)	[Comp1]	Computer1
BNC port (RGB)			BNC(RGB)
BNC port (YCbCr)	[Video] (will change when- ever pressed)	[Comp2/ YCbCr]	BNC(RGB)
Video port			BNC(YCbCr)
S-Video port		[Video] (will change when- ever pressed)	Video
			S-Video

### Point

- Projection will take place without pressing the button if only one item of equipment is connected.
- Computer 1 when no input signals are detected despite the connection being in place and when the images for the connected equipment are not output.
- The BNC port source that switches between [Computer] and [Video] on the main unit and [Comp2/YCbCr] on the remote control can only display either BNC (RGB) or BNC (YCbCr), depending on the BNC setting. (see page 59)

### 3 Starting projection.

Switch on the power supply to the computer or video equipment. If the equipment connected is video equipment, then also press the [Playback] or [Play] buttons.

The [No Signal] display will be erased, and projection will commence.

---

#### Point

- If [No Signal] remains displayed, check the connections once again.
- Depending on the computer, there are cases when it is necessary to switch the image signal output destination with the key (⌘, etc.) or the settings after establishing the connection.

NEC	Panasonic	Toshiba	IBM	SONY	FUJITSU	Macintosh
[Fn]+[F3]	[Fn]+[F3]	[Fn]+[F5]	[Fn]+[F7]	[Fn]+[F7]	[Fn]+[F10]	After rebooting the control panel monitor and sound to be set to mirroring

The table shown above provides examples for certain products. Refer to the computer's instruction manual for further details.

- Press the [Resize] button when signals that support DVD players or wide television screens (16:9 images) have been input. The parameters will change between 4:3 images and 16:9 images whenever the switch is pressed.
  - There are cases where a projected image will remain projected if a still image is projected for a long period of time.
-

# Ending

End projection in accordance with the following procedure.

## 1 Press the [Power] button.

A message to confirm that the power needs to be switched off will be displayed.

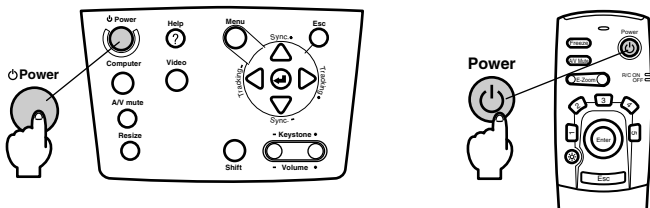

## 2 Press the [Power] button once more.

The lamp will be extinguished, the operation indicator will blink in orange, and the cool-down process will commence.

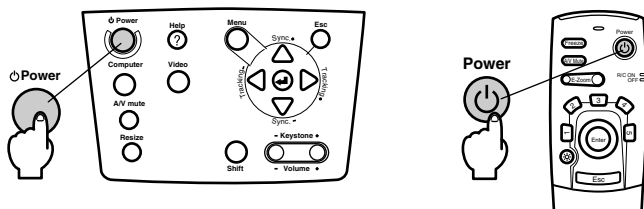

The operation indicator will change from blinking to being illuminated in orange once the cool-down process has been completed. The amount of time required for the cool down is approximately forty seconds (may be longer depending on the ambient temperature).

### Point

- Press a different button if the power is not to be switched off. The message will be erased after seven seconds if no buttons are pressed (the power will remain on).
- It is also possible to end projection by pressing the [Power] button as explained in procedure #1 for more than one second (will assume the same status as if ending with procedure #2).
- Button operations are not possible when the operation indicator is blinking in orange. In this event, please wait until full illumination has been attained.

- 3** Check to confirm that the operation indicator is illuminated in orange, and then unplug the power plug from the socket.

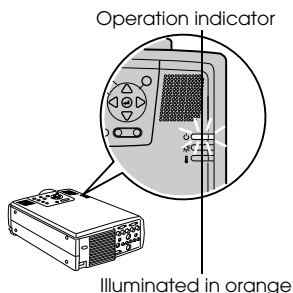

### ⚠ Caution

Do not remove the power plug from the socket when the operation indicator is blinking in orange. Failure to observe this may result in damage to the equipment and will speed up the period for replacing the lamp.

- 4** Set the R/C ON OFF switch to [OFF] when using the remote control.

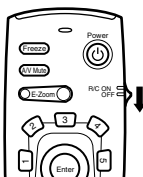

### Point

The batteries are being consumed when the [R/C ON OFF] switch on the remote control is set at [ON]. Ensure that the [R/C ON OFF] switch on the remote control is set to [OFF] when not in use.

- 5** Restore the front foot if it has been extended.

Steady the projector by hand, and then lift the foot adjust lever with a finger and gently lower it into the main unit.

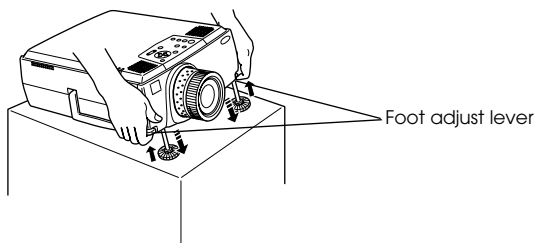

- 6** Attach the lens cover.

# Adjusting the Projection Position

The projector can be adjusted into the following vertical projection positions.

## Feet Adjustments

Adjusts the projection angle of the projector. As far as possible, make the necessary adjustments while making sure that the projector is facing the screen at right angles.

**1** Lift the foot adjust lever with a finger and raise the front part of the projector.

The front foot will protrude.

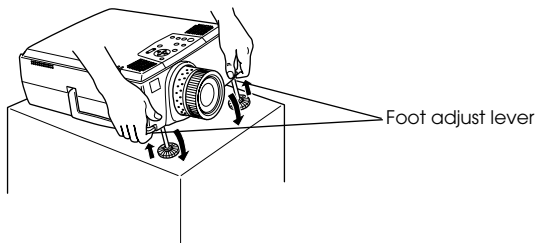

**2** Remove your finger from the foot adjust lever, and then let go of the projector.

**3** Rotate the lower part of the front foot to minutely adjust the height.

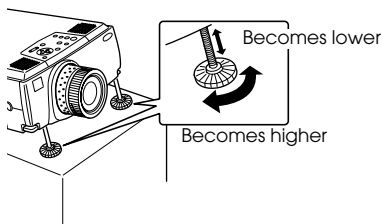

### Point

- There are cases where the screen will be distorted into a trapezoid shape when foot adjustments are performed. This trapezoid distortion can be adjusted with the use of the trapezoid correction function. (see page 38)
- The front foot is restored by lifting the foot adjust lever with a finger and lowering the projector.

# Adjusting the projection size

It is possible to adjust the size of the projection and correct any trapezoid distortion.

## Point

A function to resize the screen ([see page 45](#)) and an E-Zoom function for enlarging certain areas ([see page 47](#)) are also available.

## Zoom Adjustment

- 1 Rotate the zoom ring to make the required adjustments (enlargement up to a maximum of 1.3x is possible).

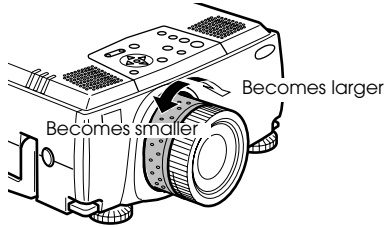

The projection distance must also be adjusted when enlarging the screen. ([see page 16](#))

## Point

If optional lenses are to be used, refer to the relevant instruction manuals for further details.

## Keystone Adjustment

Make the necessary adjustment when the screen has been distorted into a trapezoid with foot adjustment.

- 1 Press the [Keystone +, -] button to lengthen the screen sideways.

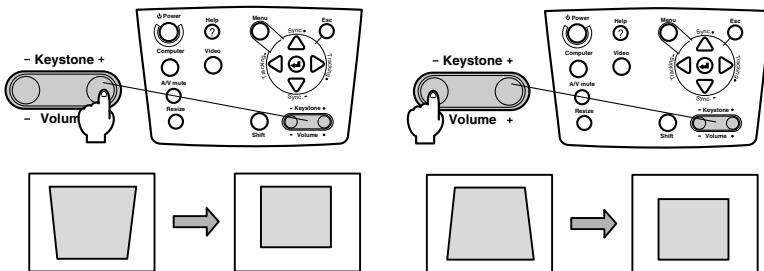

The corrected screen will shrink in size.

The corrected screen will shrink in size.

## Point

- The screen will be reduced in size when keystone correction has been performed.
- The status of keystone correction will be recorded. Perform readjustments that match the installation position when the projection position or angle have been changed.
- Reduce the sharpness if blurring occurs after keystone correction. ([see page 57](#))
- Keystone correction is performed from the menu. ([see page 59](#))



# Picture Quality Adjustment

Adjusts image focus and disturbance.

## Focus Adjustment

Aligns the focus of the image.

- 1 Rotate the focus ring to make the required adjustment.

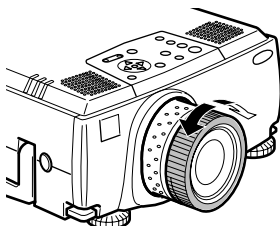

### Point

- It is not possible to align the focus if the lens is dirty or fogged over with condensation. In this event, clean the lens accordingly. (see page 81)
- Correct adjustment is not possible if the installation position is out of line by between 1.1 and 14.6 meters (3.6 ft. and 48.1 ft.).
- If optional lenses are to be used, refer to the relevant instruction manuals for further details.

## Auto Adjustment (when projecting computer images)

Automatically adjusts the computer image to attain the optimum effect. The items adjusted include the tracking, position and synchronization.

- 1 Press the [↵(Enter)] button on the projector (the [Auto] button on the remote control).

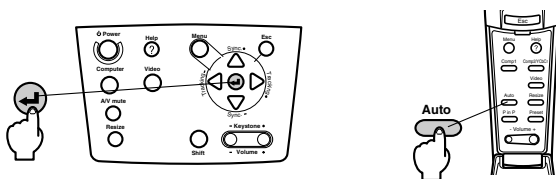

### Point

- If auto adjustments are initiated when the E-Zoom, A/V Mute or P in P functions are executing, adjustment will not be carried out until the executing function has been cancelled.
- Depending on the type of signals being output by the computer, there are cases when adjustment cannot be carried out correctly. In this event, adjust the tracking and synchronization. (see page 40)

---

## Tracking Adjustments (when projecting computer images)

Adjusted when vertical stripes are apparent on the computer image.

**1** Press the [Tracking +, -] button on the projector.

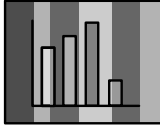

---

## Synchronization Adjustments (when projecting computer images)

Adjusted when flashing, blurring and vertical noise are apparent on the computer image.

**1** Press the [Sync +, -] button on the projector.

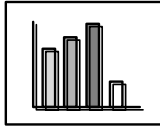

---

## Calling Out Adjustment Values (when projecting computer images)

It is possible to record preset adjustment values and call them out when required.

**1** Press the [Preset] button on the remote control.

The pre-registered numbers between preset #1 and preset #5 will change in sequence whenever this button is pressed.

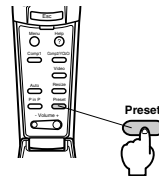
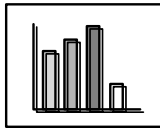

---

### Point

- There are cases when these adjustments must be made again if the values output from the computer (resolution, display color) are amended after flashing and blurring have been adjusted.
  - There are cases where flashing and blurring are caused by adjusting the brightness and contrast\*.
  - Images will be projected more vividly if synchronization adjustments are made after the tracking adjustments.
  - Auto adjustments, tracking adjustments and synchronization adjustments are not possible if no image signals are being input by the computer, such as when projecting video images or displaying menus.
  - The preset values must be registered beforehand. (see page 57)
-

# Introduction of Functions

The functions that can be operated by pressing buttons when images are being projected are listed below.

Function	Outline	Button		Reference Page
		Main Unit	Remote Control	
Help	Displays the method of solving problems when trouble occurs.	Help	Help	42
A/V Mute	Temporarily mutes the image and sound.	A/V Mute	A/V Mute	44
Freeze	Freezes the image.		Freeze	44
Resize	Changes the size of the image.	Resize	Resize	45
E-Zoom	Enlarges the image.		E-Zoom	47
Effect	Adds decorations to the image.		Effect	48
P in P	Adds a sub-screen to the image.		P in P	51
Preset	Calls out pre-registered adjustment values.		Preset	40
Keystone correction	Corrects trapezoid distortion.	Keystone		38
Auto adjustment	Automatically adjusts the image for optimum effect.	↵ (Enter)	Auto	39
Tracking	Adjusts vertical stripes that appear on the image.	Tracking		40
Synchronization	Adjusts flashing, blurring and vertical noise that appears on the image.	Sync		40
Volume	Adjusts the volume.	Shift + Volume	Volume	52
Menu	Displays the menu.	Menu	Menu	55

# Useful Functions

## Help Function

The methods of solving trouble when it occurs are divided into separate sections and explained below for use when problems arise.

### 1 Press the [Help] button.

The help menu will be displayed.

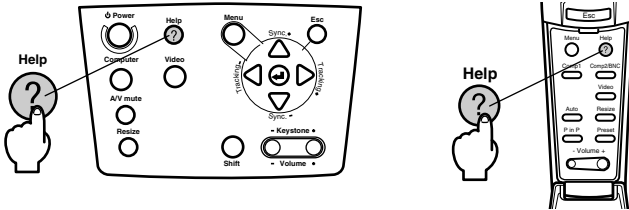

### 2 Select the item.

Press the [Sync+, -] button on the main unit (tilt the [Enter] button up and down on the remote control) to select the item.

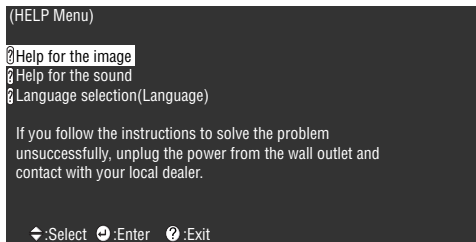

### 3 Set the item.

Set the item by pressing the [↵(Enter)] button on the main unit (the [Enter] button on the remote control).

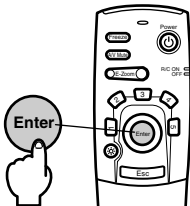

**4** Repeat the operations explained in procedures 2 and 3 to select and set the detailed items.

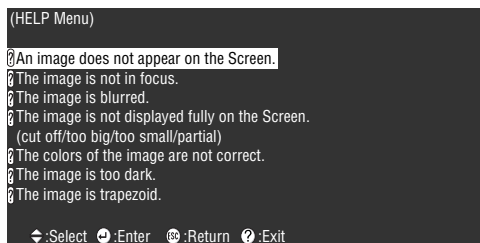

---

**Point**

- Refer to "Troubleshooting" in this manual if the help text does not solve your problems. (see page 70)
  - The help menu can be canceled by pressing the [Esc] or [Help] buttons.
-

# Projection Cutting

It is possible to temporarily erase and stop images and sound.

## A/V Mute Function

Temporarily erases images and sound. It is also possible to project the user logo at this time.

### 1 Press the [A/V Mute] button.

The images and sound will be erased.

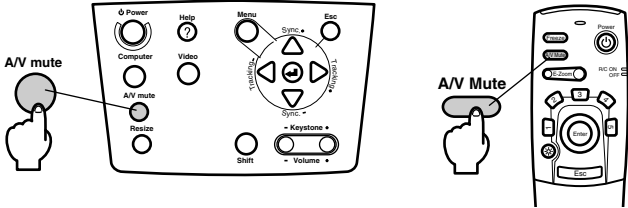

Will be canceled when the [A/V Mute] button is pressed again, when the volume is adjusted, or when the menu is displayed.

Depending on the setting, three different types of statuses may be selected when temporarily erasing images and sound. ([see page 59](#))

Black color



Blue color



User logo



### Point

The EPSON logo has been registered in the user logo. User logo registration and setup is necessary to amend the user logo. ([see page 60](#))

## Freeze Function

Temporarily freezes the image; however, the sound will not be muted.

### 1 Press the [Freeze] button.

The image will freeze.

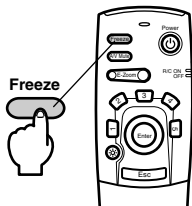

Press the [Freeze] button once more to cancel this mode.

# Switching Image Sizes

The window display and resizing display are switched when projecting images onto a computer. Video image projections are switched between an aspect ratio of 4:3 and 16:9.

## 1 Press the [Resize] button.

The screen size will switch.

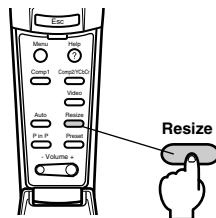
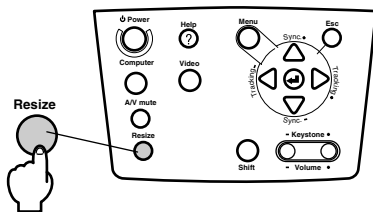

## ● In the case of computer images

Windows display: Projected at the entered resolution. There are cases where the projection size and the image size are different.

Resizing display: Projected with the resolution reduced or expanded so that the image fits the entire size of the projection.

### Example: In the case of 800 x 600

Resizing display

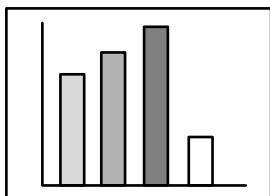

Window display

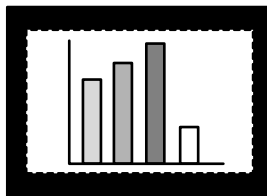

### Example: In the case of 1,600 x 1,200

Resizing display

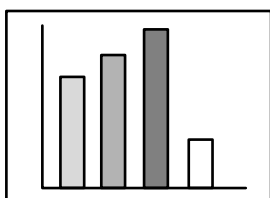

Window display

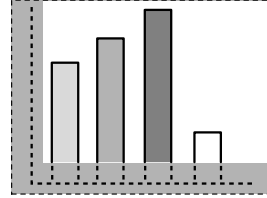

## Point

- The size will not be switched if the display resolution of the liquid crystal is the same as the entered resolution (1,024 x 768 dots).
- A certain portion of the image will not be displayed if the entered resolution is larger than the display resolution of the liquid crystal. Tilt the [Enter] button on the remote control to scroll through the areas not displayed.
- Certain areas on the right and left will not be displayed when SXGA (1,280 x 1,024 dots) is being displayed. Press the [Resize] button while pressing the [Shift] button on the main unit to obtain a full-screen display.

- **In the case of video images**

Switching will be performed for 4:3 and 16:9 image sizes. Images recorded with digital videos and DVD images can be projected on 16:9 wide screens.

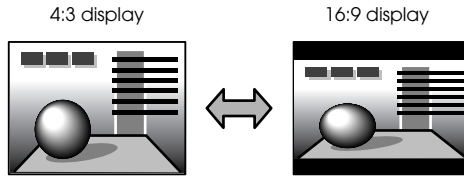



# Enlarging Images (E-Zooming function)

It is possible to enlarge projected sizes without amendment.

## 1 Press the [E-Zoom] button.

The size percentage will be displayed in the bottom right-hand corner to enable the image to be reduced or enlarged.

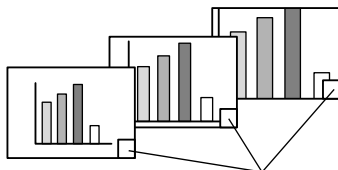

The size percentage will be displayed.

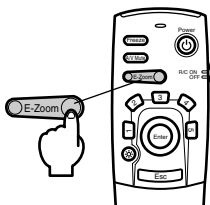

---

### Point

- Enlargement is possible with 24 stages between 1x and 4x at increments of 0.125x.
  - A certain portion of the image will not be displayed when it has been enlarged. Tilt the [Enter] button on the remote control to scroll the screen and display this portion accordingly.
  - Sub-screens will be enlarged when the P in P function is being used.
-

# Effect Function

The [Effect] buttons add decorations to images displayed during presentations. The decoration settings can be amended on the effect menu. ([see page 58](#))

---

## Cursor/Stamp

Imprints a stamp on the image.

**1** Press the [1] button.

The selection will switch between three different cursor/stamps whenever the [1] button is pressed.

**2** Tilt the [Enter] button on the remote control to move the position of the cursor/stamp.

**3** The stamp will be imprinted at the location of the cursor when the [Enter] button on the remote control has been pressed.



---

### Point

- The effect function will be canceled and the cursor will disappear when the [Esc] button is pressed.
- The decoration will be erased when the [5] button is pressed.
- The mouse cannot be used when the effect function is in progress.

---

## Box

Draws a box on the image.

**1** Press the [2] button.

**2** Tilt the [Enter] button on the remote control to move the cursor to the starting position.

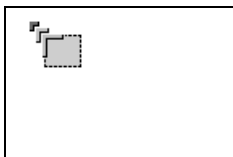

**3** Press the [Enter] button to set the start position.

**4** Tilt the [Enter] button on the remote control to move the cursor to the ending position.

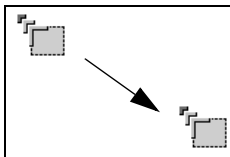

**5** Press the [Enter] button to set the end position.

---

**Point**

- The effect function will be canceled and the cursor will disappear when the [Esc] button is pressed prior to setting the position.
  - The decoration will be erased when the [5] button is pressed.
  - There are cases where the effect will be difficult to see depending on the color combination of the image's background and the box. Amend the color of the box in this event. ([see page 58](#))
  - The mouse cannot be used when the effect function is in progress.
- 

---

## Spotlight

Shines a spotlight on a certain part of the image.

**1** Press the [3] button.

Will switch between three different spotlight sizes whenever the [3] button is pressed.

**2** Tilt the [Enter] button to move the spotlight.

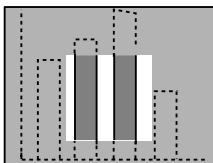

---

**Point**

- The effect function will be canceled and the spotlight will disappear when the [Esc] button is pressed.
  - The mouse cannot be used when the effect function is in progress.
-

---

## Bar

Draws a bar line on the image.

**1** Press the [4] button to display the required cursor/stamp.

The selection will switch between three different bars whenever the [4] button is pressed.

**2** Tilt the [Enter] button to set the end position.

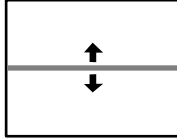

---

### Point

- The effect function will be canceled and the bar will disappear when the [Esc] button is pressed.
  - There are cases where the effect will be difficult to see depending on the color combination of the image's background and the bar. Amend the color of the bar in this event. ([see page 59](#))
  - The mouse cannot be used when the effect function is in progress.
- 

---

## Canceling Effects

**1** Press the [5] button.

The boxes, bars and other effects will disappear.

# P in P Function

The video image will be displayed as a sub-screen inside the computer image or video image.

## 1 Press the [P in P] button.

Operation instructions will be displayed at the bottom left-hand side of the screen and the sub-screen will be displayed at the top right-hand side of the main screen.

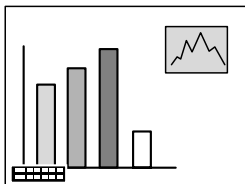

## 2 Tilt the [Enter] button on the remote control to move the position of the sub-screen.

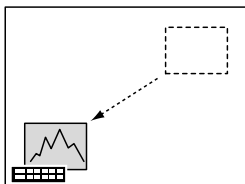

## 3 Press the [E-Zoom] button to change the size of the sub-screen.

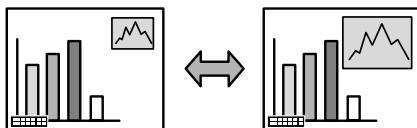

## 4 Press the [1] button to switch across to sub-screen sound.

Press the [2] button to return to the main-screen sound after the sound has been switched.

## 5 Press the [Enter] button to set the sub-screen display.

The operation guide in the bottom left-hand corner will be erased.

---

### Point

- The sub screen will be erased when the [P in P] button is pressed again.
  - The computer image or video image will be displayed in the main screen and the video image (Video, S-Video) will be displayed in the sub-screen, and the video image on the sub screen can be amended with the P in P settings. ([see page 59](#))
  - Switch the position, size, and sound of the sub-screen prior to fixing the sub-screen's display.
  - The sub-screen can be switched between five different sizes.
-

# Volume Adjustment

The volume can be amended when sound is emitted from the projector speakers.

- 1 Press the [Volume+, -] button while pressing the [Shift] button ([Volume+, -] button on the remote control).

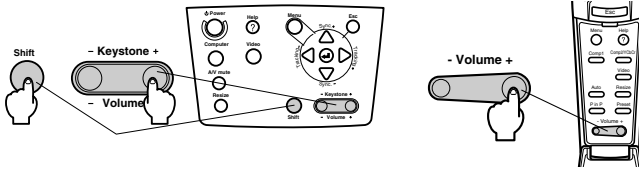

---

## Point

Adjustment is not possible when no sound signals are being input.

---

# Menu Configuration

The setup menu enables the various adjustments and settings to be made.

## Menu Items

The menus are split into top menus and sub menus and consist of a hierarchy structure. Also, the image menu will differ in accordance with the input source (connected port).

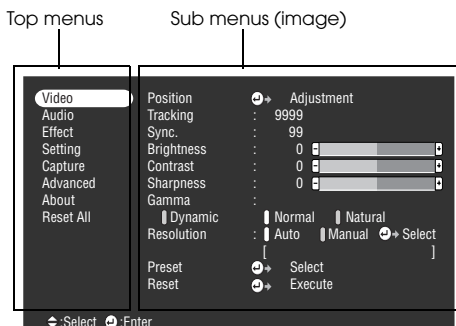

### ● Menu items

Image menu · Computer (D-Sub 15/BNC)



Image menu · Computer (DVI-D)



Image menu · Video (Video/S-Video)



Image menu · Video (BNC)



### Point

- The items displayed on the image menu will differ in accordance with the projected input source, and menus other than that belonging to the projected input source cannot be adjusted.
- The image menu cannot be adjusted when no image signals are being input.

### Sound menu

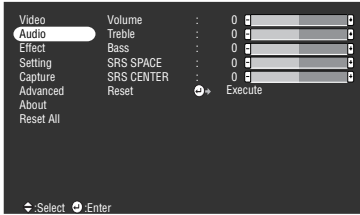

### Effect menu

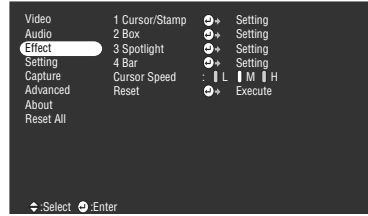

### Setup menu

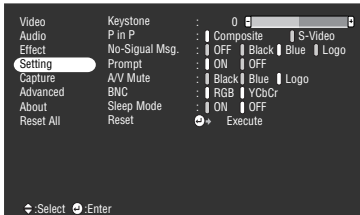

### Capture menu

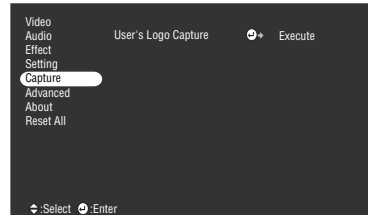

### Advance settings menu



### Information menu



The information menu displays the lamp illumination time and the setup status of the projected input source

### All reset menu

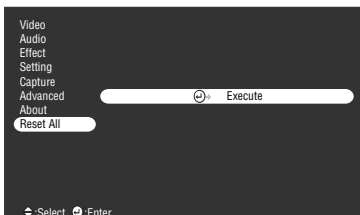

### Point

The lamp illumination time is displayed in units of 0H between 0 and 10 hours, and in units of 1 hour above 10 hours.



# Menu Operations

The menus can be operated from both the projector and the remote control.

## Operation Method

### 1 Press the [Menu] button.

The top menu will be displayed.

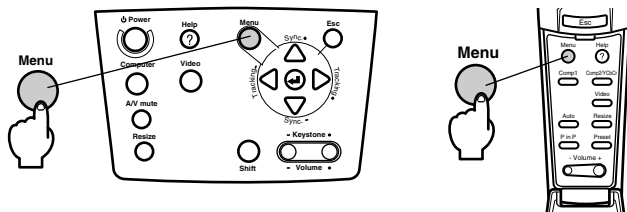

### 2 Select the required item.

Press the [Sync +, -] button on the projector (tilt the [Enter] button up or down on the remote control) to select the required item.

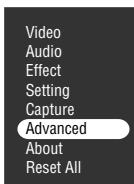

### 3 Set the selected item.

Press the [↵(Enter)] button on the projector (the [Enter] button on the remote control) to set the selected item.

The sub-menu will be displayed.

### 4 Then select the detailed sub item.

Press the [Sync +, -] button on the projector (tilt the [Enter] button up or down on the remote control) to select the sub item.

The items displayed on the image menu and information menu will differ in accordance with the projected input source.

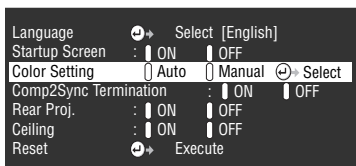

## 5 Select the parameter value.

Press the [Tracking +, -] button on the projector (tilt the [Enter] button left or right on the remote control) to select the parameter value.

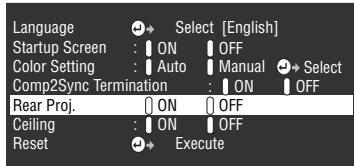

---

### Point

- **↵** (Enter) is attached to the rear of the sub item names that execute the parameters and continue onto the lower hierarchies. Press the [Enter] button to set this selection, and then select the parameter setting again.
- Refer to the list of settings for further information on the function of each setting. ([see page 57](#))

---

## 6 Set all of the other items in the same way.

## 7 Press the [Menu] button.

The menu will end.

---

### Point

- Press the [Esc] button to return to the previous menu in the hierarchy.
  - The items displayed on the image menu will differ in accordance with the projected input source, and menus other than that belonging to the projected input source cannot be adjusted.
  - Image menus cannot be adjusted when no image signals are being input.
  - The last setup screen will be displayed when a menu is ended and then displayed again (the same status as immediately prior to ending the menu with procedure #7.)
-

## Setting Items

Top Menu	Sub Menu	Function	Default Value
Video	Position	Moves the image's display position up, down, left and right. Press the [Enter] button to make the required adjustments on the adjustment screen displayed.	Center value
	Tracking	Adjusts vertical stripes that appear on the computer image.	Depends on the connection signals
	Sync.	Adjusts disturbance, blurring and vertical noise that appear on the computer image. ·Disturbance and blurring may occur as a result of adjusting the brightness and contrast*. ·It is possible to regulate the vividness of the image by adjusting the synchronization after adjusting the tracking.	0
	Brightness	Adjusts the brightness of the image.	Center value
	Contrast*	Adjusts the contrast of the image.	Center value
	Color	Adjusts the color depth of the image.	Center value
	Tint	Adjusts the tint of the image.	Center value
	Sharpness	Adjusts the sharpness of the image.	Center value
	Gamma	Corrects the color vividness of the image. Dynamic: Produces an image with clear color differences. Suitable for displaying plans, etc. Normal: Projects tint without correction. Natural: Produces an image with natural tint. Suitable for video images.	Normal
	Resolution	Sets the input resolution. Auto: Automatically adjusts the input resolution. Manual: Press the [Enter] button and select the required setting from the input resolution selection menu displayed.	Auto
	Preset	It is possible to save the current computer input signal adjustment values (input resolution, tracking, synchronization signals, brightness, contrast, sharpness, gamma and display position). Press the [Enter] button and select the preset number under which registration is to be performed from the preset selection menu displayed. ·The adjustment values registered under a preset number represent the current status of the system. Ensure that the optimum values have been set up before registering this data. ·The preset adjustment values can be called out by pressing the [Preset] button. (see page 40)	Not registered
Smooth Motion	Images, etc., will move smoothly when seen after this has been set at [ON]. Set this at [OFF] if the colors appear to flicker.	ON	

Top Menu	Sub Menu	Function	Default Value
Video	Video Signal	Sets the video signal method. Press the [Enter] button and select the required setting from the video signal method selection menu displayed. · The video signal method will be automatically set up in the [Auto] mode, but do not use the [Auto] mode for the PAL system (60Hz).	Auto
	Reset	Returns all image menu adjustment values to the default values. Press the [Enter] button and then select [Yes] on the confirmation screen displayed. · Select [Reset All] to return all menu settings to the default settings. (see page 61)	-
Audio	Volume	Adjusts the volume.	15
	Treble	Adjusts the strength of the high tones.	Center value
	Bass	Adjusts the strength of the low tones.	Center value
	SRS Space	Adjusts the width of the sound.	2
	SRS Center	Adjusts the depth of the sound.	2
	Reset	Returns all sound menu adjustment values to the default values. Press the [Enter] button and then select [Yes] on the confirmation screen displayed. · Select [Reset All] to return all menu settings to the default settings. (see page 61)	-
Effect	Cursor/Stamp	Sets the shape, size, color and length of the cursor/stamps allocated to the [1] button. Press the [Enter] button and select the item to be displayed from the cursor/stamp setup menu. The shape, size, color and length conditions can be set by pressing button types 1 to 3 respectively (depending on the selected cursor shape, size, color and length cannot be set up.) · The [1] button executes the cursor/stamp function. The cursor/stamp types will be switched between 1 and 3 sequentially for each time the [1] button is pressed. (see page 48)	Individual settings between types 1 to 3
	Box	Set the color, shading and shape of the box allocated to the [2] button. Press the [Enter] button and select the required item from the box setup menu. · The [2] button executes the box function. (see page 48)	Color: Magenta Shading: No Shape: Square
	Spotlight	Sets the size of the spotlight allocated to the [3] button. Press the [Enter] button and select the required item from the spotlight setup menu. · The [3] button executes the spotlight function. (see page 49)	Size: Medium

Top Menu	Sub Menu	Function	Default Value
Effect	Bar	<p>Sets the color, direction and width of the bar allocated to the [4] button.</p> <p>Press the [Enter] button and select the required item from the bar setup menu. The color, direction and width can be selected independently for each of the settings between 1 and 3.</p> <ul style="list-style-type: none"> <li>· The [4] button executes the bar function. The bar types will be switched between 1 and 3 sequentially for each time the [4] button is pressed. (see page 50)</li> </ul>	Individual settings between types 1 to 3
	Cursor Speed	<p>Selects the speed of Cursor.</p> <p>L: Slow M: Medium H: Fast</p>	M
	Reset	<p>Returns all effect menu adjustment values to the default values.</p> <p>Press the [Enter] button and then select [Yes] on the confirmation screen displayed.</p> <ul style="list-style-type: none"> <li>· Select [Reset All] to return all menu settings to the default settings. (see page 61)</li> </ul>	-
Setting	Keystone	<p>Adjusts trapezoid distortion.</p> <ul style="list-style-type: none"> <li>· The screen will be reduced in size when trapezoid correction has been performed.</li> <li>· The status of trapezoid correction will be recorded. Perform readjustments that match the installation position when the projection position or angle has been changed.</li> <li>· Reduce the sharpness if blurring occurs after trapezoid correction. (see page 57)</li> </ul>	Center value
	P in P	<p>Sets the input source for the P in P function's sub-screen.</p> <ul style="list-style-type: none"> <li>· The P in P function is executed by pressing the [P in P] button. (see page 51)</li> </ul>	Composite
	No Signal Msg	<p>The status for [No Image Signal Input] and other message display.</p> <ul style="list-style-type: none"> <li>· The user logo must be registered and set up before it can be amended.</li> </ul>	Blue
	Prompt	<p>Sets whether to display the input source on the screen or not.</p>	ON
	A/V Mute	<p>Sets up the screen status for when the [A/V Mute] button is pressed.</p> <ul style="list-style-type: none"> <li>· The user logo must be registered and set up before it can be amended.</li> </ul>	Black
	BNC	<p>Sets the mode for the input image signals connected to the BNC port.</p> <p>RGB: Enables RGB signals to be input. YCbCr: Enables video signals to be input (YCbCr or YPbPr.)</p>	RGB

Top Menu	Sub Menu	Function	Default Value
Setting	Sleep Mode	Sets the energy-saving function for when no image signals are being input. When this is set at [ON], projection will be automatically ended and the projector will enter the sleep mode if no image signals are input and no operations are performed for a period of thirty minutes (the operation indicator will be illuminated in orange). Press the [Power] button to restart projection.	ON
	Reset	Returns all setting menu adjustment values to the default values. Press the [Enter] button and then select [Yes] on the confirmation screen displayed. · Select [Reset All] to return all menu settings to the default settings. (see page 61)	-
Capture	User's Logo Capture	Registers a user logo. (see page 62) Press the [Enter] button and follow the instructions displayed on the confirmation screen. · The saving procedure requires a certain amount of time to complete. Do not attempt to operate the projector or the equipment connected to the projector while this procedure is running. Failure to observe this may result in damage. · The size that can be registered is 400 x 300 dots. · The display size will be adjusted when video images are being projected.	EPSON logo
Advanced	Language	Sets the language with which messages are to be displayed. Press the [Enter] button and select the required language from the language selection menu displayed.	English
	Startup Screen	Displays the user logo during warm-up after the power has been switched on. · The user logo must be registered and set up before it can be amended.	ON
	Color Setting	Adjusts the color temperature* of the image. Auto: Automatically adjusts the color settings. Manual: Press the [Enter] button and select the required item from the color setting menu displayed. · Set the color temperature value to the yardstick value. · The black level and white level settings are only used when multiple projectors are used in the stack formation.	Auto

Top Menu	Sub Menu	Function	Default Value
Ad- vanced	Comp2 Sync Termination	Sets the Computer 2 termination mode to enable image processing from a Port. ON: Terminated in analog (75Ω) OFF: TTL input · Usually used at [OFF]. Set at on with the switcher when analog (75Ω) termination is required.	OFF
	Rear Proj.	Set at [ON] to project images onto a half-transparent screen from the rear. The projected image will be inverted.	OFF
	Ceiling	Set at [ON] to project images when suspended from the ceiling. The projected image can be inverted from left to right and up and down. · The optional ceiling suspension unit is required to suspend the projector from the ceiling. (see page 87)	OFF
	Reset	Returns all advanced setting menu adjustment values to the default values. Press the [Enter] button and then select [Yes] on the confirmation screen displayed. · Select [Reset All] to return all menu settings to the default settings.	-
About		(Displays the current settings)	-
Reset all	Execute	Resets all items in all setting menus to their default settings. Press the [Enter] button and then select [Yes] on the confirmation screen displayed. · Execute the [Reset] function from each individual sub menu to return the image and sound settings to the default values for each menu. · The user logo, lamp illumination time, language and BNC settings cannot be restored to the default values. Reset the lamp illumination time after the lamp has been replaced. (see page 86)	-

- The image menu and information displayed will differ in accordance with the projected input source, and menus other than that belonging to the projected input source cannot be adjusted.
- The information menu displays the status of the input source settings being projected.

# User Logo Registration

Registers the images currently displayed as the user logo.

- 1** Displays the image that is to be registered as the user logo.
- 2** Press the [Menu] button and select [Capture] - [User's Logo Capture].  
The confirmation screen will be displayed.

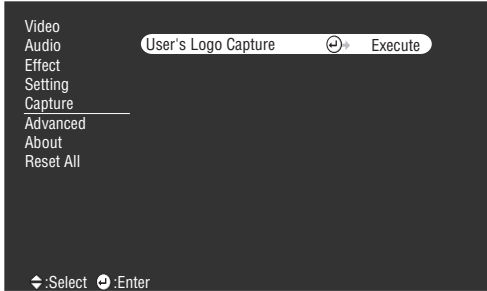

- 3** Select [Yes] and then press the [↵ (Enter)] button on the main unit (the [Enter] button on the remote control).  
The image to be registered will be displayed.



- 4** Adjust the position of the image and then press the [↵ (Enter)] button on the main unit (the [Enter] button on the remote control).  
The confirmation screen will be displayed.

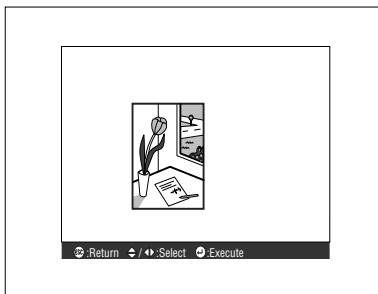



- 5** Select [Yes] and then press the [↵(Enter)] button on the main unit (the [Enter] button on the remote control).

The enlargement setup screen will be displayed.



- 6** Select the enlargement rate and then press the [↵(Enter)] button on the main unit (the [Enter] button on the remote control).

The screen to confirm saving will be displayed.

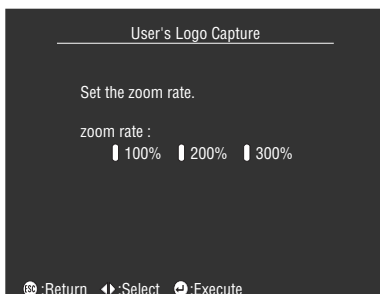

- 7** Select [Yes] and then press the [↵(Enter)] button on the main unit (the [Enter] button on the remote control).

The image will be saved. Wait until the [saving completed] screen is displayed.



---

### Point

- A certain amount of time is required for the saving process. Do not operate the projector or connected equipment while saving is in progress. Failure to observe this may result in defects.
  - The image size that can be registered is 400 x 300 dots.
  - The display size will be amended when the video image is being projected.
-

# Introduction of Projector Software

The projector software includes the following.

## Outline of Projector Software

The various types of projector software available are explained below.

### ● EMP Link V

Enables the projector settings to be amended from the computer. This allows functions to be allocated to the [Effect] button and a user logo to be edited (refer to the EMP Link V Users' Guide (PDF)).

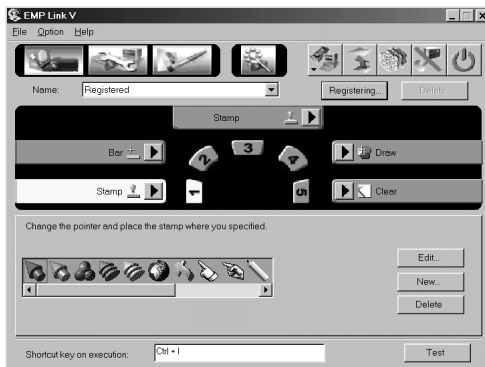

# Computer Connections

Establish a serial connection between the computer and projector when EMP Link V is being used. The computer and projector can be connected together with serial.

## Serial Connections

### ⚠ Caution

- Ensure that the power supply to the projector has been switched off before attempting to establish the connection. Failure to observe this may result in equipment damage.
- Confirm the shape of the cable connector and the port before establishing the connection. If connections are forced despite the connector and port being different shapes, it may result in malfunctions and equipment damage.

### Point

- Depending on the shape of the computer port, an adapter may be required for connection purposes. Refer to the computer's instruction manual for further details.
- The connected computer is used to amend the projector settings and to perform operations. Connect the computer that is required to output projection images to the Computer 1 or Computer 2 port. (see page 18)
- Switch on the projector and ensure that the connection has been set up before using the software.

## ● Windows Computers

Connect the projector's Mouse/Com port to the computer's serial port with the use of the PC serial cable and main cable supplied.

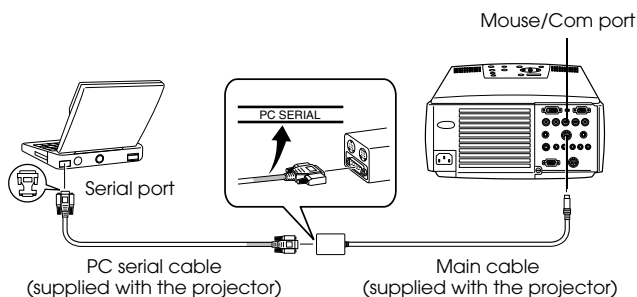

## ● Macintosh Computers

Connect the projector's Mouse/Com port to the computer's printer port or modem port with the use of the Mac serial cable and main cable supplied.

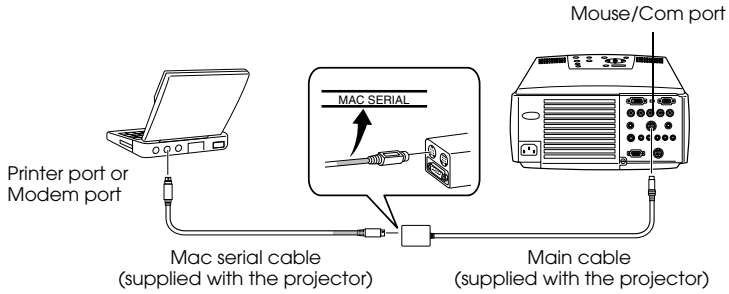

# Installation

This section explains how to install the EMP Link V.

## Operating Environment

Check the following to ensure that the software can operate on the computer in use.

### ● Windows Operating Environment

Windows	
Operable computer	NEC PC98-NX series or DOS/V computers operating on the Windows 95/98/NT4.0/2000 platform CPU: Pentium133MHz or more
Available memory capacity	32MByte or more (an additional 8MBytes when operating the Acrobat Reader)
Available hard disk capacity	· EMP Link V /EMP Link PDF User's Guide 5MByte or more
	· Acrobat Reader 10MByte or more**
Display	Resolution of 16bit High Color (640x480) or more

\*\*20MByte or more is required for the Chinese and Korean languages.

### ● Macintosh Operating Environment

Macintosh	
Operable computer	Operating on Mac OS 7.6/8.0/8.1/8.5/8.5.1/8.6/9.0/9.0.4/9.1 CPU: Power PC or more
Main memory capacity	32MBytes or more (22MByte when operating the Acrobat Reader)
Available hard disk capacity	· EMP Link V /EMP Link PDF User's Guide 5MByte or more
	· Acrobat Reader 8MByte or more**
Display	32,000 Color (640 x 480) or more

\*\*15MByte or more is required for the Japanese language, and 25MByte or more is required for the Korean language.

---

## Installation

This section explains how to install the software using the Windows 98 screens. Software installation into the Windows 95 platform follows the same procedure.

---

### Point

The EMP Link V User's Guide is stored on the CD-ROM in the PDF format. As Acrobat Reader is required to read this, it is recommended that it is installed at the same time as EMP Link V for computers that do not have this function.

---

## ● In the case of Windows

### 1 Start up Windows and set the CD-ROM in place.

The set-up program will start automatically.

---

### Point

If the set-up program does not start automatically, open the [Specify and execute file name] dialog box from the [Start] – [Specify and execute file name] menu, and enter [CD-ROM drive name: \SETUP].

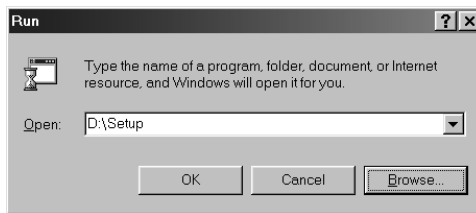

---

### 2 Select the language and the program to be installed and then press the [OK] button.

Installation will then commence. Proceed with all subsequent screens in accordance with the instructions provided.



---

### Point

The program can be un-installed by selecting [EMP Link V] from the [My Computer] – [Control Panel] – [Add and Delete Applications] menu and then executing [Add and Delete].

---

- **In the case of the Macintosh**

**1** Start up the Macintosh and then set the CD-ROM in place.

**2** Double-click on the EMP Link Installer icon.

The set-up program will start up automatically.

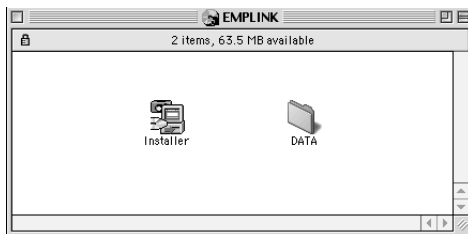

**3** Select the language and click on the [OK] button.

Proceed with all subsequent screens in accordance with the instructions provided.



**Point**

Drag the [EMP Link V] folder and [EMP Link V] contained in [System] – [Default Settings] into the trash can to un-install the program.

---

## Reading the User's Guide

- **In the case of Windows**

Select [Start] – [Programs] – [EMP Link V] – [User's Guide] to open the file.

- **In the case of the Macintosh**

Double-click on the [User's Guide] icon contained within the [EMP Link V] folder to open the file.

# Troubleshooting

When you think you have a problem, first of all check the indicators on the projector. The projector is fitted with operation indicator, lamp indicator and temperature indicator to advise the user of the projector's status.

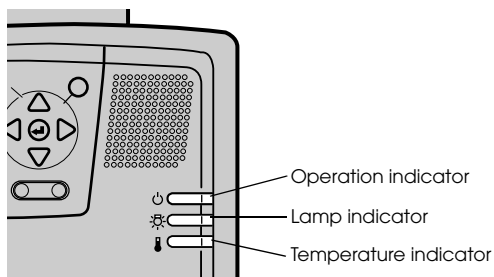

## Operation Indicator

Indicator Status	Cause	Recovery or Status	Reference Page
Illuminated in Orange	Stand-by status	(Not an error) Projection will be started when the [Power] button is pressed.	31
Blinking in Orange	Cool-down procedure in progress	(Not an error) · Wait for a moment. The amount of time for the projector to cool down* (cooling the lamp) will depend on the external temperature, etc. · The [Power] button cannot be used during the cool-down period. This will be illuminated in orange once the cool-down process has been completed, so press the button once more then.	35
Illuminated in Green	Projection in progress	(Not an error)	32
Blinking in Green	Warm-up in progress	(Not an error) · Wait for a moment. · The amount of time required for the warm-up procedure is approximately 30 seconds. · The green lamp will stop blinking and become illuminated once the warm-up procedure has been completed.	32
Illuminated in Red	Internal error	Cease operations, remove the power plug from the socket and contact your dealer or nearest address provided at "International Warranty Conditions" in "Safety Instructions/World-Wide Warranty Terms" included in the package and request repairs.	



Indicator Status	Cause	Recovery or Status	Reference Page
Extinguished	The power is not switched on	<p>The power is not switched on.</p> <ul style="list-style-type: none"> <li>· Check to ensure that the lamp or fan are correctly attached if the lamp has been replaced. If the lamp or fan are not correctly attached, the projector will assume the same status as if the power has not been switched on.</li> <li>· Check the power cord connection.</li> <li>· Check the power supply to the socket.</li> </ul>	31

## Lamp Indicator

Indicator Status	Cause	Recovery and Status	Reference Page
Blinking in Red	Lamp error	<ul style="list-style-type: none"> <li>· First, remove the lamp and check to see if it is broken (be careful not injure yourself on broken glass if the lamp is broken). If the lamp is not broken reset it. Next, plug in the power plug and turn on the main unit's power. If the problem still persists or the lamp is broken, contact your dealer or nearest address provided at "International Warranty Conditions" in "Safety Instructions/World-Wide Warranty Terms" included in the package (images cannot be projected unless the lamp is replaced).</li> <li>· Check to ensure that the lamp or fan are correctly attached if the lamp has been replaced. If the lamp or fan are not correctly attached, the projector will assume the same status as if the power has not been switched on.</li> </ul>	84
Blinking in Orange	Nearing the time for replacing the lamp	Prepare a new lamp. It is recommended that the lamp is replaced as soon as possible, as there are cases where the time for replacement is earlier than stated in the conditions of usage.	84
Extinguished		<p>(Not an error)</p> <p>The power has not been switched on or normal projection is in progress.</p>	

## Temperature Indicator

Indicator Status	Cause	Recovery and Status	Reference Page
Illuminated in Red	Excessive internal temperature (overheating)	<p>The lamp goes off automatically and projection becomes impossible. Wait for approximately 5 minutes with the projector in that state. After 5 minutes has passed, pull out the power plug once, then insert it again.</p> <p>If the projector overheats, check the following 2 points and make the necessary improvements.</p> <ul style="list-style-type: none"> <li>· Is the projector installed in a place with good ventilation?</li> <li>· Make sure the air intake and exhaust vents are not covered, and that it is not placed up against the wall.</li> <li>· Has dust accumulated in the air filter?</li> <li>· If the air filter is dirty, clean it.</li> </ul> <p>When the power plug is reinserted, the projector will recover to the normal state, so press the [Power] button and turn on the power again. If the projector overheats again even when the above measures have been taken, and when an error is displayed in the indicator, and when the power is turned on again, discontinue use, pull the power plug out of the receptacle and request repairs by the retail shop where you purchased it, or by the service office at the nearest address provided at "International Warranty Conditions" in "Safety Instructions/World-Wide Warranty Terms" included in the package.</p>	15  82
Blinking in Red	Internal error	<p>Cease operations, remove the power plug from the socket and contact your dealer or nearest address provided at "International Warranty Conditions" in "Safety Instructions/World-Wide Warranty Terms" included in the package and request repairs.</p>	
Blinking in Orange	High-temperature cooling in progress	<ul style="list-style-type: none"> <li>· Not an error. Projection will be automatically suspended if the temperature increases further.</li> <li>· There are cases where high-speed cooling is activated if the temperature exceeds approximately 35 degrees Celsius when the projector is in use, although this will differ depending on the environment in which it is being used and the method in which it is being used. Although usage may be continued, it is recommended that the projector is used in environments with a prevalent temperature below 35 degrees Celsius.</li> <li>· Install the projector in a well-ventilated place and ensure that the ventilation inlet and outlet are not blocked.</li> <li>· Clean the air filter.</li> </ul>	15  82
Extinguished		<p>(Not an error) The power has not been switched on or normal projection is in progress.</p>	

### Point

- Refer to the section on "When the Indicators Provide No Help" on the following page if the indicators appear normal but the projected image is defective.
- Contact your dealer or nearest address provided at "International Warranty Conditions" in "Safety Instructions/World-Wide Warranty Terms" included in the package if an indicator status not covered by the above table is apparent.

# When the Indicators Provide No Help

Refer to each relevant item if the following situations arise but the indicators provide no help.

- The image is not projected [page 73](#)
- The image is unclear [page 75](#)
- The image is cut up (Large)/Small [page 77](#)
- The image color is bad [page 77](#)
- The image is dark [page 78](#)
- No sound [page 78](#)
- The remote control won't work [page 79](#)
- Cannot end [page 79](#)
- The EMP Link V will not function [page 80](#)

---

## The image is not projected

### ● Nothing is displayed



Nothing is displayed

- **Is the lens cover still in place?**  
[see page 31](#)
- **Has the power been switched off and then on immediately?**  
The [Power] button will not operate after projection has been finished (during the cooling down procedure). The [Power] button will work again after the cooling down\* process Projection lamp cooling operations: the operation indicator is illuminated in orange has been completed.  
[see page 35](#)
- **Is the sleep mode set at ON?**  
When the sleep mode has been set at [ON], the lamp will be automatically extinguished if no operations occur and no signals are input for a period of thirty minutes.  
[see page 60](#)
- **Did you press the [Power] button?**  
[see page 32](#)
- **Has the brightness of the image been correctly adjusted?**  
[see page 57](#)
- **Is the system in the [A/V Mute] mode?**  
[see page 44](#)
- **Is the input image completely black?**  
There are cases where input images will become completely black owing to screen savers, etc.
- **Are image signals being input?**  
No message will be displayed if the [Menu] - [Setting] - [No Signal Msg] parameter is set at OFF. Set this to black or blue to display the message.  
Refer to the relevant items when the message is displayed.  
[see page 74](#)

## ● Messages



[Not Supported]  
will be displayed



[No Signal]  
will be displayed

- **Is the resolution of the image signal output from the computer higher than UXGA (1,600 x 1,200)?**  
see page 18
- **Check to ensure that the mode supports the frequency of the image signals output from the computer.**  
Refer to the computer's instruction manual to discover how to amend the resolution and frequency of the image signals output from the computer.  
see page 18
- **Have the cables been connected correctly?**  
see page 18
- **Has the correct image input port been selected for the connection?**  
Press the [Computer] or [Video] buttons on the projector ([Comp1], [Comp2/YCbCr] [Video] on the remote control) to switch the image.  
see page 33
- **Has the power supply to the connected computer or video equipment been switched on?**  
see page 34
- **Are image signals being output from the connected computer or video equipment?**
- **Note-type and liquid crystal type computers must output image signals to the projector.**  
Image signals are not output externally simply because they are output to the LCD screen under normal conditions, so the setting must be switched to external output.  
There are models for which image signals are not output to the LCD screen when output externally.  
see page 18
- **Is 5BNC being input and the [Menu] – [Setting] – [BNC] parameter set at [YCbCr]?**  
Set to [RGB].  
see page 22
- **Is [Component Video (color difference)] being input and the [Menu] – [Setting] – [BNC] parameter set at [RGB]?**  
Set to [YCbCr].  
see page 29

## The image is unclear

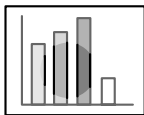

- The screen is blurred.
- Focus can only be attained in certain areas.

- **Has the focus been set correctly?**  
[see page 39](#)
- **Has the projection angle been increased by adjusting the feet?**  
There are cases where the vertical focus is difficult to align if the projection angle is too large.
- **Is the projection distance suitable?**  
The recommended projection distance range is between 1.1m and 14.6m (3.6ft. and 48.1ft.). Locate the projector within this distance range.  
[see page 16](#)
- **Is the lens soiled?**  
[see page 81](#)
- **Is the projection light shining at right angles onto the screen?**  
[see page 17](#)
- **Is the lens fogged?**  
Condensation will form on the surface of the lens when the projector is suddenly brought into a warm room from a cold room, and this may lead to the image seeming blurred. In this event, switch the power off and leave the unit to stand for a while.
- **Has the [Sync., Tracking and Position] been adjusted?**  
The image can be adjusted by regulating the [Tracking] and [Sync] buttons on the projector while monitoring the image on screen. Adjustments can also be made by opening the [Menu].  
[see page 40, 57](#)
- **Has the signal format setting for the image been set correctly?**
  - In the case of computer images:  
Set the signal format with [Menu] – [Video] – [Resolution]. There are cases where the image signals being input cannot be determined in the [Auto] mode.  
[see page 57](#)
  - In the case of video images:  
Select the video signal format with [Menu] – [Video] – [Video Signal]. There are cases where the video image signals being input cannot be determined in the [Auto] mode.  
[see page 58](#)

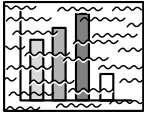

- The image is disturbed.
- Noise appears

- **Has the cable been connected correctly?**

see page 18, 28

- **Is the selected resolution correct?**

Align the computer with the signals supported by the projector. Refer to the computer's instruction manual for details on how to amend the signals.

see page 18

- **Has the [Sync\*, Tracking and Position] been adjusted?**

The image can be adjusted by regulating the [Tracking] and [Sync] buttons on the projector while monitoring the image on screen.

Adjustments can also be made by opening the [Menu].

see page 40, 57

- **Has the cable length been extended?**

There are cases where noise will occur if the cable length is extended.

- **Has the signal format setting for the image been set correctly?**

· In the case of computer images:

Set the signal format with [Menu] – [Video] – [Resolution]. There are cases where the image signals being input cannot be determined in the [Auto] mode.

see page 57

· In the case of video images:

Select the video signal format with [Menu] – [Video] – [Video Signal].

There are cases where the video image signals being input cannot be determined in the [Auto] mode.

see page 58

---

## The image is cut up (Large)/Small

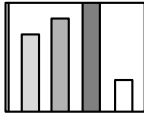

- The image is cut up
- The image is small

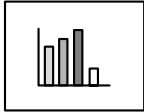

- **There is a possibility that the [Resize] setting has not been correctly selected.**  
Press the [Resize] button.  
[see page 45](#)
- **Has the [Position] been adjusted?**  
Adjust with [Menu] – [Video] – [Position].  
[see page 57](#)
- **Is the selected resolution correct?**  
Align the computer with the signals supported by the projector. Refer to the computer's instruction manual for details on how to amend the signals.  
[see page 18](#)
- **Amend the resolution for note-type and liquid crystal type computers.**  
Either amend the resolution so that the display fills the entire screen, or set the image signals so that only external output is possible.  
[see page 18](#)
- **Has the system been set for dual display?**  
Only half of the computer screen's image will be displayed with the projector if dual display has been set with [Display Properties] on the control panel. Cancel the dual display setting to display the entire computer screen image. Refer to the video driver manual supplied with the computer in use for further details.

---

## The image color is bad

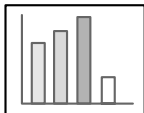

- **Has the image brightness been correctly adjusted?**  
[see page 57](#)
- **Have the cables been connected correctly?**  
[see page 18, 28](#)
- **Has the contrast\* been correctly adjusted?**  
[see page 57](#)
- **Has the color setting been correctly adjusted?**  
[see page 60](#)
- **Have the color depth and tint been correctly adjusted?**  
(The display on the computer monitor or the liquid crystal screen will not always match up with the tint of the image, but this is not an abnormality.)  
[see page 57](#)
- **Is it time to replace the lamp?**  
If the lamp indicator is blinking, it means that the time to replace the lamp is drawing near. When the time to replace the lamp draws near, the image will appear dark and the tint will deteriorate. In this event, replace the lamp with a new one.  
[see page 84](#)

---

## The image is dark

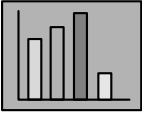

- **Is it time to replace the lamp?**  
If the lamp indicator is blinking, it means that the time to replace the lamp is drawing near. When the time to replace the lamp draws near, the image will appear dark and the tint will deteriorate. In this event, replace the lamp with a new one.  
[see page 84](#)
- **Has the image brightness been correctly adjusted?**  
[see page 57](#)
- **Has the contrast been correctly adjusted?**  
[see page 57](#)

---

## No sound

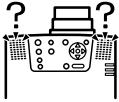

- **Has the sound input been connected correctly?**  
[see page 24, 28](#)
- **Has the image for which sound is required been selected?**  
[see page 33](#)
- **Is sound being emitted from connected equipment?**  
Confirm the sound from connected equipment, etc.
- **Has the volume been turned right down?**  
[see page 52](#)
- **Has the [A/V Mute] function been left on?**  
There is a possibility that the [A/V Mute] mode is in effect. Press the [A/V Mute] button, adjust the volume, or display the menu to cancel the [A/V Mute] status.  
[see page 44](#)



---

## The remote control won't work



- Is the [R/C ON OFF] switch on the remote control on?  
[see page 32](#)
- Is the remote control being aimed in the correct direction?  
The operable range of the remote control is 30° to the left and right, and 15° up and down.  
[see page 13](#)
- Is the distance between the remote control and the projector too great?  
The operable distance of the remote control is approximately 10m.  
[see page 13](#)
- Is the remote control receiver connected and the remote control being aimed at the projector?
- Is the light-receiving area on the remote control blocked?
- Has the remote control light-receiving area been subject to direct sunlight, fluorescent light or any other strong light source?
- Have the batteries been mounted in place?  
[see page 14](#)
- Have the batteries run out?
- Have the batteries been mounted back to front?  
[see page 14](#)

---

## Cannot end (after the [Power] button has been pressed)

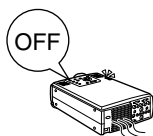

- **Is the operation indicator illuminated in orange?**  
The projector has been designed so that the operation indicator is not extinguished even when the power has been switched off. The operation indicator will be extinguished when the power plug has been disconnected from the socket.
- **The fan will not cease operations.**  
The cool-down\* process (to allow the projector lamp to cool down; the operation indicator will blink in orange) will be performed after the power has been switch off by pressing the [Power] button. The operation indicator will be illuminated in orange when this has been completed, so remove the power plug from the socket at this point.  
\*\*The amount of time required for the cool-down process will depend on the external temperature.

---

## EMP Link V will not function



- **Are the connection settings correct?**  
Select a COM port number that is not being used by a printer or modem.
- **Have the cables been connected correctly?**
- **Were the connections established with the power supply switched off?**
- **Is the signal extension cord too long?**
- **Did installation end normally?**  
Re-install if not.
- **Has the power supply to the projector been switched on?**  
Reboot the computer.

---

### Point

If an abnormality remains after checking the results of the above inspections, disconnect the power plug from the socket and consult with your dealer or nearest address provided at "International Warranty Conditions" in "Safety Instructions/World-Wide Warranty Terms" included in the package.

---

# Cleaning the Projector, Cleaning the Lens, Cleaning the Air Filter

Clean the projector if it becomes soiled or if the quality of the projected images deteriorate. Please clean the air filter about every 100 hours of operation.

## Warning

- Personnel other than qualified servicemen must never open the projector. Many high-voltage parts are contained inside the cover that may cause electric shocks. Contact your dealer or your nearest address provided at "International Warranty Conditions" in "Safety Instructions/World-Wide Warranty Terms" included in the package to request internal inspections, repairs, adjustments, cleaning and other tasks.
- Exercise caution when handling the power plug and power connector. Mishandling may result in the outbreak of fire and electric shocks. Observe the following when handling the power plug.
  - Do not connect plugs or connectors that have become dirty or have foreign matter adhering to them.
  - Ensure that the plugs and connectors are firmly inserted in the relevant sockets as far as they will go.
  - Never attempt to connect plugs and connectors with wet hands.

## Caution

- Never attempt to remove the lamp immediately after use. Failure to observe this may result in burns or other injuries. Allow the projector to cool down for at least sixty minutes after the power supply has been switched off.
- Disconnect the power plug and power connector from their sockets when carrying out maintenance tasks. Failure to observe this may result in electric shocks.

Switch off the power supply and disconnect the power cord prior to cleaning any part of the projector.

---

## Cleaning the Projector

- Gently wipe the soiled parts of the projector with a soft cloth.
- When the soiling is severe, wipe the area with a cloth moistened with neutral detergent diluted with water, and then gently wipe it with a dry cloth.  
Never use wax, benzene, thinner or other active agents. Failure to observe this may result in damage or paint peeling from the casing.

---

## Cleaning the Lens

Clean the lens with an air-blower (available on the open market) and special lens cleaning paper. The surface of the lens is easily damaged, so exercise extreme caution and avoid using anything other than soft materials.

---

## Cleaning the Air Filter

Air ventilation will deteriorate and the internal temperature of the projector will rise if the air filter becomes blocked with dirt and dust, and this may result in damage.

Ensure that the projector is stood on its end and the air filter cleaned with a vacuum cleaner to prevent the dirt and dust from penetrating inside.

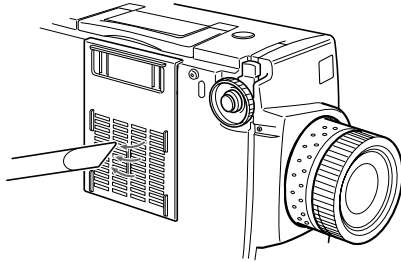

---

### Point

- If it is no longer possible to remove the dirt from the air filter or it begins to crack, it is time to replace it. Contact your dealer in this event.
  - A replacement air filter is packaged with the replacement lamp. Replace the air filter at the same time as replacing the lamp.
-

# Replacing the Air Filter

## Replacement Method

- 1** Switch off the power supply, allow the projector to cool down\*, and then disconnect the power cord.

The amount of time required for the projector to cool down will depend on the surrounding temperature.

- 2** Remove the air filter.

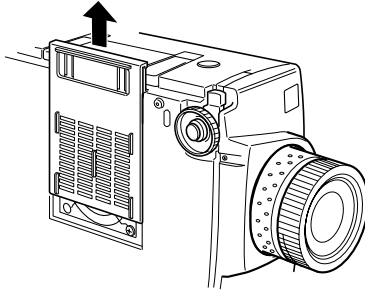

---

### Point

Ensure that the projector is stood on its end when replacing the air filter to prevent the dirt and dust from penetrating inside.

---

- 3** Set a new air filter in place.

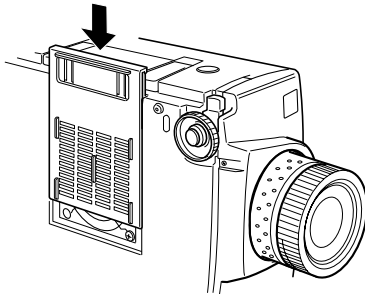

---

### Point

Insert the clips before pressing on the catch to set the air filter in place.

---

# Replacing the Lamp

Replace the lamp at the following times (model number: ELPLP11).

**When a message stating [Lamp Replace] is displayed for thirty seconds after the start of projection**

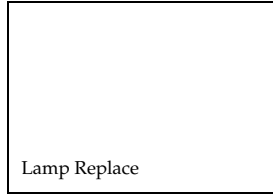

**When the lamp indicator is blinking in orange**

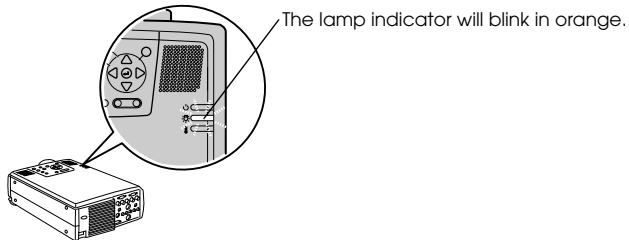

**When the brightness and picture quality has deteriorated below the initial levels**

---

## Point

- Replace the lamp as quickly as possible after the message has been displayed to maintain the initial brightness levels and picture quality.
  - The replacement message has been set at approximately 1,900 hours of use in order to maintain the initial brightness levels and picture quality. If you continue to use the lamp after this period, the possibility of the lamp breaking becomes greater. When the lamp replacement message appears, replace the lamp with a new one as soon as possible, even if it is still working.
  - Although the replacement message is displayed after approximately 1,900 of use, there are cases where the individual characteristics of each lamp and other usage conditions result in it not lighting up before this 1,900 hours has elapsed. For this reason, always prepare a replacement lamp well in advance.
  - Contact your dealer for a spare lamp.
-

## Replacement Method

- 1** Switch off the power supply, allow the projector to cool down\*, and then disconnect the power cord.

The amount of time required for the projector to cool down will depend on the surrounding temperature.

- 2** Once the projector has cooled down sufficiently, remove the fan.

- Approximately sixty minutes are required for the projector to cool down sufficiently.
- Remove the two screws holding the fan in place.

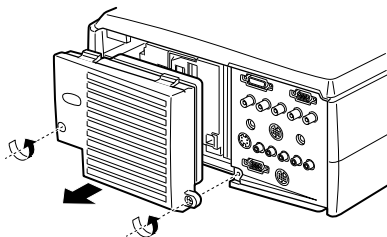

- 3** Withdraw the lamp.

Loosen the three screws holding the lamp in place, and then pull the lamp out towards you.

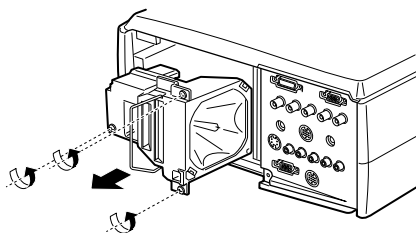

- 4** Attach a new lamp.

Align the direction, push the lamp in as far as it will go, and then secure it in place with the three screws.

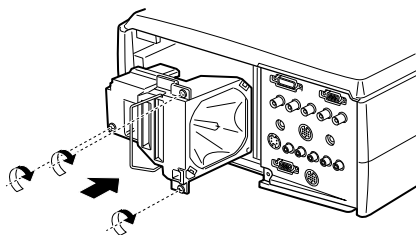

## 5 Attach the fan.

Align the direction, insert the fan, and then secure it in place with the two screws.

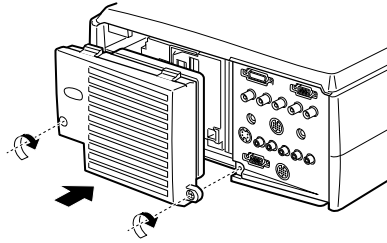

### Point

- Ensure that the lamp has been firmly secured in place. For safety reasons, this projector has been designed so that the power supply is automatically disconnected when the fan is removed. It will not be possible to switch on the power supply unless the lamp and fan have been properly fitted.
- A replacement air filter is packaged with the replacement lamp. Replace the air filter at the same time as replacing the lamp.
- Ensure that the lamp illumination time is reset in accordance with the following procedure after the lamp has been replaced with a new one.

## Resetting the Lamp Illumination Time

### 1 Press the [Help] button for five or more consecutive seconds.

The screen for resetting the lamp's illumination time will be displayed after the help menu has been displayed.

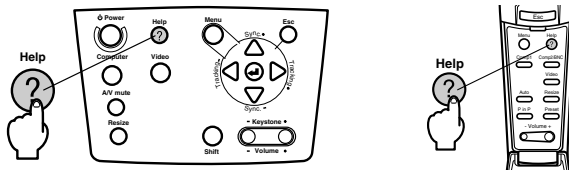

### 2 Select [Yes]

Press the [Tracking +, -] on the main unit (tilt the [Enter] button on the remote control) and select [Yes].

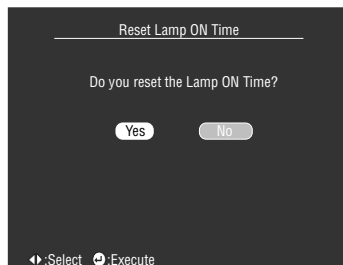

### 3 Execution

Press the [↵ (Enter)] button on the main unit or the [Enter] button on the remote control to execute the process.



## Optional Parts

The following optional parts are available for purchase in accordance with your needs.

Mac Adapter Set	ELPAP01
Image Presentation Camera (XGA)	ELPDC02
Image Presentation Camera	ELPDC03
Ceiling Bracket	ELPFC02
Ceiling Plate (silver)**	ELPFC03
Pipe 370 (silver, 370mm)	ELPPF04
Pipe 570 (silver, 570mm)	ELPPF05
Pipe 770 (silver, 770mm)	ELPPF06
WindowScreen (40-inch)	ELPHS01
WindowScreen (60-inch)	ELPHS03
VGA-Computer Cable (HD15/HD15, 1.8m)	ELPKC02
VGA-Computer Cable (HD15/HD15, 3.0m)	ELPKC09
VGA-Computer Cable (HD15/HD15, 20m)	ELPKC10
VGA-Computer Cable (HD15/5BNC, 1.8m)	ELPKC11
VGA-Work Station Cable (5BNC/13W3, 3.0m)	ELPKC12
VGA-Work Station Cable (5BNC/5BNC, 3.0m)	ELPKC13
VGA-Work Station Cable (HD15/EVC, 3.0m)	ELPKC14
VGA-Work Station Cable (5BNC/EVC, 3.0m)	ELPKC15
ELP Link Cable Set	ELPKC17

Serial Mouse Cable 10m	ELPKC18
Digital Video Cable (DVI-D/DVI-D, 3.0m)	ELPKC20
Digital Video Cable (DVI-D/DFP, 3.0m)	ELPKC21
Hard Travel Case	ELPKS15
Long Throw Zoom Lens	ELPLL02
Long Throw Zoom Lens	ELPLL03
Spare Lamp	ELPLP11
Rear Projection Wide Lens	ELPLR01
Standard Lens	ELPLS01
Wide Zoom Lens	ELPLW01
Dual Stacker	ELPMB04
Stacker Plus	ELPMB05
Ceiling Mount	ELPMB06
Portable Screen	ELPSC06
60-inch Screen	ELPSC07
80-inch Screen	ELPSC08
Remote Control Receiver	ELPST02
Remote Control Receiver Kit	ELPST04

\*\*A special technique is necessary to suspend the projector from the ceiling.

Please consult with your dealer if you are planing to suspend the projector from the ceiling when you use it.

# Terminology

This section provides simple explanations for the terminology used within the manual, items for which explanations are not available, and other complex processes.

A/V Mute	Temporarily erases the image and sound at the same time. The sound and image can be muted by pressing the [A/V Mute] button on the projector. Press the [A/V Mute] button once again or adjust the volume or display the menu to cancel the mute mode.
Color differential signal	Video equipment transmits signals through three cables as Red-Bright (R-Y), Bright (Y) and Blue-Bright (B-Y). This enables the composite signals (the red, green and blue signals and their brightness signals are transmitted along one cable) to be projected more clearly.
Cool-down	A lamp cooling procedure continues to operate even after the power supply has been switched off and the lamp extinguished. The cooling fan will begin to operate when the lamp is extinguished, and button operations will not longer be possible. This period is known as the cooling down period. The amount of time required for the cooling down procedure will differ in accordance with the surrounding temperature.
Color temperature	The temperature of the subject that emits light. A blue hue is attained when the color temperature is high, and a red hue is attained when the color temperature is low.
Contrast	By strengthening or weakening the tone of the colors, it is possible to project characters and pictures more clearly and attain a softer tint. This is known as contrast adjustment.
DVI-D port	The input port that conforms to the DVI digital video ratings (Digital Visual Interface: Ratings to govern how video signals are digitally transmitted). Synchronization and tracking misalignments will not occur during transmission.
Operating system	The software necessary to operate the computer.
Remote port	The optional remote control receiver can be connected.
SRS	The three-dimensional acoustic system. This enables wide and deep sound to be listened to. These are adjusted with the [Space] (wide) and [Center] (deep) buttons.
Stack projection	Refers to the simultaneous duplicate projection of images with the use of multiple projectors in order to increase projection image brightness.
SVGA	IBM PC/AT compatible (DOS/V equipment) signals with 800 horizontal pixels and 600 vertical pixels.
SXGA	IBM PC/AT compatible (DOS/V equipment) signals with 1,280 horizontal pixels and 1,024 vertical pixels.
Synchronization (Sync)	Outputs computer signals at a pre-determined frequency. The image will not be projected clearly unless this frequency is aligned with the frequency of the projector. Aligning the signal phasing is known as synchronization. Projected images will be subject to disturbance, blurring and horizontal noise if not synchronized.
Theft-protection lock	A theft-proof cable (available on the open market) is passed through the holes on the projector case to secure it to a desk or column. These holes support the Micro-Saver Security System manufactured by Kensington Inc.

Tracking	Outputs computer signals at a pre-determined frequency. The image will not be projected clearly unless this frequency is aligned with the frequency of the projector. Aligning the signal frequency is known as tracking. Projected images will be subject to disturbance, blurring and horizontal noise if not synchronized.
USB	An abbreviation for Universal Serial Bus. This is an interface for connecting comparatively low frequency equipment to the computer.
UXGA	IBM PC/AT compatible (DOS/V equipment) signals with 1,600 horizontal pixels and 1,200 vertical pixels.
VGA	IBM PC/AT compatible (DOS/V equipment) signals with 640 horizontal pixels and 480 vertical pixels.
XGA	IBM PC/AT compatible (DOS/V equipment) signals with 1,024 horizontal pixels and 768 vertical pixels.

# Specifications

Brand Name	Multi-Media Projector EMP-8200/8200NL	
External Dimensions	Width 303 × Height 147 × Depth 389 mm(excluding the lens and feet)	
Panel Size	1.3-inch (Width 27mm × Height 20mm × Corner-to-corner 34 mm)	
Display Method	Poly-silicone TFT	
Drive Method	Full-line 12-phase block sequential writing	
Pixel Count	2,359,296 (Horizontal 1,024 × Vertical 768 pixels) × 3	
Focus Adjustment	Manual	
Zoom Adjustment	Manual (approximately 1:1.3)	
Lamp (light source)	UHE lamp model: ELPLP11 rated 230W	
Maximum Sound Output	3W + 3W stereo	
Speakers	2	
Power Supply	AC100V 50/60Hz approximately 360W, 8.5W during power-saving 100-120VAC 50/60Hz 4A 200-240VAC 50/60Hz 2A	
Temperature range during use	+5°C to +40°C (41°F - 104°F) (with no condensation)	
Temperature range during storage	-10°C to +60°C (14°F - 140°F) (with no condensation)	
Weight	Approximately 8.3kg (18.3lbs)	
Connection Ports	Computer 1 port	Single-system mini D-Sub 15pin(female)/ DVI-D port-port (switch)
	Monitor Out port	Single-system mini D-Sub 15pin(female)
	Audio port (for use with Computer 1)	Single-system Stereo mini-jack
	S-Audio/Audio2 port (for use with S-Video / Computer2)	Single-system RCA pin jack × 2(L, R)
	L-Audio-R port (for video use)	Single-system RCA pin jack × 2(L, R)
	Mouse/Com port	Single-system DIN 13pin
	BNC connection port	Single-system 5BNC(female)
	Video port	Single-system RCA pin jack
	S-Video port	Single-system mini DIN 4pin
	Remote port	Single-system Stereo mini-jack
	Stack Out port	Single-system DIN 13pin

## **Safety**

USA

UL1950 3<sup>rd</sup> Edition

Canada

CSA C22.2 No.950-95 (cUL)

European Community

The Low Voltage Directive (73/23/EEC)

IEC60950 2<sup>nd</sup> Edition, +Amd.1, +Amd.2, +Amd.3, +Amd.4

## **EMC**

USA

FCC 47CFR Part15B Class B (DoC)

Canada

ICES-003 Class B

European Community

The EMC Directive (89/336/EEC)

EN55022, 1998 Class B

EN55024, 1998

IEC61000-4-2, IEC61000-4-3, IEC61000-4-4, IEC61000-4-5,

IEC61000-4-6, IEC61000-4-8, IEC61000-4-11,

IEC61000-3-2, IEC61000-3-3

Australia/New Zealand

AS/NZS 3548:1995, A1:1997, A2:1997 Class B

CISPR Pub.22:1993, A1:1995, A2:1996, Class B

# Index

## **Numerics**

13w3 21  
5BNC 21, 22

## **A**

A/V Mute 59  
A/V Mute button 8, 10  
A/V Mute Function 44  
About 61  
About the Manuals and Notations Used 1  
Adjusting the Projection Position 37  
Adjusting the projection size 38  
Adjustment Values 40  
Advance settings menu 54  
Advanced 60, 61  
Air filter (suction inlet) 7  
All reset menu 54  
Audio 58  
Audio cable 24  
Audio port 9  
Auto Adjustment 39  
Auto button 11

## **B**

Bar 50, 59  
Bass 58  
Battery cover 12, 14  
BNC 59  
Box 48, 58  
Brightness 57

## **C**

Canceling Effects 50  
Capture 60  
Capture menu 54  
Ceiling 61  
Ceiling suspended projector 15  
Change-over switch 9, 23  
Cleaning the Air Filter 82  
Cleaning the Projector, Cleaning the Lens,  
Cleaning the Air Filter 81

Color 57  
Color differential 29  
Color setting 60  
Color temperature 60  
Commencing Projection 32  
Comp1 33  
Comp2/ YCbCr 33  
Comp2Sync Termination 61  
Component 29  
Composite image signals 28  
Computer 33  
Computer 1-DVI-D port 9  
Computer 1-mini D-Sub 15 port 9, 20  
Computer 2-BNC port 9, 22, 30  
Computer button 8  
Connecting External Monitors 25  
Connecting the projector to a computer 18  
Connecting Up the Mouse (wireless  
mouse function) 26  
Connecting Video Equipment 28  
Connections of two computers 22  
Contrast 57  
Cool-down 35, 70, 88  
Cursor speed 59  
Cursor/Stamp 48, 58

## **D**

DFP 23  
DVI-D 23

## **E**

Effect 58, 59  
Effect button 10  
Effect Function 48  
Effect menu 54  
Eligible Computers 18  
EMP Link V 64  
EMP Link V installation 67  
Ending 35  
Enlarging Images (E-Zooming function)  
47  
Enter button 8, 10  
Esc button 8, 11

Execute 61  
E-Zoom button 10  
E-Zooming function 47

## **F**

Fan 7  
Feet Adjustments 37  
Focus 39  
Focus ring 6, 39  
Foot adjust lever 6, 37  
Freeze button 10  
Freeze Function 44  
Frequency 18  
Front foot 6, 7, 36, 37  
Functions 41

## **G**

Gamma 57

## **H**

Half-transparent 15  
Handle 6  
Help button 8  
Help Function 42

## **I**

I/O port 7  
Image menu 53  
Image signals 29  
Indicator 6, 10  
Information menu 54  
Installation Procedure 15  
Introduction of Projector Software 64

## **K**

Keystone 59  
Keystone adjustment 38  
Keystone button 8

## **L**

Lamp indicator 6, 71  
Language 60

L-Audio-R port 9, 28  
Left click 27  
Lens cover 6, 31, 36  
Lens shift knob 6, 17  
Light button 10

## **M**

Main screen 51  
Maximum sound output 90  
Menu button 8, 55  
Menu Configuration 53  
Menu Operations 55  
Mini D-Sub 15 pin 20  
Monitor Out port 9  
Mouse/Com port 9, 26

## **N**

No signal msg 59

## **O**

Operable distance 13  
Operable range 13  
Operation indicator 6, 31, 70  
Operation panel 6, 8  
Optional Parts 87  
Overheating 72

## **P**

P in P 59  
P in P button 11  
P in P Function 51  
Parts, Names and Operations 6  
Picture in Picture Function 51  
Picture Quality Adjustment 39  
Position 57  
Power button 8, 10, 32  
Power cord 31  
Power inlet 7, 31  
Preset 57  
Preset button 11, 40  
Projection 31  
Projection Angles 17  
Projection cutting 44  
Projection distance 16

Projector software 64  
Prompt 59

## **R**

R/C ON OFF switch 10, 32, 36  
Rear foot 7  
Rear Proj. 61  
Remote control 10, 13  
Remote control light-emitting area 10  
Remote control light-receiving area 6, 7  
Remote port 9  
Replacing the Air Filter 83  
Replacing the lamp 84  
Reset 58, 59, 60, 61  
Reset all 61  
Resize button 8, 11  
Resolution 18, 57  
RGB image signals 30  
Right click 27

## **S**

S image signals 28  
S-Audio/Audio 2 port 9, 28  
Screen size 16  
Setting 59, 60  
Setup menu 53, 54  
Sharpness 57  
Shift button 8  
Sleep Mode 60, 73  
Smooth motion 57  
Sound Connection 24  
Sound menu 54  
Speaker 6  
Specifications 90  
Spotlight 49, 58  
SRS Center 58  
SRS Space 58  
Stack Out port 9  
Stamp 48  
Startup Screen 60  
Sub menus 53  
Sub-screen 51  
S-Video port 9, 28  
Symbol displays 1  
Sync button 8  
Sync. 57

Synchronization 40

## **T**

Temperature indicator 6, 72  
Temperature range during storage 90  
Temperature range during use 90  
Terminology 88  
Theft-protection lock 6, 88  
Tint 57  
Top menus 53  
Tracking 40, 57  
Tracking button 8  
Treble 58  
Troubleshooting 70

## **U**

User logo 44  
User's logo capture 60

## **V**

Video 33, 57, 58  
Video button 8, 11  
Video port 9, 28  
Video signal 58  
Volume 52, 58  
Volume Adjustment 52  
Volume button 11

## **W**

Window display 45  
Window resizing 45

## **Z**

Zoom 38  
Zoom ring 6



# **DECLARATION of CONFORMITY**

According to 47CFR, Part 2 and 15

**Class B Personal Computers and Peripherals; and/or  
CPU Boards and Power Supplies used with Class B  
Personal Computers**

We : EPSON AMERICA, INC.  
Located at : 3840 Kilroy Airport Way  
MS: 3-13  
Long Beach, CA 90806  
Tel : 562- 290- 5254

Declare under sole responsibility that the product identified herein, complies with 47CFR Part 2 and 15 of the FCC rules as a Class B digital device. Each product marketed, is identical to the representative unit tested and found to be compliant with the standards. Records maintained continue to reflect the equipment being produced can be expected to be within the variation accepted, due to quantity production and testing on a statistical basis as required by 47CFR 2.909 Operation is subject to the following two conditions : (1) this device may not cause harmful interference, and (2) this device must accept any interference received, including interference that may cause undesired operation.

**Trade Name** : EPSON  
**Type of Product** : LCD Projector  
**Model** : EMP- 8200/8200NL  
ELP- 8200/8200NL

## **FCC Compliance Statement For United States Users**

This equipment has been tested and found to comply with the limits for a Class B digital device, pursuant to Part 15 of the FCC Rules. These limits are designed to provide reasonable protection against harmful interference in a residential installation. This equipment generates, uses, and can radiate radio frequency energy and, if not installed and used in accordance with the instructions, may cause harmful interference to radio or television reception. However, there is no guarantee that interference will not occur in a particular installation. If this equipment does cause interference to radio and television reception, which can be determined by turning the equipment off and on, the user is encouraged to try to correct the interference by one or more of the following measures.

- Reorient or relocate the receiving antenna.
- Increase the separation between the equipment and receiver.
- Connect the equipment into an outlet on a circuit different from that to which the receiver is connected.
- Consult the dealer or an experienced radio/TV technician for help.

### **WARNING**

The connection of a non-shielded equipment interface cable to this equipment will invalidate the FCC Certification or Declaration of this device and may cause interference levels which exceed the limits established by the FCC for this equipment. It is the responsibility of the user to obtain and use a shielded equipment interface cable with this device. If this equipment has more than one interface connector, do not leave cables connected to unused interfaces. Changes or modifications not expressly approved by the manufacturer could void the user's authority to operate the equipment.

All rights reserved. No part of this publication may be reproduced, stored in a retrieval system, or transmitted in any form or by any means, electronic, mechanical, photocopying, recording, or otherwise, without the prior written permission of SEIKO EPSON CORPORATION. No patent liability is assumed with respect to the use of the information contained herein. Neither is any liability assumed for damages resulting from the use of the information contained herein.

Neither SEIKO EPSON CORPORATION nor its affiliates shall be liable to the purchaser of this product or third parties for damages, losses, costs, or expenses incurred by purchaser or third parties as a result of: accident, misuse, or abuse of this product or unauthorized modifications, repairs, or alterations to this product, or (excluding the U.S.) failure to strictly comply with SEIKO EPSON CORPORATION's operating and maintenance instructions.

SEIKO EPSON CORPORATION shall not be liable against any damages or problems arising from the use of any options or any consumable products other than those designated as Original EPSON Products or EPSON Approved Products by SEIKO EPSON CORPORATION.

EPSON is a registered trademark and PowerLite is a trademark of SEIKO EPSON CORPORATION.

**General Notice:** The following trademarks and registered trademarks are the property of their respective owners and are used in this publication for identification purposes only.

- EPSON/Seiko Epson Corp.
- Macintosh, PowerBook/Apple Computer Corp.
- IBM/International Business Machines, Inc.
- Windows/Microsoft Corp.

Other product names used herein are also for identification purposes only and may be trademarks of their respective owners. EPSON disclaims any and all rights in those marks.

# EPSON®

