

# EPSON®

## MM PROJECTOR ULTRA MEDIA

# EMP-8150/8150NL™

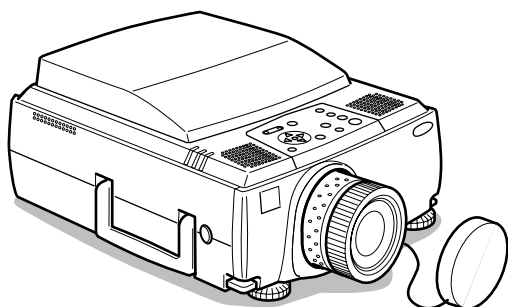

Before use

Installation

Connections

Projection

Useful Functions

Adjustments and  
Setting

Using the EasyMP.net  
Software

Troubleshooting











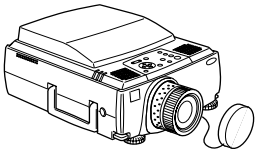
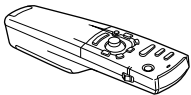
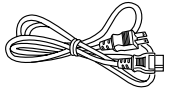
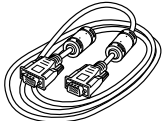

Maintenance

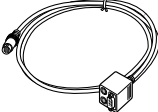
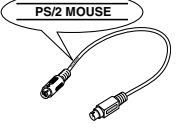
Others

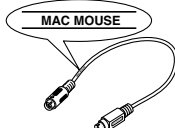
## Owner's Manual

# Accessory Verification

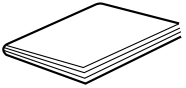
Check to confirm that the following items are included in the package when removing the projector and accessories from the box. Contact your dealer if any items are found to be missing.

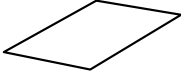
<ul style="list-style-type: none"> <li>· Projector</li> <li>· Lens Cover with string</li> </ul>  <p>The NL model is not fitted with a lens or lens cover.</p>	<ul style="list-style-type: none"> <li>· Remote Control</li> </ul> 	<ul style="list-style-type: none"> <li>· 2AA Batteries for the remote control (three-cell alkaline manganese batteries)</li> </ul> 	
<ul style="list-style-type: none"> <li>· Power Cord</li> </ul> 	<ul style="list-style-type: none"> <li>· Computer Cable</li> </ul> 	<ul style="list-style-type: none"> <li>· Computer Cable (mini D-Sub 15-pin/5BNC)</li> </ul> 	<ul style="list-style-type: none"> <li>· Audio Cable</li> </ul> 
<ul style="list-style-type: none"> <li>· RCA Audio Cable (Yellow)</li> </ul> 	<ul style="list-style-type: none"> <li>· RCA Audio Cable (Red/White)</li> </ul> 	<ul style="list-style-type: none"> <li>· Main Cable</li> </ul> 	<ul style="list-style-type: none"> <li>· USB Mouse Cable</li> </ul> 
<ul style="list-style-type: none"> <li>· PS/2 Mouse Cable</li> </ul> 	<ul style="list-style-type: none"> <li>· Serial Mouse Cable</li> </ul> 	<ul style="list-style-type: none"> <li>· Mac Mouse Cable</li> </ul> 	<ul style="list-style-type: none"> <li>· Mac Serial Cable</li> </ul> 
<ul style="list-style-type: none"> <li>· PC Serial Cable</li> </ul> 	<ul style="list-style-type: none"> <li>· EasyMP.net Software CD-ROM</li> </ul> 	<ul style="list-style-type: none"> <li>· Owner's Manual (this document)</li> </ul> 	<ul style="list-style-type: none"> <li>· 16MB Compact Flash Card+Card Adapter</li> </ul> 
<ul style="list-style-type: none"> <li>· EasyMP.net User's Guide</li> </ul> 	<ul style="list-style-type: none"> <li>· Warranty Card</li> </ul> 		

# ■ Features

- **Crystal clear screen**

Clarity has been vastly improved.

Provides crystal clear projections even in bright areas, perfect for presentation purposes.

- **Wide range of display resolution**

Uses a newly-developed high resolution liquid crystal panel.

(1024×768)

- **Compact and light**

A compact body makes it easy for carrying around.

(approximately 9.1Kg)

- **Beautiful video images**

The three-dimensional Y/C separation and smooth motion I/P conversion technology provide vivid video images.

- **DVI-D port\* that supports digital output**

Fitted with a DVI-D Port for digital input purposes. This can also be connected to a computer's digital output port.

- **The EasyMP.net function, particularly strong with computer link-ups.**

In addition to performing presentations with the data contained on the memory card inserted into the PCMCIA card slot, it is also possible to control the presentation from a computer connected to a LAN.

# ■ Contents

<b>Accessory Verification</b>	<b>1</b>
-------------------------------	----------

---

<b>Features</b>	<b>1</b>
-----------------	----------

---

<b>Contents</b>	<b>2</b>
-----------------	----------

---

<b>Using this manual</b>	<b>7</b>
--------------------------	----------

---

Symbol displays .....	7
-----------------------	---

<b>Safety Precautions</b>	<b>8</b>
---------------------------	----------

---

<b>Before using this equipment</b>	<b>13</b>
------------------------------------	-----------

---

<b>Parts, Names and Operations</b>	<b>13</b>
------------------------------------	-----------

---

Projector .....	13
-----------------	----

Remote Control .....	18
----------------------	----

Range of Remote Control Operations .....	21
--	----

Inserting the Remote Control Batteries .....	22
--	----

<b>Installation</b>	<b>23</b>
---------------------	-----------

---

<b>Installation Procedure</b>	<b>23</b>
-------------------------------	-----------

---

Installation example .....	23
----------------------------	----

Screen size and projection distance .....	24
---	----

Projection angles .....	26
-------------------------	----

<b>Connections</b>	<b>27</b>
--------------------	-----------

---

<b>Connecting the projector to a computer</b>	<b>27</b>
---	-----------

---

Eligible computers .....	27
--------------------------	----

In the case of the mini D-Sub 15 pin .....	29
--	----

In the case of 5BNC	
---------------------	--

(When connected to the second computer) .....	31
---	----

In the case of DVI-D* .....	32
-----------------------------	----

Sound connection .....	33
------------------------	----

Connecting external monitors .....	34
Connecting up the mouse (wireless mouse function) .....	35
<b>Connecting the video equipment</b>	<b>37</b>
<hr/>	
In the case of composite image signals .....	37
In the case of S image signals .....	37
In the case of component (color differential*) image signals .....	38
In the case of the digital tuner's D output port .....	39
In the case of RGB image signals .....	40
<b>Projecting</b>	<b>41</b>
<hr/>	
<b>Projection</b>	<b>41</b>
<hr/>	
Preparations .....	41
Commencing projection .....	42
<b>Ending</b>	<b>45</b>
<hr/>	
<b>Adjusting the projection position</b>	<b>47</b>
<hr/>	
Feet adjustments .....	47
<b>Adjusting the projection size</b>	<b>48</b>
<hr/>	
Zoom adjustment .....	48
Keystone adjustment .....	49
<b>Picture Quality Adjustment</b>	<b>50</b>
<hr/>	
Focus adjustment .....	50
Auto adjustment (when projecting computer images) .....	50
Tracking adjustments (when projecting computer images) .....	51
Synchronization adjustments (when projecting computer images) .....	51
Calling out adjustment values (when projecting computer images) .....	51
<b>Introduction of Functions</b>	<b>52</b>
<hr/>	

<b>Useful Functions</b>	<b>53</b>
<hr/>	
<b>Useful Functions</b>	<b>53</b>
<hr/>	
Help Function .....	53
<b>Projection Cutting</b>	<b>55</b>
<hr/>	
A/V Mute Function .....	55
Freeze Function .....	55
<b>Switching Image Sizes</b>	<b>56</b>
<hr/>	
<b>Enlarging Images (E-zooming function)</b>	<b>58</b>
<hr/>	
<b>Effect Function</b>	<b>59</b>
<hr/>	
Cursor/Stamp .....	59
Box .....	59
Spotlight .....	60
Bar .....	61
Cancelling effects .....	61
<b>P in P Function</b>	<b>62</b>
<hr/>	
<b>Adjustments and settings</b>	<b>63</b>
<hr/>	
<b>Volume Adjustment</b>	<b>63</b>
<hr/>	
<b>Menu Configuration</b>	<b>64</b>
<hr/>	
Menu items .....	64
<b>Menu Operations</b>	<b>66</b>
<hr/>	
Operation method .....	66
Setting items .....	68
Image capture .....	73
User logo registration .....	75

---

## **Using the EasyMP.net Software** **77**

---

### **Introduction of EasyMP.net Software** **77**

---

Presentation support software .....	77
EasyMP.net PC applications .....	78

### **Installation** **79**

---

Operating Environment .....	79
Installation .....	80
Reading the User's Guide .....	81

### **Computer Connections** **82**

---

Serial Connections .....	82
--------------------------	----

## **Troubleshooting** **84**

---

### **Troubleshooting** **84**

---

Operation Indicator .....	84
Lamp Indicator .....	85
Temperature Indicator .....	86

### **When the Indicators Provide No Help** **87**

---

The image is not projected .....	87
The image is out of focus .....	89
The image is distorted .....	90
The image color is bad .....	91
The image is dark .....	91
No sound .....	92
The remote control won't work .....	92
The projector will not switch off (after the [Power] button has been pressed) .....	93
EMP Link V will not function .....	93

---

**Maintenance** **94**

---

**Cleaning the projector, Cleaning the lens,  
Cleaning the Air Filter** **94**

---

Cleaning the projector .....	95
Cleaning the lens .....	95
Cleaning the Air Filter .....	95

**Replacing the Air Filter** **96**

---

Replacement method .....	96
--------------------------	----

**Replacing the lamp** **97**

---

Replacement method .....	98
Resetting the lamp illumination time .....	99

**Others** **100**

---

**Optional Parts** **100**

---

**Terminology** **101**

---

**Specifications** **103**

---

**Check Sheet** **104**

---

**World-Wide Warranty Terms** **107**

---

**Index** **111**

---



# ■ Using this manual

---

## Symbol displays

A variety of picture displays have been used in this manual and on the actual product to ensure that the projector is used correctly and safely in order to prevent risks to users and other people, and to prevent damage to property. Explanations for these displays are provided below. Ensure that they are fully understood before reading this manual.

 <b>Warning</b>	Displays details that may result in death or injury if ignored.
 <b>Caution</b>	Displays details that may result in injury or damage to property if ignored.

Point: Includes supplementary explanations and useful tips.

See page: Indicates reference pages

\*: Refer to the terminology

\*Usage of the terms “this unit” and “this projector” in this manual

The terms “this unit” and “this projector” appear regularly in this manual, and these terms also cover the accessories supplied with the projector and other optional products.

\*The projection distances, illustrations and screen sizes apply to when the standard lens is in use.

# ■ Safety Precautions

Read and observe the following safety precautions to ensure safe use of the equipment.

## ⚠ Warning

- **If any of the following abnormalities occur, switch off the power supply immediately, remove the plug from the power socket and contact your dealer or nearest address provided at page 107.**

- The emission of smoke, strange odours or strange noises.
- Faults, such as images not being able to be projected or no sound being emitted.
- When water or foreign objects have entered the inside of the unit.
- When the unit has been dropped or the case damaged.

Continuation of operations under these conditions may result in the outbreak of fire or electric shocks.

Repairs should never be attempted by the user.

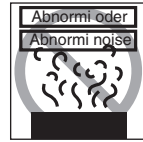

- **The cabinet to the unit should never be opened by anyone other than our service personnel.**

The inside of the projector contains many high-voltage parts that may result in the outbreak of fire, electric shocks or other incidents.



- **Never use an electrical voltage other than that displayed.**

The use of a voltage other than that specified may result in the outbreak of fire or electric shocks.



- **Verify the specifications of the Power Cord.**

The Power Cord supplied with the projector conforms to the electrical specifications of the country of purchase. If the projector is to be used in any other location, check the electrical voltage and shape of sockets in the relevant country beforehand and purchase a cable that conforms to that country's specifications.

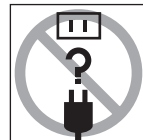

- **Never use damaged Power Cord.**

Failure to observe this may result in the outbreak of fire or electric shocks.

Also ensure that the following points are strictly observed.

- Never make any modifications to the Power Cord.
- Never place anything heavy on the Power Cord.
- Never bend, twist or pull the cable.
- Ensure that the cable is not installed near heaters.

Contact your dealer or nearest address provided at page 107 if the power cord becomes damaged.

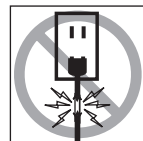

## ⚠ Warning

- **Never look into the lens when the power is switched on.**

An extremely strong light is emitted that may cause sight defects. Special attention must be paid by households with children.



- **Take care when handling power plugs and power connectors.**

Failure to observe these instructions may result in the outbreak of fire or electric shocks.

Observe the following precautions when handling power plugs and power connectors.

- Never connect too many appliances to a single socket.
- Never use plugs or connectors to which dust, dirt or other foreign objects have adhered.
- Ensure that the plugs and connectors are firmly inserted as far as they will go.
- Do not attempt to plug in plugs or connectors with wet hands.
- Do not pull the Power Cord when disconnecting plugs and connectors. Always ensure that the actual plug or connector is firmly gripped.



- **The projector includes many glass parts, such as the lens and lamps.**

If any of these parts should break, handle them with extreme care to avoid injury and then contact your dealer or nearest address provided at page 107 and request repairs.



- **Never place vases or containers that contain liquid on top of the projector.**

If the water is spilled and enters the outer case, it may result in the outbreak of fire or electric shocks.



- **Never insert or drop metal or inflammable objects, or any other foreign objects into the suction inlets and ventilation outlets on the projector.**

Failure to observe this may result in the outbreak of fire or electric shocks.



- **Never place the projector or the battery-operated remote control in locations with excessive temperatures, such as in vehicles with closed windows, in areas subject to direct sunlight, or near the fan outlets of air-conditioners and heaters.**

Failure to observe this may result in heat-distortion that would have an adverse affect on the contents of the projector, and may result in the outbreak of fire or electric shocks.



## ⚠ Caution

- **Never stand on the projector or place any heavy objects on it.**  
Failure to observe this may result in it dropping over, becoming damaged, or causing injury.



- **Never place the projector on unstable surfaces, such as wobbly tables or slanted surfaces.**  
Failure to observe this may result in it dropping over, becoming damaged, or causing injury.



- **Do not place or store the projector within the reach of children's hands.**  
Failure to observe this may result in it dropping over, becoming damaged, or causing injury.



- **Do not place the projector in humid or dusty locations, or in locations where it would be subject to oil steam or water steam, such as kitchens or near humidifiers.**  
Failure to observe this may result in the outbreak of fire or electric shocks.



- **Never block the projector's suction inlets or ventilation outlets. Failure to observe this may result in the build up of high temperatures inside the projector, leading to the outbreak of fire. Do not place the projector in the following locations.**
  - In narrow, badly ventilated areas, such as in cupboards or in bookcases.
  - On top of carpets, mattresses or blankets.
  - Never cover the projectors with table cloth or other material.Also, if placing by a wall, ensure that at least 20cm of space has been provided between the projector and the wall.

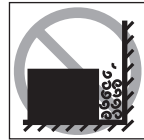

- **Always ensure that the plug has been disconnected from the power socket when it is not to be used.**  
Failure to observe this may result in the outbreak of fire.

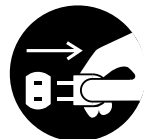

## ⚠ Caution

- **Always ensure that the power has been switched off, the plug has been disconnected from the power socket, and all other cables have been disconnected when moving the projector.**  
Failure to observe this may result in the outbreak of fire or electric shocks.

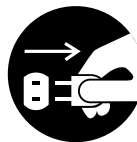

- **Never attempt to remove the lamp immediately after the projector has been used. Wait for the projector to cool down sufficiently by leaving it for at least sixty minutes after the power supply has been switched off before attempting this.**  
Failure to observe this may result in burns or other injuries.

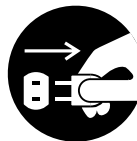

- **Misuse of the batteries may result in damage to the batteries and subsequent leakages, leading to the outbreak of fire, injury and product corrosion. Observe the following precautions to ensure safety.**

- Never use combinations of different batteries, or old batteries together with new batteries.
- Never use batteries that are not specified in the instruction manual.
- If liquid should leak from the battery, wipe up the leakage with a cloth and then replace the battery accordingly.
- Replace the batteries immediately when the time for replacement arrives.
- Remove the batteries when the projector is not to be used for a long period of time.
- Never apply heat to the batteries, or place them in naked flames or water.
- Ensure that the batteries are inserted in accordance with the correct polarity (+ and -).
- If any liquid that has leaked from a battery gets onto the hands, wash it off immediately with water.

Batteries must be disposed of in accordance with the regulations in effect in each relevant area.

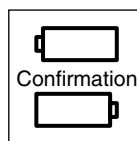

- **Ensure that the electric plug and connectors have been disconnected from their sockets when performing maintenance tasks.**  
Failure to observe this may result in electric shocks.

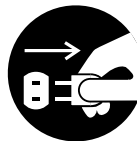

## Safety Precautions

- **Using the projector outside of the permissible temperature range (+5C° to 40C°) may result in unstable display and excessive loads being placed on the fan, leading to damage to the equipment.**
- **Storing the projector outside of the permissible temperature range (-10C° to 60C°) may result in damage of the case. Take special care to avoid placing the equipment in direct sunlight for a long period of time.**
- **Do not use the projector with the lens cover still in place. The heat generated by the lens may cause the cover to become malformed.**
- **The liquid crystal display panel has been manufactured with high-accuracy technology and contains more than 99.99% active pixels. However, note that there is a possibility of 0.01% of missing pixels and pixels that will be constantly illuminated.**

# Before using this equipment

This section provides explanations on parts and part names, and the items that should be verified before operating the remote control.

## Parts, Names and Operations

### Projector

#### ● Front Panel

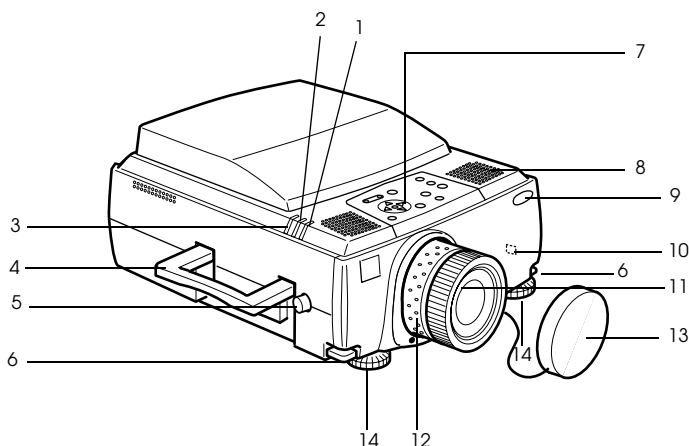

- 1 Operation Indicator
- 2 Lamp Indicator
- 3 Temperature Indicator
- 4 Handle
- 5 Lens Shift Knob
- 6 Foot Adjust Lever
- 7 Operation Panel
- 8 Speaker
- 9 Remote Control Receiver
- 10 Theft-Protection Lock ([see page 102](#))
- 11 Focus Ring
- 12 Zoom Ring
- 13 Lens Cover
- 14 Front Foot

## ● Back Panel

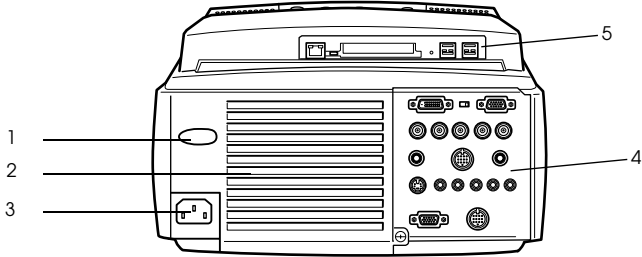

**1 Remote Control Receiver**

**2 Fan**

**3 Power Inlet**

**4 I/O Port**

**5 EasyMP.net Board**

## ● Rear Panel

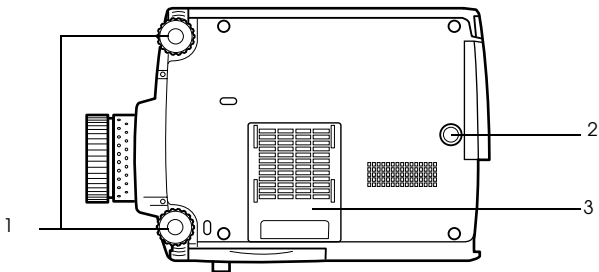

**1 Front Foot**

**2 Rear Foot**

**3 Air Filter (suction inlet)**



## ● Operation Panel

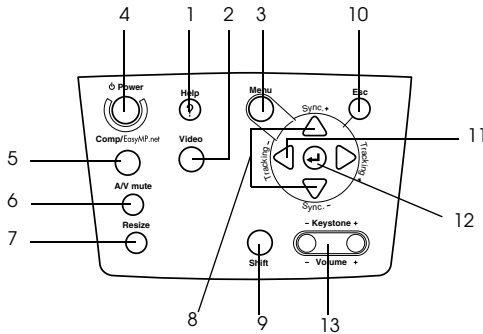

### 1 [Help] button (see page 53)

Displays the methods of solving problems. Press this button when trouble occurs.

### 2 [Video] button (see page 43)

Switches the images between video images (Video), S video (S-Video) and component video (BNC (YCbCr)).

### 3 [Menu] button (see page 66)

Displays and cancels the menu.

### 4 [Power] button (see page 42, 45)

Switches the power supply on and off.

### 5 [Comp/EasyMP.net] button (see page 43)

Switches the Computer #1 images, BNC (RGB) and the EasyMP.net images.

### 6 [A/V mute] button (see page 55)

Temporarily erases the image and sound. Projection is resumed when this button is pressed once more or when the volume control is adjusted or when the menu is displayed. User logos can also be set up for projection when in the A/V mute mode.

### 7 [Resize] button (see page 56)

Switches between the window display and the resizing display when computer images are being projected. Switches the aspect ratio between 4:3 and 16:9 when video images are being projected.

### 8 [Sync] button (see page 51)

Makes the necessary adjustments when the screen is out of focus or flickering. This button functions as the up and down key when the menu or help text are being displayed.

### 9 [Shift] button (see page 63)

Adjusts the volume when pressed simultaneously with the [Volume (Keystone)] button.

### 10 [ESC] button (see page 67)

Ends functions that are currently in use. Returns the screen to the previous stage when this is pressed during menu and help text display.

### 11 [Tracking] button (see page 51)

Performs the necessary adjustments when stripes appear on the screen. Moves left and right when this is pressed during menu and help text display.

### 12 [↵(Enter)] button (see page 50, 66)

- Sets the menu item and moves onto the lower stage.
- Optimizes the computer image when the menu or help text are not displayed. (Switches the input resolution across to [Auto] when set for [Manual]).

### 13 [Keystone] button (see page 49)

Performs the necessary adjustments when the screen distorts into a trapezoid shape.

## ● I/O Ports

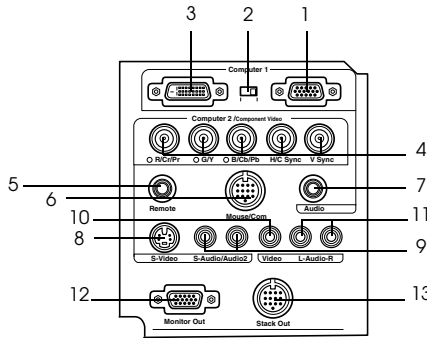

### 1 Computer 1 mini D-Sub 15 Port

Inputs the computer's analog image signals.

### 2 Change-over Switch

Switches the valid port for Computer #1 across to either mini D-Sub15 (analog) or DVI-D (digital). Operate the switch with the tip of a ballpoint pen or other pointed object.

### 3 Computer 1 DVI-D Port

Inputs the computer's digital image signals.

### 4 Computer 2/Component Video-BNC Port

· R/Cr/Pr · G/Y · B/Cb/Pb · H/C Sync · V Sync

Inputs the computer's BNC image signals, the A/V equipment component image signals (color differential signal\*) or the RGB image signals.

### 5 Remote Port

Connects the optional remote control receiver (ELPST04).

### 6 Mouse/Com Port

Establishes a connection with the computer when the EasyMP.net Software that is supplied is to be used when the remote control is used as a wireless mouse.

### 7 Audio Port

Inputs the audio signals from the computer and A/V equipment connected to the Computer #1 Port.

### 8 S-Video Port

Inputs the A/V equipment's S image signals.

### 9 S-Video/Audio 2 Port

Inputs the audio signals from the computer and A/V equipment connected to the BNC port or the S-Video port.

Outputs only the sound for connected computers and A/V equipment.

### 10 Video Port

Inputs the the A/V equipment's component image signals.

### 11 L-Audio-R Port

Inputs the the A/V equipment's sound signals.

### 12 Monitor Out Port

Outputs the projected image signals to an external monitor (not output when the input comes from the DVI-D port).

### 13 Stack Out Port

This is used during stack projection.

## ● EasyMP.net board

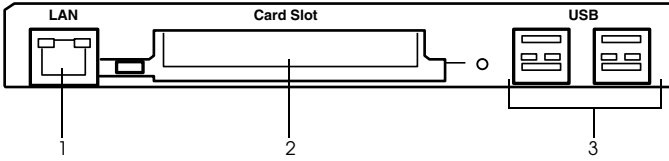

### 1. Network Connector

Connects the projector to a network.

### 2. PCMCIA Card Slot

For the insertion of memory cards.

### 3. USB Port

Used for connecting the USB mouse, USB keyboards and USB tablets, etc.

---

### Point

Refer to the "EasyMP.net User's Guide" for details on the EasyMP.net functions.

---

# Remote Control

## ● Front Panel

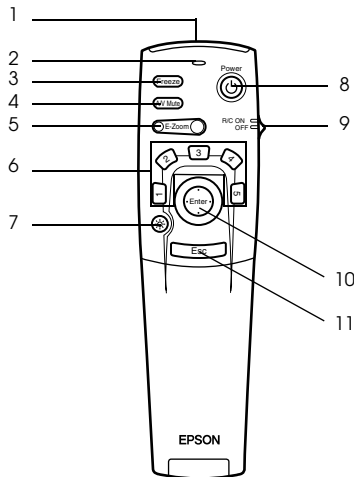

### 1 Remote control light-receiving area

Outputs the remote control unit's signals.

### 2 Indicator

Illuminated when the remote control unit signals are being output.

Light will not be emitted when the batteries are getting low or when the [R/C ON OFF] switch is set at [OFF].

### 3 [Freeze] button (see page 55)

Temporarily freezes the image. Press this button once more to cancel the freeze mode.

### 4 [A/V Mute] button (see page 55)

Temporarily mutes the images and sound. To resume projection, press the button once more, adjust the volume control, or display the menu.

It is also possible to project the user logo when the A/V mute function is operating.

### 5 [E-Zoom] button (see page 58, 62)

Enlarges and reduces the size of the image. The image in the sub-screen will be enlarged when Picture-in-Picture images are being projected. Press the [Esc] button to cancel this function.

### 6 [Effect] button (see page 59)

Executes the allocated effect function. Press the [ESC] key to cancel this mode.

### 7 [☀ (Light)] button

The remote control button will be illuminated for approximately ten seconds.

### 8 [Power] button (see page 42, 45)

Switches the power supply to the projector on and off.

### 9 [R/C ON OFF] switch (see page 42, 46)

Switches the remote control unit on and off. The remote control unit cannot be used for operations when this switch is not set at [ON].

## 10 [Enter] button (see page 36, 66)

- Sets the menu item when pressed, and then moves onto the lower stage. Becomes a cursor key to select the menu items when moved up, down, left or right.
- This function operates with a left-hand click on the mouse when computer images are being projected. The pointer will move when this button is moved up, down, left or right.

## 11 [ESC] button (see page 36, 67)

- Ends the function being used. Returns to the previous stage when the menu or help text is being displayed.
- This function operations with a right-hand click on the mouse when computer images are being projected.

## ● Inside of the Cover

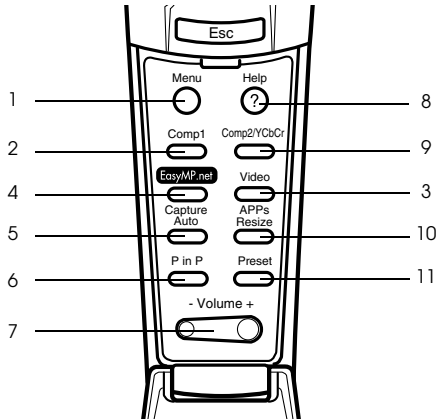

## 1 [Menu] button (see page 66)

Displays and ends the menu.

## 2 [Comp1] button (see page 43)

Switches across to the image from computer #1 port. (Switches across to the DVI-D image when the switch is set to the Digital (left-hand side)).

## 3 [Video] button (see page 43)

Switches between video images (Video) and S-video images (S-Video).

## 4 [EasyMP.net] button (see page 43)

Switches across to EasyMP.net images.

## 5 [Auto] button (see page 50)

Optimizes the computer images. The projected image will be captured when EasyMP.net images are being projected.

## 6 [P in P] button (see page 62)

Displays the video image within the computer image or the video image as a sub-screen. This function is cancelled by pressing this button once again.

## 7 [Volume] button (see page 63)

Adjusts the volume.

## 8 [Help] button (see page 53)

Displays the method of solving problems. Press this button when trouble occurs.

## 9 [Comp2/YCbCr] button (see page 43)

Switches between the images from the BNC port.

**10 [Resize] button (see page 56)**

Switches between the window display and the resizing display when computer images are being projected. Switches the aspect ratio between 4:3 and 16:9 when video images are being projected.

An application list will be displayed when EasyMP.net images are being projected.

**11 [Preset] button (see page 51)**

Calls out the preset computer input settings.

● **Rear Panel**

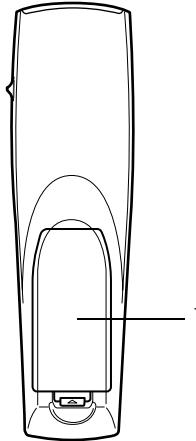

**1 Battery Cover**

## Range of Remote Control Operations

Depending on the distance and angle from the main unit's light receiving area, there are cases where the remote control will not function. Ensure that the remote control is used within the following conditions:

- **Operable distance: Approximately 10 metres**
- **Operable range:**

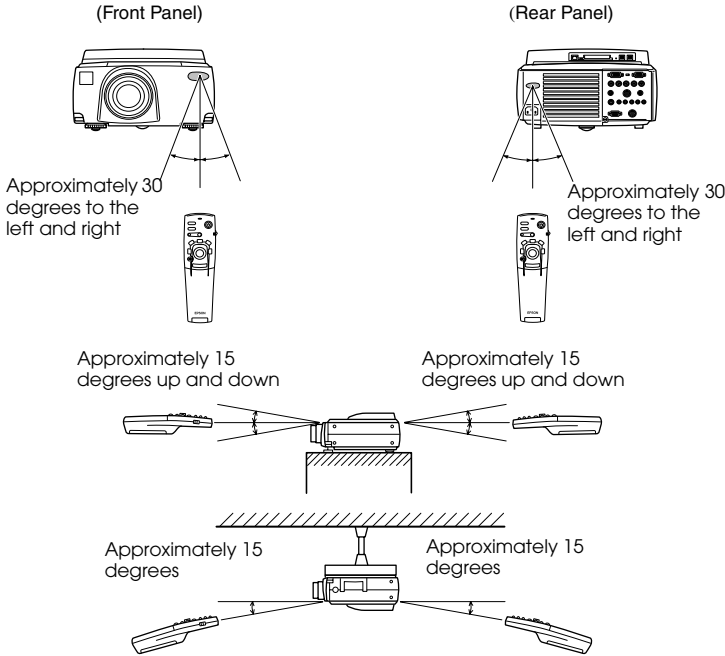

---

### Point

- Ensure that the R/C ON OFF switch is set at [ON] when using the remote control unit.
  - Aim the remote control at the projector's light-receiving area.
  - There are cases where the operable distance (approximately 10 meters) of the remote control is diminished when signals are reflected off screens depending on the type of screen in use.
  - Ensure that sunlight and fluorescent lighting is not shone directly into the projector's light-receiving area.
  - If the remote control will not function or malfunctions, there is a possibility that the batteries need changing. In this event, replace the batteries accordingly.
  - Use the optional remote control receiver (ELPST04) if it is to be used at a distance of 10m or more.
-

## Inserting the Remote Control Batteries

The remote control batteries are inserted in accordance with the following procedure:

### ⚠ Caution

Ensure that unused batteries of the same type are used.

#### 1 Remove the Battery Cover.

Apply pressure to the clip holding the Battery Cover, and then lift it upwards.

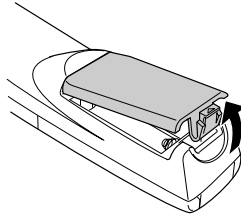

#### 2 Insert the batteries.

Ensure that the batteries are aligned correctly with the “+” and “-” labels on the remote control.

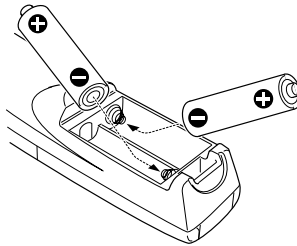

#### 3 Replace the cover.

Apply pressure to the battery cover until it clicks firmly into place.

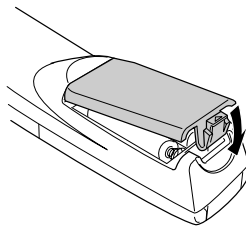

---

#### Point

- Specified batteries: Two three-cell alkaline manganese batteries (LR6).
  - The batteries should be replaced approximately once every three months when used for thirty minutes per day.
-



# Installation

This section provides an example of projector installation, and explanations on the projection distances and projection angles.

## Installation Procedure

Determines the projection angle and projection distance to ensure the most suitable screen display.

### ⚠ Caution

- Do not block the ventilation outlet at the back of the projector or the Air Filter (suction inlet) on the rear panel.
- There are cases where material or paper get sucked onto the Air Filter on the rear panel when the projector is in use, so attention must be paid to prevent this.
- Do not place the projector in a location where it is subject to the direct air flow from air conditioners or heaters.
- When the projector is to be placed near a wall, ensure that there is at least 20cm of space between the wall and the projector.
- Do not cover the projector with table cloths or other material.

## Installation example

The projector may be installed in locations that conform to the installation conditions and projection methods.

### Viewing projected images from the front

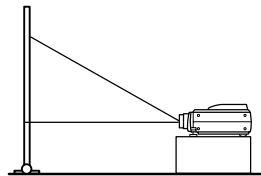
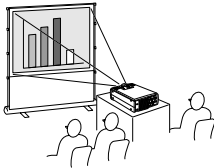

## Viewing projected images from the front with a ceiling suspended projector

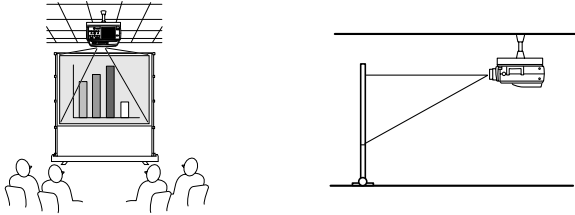

Use the optional ceiling suspension unit and set the ceiling suspension parameter to [ON]. (see page 72)

## Viewing images projected onto half-transparent screens from the rear.

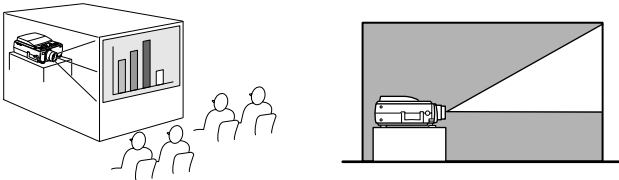

- Set the rear parameter to [ON]. (see page 72)
- Ceiling suspension is also possible with the use of the optional ceiling suspension unit.

---

## Screen size and projection distance

Determines the distance that the screen must be from the lens in order to obtain the required screen size.

The projector's Standard Lens is approximately a 1.4x zoom lens and the largest screen size is about 1.4 times the size of the smallest screen.

Using the following table for reference purposes, install the projector so that the screen size is smaller than the screen.

Screen Size	Approximate Projection Distance
30-inch (61×46cm)	1.1m to 1.4m
40-inch (81×61cm)	1.5m to 1.8m
60-inch (120×90cm)	2.3m to 2.8m
80-inch (160×120cm)	3.0m to 3.8m
100-inch (200×150cm)	3.8m to 4.8m
200-inch (410×300cm)	7.6m to 9.7m
300-inch (610×460cm)	11.4m to 14.6m

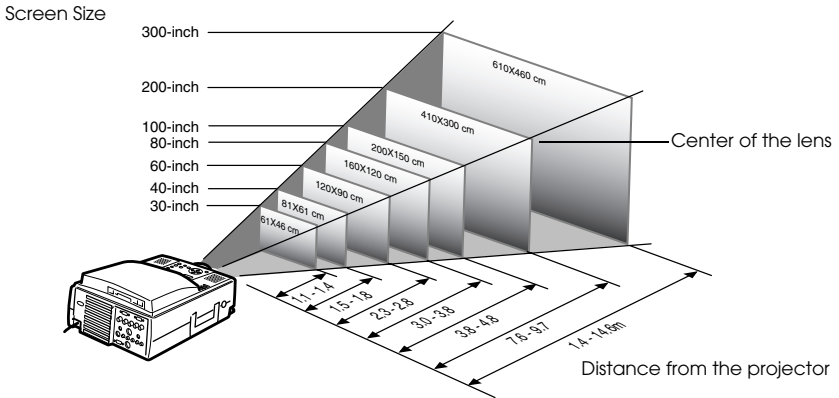

### Point

- The projection distances listed above are the distances when the standard lens is in use. If optional lenses are to be used, refer to the relevant instruction manuals for further details.
- The screen size will become smaller when the trapezoid correction function is used.

---

## Projection angles

The optimum projection screen is acquired by placing the center of the projector's lens and a right-angle to the screen.

### When viewing from the side

It is possible to move the projection position up and down with the lens shift function

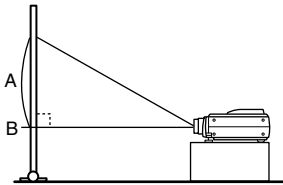

A:B 10:Becomes 0

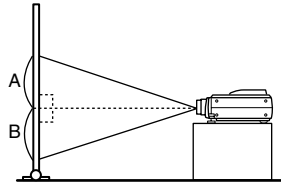

A:B 5:Becomes 5

### When viewing from the top or bottom

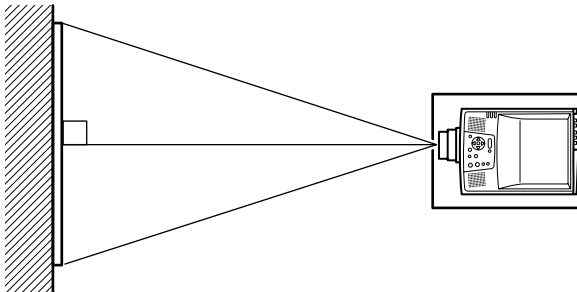

---

### Point

Although the projection position can be adjusted with the foot lever ([see page 47](#)), there are cases where the screen will distort into a trapezoid shape. In this event, adjust the trapezoid distortion with the trapezoid correction function. ([see page 49](#))

---

# Connections

This section provides explanations on connecting the projector to computers and video equipment.

## ■ Connecting the projector to a computer

Switch off the power supply to the projector and computer before attempting to make the connection.

### Eligible computers

There are computers with which connections cannot be established and computers that cannot be used for projection purposes even though a connection has been established. First of all, it is necessary to confirm that a connection can be established with the computer in use.

#### ● Conditions for eligible computers

##### Condition #1: The computer must be fitted with an image signal output port

Check to ascertain that the computer is fitted with ports that will output image signals, such as the [RGB Port], the [Monitor Port] and the [Video Port]. If you have trouble confirming this, refer to chapter on external monitor connections in the computer's instruction manual.

There are computers, such as combined computer/monitor models and laptop models, that do not allow connections or for which optional external output ports must be purchased.

#### Point

Depending on the computer, there are cases when it is necessary to switch the image signal output with the connection key (≡□, etc.,) and the settings.

NEC	Panasonic	Toshiba	IBM	SONY	FUJITSU	Macintosh
Fn+F3	Fn+F3	Fn+F5	Fn+F7	Fn+F7	Fn+F10	Mirroring is set up with monitor adjustments on the control panel after starting up.

The table shown above provides examples for certain products. Refer to the computer's instruction manual for further details.

##### Condition #2: The resolution and frequency of the computer must be within the boundaries listed in the chart on the next page.

Projection will not be possible if the computer does not support the output image signal resolutions and frequencies shown in the chart on the next page (there are cases where projection is possible, but vivid projection will not be possible).

Confirm the image signal resolution and frequency with the computer's instruction manual.

There are also computers available that allow the output resolution to be amended. In this case, amend the parameters to fit within the ranges shown in the chart on the next page.

Signal	Refresh Rate (Hz)	Resolution (Dots)	Pixels (dots) Used During Resizing Display (Resize On)	Pixels (dots) Used During Real Display (Resize Off)	Remarks
PC98		640×400	1024×640	640×400	
VGACGA		640×400	1024×640	640×400	
VGAEGA		640×350	1024×560	640×350	
VGA	60	640×480	1024×768	640×480	
VESA	72/75/85/100/120	640×480	1024×768	640×480	
SVGA	56/60/72/75/85/100/120	800×600	1024×768	800×600	
XGA	43i/60/70/75/85/100	1024×768	1024×768	1024×768	
SXGA	70/75/85	1152×864	1024×768	1152×864	Virtual (Partial) Display
SXGA	60/75/85	1280×960	1024×768	1280×960	Virtual (Partial) Display
SXGA	43i/60/75/85	1280×1024	960×768	1280×1024	Virtual (Partial) Display
SXGA+		1400×1050	1024×768	1400×1050	Virtual (Partial) Display
		1440×1080	1024×768	1440×1080	
UXGA	48i/60/65/70/75/80/85	1600×1200	1024×768	1600×1200	Virtual (Partial) Display
MAC13		640×480	1024×768	640×480	
MAC16		832×624	1024×768	832×624	
MAC19		1024×768	1024×768	1024×768	
MAC21		1152×870	1016×768	1152×870	Virtual (Partial) Display
iMAC		640×480	1024×768	640×480	
		800×600	1024×768	800×600	
		1024×768	1024×768	1024×768	
NTSC			1024×768	1024×576	4:3 ↔ 16:9, Selectable
PAL			1024×768	1024×576	4:3 ↔ 16:9, Selectable
SECAM			1024×768	1024×576	4:3 ↔ 16:9, Selectable
SDTV (480P/i)	60		1024×768	1024×576	
HDTV (720P)	60		1280×720	1024×576 (16:9)	
HDTV (1080P/i)	60		1024×768	1024×576 (16:9)	

## In the case of the mini D-Sub 15 pin

### ⚠ Caution

- Switch off the power supply to the projector and computer before attempting to make the connection. Failure to observe this may result in damage.
- Confirm the shape of the cable connector and the shape of the port before making the connection. Applying excessive force when the direction or shape of the connector and port differ may result in defects and damage to the equipment.

- Connect the computer's monitor port to the Computer #1 mini D-Sub 15 Port on the projector with the computer cable supplied.
- Set the switch to the analog setting (right-hand side) with the tip of a ballpoint pen or other pointed object.

### ● When the monitor port is the D-Sub 15 pin

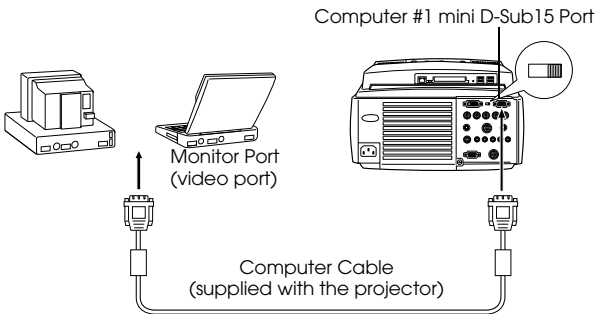

### ● When the monitor port is the 5BNC

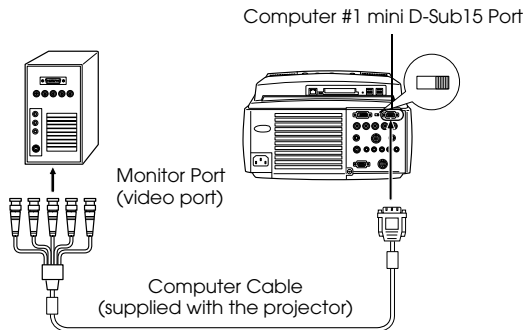

---

**Point**

- Do not bind the Power Cable and the Computer Cable together. Failure to observe this may result in malfunctions.
  - An adapter may be required when making the connection depending on the stand of the computer's port. Refer to the computer instruction manual for further details.
  - There are cases where the optional (ELPAP01) Mac Desktop Adapter and Mac Monitor Adapter are required when connecting up to a Macintosh.
  - It is possible to establish connections with both the Computer #1 Port and the Computer #2 Port when two computers are to be connected.
- 

**● When the monitor port is 13w3**

The Computer #1 Port is also connected to the D-Sub 15 port with the use of the conversion cable when the 13w3 port is used for connecting the computer's monitor port to a work station.

- The projector's computer #1 mini d-Sub 15 Port is connected to the computer's monitor port (13w3) with the 13w3 ↔D-Sub 15 cable (available on the open market).
- Set the switch to the analog setting (right-hand side) with the tip of a ballpoint pen or other pointed object.

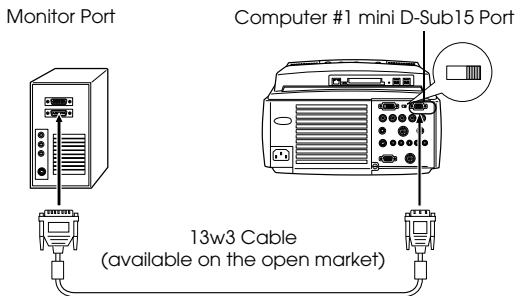



---

## In the case of 5BNC

### (When connected to the second computer)

Connects the computer monitor port to the projector's Computer 2/Component Video-BNC Port with the computer cable supplied.

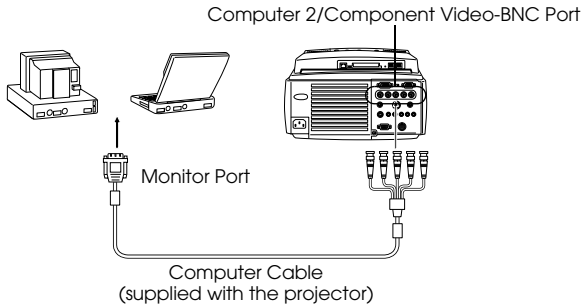

---

#### Point

- Set the BNC parameter to [RGB] when establishing the connection. (see page 70)
- Make the connection with the 5BNC <--> 5BNC cable (optional:ELPKC13) when the computer monitor port is 5BNC.
- Connections can be made to both computer #1 port and computer #2 port when two computers are to be connected.

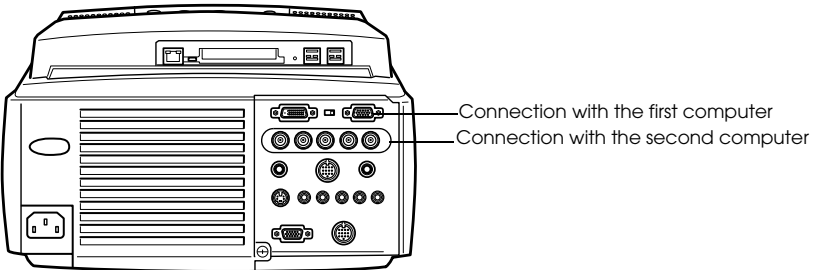

---

## In the case of DVI-D\*

Digital signals are output to the projector without amendment if a digital video card for liquid crystal displays and output port are mounted onto the computer.

- Connect the computer's digital output port to the projector's computer #1 DVI-D port with the optional digital video cable (ELPKC20/21). Select the cable in accordance with the shape of the computer port (DVI-D/DFP).
- Set the switch to the digital setting (left-hand side) with the tip of a ballpoint pen or other pointed object.

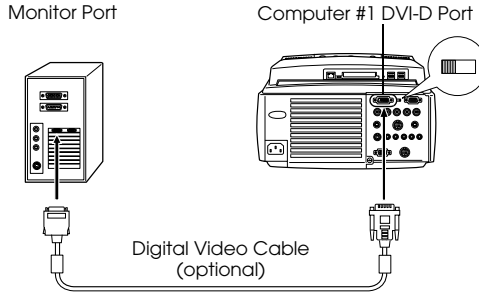

---

### Point:

There are cases where the computer must be set up in order to switch the computer output to the DVI-D. Refer to the instruction manual for the computer for further details.

---

---

## Sound connection

The projector is equipped with two built-in speakers capable of outputting a maximum of 3W, and it is also possible to output computer sound from the projector's speakers.

### ● Connecting the computer to Computer #1

Connect the projector's Audio Port (stereo mini jack) to the computer's audio output port with the Audio Cable supplied.

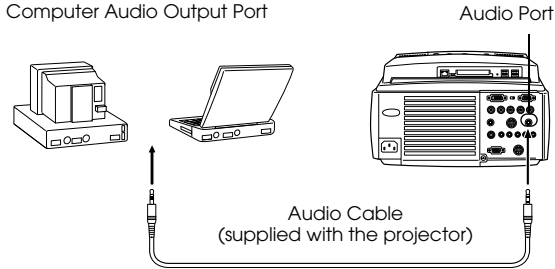

### ● Connecting the computer to Computer #2

Connect the computer's audio output port to the projector's S-Audio/Audio #2 port (RCA pin jack) with the RCA audio cable (sold on the open market).

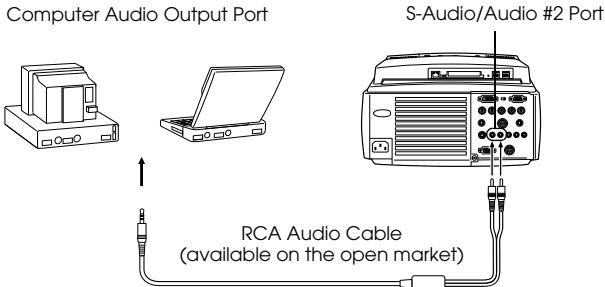

---

### Point

A connection has been established with the audio cable, and the sound for the selected image is being output.

---

---

## Connecting external monitors

It is possible to display the image projected with the projector onto a computer simultaneously. Connect the projector's monitor out port to the computer monitor with the cable attached to the monitor.

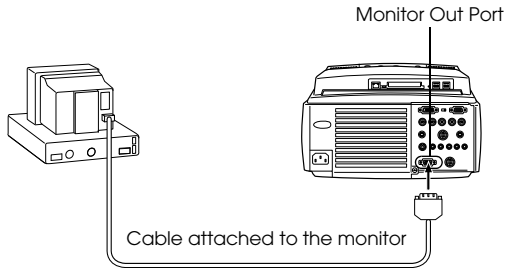

---

### Point

- There are cases where the optional (ELPAP01) Mac Desktop Adapter and Mac Monitor Adapter are required when connecting up to a Macintosh.
  - Images cannot be displayed on external monitors when the computer is connected to the DVI-D port.
-

## Connecting up the mouse (wireless mouse function)

This enables the computer's mouse pointer to be operated with the remote control in the same way as a wireless mouse.

Connect the projector's Mouse/Com Port to the computer's mouse port with the mouse cable and Main Cable.

Computer	Mouse to use	Mouse cable to use
PC/AT DOS/V	PS mouse	PS/2 mouse cable (supplied)
	Serial mouse	Serial mouse cable (supplied)
	USB mouse	USB mouse cable (supplied)
Macintosh	Macintosh mouse	MAC mouse cable (supplied)
	USB mouse	USB mouse cable (supplied)

PS/2 Connection

Mouse/COM Port

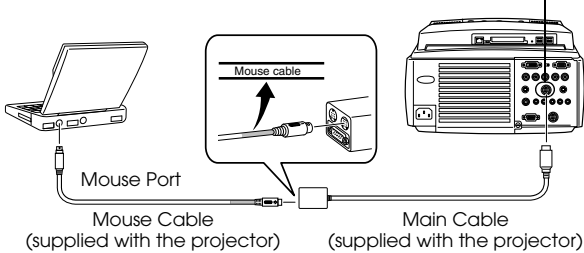

Refer to the above table before making your selection.

### Point

- Only the USB standard mounted model supports USB Mouse Cable connections. In the case of Windows, only the Windows 98/2000 preinstalled model is supported. Operations cannot be guaranteed on upgraded Windows 98/2000 environments.
- Only a computer mouse connected to the mouse/com port can be used.
- The mouse cannot be used when the effect function is in progress.
- There are cases where certain settings must be made on the computer in order to use a mouse. Refer to the instruction manual for the computer for further details.
- Switch off the power to the projector and computer before making the connection.
- It is necessary to reboot the computer if it does not work.

Perform the following mouse operations after the connection has been established:

Left click ----- Press the [Enter] button.

Right click ----- Press the [Esc] button.

Mouse pointer movement ----- Lowers the remote control [Enter] button

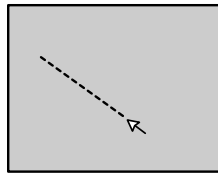
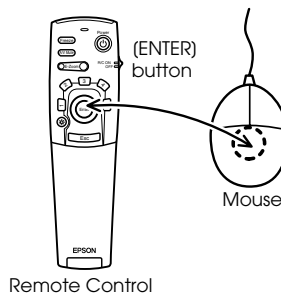
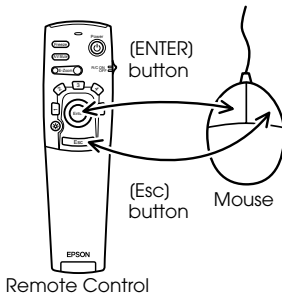

-----  
**Point**

- The operations will be reversed if the left/right button functions of the mouse pointer have been amended with the computer.
  - The mouse cannot be used when the menu is being displayed, when the Effect, P in P or E-Zoom functions are in use.
  - The movement speed of the mouse pointer can be changed. ([see page 70](#))
-

# ■ Connecting the video equipment

Switch off the power supply to the projector and video equipment prior to attempting to make the connection.

---

## Point

The audio signals output the selected image's sound.

---

---

## In the case of composite image signals

- Connect the projector's Video Port to the video equipment with the supplied RCA Video Cable (Yellow).
- Connect the L-Audio-R ports with the RCA audio cable supplied (red/white) to output sound from the projector's speakers.

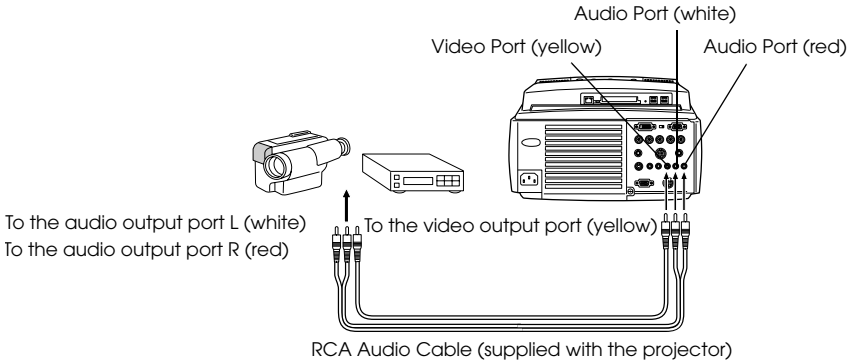

---

## In the case of S image signals

- Connect the projector's S-Video Port to the video equipment with the S-Video cable (available on the open market).
- Connect the supplied RCA Audio Cable (Red/White) to the S-Audio/Audio #2 Port if the sound is to be output from the projector's speakers.

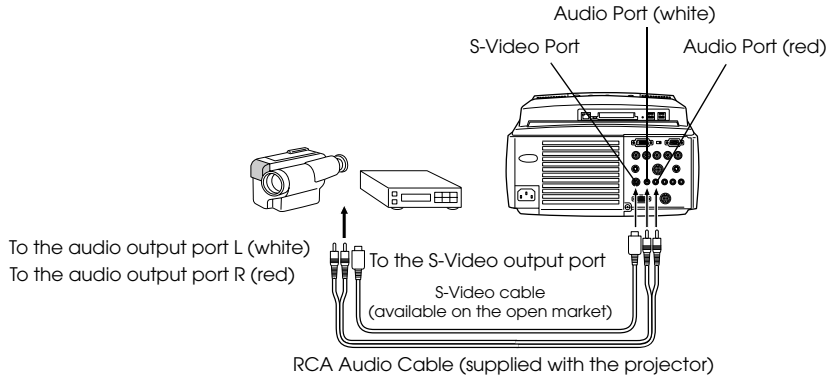

## In the case of component (color differential\*) image signals

- Connect the projector's Computer 2/Component Video-BNC Port to the video equipment with the component video cable (available on the open market) so that the following table is supported.

Video equipment	R-Y(Cr)	Y	B-Y(Cb)
Projector	R/R-Y	G-RCG	B/B-Y

- Connect the S-Audio/Audio #2 ports with the RCA audio cable supplied (red/white) to output sound from the projector's speakers.

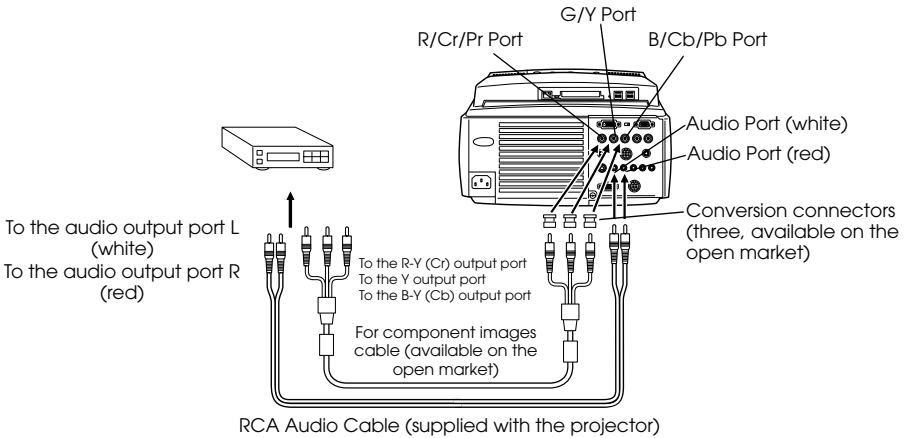

### Point

- A conversion connector (available on the open market) is required on the projector's BNC port when a component image cable is connected. Align the video with the equipment port.
- Set the BNC parameter to [YCbCr] when the connection has been established. ([see page 70](#))



---

## In the case of the digital tuner's D output port

- Connect the digital tuners to the projector's Computer 2/Component Video- BNC port with the optional D port cable (ELPKC23).
- Connect the supplied RCA Audio Cable (Red/White) to the S-Audio/Audio2 Port if the sound is to be output from the projector's speakers.

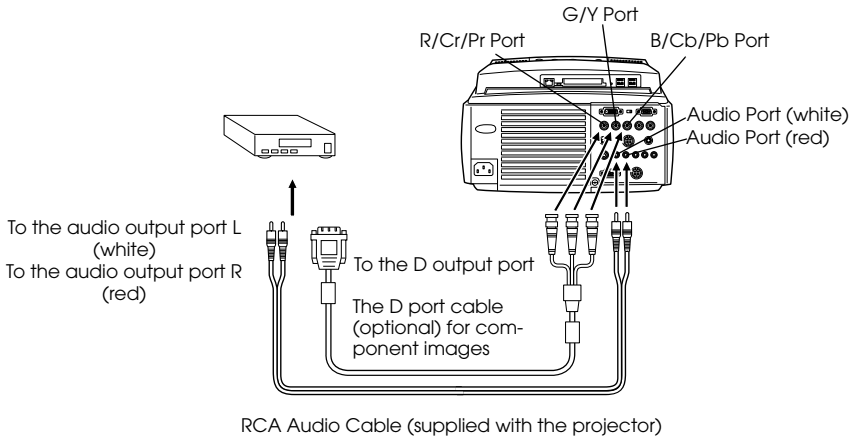

---

### Point

- Set the BNC parameter to [YCbCr] when the connection has been established. ([see page 70](#))
  - Establishing connections with digital tuners is only possible in Japan.
  - Supports digital tuners up to the D4 rating.
-

---

## In the case of RGB image signals

- Connect the projector's Computer 2/Component Video- BNC Port to the video equipment with the component image cable (available on the open market).
- Connect the supplied RCA Audio Cable (Red/White) to the S-Audio/Audio #2 Port if the sound is to be output from the projector's speakers.

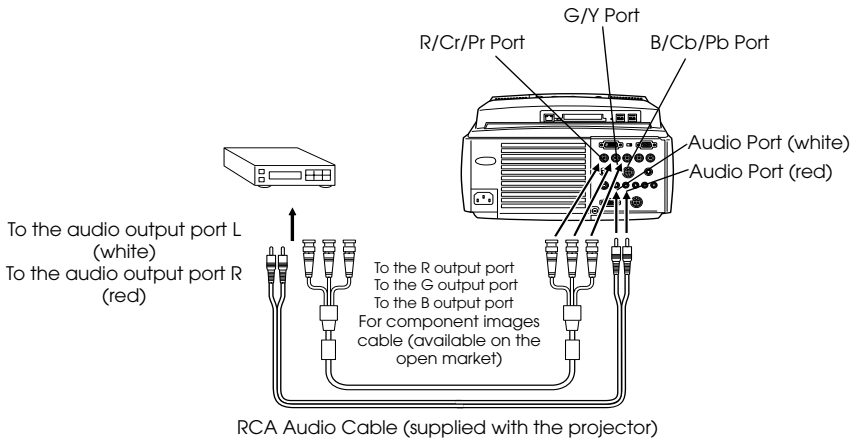

---

### Point

- Purchase the component image cable so that one end matches the BNC type port on the projector and the other matches the port on the video equipment.
  - Set the BNC parameter to [RGB] when the connection has been established. (see page 70)
-

# Projecting

This section provides explanations on starting and ending projection, and on the basic functions for adjusting projected images.

## ■ Projection

Images can be projected after all connections have been completed.

### Preparations

#### ⚠ Warning

- Never look directly into the lens once the power supply has been switched on. Failure to observe this may result in the powerful light damaging eyesight.
- Ensure that the Power Cord supplied is used. The use of cables other than the one supplied may result in the outbreak of fire or electric shocks.

#### ⚠ Caution

Do not perform any projection tasks with the Lens Cover attached. Failure to observe this may result in the cover becoming malformed due to heat.

**1** Connect the projector to a computer and video equipment. (see page 27, 37)

**2** Remove the Lens Cover.

**3** Attach the supplied Power Cord to the projector.

Check to confirm the shape of the projector's Power Inlet and Power Connector, align the connector in the correct direction, and then insert it as far as it will go.

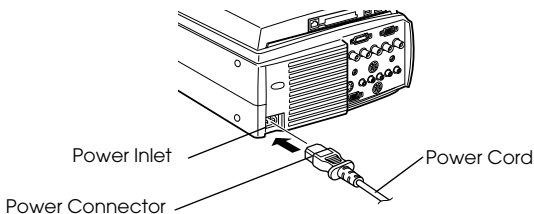

#### 4 Plug the Power Plug into the power socket.

The Operation Indicator will be illuminated in orange.

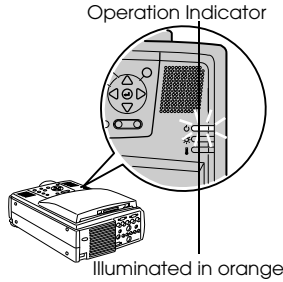

#### Point

Button operations are not possible when the Operation Indicator is blinking in orange.

## Commencing projection

#### 1 Press the [Power] button to turn on the power supply.

The Operation Indicator will begin to blink in green, and projection will be started.

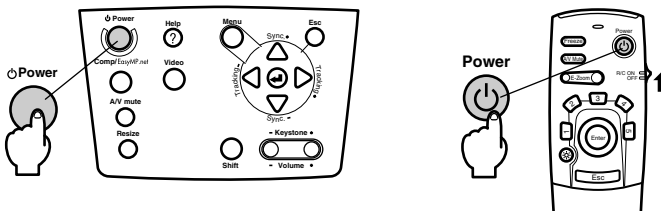

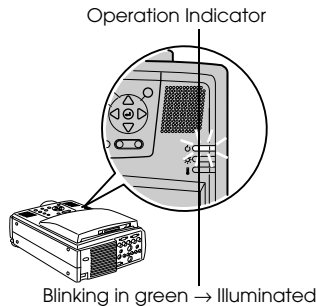

Set the R/C ON OFF switch to (ON) first of all when using the remote control unit

The Operation Indicator blinks and then is illuminated in green after approximately thirty seconds.

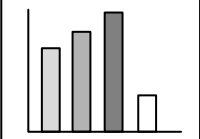
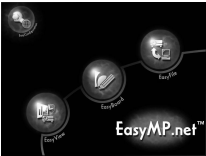

The projected screen will appear as follows in accordance with the situation.

<p>● When no image signals are being input.</p>  <p>A message stating "No Image Signals Input" will be displayed (there are cases where this will not be displayed, depending on the settings). (see page 70)</p>	<p>● When the image signals are being input.</p>  <p>The image will be projected.</p>
<p>● When EasyMP.net has been selected.</p>  <p>The EasyMP.net main menu will be displayed.</p>	<p>● When the power supply is switched on for the first time.</p>  <p>The initial setup screen on which the date is set will be displayed. Set up the date and time on the screen while referring to the EasyMP.net instruction manual.</p>

**Point**

- Set the date and time when the EasyMP.net default setting screen is displayed. (Refer to the "EasyMP.net User's Guide".)
- Button operations are not possible when the Operation Indicator is blinking in green.

**2 Select the Port to which the connection has been made when more than one item of equipment has been connected.**

Press the port button connected to the computer or video equipment to switch the input source.

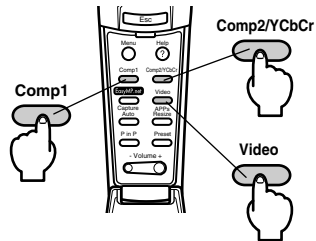
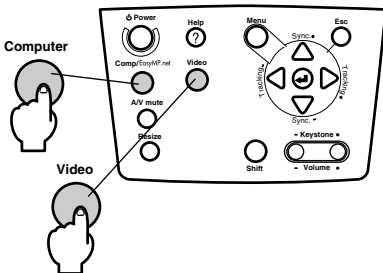

ConnectedPort	Button to Select		Display at the top right-hand corner of the screen
	Main Unit	Remote Control	
EasyMP.net	[Computer] (will change whenever pressed)	[EasyMP.net]	EasyMP.net
Computer #1 Port		[Comp1] (Switched with the BNC setting. (see page 70))	Computer1
BNC Port (RGB)			BNC(RGB)
BNC Port (YCbCr)	[Video] (will change whenever pressed)	[Comp2/ YCbCr]	BNC(RGB)
			BNC(YCbCr)
Video Port		[Video] (will change whenever pressed)	Video
S-Video Port			S-Video

### Point

Only one of the BNC port's sources (BNC (RGB) or (BNC (YCbCr)) that are alternately switched with [Comp/EasyMP.net] and [Video] on the projector and [Comp2/YCbCr] on the remote control will be displayed with the BNC setting. (see page 70)

### 3 Starting projection.

Switch on the power supply to the computer or video equipment. If the equipment connected is video equipment, then also press the [Playback] or [Play] buttons. The [No Signal] display will be erased, and projection will commence.

### Point

- If [No Signal] remains displayed, check the connections once again.
- Depending on the computer, there are cases when it is necessary to switch the image signal output destination with the key (□, etc.) or the settings after establishing the connection.

NEC	Panasonic	Toshiba	IBM	SONY	FUJITSU	Macintosh
Fn+F3	Fn+F3	Fn+F5	Fn+F7	Fn+F7	Fn+F10	Mirroring is set up with monitor adjustments on the control panel after starting up.

The table shown above provides examples for certain products. Refer to the computer's instruction manual for further details.

- Press the [Resize] button when signals that support DVD players or wide television screens (16:9 images) have been input. The parameters will change between 4:3 images and 16:9 images whenever the switch is pressed.
- There are cases where a projected image will remain projected if a still image is projected for a long period of time.
- Refer to the [EasyMP.net Instruction Manual] for further details on EasyMP.net functions.

# Ending

End projection in accordance with the following procedure.

**1** Switch off the power supply to the connected equipment.

**2** Press the [Power] button.

A message to confirm that the power needs to be switched off will be displayed.

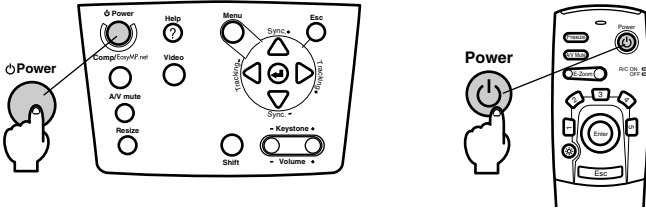

**3** Press the [Power] button once more.

The lamp will be extinguished, the Operation Indicator will blink in orange, and the cool-down process will commence.

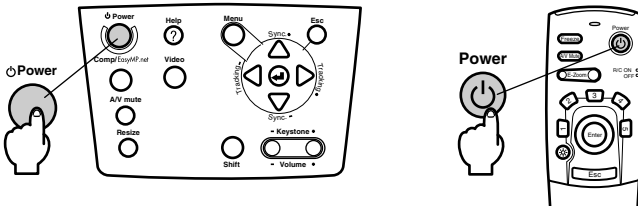
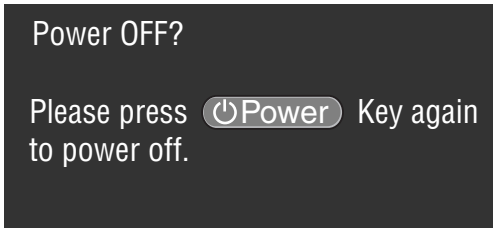

The Operation Indicator will change from blinking to being illuminated in orange once the cool-down process has been completed. The amount of time required for the cool down is approximately forty seconds (may be longer depending on the ambient temperature).

## Point

- Press a different button if the power is not to be switched off. The message will be erased after seven seconds if no buttons are pressed (the power will remain on).
- It is also possible to end projection by pressing the [Power] button as explained in procedure #2 for more than one second (will assume the same status as if ending with procedure #3).
- Button operations are not possible when the Operation Indicator is blinking in orange. In this event, please wait until full illumination has been attained.

- 4** Check to confirm that the Operation Indicator is illuminated in orange, and then unplug the Power Plug from the socket.

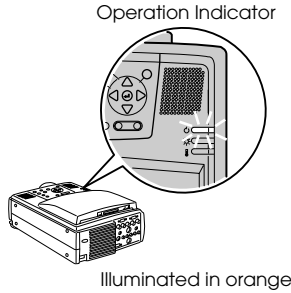

### ⚠ Caution

Do not remove the Power Plug from the socket when the Operation Indicator is blinking in orange. Failure to observe this may result in damage to the equipment and will speed up the period for replacing the lamp.

- 5** Set the R/C ON OFF switch to [OFF] when using the remote control.

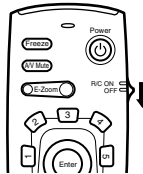

### Point

The batteries are being consumed when the [R/C ON OFF] switch on the remote control unit is set at [ON]. Ensure that the [R/C ON OFF] switch on the remote control unit is set to [OFF] when not in use.

- 6** Restore the Front Foot if it has been extended.

Steady the projector by hand, and then lift the Foot Adjust Lever with a finger and gently lower it into the main Unit.

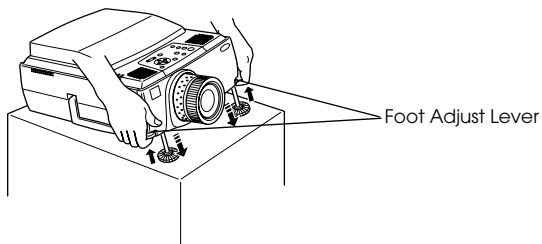

- 7** Attach the lens cover.



# ■ Adjusting the projection position

The projector can be adjusted into the following vertical projection positions.

---

## Feet adjustments

Adjusts the projection angle of the projector. As far as possible, make the necessary adjustments while making sure that the projector is facing the screen at right angles.

### **1** Lift the Foot Adjust Lever with a finger and raise the front part of the projector.

The Front Foot will protrude.

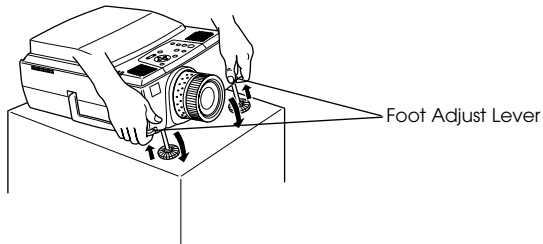

### **2** Remove your finger from the Foot Adjust Lever, and then let go of the projector.

### **3** Rotate the lower part of the Front Foot to minutely adjust the height.

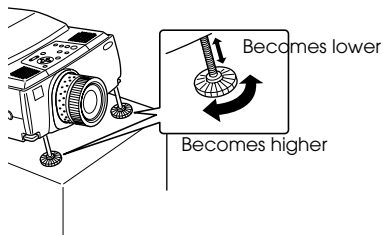

---

### Point

- There are cases where the screen will be distorted into a trapezoid shape when foot adjustments are performed. This trapezoid distortion can be adjusted with the use of the trapezoid correction function. ([see page 49](#))
  - The Front Foot is restored by lifting the Foot Adjust Lever with a finger and lowering the projector.
-

## ■ Adjusting the projection size

It is possible to adjust the size of the projection and correct any trapezoid distortion.

### Point

A function to resize the screen ([see page 56](#)) and an E-Zoom function for enlarging certain areas ([see page 58](#)) are also available.

---

## Zoom adjustment

- 1 Rotate the Zoom Ring to make the required adjustments (enlargement up to a maximum of 1.4x is possible).

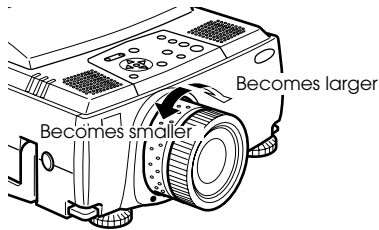

The projection distance must also be adjusted when enlarging the screen. ([see page 24](#))

### Point

If optional lenses are to be used, refer to the relevant instruction manuals for further details.

# Keystone adjustment

Make the necessary adjustment when the screen has been distorted into a trapezoid with foot adjustment.

**1** Press the [Keystone +, -] button to lengthen the screen sideways.

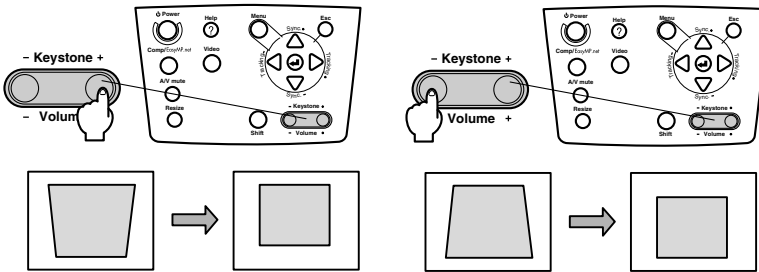

The corrected screen will shrink in size.

The corrected screen will shrink in size.

Keystone correction can be adjusted 30 degrees upwards (64 stages) and 30 degrees downwards (64 stages).

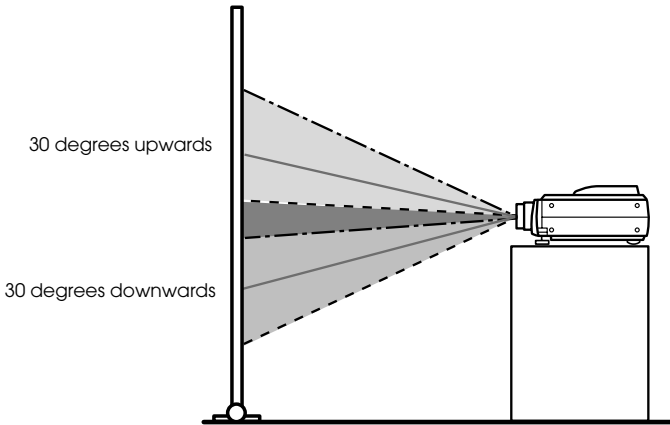

## Point

- The screen will be reduced in size when Keystone correction has been performed.
- The status of Keystone correction will be recorded. Perform readjustments that match the installation position when the projection position or angle have been changed.
- Reduce the sharpness if blurring occurs after Keystone correction. ([see page 68](#))
- Keystone correction can be performed from the menu. ([see page 70](#))

# Picture Quality Adjustment

Adjusts image focus and disturbance.

## Focus adjustment

Aligns the focus of the image.

**1** Rotate the Focus Ring to make the required adjustment.

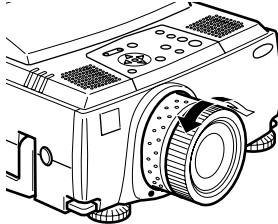

### Point

- It is not possible to align the focus if the lens is dirty or fogged over with condensation. In this event, clean the lens accordingly. ([see page 95](#))
- Correct adjustment is not possible if the installation position is out of line by between 1.1 to 14.6 meters.
- If optional lenses are to be used, refer to the relevant instruction manuals for further details.

## Auto adjustment (when projecting computer images)

Automatically adjusts the computer image to attain the optimum effect. The items adjusted include the Tracking, Position and Sync.

**1** Press the [↵Enter] button on the projector (the [Auto] button on the remote control).

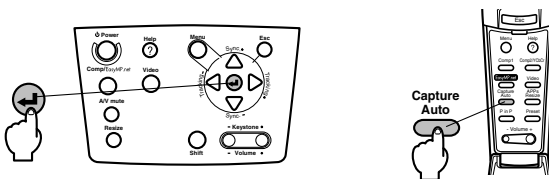

### Point

- If auto adjustments are initiated when the E-Zoom, A/V Mute or Picture-in-Picture functions are executing, adjustment will not be carried out until the executing function has been cancelled.
- Depending on the type of signals being output by the computer, there are cases when adjustment cannot be carried out correctly. In this event, adjust the Tracking and Sync. ([see page 51](#))
- The projected image will be captured and no adjustments will be made when the [Auto/Capture] button on the remote control is pressed while EasyMP.net images are being projected.

---

## Tracking adjustments (when projecting computer images)

Adjusted when vertical stripes are apparent on the computer image.

**1** Press the [Tracking +, -] button on the projector.

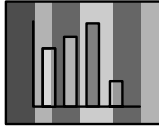

---

## Synchronization adjustments (when projecting computer images)

Adjusted when flashing, blurring and vertical noise are apparent on the computer image.

**1** Press the [Sync +, -] button on the projector.

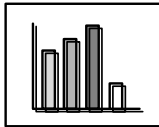

---

## Calling out adjustment values (when projecting computer images)

It is possible to record preset adjustment values and call them out when required.

**1** Press the [Preset] button on the remote control.

The pre-registered numbers between preset #1 and preset #5 will change in sequence whenever this button is pressed.

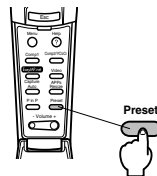
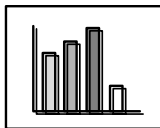

---

### Point

- There are cases when these adjustments must be made again if the values output from the computer (resolution, display color) are amended after flashing and blurring have been adjusted.
  - There are cases where flashing and blurring is caused by adjusting the brightness and contrast\*.
  - Images will be projected more vividly if synchronization adjustments are made after the tracking adjustments.
  - Auto adjustments, tracking adjustments and synchronization adjustments are not possible if no image signals are being input by the computer, such as when projecting video images.
  - The preset values must be registered beforehand. ([see page 68](#))
-

## ■ Introduction of Functions

The functions that can be operated by pressing buttons when images are being projected are listed below.

Function	Outline	Button		Reference Page
		Main Unit	Remote Control Unit	
Help	Displays the method of solving problems when trouble occurs.	Help	Help	<a href="#">53</a>
A/V Mute	Temporarily mutes the image and sound.	A/V Mute	A/V Mute	<a href="#">55</a>
Freeze	Freezes the image.	-	Freeze	<a href="#">55</a>
Resize	Changes the size of the image.	Resize	Resize	<a href="#">56</a>
E-Zoom	Enlarges the image.	-	Zoom	<a href="#">58</a>
Effect	Adds decorations to the image.	-	Effect	<a href="#">59</a>
P in P	Adds a sub-screen to the image.	-	P in P	<a href="#">62</a>
Preset	Calls out pre-registered adjustment values.	-	Preset	<a href="#">51</a>
Trapezoid correction	Corrects trapezoid correction.	Keystone	-	<a href="#">49</a>
Auto adjustment	Automatically adjusts the image for optimum effect.	↵(Enter)	Auto	<a href="#">50</a>
Tracking	Adjusts vertical stripes that appear on the image.	Tracking	-	<a href="#">51</a>
Synchronization	Adjusts flashing, blurring and vertical noise that appears on the image.	Sync	-	<a href="#">51</a>
Volume	Adjusts the volume.	Shift + Volume	Volume	<a href="#">63</a>
Menu	Displays the menu.	Menu	Menu	<a href="#">66</a>

# Useful Functions

This section provides explanations on the effective and useful functions, such as presentations, available with this projector.

## Useful Functions

### Help Function

The methods of solving trouble when it occurs are divided into separate sections and explained below for use when problems arise.

#### 1 Press the [Help] button.

The help menu will be displayed.

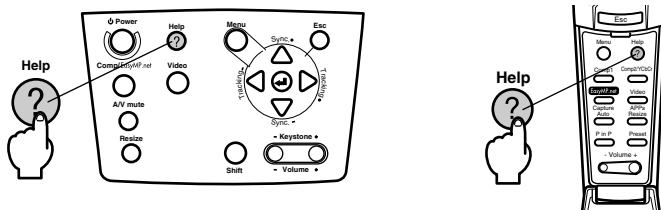

#### 2 Select the item.

Press the [Sync+, -] button on the main unit (move the [Enter] button up and down on the remote control) to select the item.

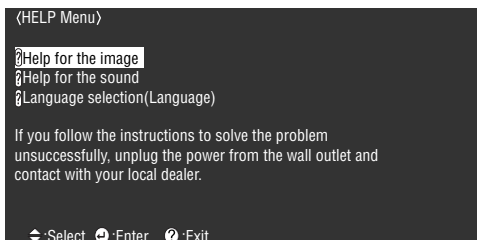

### 3 Set the item.

Set the item by pressing the [Enter] button on the main unit (the [Enter] button on the remote control unit).

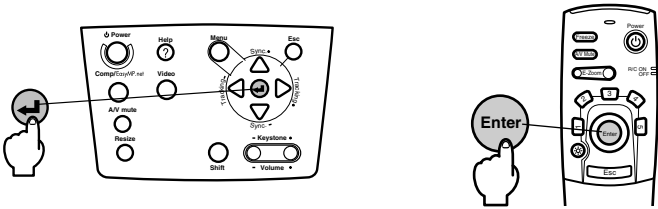

### 4 Repeat the operations explained in procedures 2 and 3 to select and set the detailed items.

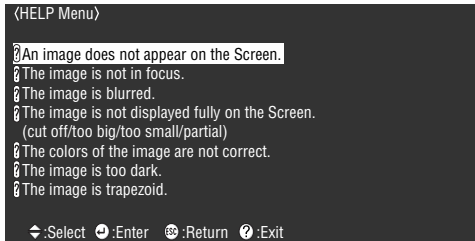

#### Point

- Refer to [Troubleshooting] in this manual if the help text does not solve your problems. ([see page 84](#))
- The help menu can be cancelled by pressing the [ESC] or [Help] buttons.



# ■ Projection Cutting

It is possible to temporarily erase and stop images and sound.

---

## A/V Mute Function

Temporarily erases images and sound. It is also possible to project the user logo at this time.

### 1 Press the [A/V Mute] button.

The images and sound will be erased.

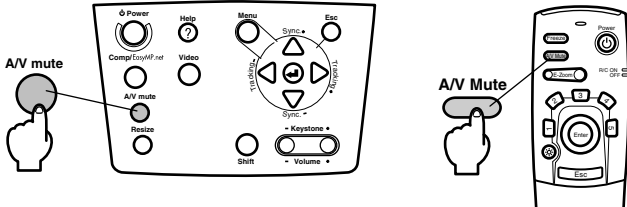

To resume projection, press the [A/V Mute] button once more, adjust the volume control, or display the menu.

Depending on the setting, three different types of statuses may be selected when temporarily erasing images and sound. (see page 70)

Black color



Blue color



User logo



---

### Point

The Epson logo has been registered in the user logo. User logo registration and setup is necessary to amend the user logo. (see page 71)

---

---

## Freeze Function

Temporarily freezes the image; however, the sound will not be muted.

### 1 Press the [Freeze] button.

The image will freeze.

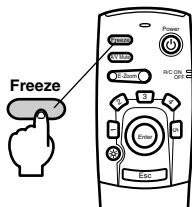

Press the [Freeze] button once more to cancel this mode.

# Switching Image Sizes

The window display and resizing display are switched when projecting images onto a computer. Video image projections are switched between an aspect ratio of 4:3 and 16:9.

## 1 Press the [Resize] button.

The screen size will switch.

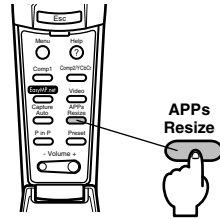
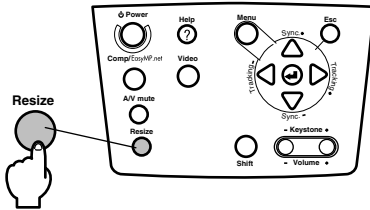

## In the case of computer images

Windows display: Projected at the entered resolution. There are cases where the projection size and the image size are different.

Resizing display: Projected with the resolution reduced or expanded so that the image fits the entire size of the projection.

**(Example) When the input resolution is smaller than the display resolution (in the case of 800 x 600)**

Resizing display

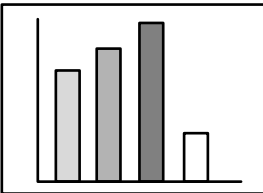

Window display

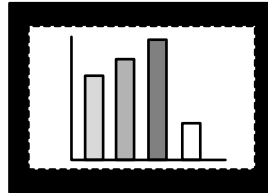

**(Example) When the input resolution is greater than the display resolution (in the case of 1600 x 1200)**

Resizing display

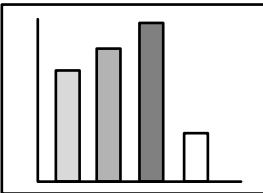

Window display

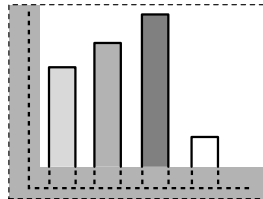

---

**Point**

- The size will not be switched if the display resolution of the liquid crystal is the same as the entered resolution (1024 x 768 dots).
  - A certain portion of the image will not be displayed if the entered resolution is larger than the display resolution of the liquid crystal.
  - Lower the [Enter] button on the remote control unit to scroll through the areas not displayed.
  - Certain areas on the right and left will not be displayed when SXGA (1280 x 1024 dots) is being displayed. Press the [Resize] button while pressing the [Shift] key on the main unit to obtain a full-screen display.
- 

**● In the case of video images**

Switching will be performed for 4:3 and 16:9 image sizes. Images recorded with digital videos and DVD images can be projected on 16:9 wide screens.

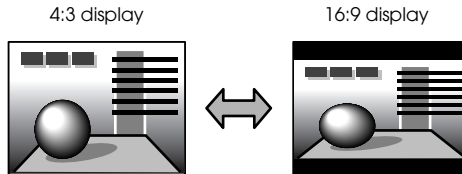

---

**Point**

The application list will be displayed and the image size will not be modified when EasyMP.net images are being projected. (Refer to the “EasyMP.net User’s Guide”)

---

# ■ Enlarging Images (E-zooming function)

It is possible to enlarge projected sizes without amendment.

## 1 Press the [E-Zoom] button.

The size percentage will be displayed in the bottom right-hand corner to enable the image to be reduced or enlarged.

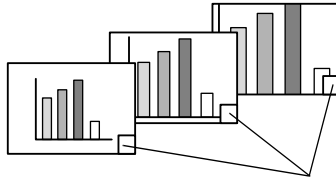

The size percentage will be displayed.

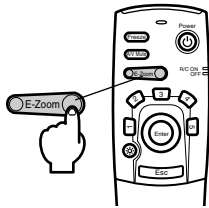

---

### Point

- Enlargement is possible with 24 stages between 1x and 4x at increments of 0.125x.
  - A certain portion of the image will not be displayed when it has been enlarged. Lower the [Enter] button on the remote control to scroll the screen and display this portion accordingly.
  - Sub-screens will be enlarged when the P in P function is being used.
-

# ■ Effect Function

The [Effect] buttons add decorations to images displayed during presentations. The decoration settings can be amended on the effect menu. ([see page 69](#))

---

## Cursor/Stamp

Imprints a stamp on the image.

**1** Press the [1] button.

The selection will switch between three different cursor/stamps whenever the [1] button is pressed.

**2** Lower the [Enter] button on the remote control unit to move the position of the cursor/stamp.

**3** The stamp will be imprinted at the location of the cursor when the [Enter] button on the remote control unit has been pressed.

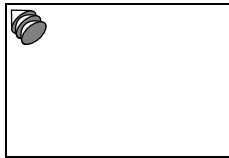

---

### Point

- The effect function will be cancelled and the cursor will disappear when the [Esc] button is pressed.
  - The decoration will be erased when the [5] button is pressed.
  - The mouse cannot be used when the effect function is in progress.
- 

---

## Box

Draws a Box on the image.

**1** Press the [2] button.

**2** Lower the [Enter] button on the remote control unit to move the cursor to the starting position.

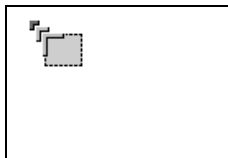

**3** Press the [Enter] button to set the start position.

- 4** Lower the [Enter] button on the remote control unit to move the cursor to the ending position.

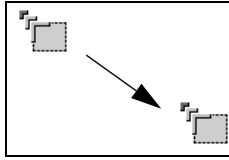

- 5** Press the [Enter] button to set the end position.

**Point**

- The effect function will be cancelled and the cursor will disappear when the [Esc] button is pressed prior to setting the position.
- The decoration will be erased when the [5] button is pressed.
- There are cases where the effect will be difficult to see depending on the color combination of the image's background and the Box. Amend the color of the Box in this event. ([see page 69](#))
- The mouse cannot be used when the effect function is in progress.

---

**Spotlight**

Shines a spotlight on a certain part of the image.

- 1** Press the [3] button.

Will switch between three different spotlight sizes whenever the [3] button is pressed.

- 2** Lower the [Enter] button to move the spotlight.

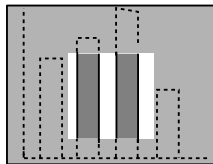

**Point**

- The effect function will be cancelled and the spotlight will disappear when the [Esc] button is pressed.
- The mouse cannot be used when the effect function is in progress.

---

## Bar

Draws a bar line on the image.

**1** Press the [4] button to display the required cursor/stamp.

The selection will switch between three different bars whenever the [4] button is pressed.

**2** Press the [Enter] button to set the end position.

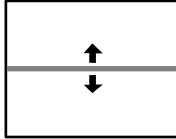

---

### Point

- The effect function will be cancelled and the bar will disappear when the [Esc] button is pressed.
  - There are cases where the effect will be difficult to see depending on the color combination of the image's background and the bar. Amend the color of the bar in this event. ([see page 70](#))
  - The mouse cannot be used when the effect function is in progress.
- 

---

## Cancelling effects

**1** Press the [5] button.

The box, bars and other effects will disappear.

## ■ P in P Function

The video image will be displayed as a sub-screen inside the computer image or video image.

### 1 Press the [P in P] button.

Operation instructions will be displayed at the bottom left-hand side of the sub-screen situated at the top right-hand side of the main screen.

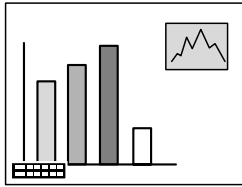

### 2 Press the [Enter] button on the remote control to move the position of the sub-screen.

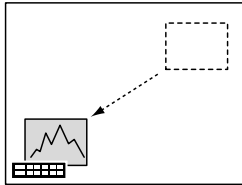

### 3 Press the [E-Zoom] button to change the size of the sub-screen.

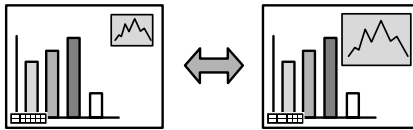

### 4 Press the [1] button to switch across to sub-screen sound.

Press the [2] button to return to the main-screen sound after the sound has been switched.

### 5 Press the [Enter] button to set the sub-screen display.

The operation guide in the bottom left-hand corner will be erased.

---

#### Point

- The sub-screen will be erased when the [PinP] button is pressed again.
  - The computer image or video image (only component video image signals) will be displayed in the main screen, and the video image (Video, S-Video) will be displayed in the sub-screen. The video image displayed in the sub-screen can be amended with the PinP setting. (see page 70)
  - Switch the position, size, and sound of the sub-screen prior to fixing the sub-screen's display.
  - The sub-screen can be switched between five different sizes.
  - When the position of the sub-screen has been amended, it will be displayed in the previously determined position the next time the P in P function is executed.
-



# Adjustments and settings

This section provides explanations on adjusting the projector volume and on setup menu operations.

## ■ Volume Adjustment

The volume can be amended when sound is emitted from the projector speakers.

- 1** Press the [Volume+, -] button while pressing the [Shift] button([Volume+, -]button on the remote control).

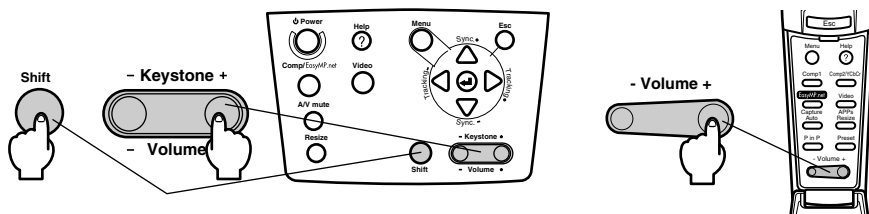

### Point

- Adjustment is not possible when no sound signals are being input.
- Adjustment is possible when outputting sound to external speakers.

# Menu Configuration

The setup menu enables the various adjustments and settings to be made.

## Menu items

The menus are split into top menus and sub menus and consist of a hierarchy structure. Also, the image menu will differ in accordance with the input source (connected port).

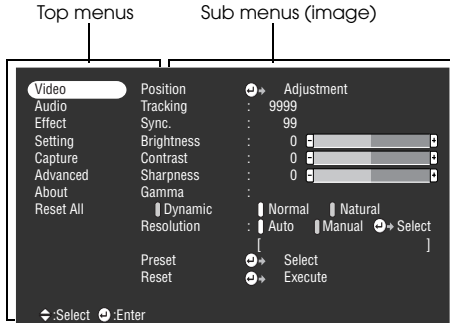

## ● Menu items

Image menu · Computer (D-Sub 15/BNC)

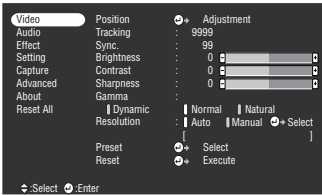

Image menu · Computer (DVI-D)



Image menu · Video (Video/S-Video)



Image menu · Video (BNC)

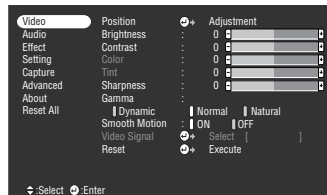
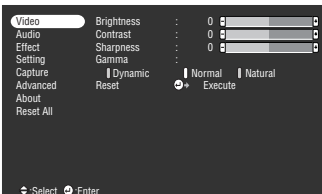

Image menu - EasyMP.net



**Point**

- The items displayed on the image menu will differ in accordance with the projected input source, and the adjustment of menu items that are not displayed is not possible.
- The image menu cannot be adjusted when no image signals are being input.

Sound menu

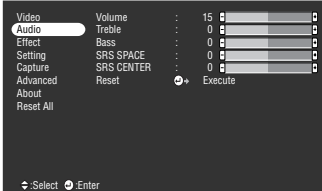

Effect menu



Setup menu

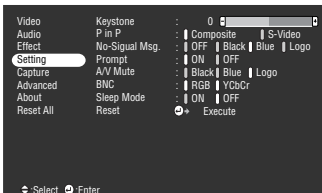

Capture menu

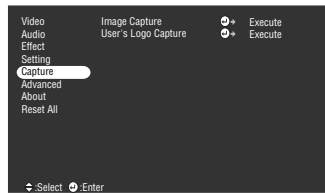

Advance settings menu



Information menu



The information menu displays the setup status of the projected input source

All reset menu

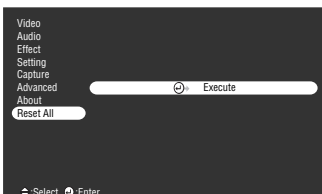

**Point**

The lamp illumination time is displayed in units of 0H between 0 and 10 hours, and, in units of 1 hour above 10 hours.

# Menu Operations

The menus can be operated from both the projector and the remote control unit.

## Operation method

### 1 Press the [Menu] button.

The top menu will be displayed.

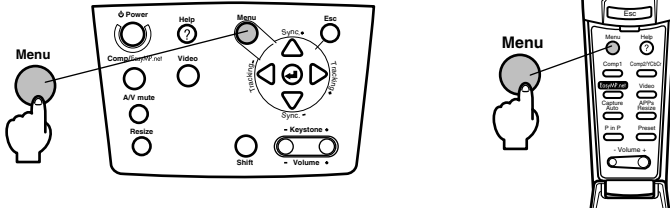

### 2 Select the required item.

Press the [Sync +, -] button on the projector (lower the [Enter] button up or down on the remote control unit) to select the required item.

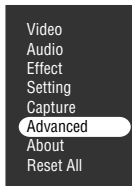

### 3 Set the selected item.

Press the [↵(Enter)] button on the projector (the [Enter] button on the remote control unit) to set the selected item.

The sub-menu will be displayed.

### 4 Then select the detailed sub item.

Press the [Sync +, -] button on the projector (lower the [Enter] button up or down on the remote control unit) to select the sub item.

The items displayed on the image menu and information menu will differ in accordance with the projected input source.

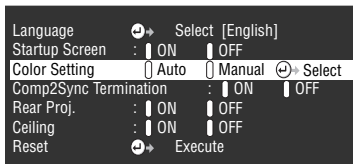

## 5 Select the parameter value.

Press the [Tracking +, -] button on the projector (lower the [Enter] button left or right on the remote control unit) to select the parameter value.

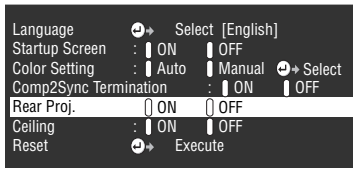

---

### Point

- **↵** (Enter) is attached to the rear of the sub item names that execute the parameters and continue onto the lower hierarchies. Press the [Enter] button to set this selection, and then select the parameter setting again.
- Refer to the list of settings for further information on the function of each setting. ([see page 68](#))

---

## 6 Set all of the other items in the same way.

## 7 Press the [Menu] button.

The menu will end.

---

### Point

- Press the [ESC] button to return to the previous menu in the hierarchy.
  - The items displayed on the image menu will differ in accordance with the projected input source, and menus other than that belonging to the projected input source cannot be adjusted.
  - Image menus cannot be adjusted when no image signals are being input.
-

## Setting items

Top Menu	Sub Menu	Function	Default Value
Video	Position	Moves the image's display position up, down, left and right. Press the [Enter] button to make the required adjustments on the adjustment screen displayed.	Depends on the connection signals
	Tracking	Adjusts vertical stripes that appear on the Computer image.	Depends on the connection signals
	Sync.	Adjusts disturbance, blurring and vertical noise that appears on the Computer image. · Disturbance and blurring may occur as a result of adjusting the brightness and contrast. · It is possible to regulate the vividness of the image by adjusting the synchronization after adjusting the tracking.	0
	Brightness	Adjusts the brightness of the image.	Center value (0)
	Contrast	Adjusts the contrast of the image.	Center value (0)
	Color	Adjusts the color depth of the image.	Center value (0)
	Tint	Adjusts the tint of the image.	Center value (0)
	Sharpness	Adjusts the sharpness of the image.	Center value (0)
	Gamma	Corrects the color vividness of the image. Dynamic : Produces an image with clear color differences. Suitable for displaying plans, etc. Normal : Projects tint without correction. Natural : Produces an image with natural tint. Suitable for video images.	Normal
	Resolution	Sets the input resolution. Auto : Automatically adjusts the input resolution. Manual : Press the [Enter] button and select the required setting from the input resolution selection menu displayed.	Audio
Preset	It is possible to save the current computer input signal adjustment values (input resolution, tracking, synchronization signals, Brightness, Contrast, Sharpness, Gamma display position). Press the [Enter] button and select the preset number under which registration is to be performed from the preset selection menu displayed. · The adjustment values registered under a preset number represent the current status of the system. Ensure that the optimum values have been set up before registering this data. · The preset adjustment values can be called out by pressing the [Preset] button. (see page 51)	Not registered	

Top Menu	Sub Menu	Function	Default Value
Video	Smooth Motion	Images, etc., will move smoothly when seen after this has been set at [ON]. Set this at [OFF] if the colors appear to flicker.	ON
	Video Signal	Sets the video signal method. Press the [Enter] button and select the required setting from the video signal method selection menu displayed. · The video signal method will be automatically set up in the [Auto] mode, but do not use the [Auto] mode for the PAL system (60Hz).	Auto
	Reset	Returns all image menu adjustment values to the default values. Press the [Enter] button and then select [Yes] on the confirmation screen displayed. · Select [Reset All] to return all image and sound values to the default settings. (see page 72)	-
Audio	Volume	Adjusts the volume.	15
	Treble	Adjusts the strength of the high tones.	Center value (0)
	Bass	Adjusts the strength of the low tones.	Center value (0)
	SRS SPACE	Adjusts the width of the sound.	2
	SRS CENTER	Adjusts the depth of the sound.	2
	Reset	Returns all sound menu adjustment values to the default values. Press the [Enter] button and then select [Yes] on the confirmation screen displayed. · Select [Reset All] to return all image and sound values to the default settings. (see page 72)	-
Effect	Cursor/Stamp	Sets the shape, size, color and length of the cursor/stamps allocated to the [1] button. Press the [Enter] button and select the item to be displayed from the cursor/stamp setup menu. The shape, size, color and length conditions can be set by pressing button types 1 to 3 respectively (depending on the selected cursor shape, size, color and length cannot be set up.) · The [1] button executes the cursor/stamp function. The cursor/stamp types will be switched between 1 and 3 sequentially for each time the [1] button is pressed. (see page 59)	Individual settings between types 1 to 3
	Box	Sets the use/non-use and shape of the color and shading of Box allocated to the [2] button. Press the [Enter] button and select the required item from the Box setup menu. · The [2] button executes the Box function. (see page 59)	Color: Magenta Shading: No Shape: Square
	Spotlight	Sets the size of the spotlight allocated to the [3] button. Press the [Enter] button and select the required item from the spotlight setup menu. · The [3] button executes the spotlight function. (see page 60)	Size: Medium

Top Menu	Sub Menu	Function	Default Value
Effect	Bar	Sets the color, direction and width of the bar allocated to the [4] button. Press the [Enter] button and select the required item from the bar setup menu. The color, direction and width can be selected independently for each of the settings between 1 and 3. · The [4] button executes the bar function. The bar types will be switched between 1 and 3 sequentially for each time the [4] button is pressed. (see page 61)	Individual settings between types 1 to 3
	Cursor Speed	Selects the speed of Cursor. L: Slow M:Medium H:Fast	M
	Reset	Returns all effect menu adjustment values to the default values. Press the [Enter] button and then select [Yes] on the confirmation screen displayed. · Select [Reset All] to return all image and sound values to the default settings. (see page 72)	-
Setting	Keystone	Adjusts trapezoid distortion. · The screen will be reduced in size when keystone correction has been performed. · The status of keystone correction will be recorded. Perform readjustments that match the installation position when the projection position or angle have been changed. · Reduce the sharpness if blurring occurs after keystone correction. (see page 68)	Center value (0)
	P in P	Sets the input source for the P in P function's sub-screen. · The P in P function is executed by pressing the [PinP] button. (see page 62)	Composite
	No Signal Msg	The status for [No Image Signal Input] and other message display. · The user logo must be registered and set up before it can be amended.	Blue
	Prompt	Sets whether to display the input source on the screen or not.	ON
	A/V Mute	Sets up the screen status for when the [A/V Mute] button is pressed. · User logos must be registered and set up before they can be amended.	Black
	BNC	Sets the mode for the input image signals connected to the BNC port. RGB: Enables RGB signals to be input. YCbCr: Enables video signals to be input (YCbCr or YPbPr.)	RGB



Top Menu	Sub Menu	Function	Default Value
Setting	Sleep Mode	Sets the energy-saving function for when no image signals are being input. When this is set at [ON], projection will be automatically ended and the projector will enter the sleep mode if no image signals are input and no operations are performed for a period of thirty minutes (the operation indicator will be illuminated in orange). Press the [Power] button to restart projection.	ON
	Reset	Returns all setting menu adjustment values to the default values. Press the [Enter] button and then select [Yes] on the confirmation screen displayed. · Select [Reset All] to return all image and sound values to the default settings. (see page 72)	-
Cap- ture	Image capture	Captures the projected image and saves it on the memory card as a JPEG format image file. It is possible to view images saved onto the memory card and copy them onto computers connected to the network with the EasyMP.net Easy Review and Easy File functions. (see page 73)	-
	User's Logo Capture	Registers user logos. (see page 75) Press the [Enter] button and follow the instructions displayed on the confirmation screen. · The saving procedure requires a certain amount of time to complete. Do not attempt to operate the projector or the equipment connected to the projector while this procedure is running. Failure to observe this may result in damage. · The size that can be registered is 400 x 300 dots. · The display size will be adjusted when video images are being projected.	EPSON logo
Ad- vanced	Language	Sets the language with which messages are to be displayed. Press the [Enter] button and select the required language from the language selection menu displayed. · The EasyMP.net screen is displayed in three interface languages only English, German and French. Even if another interface language is selected, the display language will not change.	English
	Startup Screen	Displays the user logo during warm-up after the power has been switched on. · The user logo must be registered and set up before it can be amended.	OFF
	Color Setting	Adjusts the color temperature* of the image. Auto: Automatically adjusts the color settings. Manual: Press the [Enter] button and select the required item from the color setting menu displayed. · Set the color temperature value to the yardstick value. · The black level and white level settings are only used when multiple projectors are used in the stack formation.	Auto

Top Menu	Sub Menu	Function	Default Value
Ad- vanced	Comp2 Sync Termination	Sets the Computer #2 termination mode to enable image processing from a Port. On: Terminated in analog (75Ω) OFF: TTL input · Usually used at [OFF]. Set at on with the switcher when analog 75 termination is required.	OFF
	Rear Proj.	Set at [ON] to project images onto a half-transparent screen from the rear. The projected image will be inverted.	OFF
	Ceiling	Set at [ON] to project images when suspended from the ceiling. The projected image can be inverted from left to right and up and down. · The optional ceiling suspension unit is required to suspend the projector from the ceiling.	OFF
	Reset	Returns all advanced setting menu adjustment values to the default values. Press the [Enter] button and then select [Yes] on the confirmation screen displayed. · Select [Reset All] to return all image and sound values to the default settings.	-
About		(Displays the current settings)	-
Reset All	Execute	Returns all items in the set-up menus to the default values. Press the [Enter] button and then select [Yes] on the confirmation screen displayed. · Execute the [Reset] function from each individual sub menu to return the image and sound settings to the default values for each menu. · The User's Logo Capture, Lamp ON Time, language and BNC settings cannot be restored to the default values. Perform the reset procedure after the lamp has been replaced. (see page 97)	-

- The image menu and information displayed will differ in accordance with the projected input source, and Menus other than that belonging to the projected input source cannot be adjusted.
- The information menu displays the status of the input source settings being projected.
- If a message stating [Image capture failed] is displayed on the screen, there is a possibility that a system error occurred with EasyMP.net. Switch the projected image across to EasyMP.net and resolve the system error before moving onto the next procedure.

## Image capture

The image currently being displayed will be saved onto the memory card.

- 1** Displays the images that are to be captured.
- 2** Press the [Menu] button and then select [Capture] - [Image Capture].  
A confirmation screen will be displayed.



- 3** Select [Yes] and then press the [Enter].  
A screen to reconfirm the image to be registered will be displayed.

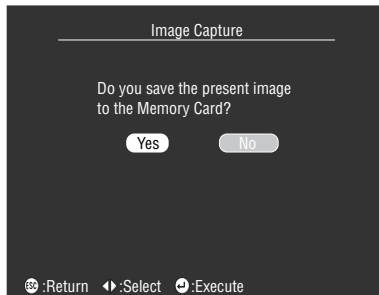

- 4** Select [Yes] and then press the [Enter].

The image will be saved. Wait for a moment until the saving completion screen is displayed.



## 5 Press the [Enter] button or the [Esc] button.

The capture function will be ended and the screen will return to the menu.



---

### Point

- A certain amount of time is required for the saving process. Do not operate the projector or connected equipment while saving is in progress. Failure to observe this may result in defects.
  - Images cannot be saved if the memory card has not been inserted.
  - Do not remove the memory card while images are being saved.
  - A [Capture] folder will be created on the memory card when an image has been captured, and the contents of that screen will be saved in the jpg format.
  - It is possible to view captured images and copy them onto computers connected to the network with the EasyMP.net Easy Review and Easy File functions.
  - If a message stating [Image capture failed] is displayed on the screen, there is a possibility that a system error occurred with EasyMP.net. Switch the projected image across to EasyMP.net and resolve the system error before moving onto the next procedure.
  - Images cannot be captured if the memory card has not been inserted.
  - Images cannot be captured when EasyMP.net is being started up. Use Easy Capture to capture images when EasyMP.net is being started up. (Refer to the "EasyMP.net User's Guide".)
-

## User logo registration

Registers the images currently displayed as the user logo.

- 1 Displays the image that is to be registered as the user logo.
- 2 Press the [Menu] button and select [Capture] - [User Logo Capture].  
The confirmation screen will be displayed.

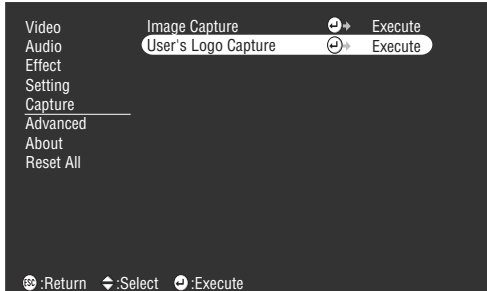

- 3 Select [Yes] and then press the [↵ (Enter)] button on the main unit (the [Enter] button on the remote control).  
The image to be registered will be displayed.



- 4 Adjust the position of the image and then press the [↵ (Enter)] button on the main unit (the [Enter] button on the remote control).  
The confirmation screen will be displayed.

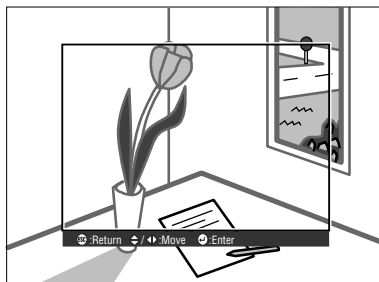

- 5** Select [Yes] and then press the [↵(Enter)] button on the main unit (the [Enter] button on the remote control).

The enlargement setup screen will be displayed.

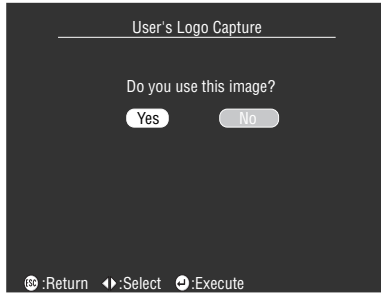

- 6** Select the enlargement rate and then press the [↵(Enter)] button on the main unit (the [Enter] button on the remote control).

The screen to confirm saving will be displayed.

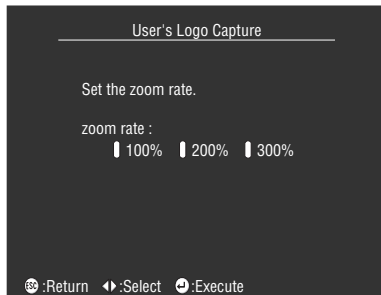

- 7** Select [Yes] and then press the [↵(Enter)] button on the main unit (the [Enter] button on the remote control).

The image will be saved. Wait until the [saving completed] screen is displayed.



---

### Point

- A certain amount of time is required for the saving process. Do not operate the projector or connected equipment while saving is in progress. Failure to observe this may result in defects.
  - The image size that can be registered is 400 x 300 dots.
  - The display size will be amended when the video image is being projected.
-

# Using the EasyMP.net Software

This section provides explanations on the operations required for installing the optional EasyMP.net Software and EMP link V.

## ■ Introduction of EasyMP.net Software

The EasyMP.net PC applications and EMP Link V presentation support software is stored on the [EasyMP.net Software] CD-ROM.

## Presentation support software

### ● EMP Link V

Enables the projector settings to be amended from the computer. This allows functions to be allocated to the [Effect] button and user logos to be edited (refer to the EMP Link V Users' Guide (PDF)).

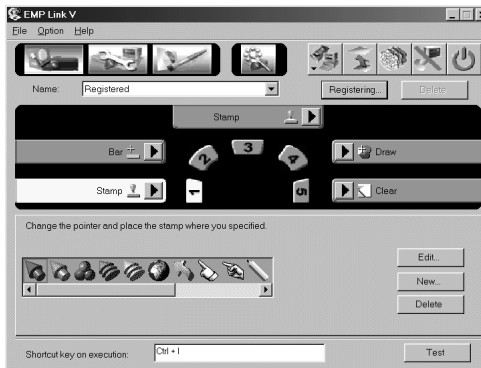

---

## EasyMP.net PC applications

### ● EMP File

It is possible to control the files saved onto the projector's memory card remotely from a computer.

### ● EMP Tablet

It is possible to operate the cursor and execute functions remotely with the computer mouse when EasyMP.net images are being projected.

### ● EMP Scenario

It is possible to create image scenarios for projection purposes.

---

#### Point

- Refer to the EasyMP.net User's Guide for details on using EasyMP.net and the EasyMP.net function PC applications.
  - The EasyMP.net function PC applications will only operate on the Windows 95, 98 and NT4.0 platforms.
  - It is possible to amend the projector settings from a remote location with EasyMP.net by connecting a personal computer to a network and using the browser installed on the PC.
-



# ■ Installation

This section explains how to install the EasyMP.net Software. Four types of software (EMP Scenario, EMP Tablet, EMP File Utility and EMP Link V) and the PDF users' guide for EMP Link V will be installed simultaneously when the installation procedure is executed.

---

## Operating Environment

Check the following to ensure that the software can operate on the computer in use.

### ● Windows Operating Environment

Windows	
Operable computer	Computers operating on the Windows 95/98/NT4.0/2000 platform CPU: Pentium133MHz or more
Available memory capacity	32MByte or more (an additional 8MBytes when operating the Acrobat Reader for the EMP LinkV PDF User's Guide)
Available hard disk capacity	· EasyMP.net Software 5MByte or more
	· Acrobat Reader 10MByte or more*
Display	Resolution of 16bit High Color (640x480) or more

\*20MByte or more is required for the Chinese and Korean languages.

### ● Macintosh Operating Environment (EMP Link V Only)

Macintosh	
Operable computer	Operating on Apple Kanji Talk 7.5.5 or more CPU: Power PC or more
Main memory capacity	32MBytes or more (22MByte when operating the Acrobat Reader)
Available hard disk capacity	· EMP Link V /EMP Link PDF User's Guide 5MByte or more
	· Acrobat Reader 8MByte or more*
Display	32000 Color (640 x 480) or more

\*15MByte or more is required for the Japanese language, and 25MByte or more is required for the Korean language.

---

## Installation

This section explains how to install the software using the Windows 98 screens. Software installation into the Windows 95 platform follows the same procedure.

---

### Point

The EMP Link V users' guide will be installed onto the personal computer together with the software in the PDF format. Acrobat reader is required to read this. If Acrobat Reader is not available on the personal computer in use, it is recommended that it is installed at the same time as EMP Link V.

---

## ● In the case of Windows

### 1 Start up Windows and set the CD-ROM in place.

The set-up program will start automatically.

---

### Point

If the set-up program does not start automatically, open the [Specify and execute file name] dialog box from the [Start] – [Specify and execute file name] menu, and enter [CD-ROM drive name: \SETUP].

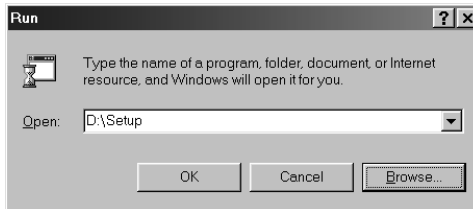

---

### 2 Select the language and the program to be installed and then press the [OK] button.

Installation will then commence. Proceed with all subsequent screens in accordance with the instructions provided.



---

### Point

The program can be un-installed by selecting each Software from the [My Computer] – [Control Panel] – [Add and Delete Applications] menu and then executing [Add and Delete].

---

- **In the case of the Macintosh**

**1** Start up the Macintosh and then set the CD-ROM in place.

**2** Double-click on the EMP Link Installer icon.

The set-up program will start up automatically.

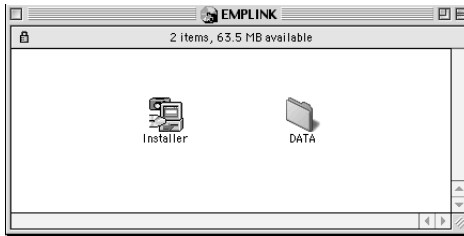

**3** Select the language and click on the [OK] button.

Proceed with all subsequent screens in accordance with the instructions provided.



-----  
**Point**

Drag the [EMP LinkV] folder and [EMP LinkV] contained in [System] – [Default Settings] into the trash can to un-install the program.  
-----

---

## Reading the User's Guide

- **In the case of Windows**

Select [Start] – [Programs] – [EMP Link V] – [User's Guide] to open the file.

- **In the case of the Macintosh**

Double click on the [User's Guide] icon contained within the [EMP LinkV] folder to open the file.

# ■ Computer Connections

Establish a serial connection between the computer and projector when EMP Link V is being used. The computer and projector can be connected together with serial.

## Serial Connections

### ⚠ Caution

- Ensure that the power supply to the projector has been switched off before attempting to establish the connection. Failure to observe this may result in equipment damage.
- Confirm the shape of the cable connector and the port before establishing the connection. If connections are forced despite the connector and port being different shapes, it may result in malfunctions and equipment damage.

### Point

- Depending on the shape of the computer port, an adapter may be required for connection purposes. Refer to the computer's instruction manual for further details.
- The connected computer is used to amend the projector settings and to perform operations. Connect the computer that is required to output projection images to the Computer #1 or Computer #2 port. (see page 27)
- Switch on the projector and ensure that the connection has been set up before using the software.

## ● Windows Computers

Connect the projector's Mouse/Com Port to the computer's serial port with the use of the PC Serial Cable and Main Cable supplied.

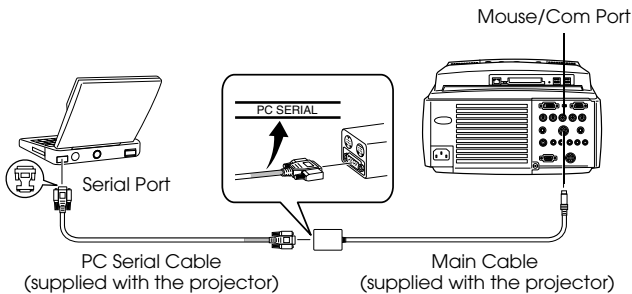

## ● Macintosh Computers

Connect the projector's Mouse/Com Port to the computer's printer port or modem port with the use of the Mac Serial Cable and main cable supplied.

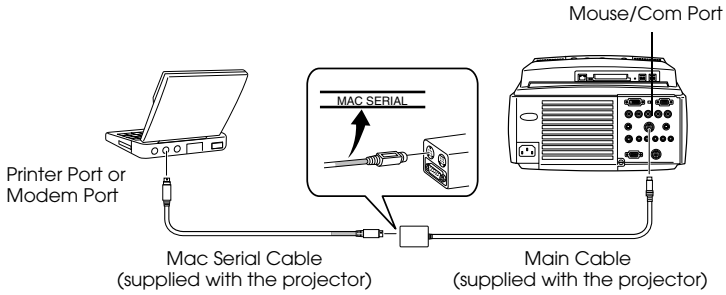

# Troubleshooting

This section provides explanations on potential problems and the methods of taking care of them.

## ■ Troubleshooting

When you think you have a problem, first of all check the Indicators on the projector.

The projector is fitted with Operation Indicator, Lamp Indicator and Temperature Indicator to advise the user of the projector's status.

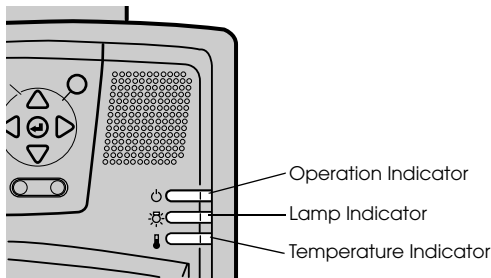

## Operation Indicator

Indicator Status	Cause	Recovery or Status	Reference Page
Illuminated in Orange	Stand-by status	(Not an error) Projection will be started when the [Power] button is pressed.	<a href="#">42</a>
Blinking in Orange	Cool-down procedure in progress	(Not an error) · Wait for a moment. The amount of time for the projector to cool down (cooling the lamp) will depend on the external temperature, etc. · The [Power] button cannot be used during the cool-down period. This will be illuminated in orange once the cool-down process has been completed, so press the button once more then.	<a href="#">49</a>
Illuminated in Green	Projection in progress	(Not an error)	<a href="#">42</a>

Indicator Status	Cause	Recovery or Status	Reference Page
Blinking in Green	Warm-up in progress	(Not an error) <ul style="list-style-type: none"> <li>· Wait for a moment.</li> <li>· The amount of time required for the warm-up procedure is approximately 30 seconds.</li> <li>· The green lamp will stop blinking and become illuminated once the warm-up procedure has been completed.</li> </ul>	<u>42</u>
Illuminated in Red	Internal error	Cease operations, remove the Power Plug from the socket and contact your dealer or nearest address provided at page 107 and request repairs.	
Extinguished	The power is not switched on	The power is not switched on. <ul style="list-style-type: none"> <li>· Check the power cord connection.</li> <li>· Check the power supply to the socket.</li> </ul>	<u>42</u>

## Lamp Indicator

Indicator Status	Cause	Recovery and Status	Reference Page
Blinking in Red	Lamp error	<ul style="list-style-type: none"> <li>· Replace with a new lamp (ELPLP11).</li> <li>· If the lamp is broken, take care to avoid injury and contact your nearest address provided at page 107 to request repairs (images cannot be projected unless the lamp is replaced).</li> <li>· Check to ensure that the lamp or fan are correctly attached if the lamp has been replaced. If the lamp or fan are not correctly attached, the projector will assume the same status as if the power has not been switched on.</li> </ul>	<u>97</u>
Blinking in Orange	Nearing the time for replacing the lamp	Prepare a new lamp. It is recommended that the lamp is replaced as soon as possible, as there are cases where the time for replacement is earlier than stated in the conditions of usage.	<u>97</u>
Extinguished		(Not an error) The power has not been switched on or normal projection is in progress.	

# Temperature Indicator

Indicator Status	Cause	Recovery and Status	Reference Page
Illuminated in Red	Excessive internal temperature (overheating)	<ul style="list-style-type: none"> <li>· Use the projector within the permissible temperature range of between 5 degrees Celsius and 40 degrees Celsius.</li> <li>· Install the projector in a well-ventilated place and ensure that the ventilation inlet and outlet are not blocked.</li> <li>· Clean the Air Filter.</li> <li>· Switch the lamp off when the red lamp is illuminated to reduce the temperature inside the projector.</li> </ul>	<p><u>23</u></p> <p><u>95</u></p>
Blinking in Red	Internal error	Cease operations, remove the Power Plug from the socket and contact your dealer or nearest address provided at page 107 and request repairs.	
Blinking in Orange	High-temperature cooling in progress	<p>(This is not an error, but the projector will automatically cease operating if the temperature increases any further.)</p> <ul style="list-style-type: none"> <li>· Use the projector within the permissible temperature range of between 5 degrees Celsius and 40 degrees Celsius.</li> <li>· Install the projector in a well-ventilated place and ensure that the ventilation inlet and outlet are not blocked.</li> <li>· Clean the Air Filter.</li> </ul>	<p><u>23</u></p> <p><u>95</u></p>
Extinguished		<p>(Not an error)</p> <p>The power has not been switched on or normal projection is in progress.</p>	

## Point

- Refer to the section on [When the Indicators Provide No Help] on the following page if the Indicators appear normal but the projected image is defective.
- Contact your dealer if an Indicator status not covered by the above table is apparent.



# ■ When the Indicators Provide No Help

Refer to each relevant item if the following situations arise but the indicators provide no help.

- The image is not projected page 87
- No sound page 92
- The image is out of focus page 89
- The remote control won't work page 92
- The image is distorted page 90
- The projector will not switch off page 93
- The image color is bad page 91
- The EMP Link V will not function page 93
- The image is dark page 91

---

## The image is not projected

### ● Nothing is displayed



Nothing is displayed

- **Is the Lens Cover still in place?**  
[see page 41](#)
- **Has the power been switched off and then on immediately?**  
The [Power] button will not operate after projection has been finished (during the cooling down procedure). The [Power] button will work again after the cooling down process. Projection lamp cooling operations: the operation indicator is illuminated in orange has been completed.  
[see page 49](#)
- **Is the Sleep Mode set at ON?**  
When the sleep mode has been set at [ON], the lamp will be automatically extinguished if no operations occur and no signals are input for a period of thirty minutes.  
[see page 71](#)
- **Did you press the [Power] button?**  
[see page 42](#)
- **Has the brightness of the image been correctly adjusted?**  
[see page 68](#)
- **Is the system in the [A/V Mute] mode?**  
[see page 55](#)  
Perform the reset procedure.  
[see page 72](#)
- **Is the input image completely black?**  
There are cases where input images will become completely black owing to screen savers, etc.
- **Are image signals being input?**  
No message will be displayed if the [Menu] - [Settings] - [No Signal Display] parameter is set at OFF. Set this to black or blue to display the message.  
Refer to the relevant items when the message is displayed.  
([see page 88](#))

## ● Messages



[Not Supported]  
will be displayed



[No Signal]  
will be displayed

- **Is the resolution of the image signal output from the computer higher than UXGA (1,600 x 1,200)?**  
see page 27
- **Check to ensure that the mode supports the frequency of the image signals output from the computer.**  
Refer to the computer's instruction manual to discover how to amend the resolution and frequency of the image signals output from the computer.  
see page 27
- **Have the cables been connected correctly?**  
see page 27
- **Has the correct image input port been selected for the connection?**  
Press the [Comp/EasyMP.net] or [Video] buttons on the projector ([Comp1], [Comp2/YCbCr] [Video] on the remote control) to switch the image.  
see page 43
- **Has the power supply to the connected computer or video equipment been switched on?**  
see page 44
- **Note-type and liquid crystal type computers must output image signals to the projector.**  
Image signals are not output externally simply because they are output to the LCD screen under normal conditions, so the setting must be switched to external output.  
There are models for which image signals are not output to the LCD screen when output externally.  
see page 27
- **Is RGB being input and the [Menu] – [Setting] – [BNC] parameter set at [YCbCr]?**  
Set to [RGB].  
see page 31
- **Is [Component Video (color difference)] being input and the [Menu] – [Setting] – [BNC] parameter set at [RGB]?**  
Set to [YCbCr].  
see page 38

## The image is out of focus

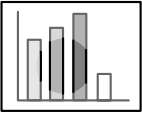

- The screen is blurred.
- Focus can only be attained in certain areas.

- **Has the focus been set correctly?**  
[see page 50](#)
- **Has the projection angle been increased by adjusting the feet?**  
There are cases where the vertical focus is difficult to align if the projection angle is too large.
- **Is the projection distance suitable?**  
The recommended projection distance range is between 1.1m and 14.6m. Locate the projector within this distance range.  
[see page 24](#)
- **Is the lens soiled?**  
[see page 26](#)
- **Is the projection light shining at right angles onto the screen?**  
[see page 95](#)
- **Is the lens fogged?**  
Condensation will form on the surface of the lens when the projector is suddenly brought into a warm room from a cold room, and this may lead to the image seeming blurred. In this event, switch the power off and leave the unit to stand for a while.
- **Has the [Sync.\*, Tracking\* and Position] been adjusted?**  
The image can be adjusted by regulating the [Tracking] and [Sync] buttons on the projector while monitoring the image on screen. Adjustments can also be made by opening the [Menu].  
[see page 51, 68](#)
- **Has the signal format setting for the image been set correctly?**
  - In the case of computer images:  
Set the signal format with [Menu] – [Image] – [Resolution]. There are cases where the image signals being input cannot be determined in the [Auto] mode.  
[see page 68](#)
  - In the case of video images:  
Select the video signal format with [Menu] – [Advanced] – [Video Signal]. There are cases where the video image signals being input cannot be determined in the [Auto] mode.  
[see page 69](#)

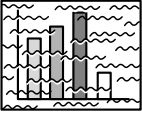

- The image is disturbed.
- Noise appears

- **Has the cable been connected correctly?**  
[see page 27, 37](#)
- **Is the selected resolution correct?**  
Align the computer with the signals supported by the projector. Refer to the computer's instruction manual for details on how to amend the signals.  
[see page 27](#)
- **Has the [Sync.\*, Tracking\* and Position] been adjusted?**  
The image can be adjusted by regulating the [Tracking] and [Sync] buttons on the projector while monitoring the image on screen. Adjustments can also be made by opening the [Menu].  
[see page 51, 68](#)
- **Has the cable length been extended?**  
There are cases where noise will occur if the cable length is extended.
- **Has the signal format setting for the image been set correctly?**
  - In the case of computer images:  
Set the signal format with [Menu] – [Image] – [Resolution]. There are cases where the image signals being input cannot be determined in the [Auto] mode.  
[see page 68](#)
  - In the case of video images:  
Select the video signal format with [Menu] – [Image] – [Video Signal Format]. There are cases where the video image signals being input cannot be determined in the [Auto] mode.  
[see page 69](#)

---

## The image is distorted

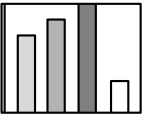

- The image is cut up
- The image is small

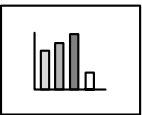

- **There is a possibility that the [Resize] setting has not been correctly selected.**  
Press the [Resize] button.  
[see page 56](#)
- **Has the [Position] been adjusted?**  
Adjust with [Menu] – [Image] – [Position].  
[see page 68](#)
- **Is the selected resolution correct?**  
Align the computer with the signals supported by the projector. Refer to the computer's instruction manual for details on how to amend the signals.  
[see page 27](#)
- **Amend the resolution for note-type and liquid crystal type computers.**  
Either amend the resolution so that the display fills the entire screen, or set the image signals so that only external output is possible.  
[see page 27](#)

---

## The image color is bad

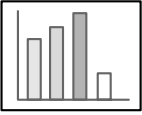

- **Has the image brightness been correctly adjusted?**  
[see page 68](#)
- **Have the cables been connected correctly?**  
[see page 27, 37](#)
- **Has the contrast been correctly adjusted?**  
[see page 68](#)
- **Has the color setting been correctly adjusted?**  
[see page 71](#)
- **Have the color density and tint been correctly adjusted?**  
(The display on the computer monitor or the liquid crystal screen will not always match up with the tint of the image, but this is not an abnormality.)  
[see page 68](#)
- **Is it time to replace the lamp?**  
If the Lamp Indicator is blinking, it means that the time to replace the lamp is drawing near. When the time to replace the lamp draws near, the image will appear dark and the tint will deteriorate. In this event, replace the lamp with a new one.  
[see page 97](#)

---

## The image is dark

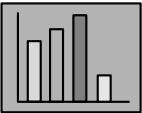

- **Is it time to replace the lamp?**  
If the Lamp Indicator is blinking, it means that the time to replace the lamp is drawing near. When the time to replace the lamp draws near, the image will appear dark and the tint will deteriorate. In this event, replace the lamp with a new one.  
[see page 97](#)
- **Has the image brightness been correctly adjusted?**  
[see page 68](#)
- **Has the contrast been correctly adjusted?**  
[see page 68](#)

---

## No sound



- **Has the sound input been connected correctly?**  
[see page 33, 37](#)
- **Has the image for which sound is required been selected?**  
[see page 43](#)
- **Is sound being emitted from connected equipment?**  
Confirm the sound from connected equipment, etc.  
Has the volume been turned right down?  
[see page 63](#)
- **Has the [A/V Mute] function been left on?**  
There is a possibility that the A/V Mute mode is in effect.  
Press the [A/V Mute] button, adjust the volume, or display the menu to cancel the A/V Mute status.  
[see page 55](#)
- **Is the sound being output to external speakers?**  
Sound will not be output from the projector's speaker if a stereo mini-jack has been connected to the Audio Out port.

---

## The remote control won't work



- **Is the [R/C ON OFF] switch on the remote control on?**  
[see page 42](#)
- **Is the remote control being aimed in the correct direction?**  
The operable range of the remote control unit is 30° to the left and right, and 15° up and down.  
[see page 21](#)
- **Is the distance between the remote control and the projector too great?**  
The operable distance of the remote control unit is approximately 10m.  
[see page 21](#)
- **Is the remote control receiver connected and the remote control being aimed at the projector?**
- **Is the light-receiving area on the remote control blocked?**
- **Has the remote control light-receiving area been subject to direct sunlight, fluorescent light or any other strong light source?**
- **Have the batteries been mounted in place?**  
[see page 22](#)
- **Have the batteries run out?**
- **Have the batteries been mounted back to front?**  
[see page 22](#)

---

## The projector will not switch off (after the [Power] button has been pressed)

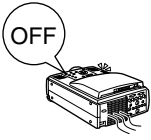

- **Is the Operation Indicator illuminated in orange?**  
The projector has been designed so that the Operation Indicator is not extinguished even when the power has been switched off. The Operation Indicator will be extinguished when the Power Plug has been disconnected from the socket.
- **The fan will not cease operations.**  
The cool-down process (to allow the projector lamp to cool down; the operation indicator will blink in orange) will be performed after the power has been switch off by pressing the [Power] button. The operation indicator will be illuminated in orange when this has been completed, so remove the power plug from the socket at this point.  
\*The amount of time required for the cool-down process will depend on the external temperature.

---

## EMP Link V will not function



- **Are the connection settings correct?**  
Select a COM port number that is not being used by a printer or modem.
- **Have the cables been connected correctly?**
- **Were the connections established with the power supply switched off?**
- **Is the signal extension cord too long?**
- **Did installation end normally?**  
Re-install if not.
- **Has the power supply to the projector been switched on?**  
Reboot the computer.

---

### Point

If an abnormality remains after checking the results of the above inspections, disconnect the Power Plug from the socket and consult with your dealer.

---

# Maintenance

This section provides explanations on taking care of the projector, replacing consumable items and other maintenance procedures.

## ■ Cleaning the projector, Cleaning the lens, Cleaning the Air Filter

Clean the projector if it becomes soiled or if the quality of the projected images deteriorate. Please clean the air filter about every 100 hours of operation.

### Warning

- Personnel other than qualified servicemen must never open the projector. Many high-voltage parts are contained inside the cover that may cause electric shocks. Contact your dealer or your nearest address provided at page 107 to request internal inspections, repairs, adjustments, cleaning and other tasks.
- Exercise caution when handling the Power Plug and Power Connector. Mishandling may result in the outbreak of fire and electric shocks. Observe the following when handling the Power Plug.
- Do not connect plugs or connectors that have become dirty or have foreign matter adhering to them.
- Ensure that the plugs and connectors are firmly inserted in the relevant sockets as far as they will go.
- Never attempt to connect plugs and connectors with wet hands.

### Caution

- Never attempt to remove the lamp immediately after use. Failure to observe this may result in burns or other injuries. Allow the projector to cool down for at least sixty minutes after the power supply has been switched off.
- Disconnect the Power Plug and Power Connector from their sockets when carrying out maintenance tasks. Failure to observe this may result in electric shocks.

Switch off the power supply and disconnect the Power Cord prior to cleaning any part of the projector.



---

## Cleaning the projector

- Gently wipe the soiled parts of the projector with a soft cloth.
- When the soiling is severe, wipe the area with a cloth moistened with a medium-strength cleaning agent diluted with water, and then gently wipe it with a dry cloth.  
Never use wax, Benzene, thinner or other active agents. Failure to observe this may result in damage or paint peeling from the casing.

---

## Cleaning the lens

Clean the lens with an air-blower (available on the open market) and special lens cleaning paper. The surface of the lens is easily damaged, so exercise extreme caution and avoid using anything other than soft materials.

---

## Cleaning the Air Filter

Air ventilation will deteriorate and the internal temperature of the projector will rise if the Air Filter becomes blocked with dirt and dust, and this may result in damage.

Ensure that the projector is stood on its end and the Air Filter cleaned with a vacuum cleaner to prevent the dirt and dust from penetrating inside.

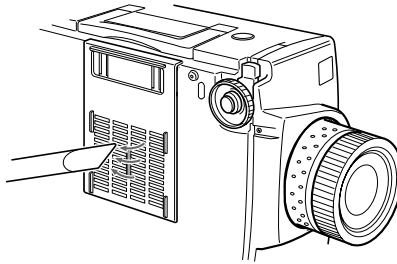

---

### Point

- If it is no longer possible to remove the dirt from the Air Filter or it begins to crack, it is time to replace it. Contact your dealer in this event.
  - A replacement air filter is packaged with the replacement lamp. Replace the Air Filter at the same time as replacing the lamp.
-

# ■ Replacing the Air Filter

---

## Replacement method

- 1** Switch off the power supply, allow the projector to cool down\*, and then disconnect the Power Cord. The amount of time required for the projector to cool down will depend on the surrounding temperature.
- 2** Remove the Air Filter.

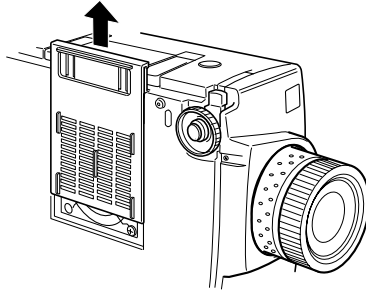

---

### Point

Ensure that the projector is stood on its end when replacing the Air Filter to prevent the dirt and dust from penetrating inside.

---

- 3** Set a new Air Filter in place.

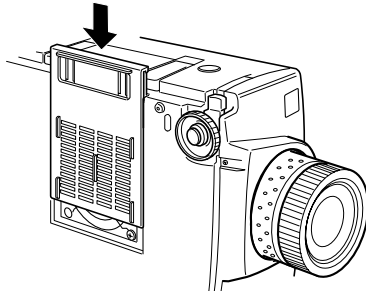

---

### Point

Insert the clips before pressing on the catch to set the air filter in place.

---

## ■ Replacing the lamp

Replace the lamp at the following times (model number: ELPLP11).

**When a message stating [Lamp Replace] is displayed for thirty seconds after the start of projection**

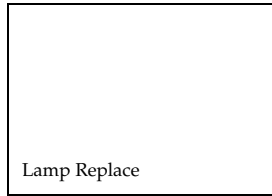

**When the lamp indicator is blinking in orange**

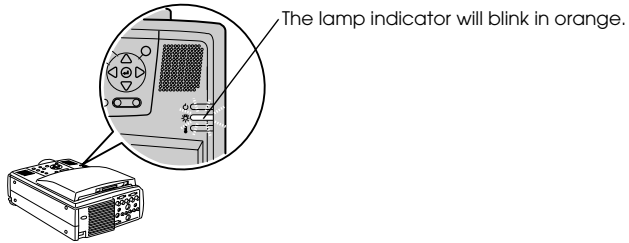

**When the brightness and picture quality has deteriorated below the initial levels**

---

### Point

- Replace the lamp as quickly as possible after the message has been displayed to maintain the initial brightness levels and picture quality.
  - The replacement message has been set at approximately 2,000 hours of use in order to maintain the initial brightness levels and picture quality.
  - Although the replacement message is displayed after approximately 2,000 of use, there are cases where the individual characteristics of each lamp and other usage conditions result in it not lighting up before this 2,000 hours has elapsed. For this reason, always prepare a replacement lamp well in advance.
  - Replacement lamps are available from Epson OA Supplies Inc.  
Order your lamps from your nearest Epson dealer.
-

## Replacement method

- 1** Switch off the power supply, allow the projector to cool down\*, and then disconnect the Power Cord.

The amount of time required for the projector to cool down will depend on the surrounding temperature.

- 2** Once the projector has cooled down sufficiently, remove the Fan.

- Approximately sixty minutes are required for the projector to cool down sufficiently.
- Remove the two screws holding the Fan in place.

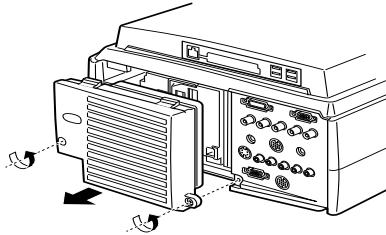

- 3** Withdraw the lamp.

Loosen the three screws holding the lamp in place, and then pull the lamp out towards you.

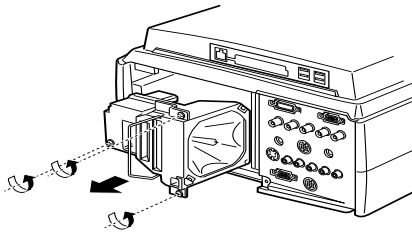

- 4** Attach a new lamp.

Align the direction, push the lamp in as far as it will go, and then secure it in place with the three screws.

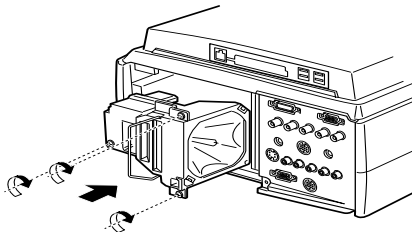

## 5 Attach the Fan.

Align the direction, insert the fan, and then secure it in place with the two screws.

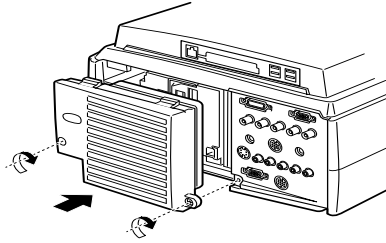

### Point

- Ensure that the lamp has been firmly secured in place. For safety reasons, this projector has been designed so that the power supply is automatically disconnected when the fan is removed. It will not be possible to switch on the power supply unless the lamp and Fan have been properly fitted.
- A replacement Air Filter is packaged with the replacement lamp. Replace the Air Filter at the same time as replacing the lamp.
- Ensure that the lamp illumination time is reset in accordance with the following procedure after the lamp has been replaced with a new one.

## Resetting the lamp illumination time

### 1 Press the [Help] button for five or more consecutive seconds.

The screen for resetting the lamp's illumination time will be displayed after the help menu has been displayed.

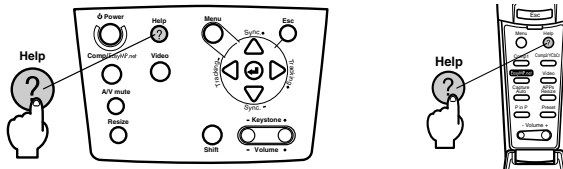

### 2 Select [Yes]

Press the [Tracking +, -] on the main unit (lower the [Enter] button on the remote control unit) and select [Yes].

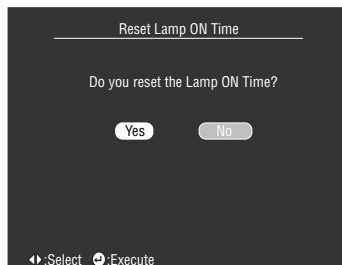

### 3 Execution

Press the [↵ (Enter)] button on the main unit or the [Enter] button on the remote control unit to execute the process.

## Others

This section provides explanations on optional items and after service care, as well as providing details on specifications, terminology and other technical information.

### ■ Optional Parts

The following optional parts are available for purchase in accordance with your needs.

Mac Adapter Set	ELPAP01
Image Presentation Camera (XGA)	ELPDC02
Image Presentation Camera	ELPDC03
Ceiling Bracket	ELPFC02
Ceiling Plate	ELPFC03
Pipe 370 (silver, 370mm)	ELPPF04
Pipe 570 (silver, 570mm)	ELPPF05
Pipe 770 (silver, 770mm)	ELPPF06
WindowScreen (40 inch)	ELPHS01
WindowScreen (60 inch)	ELPHS03
VGA-Computer Cable (HD15/HD15, 1.8m)	ELPKC02
VGA-Computer Cable (HD15/HD15, 3.0m)	ELPKC09
VGA-Computer Cable (HD15/HD15, 20m)	ELPKC10
VGA-Computer Cable (HD15/5BNC, 1.8m)	ELPKC11
VGA-Work Station Cable (5BNC/13W3, 3.0m)	ELPKC12
VGA-Work Station Cable (5BNC/5BNC, 3.0m)	ELPKC13
VGA-Work Station Cable (HD15/EVC, 3.0m)	ELPKC14
VGA-Work Station Cable (5BNC/EVC, 3.0m)	ELPKC15

ELP Link Cable Set	ELPKC17
Serial Mouse Cable 10m	ELPKC18
Digital Video Cable (DVI-D/DVI-D, 3.0m)	ELPKC20
Digital Video Cable (DVI-D/DFP, 3.0m)	ELPKC21
Long Throw Zoom Lens	ELPLL02
Long Throw Zoom Lens	ELPLL03
Spare Lamp	ELPLP11
Rear Projection Wide Lens	ELPLR01
Standard Lens	ELPLS01
Wide Zoom Lens	ELPLW01
Dual Stacker	ELPMB04
Stacker Plus	ELPMB05
Ceiling Mount	ELPMB06
Portable Screen	ELPSC06
60 inch Screen	ELPSC07
80 inch Screen	ELPSC08
Remote Control Receiver	ELPST02
Remote Control Receiver Kit	ELPST04

# ■ Terminology

This section provides simple explanations for the terminology used within the manual, items for which explanations are not available, and other complex processes.

A/V Mute	Temporarily erases the image and sound. The sound and image can be muted by pressing the [A/V Mute] button on the projector. Press the [A/V Mute] button once again or adjust the volume or display the menu to cancel the mute mode.
DVI-D port	The input port that conforms to the DVI digital video ratings (Digital Visual Interface: Ratings to govern how video signals are digitally transmitted). Synchronization and tracking misalignments will not occur during transmission.
D output port	The output port for digital tuners that support the new digital broadcasts within Japan.
Remote port	Enables the optional remote control receiver to be connected so that multiple items of equipment can be operated with a remote control unit.
SRS	The three-dimensional acoustic system. This enables wide and deep sound to be listened to. These are adjusted with the [Space] (wide) and [Center] (deep) buttons.
SVGA	IBM PC/AT compatible (DOS/V equipment) signals with 800 horizontal pixels and 600 vertical pixels.
SXGA	IBM PC/AT compatible (DOS/V equipment) signals with 1,280 horizontal pixels and 1,024 vertical pixels.
Sync(synchronization)	Outputs computer signals at a pre-determined frequency. The image will not be projected clearly unless this frequency is aligned with the frequency of the projector. Aligning the signal phasing is known as synchronization. Projected images will be subject to disturbance, blurring and horizontal noise if not synchronized.
VGA	IBM PC/AT compatible (DOS/V equipment) signals with 640 horizontal pixels and 480 vertical pixels.
XGA	IBM PC/AT compatible (DOS/V equipment) signals with 1,024 horizontal pixels and 768 vertical pixels.
USB	An abbreviation for Universal Serial Bus. This is an interface for connecting comparatively low frequency equipment to the computer.
UXGA	IBM PC/AT compatible (DOS/V equipment) signals with 1,600 horizontal pixels and 1,200 vertical pixels.
Color temperature	The temperature of the subject that emits light. A blue hue is attained when the color temperature is high, and a red hue is attained when the color temperature is low.
Color differential signal (Components)	Video equipment transmits signals through three cables as Red-Bright (R-Y), Bright (Y) and Blue-Bright (B-Y). This enables the composite signals (the red, green and blue signals and their brightness signals are transmitted along one cable) to be projected more clearly.
Operating system	The software necessary to operate the computer. The EMP Link V supplied with the projector operates the computers with the use of the Windows 95 operating system, the Windows 98 operating system, the Windows NT 4.0 operating system, the Windows 2000 operating system.

Cool-down	A lamp cooling procedure continues to operate even after the power supply has been switched off and the lamp extinguished. The cooling fan will begin to operate when the lamp is extinguished, and button operations will no longer be possible. This period is known as the cooling down period. The amount of time required for the cooling down procedure will differ in accordance with the surrounding temperature.
Contrast	By strengthening or weakening the tone of the colors, it is possible to project characters and pictures more clearly and attain a softer tint. This is known as contrast adjustment.
Stack projection	Refers to the simultaneous duplicate projection of images with the use of multiple projectors in order to increase projection image brightness.
Theft-protection lock	A theft-proof (available on the open market) is passed through the holes on the projector case to secure it to a desk or column. These holes support the Micro-Saver Security System manufactured by Kensington Inc. The agency for this product within Japan is listed below.  NANAYO SHOJI CO., LTD. Information & Communication Division Nanayo Bldg. 2-55-7, Hamacho, Chuo-ku, Tokyo 103-0007 Tel: 03-3663-7787 Fax: 03-3669-2367
Synchronization(Sync)	Outputs computer signals at a pre-determined frequency. The image will not be projected clearly unless this frequency is aligned with the frequency of the projector. Aligning the signal phasing is known as synchronization. Projected images will be subject to disturbance, blurring and horizontal noise if not synchronized.
Tracking	Outputs computer signals at a pre-determined frequency. The image will not be projected clearly unless this frequency is aligned with the frequency of the projector. Aligning the signal frequency is known as tracking. Projected images will be subject to disturbance, blurring and horizontal noise if not synchronized.



# ■ Specifications

Product Name	Multi-Media Projector	
Model	EMP-8150/8150NL	
External Dimensions	Width 303 × Height 179 × Depth 389 mm(excluding the lens and feet)	
Panel Size	1.3-inch (Width 27mm × Height 20mm × Corner-to-corner 34 mm)	
Display Emthod	Poly-silicone TFT	
Drive Method	Full-line 12-phase block sequential writing	
Pixel Count	2,359,296 (Horizontal 1,024 × Vertical 768 pixels × 3)	
Focus Adjustment	Manual (When the standard lens is in use)	
Zoom Adjustment	Manual (approximately 1:1.4) (When the standard lens is in use)	
Lamp (light source)	UHE lamp model: ELPLP11 rated 230W	
Maximum Sound Output	3W × 3Wstereo	
Speakers	2	
Power Supply	AC100V 50/60Hz approximately 370W, 8.5W during power-saving 100-120VAC 50/60Hz 4A 200-240VAC 50/60Hz 2A	
Temperature range during use	+5°C to +40°C (with no condensation)	
Temperature range during storage	-10°C to +60°C (with no condensation)	
Weight	Approximately 9.1kg	
Connection ports	Computer 1 port	Single-system mini D-Sub 15pin(female)/ DVI-D portport (switch)
	Monitor Out port	Single-system mini D-Sub 15pin(female)
	Audio 1 port (for use with Computer 1)	Single-system Stereo mini-jack
	S-Audio/Audio2 port (For use with S-Video / Computer2)	Single-system RCA pin jack × (L, R)
	L-Audio-R port (for video use)	Single-system RCA pin jack × (L, R)
	Mouse/Com port	Single-system DIN 13pin
	BNC connection port	Single-system 5BNC(female)
	Video port	Single-sysem RCA pin jack
	S-Video port	Single-system mini DIN 4pin
	Remote port	Single-system Stereo mini-jack
	Stack Out port	Single-system DIN 13pin
EasyMP.net	USB port	4-system Universal serial bus
	Network port	Single-system RJ-45
	Card slot	Single-system PCMCIA

# Check Sheet

Kindly take a copy of the check sheet and fill out the relevant items before contacting us in order to provide us with details on the systems of the trouble that has occurred with your projector.

## Images

### Inquiry details

- The power supply cannot be switched on
- Nothing is displayed on the screen
- A message is displayed
  - NO SIGNAL
  - The image signals are not being input
  - The projector is not able to receive the signals
- Blue screen (blue back)
- Projection pattern
- Logo (the message is not displayed)

- The image breaks up or is too small
  - An area on which nothing is displayed exists
  - The image is smaller than the screen
  - The screen is distorted into a trapezoid shape
  - Certain dots are missing

- The image is not clear
  - The image is blurred or cannot be focused.
  - Stripes are displayed
  - Flickering
  - Certain characters are missing

- The color or the image is bad or too dark
  - Dark
  - The color is bad or dark (computer)
  - The color is bad or dark (video)
  - The color is different on a TV and CRT

### Menu

- The menu is displayed
  - Setup  Sleep Mode ON
- Information (computer)
  - Lamp ON Time H
  - Frequency H Hz
  - SYNC polarity H  Positive  Negative
  - V  Positive  Negative
  - SYNC mode  Separate  Composite
  - Sync on Green
- Input resolution X
- Refresh sheet Hz
- Information (video)
  - Lamp ON Time H
  - Video signal system  AUTO  NTSC  Others

Describe the problem

EMP

Serial number \_\_\_\_\_

Purchasing time  
Year, month \_\_\_\_\_

Indicator  
(Describe the color of the indicator lamps and the status of illumination and blinking)

Operation

Lamp

Temperature

Connector

Is it plugged in firmly?

Computer

- D-Sub15 pin
- BNC
- DVI-D

Video

- Composite
- S port
- Component

Computer settings (screen property)

- LCD display exists
- Resolution X
- Refresh sheet Hz

Connector

Is it plugged in firmly?

Computer

Win • MAC • EWS

Manufacturer's name( )

Model ( )

Note, desktop, single unit

Panel resolution( X )

Video board ( )

Video equipment

Video, DVD, camera

Manufacturer's name ( )

Model( )

Computer cable

- Specially designed
- Length m
- Model number( )
- Wiring, additional equipment
- Model number( )
- Switching unit
- Model number( )

Power cable

- Is it plugged in firmly?
- Power switch on

Always occurs when \_\_\_\_\_ is performed, etc.

Time of occurrence  Before use.  Immediately after the start of usage.  During usage.  Other.( )

Frequency of occurrence  Always.  Sometimes ( \_\_\_ times per \_\_\_ usage).  Other.( )

# ● Sound

## Inquiry details

- No sound can be heard
- The volume is too low
- The sound breaks up
- A different sound is emitted

## Menu

- The menu is displayed
- Sound
  - Volume(     )

EMP
Serial number
Purchasing time
Year,     month

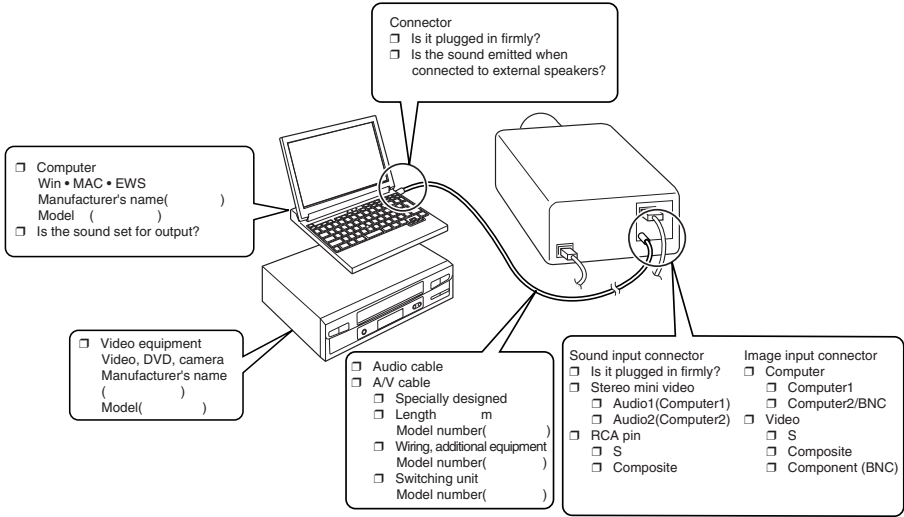

Time of occurrence  Before use.  Immediately after the start of usage.  During usage.  Other.(     )  
 Always occurs when \_\_\_\_\_ is performed, etc.

Frequency of occurrence  Always.  Sometimes ( \_\_\_ times per \_\_\_ usage).  Other.(     )

# ● Remote control unit, wireless mouse, EMP-Link

## Inquiry details

- The remote control unit cannot be used
- The remote mouse cannot be used
- The EMP-Link cannot be used

## Menu

- Advanced settings for the menu displayed with the use of the remote control unit
- 1 ↔ 2

EMP  
Serial number

Purchasing time  
Year, month

Is the remote control receiver blocked?

Computer

Win • MAC • EWS • 98(NEC)  
Manufacturer's name( )  
Model ( )

- Is the mouse set for use?
  - PS/2
  - Serial mouse
  - USB
  - ADB
  - 98(NEC)
- Is the serial port set for use?
- Has the EMP-Link been installed and started up?
- Reboot the computer

Connector

- Computer1
- Computer2/BNC
- Mouse/Com
- Is a cable connected to the remote control connector?

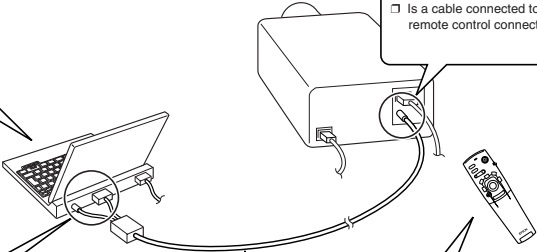

Connector

- Is it plugged in firmly?
- Mouse
  - PS/2
  - Serial mouse
  - USB
  - ADB
  - 98(NEC)
  - Serial  
(when EMP-Link is in use)

Main mouse cable

- Specially designed
- Length \_\_\_\_\_ m
- Model number( )
- Switching unit  
Model number( )

Remote control unit

- Has the power supply been switched on?
- Have the batteries been inserted correctly?
- Move closer to the projector's remote control light-receiving area and try again.

Always occurs when \_\_\_\_\_ is performed, etc. )

Time of occurrence  Before use.  Immediately after the start of usage.  During usage.  Other.( )

Frequency of occurrence  Always.  Sometimes ( \_\_\_ times per \_\_\_ usage).  Other.( )

# ■ World-Wide Warranty Terms

This product includes a world-wide warranty, which allows the equipment to be repaired in more than forty-five countries of the world. Note that product is not covered by the terms of warranty stated here, but by the terms of warranty laid out on the warranty card supplied when the equipment is purchased in each relevant country.

**The world-wide warranty for the Epson Multi-Media Projector is valid in the following countries:**

<Europe>

·Austria ·Belgium ·Bulgaria ·Croatia ·Cyprus ·Czech  
·Denmark ·Finland ·France ·Germany ·Greece ·Hungary  
·Ireland ·Italy ·Luxemburg ·Macedonia ·Holland  
·Norway ·Portugal ·Poland ·Romania ·Slovakia ·Slovenia  
·Spain ·Sweden ·Switzerland ·Turkey ·United Kingdom ·Yugoslavia

<North America and Central America>

·Canada ·Costa Rica ·Mexico ·United States of America

<South America>

·Argentina ·Brazil ·Chile ·Colombia ·Peru ·Venezuela

<Asia and Oceania>

·Australia ·Hong Kong ·Japan ·South Korea ·Malaysia ·Singapore ·Taiwan ·Thailand

**The warranty is subject to the following terms and conditions.**

- 1)The warranty is only valid when the product is presented together with the warranty card or receipt of purchase issued in the country of purchase.
- 2)The warranty will be implemented based on the warranty terms and conditions established by Epson or a service organization stipulated by Epson in countries listed in the instruction manual.
  - The period of warranty is twelve months from the date of purchase.
  - The warranty will cover the cost of spare parts and labor in accordance with the conditions laid out by Epson within the applicable range of the warranty.
  - The user will not be supplied with a substitute product during the period of repair as a basic policy.
- 3)The warranty will not apply in the following situations.
  - a.Defects in consumables (lamps) or optional parts.
  - b.When the product is damaged owing to inappropriate use, damaged during transportation, or handled in a manner not stipulated by the instruction manual.
  - c.When repairs or modified work have been carried out by a third party other than Epson or a service organization stipulated by Epson.
  - d.When trouble arises through the use of optional parts or consumable parts not manufactured by Epson or not otherwise authorized for use by Epson.

## **Note:**

The power cable supplied with the product is subject to the power supply conditions of the country of purchase. When using the product overseas, ensure that an Epson cable specifically manufactured for use in that relevant country is purchased.

## **List of contacts for the Epson Multi-Media Projector's world-wide warranty**

This list of contacts is current as of December 1<sup>st</sup>, 2000. Access the relevant home pages for up-to-date information. If no home page is available, access the main web site at [www.epson.com](http://www.epson.com).

<EUROPE>

**AUSTRIA :**

**EPSON Support Center  
Austria**

Tech. Help Desk: 00491805 235470  
Web Address:  
<http://www.epson.at>

**BELGIUM :**

**EPSON Support Center  
BeNeLux**

Tech. Help Desk: 032 70222082  
Web Address:  
<http://www.epson.be>

**BULGARIA :**

**PROSOFT**

6. AI Jendov Str.  
BG-1113 Sofia  
Tel: 00359.2.730.231  
Fax: 00359.2.9711049  
E-mail: [Prosoft@internet-BG.BG](mailto:Prosoft@internet-BG.BG)

**CROATIA :**

**Recro d.d.**

Trg. Sportova 11  
HR-10000 Zagreb  
Tel: 00385.1.6350.777  
Fax: 00385.1.6350.716  
E-mail: [recro@recro.hr](mailto:recro@recro.hr)  
Web Address:  
<http://www.recro.hr>

**CYPRUS :**

**CTC- INFOCOM**

6a. Ionos Str., Engomi  
P. O. Box 1744  
2406 Nicosia, Cyprus  
Tel: 00357.2.458477  
Fax: 00357.2.668490

**CZECH :**

**EPRINT s.r.o.**

Stresoviccka 49  
CZ-16200 Praha 6  
Tel: 00420.2.20180610  
Fax: 00420.2.20180611  
E-mail: [eprint@mbox.vol.cz](mailto:eprint@mbox.vol.cz)

**FINLAND :**

Tech. Help Desk: 0800.523010  
(note. Some geographical  
areas excluded)

**FRANCE :**

**EPSON France,**

68 bis rue Marjolin, F-92300  
Levallois,  
Tech. Help Desk: 01.49.61.33.95  
Web Address:  
<http://www.epson.fr>

**GERMANY :**

**EPSON Deutschland  
GmbH**

Ziilpicher StraÙe 6  
D-40549 Düsseldorf  
Tech. Help Desk: 01805 235470  
Web Address:  
<http://www.epson.de>

**GREECE :**

**Pouliadis Ass. Corp.**

Aristotelous St. 3  
GR-19674 Athens  
Tel: 0030.1.9242072  
Fax: 0030.1.9441066

**HUNGARY :**

**R.A. Trade Kft.**

Petöfi Sandor u. 64  
H-2040 Budaör  
Tel: 0036.23.415.317  
Fax: 0036.23.417.310

**IRELAND :**

Tech. Help Desk: 01.6799016

**LUXEMBURG :**

**EPSON Support Center  
BeNeLux**

Tech. Help Desk:  
0032 70 222082  
Web Address:  
<http://www.epson.be>

**MACEDONIA :**

**Rema Kompjuteri d.o.o.**

St. Naroden Front 19a  
Iok 16  
91000 Skopje/ Macedonia  
Tel: 00389.91.118159  
Fax: 00389.91.118159

**NETHERLANDS :**

**EPSON Support Center  
BeNeLux**

Tech. Help Desk: 043 3515752  
Web Address:  
<http://www.epson.nl>

**NORWAY :**

Tech. Help Desk: 800.11828

**POLAND :**

**FOR EVER Sp. z.o.o.**

Ul. Frankiska Kawy 44  
PL- 01-496 Warszawa  
Tel: 0048.22.638.9782  
Fax: 0048.22.638.9786  
E-mail: [office@for-ever.com.pl](mailto:office@for-ever.com.pl)

**PORTUGAL :**

**EPSON Portugal, S.A.**

Rua do Progresso, 471-1  
Perafita- Apartado 5132  
Tech. Help Desk: 0808 200015  
Web Address:  
<http://www.epson.pt>

**ROMANIA :**

**MB Distribution S.R. L.**

162, Barbu Vacarescu Blvd.  
Sector 2  
RO- 71422 Bucharest  
Tel: 0040.1.2300314  
Fax: 0040.1.2300313  
E-mail: [office@mbd-epson.ro](mailto:office@mbd-epson.ro)

**DENMARK :**

Tech. Help Desk: 80881127

**SLOVENIA :****Repro Ljubljana d.o.o.**

Smartinska 106  
SLO-1001 Ljubljana  
Tel: 00386.61.1853411  
Fax: 00386.61.1400126

**SPAIN :****EPSON IBERICA, S.A.**

Avda. Roma 18-26,  
08290 Cerdanyola del Vallès,  
Barcelona, SPAIN  
Centro At.al Cliente: 902.404142  
E-mail: soporte@epson.es  
Web Address:  
<http://www.epson.es>

**SWEDEN :**

Tech. Help Desk: 08 445 1258

**<NORTH, CENTRAL AMERICA & CARIBBEAN ISLANDS>****CANADA :**

**Epson Canada, Ltd.**  
100 Mural Street, Suite 300  
Richmond Hill, Ontario  
CANADA L4B 1J3  
Tel: 905-709-3839  
Web Address:  
<http://www.epson.com>

**COSTA RICA :****Epson Costa Rica, S.A.**

Embajada Americana,  
200 Sur y 300 Oeste  
San Jose, Costa Rica  
Tel: (50 6) 296-6222  
Web Address:  
<http://www.epsoncr.com>

**ITALY :****EPSON Italia s.p.a.**

Assistenza e Servizio Clienti  
Viale F. Lli Casiragi, 427  
20099 Sesto  
San Giovanni (MI)  
Tech. Help Desk: 02.29400341  
Web Address:  
<http://www.epson.it>

**SWITZERLAND :****EXCOM Service AG**

Moosacher Str. 6  
CH-8820 Wädenswil  
Tel: 01.7822111  
Fax: 01.7822349  
Web Address:  
<http://www.excom.ch>

**TURKEY :****Romar Pazarlama Sanayi**

**ve TIC. A.S.**  
Rihtim Cad. No. 201  
Tahir Han  
TR-Karaköy-Istanbul  
Tel: 0090.212.2520809  
Fax: 0090.212.2580804

**SLOVAKIA :****Print Trade spol. s.r.o.**

Čajkovského 8  
SK-98401 Lucenec  
Tel: 00421.863.4331517  
Fax: 00421.863.4325656  
E-mail: Prntrd@lc.psg.SK  
Web Address:  
<http://www.printtrade.sk>

**UNITED KINGDOM :****EPSON (UK) Ltd.**

Campus 100, Maylands Avenue  
Hemel Hempstead,  
Herts, HP2 7TJ  
Tech. Help Desk: 0990 133640  
Web Address:  
<http://www.epson.uk>

**YUGOSLAVIA :****BS Procesor d.o.o.**

Hadzi Nikole Zivkovic 2  
11000 Beograd  
Tel: 00381.11.639610  
Fax: 00381.11.639610

**U. S. A. :****Epson America, Inc.**

3840 Kilroy Airport Way  
Long Beach, CA90806  
Tel: (562) 276-4394  
Web Address:  
<http://www.epson.com>

## <SOUTH AMERICA>

### ARGENTINA :

**Epson Argentina S.A.**  
Avenida Belgrano 964/970  
(1192), Buenos Aires  
Tel: (54 11) 4346-0300  
Web Address:  
<http://www.epson.com.ar>

### BRAZIL :

**Epson Do Brasil Ltda.**  
Av. Tucunare, 720  
Tambore Barueri,  
Sao Paulo, SP 06460-020  
Tel: (55 11) 7295-1757  
Web Address:  
<http://www.epson.com.br>

## <ASIA & OCEANIA>

### AUSTRALIA :

**EPSON AUSTRALIA PTY  
LIMITED**  
70 Gibbes Street Chatswood  
NSW 2067 AUSTRALIA  
Tel: 1300 361 054  
Web Address:  
<http://www.epson.com.au>

### HONGKONG :

**EPSON Technical Support  
Centre (Information  
Centre)**  
Rooms 4706-4710,  
China Resources Building,  
26 Harbour Road, Wan Chai,  
HONG KONG  
Tech. Hot Line: (852) 2585 4399  
Fax: (852) 2827 4383  
Web Address:  
<http://www.epson.com.hk>

### JAPAN :

**SEIKO EPSON  
CORPORATION  
SHIMAUCHI PLANT**  
VD Customer Support Group:  
4897 Shimauchi, Matsumoto-shi,  
Nagano-ken, 390-8640 JAPAN  
Tel: 0263-48-5438  
Fax: 0263-48-5680  
<http://www.i-love-epson.co.jp>

### CHILE :

**Epson Chile S.A.**  
La Concepcion 322  
Providencia, Santiago  
Tel: (562) 236-2543  
Web Address:  
<http://www.epson.cl>

### COLOMBIA :

**Epson Colombia Ltda.**  
Diagonal 109, 15-49  
Bogota, Colombia  
Tel: (57 1) 523-5000  
Web Address:  
<http://www.epson.com.co>

### KOREA :

**EPSON KOREA CO., LTD**  
17F HANSOL Bldg., 736-1,  
Yaoksam-dong Kangnam-gu,  
Seoul, 135-080, KOREA  
Tel: 2-553-3515  
Fax: 2-5584271  
<http://www.epson.co.kr>

### MALAYSIA :

**EPSON TRADING  
(MALAYSIA) SDN. BHD.**  
No. 21 Jalan U 1/19, Seksyen  
U1,  
Hicom-grenmarie Industrial  
Park, 40150 Shan Alam,  
Selangor Darul Ehsan  
Tel: 03-5191366  
Fax: 03-5191386

### SINGAPORE :

**EPSON SINGAPORE  
PTE. LTD.**  
401 Commonwealth Drive  
#01-01 Haw Par Technocentre  
SINGAPORE 149598  
Tel: 4722822  
Fax: 4726408

### PERU :

**Epson Peru S.A.**  
Av. Del Parque Sur #400  
San Isidro, Lima, Peru  
Tel: (51 1) 224-2336  
Web Address:  
<http://www.epson.com>

### VENEZUELA :

**Epson Venezuela S.A.**  
Calle 4 con Calle 11-1  
La Urbina Sur  
Caracas, Venezuela  
Tel: (58 2) 241-0433  
Web Address:  
<http://www.epson.com.ve>

### TAIWAN :

**EPSON Taiwan  
Technology & Trading Ltd.**  
10F, No.287, Nanking East Road,  
Section 3, Taipei, Taiwan, China  
Tel: 02-2717-7360 ext. 327  
Fax: 02-2713-2155  
<http://www.epson.com.tw>

### THAILAND

**Epson (Thailand) Co., Ltd.**  
24th Floor, Empire Tower,  
195 South Sathorn Road,  
Yannawa, Sathorn, Bangkok  
10120, Thailand.  
Tel: 6700680 Ext. 309, 316, 317  
Fax: 6700688  
<http://www.epson.co.th>  
**Epson Technical Center**  
21st Floor, Payathai Tower,  
128/227 Payathai Road,  
Rachatawee, Bangkok 10400,  
Thailand.  
Tel: 6120291~3  
Fax: 2165005  
<http://www.epson-tech.in.th>



# Index

## Numerics

13w3 30  
5BNC 29, 31

## A

A/V Mute 70  
A/V Mute button 15, 18  
A/V Mute Function 55  
About 72  
Adjusting the Projection Position 47  
Adjusting the projection size 48  
adjustment values 51  
Advance settings menu 65  
Advanced 71, 72  
Air Filter (suction inlet) 14  
All reset menu 65  
Audio 69  
Audio #1 Port 16  
Audio Cable 33  
Auto adjustment 50  
Auto button 19

## B

Bar 61, 70  
Bass 69  
Battery Cover 20, 22  
BNC 70  
Box 59, 69  
Brightness 68

## C

Cancelling effects 61  
Capture 71  
Capture menu 65  
Ceiling 72  
ceiling suspended projector 24  
Change-over Switch 16  
Change-over switch 32  
Check sheet 104  
Cleaning the Air Filter 95

Cleaning the Projector, Cleaning the Lens,  
Cleaning the Air Filter 94  
Color 68  
color differential 38  
Color Setting 71  
color temperature 71  
Com/EasyMP.net button 15  
Commencing projection 42  
Comp1 button 44  
Comp2 Sync Termination 72  
Comp2/ YCbCr button 44  
component 38  
composite image signals 37  
Computer 44  
Computer #1 DVI-D Port 16  
Computer #1 mini D-Sub 15 Port 16, 29  
Computer #2 BNC Port 16, 31  
computer 2 BNC port 39  
Connecting external monitors 34  
Connecting the projector to a computer 27  
Connecting up the mouse (wireless  
mouse function) 35  
Connecting video equipment 37  
Connections of two computers 31  
Contrast 68  
cool-down 45, 84  
Cursor 59  
Cursor Speed 70  
Cursor/Stamp 69

## D

D port 39  
DFP 32  
digital tuner's 39  
DVI-D 32

## E

EasyMP.net Board 14  
EasyMP.net Software 77  
Effect button 18, 69, 70  
Effect Function 59  
Effect menu 65  
Eligible computers 27  
EMP Link V 77  
EMP Link V Installation 79  
Ending 45

Ending images 58  
Enlarging images (zoom function) 58  
Enter button 15, 19  
ESC button 15, 19  
Execute 72  
E-Zoom button 18  
E-zooming function 58

## **F**

Fan 14  
Feet adjustments 47  
Focus 50  
Focus Ring 13, 50  
Foot Adjust Lever 13, 47  
Freeze button 18  
Freeze Function 55  
frequency 27  
Front Foot 13, 14, 46, 47  
Functions 52

## **G**

Gamma 68

## **H**

half-transparent 24  
Handle 13  
Help button 15  
Help Function 53

## **I**

I/O Terminal 14  
Image menu 64  
image signals 38  
Indicator 18  
Information menu 65  
Installation Procedure 23  
Introduction of EasyMP.net Software 77

## **K**

Keystone 70  
Keystone button 15

## **L**

Lamp Indicator 13, 85  
Language 71  
L-Audio-R Port 16  
L-Audio-R ports 37  
Left click 36  
Lens Cover 13, 41  
lens cover 46  
Lens Shift Knob 13  
Light button 18

## **M**

Maximum Sound Output 103  
Menu button 15, 66  
Menu Configuration 64  
Menu Operations 66  
mini D-Sub 15 pin 29  
Monitor Out Port 16  
Mouse/Com Port 16, 35

## **N**

Network connector 17  
No Signal Msg 70

## **O**

Operable distance 21  
Operable range 21  
Operation Indicator 13, 42, 84  
Operation Panel 13, 15  
Optional Parts 100  
overheating 86

## **P**

P in P button 19, 70  
Parts, Names and Operations 13  
PCMCIA card slot 17  
permissible temperature range 12  
Picture in Picture Function 62  
Picture Quality Adjustment 50  
Position 68  
Power button 15, 18, 42  
Power Cord 41  
Power Inlet 14, 41

- Preset 68
- Preset button 20, 51
- Projection 41
- Projection angles 26
- Projection cutting 55
- projection distance 24
- Prompt 70

## **R**

- R/C ON OFF switch 18, 42, 46
- Rear Foot 14
- Rear Proj. 72
- Remote Control 18, 21
- Remote control light-receiving area 18
- Remote Control Receiver 13, 14
- Remote Port 16
- Replacing the Air Filter 96
- Replacing the lamp 97
- Reset 69, 70, 71, 72
- Reset All 72
- Resize button 15, 20
- Resolution 68
- resolution 27
- RGB image signals 40
- Right click 36

## **S**

- S image signals 37
- Safety Precautions 8
- S-Audio/Audio #2 Port 37
- Screen size 24
- Setting 70, 71
- Setup menu 65
- setup menu 64
- Sharpness 68
- Shift button 15
- Sleep Mode 71, 87
- Smooth Motion 69
- Sound connection 33
- Sound menu 65
- Speaker 13
- Specifications 103
- Spotlight 60, 69
- SRS CENTER 69
- SRS SPACE 69
- Stack Out Port 16

- Stamp 59
- Startup Screen 71
- sub menus 64
- sub-screen 62
- S-Video Port 16, 37
- S-Video/Audio #2 Port 16
- Symbol displays 7
- Sync button 15
- Sync. 68
- Synchronization 51

## **T**

- Temperature Indicator 13, 86
- temperature range 12
- Temperature range during storage 103
- Temperature range during use 103
- Terminology 101
- Theft-Protection Lock 13
- Tint 68
- top menus 64
- Tracking 51, 68
- Tracking button 15
- Trapezoid adjustment 49
- Treble 69
- Troubleshooting 84

## **U**

- USB port 17
- user logo 55
- User's Logo Capture 71
- Using this manual 7

## **V**

- Video 44, 68, 69
- Video button 15, 19
- Video Port 16, 37
- Video Signal 69
- Volume 63, 69
- Volume Adjustment 63
- Volume button 19

## **W**

- window display 56
- Window resizing 56

World-Wide Warranty Terms 107

## **Z**

Zoom 48

Zoom Ring 13

# DECLARATION of CONFORMITY

according to ISO/IEC Guide 22 and EN 45014

Manufacturer : SEIKO EPSON CORPORATION  
Address : 3-5, Owa 3-chome, Suwa-shi,  
Nagano-ken 392-8502 Japan  
Representative : EPSON EUROPE B. V.  
Address : Entrada 701, 1096 EJ AMSTERDAM,  
The Netherlands

Declares that the Product

Kind of Equipment : LCD Projector

Model : ELP-8150/8150NL/  
EMP-8150/8150NL

Conforms to the following Directives and Norm(s)

## **Directive 89/336/EEC**

: EN 55022

: EN 55024

: EN61000-3-2

: EN61000-3-3

## **Directive 73/23/EEC**

: EN 60950

# DECLARATION of CONFORMITY

According to 47CFR, Part 2 and 15 for

**Class B Personal Computers and Peripherals; and/or  
CPU Boards and Power Supplies used with Class B  
Personal Computers**

We : EPSON AMERICA, INC.

Located at : MS: 3-13

3840 Kilroy Airport Way

Long Beach, CA 90806-2469

Telephone: (562) 290- 5254

Declare under sole responsibility that the product identified herein, complies with 47CFR Part 2 and 15 of the FCC rules as a Class B digital device. Each product marketed, is identical to the representative unit tested and found to be compliant with the standards. Records maintained continue to reflect the equipment being produced can be expected to be within the variation accepted, due to quantity production and testing on a statistical basis as required by 47CFR 2.909. Operation is subject to the following two conditions : (1) this device may not cause harmful interference, and (2) this device must accept any interference received, including interference that may cause undesired operation.

**Trade Name : EPSON**

**Type of Product : LCD Projector**

**Model : EMP-8150/8150NL/**

**ELP-8150/8150NL**

## **FCC Compliance Statement For United States Users**

This equipment has been tested and found to comply with the limits for a Class B digital device, pursuant to Part 15 of the FCC Rules. These limits are designed to provide reasonable protection against harmful interference in a residential installation. This equipment generates, uses, and can radiate radio frequency energy and, if not installed and used in accordance with the instructions, may cause harmful interference to radio or television reception. However, there is no guarantee that interference will not occur in a particular installation. If this equipment does cause interference to radio and television reception, which can be determined by turning the equipment off and on, the user is encouraged to try to correct the interference by one or more of the following measures.

- Reorient or relocate the receiving antenna.
- Increase the separation between the equipment and receiver.
- Connect the equipment into an outlet on a circuit different from that to which the receiver is connected.
- Consult the dealer or an experienced radio/TV technician for help.

### **WARNING**

The connection of a non-shielded equipment interface cable to this equipment will invalidate the FCC Certification or Declaration of this device and may cause interference levels which exceed the limits established by the FCC for this equipment. It is the responsibility of the user to obtain and use a shielded equipment interface cable with this device. If this equipment has more than one interface connector, do not leave cables connected to unused interfaces. Changes or modifications not expressly approved by the manufacturer could void the user's authority to operate the equipment.

### **For Canadian Users**

This digital apparatus does not exceed the Class B limits for radio noise emissions from digital apparatus as set out in the radio interference regulations of the Canadian Department of Communications.

Le présent appareil numérique n'émet pas de bruits radioélectriques dépassant les limites applicables aux appareils numériques de Classe B prescrites dans le règlement sur le brouillage radioélectrique édicté par le Ministère des Communications du Canada.

All rights reserved. No part of this publication may be reproduced, stored in a retrieval system, or transmitted in any form or by any means, electronic, mechanical, photocopying, recording, or otherwise, without the prior written permission of SEIKO EPSON CORPORATION. No patent liability is assumed with respect to the use of the information contained herein. Neither is any liability assumed for damages resulting from the use of the information contained herein.

Neither SEIKO EPSON CORPORATION nor its affiliates shall be liable to the purchaser of this product or third parties for damages, losses, costs, or expenses incurred by purchaser or third parties as a result of: accident, misuse, or abuse of this product or unauthorized modifications, repairs, or alterations to this product, or (excluding the U.S.) failure to strictly comply with SEIKO EPSON CORPORATION's operating and maintenance instructions.

SEIKO EPSON CORPORATION shall not be liable against any damages or problems arising from the use of any options or any consumable products other than those designated as Original EPSON Products or EPSON Approved Products by SEIKO EPSON CORPORATION.

EPSON is a registered trademark and PowerLite is a trademark of SEIKO EPSON CORPORATION.

**General Notice:** The following trademarks and registered trademarks are the property of their respective owners and are used in this publication for identification purposes only.

- EPSON/Seiko Epson Corp.
- Macintosh, PowerBook/Apple Computer Corp.
- IBM/International Business Machines, Inc.
- Windows/Microsoft Corp.

Other product names used herein are also for identification purposes only and may be trademarks of their respective owners. EPSON disclaims any and all rights in those marks.



**EPSON®**