

DATA PROJECTOR

MODEL

XD210U/SD210U

User Manual

XD210U
SD210U

This User Manual is important to you.
Please read it before using your projector.

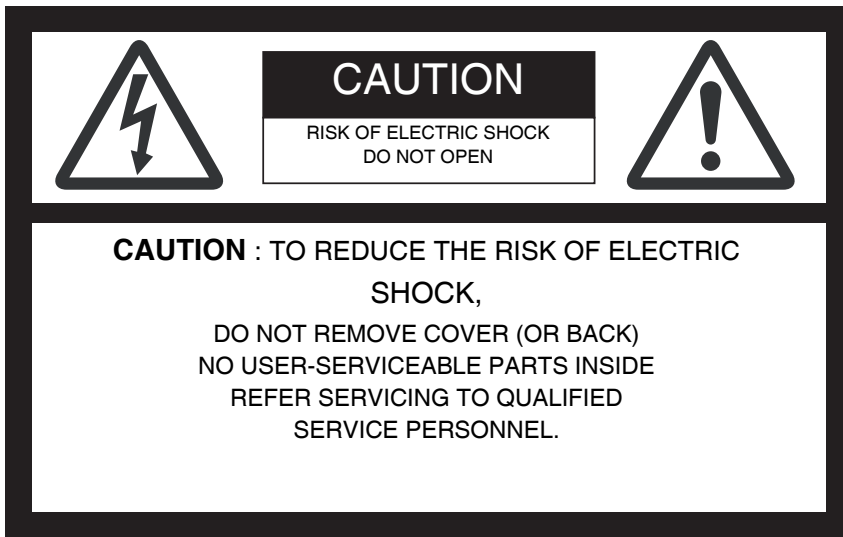

The lightning flash with arrowhead symbol within an equilateral triangle is intended to alert the user to the presence of uninsulated "dangerous voltage" within the product's enclosure that may be of sufficient magnitude to constitute a risk of electric shock.

The exclamation point within an equilateral triangle is intended to alert the user to the presence of important operating and maintenance (servicing) instructions in the literature accompanying the appliance.

WARNING:

TO PREVENT FIRE OR SHOCK HAZARD, DO NOT EXPOSE THIS APPLIANCE TO RAIN OR MOISTURE.

CAUTION:

TO PREVENT ELECTRIC SHOCK, DO NOT USE THIS (POLARIZED) PLUG WITH AN EXTENSION CORD, RECEPTACLE OR OTHER OUTLET UNLESS THE BLADES CAN BE FULLY INSERTED TO PREVENT BLADE EXPOSURE.

NOTE:

SINCE THIS PROJECTOR IS PLUGGABLE EQUIPMENT, THE SOCKET-OUTLET SHALL BE INSTALLED NEAR THE EQUIPMENT AND SHALL BE EASILY ACCESSIBLE.

WARNING

Use the attached specified power supply cord. If you use another power supply cord, it may cause interference with radio and television reception.

Use the attached RGB cable with this equipment so as to keep interference within the limit of an FCC Class B device.

This apparatus must be grounded.

DO NOT LOOK DIRECTLY INTO THE LENS WHEN THE PROJECTOR IS IN THE POWER ON MODE.

CAUTION

Not for use in a computer room as defined in the Standard for the Protection of Electronic Computer/Data Processing Equipment, ANSI/NFPA 75.

The attached power cord is to be used exclusively for this product. Never use it for other products.

When using the projector in Europe:

COMPLIANCE NOTICE

This Projector complies with the requirements of the EC Directive 2004/108/EC "EMC Directive" and 2006/95/EC "Low Voltage Directive".

The electro-magnetic susceptibility has been chosen at a level that gains proper operation in residential areas, on business and light industrial premises and on small-scale enterprises, inside as well as outside of the buildings. All places of operation are characterized by their connection to the public low voltage power supply system.

WARNING

Use the attached RGB cable with this equipment so as to keep interference within the limits of an EN55022 Class B device.

Please follow WARNING instructions.



Note: This symbol mark is for EU countries only. This symbol mark is according to the directive 2002/96/EC Article 10 Information for users and Annex IV.

Your MITSUBISHI ELECTRIC product is designed and manufactured with high quality materials and components which can be recycled and reused.

This symbol means that electrical and electronic equipment, at their end-of-life, should be disposed of separately from your household waste.

Please, dispose of this equipment at your local community waste collection/recycling centre.

In the European Union there are separate collection systems for used electrical and electronic product.

Please, help us to conserve the environment we live in!

Contents

Important safeguards.....	4
Overview.....	6
Remote control	8
Installation	9
Basic connections.....	10
Preparation	12
Basic operation.....	13
Menu operation.....	15
Image adjustment	19
Lamp replacement.....	20
Troubleshooting.....	21
Indicators	24
Specifications	25

Declaration of Conformity

Model Number : XD210U/SD210U
Trade Name : MITSUBISHI ELECTRIC
Responsible party : Mitsubishi Digital Electronics America, Inc.
9351 Jeronimo Road, Irvine, CA 92618 U.S.A
Telephone number : +1-(949) 465-6000

This device complies with Part 15 of the FCC Rules. Operation is subject to the following two conditions:

- (1) this device may not cause harmful interference, and
- (2) this device must accept any interference received, including interference that may cause undesired operation.

Trademark, Registered trademark

Macintosh is registered trademark of Apple Computer Inc.

DLP™, Digital Micromirror Device, DMD, and BrilliantColor™ are all trademarks of Texas Instruments.

Microsoft or Windows are either registered trademarks or trademarks of Microsoft Corporation in the United States and/or other countries.

Other brand or product names are trademarks or registered trademarks of their respective holders.

Important safeguards

Please read all these instructions regarding your projector and retain them for future reference. Follow all warnings and instructions marked on the projector.

1. **Read instructions**
All the safety and operating instructions should be read before the appliance is operated.
2. **Retain instructions**
The safety and operating instructions should be retained for future reference.
3. **Warnings**
All warnings on the appliance and in the operating instructions should be adhered to.
4. **Instructions**
All operating instructions must be followed.
5. **Cleaning**
Unplug this projector from the wall outlet before cleaning it. Do not use liquid aerosol cleaners. Use a damp soft cloth for cleaning.
6. **Attachments and equipment**
Never add any attachments and/or equipment without the approval of the manufacturer as such additions may result in the risk of fire, electric shock or other personal injury.
7. **Water and moisture**
Do not use this projector near water or in contact with water.
8. **Accessories**
Do not place this projector on an unstable cart, stand, tripod, bracket or table. Use only with a cart, stand, tripod bracket, or table recommended by the manufacturer or sold with the projector. Any mounting of the appliance should follow the manufacturer's instructions and should use a mounting accessory recommended by the manufacturer.



An appliance and cart combination should be moved with care. Quick stops, excessive force and uneven surfaces may cause the appliance and cart combination to overturn.

9. **Ventilation**
Slots and openings in the cabinet are provided for ventilation, ensuring reliable operation of the projector and to protect it from overheating. Do not block these openings or allow them to be blocked by placing the projector on a bed, sofa, rug, or bookcase. Ensure that there is adequate ventilation and that the manufacturer's instructions have been adhered to.
10. **Power sources**
This projector should be operated only from the type of power source indicated on the marking label. If you are not sure of the type of power, please consult your appliance dealer or local power company.
11. **Power-cord protection**
Power-supply cords should be routed so that they are not likely to be walked on or pinched by items placed upon or against them. Pay particular attention to cords at plugs, convenience receptacles, and points where they exit from the appliance. Do not put the power cord under a carpet.

12. **Overloading**
Do not overload wall outlets and extension cords as this can result in a fire or electric shock.
13. **Objects and liquids**
Never push objects of any kind through openings of this projector as they may touch dangerous voltage points or short-out parts that could result in a fire or electric shock. Never spill liquid of any kind on the projector.
14. **Servicing**
Do not attempt to service this projector yourself. Refer all servicing to qualified service personnel.
15. **Damage requiring service**
Unplug this projector from the wall outlet and refer servicing to qualified service personnel under the following conditions:
 - (a) If the power-supply cord or plug is damaged.
 - (b) If liquid has been spilled, or objects have fallen into the projector.
 - (c) If the projector does not operate normally after you follow the operating instructions. Adjust only those controls that are covered by the operating instructions. An improper adjustment of other controls may result in damage and may often require extensive work by a qualified technician to restore the projector to its normal operation.
 - (d) If the projector has been exposed to rain or water.
 - (e) If the projector has been dropped or the cabinet has been damaged.
 - (f) If the projector exhibits a distinct change in performance - this indicates a need for service.
16. **Replacement parts**
When replacement parts are required, be sure that the service technician has used replacement parts specified by the manufacturer or parts having the same characteristics as the original part. Unauthorized substitutions may result in fire, electric shock or other hazards.
17. **Safety check**
Upon completion of any service or repair to this projector, ask the service technician to perform safety checks determining that the projector is in a safe operating condition.

WARNING:**Unplug immediately if there is something wrong with your projector.**

Do not operate if smoke, strange noise or odor comes out of your projector. It may cause fire or electric shock. In this case, unplug immediately and contact your dealer.

Never remove the cabinet.

This projector contains high voltage circuitry. An inadvertent contact may result in an electric shock. Except as specifically explained in User Manual, do not attempt to service this product by yourself. Please contact your dealer when you want to fix, adjust, or inspect the projector.

Do not modify the projector.

It can lead to fire or electric shock.

Do not keep using the damaged projector.

If the projector is dropped and the cabinet is damaged, unplug the projector and contact your dealer for inspection. It may lead to fire if you keep using the damaged projector.

Do not face the projection lens to the sun.

It can lead to fire.

Use correct voltage.

If you use incorrect voltage, it can lead to fire.

Do not place the projector on uneven surface.

Place the projector on a level and stable surface only.

Do not look into the lens when the projector is operating.

It may hurt your eyes. Never let children look into the lens when the projector is on.

Do not unplug the power cord during operation.

It can lead to lamp breakage, fire, electric shock or other trouble. Wait for the fan to stop before unplugging the power cord.

Do not touch the air outlet grilles and bottom plate.

Do not touch them or put other equipment close to the air outlet grilles because they become hot during operation. The heated air outlet grilles and bottom plate may cause injury or damage to other equipment. Also, do not put the projector on a desk that is easily affected by heat.

Do not look into the air outlet grilles when projector is operating.

Heat, dust, etc. may blow out of them and hurt your eyes.

Do not block the air inlet and outlet grilles.

If they are blocked, heat may be generated inside the projector, causing deterioration in the projector quality and fire.

Do not use flammable solvents (benzene, thinner, etc.) and flammable aerosols near the projector.

Flammable substances may ignite causing fire or breakdown because the temperature inside the projector rises very high while the lamp is illuminating.

Do not use the projector with condensation on it.

It can lead to breakdown or other failure.

Place of installation

For safety's sake, do not use the projector at any place subjected to high temperature and high humidity. Please maintain an operating temperature, humidity, and altitude as specified below.

- Operating temperature: between +41°F (+5°C) and +95°F (+35°C)
- Operating humidity: between 30% and 90%
- Never put any heat-producing device under the projector to prevent the projector from being overheated.
- Do not install the projector at a place that is unstable or subject to vibration.
- Do not install the projector near any equipment that produces a strong magnetic field. Also refrain from installing the projector near any cable carrying a large amount of current.
- Place the projector on a solid, vibration-free surface. Otherwise it may fall, causing serious injury or damage.
- Do not stand the projector on its end. It may fall, causing serious injury or damage.
- Slanting the projector more than $\pm 10^\circ$ (right and left) or $\pm 15^\circ$ (front and rear) may cause trouble or explosion of the lamp.
- Do not place the projector near air-conditioning unit, heater, or humidifier to avoid hot or moist air to the exhaust and ventilation hole of the projector.

COMPLIANCE NOTICE OF FCC

This equipment has been tested and found to comply with the limits for a Class B digital device, pursuant to Part 15 of the FCC Rules. These limits are designed to provide reasonable protection against harmful interference in a residential installation. This equipment generates, uses and can radiate radio frequency energy and, if not installed and used in accordance with the instructions, may cause harmful interference to radio communications. However, there is no guarantee that interference will not occur in a particular installation. If this equipment does cause harmful interference to radio or television reception, which can be determined by turning the equipment off and on, the user is encouraged to try to correct the interference by one or more of the following measures:

- Reorient or relocate the receiving antenna.
- Increase the separation between the equipment and receiver.
- Connect the equipment into an outlet on a circuit different from that to which the receiver is connected.
- Consult the dealer or an experienced Radio / TV technician for help.

Changes or modifications not expressly approved by Mitsubishi could void the user's authority to operate this equipment.

COMPLIANCE NOTICE OF INDUSTRY CANADA

This Class B digital apparatus complies with Canadian ICES-003.

Overview

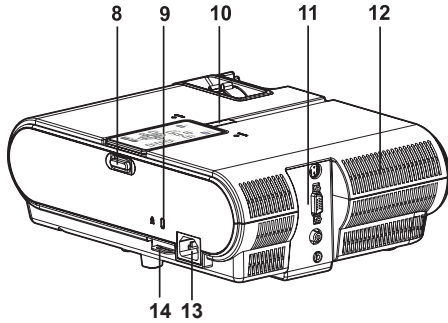
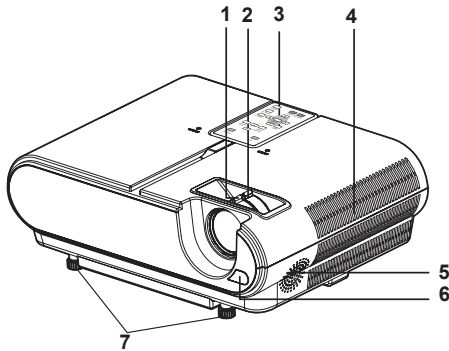

- 1 FOCUS ring
- 2 ZOOM ring
- 3 Remote control
- 4 Air inlet grille
- 5 Speaker
- 6 Remote control sensor (Front)
- 7 Adjustment feet (front)
- 8 Remote control lock button
- 9 Kensington Lock
- 10 Remote control sensor (Top)
- 11 Terminal board
- 12 Air outlet grille
- 13 Power jack
- 14 Security lock

Caution:

Do not replace the lamp immediately after using the projector because the lamp would be extremely hot and it may cause burns.

Kensington Lock

This projector has a Kensington Security Standard connector for use with Kensington MicroSaver Security System.

Refer to the information that came with the Kensington System for instructions on how to use it to secure the projector. Please contact Kensington Technology Group below.

Kensington Technology Group

2855 Campus Drive

San Mateo, CA 94403, U.S.A.

Phone: +1- (650)572-2700 Fax: +1- (650)572-9675

Indicator

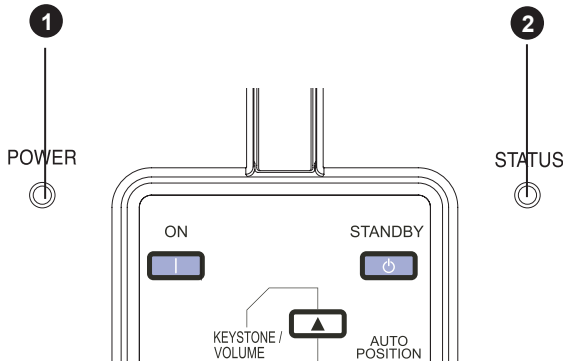

- 1 POWER indicator
- 2 STATUS indicator

Terminal board

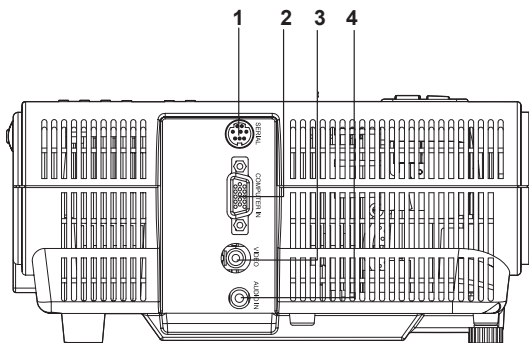

- 1 SERIAL (RS-232C) terminal
- 2 COMPUTER IN terminal (Mini D-SUB 15-pin)
- 3 VIDEO IN terminal
- 4 AUDIO IN terminal (Mini jack)

Bottom side

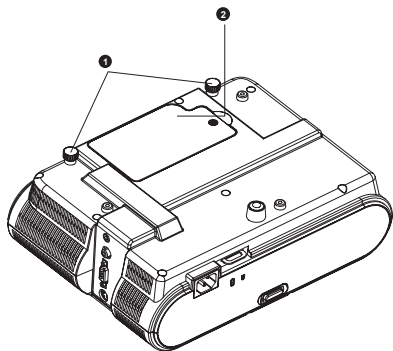

- 1 Adjustment feet
- 2 Lamp cover

Remote control

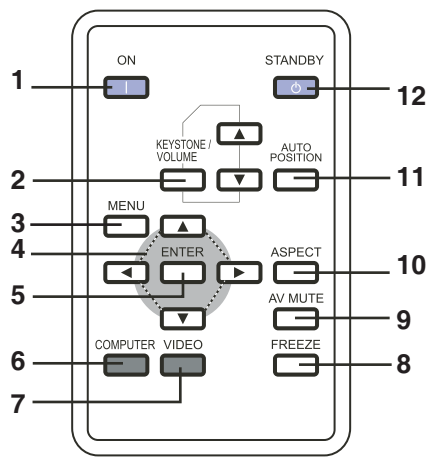

- 1 ON button
- 2 KEYSTONE/VOLUME UP, DOWN buttons
- 3 MENU button
- 4 Direction buttons
- 5 ENTER button
- 6 COMPUTER button
- 7 VIDEO button
- 8 FREEZE button
- 9 AV (Audio/Video) MUTE button
- 10 ASPECT button
- 11 AUTO POSITION button
- 12 STANDBY button

- The UP and DOWN buttons are used in the KEYSTONE adjustment in addition to the volume control.

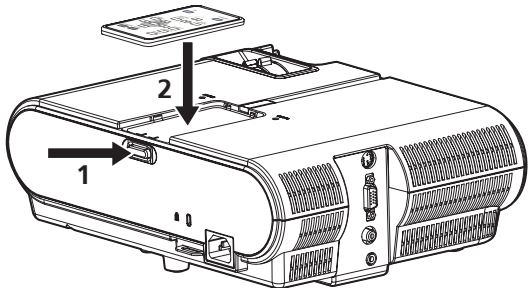

Important:

- This projector is equipped with two remote controls. One is installed on the top of the set; the other is come with the package.
- To release it from the set, press the remote control lock button, and the remote control will eject automatically. See step 1 of the illustration.
- To fix the remote control to the set, place the remote control into the remote control slot. See step 2 of the illustration.
- Be sure to remove the transparent insulation tape by pulling it before use. For further details, please refer to the section "Remote control".
- If you don't want to remove the remote control from the set, or prevent it from dropping accidentally, you can use Cap RC lock button that came with the package to lock the remote control lock button.
- Be sure to follow the illustration to use Cap RC lock button to prevent dropping.
- After installation, please follow the illustration to press the Cap RC lock button to hook the slot of RC lock button.

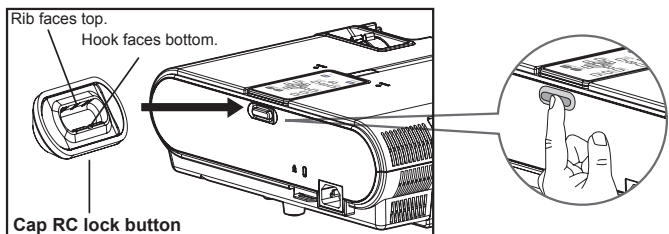

Remote control

This projector is equipped with two remote controls. One is installed on the top of the set; the other is come with the package.

For the first time use:

1. To release it from the set, press the remote control lock button, and the remote control will eject automatically.
2. Remove the transparent insulation tape by pulling it before use.

For battery change:

1. Remove the battery holder.
2. Remove the old Lithium coin cell and install new one (CR2025). Ensure that the side with the mark "+" is up.
3. Push the battery holder back into the remote control until you feel a click.

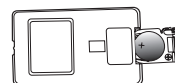
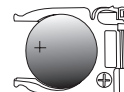
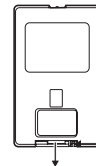
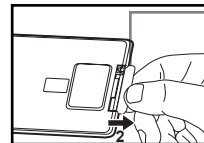

Caution:

- Risk of explosion if battery is replaced by an incorrect type.
- Dispose of used batteries according to the instructions.

Important:

- Replace battery with Matsushita Battery, Type CR2025 only.
- Battery may explode if mistreated. Do not recharge, disassemble or dispose of in fire.
- Keep battery in original package until ready to use. Discard used battery promptly. Keep out reach of children.
- Never put battery in mouth for any reason as it can easily be accidentally swallowed. If battery is accidentally swallowed, contact your physician or your poison control center.
- Keep the battery out of the reach of children. There is a danger of death by accidentally swallowing the battery.
- Do not recharge the used battery or expose the battery to fire or water.
- Do not dispose of the used battery along with household waste. Dispose of used batteries according to local regulations.
- Danger of explosion may happen if batteries are incorrectly replaced. Replace only with the same type recommended by the manufacturer.
- The battery used for the slim remote control is a button type. The battery power of this type will be exhausted faster than that of AA or AAA size batteries used for other types of remote controls. There are two remote controls included in the package. When the first battery is exhausted, replace with the other one as soon as possible.

Operation range (of the remote control)

The maximum operation distance of the remote control is about 7 m (or about 22 feet) when the remote control is pointed at the remote control sensor of the projector. When the remote control is pointed to the screen, the distance from the remote control to the projector via the screen should be 5 m or less. However, the operation distance varies depending on the type of the screen used and the lighting condition where the projector is used.

Reception angle (vertical)

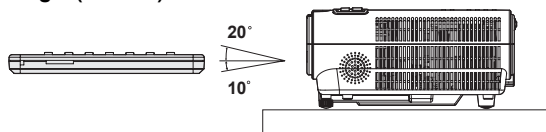

Reception angle (horizontal)

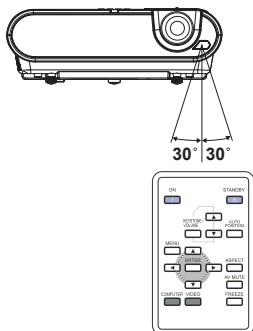

Reception angle (vertical), ceiling mount

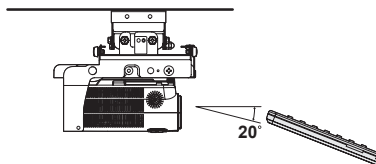

Important:

- Do not expose the remote control sensor to direct sunlight or fluorescent. Keep a distance at least 2 m (6.5 feet) between the remote control sensor and the fluorescent light to ensure correct operation of the remote control. Inverted fluorescent light, if located near the projector, may interfere the remote control.
- When you use the remote control too close to the remote control sensor, the remote control may not work correctly.
- When you operate the remote control from the rear side of the projector, the infrared will reflect from the screen, and the operating distance will become shorter. In this case, please remove the remote control on the top of the projector to improve the operating distance.

Installation

Layout of the projector

Image size varies depending on the distance between the screen and the projector.

Front projection

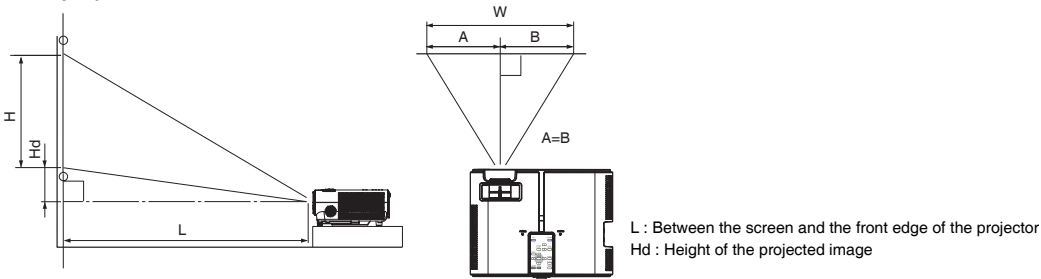

Screen				Distance from the screen : L						Hd	
Diagonal size		Width : W		Height : H		Shortest (WIDE)		Longest (TELE)			
inch	cm	inch	cm	inch	cm	inch	m	inch	m	inch	cm
40	102	32	81	24	61	61	1.5	68	1.7	1.8	5
60	152	48	122	36	91	92	2.3	103	2.6	2.7	7
80	203	64	163	48	122	124	3.1	138	3.5	3.6	9
100	254	80	203	60	152	155	3.9	173	4.4	4.5	11
150	381	120	305	90	229	233	5.9	260	6.6	6.8	17
200	508	160	406	120	305	311	7.9	347	8.8	9.0	23
250	635	200	508	150	381	389	9.9	434	11.0	11.3	29
300	762	240	610	180	457	468	11.9	-	-	13.5	34

The above figures are approximate and may be slightly different from the actual measurements.

Front projection, ceiling mounting

For ceiling mounting, you need the ceiling mount kit designed for this projector. Ask a specialist for installation.

For details, consult your dealer.

- The warranty on this projector does not cover any damage caused by use of any non-recommended ceiling mount kit or installation of the ceiling mount kit in an improper location.

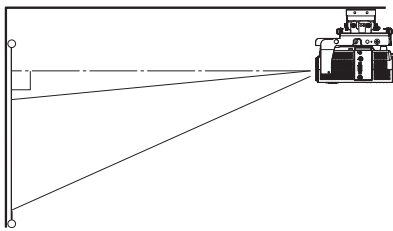

- When using the projector mounted on the ceiling, set Mounting in the Setting menu to [Ceiling]. See page 15.
- When the projector is mounted on the ceiling, images may appear darker than those projected in the case of tabletop mounting. This isn't a product malfunction.
- When the projector is mounted on the ceiling, the remote control is liable to drop down. Please remove the remote control before using it.

Rear projection

Ask a specialist for installation. For details, consult your dealer.

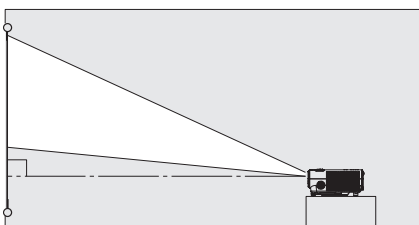

- For rear projection, set Mounting in the Setting menu to [Rear]. (See page 15.)

Caution:

- Placing the projector directly on a carpet impairs ventilation by the fans, causing damage or failure. Put a hard board under the projector to facilitate ventilation.
- Place the projector at least 50 cm (or 20 inch) away from the wall to prevent the air inlet grille and the air outlet grilles that emit hot air from being blocked.
- Do not use the projector in the following locations and manners, which may cause fire or electric shock.
 - In a dusty or humid place.
 - In a sideways or upside-down position.
 - Near a heater.
 - In an oily, smoky, or damp place such as a kitchen.
 - In direct sunlight.
 - Where the temperature rises high, such as in a closed car.
 - Where the temperature is lower than +41°F (or +5°C) or higher than +95°F (or +35°C).

Important:

- Do not apply force to the lens, because the lens may be damaged.
- We don't recommend using the projector at an altitude of 1500 meters or higher. Use at an altitude of 1500 meters or higher may affect the projector's life.

Basic connections

This projector can be connected with various devices such as a VCR, video camera, videodisc player, and personal computer that have analog RGB output connectors.

Important:

- Make sure that the connected device is turned off before starting connection.
- Plug in the power cords of the projector and the connected devices firmly. When unplugging, hold and pull the plug. Do not pull the cord.
- When the projector and the connected devices are located too close to each other, the projected image may be affected by their interference.
- See the owner's guide of each device for details about its connections.

Projector + AV device

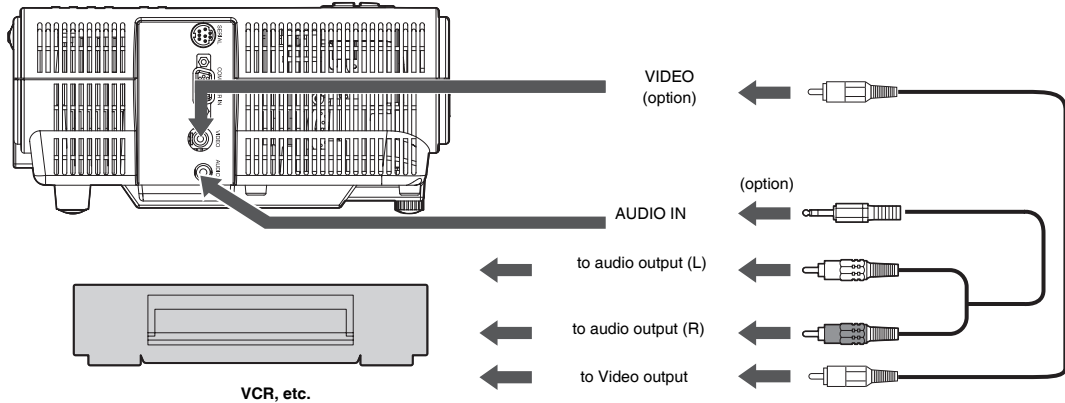

Important:

- Match the colors of the video and audio plugs on the Audio cable with those of the terminals.
- Speaker output is mono.

Projector + DVD player or HDTV decoder

Some DVD players have an output connector for 3-line fitting (Y, CB, CR). When connecting such DVD player with this projector, use the COMPUTER-IN terminal.

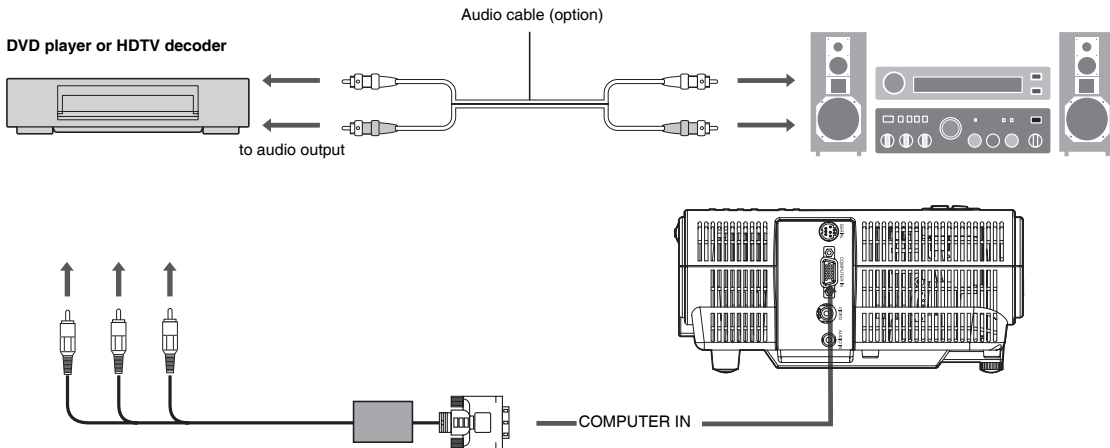

Important:

- The terminal's names Y, PB, and PR are given as examples of when a HDTV decoder is connected.
- The terminal's names vary depending on the connected devices.
- Image may not be projected correctly with some DVD players.
- When connecting a HDTV decoder having RGB output terminals, set Signal Type to RGB in the Setting menu.
- Speaker output is mono.

Projector + Computer

For computer with Mini D-SUB

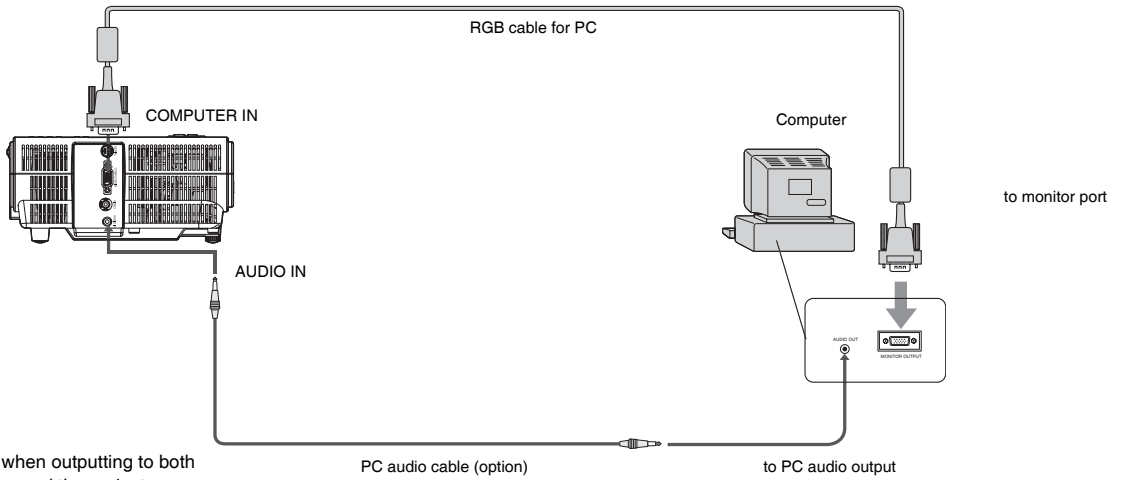

For analog connection:

1. Connect one end of the supplied RGB cable to the COMPUTER IN terminal of the projector.
2. Connect the other end of the RGB cable to the monitor port of the computer.

Important:

- When you use a longer RGB cable instead of the provided cable, the image may not be projected correctly.
- Some computers require additional connectors or analog RGB output adapters to be connected with this projector. Contact your dealer for further information.
- This projector uses stereo pin jack for its audio input. Check the type of the audio output terminal of the connected computer and prepare a proper cable for connection. Some computers don't have the audio output terminal.
- Speaker output is mono.

For Macintosh

- Some Macintoshes require a MAC adapter for the RGB cable for connection with this projector. Contact your dealer for further information.

Preparation

Preparation for projection

1. Attach the provided power cord to the projector.
2. Plug the power cord in the wall outlet.
3. Remove the lens cap.

Warning:

- Do not look into the lens directly when the projector is on.
- The lens cap is for protecting the lens. If you leave the lens cap on the lens with the projector turned on, it may be deformed because of heat build-up. Remove the lens cap when you turn on the projector.
- One of power cords for the U.S., Europe and U.K. is provided appropriately.
- This projector uses the power plug of three-pin grounding type. Do not remove the grounding pin from the power plug. If the power plug doesn't fit your wall outlet, ask an electrician to change the wall outlet.
- In case that the power cord for the U.S is provided with this projector, never connect this cord to any outlet or power supply using other voltages or frequencies than rated. If you want to use a power supply using other voltage than rated, prepare an appropriate power cord separately.
- Use 100-240 V AC 50/60 Hz to prevent fire or electric shock.
- Do not place any objects on the power cord or do not place the projector near heat sources to prevent damage to the power cord. If the power cord should be damaged, contact your dealer for replacement because it may cause fire or electric shock.
- Do not modify or alter the power cord. If the power cord is modified or altered, it may cause fire or electric shock.

Caution:

- Plug in the power cord firmly. When unplugging, hold and pull the power plug, not the power cord.
- Do not plug in or out the power cord with your hand wet. It may cause electric shock.

Adjustment of the projection angle

For the best projection, project images on a flat screen installed at 90 degrees to the floor. If necessary, tilt the projector using the two adjustment feet on the bottom of the projector.

Using the adjustment feet (front)

1. Tilt up the projector to the appropriate angle.
2. Rotate the adjustment feet (front) for fine adjustment.

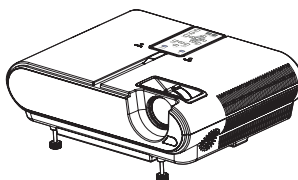

Important:

- Install the screen on a flat wall at 90 degrees to the floor.
- Slanting the projector more than $\pm 10^\circ$ (right and left) or $\pm 15^\circ$ (front and rear) may cause trouble or explosion of the lamp. You can tilt the projector up to 8 degrees using the adjustment feet only.
- Images may not be projected in a shape of a regular rectangle or with its aspect ratio 4:3, depending on the installation conditions of the projector and the screen.
- To correct vertical keystone distortion, press the **KEystone / VOLUME** button on the remote control, and adjust the image by pressing the **▲**, **▼** button.

In the following cases:



Press the ▼ button.

Press the ▲ button.

Important:

- When the keystone adjustment is carried out, the adjustment value is indicated. Note that this value doesn't mean a projection angle.
- The allowable range of the adjustment value in the keystone adjustment varies depending on the installation conditions.
- When the keystone adjustment takes effect, the resolution decreases. In addition, stripes may appear or straight lines may bend in images with complicated patterns. They are not due to product malfunctions.
- Noise may appear on the screen during the keystone adjustment because of the type of the video signal being projected and the setting values of the keystone adjustment. In such cases, set the keystone adjustment values in the range where the image is displayed without noise.
- When the keystone adjustment is carried out, the image may not be displayed correctly because of the type of input signal.

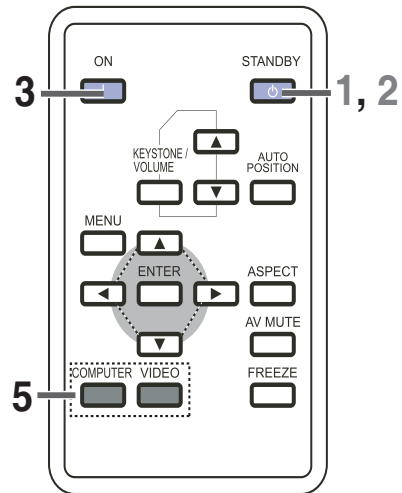
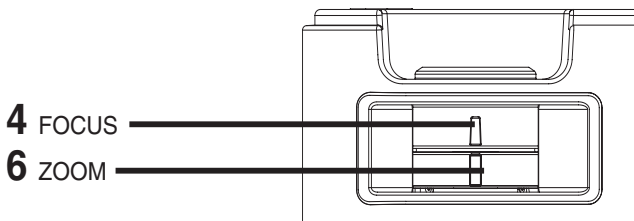

Power-on

1. Turn on the device connected to the projector first.
2. Plug the power cord in the wall outlet.
 - The POWER indicator lights up.
 - If the power cord is unplugged from the wall outlet before the projector is cooled down completely after use, it can happen that the lamp does not turn on in next time because of the high temperature of lamp. In this case, wait a few minutes and try to light the lamp again.
3. Press the ON button on the remote control.
 - It may take about one minute for the lamp to light up.
 - The lamp occasionally fails to light up. Wait a few minutes and try to light the lamp again.
 - After the ON button is pressed, the image may flicker before the lamp becomes stable. This is not a product malfunction.
 - Regardless of the setting of Lamp Mode in the Setting menu, the Standard lamp mode is activated by default. The Lamp Mode is set to either Standard or Low depending on the setting last selected, and you cannot switch the Lamp Mode in about one minute after the lamp is on.

- The input source is switched from VIDEO to COMPUTER at the press of the COMPUTER button by remote control on the top.
 - The projector automatically selects the appropriate signal format. The selected signal format is displayed on the screen.
 - To avoid permanently imprinting a fixed image onto your projector, please do not display the same stationary images for long period.
6. Adjust the image size by turning the zoom ring.
 - If necessary, adjust the focus and zoom again.

When fine streaks are seen on projected images

This is due to interference with the screen surface and is not a malfunction. Replace the screen or displace the focus a little.

Condition	Indicator	STATUS	POWER
Stand-by	-	-	Blinking green
When the lamp is on.	Steady green	Steady green	Steady green

Important:

- Do not cover the lens with the lens cap while the lamp is on.
 - The projector starts warming up when the POWER button is pressed. During the warm-up process, images may appear dark and no commands are accepted.
 - When POWER indicator lights amber and the STATUS indicator lights green, the lamp should be replaced soon.(See page 21 and 24.)
 - Images may not be projected with good quality in an extremely hot or cold environment. (This is not a product malfunction.)
 - If the lamp exceptionally turned off due to the power interruption or voltage drop, it can happen that the lamp does not turn on even if you switch again the power supply on. In that case, please pull the electric cord out of the consent and put it again in the consent about 10 minutes later.
4. Adjust the focus by turning the focus ring.
 5. Choose your desired external input source using the COMPUTER or VIDEO button.

Basic operation (continued)

Power-off

Use the following procedure to turn off the projector.

The lamp may deteriorate if the projector is powered off and on repeatedly within 30 minutes after the lamp is lighted.

1. Press the STANDBY button on the remote control.
 - The message "Power Off? Press again" appears on the screen.
 - To cancel, press any button except the POWER button. (Some buttons on the remote control don't function for cancel.)
2. Press the STANDBY button on the remote control within 10 seconds again.
 - The projector is shutting and the fan motor is cooling the lamp for shutdown. In this case, POWER and STATUS indicator light amber.
 - The projector is in stand-by mode. The POWER indicator blinks green and the STATUS indicator turns off.
3. Unplug the power cord.
 - The POWER indicator will go out.
 - If the power cord should be unplugged accidentally while the fan is cooling the lamp for shutdown, allow the projector to cool down for 10 minutes and then turn the power back on. To light the lamp again, press the ON button. If the lamp doesn't light up immediately, repeat pressing the ON button two or three times. If it should still fail to light up, replace the lamp.

Notice:

- When storing the projector in the carrying case, the lens should face up.

Instant Shut Down

You don't want to wait for the cooling fan to cease operation after powering off the projector. You can unplug the power cord right after the projector is powered off.

- Don't shut down the projector immediately after the lamp lights up because the lamp's life may be shortened.
- Don't turn the projector back on right after shutting it down because the lamp's life may be shortened. (Wait about 10 minutes before turning the projector back on.)
- Before shutting down the projector, be sure to close the menu screen. If you shut down the projector without closing the menu, the setting data of the menu may not be saved.

AUTO POSITION button

When the image isn't projected in the right position with COMPUTER selected as the input source, follow the procedure below.

1. Project a bright image such as the "Recycle Bin" window on the full screen.
2. If the screen saver is running, turn it off.
3. Press the AUTO POSITION button.
 - If the image is still not in the right position, adjust the image position using the Computer Image menu. See page 15.

VOLUME button

Press the KEYSTONE/VOLUME button to select Keystone or Volume, and press the ▲ or ▼ button to change the volume from the speaker.

The volume control bar will appear on the screen.



- The volume control bar will disappear according to OSD Timeout after the VOLUME button is released.
- The VOLUME buttons don't function while the menu selection bar or the menu is being displayed.

- When a high-level audio signal, such as a DVD audio signal, is supplied to the AUDIO-IN terminal, the output from the speaker may be distorted.

AV MUTE button

The video and audio signals are temporarily muted when the AV MUTE button is pressed. To cancel muting, press the AV MUTE button again.

ASPECT button

You can change the aspect ratio of the input video signal (or the ratio of width to height of the image). Change the setting according to the type of the input video signal.

How to change the settings:

With the remote control:

1. Press the ASPECT button.
 - Every time the ASPECT button is pressed, the aspect mode changes from 4:3 to 16:9, and back to 4:3.

With the Picture menu:

(See page 16 for menu setting.)

1. Display the Picture menu.
2. Select Aspect Ratio by pressing the ▲ or ▼ button.
3. Select your desired aspect ratio by pressing the ◀ or ▶ button.

To cancel the menu:

4. Press the MENU button.

Important:

- When a 16:9 image is kept displayed for a long time before displaying 4:3 image, the afterimages of the black bars may appear on the 4:3 image screen. Consult your dealer in this case.

Caution:

- After using the projector, wait one minute for the air outlet fans to stop in normal use. Then unplug the power cord from the wall outlet.
- The lamp can't be lit again for one minute after turned off for safety purpose. It will take another one minute for the STATUS indicator to go out. If you want to turn on the projector again, wait until the indicator goes out, and then press the POWER button.
- The air outlet fans rotate faster as the temperature around the projector rises.

Important:

- Do not display a still picture for a long time because the afterimages may persist on the screen.

When connecting to a laptop computer:

- When this projector is connected to a laptop computer, there may be times when images may not be projected. When it occurs, set the computer so that it can output signals externally. The procedure varies across computers in use. See the instruction manual of your computer.

Menu operation

* Menus are not displayed when no signal is supplied to the projector.

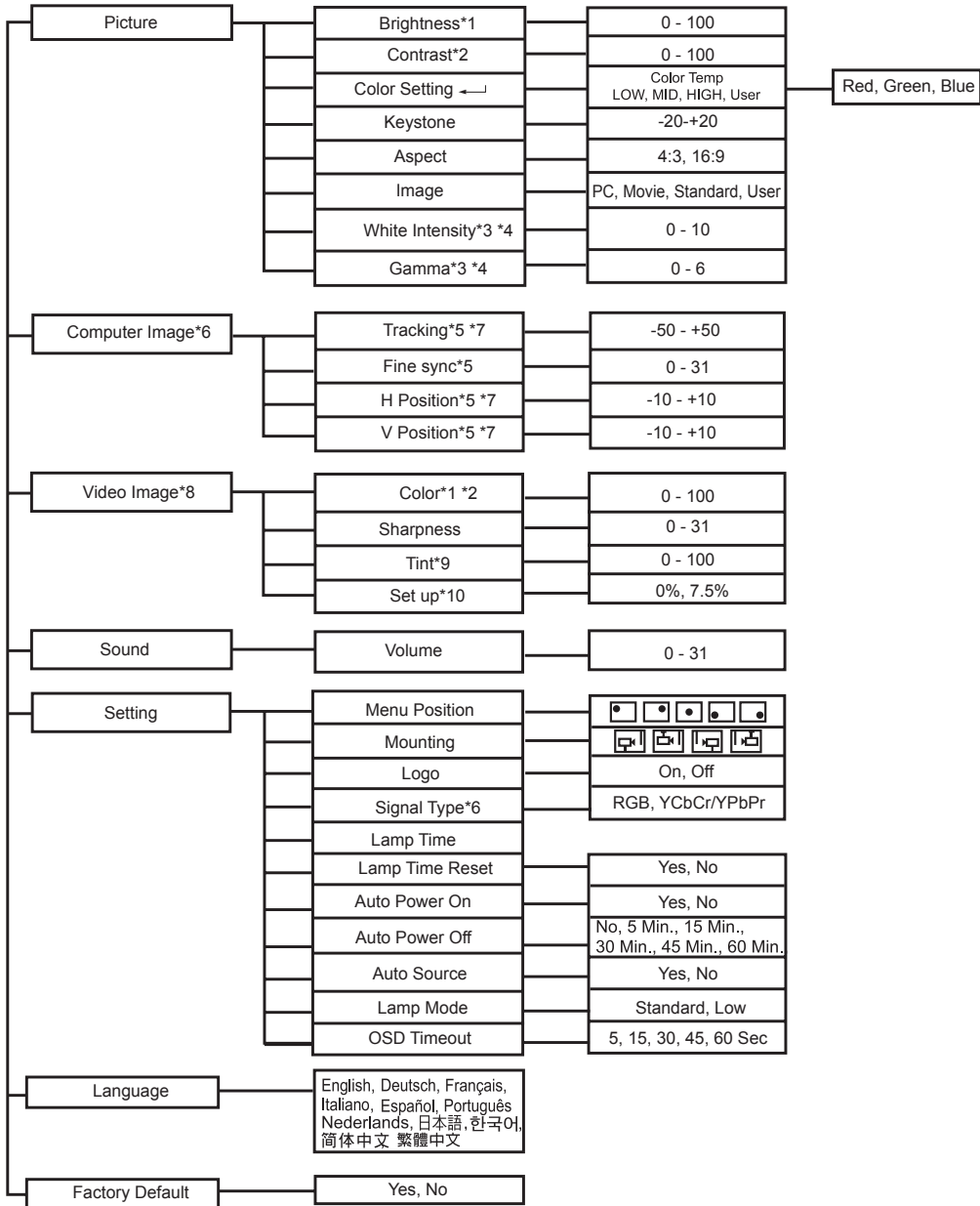

- *1 Default setting varies depending on input signals.
- *2 Available only when the input signal is PC or Video signal.
- *3 Setting value varies depending on the setting of Image.
- *4 Only adjustable when Image setting is User.
- *5 Adjustable range and default setting vary depending on signal type.
- *6 Not available when the input signal is Video.
- *7 Only available when the input signal is PC.
- *8 Not available when the input signal is PC.
- *9 Only available when the input signal is Video.
- *10 Only available when input signal is NTSC.

Important:

- When the menu is turned on and the signal is lost or not input, the system will not search for the signal even if the signal is input again. In this case, turn off the menu.
- The setting will be saved even if the menu is closed.
- The setting will not be saved when the menu is closed in a no signal state.

Menu operation (continued)

Basic operation

Several settings can be adjusted using the menu.

Example : Brightness setting

1. Press the MENU button.

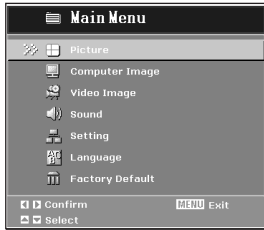

2. Press the ▲ or ▼ button to select Picture.

3. Press the ► button.

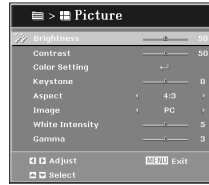

4. Press the ▲ or ▼ button to select Brightness.

5. Press the ◀ or ▶ button to adjust the brightness.

6. Exit the menu by pressing the MENU button several times

Important:

- When the button doesn't function, unplug the power cord from the wall outlet. Wait about 10 minutes, plug the power cord in, and try again.
- After selecting the items marked with , press the ENTER button.

Menu Options

Set the following options provided in the respective menus.

1. Picture menu

Menu option	Setting	Feature description
Brightness	0 - 100	Brighten or darken the image.
Contrast	0 - 100	Set the difference between light and dark areas.
Color Setting	Color Temp 4 options	Adjust the color temperature. At higher temperature the screen looks colder; at lower temperature, the screen looks warmer. If you select "User", "Red", "Green" and "Blue" can be adjusted.
Keystone	-20 - +20	Correct the keystone distortion.
Aspect	4:3	The input source will be scaled to fit the projection screen. • SXGA signal is supported.
	16:9	The input source will be scaled to fit the width of the screen.
Image	PC	For PC presentation (The brightness is emphatic.)
	Movie	For home theater.
	Standard	For PC standard color.
	User	Memorize user's settings.
White Intensity	0 - 10	Increase the brightness of white areas.
Gamma	0 - 6	Effect the represent of dark scenery. With greater gamma value, dark scenery will look brighter.

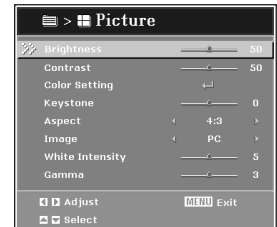

- If the cable is pulled out from the projector when the menu is displayed, last memory will lose, and the setting value will disappear.

Menu operation (continued)

2. Computer Image menu

The projector adjusts the format of the video signal supplied from the computer. However, sometimes images are not projected correctly owing to the type of the computer used. When the image from the computer isn't projected correctly, press the AUTO POSITION button. If the image isn't projected correctly yet, adjust the image from the computer using the menu.

In this menu, the setting value is not saved after turning off the projector or when unplugging the signal cable. This menu is prepared just for temporary use when AUTO POSITION does not work correctly for the current provided signal.

Menu option	Setting	Feature description
Tracking	-50 - +50	Adjust the timing of the projector relative to the computer.
Fine sync	0 - 31	Adjust the phase of the projector relative to the computer. <ul style="list-style-type: none"> You can fine-tune the Fine sync, but it is not easily identified.
H Position	-10 - +10	Adjust the image left or right within the projection area.
V Position	-10 - +10	Adjust the image up or down within the projection area.

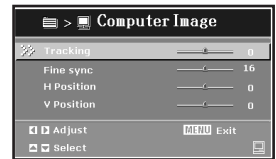

- Horizontal strips may appear in the enlarged projected image, though these conditions are not a malfunction.
- When you change the value of the horizontal or vertical position drastically, noise may appear.
- The adjustable range of the vertical position varies depending on the type of the input signal. The image may be stationary even when the value is changed. These conditions are not a malfunction.

Simple adjustment method

- Select H Position in the Computer Image menu.
- Press the ◀ or ▶ button to adjust the horizontal start position (or the left side of the image).
- Select Tracking in the Computer Image menu.
- Press the ◀ or ▶ button to adjust the horizontal start position (or the right side of the image).
- Repeat steps 1 to 4 for optimum adjustment results.
- Select V Position in the Computer Image menu.
- Press the ◀ or ▶ button to adjust the vertical start position (or the upper edge of the image).

3. Video Image menu

Menu option	Setting	Feature description
Color	0 - 100	Adjust the intensity of colors.
Sharpness	0 - 31	Sharpen or soften the image. <ul style="list-style-type: none"> You can fine-tune the Sharpness, but it is not easily identified.
Tint	0 - 100	Shift colors toward red or green.
Set up	0%, 7.5%	When 0% is selected, the black area becomes make lighter. When 7.5% is selected, the black area becomes thicker.



- If the cable is pulled out from the projector when the menu is displayed, last memory will lose, and the setting value will disappear.

4. Sound menu

Menu option	Setting	Feature description
Volume	0 - 31	Adjust the volume level.



Menu operation (continued)

5. Setting menu

Menu option	Setting	Feature description
Menu Position	5 options	Choose the menu location on the display screen.
Mounting	4 options	Adjust the picture to match the orientation of the projector: upright or upside-down, in front of or behind the screen. Invert or reverse the image accordingly.
Logo	On, Off	Choose to display the logo or not.
Signal Type	RGB YCbCr/YPbPr	For VGA signal For Component I,P signal
Lamp Time		Display the lamp's elapsed operating time (in hours). <ul style="list-style-type: none"> The displayed lamp time is based on low lamp mode setting. (The lamp lifetime is 3000 hours.)
Lamp Time Reset	Yes, No	Reset the lamp time to 0 hours.
Auto Power On	Yes, No	When this mode is set to Yes, the lamp is automatically lit when the power cord is plugged in the wall outlet. Select Yes when you set the projector at the ceiling. <ul style="list-style-type: none"> When the lamp is off, the projector is in standby. Use the remote control to turn on the lamp.
Auto Power Off	No, 5-60 Min.	Selects a desired timer setting until the projector enters the standby mode when there is no signal input from the source.
Auto Source	Yes, No Standard	Automatically scan the input source. Select this setting when you want to view images in a well-lit room.
Lamp Mode	Low	Select this setting when you want to view images at a moderate light intensity. The operating sound is consequently reduced, and the lamp lifetime becomes longer. <ul style="list-style-type: none"> When this mode is switched, projected images may flicker. If this mode is frequently switched, the lamp may be deteriorated. The default setting is Standard when shipment. The Lamp Mode cannot be switched for about 1 minute after the lamp is on.
OSD Timeout	5 - 60 sec	Duration OSD menu stays active (at idle state by second).

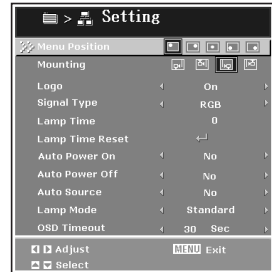

6. Language menu

Menu option	Setting	Feature description
Language	11 languages	Select the language used by the on-screen menu.



7. Factory Default menu

Menu option	Setting	Feature description
Factory Default	Yes, No	Restore all menu settings to factory default settings.



Image adjustment

You can adjust projected images by using Picture and Video Image menus.

To adjust the brightness and contrast:

You can make adjustments of the brightness of the projected image using the menu.

(See page 16 for the menu options.)

1. Display the Picture menu.
2. Select Brightness or Contrast by pressing the ▲ or ▼ button.
3. Adjust the selected option by pressing the ◀ or ▶ button.

To cancel the menu:

4. Press the MENU button.

Brightness

Every time the ▶ button is pressed, the image becomes brighter.

Every time the ◀ button is pressed, the image becomes darker.

Contrast

Select to adjust the contrast of the image. Every time the ▶ button is pressed, the image becomes brighter and more clearly defined. Every time the ◀ button is pressed, the image becomes darker and less clearly defined.

To adjust the color setting:

You can adjust color setting using the menu.

(See page 16 for the menu options.)

1. Display the Picture menu.
2. Select Color Setting by pressing the ▲ or ▼ button.
3. Select your desired color temperature by pressing the ◀ or ▶ button.

To set a user-defined color temperature, perform the following procedure:

1. Select User in the Color Temp menu.
2. Press the ▲ or ▼ button to select the desired setting.
3. Press the ◀ or ▶ button to adjust the selected setting.

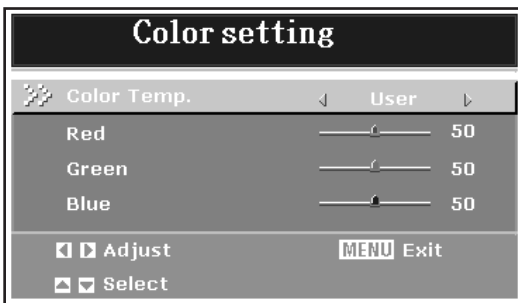

To cancel the menu:

4. Press the MENU button.

To adjust the color:

You can adjust color using the menu.

(See page 17 for the menu options.)

1. Display the Video Image menu.
2. Select Color by pressing the ▲ or ▼ button.
3. Adjust the selected option by pressing the ◀ or ▶ button.

To cancel the menu:

4. Press the MENU button.

Color

Use to adjust the color density of the projected image. Every time the ▶ button is pressed, the color becomes lighter. Every time the ◀ button is pressed, the color becomes darker.

To sharpen or soften the projected image:

You can adjust the sharpness of the projected image using the menu.

(See page 17 for the menu options.)

1. Display the Video Image menu.

2. Select Sharpness by pressing the ▲ or ▼ button.
3. Adjust the selected option by pressing the ◀ or ▶ button.

To cancel the menu:

4. Press the MENU button.

Sharpness

Use to adjust the sharpness of the projected image. Every time the ▶ button is pressed, the image appears more sharp. Every time the ◀ button is pressed, the image appears more soft.

To adjust the tint:

You can adjust the tint using the menu.

(See page 17 for the menu options.)

1. Display the Picture menu.
2. Select Tint by pressing the ▲ or ▼ button.
3. Select your desired color temperature by pressing the ◀ or ▶ button.

To cancel the menu:

4. Press the MENU button.

Tint

Use to adjust the tint of the projected image. Every time the ▶ button is pressed, the image appears more greenish. Every time the ◀ button is pressed, the image appears more reddish.

Lamp replacement

This projector is equipped with a lamp to project images. This lamp is a consumable. It may burn out or its brightness may decrease during use. In such cases, replace the lamp with a new one as soon as possible. Be sure to replace the lamp with a new lamp separately sold that is exclusive to this projector. Contact your dealer for purchase of the lamp.

Spare lamp for XD210U/SD210U: VLT-XD210LP

Caution:

- Do not remove the lamp immediately after using the projector. You may get burned because the lamp is very hot after use.
- Before replacing the lamp, press the STANDBY button to turn off the lamp and wait for two minutes for the lamp to cool down. Unplug the power cord from wall outlet and wait one hour for the lamp to cool down completely.
- Do not remove the lamp except for replacement. Careless handling can cause injury or fire.
- Do not touch the lamp directly. It may break and cause injury or burn.
- Be sure not to drop the lamp lid screw into the projector. Also be sure not to put metal or any flammable objects inside because it may cause fire or electric shock. If any objects should fall inside, unplug and contact your dealer.
- Install the lamp securely to prevent failure and fire.
- If the lamp should break, small glass fragments may fall out through the grilles and some may remain inside of the projector or the lamp box. When taking the lamp box out, be sure to turn over the projector and hold the handle of the lamp box to avoid injury due to the glass fragments.
- If the lamp should break, never shake the lamp box or hold it in front of your face after removing it. The glass fragments may fall out and cause injury to your eyes.
- Be sure to use the lamp dedicated to this projector, VLT-XD210LP for XD210U/SD210U. Use of other lamps may cause a failure of the projector.

If the projector is installed in a ceiling mount, remove it from the mount. Place a protective sheet (cloth) beneath the projector. Turn the projector over so you can access the lamp cover.

1. Loosen the screw in the lamp cover and remove the cover.
2. Loosen the two screws from the lamp module.
3. Pull up the handle, and then pull out the lamp unit by the handle.
4. Insert a new lamp module into the projector and tighten the screws.
5. Attach the lamp cover and tighten the screw.

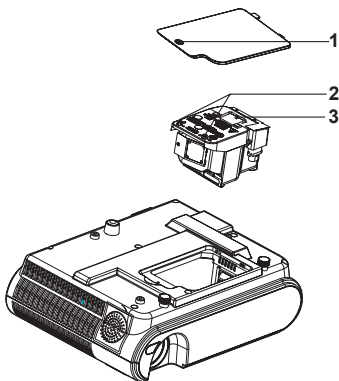

Reset of the lamp operation time

Plug in the power cord and power on, and reset the lamp operation time by pressing the MENU button. Select Setting>Lamp Time Reset>Yes.

Important:

- The projector doesn't turn on if the lamp cover isn't attached securely.

- Be sure to reset the lamp operation time whenever you replace the lamp.
- Do not reset the lamp operation time unless you replace the lamp.

Caution:

- The lamp is fragile. If it is broken, be careful not to cut yourself with glass fragments.
- Contact your dealer for a new lamp.

Interval of lamp replacement

When the lamp operation time exceeds 3000 hours, the lamp replacement message will appear on the screen until the lamp is replaced and the lamp operation time is reset.

Important:

- Do not open the lamp cover when the projector is set at a ceiling or a high place. Lamp fragments may fall from the inside if the lamp were broken. Please contact your dealer when you need to replace the lamp with a new one.
- Lamp Time is calculated by Low Lamp Mode. (At Standard Lamp Mode, 2000 hours are equal to 3000 hours at Low Lamp Mode. In this case, the warning message will be displayed.)





































Caution:

- This projector uses a lamp that contains mercury. Disposal of the lamp or the projector with the lamp may be regulated due to environmental considerations. For disposal or recycling information, please contact your local authorities or the Electronic Industries Alliance: www.eiae.org. (For US only).

Troubleshooting

Before asking for repair of the projector, check the following. If the symptom persists, stop using the projector, be sure to unplug the power plug, and then contact your dealer.

No image appears on the screen.

Problem	Solution																					
Power can not be turned on.	<ul style="list-style-type: none"> Check whether the indicators are on or off and how they are lighting. <table border="1" data-bbox="498 314 1259 716"> <thead> <tr> <th>POWER</th> <th>STATUS</th> <th>Solution</th> </tr> </thead> <tbody> <tr> <td> Off</td> <td> Off</td> <td> <ul style="list-style-type: none"> Connect the power cord to the projector. Plug the power cord into a wall outlet. </td> </tr> <tr> <td> Steady green</td> <td> Blinking green</td> <td> <ul style="list-style-type: none"> Unplug the power cord from the wall outlet and contact your dealer. </td> </tr> <tr> <td> Steady amber</td> <td> Steady green</td> <td> <ul style="list-style-type: none"> Replace the lamp. (The lamp is at the end of its life.) </td> </tr> <tr> <td> Steady green</td> <td> Blinking red</td> <td> <ul style="list-style-type: none"> Do not unplug the power cord or turn the power off before the POWER indicator changes to flashing. The fan motor will turn off when the lamp has cooled. </td> </tr> <tr> <td> Blinking green</td> <td> Off</td> <td> <ul style="list-style-type: none"> Press the ON button several times. </td> </tr> <tr> <td> Blinking green</td> <td> Blinking red</td> <td> <ul style="list-style-type: none"> Wait for 1 hour until the lamp cools down, and turn the power back on. If the temperature is still high after 1 hour, contact your dealer. </td> </tr> </tbody> </table>	POWER	STATUS	Solution	 Off	 Off	<ul style="list-style-type: none"> Connect the power cord to the projector. Plug the power cord into a wall outlet. 	 Steady green	 Blinking green	<ul style="list-style-type: none"> Unplug the power cord from the wall outlet and contact your dealer. 	 Steady amber	 Steady green	<ul style="list-style-type: none"> Replace the lamp. (The lamp is at the end of its life.) 	 Steady green	 Blinking red	<ul style="list-style-type: none"> Do not unplug the power cord or turn the power off before the POWER indicator changes to flashing. The fan motor will turn off when the lamp has cooled. 	 Blinking green	 Off	<ul style="list-style-type: none"> Press the ON button several times. 	 Blinking green	 Blinking red	<ul style="list-style-type: none"> Wait for 1 hour until the lamp cools down, and turn the power back on. If the temperature is still high after 1 hour, contact your dealer.
POWER	STATUS	Solution																				
 Off	 Off	<ul style="list-style-type: none"> Connect the power cord to the projector. Plug the power cord into a wall outlet. 																				
 Steady green	 Blinking green	<ul style="list-style-type: none"> Unplug the power cord from the wall outlet and contact your dealer. 																				
 Steady amber	 Steady green	<ul style="list-style-type: none"> Replace the lamp. (The lamp is at the end of its life.) 																				
 Steady green	 Blinking red	<ul style="list-style-type: none"> Do not unplug the power cord or turn the power off before the POWER indicator changes to flashing. The fan motor will turn off when the lamp has cooled. 																				
 Blinking green	 Off	<ul style="list-style-type: none"> Press the ON button several times. 																				
 Blinking green	 Blinking red	<ul style="list-style-type: none"> Wait for 1 hour until the lamp cools down, and turn the power back on. If the temperature is still high after 1 hour, contact your dealer. 																				
No image appears on the screen.	<ul style="list-style-type: none"> Cancel the AV mute by pressing the AV MUTE button. Check that the lens cap is removed. It may take about 1 minute for the lamp to light up. The lamp fails to light up on rare occasions. In such a case, wait for a few minutes and then try again. If the projector was turned off before the lamp was cooled down sufficiently last time, the fan may start rotating and the ON button may not work after the power cord is plugged. After the fan stops rotating, press the ON button to turn back on the POWER indicator. Check that the intake vent is clean. Check that the lamp cover is closed. (See page 20.) Check that the cables connected to the external devices are not broken. When an extension cable is being used, replace it with the supplied cable for check. When images are displayed correctly, add an RGB signal amplifier to the extension cable. When the menu is turned on and the signal is lost or not input, the system will not search for the signal even if the signal is input again. In this case, turn off the menu. 																					
Power turns off.	<ul style="list-style-type: none"> This problem may occur when the intake vent and/or exhaust vents are blocked. (For example: the STATUS indicator brinks red.) <ul style="list-style-type: none"> → Remove the objects blocking the intake vent and/or exhaust vents and then carry out the following procedure. <ol style="list-style-type: none"> Wait for the intake fan and/or exhaust fan to stop. (Wait until the POWER indicator lights green.) Unplug the power cord from the wall outlet. Wait about 10 minutes. Plug the power cord into the wall outlet. Press the ON button. When the POWER indicator is steady amber, it is indicating that the lamp should be replaced. Replace the lamp in this case. If the lamp has deteriorated, it may go out after a while it illuminates. Check if the "Auto power off" function is set. 																					
"No Signal" is displayed.	<ul style="list-style-type: none"> Turn on the power of the connected device, or check whether there is something wrong with the connected device. Check whether the external device output signals. (Check this especially when the external device is a notebook computer.) Check that the cable connected to the external device isn't defective. Check that the projector is connected to the external device using the correct terminals. Check that the connected device is correctly selected as the input source. When an extension cord is being used, replace it with the supplied cable and check whether images are projected correctly. If images are projected correctly, use an RGB signal amplifier along with the extension cord. 																					

Troubleshooting (continued)

Images are not displayed correctly.

Problem	Solution
Projected images are shaking. Projected images are displaced.	<ul style="list-style-type: none"> • Check that the cable connected to the external device isn't intermittent. • Connect the cable's plug with the external device's connector firmly. • Press the AUTO POSITION button. • Some computers output out-of-spec signals on rare occasion. Adjust the Computer Image menu. (See page 17.)
Projected images are distorted.	<ul style="list-style-type: none"> • Adjust the projector and the screen so that they are perpendicular to each other. (See page 9.)
Projected images are dark.	<ul style="list-style-type: none"> • Adjust Brightness and Contrast in the Picture menu. (See page 16.) • Replace the lamp. (See page 20.)
Projected images are blurred.	<ul style="list-style-type: none"> • Adjust the focus. (See page 13.) • Clean the lens. • Adjust Tracking and Fine sync. in the Computer Image menu. (See page 17.) • Adjust Brightness and Contrast in the Picture menu. (See page 16.) • Adjust the projector and the screen so that they are perpendicular to each other. (See page 9.)
Afterimages persist on the screen.	<ul style="list-style-type: none"> • This phenomenon is improved by keeping projecting an evenly bright image. (Such "image burn-in" phenomenon where afterimages persist on the screen may occur if a stationary image is kept displayed on the screen for a long time.)
White dots are seen on projected images. Black dots are seen on projected images.	<ul style="list-style-type: none"> • This phenomenon is normal for a DLP projector and is not a malfunction. (A very small number of pixels may visibly or invisibly be persistent all the time, but they are not a sign of system malfunctions. Over 99.99% of the pixels are effective.)
Fine streaks are seen on projected images.	<ul style="list-style-type: none"> • This is due to interference with the screen surface and is not a malfunction. Replace the screen or displace the focus a little. • Vertical or horizontal streak noise may appear on the projected image, it may depend on the type of the DVD player, game console or computer you use.
Projected images become wavy.	<ul style="list-style-type: none"> • Connect the plugs of the cables to external devices securely. • Keep the projector away from equipment generating interfering radio waves. • When the keystone adjustment is carried out, the image may not be displayed correctly because of the type of input signal. This isn't a product malfunction. In this case, readjust the keystone so that the amount of keystone correction is as small as possible.
Hue is not appropriate.	<ul style="list-style-type: none"> • Check that the cables connected to the external devices are not broken.
Tint in projected images is incorrect.	<ul style="list-style-type: none"> • Check that Signal Type in the Setting menu is correctly set. (See page 18.) • Check that the cable connected to the external device isn't broken.
Different color tint.	<ul style="list-style-type: none"> • When comparing images projected by two projectors, tints in the displayed images may be different because of variation between their optical components. This is not a malfunction. • When comparing the image projected by this projector with those displayed on the television or PC monitor, tints in the displayed images may be different because of difference in the range of color reproducibility. This is not a malfunction.
Only the motion areas in the images supplied from the computer aren't displayed.	<ul style="list-style-type: none"> • This is caused by the computer being used. Contact the manufacturer of your computer.
Projected images are obscured.	<ul style="list-style-type: none"> • Match the output resolution of your computer with the resolution of the projector. For the method to change the output resolution of the computer, contact the manufacturer of your computer. (See page 27.) • Some images and texts appear obscured during the keystone adjustment. In such cases, use the projector without applying the keystone adjustment. (See page 12.)
Projected images are flickering	<ul style="list-style-type: none"> • After the ON button on the remote has been pressed, or the Lamp mode setting has changed, images may be flickering until the lamp lights stably. This is an expected behavior. • When selecting the input signal, AUTO POSITION and Image in Menu, the projected image may be flickering temporarily. This is not a product malfunction.

Others

Problem	Solution
The exhaust vents emit warm air.	<ul style="list-style-type: none"> This air comes out after cooling the inside of the projector. You may feel hot, but this is not a malfunction.
No audio is output.	<ul style="list-style-type: none"> Check that the volume isn't set to low.
The menu can't be used.	<ul style="list-style-type: none"> The microcomputers inside the projector may be wrongly operating because of noise. <ul style="list-style-type: none"> → Press the ON button to turn off the lamp and unplug the power cord from the wall outlet. Wait about 10 minutes, plug the power cord in, and try again.
The remote control doesn't function easily or at all.	<ul style="list-style-type: none"> Check that the battery is loaded in the remote control or the battery is not weak. (See page 8.) Check that the remote control sensor isn't exposed to direct sunlight or fluorescent light. (See page 8.) Use the remote control within its operation range. (See page 8.)
Abnormal sound is heard.	<ul style="list-style-type: none"> Because the color wheel spins at a high speed, metallic sounds may be heard in rare occasions. Such symptom is not a malfunction.

If the following problem occurs after the lamp is replaced, check the following first.

Problem	Solution
The projector does not turn on.	<ul style="list-style-type: none"> Fit the lamp cover securely. (See page 20.)
The POWER lights amber and the STATUS lights green.	<ul style="list-style-type: none"> Reset the lamp operating time. (See page 20.)

Maintenance

Warning:

Do not use flammable solvents (benzene, thinner, etc.) and flammable aerosols when cleaning the projector body and lens. Flammable substances may ignite causing fire or breakdown while the lamp is illuminating.

Caution:

Be sure to turn off the lamp and unplug the power cord from the wall outlet before you perform any maintenance on the projector.

Cleaning of the projector and the ventilation slots

Use a soft cloth to clean the projector and the ventilation grilles. When the grilles become dirty, wipe them with a soft cloth dampened with diluted mild detergent, and then wipe them with a dry cloth.

To protect the surface of the projector from fading or deteriorating:

- Do not spray insecticide on or inside the projector.
- Do not use benzine or thinner to clean it.
- Do not let rubber or plastic materials contact with projector.

Cleaning of the lens

Use a standard lens-cleaning brush or a piece of lens tissue dampened with lens cleaning fluid. The lens surface is fragile. Use only recommended, nonabrasive lens-cleaning materials. Do not touch the lens with your fingers.





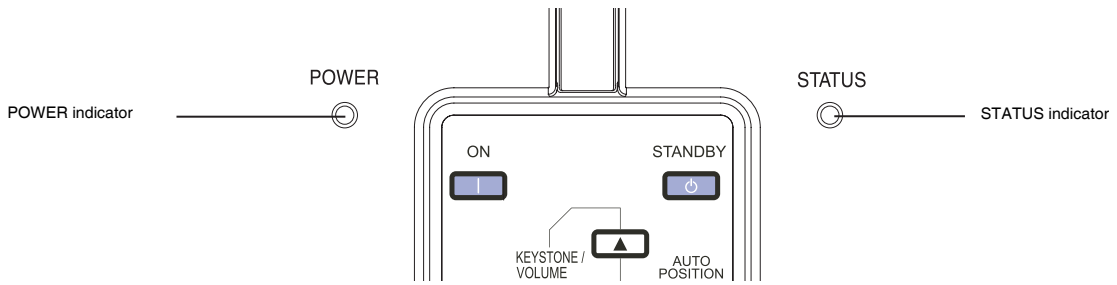

Indicators

This projector has two indicators, each of which shows the operation condition of the projector.











The following offer solutions to possible problems. If these problem persist, turn the projector off and consult your dealer.



Normal condition

POWER	STATUS	CONDITION	NOTE
 Blinking green	 Off	Stand-by	
 Steady green	 Steady green	The projector is in good condition.	
 Steady amber	 Steady amber	The projector is shutting and the fan motor is cooling the lamp for shutdown. Do not unplug the power cord or turn the power off before the POWER LED changes to flashing. The fan motor will turn off when the lamp has been cooled.	

Abnormal condition

POWER	STATUS	CONDITION	POSSIBLE SOLUTION
 Steady green	 Blinking green	The projector system has some problems with its fan, so the projector cannot start up.	Contact your dealer.
 Steady amber	 Steady green	The lamp has reached its end of life and must be changed soon. The lamp will continue to operate until it fails. Change the lamp. If the lamp is off, then the ballast will become malfunction. (during power on)	Replace the lamp and reset the lamp operation time.
 Steady green	 Blinking red	Temperature is too high. The lamp will turn off. The fan motor is cooling the lamp.	Wait until the lamp cools down, and the projector enters stand-by mode.
 Steady green	 Off	The lamp ignition failed.	Replace the lamp and reset the lamp operation time.
 Blinking green	 Blinking red	Temperature is too high or temperature's sensor is error during stand-by mode.	<ul style="list-style-type: none"> Wait for 1 hour until the lamp cools down, and turn the power back on. If the temperature is still high after 1 hour, contact your dealer.

Specifications

Type	DLP™ DATA projector
Model	XD210U/SD210U
Rated power supply	100 - 240 V AC, 50 / 60 Hz
Rated input	2.5 A
Display Technology	0.55-inch Single chip Digital Micromirror Device (DMD) XD210U: Pixels 1024 x 768 = 786432 pixels SD210U: Pixels 800 x 600 = 480000 pixels
Colors	16770000 colors
Projection lens	F 2.5 - 2.7, f = 22.0 - 24.2 mm
Light source lamp	180 W
Picture size	30 - 300 inch (aspect ratio 4:3)
PC compatibility	Resolution:640x480 (Expand) - 1024x768 (Real) - 1280x1024 (Compress) Sync on Green available
Video compatibility	NTSC / NTSC 4.43 / PAL (including PAL-M, N) / SECAM, PAL-60 Component Video (DVD/HDTV) (480i, 576i, 480p, 576p, 1080i, 720p)
Speaker	2W x 1 / 16 ohm
Video input	1.0 Vp-p 75 Ω (negative sync.)
Audio input	350 mVrms, 10 kΩ or more
Analog RGB input	RGB: 0.7 Vp-p 75 Ω (negative sync.) YPbPr/YCbCr : Y:1.0 Vp-p (negative sync.) PbPr/CbCr:0.7 Vp-p
Control connector	Serial terminal (RS-232C) (Mini-Din)
Outside dimensions	302 x 104.5 x 221 mm (width x height x depth)
Weight	Approx. 2.6 kg
Length of power cord	114 inch (1.8 m)
Temperature, humidity (performance guaranteed)	+41°F (+5°C) - +95°F (+35°C), 30 - 90%

- The specifications and outside appearance of the projector are subject to change without prior notice.

Specifications (continued)

Connectors

COMPUTER IN(D-SUB 15-pin)

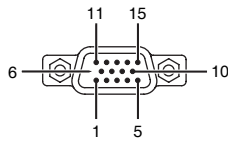

pin No.	Spec.
1	R(RED)/CR
2	G(GREEN)/Y
3	B(BLUE)/CB
4	NC
5	GND
6	GND
7	GND
8	GND
9	DDC5V
10	-
11	-
12	DDC Data
13	HD/CS
14	VD
15	DDC Clock

Dimensional drawings (unit : mm)

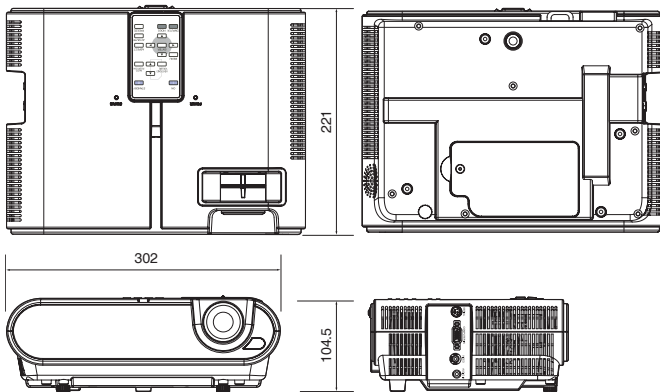

What's included in the box

AC power cord	for US J2552-0063-01 for EU J2552-0066-01 for UK J2552-0065-01	2 Remote control with battery (One is installed in the main body)
1 RGB cable for PC	J2552-0072-03	1 Safety manual/Quick start up
		1 CD-ROM
		1 Lens cap
		1 Soft case
		1 Cap RC lock button

Replacement part

(Option / Not included in the box)

Spare lamp for XD210U/SD210U

VLT-XD210LP

Specifications (continued)

Specification of RGB signals in each computer mode of the projector

Signal mode	resolution	horizontal frequency (kHz)	vertical frequency (Hz)	XD210U (H x V)	SD210U (H x V)
NTSC (60), 480i (60)	-	15.73	59.94	1024 x 768	800 x 600
PAL (50), 576i (50)	-	15.63	50.00	1024 x 768	800 x 600
1080i (60)	-	33.75	60.00	1024 x 576	800 x 450
1080i 50	-	28.13	50.00	1024 x 576	800 x 450
480p (60)	-	31.47	59.94	1024 x 768	800 x 600
576p (50)	-	31.25	50.00	1024 x 768	800 x 600
720p (60)	-	45.00	60.00	1024 x 576	800 x 450
720p (50)	-	37.50	50.00	1024 x 576	800 x 450
VGA	640 x 400	24.82	56.42	1024 x 640	800 x 500
		37.86	84.13	1024 x 640	800 x 500
		37.86	85.08	1024 x 640	800 x 500
	640 x 480	31.47	59.94	1024 x 768	800 x 600
		37.86	72.81	1024 x 768	800 x 600
		37.50	75.00	1024 x 768	800 x 600
SVGA	800 x 600	43.27	85.01	1024 x 768	800 x 600
		35.16	56.25	1024 x 768	800 x 600
		37.88	60.32	1024 x 768	800 x 600
		48.08	72.19	1024 x 768	800 x 600
		46.88	75.00	1024 x 768	800 x 600
XGA	1024 x 768	53.67	85.06	1024 x 768	800 x 600
		48.36	60.00	1024 x 768	800 x 600
		56.48	70.07	1024 x 768	800 x 600
		60.02	75.03	1024 x 768	800 x 600
		62.94	74.92	1024 x 768	800 x 600
SXGA	1152 x 864	68.68	85.00	1024 x 768	800 x 600
		63.85	70.01	1024 x 768	800 x 600
	1152 x 900	67.50	75.00	1024 x 768	800 x 600
		61.85	66.00	984 x 768	768 x 600
		71.81	76.84	984 x 768	768 x 600
1280 x 960	60.00	60.00	1024 x 768	800 x 600	
1280 x 1024	63.98	60.02	960 x 768	750 x 600	
MAC	640 x 480	35.00	66.67	1024 x 768	800 x 600
	832 x 624	49.72	74.55	1024 x 768	800 x 600
	1024 x 768	60.24	75.02	1016 x 768	800 x 600

Important:

- Some computers aren't compatible with the projector.
- The projector's maximum resolution is 1024 x 768 pixels. It may not display images of higher resolutions than 1024 x 768 (or 800 x 600) correctly.
- Images with SYNC on G (Green) signal may jitter.
- Images with SYNC on G (Green) signal may be tinged with green.
- If the resolution and frequency of your computer aren't shown on the table, find the compatible resolution and frequency by changing the resolution of your computer.
- When connecting a HDTV decoder having RGB output terminals, set Signal Type to RGB in the Setting menu.
- Video signal with 4 line (R, G, B, CS) and 5 line (R, G, B, H, V) is not supported.
- The resolutions of 640 x 480 (72 Hz) and 640 x 480 (75Hz) do not support images with SYNC on G (Green) and Composite Sync.

Mitsubishi Projector Warranty, Sales Support and Service Information

North America

MDEA (Mitsubishi Digital Electronics America, Inc.)
Presentation Products Division
9351 Jeronimo Road
Irvine, CA 92618, USA
For Warranty Registration, visit:
<http://www.mitsubishi-presentations.com> under Customer Care

Sales & Inquiries
Phone :Toll Free (888)307-0349
E-mail :ppdinfo@mdea.com

Technical Inquiries
Phone :Toll Free (888)307-0309
E-mail :TSUPPORT@mdea.com

MESCA (Mitsubishi Electric Sales Canada Inc.)
<http://www.mitsubishielectric.ca>
Information Technologies Group, 4299 14th Avenue,
Markham, Ontario L3R 0J2, Canada

Sales & Technical Inquiries
Phone :+1-(800) 450-6487
Fax :+1-(905) 475-7958
E-mail :projectors@mitsubishielectric.ca

Customer Care
E-mail :support@mitsubishielectric.ca

Europe

MEU-FRA (Mitsubishi Electric Europe B.V French Branch)
25, Boulevard des Bouvets 92 741, Nanterre CEDEX,
France

Sales Inquiries
Phone :+33 (0)1 55-68-55-53
Fax :+33 (0)1 55-68-57-31

Technical Inquiries
Phone :+33 (0)1 55-68-56-42
Fax :+33 (0)1 55-68-57-31

MEU-GER (Mitsubishi Electric Europe B.V. German Branch)
<http://www.mitsubishi-evs.de/>

Gothaer Strasse 8, 40880 Ratingen, Germany
Sales Inquiries
Phone :0049 - 2102 - 486 9250
Fax :0049 - 2102 - 486 7320

Technical Inquiries
Phone :0049 - 2102 - 486 1330
Fax :0049 - 2102 - 486 1340

MEU-IR (Mitsubishi Electric Europe B.V. Irish Branch)
<http://www.mitsubishi.ie/>

Westgate Business Park, Ballymount, Dublin 24, Ireland
Sales Inquiries
Phone :+353-1-4198807
Fax :+353-1-4198890

Technical Inquiries
Phone :+353-1-4198808
Fax :+353-1-4198895

MEU-IT (Mitsubishi Electric Europe B.V. Italian Branch)
Centro Direzionale Colleoni, Palazzo Sirio, Viale Colleoni 7,
20041 Agrate Brianza, Italy

Sales & Technical Inquiries
Phone :+39-(0)39-60531
Fax :+39-(0)39-6053214
E-mail :info.projector@it.mee.com

MEU-NL (Mitsubishi Electric Europe B.V. Benelux Branch)
<http://www.mitsubishi.nl/LCD/ProdFrame.html>

Nijverheidsweg 23A, 3641 RP Mijdrecht, The Netherlands
Sales Inquiries
Phone :+31-297-282461
Fax :+31-297-283936
E-mail :info@mitsubishi.nl

Technical Inquiries
Phone :+31-297-282461
Fax :+31-297-283936
E-mail :info@mitsubishi.nl

Russia (Mitsubishi Electric Europe B.V Moscow
Representative Office)
<http://www.mitsubishi-projector.ru/>

Moscow Representative Office, 52/5 Kosmodamianskaya
Nab., 115054, Moscow, Russia
Sales & Technical Inquiries
Phone : (7095) 721-2068
Fax : (7095) 721-2071

MEU-SP (Mitsubishi Electric Europe B.V. Spanish Branch)
<http://www.mitsubishielectric.es/>

Ctra. de Rubi, 76-80, 08173 Sant Cugat del Valles,
Barcelona, Spain

Sales Inquiries
Phone :+34-93.565.31.54
Fax :+34-93.589.43.88
E-mail :mitsubishi.profesional@sp.mee.com

Technical Inquiries
Phone :+34-93.586.27.51
Fax :+34-93.588.53.87
E-mail :mitsubishi.profesional@sp.mee.com

MEU-SWE (Mitsubishi Electric Europe B.V Scandinavian
Branch)

Hammrbacken 14, Box 750, S-19127, Sollentuna, Sweden
Sales Inquiries
Phone :+46-(0)8-6251070
Fax :+46-(0)8-6251036

Technical Inquiries
Phone :+46-(0)8-6251052
Fax :+46-(0)8-6251036

MEU-UK (Mitsubishi Electric Europe)
<http://www.mitsubishi.co.uk/evs/>

Visual Information Systems Division, Travellers Lane,
Hatfield, Hertfordshire, AL10 8XB U.K.

Sales Inquiries
Phone :+44 (1707) 278684
Fax :+44 (1707) 278541
E-mail :projector.info@meuk.mee.com

Technical Inquiries
Phone :+44 (870) 606 5008
Fax :+44 (1506) 431927
E-mail :projector.info@meuk.mee.com

MEU-USA (Mitsubishi Electric Europe B.V. USA Branch)
25, Boulevard des Bouvets 92 741, Nanterre CEDEX,
France

Sales Inquiries
Phone :+33 (0)1 55-68-55-53
Fax :+33 (0)1 55-68-57-31

Technical Inquiries
Phone :+33 (0)1 55-68-56-42
Fax :+33 (0)1 55-68-57-31

MEU-GER (Mitsubishi Electric Europe B.V. German Branch)
<http://www.mitsubishi-evs.de/>

Gothaer Strasse 8, 40880 Ratingen, Germany
Sales Inquiries
Phone :0049 - 2102 - 486 9250
Fax :0049 - 2102 - 486 7320

Technical Inquiries
Phone :0049 - 2102 - 486 1330
Fax :0049 - 2102 - 486 1340

MEU-IR (Mitsubishi Electric Europe B.V. Irish Branch)
<http://www.mitsubishi.ie/>

Westgate Business Park, Ballymount, Dublin 24, Ireland
Sales Inquiries
Phone :+353-1-4198807
Fax :+353-1-4198890

Technical Inquiries
Phone :+353-1-4198808
Fax :+353-1-4198895

MEU-IT (Mitsubishi Electric Europe B.V. Italian Branch)
Centro Direzionale Colleoni, Palazzo Sirio, Viale Colleoni 7,
20041 Agrate Brianza, Italy

Sales & Technical Inquiries
Phone :+39-(0)39-60531
Fax :+39-(0)39-6053214
E-mail :info.projector@it.mee.com

MEU-NL (Mitsubishi Electric Europe B.V. Benelux Branch)
<http://www.mitsubishi.nl/LCD/ProdFrame.html>

Nijverheidsweg 23A, 3641 RP Mijdrecht, The Netherlands
Sales Inquiries
Phone :+31-297-282461
Fax :+31-297-283936
E-mail :info@mitsubishi.nl

Technical Inquiries
Phone :+31-297-282461
Fax :+31-297-283936
E-mail :info@mitsubishi.nl

Russia (Mitsubishi Electric Europe B.V Moscow
Representative Office)
<http://www.mitsubishi-projector.ru/>

Moscow Representative Office, 52/5 Kosmodamianskaya
Nab., 115054, Moscow, Russia
Sales & Technical Inquiries
Phone : (7095) 721-2068
Fax : (7095) 721-2071

INDONESIA (Mitsubishi Electric Asia Pte. Ltd.)
307, Alexandra Road, #05-01/02 Mitsubishi Electric
Building, Singapore 159943

Sales Inquiries
Phone :+65-6473-2308
Fax :+65-6475-9503
E-mail :Peripherals@asia.meap.com

Technical Inquiries
Phone :+65-6470-2666
Fax :+65-6475-9503

PHILIPPINES (Mitsubishi Electric Asia Pte. Ltd.)
<http://www.mitsubishielectric.com.sg>

307, Alexandra Road, #05-01/02 Mitsubishi Electric
Building, Singapore 159943

Sales Inquiries
Phone :+65-6473-2308
Fax :+65-6475-9503
E-mail :Peripherals@asia.meap.com

Technical Inquiries
Phone :+65-6470-2666
Fax :+65-6475-9503

VIETNAM (Mitsubishi Electric Asia Pte. Ltd.)
307, Alexandra Road, #05-01/02 Mitsubishi Electric
Building, Singapore 159943

Sales Inquiries
Phone :+65-6473-2308
Fax :+65-6475-9503
E-mail :Peripherals@asia.meap.com

Technical Inquiries
Phone :+65-6470-2666
Fax :+65-6475-9503

MEU-USA (Mitsubishi Electric Europe B.V. USA Branch)
25, Boulevard des Bouvets 92 741, Nanterre CEDEX,
France

Sales Inquiries
Phone :+33 (0)1 55-68-55-53
Fax :+33 (0)1 55-68-57-31

Technical Inquiries
Phone :+33 (0)1 55-68-56-42
Fax :+33 (0)1 55-68-57-31

MEU-GER (Mitsubishi Electric Europe B.V. German Branch)
<http://www.mitsubishi-evs.de/>

Gothaer Strasse 8, 40880 Ratingen, Germany
Sales Inquiries
Phone :0049 - 2102 - 486 9250
Fax :0049 - 2102 - 486 7320

Technical Inquiries
Phone :0049 - 2102 - 486 1330
Fax :0049 - 2102 - 486 1340

MEU-IR (Mitsubishi Electric Europe B.V. Irish Branch)
<http://www.mitsubishi.ie/>

Westgate Business Park, Ballymount, Dublin 24, Ireland
Sales Inquiries
Phone :+353-1-4198807
Fax :+353-1-4198890

Technical Inquiries
Phone :+353-1-4198808
Fax :+353-1-4198895

MEU-IT (Mitsubishi Electric Europe B.V. Italian Branch)
Centro Direzionale Colleoni, Palazzo Sirio, Viale Colleoni 7,
20041 Agrate Brianza, Italy

Sales & Technical Inquiries
Phone :+39-(0)39-60531
Fax :+39-(0)39-6053214
E-mail :info.projector@it.mee.com

MEU-NL (Mitsubishi Electric Europe B.V. Benelux Branch)
<http://www.mitsubishi.nl/LCD/ProdFrame.html>

Nijverheidsweg 23A, 3641 RP Mijdrecht, The Netherlands
Sales Inquiries
Phone :+31-297-282461
Fax :+31-297-283936
E-mail :info@mitsubishi.nl

Technical Inquiries
Phone :+31-297-282461
Fax :+31-297-283936
E-mail :info@mitsubishi.nl

Russia (Mitsubishi Electric Europe B.V Moscow
Representative Office)
<http://www.mitsubishi-projector.ru/>

Moscow Representative Office, 52/5 Kosmodamianskaya
Nab., 115054, Moscow, Russia
Sales & Technical Inquiries
Phone : (7095) 721-2068
Fax : (7095) 721-2071

MEU-USA (Mitsubishi Electric Europe B.V. USA Branch)
25, Boulevard des Bouvets 92 741, Nanterre CEDEX,
France

Sales Inquiries
Phone :+33 (0)1 55-68-55-53
Fax :+33 (0)1 55-68-57-31

Technical Inquiries
Phone :+33 (0)1 55-68-56-42
Fax :+33 (0)1 55-68-57-31

MEU-GER (Mitsubishi Electric Europe B.V. German Branch)
<http://www.mitsubishi-evs.de/>

Gothaer Strasse 8, 40880 Ratingen, Germany
Sales Inquiries
Phone :0049 - 2102 - 486 9250
Fax :0049 - 2102 - 486 7320

Technical Inquiries
Phone :0049 - 2102 - 486 1330
Fax :0049 - 2102 - 486 1340

MEU-IR (Mitsubishi Electric Europe B.V. Irish Branch)
<http://www.mitsubishi.ie/>

Westgate Business Park, Ballymount, Dublin 24, Ireland
Sales Inquiries
Phone :+353-1-4198807
Fax :+353-1-4198890

Technical Inquiries
Phone :+353-1-4198808
Fax :+353-1-4198895

MEU-IT (Mitsubishi Electric Europe B.V. Italian Branch)
Centro Direzionale Colleoni, Palazzo Sirio, Viale Colleoni 7,
20041 Agrate Brianza, Italy

Sales & Technical Inquiries
Phone :+39-(0)39-60531
Fax :+39-(0)39-6053214
E-mail :info.projector@it.mee.com