

# DATA PROJECTOR

XJ-V Series

**XJ-V10X/XJ-V100W/XJ-V110W**

XJ-F Series

**XJ-F10X/XJ-F20XN\*/**

**XJ-F100W/XJ-F200WN\*/**

**XJ-F210WN\***

\*Network Models

## User's Guide

- In this manual, "XJ-V Series" and "XJ-F Series" refer only to the specific models listed above.
- Be sure to read the "Safety Precautions" and "Operating Precautions" in the "Setup Guide" document, and make sure you use this product correctly.
- Keep this manual in a safe place for future reference.
- Visit the site below for the latest version of this manual.  
<http://world.casio.com/manual/projector/>

- DLP is a registered trademark of Texas Instruments of the United States.
- Microsoft, Windows, and Windows Vista are registered trademarks or trademarks of Microsoft Corporation in the United States and other countries.
- HDMI, the HDMI Logo and High-Definition Multimedia Interface are trademarks or registered trademarks of HDMI Licensing, LLC.
- Mac OS is a trademark or registered trademark of Apple, Inc. in the United States and other countries.
- PJLink is a pending trademark or a registered trademark in Japan, the United States, and other countries and areas.
- Crestron is a registered trademark of Crestron Electronics, Inc. of the United States.
- AMX is a registered trademark of AMX LLC of the United States.
- XGA is a registered trademark of IBM Corporation of the United States.
- Other company and product names may be registered trademarks or trademarks of their respective owners.
- Portions of this product are based in part on the work of the Independent JPEG Group.

- The contents of this User's Guide are subject to change without notice.
- Copying of this manual, either in part or its entirety is forbidden. You are allowed to use this manual for your own personal use. Any other use is forbidden without the permission of CASIO COMPUTER CO., LTD.
- CASIO COMPUTER CO., LTD. shall not be held liable for any lost profits or claims from third parties arising out of the use of this product or this manual.
- CASIO COMPUTER CO., LTD. shall not be held liable for any loss or lost profits due to loss of data due to malfunction or maintenance of this product, or any other reason.
- The sample screens shown in this manual are for illustrative purposes only, and may not be exactly the same as the screens actually produced by the product.

# Contents

<b>Useful Features and Functions</b> .....	<b>7</b>
XJ-V10X/XJ-V100W/XJ-V110W .....	7
XJ-F10X/XJ-F100W .....	8
XJ-F20XN/XJ-F200WN/XJ-F210WN (Network Models) .....	9
XJ-V100W/XJ-V110W/XJ-F100W/XJ-F200WN/XJ-F210WN (WXGA Models) .....	9
<b>Getting Ready</b> .....	<b>10</b>
<b>Setting Up the Projector</b> .....	<b>10</b>
Setup Precautions .....	10
<b>Connecting Projector Cables</b> .....	<b>11</b>
<b>Remote Controller</b> .....	<b>12</b>
To load remote controller batteries .....	13
To replace remote controller batteries .....	13
<b>Operating the Projector</b> .....	<b>14</b>
<b>Selecting the Input Source (INPUT)</b> .....	<b>14</b>
To select the input source .....	15
<b>Resolution</b> .....	<b>15</b>
<b>Output Image Operations</b> .....	<b>16</b>
To use manual keystone correction (KEystone) .....	16
To zoom an image (D-ZOOM) .....	16
To momentarily blank the image and mute the audio (BLANK) .....	17
To freeze an image (FREEZE) .....	17
To auto adjust an image (AUTO) .....	17
To change the aspect ratio of the projected image (ASPECT) .....	17
To adjust image brightness (FUNC) .....	19
To change the color mode (FUNC) .....	19
<b>Adjusting the Volume Level (VOLUME)</b> .....	<b>20</b>
To adjust the volume level .....	20
To mute the audio .....	20
<b>Light Control</b> .....	<b>21</b>
To turn light control on or off .....	21
To adjust light output .....	21
To check the power saving level .....	22
To turn the light sensor control on or off (XJ-F Series only) .....	22

<b>Using the Presentation Timer (TIMER)</b> .....	<b>23</b>
To display the timer .....	23
To display the timer function menu .....	23
To configure timer settings.....	24
To start a countdown timer operation .....	24
To pause the timer countdown .....	25
To resume a paused timer countdown.....	25
To reset the timer to its start time .....	25
<b>Using the Setup Menu (MENU)</b> .....	<b>26</b>
Basic Setup Menu Operations.....	26
Setup Menu Settings .....	27
<b>Password Protection</b> .....	<b>32</b>
Using the Password Feature.....	32
To change the password .....	33
To change the power on password setting .....	34
To change the projector internal storage function password (network models only).....	34
<b>Control Panel Lock (XJ-F Series Only)</b> .....	<b>35</b>
To lock the control panel .....	35
To unlock the control panel.....	35

**Projecting from Built-in Memory or USB Input  
(Network Models Only) ..... 36**

<b>Projecting with File Viewer</b> .....	<b>36</b>
File Viewer Overview.....	36
Projecting Files Located in Projector Internal Memory.....	37
To copy files from a computer to projector internal memory.....	37
Starting Projection of Files Located in Projector Internal Memory .....	39
To format projector internal memory (Windows users only) .....	40
Projecting Files from a Memory Device Connected by USB.....	41
To connect a USB flash drive to the projector .....	41
To connect a memory card to the projector .....	41
To connect a digital camera to the projector .....	42
To start projection of files that are on a memory device connected via USB.....	42
Projecting Files .....	45
To project a presentation file.....	45
To project a PDF file .....	46
To project an image file.....	47
To project a movie file.....	47

File Menu Operations.....	49
To toggle the file menu between the list view and icon view .....	49
To scroll the file menu .....	49
To open a folder .....	49
To exit the current folder and move up to the next level .....	49
To return to the main screen from the file menu .....	49
Configuring File Viewer Settings.....	50
To configure File Viewer settings.....	50
Autorun .....	52
To auto project images files or a movie file from a USB flash drive .....	52
To auto project images files or a movie file from projector internal memory .....	53
File Viewer Troubleshooting.....	54
File Viewer Error Messages .....	55
Using EZ-Converter FA to Convert PowerPoint Files to ECA or PtG Files.....	56
To convert a PowerPoint file to an ECA file or PtG file .....	57
To specify the screen resolution of the ECA file or PtG file.....	59
To specify the maximum animation display time.....	59
To play back an ECA file or PtG file on your computer .....	59
<b>Projecting with the USB Display Function .....</b>	<b>61</b>
USB Display Function Overview .....	61
Projecting Computer Screen Contents Over a USB Connection .....	61
To project Windows computer screen contents over a USB connection for the first time.....	62
To project Mac OS computer screen contents over a USB connection for the first time.....	63
To project computer screen contents over a USB connection after the first time .....	65
Projecting the Screen Image of a Graphing Calculator.....	66
To project the screen image of a graphing calculator .....	66
<b>Cleaning the Projector.....</b>	<b>67</b>
Cleaning the Projector Exterior .....	67
Cleaning the Lens.....	67
Cleaning Vents .....	67
<b>Troubleshooting .....</b>	<b>68</b>
Indicators.....	68
Error Indicators and Warning Messages .....	69
Projector Troubleshooting .....	70

<b>Appendix .....</b>	<b>73</b>
Connecting to a Component Video Output.....	73
Connecting to a Composite Video Output or S-Video Output (XJ-F Series Only).....	74
Supplying Power to External Equipment (XJ-F Series Only).....	75
Updating Firmware and Transferring a User Logo .....	76
To update firmware and transfer a user logo.....	76
Hanging the Projector from a Ceiling .....	76
Projection Distance and Screen Size .....	77
Aspect Ratio Setting and Projection Image .....	78
Supported Signals.....	80
Projector RS-232C Control .....	82
To establish a serial connection between the projector and a computer.....	82

# Useful Features and Functions

## XJ-V10X/XJ-V100W/XJ-V110W

- **Mercury-free Hybrid Light Source**

A CASIO-original laser and LED hybrid light source enables high luminance, low power consumption, and low running cost. This projector does not use a mercury lamp, making it environmentally friendly.

- **No-wait Projection**

A CASIO hybrid light source reaches maximum brightness immediately after power is turned on, compared with a wait of approximately one minute normally required with a mercury lamp. The light source will even reach maximum brightness immediately if you turn it back on right after you turn it off. A mercury lamp requires a longer wait in this case to cool down.

- **Quick and simple light adjustment (Instant Light Control)**

A simple key operation instantly adjusts light output to one of seven levels.

- **Support for Three Input Sources**

Analog RGB, component video (Y·Cb·Cr, Y·Pb·Pr), and HDMI input sources are supported.

- **Vertical Keystone Correction**

Manual adjustment to correct for vertical keystone (distortion of the projected image shape caused when projecting from below or above the projection surface) and return the projected image to a rectangular shape.

- **AUDIO OUT Terminal for Audio Output**

Audio input via the projector's HDMI terminal or AUDIO IN terminal is output from its AUDIO OUT terminal. Amped speakers or other equipment can be connected to the AUDIO OUT terminal when you want to output audio from another device via the projector.

- **Ceiling Mounted and Rear Projection Support**

The projector can be configured to project an image of normal orientation even when installed upside down (for ceiling projection) or when projecting from behind the screen.

- **Direct Power On**

The projector can be configured to turn on automatically and start projecting as soon as it is plugged into a power outlet.

- **Firmware update**

Firmware (software in the projector flash ROM) updates can be transferred to the projector from a computer as required.

- **Mercury-free Hybrid Light Source**

A CASIO-original laser and LED hybrid light source enables high luminance, low power consumption, and low running cost. This projector does not use a mercury lamp, making it environmentally friendly.

- **No-wait Projection**

A CASIO hybrid light source reaches maximum brightness immediately after power is turned on, compared with a wait of approximately one minute normally required with a mercury lamp. The light source will even reach maximum brightness immediately if you turn it back on right after you turn it off. A mercury lamp requires a longer wait in this case to cool down.

- **Quick and simple light adjustment (Instant Light Control)**

A simple key operation instantly adjusts light output to one of seven levels.

- **Auto light adjustment using a light sensor (Intelligent Light Control)**

The projector senses surrounding light levels and adjusts light output automatically as required for efficient low-power operation. (Requires “Light Sensor” setting to be set to “On”.)

- **Support for five input sources**

Analog RGB, component video (Y·Cb·Cr, Y·Pb·Pr), HDMI, composite video, and S-video input sources are supported. Two HDMI inputs are provided.

- **Vertical Keystone Correction**

Manual adjustment to correct for vertical keystone (distortion of the projected image shape caused when projecting from below or above the projection surface) and return the projected image to a rectangular shape.

- **Power supply to external equipment**

A 5V DC terminal enables power supply to external equipment.

- **Temporary blanking of projection without cutting power**

Turning off projector power also cuts power being supplied to external equipment. To prevent this, a [BLANK] key lets you temporarily stop projection without interrupting the power supply.

- **16W built-in speaker**

Audio from the input source can be output from the projector’s built-in speaker.

- **Ceiling Mounted and Rear Projection Support**

The projector can be configured to project an image of normal orientation even when installed upside down (for ceiling projection) or when projecting from behind the screen.

- **Direct Power On**

The projector can be configured to turn on automatically and start projecting as soon as it is plugged into a power outlet.

- **Firmware update and user logo image data transfer**

Firmware (software in the projector flash ROM) updates and user logo images can be transferred to the projector from a computer as required.



## XJ-F20XN/XJ-F200WN/XJ-F210WN (Network Models)

---

Network models include all of the features of the XJ-F10X and XJ-F100W (page 8) along with those described below.

- **Projection of image, movie, and other types of files (File Viewer)**

The projector's File Viewer can be used to open and project the following types of files located in projector internal memory or on a USB flash drive connected to the projector: image files (JPG, PNG, GIF, BMP), movie files (AVI, MOV, MP4), presentation files (ECA, PtG), PDF files.

- **Projection of computer screen contents over a USB connection (USB Display)**

Connecting the projector to a computer with a USB cable enables projection of the computer's screen contents. This supports projection of screen contents of even small computers that have only a USB port, but no RGB, HDMI, or other type of video output terminal.

- **Graphic Scientific Function Calculator Connection**

Certain CASIO graphic scientific calculator models can be connected directly to the projector's USB-A port for projection of the calculator screen contents.

- **Power supply to external equipment**

A USB-A/5V DC port (doubles as a USB host port) enables power supply to external equipment.

- **Projection of images from a computer or smart device over a wireless LAN connection\***

The projector is configured as an access point, a computer or smart device can connect directly to it over a wireless LAN connection. Or a computer or smart device can connect over a wireless LAN connection via an existing wireless LAN access point. Both screen output and audio output are supported while a computer is connected.

- **Projector control using a computer or smart device over a wireless LAN connection\***

The projector can be controlled from a computer or smart device connected to it over a wireless LAN connection.

- **Projection of screen contents of a computer connected via wired LAN\***

A LAN cable can be used for a direct connection between the projector and a computer, or a LAN connection can be established via an existing network router. Once a connection is established, both screen output and audio output are supported.

- **Remote control of the projector from a computer connected via wired LAN\***

Projector control operations can be performed remotely using the web browser of a computer connected via a wired LAN connection.

\* For details about LAN connection, see the separate "Network Function Guide".

## XJ-V100W/XJ-V110W/XJ-F100W/XJ-F200WN/XJ-F210WN (WXGA Models)

---

- **WXGA Resolution**

Supports WXGA (1280 × 800) wide-screen projection resolution. This resolution is ideal for projecting wide-screen notebook computer and HD TV images.

# Getting Ready

This section explains how to select a location for the projector, how to connect its cables, and how to perform other operations required before using it.

## Setting Up the Projector

Locate the projector on a desk, table, or stand that is firm and level. Make sure that you allow sufficient space around the sides and back of the projector for proper ventilation. The illustrations below show how the projector should be oriented relative to the screen for optimum projection.

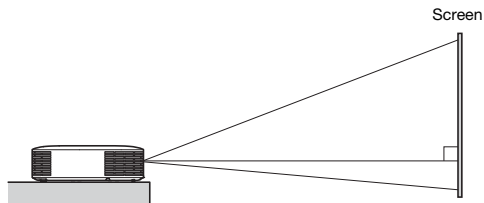

Make sure the projector is at a right angle to the screen.

## Setup Precautions

- Use a conveniently located power outlet that you can reach easily when you need to unplug the projector.
- Do not locate any objects within 30 cm (11.8 inches) around the projector. Particular care is required to keep objects away from projector air intake and exhaust openings.
- Airflow from air conditioning equipment can blow the heat being exhausted from the area around the projector's lens in a way that causes heat ripples to appear in the projected image. If this happens, adjust the airflow of the air conditioning equipment or move the projector.

# Connecting Projector Cables

Connect the projector to a power outlet and to an input source device.

## XJ-V Series

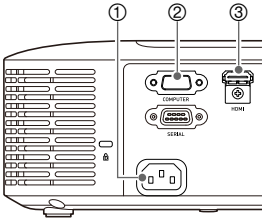

## XJ-F Series

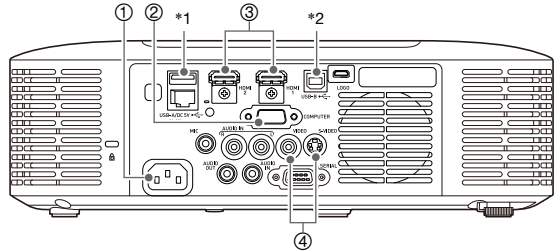

Some of the terminals shown in the illustration are not equipped on the XJ-F10X and XJ-F100W.

- ① Use the provided power cord to plug the projector into a power outlet.
  - ② Use an RGB cable to connect to the RGB output terminal of a computer or other input source.
  - ③ Use an HDMI cable to connect to the HDMI output terminal of a computer, video equipment, or other input source. Be sure to use a High Speed HDMI cable for connection.  
The XJ-F Series models have two HDMI input terminals, which means you can have two external HDMI devices connected at the same time.
  - ④ Connect to the composite output or S-Video output of the video device. For details, see “Connecting to a Composite Video Output or S-Video Output (XJ-F Series Only)” (page 74).
- \*1 This port can be used to supply power (up to 5V DC 2A) to external equipment. For details, see “Supplying Power to External Equipment (XJ-F Series Only)” (page 75).  
With the XJ-F20XN, XJ-F200WN, and XJ-F210WN projectors (network models), a USB flash drive (page 41), a CASIO calculator (page 66), or a separately available wireless adapter (refer to the separate “Network Function Guide”) can be connected to this port as an input source for projection.
- \*2 This port is equipped on the XJ-F20XN, XJ-F200WN, XJ-F210WN (network models) only. It is used when accessing projector internal memory from a computer and when projecting computer screen contents from the projector over a USB connection. For details, see “To copy files from a computer to projector internal memory” (page 37) and “Projecting with the USB Display Function” (page 61).



### Note

- For more information about component video connection, see “Connecting to a Component Video Output” on page 73.
- For information about how to connect for RS-232C control of the projector, see “Projector RS-232C Control” (page 82).
- For information about how to connect in order to update the projector firmware or to transfer user logo data, see “Updating Firmware and Transferring a User Logo” (page 76).

# Remote Controller

Projector operations are performed using the remote controller that comes with it. Point the remote controller signal emitter at one of the signal receivers on the projector as you perform remote controller key operations. The maximum range of the remote controller signal is approximately 5 meters (16.4 feet) (between signal emitter and receiver).

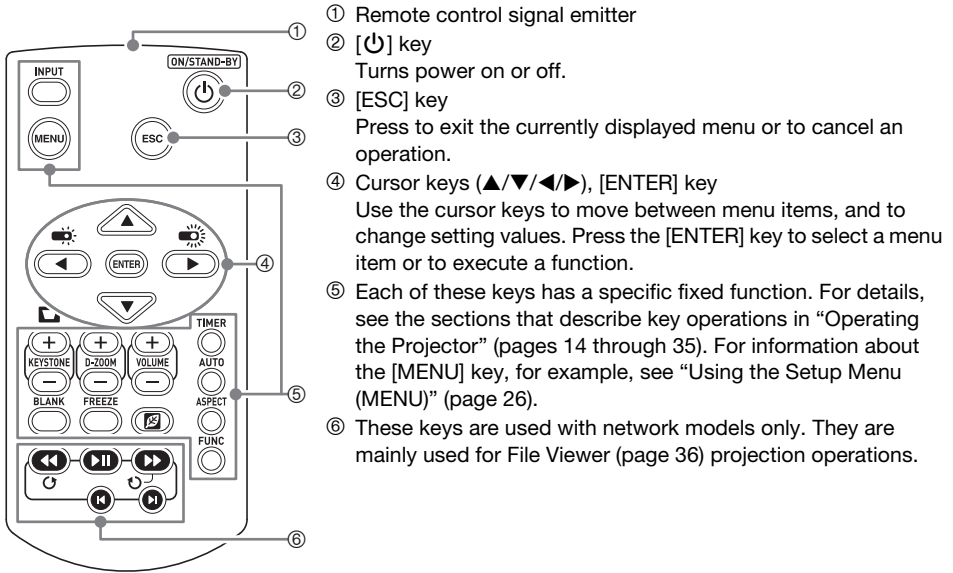

## Important!

- To avoid running down the batteries, store the remote control unit so its keys are not pressed inadvertently.

## To load remote controller batteries



### Important!

- Be sure to use alkaline batteries only.



### Caution

RISK OF EXPLOSION IF BATTERY IS REPLACED BY AN INCORRECT TYPE.  
DISPOSE OF USED BATTERIES ACCORDING TO THE INSTRUCTIONS.

1. Open the battery cover on the back of the remote controller.

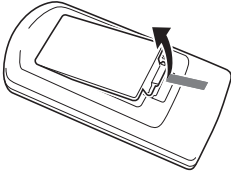

2. Load two new batteries into the case, making sure that their positive (+) and negative (-) ends are facing correctly.

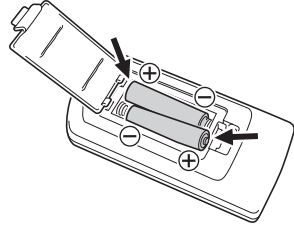

3. Close the battery cover on the back of the remote controller.

## To replace remote controller batteries

Open the battery cover on the back of the remote controller, replace the old batteries with new ones, and then close the battery cover.

# Operating the Projector

Unless specifically noted otherwise, the operations in this section are performed using the remote controller. If both the projector and the remote controller have the same key, either one can be used to perform the corresponding operation.

## Selecting the Input Source (INPUT)

The tables below show the input sources that can be selected for each projector model.

### XJ-V Series

Input Source Name	Output Projection Image (and Audio)
Computer (RGB or Component)	Images and audio from a computer or video device connected to the projector's COMPUTER terminal and AUDIO IN terminal.
HDMI	Images and audio from a computer or video device connected to the projector's HDMI terminal.

### XJ-F Series

Input Source Name	Output Projection Image (and Audio)
Computer (RGB or Component)	Images and audio from a computer or video device connected to the projector's COMPUTER terminal and AUDIO IN terminal.
S-Video	Images and audio from a video device connected to the projector's S-VIDEO terminal and AUDIO IN R/L terminals.
Video	Images and audio from a video device connected to the projector's VIDEO terminal and AUDIO IN R/L terminals.
HDMI1	Images and audio from a computer or video device connected to the projector's HDMI 1 terminal.
HDMI2	Images and audio from a computer or video device connected to the projector's HDMI 2 terminal.
File Viewer*	Images (and audio in the case of a movie file) contained in the following types of files located in projector internal memory or on a memory device connected to the projector's USB-A port: image files, movie files, presentation files, PDF files.
CASIO USB Tool*	Screen contents of a CASIO calculator or electronic dictionary connected to the projector's USB-A port.
Network*	Screen contents and audio of a computer connected to the projector via wireless LAN or wired LAN.
USB Display*	Screen contents and audio of a computer connected to the projector's USB-B port.

\* Network models only

## To select the input source

1. Press the [INPUT] key.
2. On the “Input” dialog box that appears, use the [INPUT], [▲] and [▼] keys to select the input source you want and then press the [ENTER] key.
  - If you do not press the [ENTER] key, the projector will automatically apply the currently selected input source after about three seconds.
  - The name of the input source you selected will appear in the upper right corner of the projection screen for a few seconds.
  - The message “No signal input” will appear if no input signal can be detected.



### Note

---

- For more information about the operation required to select “Network”, “USB Display”, “File Viewer”, or “CASIO USB Tool” as the input source and perform projection, refer to the following.

Network: Separate Network Function Guide

USB Display: “Projecting with the USB Display Function” (page 61)

File Viewer: “Projecting with File Viewer” (page 36)

CASIO USB Tool: “Projecting the Screen Image of a Graphing Calculator” (page 66)

## Resolution

---

Depending on the projector model, its video resolution will be fixed at XGA (1024 × 768 pixels) or WXGA (1280 × 800 pixels). Images may appear coarse, text and other figures may be difficult to read or a moire pattern may appear when the input signal from a computer does not match the projector’s video resolution. If this happens, try doing the following.

- Change the computer’s output resolution setting so it matches the projector’s video resolution. For information about the video resolution of your projector, see “Specifications” in the Setup Guide. See the user documentation that comes with your computer for details about changing its settings.
- Change the “Aspect Ratio” setting to “True” (Applies only to models that support WXGA video resolution). With the “True” setting, the projector projects the input signal at its actual size (1 input source dot equal to one projector output pixel dot). For information about configuring the Aspect Ratio setting, see “To change the aspect ratio of the projected image (ASPECT)” (page 17).

# Output Image Operations

## To use manual keystone correction (KEYSTONE)

Use the [KEYSTONE +] and [KEYSTONE -] keys to adjust keystone correction manually.

- The projector has a keystone correction feature that detects when it is at a vertical angle to the screen and performs keystone correction automatically. Use the above to make adjustment manually when auto correction produces results that are not what you want.

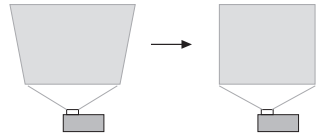

### Note

- If there is no menu, dialog box, or anything else displayed on the projection screen with an XJ-F Series projector, you can also use the projector's [▲] and [▼] keys to perform manual keystone correction.

## To zoom an image (D-ZOOM)

- 1. Press the [D-ZOOM +] key.**
  - This will enlarge the center of the projected image one step.
- 2. To zoom in on the center of the projected image more, press the [D-ZOOM +] key again. To zoom out, press the [D-ZOOM -] key.**
  - Each press of [D-ZOOM +] zooms in (increases the zoom factor), while [D-ZOOM -] zooms out. Holding down either key continuously scrolls the zoom factor.
- 3. While an image is zoomed, use the [▲], [▼], [◀], and [▶] keys to scroll the view to other parts of the image.**
- 4. To exit the zoom operation, press the [ESC] key.**



# To momentarily blank the image and mute the audio (BLANK)

## 1. Press the [BLANK] key.

- This blanks the screen by displaying the blank screen image specified by the Setup Menu “Blank Screen” setting (page 28) and mutes the audio.

## 2. To resume normal image and sound, press the [BLANK] key (or [ESC] key).

# To freeze an image (FREEZE)

Press the [FREEZE] key to freeze the current input source image. To return to the real-time input source image, press the [FREEZE] key again or press the [ESC] key.

# To auto adjust an image (AUTO)

Press the [AUTO] key.

- Pressing the [AUTO] key automatically adjusts the frequency and phase in accordance with the input signal, which can reduce flickering and other projected image problems.
- This operation is supported while the input source is Computer (RGB).

# To change the aspect ratio of the projected image (ASPECT)

Press the [ASPECT] key to cycle through the aspect ratio settings for the projected image.

Available settings depend on your projector model as shown below.

## XJ-V100W/XJ-V110W/XJ-F100W/XJ-F200WN/XJ-F210WN

Pressing the [ASPECT] key will cycle through settings in accordance with the current input source as shown below.

Input Source	Pressing the [ASPECT] key will cycle through these settings:
RGB, HDMI(PC)	Normal → Full → 16:9 → 4:3 → True
Video*, S-Video*, Component, HDMI(DTV)	Normal → 16:9 → 16:10 → 4:3 → Letter Box

\* XJ-F100W/XJ-F200WN/XJ-F210WN only

## XJ-V10X/XJ-F10X/XJ-F20XN

Pressing the [ASPECT] key will cycle through settings in accordance with the current input source as shown below.

Input Source	Pressing the [ASPECT] key will toggle between these settings:
RGB, HDMI(PC)	Normal → Full → 16:9 → 16:10
Video*, S-Video*, Component, HDMI(DTV)	Normal → 16:9 → 16:10 → 4:3

\* XJ-F10X/XJ-F20XN only

## Description of Each Setting

**Normal:** Projects at the projector's maximum possible size while maintaining the input signal aspect ratio.

**Full:** Projects at the projector's maximum possible size by enlarging or reducing the input signal.

**16:9:** This setting specifies a 16:9 aspect ratio, which is the same as a movie screen, high-definition TV, etc. Using this setting when the input signal is a 16:9 image that has been squeezed to a 4:3 image causes the image to be displayed with its normal 16:9 aspect ratio.

**16:10:** This setting specifies a 16:10 aspect ratio. Use this setting to adjust the image for projection onto a 16:10 aspect ratio screen.

**4:3:** Regardless of the input signal aspect ratio, the image is always resized to an aspect ratio of 4:3 for projection.

**True:** Projects the input signal at its actual size (1 input source dot equal to one projector output pixel dot) in the center of the projector's projection screen. If the input signal resolution exceeds the projector's output resolution, the excess is cut off.

**Letter Box:** This will resize the image horizontally to 1280 dots and project 800 vertical dots of the center of the image, maintaining the aspect ratio of the input signal.



---

### Note

- For details about how the aspect ratio setting affects the projected image, see "Aspect Ratio Setting and Projection Image" (page 78).
- When projecting while "True" is selected as the aspect ratio setting for an RGB signal with a resolution that is less than SVGA, the image is enlarged to SVGA and projected.
- You can also change the aspect ratio using the Setup Menu "Screen Settings → Aspect Ratio" setting (page 28).



---

### Important!

- Note that enlarging or reducing the size of an image using the [ASPECT] key for commercial purposes or public presentation may infringe on the legally protected copyright of the copyright holder of the original material.

## To adjust image brightness (FUNC)

1. Press the [FUNC] key. On the menu that appears, select “Brightness” and then press the [ENTER] key.
2. On the brightness adjustment screen that appears, use the [◀] and [▶] keys to adjust brightness.
3. To hide the window, press the [ESC] key.



---

### Note

- The above operation is for fine adjusting image brightness without affecting light brightness. For information about changing light brightness, see “Light Control” (page 21).

## To change the color mode (FUNC)

1. Press the [FUNC] key. On the menu that appears, select “Color Mode” and then press the [ENTER] key.
  - This displays the color mode selection window. The currently selected color mode is the one whose button is selected (filled in).
2. Use the [▼] and [▲] keys to move the highlighting to the color mode you want to select, and then press the [ENTER] key.
  - This will select the button next to the highlighted color mode name.
  - For details on what each color mode does, see “Image Adjustment 1 → Color Mode” (page 27).
3. To hide the window, press the [ESC] key.



---

### Important!

- The color mode cannot be selected in the following cases.
  - When “Off” is selected for the “Light Control” setting (page 21)

## Adjusting the Volume Level (VOLUME)

Use the procedure below to adjust the volume level of the projector's speaker output, and output from the AUDIO OUT terminal. If your projector does not have a built-in speaker, only AUDIO OUT terminal output is affected.

### To adjust the volume level

- 1. Press the [VOLUME +] or [VOLUME -] key.**
  - This causes the "Volume" screen to appear on the projected image.
- 2. Press the [VOLUME +] key to increase the volume, or the [VOLUME -] key to lower the volume.**
- 3. After the setting is the way you want, press the [ESC] key.**

### To mute the audio

- 1. Press the [VOLUME +] or [VOLUME -] key to display the "Volume" screen.**
- 2. Press the [ENTER] key.**
  - This stops output from the speaker.
- 3. To restore the audio, press the [VOLUME +] or [VOLUME -] key.**

# Light Control

Light Control lets you adjust the light being output (light source brightness) by the projector. When “On” is selected for “Light Control” on the Setup Menu (initial default setting), light output can be adjusted to one of seven levels.

With the XJ-F Series, selecting “On” for the Setup Menu “Light Sensor” setting will cause light output to be adjusted automatically in accordance with currently available light.



---

## Note

- To project at maximum light source brightness, select “Off” for the “Light Control” setting on the Setup Menu. This also disables changes in light output. With the XJ-F Series, this also disables the light sensor.

## To turn light control on or off

1. Press the [MENU] key to display the Setup Menu.
2. Use the [▼] key to select “Option Settings 1”, and then press the [ENTER] key.
3. Use the [▼] key to select “Light Control” and then press the [ENTER] key.
  - This displays a light control dialog box.
4. Use the [▼] key to select “Light Control” and then press the [◀] key to select “On” or the [▶] key to select “Off”.
5. Press the [ESC] key to exit the Setup Menu.

## To adjust light output

1. While there is no menu, dialog box, or anything else displayed on the projection screen, press the [◀] or [▶] key.
  - Pressing the [◀] key lower light output by 1, while pressing [▶] increases it by 1. Pressing either key also displays a light output dialog box that shows the current light output setting as a value from 1 to 7.
2. You can use [◀] and [▶] to further adjust light output while the dialog box is displayed.
3. When the brightness is the level you want, press the [ESC] key to exit the dialog box.
  - The dialog box will disappear automatically if you do not perform any key operation for about five seconds.



---

## Note

- The above operation cannot be performed while “Off” is selected for the “Light Control” setting on the Setup Menu.

## To check the power saving level

1. Press the  key.
  - This displays a light control dialog box. The current power saving level is indicated by leaf (🌿) marks at the top of the dialog box. The more leaf marks there are, the higher the power saving level.
  - At this time you can adjust the light output level using the [◀] and [▶] keys.
2. To close the dialog box, press the [ESC] key.



---

### Note

- The above operation cannot be performed while “Off” is selected for the “Light Control” setting on the Setup Menu.

## To turn the light sensor control on or off (XJ-F Series only)

1. Press the [MENU] key to display the Setup Menu.
2. Use the [▼] key to select “Option Settings 1”, and then press the [ENTER] key.
3. Use the [▼] key to select “Light Control” and then press the [ENTER] key.
  - This displays a light control dialog box.
4. Use the [▼] key to select “Light Sensor” and then press the [◀] key to select “On” or the [▶] key to select “Off”.
5. Press the [ESC] key to exit the Setup Menu.

## Using the Presentation Timer (TIMER)

The presentation timer shows a countdown from a preset time value. You can use it to keep track of how much time has elapsed during your presentation, and to limit a presentation to a preset amount of time. You can configure the presentation timer so it is displayed in the projected image.



### To display the timer

When the timer is not displayed on the projected image, press the [TIMER] key once.

The timer will appear for about five seconds and then disappear automatically if the “Off” is selected for the “Continuous Display” setting on the timer function menu.

### To display the timer function menu

When the timer is not displayed on the projected image, press the [TIMER] key twice. If the timer is displayed, press the [TIMER] key once.

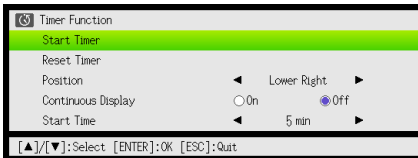

Use this menu to start, pause, resume, and reset the timer, and to configure various timer settings.

## To configure timer settings

1. Use the [TIMER] key to display the timer function menu.
2. Use the [▼] and [▲] keys to select the “Position”, “Continuous Display”, or “Start Time” setting and then change the settings as described in the table below.

To do this:	Perform this operation:
Reposition the timer on the projected image	Select “Position”, and then use the [◀] and [▶] keys to select one of the following settings: “Lower Right”, “Upper Right”, “Upper Left”, “Lower Left” (Initial default: Lower Right).
Enable or disable continuous display of the timer	Select “Continuous Display”, and then use the [◀] and [▶] keys to select either “On” or “Off” (Initial default: Off). On: Once the timer is displayed, it remains displayed until you display a different dialog box or you press the [ESC] key. Off: The timer automatically disappears about five seconds after it is displayed.
Specify the timer countdown start time	Select “Start Time”, and then use the [◀] and [▶] keys to specify the countdown start time you want. You can set a start time from five to 60 minutes, in five-minute steps (Initial default: 20 minutes).

3. To save your settings and close the timer function menu, press [ESC].
  - To start the timer immediately after changing its settings, use [▼] and [▲] to select “Start Timer” on the timer function menu and then press the [ENTER] key before pressing [ESC] in the step above.

## To start a countdown timer operation

1. Use the [TIMER] key to display the timer function menu.
2. Select “Start Timer” and then press the [ENTER] key.
  - This will close the timer function menu and start the timer countdown.
  - After the countdown reaches 00:00, it will start a 60-minute count up operation (from –00:01 to –60:00). The numerals of the timer display are red (indicating that the presentation is over time) during a count up operation.



## To pause the timer countdown

1. Use the [TIMER] key to display the timer function menu.
2. Select “Pause Timer” and then press the [ENTER] key.

## To resume a paused timer countdown

1. Use the [TIMER] key to display the timer function menu.
2. Select “Restart Timer” and then press the [ENTER] key.

## To reset the timer to its start time

1. Use the [TIMER] key to display the timer function menu.
2. Select “Reset Timer” and then press the [ENTER] key.
  - This will reset the time to the “Start Time” setting.

# Using the Setup Menu (MENU)

Pressing the [MENU] key displays the Setup Menu shown below on the projection screen. You can use this menu to adjust projected image brightness, contrast, and other settings, and to change projector settings.

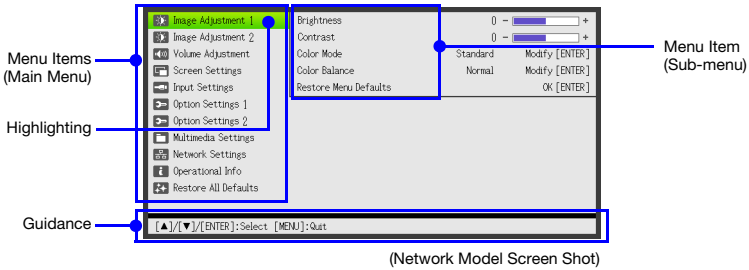

The guidance shows the key operations that can be performed for the currently selected (highlighted) menu item.

## Basic Setup Menu Operations



To do this:	Perform this operation:
Display the Setup Menu Exit the Setup Menu	Press the [MENU] key. Pressing the [MENU] key to exit the Setup Menu will save the settings you configured while it was displayed.
Select a menu item	Use the [▲] and [▼] keys to move the highlighting to the menu that contains the menu item you want to select and then press the [ENTER] key. Next, use the [▲] and [▼] keys to move the highlighting to the menu item you want to select.
Configure the setting of a menu item	<ul style="list-style-type: none"> <li>● If a menu item that has options or setting values to the right, use the [◀] and [▶] keys to change the setting.</li> <li>● For a menu item that has "Modify[ENTER]" or "OK[ENTER]" to the right, press the [ENTER] key to display a dialog box for configuring the setting.</li> </ul>

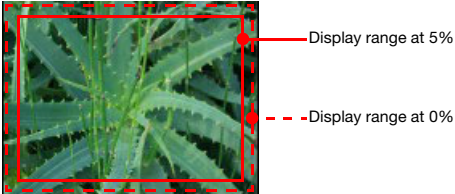

## Setup Menu Settings

- One or more letters (such as RCV) after the menu item name indicates an item that is available only when one or more particular input source is selected. The letters indicate the input source(s) where the menu item is available.  
**R:** RGB input, **C:** Component input, **V:** S-video input\*<sup>1</sup> or Video input\*<sup>1</sup>, **H:** HDMI (PC) input, **D:** HDMI (DTV) input, **F:** File Viewer\*<sup>2</sup>, **T:** CASIO USB Tool\*<sup>2</sup>, **N:** Network\*<sup>2</sup>, **U:** USB Display\*<sup>2</sup>  
\*<sup>1</sup> XJ-F Series projectors only    \*<sup>2</sup> Network model projectors only
- A menu item that does not have any letter after it will be available regardless of the input source.
- **F** after a menu item indicates the item is available only on XJ-F Series projectors.
- **N** after a menu item indicates the item is available only on network model projectors.
- The initial default setting is indicated by an asterisk (\*).

Use this menu item:	To do this:
Image Adjustment 1 → Brightness	Adjust projected image brightness.
Image Adjustment 1 → Contrast	Adjust projected image contrast.
Image Adjustment 1 → Sharpness (V) <b>F</b>	Use this sub-menu to adjust the sharpness of the outlines in the projected image. A larger value makes the image sharper, while a smaller value makes it softer.
Image Adjustment 1 → Saturation (V) <b>F</b>	Use this sub-menu to adjust the color saturation of the projected image. A larger value increases color saturation.
Image Adjustment 1 → Tint (V) <b>F</b>	Use this sub-menu to adjust the tint of the projected image. A larger value makes the overall image more bluish, while a smaller value makes the overall image more reddish. This setting is supported only when the signal is NTSC or NTSC4.43.
Image Adjustment 1 → Color Mode	Select one of the following projected image color modes: "Standard*", "Graphics", "Theater*", "Blackboard", "Natural".   <b>Note</b> <ul style="list-style-type: none"> <li>● Initial default setting: "Theater" when the input source is S-Video, Video, or HDMI (DTV). "Standard" any other time.</li> </ul>
Image Adjustment 1 → Color Balance	Select one of the following color balance presets: "Warm", "Normal*", "Cold". Also can be used to separately adjust red, green, and blue.
Image Adjustment 1 → Light Control Off Mode	When "Off" is selected for the "Option Settings 1 → Light Control → Light Control" setting, specify either "Bright" (brightness priority) or "Normal*" (hue priority) as the image quality setting.
Image Adjustment 1 → Restore Menu Defaults	Return all of the items in the "Image Adjustment 1" main menu to their initial defaults for the currently projecting image source.
Image Adjustment 2 → Vertical Position (RCV)	Adjust the vertical and horizontal positions of the input source image in relation to the target screen.
Image Adjustment 2 → Horizontal Position (RCV)	
Image Adjustment 2 → Frequency (R)	When vertical bands appear in the projected image while RGB is selected as the input source, it means that the frequency setting is not correct. When this happens, use this setting to adjust the frequency manually. If, for some reason, your manual frequency settings cause the image input from the computer to disappear from the projection, you can press the [AUTO] key to perform an auto adjust operation, which should cause the image to appear.
Image Adjustment 2 → Phase (R)	Adjust the phase of the RGB input signal when the image flickers because the projector phase and RGB input signal phase do not match.

Use this menu item:	To do this:
Image Adjustment 2 → Overscan (CVD)	<p>Adjust the overscan amount for an input video signal within the range of 0% to 5%*. The size of the border area displayed on the projection screen depends on the setting value. A smaller value results in a wider border area as shown below.</p>  <p>— Display range at 5% - - - Display range at 0%</p>
Image Adjustment 2 → Restore Menu Defaults (RCVD)	Return all of the items in the “Image Adjustment 2” main menu to their initial defaults for the currently projecting image source.
Volume Adjustment → Volume	See “Adjusting the Volume Level (VOLUME)” (page 20) for more information.
Volume Adjustment → Restore Menu Defaults	Return the Volume setting to its initial default for the currently projecting image source.
Screen Settings → Keystone Correction	Use this sub-menu to perform vertical keystone correction of the projected image.
Screen Settings → Aspect Ratio (RCVHD)	Select an aspect ratio setting for the projected image. See “To change the aspect ratio of the projected image (ASPECT)” (page 17) for more information.
Screen Settings → Projection Mode	Specify whether projection will be from the front of the screen or the back of the screen. Front*: Select this option to project from the front of the screen. Rear: Select this option to project from the back of the screen. This setting flips the front projected image horizontally.
Screen Settings → Ceiling Mount	Set up the projector to be positioned upside down for hanging from a ceiling. On: Select when the projector is positioned upside down for hanging from a ceiling. Since the bottom of the projector is upwards, the projected image is flipped both horizontally and vertically. Off*: Select when the projector is used on a desktop. This projects the image assuming that the top of the projector is upwards.
Screen Settings → No Signal Screen	Select one of the following as the projection image whenever there is no input signal being input to the projector: “Blue”* (blue screen), “Black” (black screen), “Logo” (projector built-in logo, or user logo, page 76).
Screen Settings → Blank Screen	Select one of the following as the projection image whenever the [BLANK] key is pressed: “Blue”* (blue screen), “Black” (black screen), “Logo” (projector built-in logo, or user logo, page 76).
Screen Settings → Restore Menu Defaults	Return all of the items in the “Screen Settings” main menu to their initial defaults for the currently projecting image source.
Input Settings → COMPUTER Terminal (RC)	Specify the method to be used to identify the COMPUTER terminal input signal. Auto*: Projector automatically identifies the COMPUTER terminal input signal. RGB: Always assumes the COMPUTER terminal input signal is an RGB signal. Component: Always assumes the COMPUTER terminal input signal is a component video signal.
Input Settings → RGB Level Adjust (RC)	Specifies whether level adjustment of the input RGB signal is enabled (On*) or disabled (Off). Leaving this setting “On” will normally optimize the projected image. However, depending on the input signal, there may be cases when this setting does not optimize the image and may even distort it. If this happens, change this setting to “Off”.

Use this menu item:	To do this:
Input Settings → Video Signal (V) <b>F</b> Input Settings → S-Video Signal (V) <b>F</b>	Specify the method to be used to identify the VIDEO terminal input signal. Auto*: Projector automatically identifies the video input signal. NTSC, NTSC4.43, PAL, PAL-M, PAL-N, PAL60, SECAM: Always assumes the video input signal is the specified video signal type.
Input Settings → Signal Name Indicator	Specify whether the newly selected input signal type should be displayed (On*) or not displayed (Off) when the [INPUT] key is pressed to change the input signal.
Input Settings → Restore Menu Defaults	Return all of the items in the “Input Settings” main menu to their initial defaults for the currently projecting image source.
Option Settings 1 → Auto Keystone Correction	Turn auto keystone correction on (On*) or off (Off).   <b>Note</b> <ul style="list-style-type: none"> <li>This item cannot be selected while “On” is selected for “Screen Settings → Ceiling Mount”, and “Auto Keystone Correction” is disabled regardless of the setting of this item.</li> </ul>
Option Settings 1 → Auto Adjust (R)	Specify whether the projector should detect the RGB input signal type (resolution, frequency) and adjust the projection image accordingly. On*: Auto Adjust enabled. Off: Auto Adjust disabled.   <b>Note</b> <ul style="list-style-type: none"> <li>If you want to retain the following “Image Adjustment 2” menu settings when power is turned off, select “Off” for this setting: “Vertical Position”, “Horizontal Position”, “Frequency”, “Phase”.</li> </ul>
Option Settings 1 → Light Control	See “Light Control” (page 21).
Option Settings 1 → Auto Power Off	Specify the amount of time of projector operation and input signal inactivity to be allowed before Auto Power Off is triggered to turn off projector power automatically. Auto Power Off can be disabled, if you want. 5 min, 10 min*, 15 min, 20 min, 30 min: Time until Auto Power off is triggered. Off: Disables Auto Power Off.
Option Settings 1 → Password	See “Password Protection” (page 32).
Option Settings 1 → Direct Power On	Enable (On) and disable (Off*) projector auto power on as soon as the projector’s AC adapter is plugged into a power outlet.
Option Settings 1 → Language	Specify the display language. English, French, German, Italian, Spanish, Swedish, Portuguese, Dutch, Norwegian, Polish, Finnish, Czech, Turkish, Russian, Lithuanian, Vietnamese, Thai, Malay, Indonesian, Arabic, Chinese (Simplified), Chinese (Traditional), Korean, Japanese   <b>Important!</b> <ul style="list-style-type: none"> <li>Network Model Users              When using certain Network model functions, some menus and messages may be displayed in English, regardless of the language selected here.</li> </ul>
Option Settings 1 → Restore Menu Defaults	Return all of the items in the “Option Settings 1” main menu to their initial defaults for the currently projecting image source.
Option Settings 2 → Plug and Play <b>N</b>	Specify what the projector should do when a supported external USB device is connected to the projector’s USB-A port or when the projector is turned on while an external USB device is connected to the USB-A port. On: Enables automatic input source switching. Off*: Disables automatic input source switching.

Use this menu item:	To do this:
Option Settings 2 → Audio Out <b>F</b>	Use this sub-menu to specify whether audio input from the input sources below should be output to the speaker (Speaker*) or output to an external destination (Line)*1. <ul style="list-style-type: none"> <li>● HDMI</li> <li>● File Viewer (Movie playback audio)*2</li> <li>● Wireless or Network (Video stream projection movie audio)*2</li> <li>● USB Display*2</li> </ul> *1 When Line is specified, the projector will output audio from its AUDIO OUT terminal. *2 Network models only
Option Settings 2 → High Altitude	Turn the high-altitude fan speed setting on or off in accordance with the altitude of the area where you are using the projector. On: Select this setting when using the projector in a high altitude (1,500 to 3,000 meters / 5,000 to 10,000 feet above sea level) area where air is thin. This setting increases cooling efficiency. Off*: Select this setting at normal altitudes (up to 1,500 meters / 5,000 feet).  <b>Important!</b> <ul style="list-style-type: none"> <li>● Do not use this projector at altitudes greater than 3,000 meters (10,000 feet) above sea level.</li> </ul>
Option Settings 2 → Control Panel Lock <b>F</b>	Disable projector unit key operations. See “Control Panel Lock (XJ-F Series Only)” (page 35) for more information.
Option Settings 2 → Closed Caption (V) <b>F</b>	Use this sub-menu to specify whether to display closed captions when projecting a video signal that includes them. Off*: Closed captions not displayed. CC1, CC2, CC3, CC4: Indicates the current closed caption output setting (CC1, CC2, CC3, and CC4).  <b>Note</b> <ul style="list-style-type: none"> <li>● Keystone correction does not affect displayed closed caption text.</li> </ul>
Option Settings 2 → Timer Function	Display the timer function menu. For details, see “Using the Presentation Timer (TIMER)” (page 23).
Option Settings 2 → Microphone Input Level <b>N</b>	Adjusts the volume level of audio input from the MIC terminal within the range of 0* (mute) to 3 (maximum).
Option Settings 2 → Restore Menu Defaults	Return all of the items in the “Option Settings 2” main menu to their initial defaults for the currently projecting image source.
Multimedia Settings → Autorun <b>N</b>	Specify whether to use (Enable*) or not use (Disable) the autorun function. For details, see “Autorun” (page 52).
Multimedia Settings → Functions <b>N</b> (FN)	Display the same menu (Function Menu) that appears when the remote controller’s [FUNC] key is pressed.
Multimedia Settings → Internal Storage Function <b>N</b> (RCVHD)	Access projector internal memory from a computer. For details, see “To copy files from a computer to projector internal memory” (page 37).
Network Settings <b>N</b>	Access projector wireless LAN connection setting and network setting items. For details, see the separate “Network Function Guide”.
Operational Info	Display the projector information below. Input Signal, Signal Name, Resolution, Horizontal Frequency, Vertical Frequency, Scan System, Light Time, Version (projector ROM version)
Restore All Defaults → Unit Operating Time	Display the cumulative operating time of this unit. This time cannot be initialized.

Use this menu item:	To do this:
Restore All Defaults → Restore All Defaults	<p>Initialize all Setup Menu item settings, except for those below.            Option Settings 1 → Language, Option Settings 1 → Power On Password,            Operational Info → Light Time, Operational Info → Version,            Restore All Defaults → Unit Operating Time</p> <p> <b>Note</b> _____</p> <ul style="list-style-type: none"> <li>● A user logo image that has been transferred to the projector (page 76) is not deleted by a “Restore All Defaults” operation.</li> </ul>

# Password Protection

The operations described below can be password protected on the projector. You can have only one password assigned to the projector at any time, and the same password is used for operations.

## ● Projector startup protection

The projector can be configured so a dialog box prompting input of the password is displayed whenever the projector is turned on. In this case, further operation of the projector is not possible unless the correct password is input. This protects against unauthorized use of the projector.

## ● Using projector internal storage (network models only)

Attempting to access the projector internal storage function (page 37) from the Setup Menu causes a password input dialog box to appear. This protects against inadvertent and unauthorized deletion or replacement of files in projector internal memory.

Use the “Power On Password” and “Internal Storage Password” settings to turn password protection for the above operations on or off individually.

## Using the Password Feature

Note the following precautions whenever you use the password feature.

- The password feature protects against unauthorized use of the projector. Note that it is not an anti-theft measure.
- You will need to enter the initial factory default password the first time you use the projector after turning on the password feature. Change the initial factory default password to a different one of your choice as soon as possible after turning on the password feature.
- Remember that password operations are always performed using the remote controller, so you should take care not to lose or misplace the remote controller.
- Also note that you will not be able to input the password if the remote controller batteries are dead. Replace the remote control batteries as soon as possible after it starts to go low.

## If you forget your password...

If you forget the password, you will need to bring the following two items to your CASIO distributor to have the password cleared. Note that you will be charged to have the password cleared.

1. Personal identification (original or copy of your driver’s license, employee I.D., etc.)
2. Projector unit

Note that your CASIO distributor will not be able to clear the password of your projector unless you bring both of the items listed above.

Also, keep the projector’s warranty in a safe place.



### Important!

- Having your password cleared using the procedure described above will return all of the settings of your projector, except for the Light Time, to their initial factory defaults.

## Keep a written record of your password!

You will not be able to use the projector if you forget its password. We strongly suggest that you keep a written or other type of record of the password so you can look it up when necessary.



## To change the password

1. Press the [MENU] key to display the setup menu.
2. Use the [▼] key to select “Option Settings 1”, and then press the [ENTER] key.
3. Use the [▼] key to select “Password”, and then press the [ENTER] key.
  - This will display a dialog box prompting you to enter the current password.
4. Enter the current password.
  - The password of your projector is not really a “word” made up of letters, but rather a sequence of remote controller key inputs.
  - If the projector is still protected by the factory default password, perform the key operation shown below to enter it.



5. After entering the current password, press the [ENTER] key.
  - This displays the Password screen.
6. Use the [▼] key to select “Change Password”, and then press the [ENTER] key.
  - This will display a dialog box prompting you to enter the new password.
7. Enter a key sequence up to eight key operations long.
  - You can use any of the following keys as part of your password key sequence. [INPUT], [MENU], [BLANK], [FREEZE], [⏏], [VOLUME +], [VOLUME -], [D-ZOOM +], [D-ZOOM -], [KEYSTONE +], [KEYSTONE -], [▲], [▼], [◀], [▶], [TIMER], [AUTO], [ASPECT], [FUNC]
8. After entering the new password, press the [ENTER] key.
  - This will display a dialog box prompting you to enter the same password again.
9. Re-enter the same password key sequence you entered in step 7 and then press the [ENTER] key.
  - The message “Your new password has been registered.” indicates that the password has been changed. Press the [ESC] key.
  - If the password you entered in this step is different from the one you entered in step 7, the message “The password you input is wrong.” appears. Press the [ESC] key to return to step 7.

## To change the power on password setting

1. Perform steps 1 through 5 under “To change the password” (page 33) and display the Password screen.
2. After confirming that “Power On Password” is selected, use the [◀] and [▶] keys to select either the “On” or “Off” setting.
  - Changing the setting from “Off” to “On” will cause the “Prompt for password when power is turned on?” dialog box to appear. Press the [ENTER] key to confirm that you want to turn on power on password protection, or [ESC] to exit the dialog box without changing the setting.
3. After you are finished, press the [MENU] key to exit the setup menu.

## To change the projector internal storage function password (network models only)

1. Perform steps 1 through 5 under “To change the password” (page 33) and display the Password screen.
2. Press the [▼] key to select “Internal Storage Password”.
3. Use the [◀] and [▶] keys to select “On” or “Off”.
  - Changing the setting from “Off” to “On” will cause the “Prompt for password when an internal storage operation is performed?” dialog box to appear. Press the [ENTER] key to confirm that you want to turn on internal storage password protection, or [ESC] to exit the dialog box without changing the setting.
4. After you are finished, press the [MENU] key to exit the setup menu.

## Control Panel Lock (XJ-F Series Only)

Control panel lock disables (locks) all of the projector's keys, except for the [⏻] key. This limits projector operation to the remote controller, which protects against inadvertent mis-operation.

### To lock the control panel

1. Press the [MENU] key to display the setup menu.
2. Use the [▼] key to select “Option Settings 2”, and then press the [ENTER] key.
3. Use the [▼] key to select “Control Panel Lock”.
4. Use the [◀] key to select “On”.
5. When the confirmation dialog box appears, press the [ENTER] key.
  - This disables (locks) all projector keys except for the [⏻] key.
6. After you are finished, press the [MENU] key to exit the setup menu.



#### Note

---

- Even if the control panel is locked, you can clear a warning message (page 69) that appears on the projection screen by pressing the projector's [ESC] key.

### To unlock the control panel

Perform either of the following operations.

- On the projector, hold down the [▼] key until the message “Control panel was unlocked.” appears.
- To use the remote controller to unlock the control panel, perform the procedure under “To lock the control panel” above. In step 4, press the [▶] key of the remote controller to select “Off” and then press the [MENU] key.

# Projecting from Built-in Memory or USB Input (Network Models Only)

This section explains operations using the projector’s “File Viewer” (to project the contents of files in built-in memory or on a USB flash drive), “USB Display” (to project data from a computer over a USB connection), and “CASIO USB Tool” (to project CASIO calculator screen contents).

## Projecting with File Viewer

### File Viewer Overview

File Viewer is an application you can use for viewing or playing back different types of files located in projector internal memory or on a memory device connected to the projector’s USB port.

### Supported Playback Files

File Type	Supported File Conditions
Image File:*1	JPEG: Up to approximately 15 M pixels (baseline JPEG) Up to approximately 8 M pixels (progressive JPEG) PNG: Less than 6 MB and up to approximately 8 M pixels*2 GIF: Less than 6 MB and up to approximately 8 M pixels*2 BMP: Less than 6 MB and up to approximately 8 M pixels (for 24-bit color)
Movie File:*3	AVI: 20 Mbps maximum 720/30P (MJPEG video, ADPCM audio) MOV: 20 Mbps maximum 1080/30P (H.264 video, ADPCM audio or AAC audio) MP4: 20 Mbps maximum 1080/30P (H.264 video, AAC audio)
Presentation File	ECA or PtG file created with EZ-Converter FA*4
PDF Files	PDF Ver 1.4

\*1 Even if you are using a WXGA model projector (page 9), the maximum projection resolution for image data is 1024 × 768, except for baseline JPEG. In the case of baseline JPEG image data, maximum projection resolution is 1280 × 800.

\*2 Transparent colors in PNG and GIF format image files that have transparent colors enabled will all be displayed as black. Animation GIFs are displayed as still images, without animation.

\*3 Performing fast forward or fast reverse with a movie file with a large bit rate may cause the operation to be performed at a slower speed than normal or to stop part way through. Though a movie with one of the maximum bit rates shown above will play back normally, fast forward and fast reverse not supported.

\*4 PowerPoint files can be converted using EZ-Converter FA (available from the CASIO website). See “Using EZ-Converter FA to Convert PowerPoint Files to ECA or PtG Files” (page 56).

## Projecting Files Located in Projector Internal Memory

File Viewer can be used to project the following types of files when they are located in projector internal memory: image files, movie files, presentation files, PDF files. To use the procedure in this section, the file(s) to be projected must first be copied to projector internal memory. You can copy files using either of the following methods.

- Connect the projector to a computer with a USB cable and copy the files to projector internal memory.
- Use a LAN to copy (upload) files from a computer or smart device to projector internal memory.

The procedures in this manual are all based on copying files over a USB connection. For information about how to copy a file using a LAN, see the separate “Network Function Guide”.

### To copy files from a computer to projector internal memory



#### Note

- This procedure is supported on a computer running one of the operating systems below.  
Windows: XP, Vista, 7, 8, 8.1, 10 (Logged in with admin privileges)  
Mac OS: 10.6, 10.7, 10.8, 10.9, 10.10 (Logged in with a root account or user account)

- 1. Press the [MENU] key to display the setup menu.**
- 2. Use the [▼] key to select “Multimedia Settings”, and then press the [ENTER] key.**
- 3. Use the [▼] key to select “Internal Storage Function”, and then press the [ENTER] key.**
- 4. When the “Turns off the projector to use internal storage.” message appears, press the [ENTER] key.**
  - This will cause projector power to turn off. The POWER/STANDBY indicator will light amber and the STATUS indicator will light red.
- 5. Press the projector’s [⏻] key to turn on power.**
  - The POWER/STANDBY indicator will light green and the STATUS indicator will light red. This indicates that the projector’s internal storage function is operational. You will not be able to project images with the projector at this time.
- 6. If the computer has a USB flash drive or any other removable media connected, disconnect it.**
- 7. Use a commercially available USB cable to connect the projector’s USB-B port (Micro USB B type) to your computer’s USB port.**
  - The location of the USB-B port of this projector is indicated by “\*2” in the illustration under “Connecting Projector Cables” (page 11).
  - When you do, projector internal memory will be recognized by your computer as removable disk drive named “InternalMem”.

## 8. On the computer, open the “InternalMem” drive.

### Windows:

When the “AutoPlay” dialog box appears on your computer screen, click “Open folder to view files”. If the “AutoPlay” dialog box does not appear, perform the following operation: [Start] → [Computer] → Double-click “InternalMem”.

### Mac OS:

An “InternalMem” drive icon will appear on the Mac desktop. Double-click to open it.

## 9. Copy the file(s) you want to project to the “InternalMem” drive.

## 10. After you copy all of the files you want, perform one of the operations below to unmount the “InternalMem” drive.

### Windows:

Click the “Safely Remove Hardware” icon in the task tray (in the lower right corner of the screen). On the menu that appears, select “CASIO USB Display Storage”. Check to make sure that a “Safe To Remove Hardware” message appears.

### Mac OS:

Drag the “InternalMem” drive icon to the trash can icon. Check to make sure that the “InternalMem” drive icon is no longer on the Mac desktop.

## 11. Disconnect the USB cable from the projector and the computer.

## 12. Turn the projector back on.

- This stops internal storage function operation and returns to normal projection.
- For information about how to project a file copied to projector internal memory, see “Starting Projection of Files Located in Projector Internal Memory” (page 39).



### Note

---

- The above is presented only as a typical example of the file copy operation on a computer. The actual steps you will need to perform may differ slightly in accordance with your computer’s operating system and setup.
- If “On” is selected for “Internal Storage Password” on the setting menu, a password input dialog box will appear when you press the [ENTER] key in step 3 of the procedure above. If this happens, enter the appropriate password and then press the [ENTER] key to advance to step 4 of the procedure. For details, see “Password Protection” (page 32).

# Starting Projection of Files Located in Projector Internal Memory

1. If a USB flash drive or some other USB device is connected to the projector's USB-A port, disconnect it.
2. Press the [INPUT] key. This will display the "Input" dialog box.
3. Use the [▼] and [▲] keys to select "Viewer" and then press the [ENTER] key.
4. On the dialog box that appears, confirm that "File Viewer" is selected and then press the [ENTER] key.
  - This will start up File Viewer and display the File Viewer main screen like the one shown below.

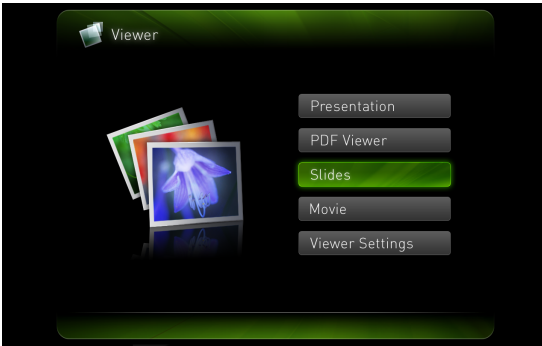

5. Depending on the type of file you want to project, perform one of the operations below.

To project this type of file:	Perform this operation:
Presentation Files	"To project a presentation file" (page 45)
PDF Files	"To project a PDF file" (page 46)
Image Files	"To project an image file" (page 47)
Movie Files	"To project a movie file" (page 47)

## To format projector internal memory (Windows users only)



### Caution

Never format projector internal memory from a computer running Mac OS. Doing so can disable the projector's USB functions.



### Important!

- Performing the procedure below will delete all of the folders and files currently in the projector internal memory.

**1. Perform steps 1 through 7 under “To copy files from a computer to projector internal memory” (page 37).**

**2. Perform the procedure below to format the “InternalMem” drive on your computer.**

- (1) Right click the “InternalMem” drive icon. On the menu that appears, select “Format”.
- (2) On the “Format” dialog box that appears, check to make sure that “FAT32 (recommended)” is selected for “File system” and then click [Start].
- (3) On the warning dialog box that appears, click the [OK] button.
- (4) When a dialog box telling you that formatting is complete appears, click [OK] to close it.
- (5) Click [Close] to close the format dialog box.



## Projecting Files from a Memory Device Connected by USB

Use the procedures in this section when you want to use File Viewer to project image files, movie files, presentation files, or PDF files from a USB flash drive or other memory device.

### Supported Memory Devices

The Data Projector's USB-A port supports connection of a FAT/FAT32 format memory device supported by the USB interface. The following are supported memory devices.

- USB flash drive
- Memory cards
  - A commercially available USB card reader is required to connect a memory card to the Data Projector.
- USB storage class (USB Mass Storage Class) compatible digital cameras

### To connect a USB flash drive to the projector

Connect USB flash drive to the Data Projector's USB-A port as shown below.

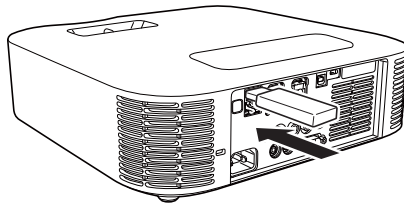

### To connect a memory card to the projector

- 1. Load the memory card into a USB card reader's card slot.**
  - For details about how to load a memory card into the USB card reader, see the user documentation that comes with the reader.
- 2. Connect the USB card reader to the Data Projector's USB-A port.**

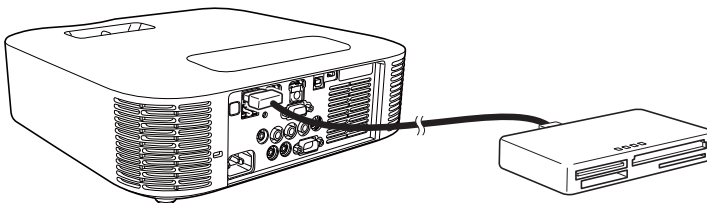

## To connect a digital camera to the projector

- 1. If necessary, configure the digital camera's USB mass storage class setting.**
- 2. Turn off the digital camera and connect a USB cable to it.**
- 3. Connect the other end of the USB cable (Type A connector) to the Data Projector's USB-A port.**
- 4. Turn on the digital camera.**



---

### Note

- For details about steps 1, 2, and 4, see the user documentation that comes with your digital camera.

## To start projection of files that are on a memory device connected via USB

- 1. Connect the memory device where files you want to project are stored to the projector's USB-A port.**
  - If the File Viewer main screen appears automatically, advance to step 4 of this procedure. If it doesn't, go to step 2. Note that the File Viewer main screen will appear automatically if "On" is selected for the "Plug and Play" setting on the projector's Setup Menu.
- 2. Press the [INPUT] key. This will display the "Input" dialog box.**
- 3. Use the [▼] and [▲] keys to select "File Viewer" and then press the [ENTER] key.**
  - This will start up File Viewer and display the File Viewer main screen.

**4. Depending on the type of file you want to project, perform one of the operations below.**

To project this type of file:	Perform this operation:
Presentation File	Use the [▼] and [▲] keys to select “Presentation” and then press the [ENTER] key.
PDF File	Use the [▼] and [▲] keys to select “PDF Viewer” and then press the [ENTER] key.
Image File	Use the [▼] and [▲] keys to select “Slide” and then press the [ENTER] key.
Movie File	Use the [▼] and [▲] keys to select “Movie” and then press the [ENTER] key.

- The screen that will appear depends on the function you selected.



**5. Use the file list displayed on the screen to check the contents of the USB flash drive you connected in step 1 of this procedure or the contents of internal memory.**

- If the file list shows the contents of a USB flash drive, go to step 7 of this procedure. If the file list shows the contents of internal memory, go to step 6.

**6. Press the [FUNC] key. On the menu that appears, select “Drive Switching” and then press the [ENTER] key.**

**7. Depending on the function you selected in step 4 of this procedure, perform one of the operations below.**

If you selected this function:	Perform this operation:
Presentation	Perform the procedure from step 2 under “To project a presentation file” (page 45).
PDF Viewer	Perform the procedure from step 2 under “To project a PDF file” (page 46).
Slide	Perform the procedure from step 2 under “To project an image file” (page 47).
Movie	Perform the procedure from step 2 under “To project a movie file” (page 47).

## Drive Menu

Entering the Presentation Mode, PDF Viewer Mode, Slide Mode, or Movie Mode while there are multiple memory devices connected to the Data Projector's USB-A port (multiple USB flash drive devices connected via a USB hub, multiple memory cards loaded in the memory card reader connected to the Data Projector, etc.) will cause a menu like the one shown below to appear on the projection screen.



When this happens, use the cursor keys to move the highlighting to the drive you want to use and then press the [ENTER] key. This will display a menu of files for the mode you are entering.



### Note

---

- The Data Projector can recognize up to four drives.
- The message "NOUSB" will appear in the Drive Menu if there is no memory device connected to the projector's USB-A port when you perform Drive Switching ([FUNC] → "Drive Switching" → [ENTER]). If this happens, perform Drive Switching again to restore the previous screen.

## Projecting Files

This section explains procedures you can project each type of file using File Viewer.

### To project a presentation file

- 1. On the File Viewer main screen, select “Presentation” and then press the [ENTER] key.**
  - This displays a menu of presentation (ECA or PtG) files.
- 2. Use the [▼] and [▲] keys to select the presentation file you want to play and then press the [ENTER] key (or [▶▶▶] key).**
  - This will start playback of the currently selected presentation file. Whenever there is an automatic pause in playback, press [▶▶▶] to play the next animation or to advance to the next page.
- 3. To return to the file menu, press the [ESC] key.**
- 4. To return to the main screen, press the [FUNC] key and then the [ENTER] key.**



#### Note

- You can perform the operations described in the table below while presentation playback is in progress.

To do this:	Perform this operation:
Go to the previous page	Press the [◀] or [◀◀] key.
Go to the next page	Press the [▶] or [▶▶] key.
Pause playback; Resume playback from where it was paused	Press the [▶▶▶] key.
Skip back to the start of the currently playing animation	Press the [▲] or [◀◀] key
Skip forward to the end of the currently playing animation	Press the [▼] or [▶▶] key.
Select a particular page from a menu of thumbnails and play back that page	1. Press the [FUNC] key. 2. On the menu that appears, select “Page Selection” and then press the [ENTER] key. 3. Use the cursor keys to select the thumbnail of the page you want to play back and then press the [ENTER] key.

## To project a PDF file

1. On the File Viewer main screen, select “PDF Viewer” and then press the [ENTER] key.
  - This displays a list of PDF files.
2. Use the [▼] and [▲] keys to select the PDF file you want to open and then press the [ENTER] key (or [▶▶▶] key).
  - This will open the selected PDF file.
3. Perform page change, zoom, and other operations as required.
  - The following operations are supported during PDF file projection.

To do this:	Perform this operation:
Go to the previous page	Press the [◀] or [◀◀] key.
Go to the next page	Press the [▶] or [▶▶] key.
Adjust the image to the screen width	Press the [FUNC] key. On the menu that appears, select “Adjust to Screen Width” and then press the [ENTER] key.
Return to a full page view	Press the [FUNC] key. On the menu that appears, select “Show Entire Page” and then press the [ENTER] key.
Select a page from a thumbnail list and display it	1. Press the [FUNC] key. 2. On the menu that appears, select “Page Selection” and then press the [ENTER] key. 3. Use the cursor keys to select the thumbnail of the page you want to display and then press the [ENTER] key.

4. To return to the file menu, press the [ESC] key.
5. To return to the main screen, press the [FUNC] key and then the [ENTER] key.

## To project an image file

- 1. On the File Viewer main screen, select “Slide” and then press the [ENTER] key.**
  - This displays a list of image files.
- 2. Use the [▼] and [▲] keys to select image file you want to open and then press the [ENTER] key.**
  - This will project the selected image file.
  - Pressing the [▶▶▶] key instead of the [ENTER] key will start an image file slideshow starting from the currently selected file.
- 3. Perform the rotate image and image scrolling operations described below as required.**
  - The following operations are supported during image file projection.

To do this:	Perform this operation:
Project the previous image file	Press the [◀] or [◀◀] key.
Project the next image	Press the [▶] or [▶▶] key.
Rotate the image leftwards 90 degrees*	Press the [◀◀◀] key.
Rotate the image rightwards 90 degrees*	Press the [▶▶▶] key.
Start a slideshow	Press the [▶▶▶] key.
Stop an ongoing slideshow	Press the [▶▶▶] key.

\* Supported for JPEG files only.

- 4. To return to the file menu, press the [ESC] key.**
- 5. To return to the main screen, press the [FUNC] key and then the [ENTER] key.**

## To project a movie file

- 1. On the File Viewer main screen, select “Movie” and then press the [ENTER] key.**
  - This displays a list of movie files.
- 2. Use the [▼] and [▲] keys to select the movie file you want to open and then press the [ENTER] key or [▶▶▶] key.**
  - This will start playback of the selected movie file.

### 3. Perform fast forward, fast reverse, pause, and other operations as required.

- The operations described below are supported during movie file playback.

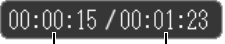
To do this:	Perform this operation:
Pause and resume movie playback	Press the [ENTER] or [▶  ] key. <ul style="list-style-type: none"><li>● A pause icon (▶  ) is displayed in the upper left corner of the projection screen while movie projection is paused.</li></ul>
Re-play the file from the beginning	<ol style="list-style-type: none"><li>1. Press the [FUNC] key.</li><li>2. On the menu that appears, select "Play from Beginning" and then press the [ENTER] key.</li></ol>
Toggle display of the movie playback time between show and hide  Total movie play time Elapsed movie play time	Press the [FUNC] key. On the menu that appears, select "Time Indicator On/Off" and then press the [ENTER] key.
Fast forward at 2X, 8X, or 32X normal speed	Press the [▶▶] or [▶▶▶] key. <ul style="list-style-type: none"><li>● The first press starts 2X speed fast forward, the second press increases to 8X, and the third press increases to 32X.</li><li>● The [▶▶▶] indicator appears in the upper left corner during 2X fast forward, [▶▶▶▶] during 8X fast forward, and [▶▶▶▶▶] during 32X fast forward.</li></ul>
Fast reverse at 2X, 8X, or 32X normal speed	Press the [◀] or [◀◀] key. <ul style="list-style-type: none"><li>● The first press starts 2X speed fast reverse, the second press increases to 8X, and the third press increases to 32X.</li><li>● The [◀◀] indicator appears in the upper left corner during 2X fast reverse, [◀◀◀] during 8X fast reverse, and [◀◀◀◀] during 32X fast reverse.</li></ul>
Return from fast forward or fast reverse to normal playback	Press the [ENTER] key or [▶  ] key twice. Pressing either of these keys only once will pause playback. Press once more to start normal playback.
Jump to the final movie frame	Press the [FUNC] key. On the menu that appears, select "Go to End" and then press the [ENTER] key.
Stop movie file playback and return to the file menu	Press the [ESC] key.

### 4. To return to the file menu, press the [ESC] key.

### 5. To return to the main screen, press the [FUNC] key and then the [ENTER] key.



## File Menu Operations

---

There are two different views for the File Viewer file menu: a list view and an icon view.

### List View

This view shows a list of names of folders and files in the projector internal memory, or on memory device connected to the projector's USB port. Folders and files are displayed in this format immediately after you go from the File Viewer main screen to the Presentation Mode, PDF Viewer Mode, Slide Mode, or Movie Mode.

### Icon View

This view shows both icons and names for the folders and files. Thumbnails are displayed for all of the files that can be played back by File Viewer.

## To toggle the file menu between the list view and icon view

Press the [FUNC] key. On the menu that appears, select "Screen Format" and then press the [ENTER] key.



### Note

- You can specify either the list view or icon view as the default view. For more information, see "Configuring File Viewer Settings" on page 50.

## To scroll the file menu

Press the [▶] key to scroll forward, and the [◀] key to scroll back.

## To open a folder

Use the cursor keys to move the highlighting to the folder you want to open and then press the [ENTER] key.

## To exit the current folder and move up to the next level

Press the [ESC] key.

## To return to the main screen from the file menu

Press the [FUNC] key. On the menu that appears, select "Back to top menu" and then press the [ENTER] key.

## Configuring File Viewer Settings

---

This section explains how to configure File Viewer settings, including those that control what appears on the File Viewer file menu.

### To configure File Viewer settings

- 1. On the File Viewer main screen, select “Viewer Settings” and then press the [ENTER] key.**
  - This displays the “Viewer Setup” screen.
- 2. Use [▼] and [▲] to select the item whose setting you want to change.**
- 3. Use [◀] and [▶] to change the currently selected setting.**
  - For information about the settings available for each item, see “File Viewer Setting Items”.
- 4. Repeat steps 2 through 3 as many times as necessary to configure all of the settings you want.**
- 5. After all the settings are the way you want, press the [ESC] key to return to the File Viewer main screen.**

## File Viewer Setting Items

The initial default setting for each item is indicated by an asterisk (\*).

Setting Name	Description
Display Sequence Setup	<p>Specifies the sequence of images in the file menu.</p> <p><b>&lt; File Names (Ascending) &gt;*</b>: Displays files in file name ascending order.</p> <p><b>&lt; File Names (Descending) &gt;</b>: Displays files in file name descending order.</p> <p><b>&lt; File Name Extension (Ascending) &gt;</b>: Displays file names in file name extension ascending alphabetical order. If multiple files have the same file name extension, they are displayed in file name ascending order.</p> <p><b>&lt; Time (New-to-Old) &gt;</b>: Displays files by the time they were last modified, from the newest to the oldest.</p> <p><b>&lt; Time (Old-to-New) &gt;</b>: Displays files by the time they were last modified, from the oldest to the newest.</p>
Startup Mode	<p>Specifies whether the default view when a mode is entered from the main File Viewer main screen is the list view or icon view.</p> <p><b>&lt; List View &gt;*</b>: Specifies list view as the default view.</p> <p><b>&lt; Icon View &gt;</b>: Specifies icon view as the default view.</p>
Thumbnail View	<p><b>&lt; Show &gt;*</b>: Displays file thumbnails in the file menu.</p> <p><b>&lt; Hide &gt;</b>: File thumbnails not displayed.</p>
Image Switching	<p><b>&lt; Manual &gt;*</b>: Specifies manual image scrolling.</p> <p><b>&lt; Auto &gt;</b>: Specifies auto image scrolling.</p>
Slideshow Display Interval	<p>Specifies how long each image will remain displayed during a slideshow.</p> <p><b>&lt; 5 seconds &gt;*</b>, <b>&lt; 10 seconds &gt;</b>, <b>&lt; 30 seconds &gt;</b>, <b>&lt; 1 minute &gt;</b>, <b>&lt; 5 minutes &gt;</b></p>
Slideshow Repeat	<p><b>&lt; Repeat &gt;</b>: Loops playback of a slideshow or movie.</p> <p><b>&lt; Repeat Off &gt;*</b>: Automatically stops playback when the end of a slideshow or movie is reached.</p>
Movie Audio Output	<p><b>&lt; Output &gt;*</b>: Outputs audio when a movie with an audio track is played back.</p> <p><b>&lt; Do not output &gt;</b>: Audio not output during movie playback.</p>
Initialize Viewer Setup	Returns all File Viewer settings to their initial defaults.

## Autorun

Autorun lets you configure the projector for automatic projection of image files or a movie file located in a special folder named “AUTORUNC”. When auto projection is performed depends on where the “AUTORUNC” folder is located.

When AUTORUNC is located here:	Autorun is performed at this time:
Internal memory	When the projector is turned on while there is nothing connected to its USB-A port.
USB flash drive	When a USB flash drive is connected to the projector's USB-A port or when the projector is turned on while a USB flash drive is connected to the USB-A port.

The settings shown below need to be configured before using Autorun.

- “Multimedia Settings → Autorun” (page 30): Enabled
- “Option Settings 2 → Plug and Play” (page 29): On



### Note

- Autorun projection of the still images or a movie file is in accordance with the current settings configured on the “Viewer Setup” screen (page 50).

## To auto project images files or a movie file from a USB flash drive

- 1. Create a folder named “AUTORUNC” (all single-byte upper-case characters) in the root directory of the USB flash drive.**
- 2. Insert all of the image files or movie file you want to auto project into the folder you created in step 1.**
  - If you want to auto project a movie file, place only one movie file into the “AUTORUNC” folder. Do not place any other files into the folder. If there is both a movie file and image file in the “AUTORUNC” folder, the image file will be given priority and the movie file will not be played.
  - Multiple image files can be placed in the “AUTORUNC” folder without any problem. If there are, plugging the USB flash drive into the projector in step 3 below will start a slideshow of the images.
- 3. While projector power is turned on, plug the USB flash drive that contains the “AUTORUNC” folder to which you copied the files in step 2 above into the projector’s USB-A port.**
  - This will automatically start up File Viewer and project the file(s) you put in the “AUTORUNC” folder in step 2 above.

## To auto project images files or a movie file from projector internal memory

- 1. Perform steps 1 through 8 under “To copy files from a computer to projector internal memory” (page 37).**
- 2. Create a folder named “AUTORUNC” (all single-byte upper-case characters) in the root directory of the “InternalMem” drive (projector internal memory).**
- 3. Insert all of the image files or movie file you want to project with Autorun into the folder you created in step 2.**
  - If you want to auto project a movie file, place only one movie file into the “AUTORUNC” folder. Do not place any other files into the folder. If there is both a movie file and image file in the “AUTORUNC” folder, the image file will be given priority and the movie file will not be played.
  - Multiple image files can be placed in the “AUTORUNC” folder without any problem. If there are, turning on projector power in step 6 below will start a slideshow of the images.
- 4. Turn off the projector.**
- 5. If a USB flash drive or some other USB device is connected to the projector’s USB-A port, disconnect it.**
- 6. Turn on the projector.**
  - This will automatically project the file(s) you put in the “AUTORUNC” folder in step 3 above.

## File Viewer Troubleshooting

Problem	Cause and Required Action
File Viewer does not appear when I connect USB flash drive to the Data Projector's USB-A port.	<ul style="list-style-type: none"> <li>● The USB flash drive you are connecting may have a format that cannot be recognized by the Data Projector. Connect the USB flash drive to your computer to check if its file system is FAT or FAT32. If it isn't, reformat the USB flash drive to FAT or FAT32. Note that doing so will delete all of the data currently in USB flash drive.</li> <li>● If "Off" is selected for the "Option Settings 2 → Plug and Play" setting (page 29), File Viewer will not startup automatically even if a USB flash drive is connected to the projector's USB-A port. If this happens, change the "Plug and Play" setting to "On".</li> </ul>
Some folders and/or files are not displayed in the file menu.	All the folders and/or files contained in a folder will not be displayed if there are more than 999 folder and/or files inside the folder. If this happens, reduce the number of folders and/or files in the folder.
There are multiple devices connected to the Data Projector via a USB hub or USB card reader, but some of the devices are not recognized.	The Data Projector can recognize up to four drives. If the number of connected drives is greater than four, the Data Projector will not recognize the fifth and subsequent drives. Connect memory devices while ensuring that no more than four drives are connected.
When I connect my digital camera to the Data Projector via USB, digital camera memory contents do not appear.	<ul style="list-style-type: none"> <li>● The digital camera's USB mass storage class setting may not be configured correctly, or you may need to perform some operation on the camera. Consult the user documentation for your digital camera for information about the required settings and operations.</li> <li>● The digital camera may not support USB mass storage class. If it does not, you will not be able to use Viewer to view digital camera memory contents.</li> </ul>
On the Slide Mode file menu, question marks (?) appear in place of thumbnails.	Question marks are displayed in place of thumbnails of images that cannot be projected by File Viewer.

## File Viewer Error Messages

Problem	Cause and Required Action
Folder does not contain any image files.	There is no displayable folder, or file in the folder you are trying to access with the File Viewer. Use your computer to check the contents of the folder. For details about file formats supported for Data Projector playback, see "Supported Playback Files" (page 36).
This ECA file cannot be played./ This PtG file cannot be played.	There may be an error in the ECA file or PtG file itself. Play back the ECA file or PtG file using the EZ-Converter FA on your computer and check it.
Cannot display an image file.	<ul style="list-style-type: none"> <li>● You may be trying to play back an image whose format and/or size is not supported by File Viewer. Check the "Supported Playback Files" (page 36).</li> <li>● There may be an error in the image file itself. Open the image file on your computer and check it.</li> </ul>
This movie file cannot be played back.	<ul style="list-style-type: none"> <li>● You may be trying to play back a movie whose format and/or size is not supported by File Viewer. Check the "Supported Playback Files" (page 36).</li> <li>● There may be an error in the movie file itself. Open the movie file on your computer and check it.</li> </ul>
This PDF file cannot be displayed.	For information about the types of PDF files that can be displayed by File Viewer, see "Supported Playback Files" (page 36).
Internal Memory Access Error	<p>An error may have been generated by a particular folder or file in projector internal memory. Perform steps 1 through 8 under "To copy files from a computer to projector internal memory" (page 37) and then open the "InternalMem" drive (projector internal memory) on your computer. Check if all of the folders and files in "InternalMem" open normally. If you experience trouble with any file or folder, delete it.</p> <p>If you cannot open any of the files or folders in projector internal memory with your computer or if you cannot open the "InternalMem" drive itself, it could mean there is a problem with the projector internal memory file system. In this case, perform the procedure under "To format projector internal memory (Windows users only)" (page 40).</p>
Failure due to insufficient internal memory capacity.	Remaining available projector internal memory capacity is insufficient. Perform steps 1 through 8 under "To copy files from a computer to projector internal memory" (page 37) and then open the "InternalMem" drive (projector internal memory) on your computer. Next, delete files you no longer need.
This file cannot be played back.	For information about the types of files that can be displayed by File Viewer, see "Supported Playback Files" (page 36).
Could not find an image file.	There is nothing in projector internal memory or on the connected USB flash drive, or there is some problem with the file system. Use your computer to check the contents of projector internal memory or the USB flash drive.

# Using EZ-Converter FA to Convert PowerPoint Files to ECA or PtG Files

EZ-Converter FA is computer software for converting PowerPoint files to ECA files or PtG files, which can be played back using the projector's File Viewer. EZ-Converter FA supports conversion of files created with Microsoft Office PowerPoint 2003, 2007 and 2010.



## Important!

- Before trying to use EZ-Converter FA, be sure to go to the CASIO website (<http://www.casio-intl.com/support/>) and check the information there about minimum computer system requirements, and conditions governing download and use.
- The procedure below assumes that you already have EZ-Converter FA installed on your computer.



## Note

- Save for certain exceptions (described below), playback and projection of an ECA file or PtG file normally should be able to reproduce transitions, animations, and other special effects of the original PowerPoint file.
  - Conversion of OLE objects (movies, audio, etc.) and VBA objects in a PowerPoint file is not supported.
  - Conversion of timer and repeat operations in a PowerPoint file animation is not supported.
  - An animation in a PowerPoint file is converted up to the time specified by "To specify the maximum animation display time" (page 59), and everything after that is cut. When the point up to which the animation was converted is reached during playback of the converted file, playback will pause, and you will have to press the [▶||] key to advance to the next step.
  - The source PowerPoint file plays when you convert a file with EZ-Converter FA. If there is no change on the screen for about three consecutive seconds during this playback, say between Points A and B, for example, the effect at Point B in the original file is ignored and not converted. When Point B is reached during playback of the converted file, playback will pause, and you will have to press the [▶||] key to advance to the next step.
- Starting a conversion operation with EZ-Converter FA will temporarily change the screen settings of your computer as shown below. Screen settings will revert back to what they were after the conversion operation is complete.

Operating System:	Changes:
Windows XP	<ul style="list-style-type: none"><li>● Screen resolution changes to 800 × 600, 1024 × 768, 1280 × 768 or 1280 × 800.</li><li>● Display card hardware acceleration is disabled.</li></ul>
Windows Vista or Windows 7	<ul style="list-style-type: none"><li>● Screen resolution changes to 800 × 600, 1024 × 768, 1280 × 768 or 1280 × 800.</li><li>● Windows changes to the Basic mode (Windows Aero™ disabled).</li></ul>
Windows 8	<ul style="list-style-type: none"><li>● Screen resolution changes to 800 × 600, 1024 × 768, 1280 × 768 or 1280 × 800.</li></ul>

- The screen resolution of the ECA file or PtG file will be the resolution specified by the EZ-Converter FA setting (800 × 600, 1024 × 768, 1280 × 768 or 1280 × 800) when the file conversion operation starts. For information about configuring this setting, see "To specify the screen resolution of the ECA file or PtG file" (page 59).



# To convert a PowerPoint file to an ECA file or PtG file



## Important!

- Before performing any of the operations here, you will need to have a file created using Microsoft Office PowerPoint 2003, 2007 or 2010 on hand.
- Conversion of a PowerPoint file to an ECA file or PtG file requires playback of the original file from beginning to end. Note that the time required for conversion will roughly correspond to the time required for playback.

### 1. Turn on your computer and start up Windows.

### 2. Connect the USB flash drive (or memory card) where you want to store the converted ECA file or PtG file to your computer.

- You can skip this step if you want to save the ECA file or PtG file to your computer's local hard disk.

### 3. On your computer, start up EZ-Converter FA.

- If your computer is running Windows Vista or Windows 7, starting up EZ-Converter FA will cause the "User Account Control" message to appear. When it does, click [Allow] or [Yes].
- This will display the EZ-Converter FA window.

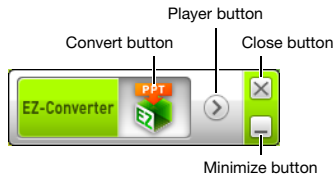

### 4. Configure the following settings as required.

- Specify the ECA file or PtG file screen display resolution. See "To specify the screen resolution of the ECA file or PtG file" (page 59).
- If the original file contains an animation, specify the maximum animation display time. See "To specify the maximum animation display time" (page 59).

### 5. Click the button at the top of the EZ-Converter FA window.

- This displays a dialog box for opening files.

### 6. Select the PowerPoint file you want to convert from and then click the [Open] button.

- This will display a dialog box like the one shown below for specifying the file settings.

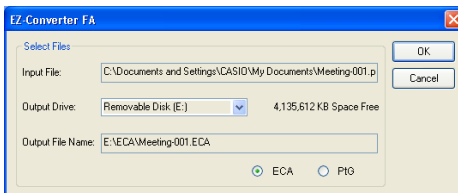

## 7. Configure the settings as required on the dialog box.

- The following describes the meanings and settings of each of the items that appear on the dialog box.

Dialog Box Item	Description
Input File	Shows the name of the PowerPoint file selected in step 6. The setting of this item cannot be changed.
Output Drive	Shows the drive name of the removable disk (USB flash drive or memory card) connected to the computer in step 2. When you have multiple removable disks connected to your computer, you can click the [▼] button and select the name of the drive where you want to save the converted file. A converted file is stored in the folder named ECA (in the case of an ECA file) or PtG (in the case of a PtG file) on the drive you specify here.  Under initial default settings, if there are no removable disks connected to the computer, the resulting file will be saved in the same location (drive and folder) as the original PowerPoint file. Click the [Browse] button and change the save destination, if you want.
Output File Name	Shows the file name of the converted file, along with the path from the drive name. Except for the extension, the file name is the same as the PowerPoint file name. The setting of this item cannot be changed.
ECA/PtG	Specifies the format of the converted file (Default: ECA).

## 8. After configuring all the settings you want, click [OK].

- This will start playback of the PowerPoint file and start converting it to an ECA file or PtG file.
- The “Conversion complete.” message will appear when file conversion is complete.
- If you have other PowerPoint files you want to convert, repeat steps 4 through 7.
- To check the contents of an ECA file or PtG file, perform the procedure under “To play back an ECA file or PtG file on your computer” (page 59).

## 9. After you are finished converting all the files you want, click the close button in the upper right corner of the EZ-Converter FA window.

## To specify the screen resolution of the ECA file or PtG file

1. Right-click the left side of the EZ-Converter FA window.
2. On the menu that appears, click “Output Resolution”.
3. On the sub-menu that appears, select the resolution you want.
  - Select 1280 × 800 or 1280 × 768. If you cannot select the 1280 × 800 or 1280 × 768 resolution, select 1024 × 768.
  - For a PtG file, select 1024 × 768 or 800 × 600.
  - The setting you select here remains in effect until you change it.

## To specify the maximum animation display time

1. Right-click the left side of the EZ-Converter FA window.
2. On the menu that appears, click “Max Animation Display Time”.
3. On the sub-menu that appears, select a maximum animation display time value (in seconds).
  - Available sub-menu options are 10 seconds, 20 seconds, 30 seconds, and 60 seconds.
  - The option you select remains in effect until you change it.

## To play back an ECA file or PtG file on your computer

1. On your computer, start up EZ-Converter FA.
  - This will display the EZ-Converter FA window.



2. Click the  button at the top of the EZ-Converter FA window.
  - This will display two more buttons as shown below.







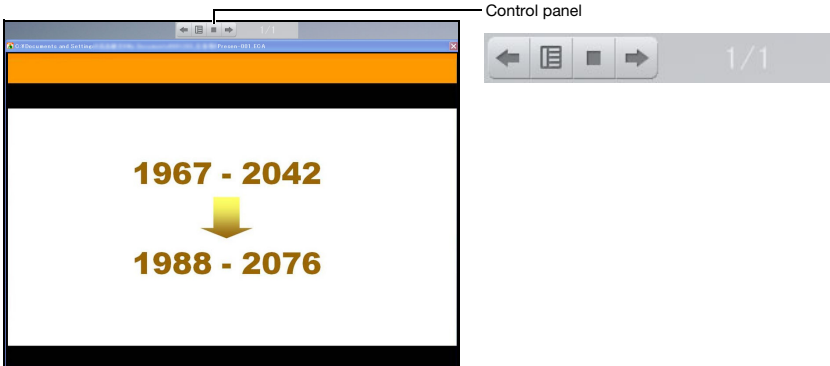

3. Click the  button.
  - This displays a dialog box for opening files.

**4. Select the ECA file or PtG file you want to play back and then click the [Open] button.**

- This will display a control panel at the top of the screen.



- During file playback, you can use the control panel buttons to perform the operations described below.

To do this:	Perform this operation:
Go to the previous page	Click the  button.
Go to the next page	Click the  button.
Jump to a specific page	1. Click the  button and then click "Slide Viewer" on the menu that appears. 2. On the page menu that appears, click the thumbnail of the destination page and then click [OK].
Display help	Click the  button and then click "Help" on the menu that appears.
Exit file playback	Click the  button, or click the  button and then click "Exit" on the menu that appears. You could also press the [ESC] button on your computer keyboard to stop playback.

# Projecting with the USB Display Function

## USB Display Function Overview

---

Connecting the projector to a computer with a USB cable\* enables projection of the computer's screen contents. This supports projection of screen contents of even small computers that have only a USB port, but no RGB, HDMI, or other type of video output terminal.

\* To use the USB Display function, connect the computer to the projector's USB-B port.

## Minimum Computer System Requirements

- Supported Operating Systems  
Windows XP SP3, Windows Vista SP1 (32bit), Windows 7 SP1 (32bit, 64bit), Windows 8/8.1 (64bit), Windows 10, or Mac OS (10.6, 10.7, 10.8, 10.9)  
Note, however, that functions may be limited by the operating system being used. For the latest information about operating environments, visit the CASIO website.
- USB Type A port (USB 2.0 or USB 3.0) equipped.



### Important!

---

- Log into Windows with admin privileges to use the USB display function. You will not be able to use USB display if you are logged into Windows with a non-admin account.

## Projecting Computer Screen Contents Over a USB Connection

---

The operation you need to perform the first time you connect to a computer to project its display contents (described below) depends on whether the computer is running Windows or Mac OS. After that, use the procedure under "To project computer screen contents over a USB connection after the first time" (page 65), which is the same for any operating system.

Perform one of the procedures below, depending on your computer's operating system.

# To project Windows computer screen contents over a USB connection for the first time

1. Press the [INPUT] key. This will display the “Input” dialog box.
2. Use the [▼] and [▲] keys to select “USB Display” and then press the [ENTER] key.
  - This will cause the “USB Display” standby screen to be projected.
3. While your computer is running, use a commercially available USB cable to connect the projector’s USB-B port (Micro USB B type) to your computer’s USB port.
  - The location of the USB-B port of this projector is indicated by “\*2” in the illustration under “Connecting Projector Cables” (page 11).
  - This will mount the projector onto your computer as a virtual CD-ROM drive, which is represented by a “USB\_DISPLAY” drive icon on your computer’s desktop.
  - Also, CASIO USB Display will start up automatically and display a licensing agreement dialog box.
4. On the licensing agreement dialog box, select “I agree” and then click [OK].
  - This will display a window like the one shown below on your computer. At the same time, projection of the computer’s screen contents will start.



## Note

- If CASIO USB Display does not start up automatically, use Explorer to navigate to the “USB\_DISPLAY” drive. Right-click the drive and then click “Auto Play” on the menu that appears.
- For information about the types of operations that can be performed at this point, see “Supported Operations during Projection over a USB connection” (page 64).

## Add-on Driver Software for Windows

With Windows, use of some functions of the CASIO USB Display requires installation of the driver software shown in the table below. The driver software is the same as that used for Network Connection. You can download it from the Network Connection download page at the CASIO website (<http://www.casio-intl.com/support/>).

To use this function:	Install this driver software:
Extended screen output function	VDD driver (for Windows XP and Windows Vista)

## To project Mac OS computer screen contents over a USB connection for the first time

1. Press the [INPUT] key. This will display the “Input” dialog box.
2. Use the [▼] and [▲] keys to select “USB Display” and then press the [ENTER] key.
  - This will cause the “USB Display” standby screen to be projected.
3. While your computer is running, use a commercially available USB cable to connect the projector’s USB-B port to your computer’s USB port.
  - The location of the USB-B port of this projector is indicated by “\*2” in the illustration under “Connecting Projector Cables” (page 11).
  - This will cause a drive icon named “USB\_DISPLAY” to appear on your computer screen.
4. Double-click the “USB\_DISPLAY” drive icon to open it.
5. Double-click “MAC\_USB\_Display\_V2.pkg” and follow the instructions that appear on the display to install the application.
  - A message prompting you to restart your computer will appear after installation is complete. Restart your computer. After the restart is complete, you will see a CASIO USB Display icon in the Dock.
6. In the Dock, click the CASIO USB Display icon.
  - Also, CASIO USB Display will start up and display a licensing agreement dialog box.
7. On the licensing agreement dialog box, select “I agree” and then click [OK].
  - This will display a window like the one shown below on your computer. At the same time, projection of the computer’s screen contents will start.



- For information about the types of operations that can be performed at this point, see “Supported Operations during Projection over a USB connection” (page 64).











### Add-on Driver Software for Mac OS

With Mac OS, use of some parts of the CASIO USB Display requires installation of the driver software shown in the table below. The driver software is the same as that used for Network Connection. You can download it from the Network Connection download page at the CASIO website (<http://www.casio-intl.com/support/>).

To use this function:	Install this driver software:
Audio output function	Sound flower
Extended desktop output function	Syphon-virtual-screen

## Supported Operations during Projection over a USB connection

The operations described in the table below are supported on the CASIO USB Display window during projection.

To do this:	Perform this operation:
Start (resume) computer screen projection	Click  .
Freeze computer screen projection	Click  .
Stop computer screen projection and project the USB display standby screen	Click  .
Start audio output from a computer*1	Click  . On the menu that appears, select "Audio Out" so there is a check mark next to it.
Mute audio output from a computer*1	Click  . On the menu that appears, select "Audio Out" to remove the check mark next to it.
Output the computer's main screen on the projection screen	Click  . On the menu that appears, select "Select the Projection Screen" → "Main Screen".
Output the computer's extended screen on the projection screen*1*2	Click  . On the menu that appears, select "Select the Projection Screen" → "Extended Screen".
Minimize the CASIO USB Display window	Click  .
Exit the CASIO USB Display window	(1) Click  . Or you could click  and then click "Exit" on the menu that appears. (2) On the confirmation dialog box that appears, click the [OK] button. ● This stops computer screen projection and projects the "USB Display" standby screen.
Display CASIO USB Display version information	Click  . On the menu that appears, select "About".

\*1 With Mac, installation of driver software is required to enable these functions. See "Add-on Driver Software for Mac OS" (page 63).

\*2 This operation is disabled under Mac OS 10.6. With Windows XP and Windows Vista, installation of driver software is required to enable these functions. See "Add-on Driver Software for Windows" (page 62).



## To project computer screen contents over a USB connection after the first time

1. Turn on and start up the projector and computer.
2. Press the [INPUT] key. This will display the “Input” dialog box.
3. Use the [▼] and [▲] keys to select “USB Display” and then press the [ENTER] key.
  - This will cause the “USB Display” standby screen to be projected.
4. Use a USB cable to connect the projector’s USB-B port to your computer’s USB port.
  - The CASIO USB Display will startup automatically on the computer and start projection of the computer screen contents.



---

### Note

- If the above operation does not cause CASIO USB Display to start up automatically, perform either of the operations below on your computer, depending on its operating system.

#### **Windows:**

Use Explorer to navigate to the “USB\_DISPLAY” drive. Right-click the drive and then click “Auto Play” on the menu that appears.

#### **Mac OS:**

In the Dock, click the CASIO USB Display icon.

# Projecting the Screen Image of a Graphing Calculator

You can connect a CASIO graphing calculator to the Data Projector using a USB cable and project the calculator's screen image with the Data Projector. USB connection of the following CASIO graphing calculators is supported.

- ClassPad II (fx-CP400)
- ClassPad 330 PLUS
- fx-CG series
- fx-9860G series
- fx-9860GII series
- fx-9750GII
- GRAPH 95/85/85 SD/75/75+/35+

## To project the screen image of a graphing calculator

- 1. While the projector is turned on, connect the USB cable that comes with the graphing calculator to the projector's USB-A port and the graphing calculator's USB port.**
- 2. On the projector, press the [INPUT] key. This will display the "Input" dialog box.**
- 3. Use the [▼] and [▲] keys to select "CASIO USB Tool" and then press the [ENTER] key.**
- 4. On the graphing calculator, perform the operation required for projection.**
  - For details about this operation, refer to the use documentation that comes with your calculator.



### Important!

---

- If the calculator does not operate properly after you connect it to the Data Projector, try disconnecting the USB cable from the calculator and then reconnecting it. If this does not correct the problem, disconnect the USB cable from both the Data Projector and the calculator. Turn the Data Projector off and then back on again, and then re-connect the calculator.

# Cleaning the Projector

Make it a habit to clean the projector at regular intervals as described in this section. Before cleaning the projector, be sure to unplug it from the power outlet and make sure it is cooled down completely.

## Cleaning the Projector Exterior

Wipe the exterior of the projector with a soft cloth that has been moistened in a weak solution of water and a mild neutral detergent. Be sure to wring all excess moisture from the cloth before wiping. Never use benzene, alcohol, thinner, or any other volatile agent for cleaning.

## Cleaning the Lens

Carefully wipe the lens with a commercially available lens cloth or optical lens paper, like those for eyeglasses or camera lenses. When cleaning the lens, do not apply undue force and take care to avoid damaging the lens.

## Cleaning Vents

Dust and dirt tend to collect around the intake vents. Because of this, you should use a vacuum cleaner to clean away accumulated dust and dirt periodically (about once a month) as shown below.

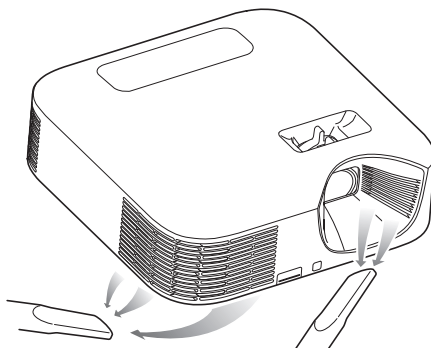

### Important!

- Continued use of the projector after dust has accumulated around the intake vents can cause overheating of internal components and lead to malfunction.
- Certain operating conditions also can cause dirt and dust to accumulate around the projector's exhaust vents. If this happens, use the same procedure as that described above to clean the exhaust vents.

# Troubleshooting

## Indicators

The POWER/STANDBY indicator and STATUS indicator change to show the current status of the projector as described in the tables below.

### POWER/STANDBY indicator

When the indicator is doing this:	It means this about the projector:
Lit red	Connected to a power source, but turned off (standby mode)
Flashing green	Warming up after being turned on
Lit green	Power on, operation normal
Flashing red	Internal process in progress immediately after power off

### STATUS indicator

When the indicator is doing this:	It means this about the projector:
Lit green	"On" selected for the "Light Control" setting
Lit (or flashing) red	Error
Lit (or flashing) amber	Error



#### Note

- The POWER/STANDBY and STATUS indicators both light amber immediately after the projector is plugged into a power outlet.

# Error Indicators and Warning Messages

Warning messages and indicators let you know what the problem is when a projector error occurs.

- When an error occurs, wait until the fan stops before unplugging the AC power cord. If you unplug the AC power cord while the fan is still operating, an error may occur when you plug the AC power cord back in.
- Press the [ESC] key to clear the warning message.

Indicator/Error Message	Description and Required Action
<p>POWER : Green steady</p> <p>STATUS : – (Green steady when “On” is selected for the “Light Control” setting.)</p> <p>Message : Internal temperature is too high. Check projector air vents for blockage.</p>	<p>The projector’s internal temperature is very high. Perform the following steps.</p> <p>① Check for any blocking of the projector’s intake vents and exhaust vents, and make sure that there is sufficient space around the projector. See “Setup Precautions” (page 10).</p> <p>② If there is dust accumulated around the intake vents and/or exhaust vents, turn off the projector and remove it. See “Cleaning the Projector” (page 67).</p>
<p>POWER : Green steady → Red steady</p> <p>STATUS : –</p> <p>Message : Internal temperature is too high. The projector will turn off.</p>	<p>Power has turned off automatically due to internal overheating. Perform the following steps.</p> <p>① Check for any blocking of the projector’s intake vents and exhaust vents, and make sure that there is sufficient space around the projector. See “Setup Precautions” (page 10).</p> <p>② If there is dust accumulated around the intake vents and/or exhaust vents, remove it. See “Cleaning the Projector” (page 67).</p> <p>If there is no problem with the projector’s vents, confirm that the POWER/STANDBY indicator is lit red (without flashing), and then turn power back on again. If the error occurs again when you turn power back on, contact your retailer or nearest authorized CASIO Service Center.</p>
<p>POWER : Red steady</p> <p>STATUS : Amber flashing (0.5-second interval)</p>	<p>Power has turned off automatically due to a fan problem. Confirm that the POWER/STANDBY indicator is lit red (without flashing) and that the fan has stopped. After checking the POWER/STANDBY indicator, disconnect the power cord from the projector and wait for all of the projector’s indicators to go out. Next, reconnect the power cord and turn projector power back on.</p> <p>If the error occurs again when you turn power back on, contact your retailer or nearest authorized CASIO Service Center.</p>
<p>POWER : Red steady</p> <p>STATUS : –</p>	<p>Power has turned off automatically due to a system problem. After confirming that the POWER/STANDBY indicator is lit red (without flashing), disconnect the power cord from the projector and wait for all of the projector’s indicators to go out. Next, reconnect the power cord and turn the projector back on.</p> <p>If the error occurs again when you turn power back on, contact your retailer or nearest authorized CASIO Service Center.</p>
<p>POWER : Red steady</p> <p>STATUS : Red steady</p> <p>Message : –</p>	<p>The projector was turned off automatically due to some problem that was probably caused by external digital noise or some other reason. Confirm that the POWER/STANDBY indicator is lit red (without flashing). After checking the POWER/STANDBY indicator, disconnect the power cord from the projector and wait for all of the projector’s indicators to go out. Next, reconnect the power cord and turn projector power back on.</p> <p>If the error occurs again when you turn power back on, contact your retailer or nearest authorized CASIO Service Center.</p>

Indicator/Error Message	Description and Required Action
POWER : Red steady STATUS : Red flashing (0.5-second interval) Message : –	The projector was turned off automatically because the light source unit turned off or did not turn on. After confirming that the POWER/STANDBY indicator is lit red (without flashing), unplug the power cord. Wait for a short while and then plug it back in and turn on the projector again. If the error occurs again when you turn power back on, contact your retailer or nearest authorized CASIO Service Center.
POWER : Red steady STATUS : Red flashing (2-second or 1-second interval) Message : –	Power has turned off automatically due to a projector memory error. Confirm that the POWER/STANDBY indicator is lit red (without flashing). After checking the POWER/STANDBY indicator, disconnect the power cord from the projector and wait for all of the projector's indicators to go out. Next, reconnect the power cord and turn projector power back on. If the error occurs again when you turn power back on, contact your retailer or nearest authorized CASIO Service Center.

## Projector Troubleshooting

Check the following items whenever you experience any problem with the projector.

Problem	Cause and Recommended Action
Power does not turn on.	<ul style="list-style-type: none"> <li>● If the POWER/STANDBY indicator is not lit, the AC power cord is not connected correctly. Connect the AC power cord correctly.</li> <li>● If the POWER/STANDBY indicator is lit red and the STATUS indicator is lit (or flashing) red or amber, it means some type of error has occurred. See “Error Indicators and Warning Messages” (page 69).</li> </ul>
No image is projected or the projected image is abnormal.	<ul style="list-style-type: none"> <li>● The computer or video device connected to the projector is not turned on or it is not outputting a video signal. Make sure the connected computer or video device is turned on, and perform the required operation on it to output a video signal.</li> <li>● The correct output source is not selected on the projector. On the projector, select the correct input source that corresponds to the connected device.</li> <li>● Images may not project correctly when you have the component output terminal of a video device connected to the COMPUTER terminal of the projector.</li> </ul>
Image color or display is very abnormal.	<p>The wrong option (“Component” or “RGB”) may be selected for the “Input Settings → COMPUTER Terminal” setting on the setup menu. The image will not be projected correctly if “Component” is selected while the projector’s COMPUTER terminal is connected to the RGB output terminal of a computer, or if “RGB” is selected while the projector’s COMPUTER terminal is connected to the component video output terminal of a video device. On the setup menu, select “Auto” for the “Input Settings → COMPUTER Terminal” setting. See page 28.</p>
I can’t understand messages or menus because they are the wrong language.	<p>Perform the following operation to select the language you want. See page 29.</p> <ol style="list-style-type: none"> <li>1. Press the [MENU] key to display the setup menu.</li> <li>2. If the input signal is HDMI (PC), press [▼] four times and then press the [ENTER] key. If the input signal is not HDMI (PC), press [▼] five times and then press the [ENTER] key.</li> <li>3. Press [▲] twice and then press the [ENTER] key to display the language selection menu.</li> <li>4. Use the [▼] and [▲] keys to move the highlighting to the language you want to select and then press the [ENTER] key.</li> <li>5. Press the [MENU] key to exit the setup menu.</li> </ol>

Problem	Cause and Recommended Action
No sound output from the AUDIO OUT terminal	<ul style="list-style-type: none"> <li>● The projector's volume level setting may be too low or muted. Use the remote controller [VOLUME +] and [VOLUME -] keys to adjust the volume level. See page 20.</li> <li>● The volume level setting of the device connected to the projector is too low or the other device is not outputting audio. Adjust the volume level of the connected device.</li> <li>● The audio output of the connected device may not be connected correctly to the projector's AUDIO IN terminal. Check the connection.</li> </ul>
No sound output from the speaker (XJ-F Series)	<ul style="list-style-type: none"> <li>● The projector's volume level setting may be too low or muted. Use the remote controller [VOLUME +] and [VOLUME -] keys to adjust the volume level. See page 20.</li> <li>● The volume level setting of the device connected to the projector is too low or the other device is not outputting audio. Adjust the volume level of the connected device.</li> <li>● The audio output of the connected device may not be connected correctly to the projector's AUDIO IN terminal. Check the connection.</li> <li>● When the input source is "HDMI", "File Viewer", "Network" or "USB Display", "Line" may be selected for the "Option Settings 2 → Audio Out" setting on the setup menu. Change the "Audio Out" setting to "Speaker". See page 30.</li> </ul>
Strange color	<p>The input signal may not match projector settings. Try doing the following.</p> <ul style="list-style-type: none"> <li>- Press the [FUNC] key and then select "Brightness" to adjust image brightness.</li> <li>- Press the [FUNC] key and then select "Color Mode" to change the color mode.</li> <li>- On the setup menu, use "Image Adjustment 1 → Color Balance" to adjust the projection image color balance.</li> </ul>
Text is blurry.	<ul style="list-style-type: none"> <li>● The image may be out of focus. Adjust image focus.</li> <li>● The current frequency and/or phase setting do not match the input signal. (Applies only when the input source is an RGB signal.) Press the [AUTO] key to execute an automatic adjustment operation.</li> <li>● On the setup menu, perform the "Image Adjustment 2 → Frequency" and "Image Adjustment 2 → Phase" adjustments. (Applies only when the input source is an RGB signal.) See page 27.</li> </ul>
The message "Please input the password." appears and further operation is not possible.	<p>The "Option Settings 1 → Power On Password" setting on the setup menu is turned on, so the projector is password protected. Input the correct password, and then press the [ENTER] key. See page 32.</p>
The remote controller does not work.	<ul style="list-style-type: none"> <li>● The remote controller batteries may be dead. Replace the batteries.</li> <li>● The remote controller may be too far from the projector. Make sure the remote controller is within about five meters from the projector when performing operations.</li> </ul>
The POWER/STANDBY indicator is lit red and the STATUS indicator is lit (or flashing) red or amber.	<p>An error occurred. See "Error Indicators and Warning Messages" (page 69).</p>
The light source unit does not light.	<ul style="list-style-type: none"> <li>● The light source has been temporarily shut off by pressing the [BLANK] key. Press the [BLANK] key or [ESC] key to turn it back on. For more information, see "To momentarily blank the image and mute the audio (BLANK)" (page 17).</li> <li>● The light source unit has reached the end of its service life or it is malfunctioning. Contact your original dealer or authorized CASIO service center for replacement.</li> </ul>

Problem	Cause and Recommended Action
Power suddenly turns off and the projector restarts.	The projector periodically performs a self-check operation. In rare cases, the result of a self-check may cause the projector to restart automatically. This normally does not indicate malfunction, so you can continue using the projector. However, malfunction may be indicated if successive restarts keep occurring. If this happens contact your original dealer or authorized CASIO service center.



### **Important!**

---

- Try performing the following steps, which may or may not return the projector to normal operation.
  1. Unplug the AC power cord and wait for at least 10 minutes.
  2. Plug the power cord back in and turn the projector back on again.
- If normal operation does not resume after you perform the above steps, take the projector to your retailer or authorized CASIO service center.



## Connecting to a Component Video Output

This section explains how to establish a component video connection between the projector and a video device.

- Component video output terminals come in 3-terminal sets: Y·Cb·Cr or Y·Pb·Pr. Be sure to match the colors of the plugs on a component video cable with the colors of the terminals (Green: Y; Blue: Cb/Pb; Red: Cr/Pr).
- Note that connection only to an analog component video output terminal is supported. Connection to a digital output terminal is not supported.

### XJ-V Series

#### Projector

COMPUTER terminal

AUDIO IN terminal

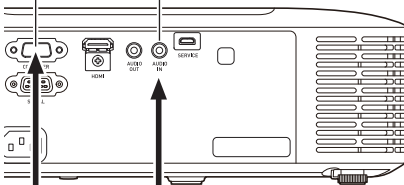

#### Video device

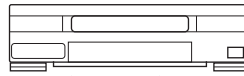

To audio output terminals

To component video output terminals

White

Red

Stereo mini plug ⇔ Pin plug type audio cable  
(commercially available)

Component video cable (commercially available)

# XJ-F Series

## Projector

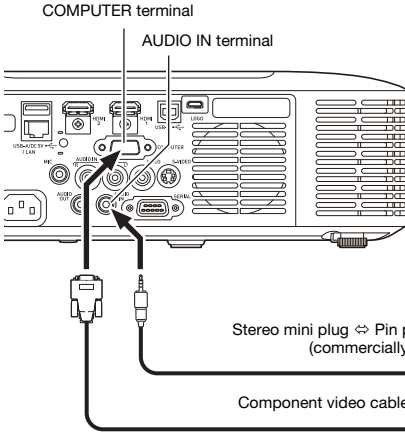

## Video device

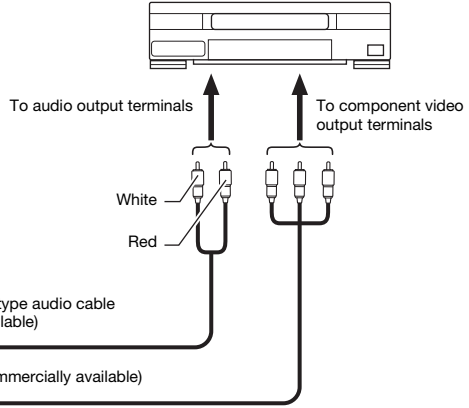

## Connecting to a Composite Video Output or S-Video Output (XJ-F Series Only)

## Projector

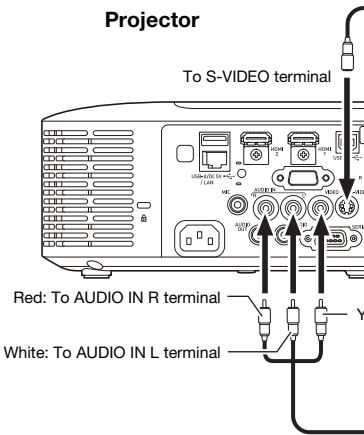

## Video device

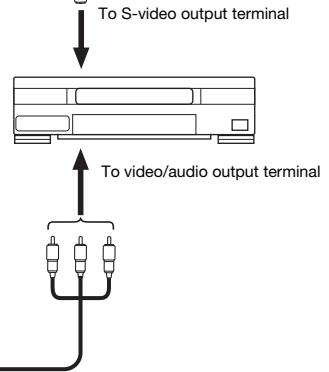

## Note

- Note that regardless of whether the image being projected is being input via the projector's S-VIDEO terminal or VIDEO terminal, the projector outputs audio that is input via the projector's AUDIO IN L/R terminals.

## Supplying Power to External Equipment (XJ-F Series Only)

Power can be supplied to external equipment via the USB-A/DC 5V port of an XJ-F20XN, XJ-F200WN, or XJ-F210WN model projector, or via the DC 5V port of an XJ-F10X or XJ-F100W model projector.



### Important!

---

- Turning off projector power also cuts power being supplied to external equipment. Note that power being supplied is also cut when the projector is turned off due to restarting by its self-check function or Auto Power Off, due to some error, or for any other reason. Depending on the external equipment being used, cut off of the power supply may cause data that is being edited to be lost or corrupted. Make it a habit to frequently save data on external equipment being powered by the projector.
- Projector power being turned off by Auto Power Off (page 29) also causes power to external equipment to be cut off. Before starting power supply to external equipment, be sure to select “Off” for the setting “Option Settings 1 → Auto Power Off” to disable Auto Power Off.
- For a list of external equipment whose operation has been confirmed while being powered by the projector, visit the CASIO projector website (<http://www.casio-intl.com/support/>). Proper operation is not guaranteed for any external device that is not included in the list at the CASIO projector website.
- Though power up to 5V DC 2A can be supplied to other devices not included on the CASIO website, note that doing so may make some functions unavailable on some devices. Before using output from this port to power another device, be sure to check the user documentation of the device and make sure you connect it correctly. Particular care is required when connecting a chargeable battery to this projector’s USB port power supply. Incorrect connection creates the risk of explosion, fire, and smoke.
- Note that CASIO COMPUTER CO., LTD. shall be held in no way liable for any loss or corruption of data stored on an external device connected to this projector’s USB port power supply, or for any damage, smoke generation, or fire occurring on the connected device.



### Note

---

- To temporarily blank projection while maintaining power supply from the projector to external equipment, press the [BLANK] key. For more information, see “To momentarily blank the image and mute the audio (BLANK)” (page 17).

## Updating Firmware and Transferring a User Logo

With an XJ-V Series projector, you can update firmware (software in the projector flash ROM) using a computer. With an XJ-F Series projector, you can update firmware and also transfer images to the projector to be used as a user logo.

For details about these operations, refer to the “Projector Firmware Update Guide” and “User Logo Transfer Guide”, which are available for download from the CASIO projector website.

### To update firmware and transfer a user logo

Use a commercially available USB cable to connect the projector’s SERVICE port (XJ-V Series models) or LOGO port (XJ-F Series models) to your computer’s USB port.

#### XJ-V Series

SERVICE port  
(Micro-USB Type B)

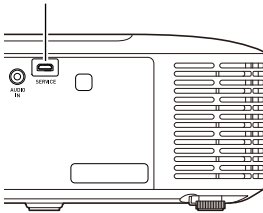

#### XJ-F Series

LOGO port  
(Micro-USB Type B)

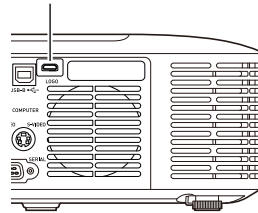

## Hanging the Projector from a Ceiling

The projector can be hung from a ceiling. When hanging a projector from the ceiling, you can orient it upside down or with the projection lens facing straight downwards.

For full details, contact the retailer where you purchased the projector.



### Important!

- When hanging the projector from a ceiling, make sure that it is at least one meter away from fire detectors, fire alarms, and other fire protection devices. Locating the projector too close to a fire protection device creates the risk of mis-operation of the device due to warm air exhausted from the projector. Also, avoid locating the projector close to fluorescent lights or other strong light sources. Bright light can shorten the operating range of the remote controller or even make remote control impossible. When selecting a location for the projector, be sure to test for proper operation of the remote controller.
- The vertical and horizontal orientation of the projected image is reversed from normal when the projector is positioned upside down for hanging from a ceiling. You need to change the setup of the projector in order to correct for this. For details, see “Screen Settings → Ceiling Mount” (page 28) under “Setup Menu Settings”.

# Projection Distance and Screen Size

- The projection distance values below are for reference when setting up the projector.
- “h” in the illustration and table indicates the distance between the center of the projector lens and the bottom edge of the projection screen.

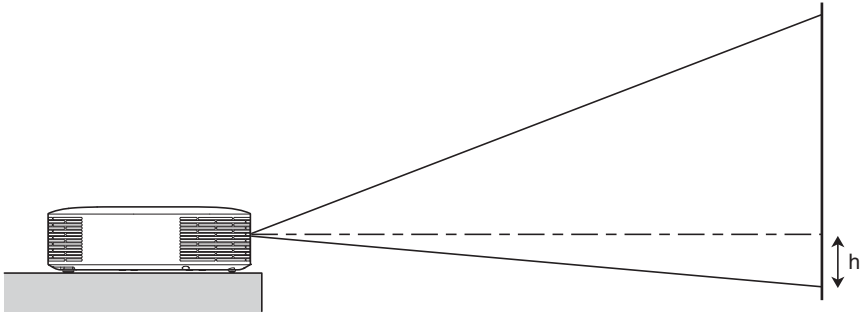



Projection Size		Approximate Projection Distance					
		XJ-V10X/XJ-F10X/XJ-F20XN			XJ-V100W/XJ-V110W/XJ-F100W/ XJ-F200WN/XJ-F210WN		
Screen Size	Diagonal (cm)	Minimum Distance (m / feet)	Maximum Distance (m / feet)	h	Minimum Distance (m / feet)	Maximum Distance (m / feet)	h (cm / inch)
30	76	0.93 / 3.05	1.38 / 4.53	0	-	-	-
35	89	-	-	-	0.92 / 3.02	1.37 / 4.49	8 / 3.15
40	102	1.27 / 4.17	1.88 / 6.17	0	1.06 / 3.48	1.58 / 5.18	9 / 3.54
60	152	1.95 / 6.4	2.87 / 9.42	0	1.64 / 5.38	2.42 / 7.94	13 / 5.12
77	196	2.54 / 8.33	3.72 / 12.2	0	2.14 / 7.02	3.14 / 10.3	17 / 6.69
80	203	2.64 / 8.66	3.86 / 12.66	0	2.22 / 7.28	3.26 / 10.7	18 / 7.09
100	254	3.33 / 10.93	4.85 / 15.91	0	2.81 / 9.22	4.11 / 13.48	22 / 8.66
150	381	5.04 / 16.54	7.33 / 24.05	0	4.26 / 13.98	6.22 / 20.41	34 / 13.39
200	508	6.76 / 22.18	9.82 / 32.22	0	5.72 / 18.77	8.32 / 27.3	45 / 17.72
300	762	10.18 / 33.4	14.78 / 48.49	0	8.63 / 28.31	12.54 / 41.14	67 / 26.38

# Aspect Ratio Setting and Projection Image

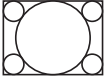
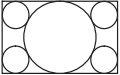

The following shows how images are projected in accordance with the type of the input signal and the aspect ratio setting of the projector.

## XJ-V100W/XJ-V110W/XJ-F100W/XJ-F200WN/XJ-F210WN

Input source: RGB or HDMI(PC)

Input Signal	Normal	Full	16:9	4:3	True
 SVGA (800 × 600)					
 XGA (1024 × 768)					
 WXGA (1280 × 800)					
 SXGA (1280 × 1024)					



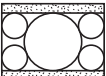
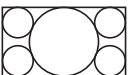



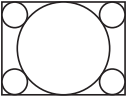
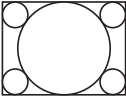
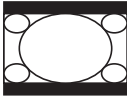
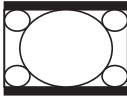
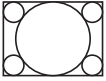
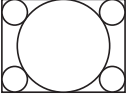
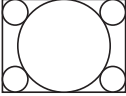

Input source: Video\*, S-Video\*, Component or HDMI(DTV)

Input Signal	Normal	16:9	16:10	4:3	Letter Box
 4:3 Aspect Image					
 Squeezed Image					
 Letter Box Image					
 16:9 Aspect Image					

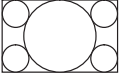

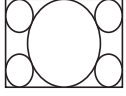

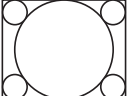
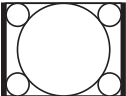
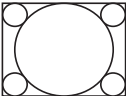



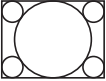
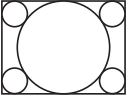
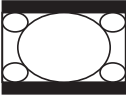

\* XJ-F100W/XJ-F200WN/XJ-F210WN only

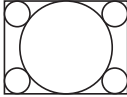
# XJ-V10X/XJ-F10X/XJ-F20XN

Input source: RGB or HDMI(PC)

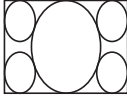
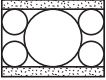
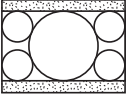
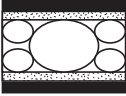
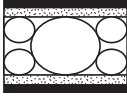
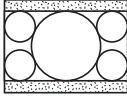
Input Signal	Normal	Full	16:9	16:10
 SVGA (800 × 600)				
 XGA (1024 × 768)				
 WXGA (1280 × 800)				
 SXGA (1280 × 1024)				

Input source: Video\*, S-Video\*, Component or HDMI(DTV)

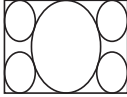
Input Signal	Normal	16:9	16:10	4:3
 4:3 Aspect Image				
 Squeezed Image				
 Letter Box Image				
 16:9 Aspect Image				

\* XJ-F10X/XJ-F20XN only

# Supported Signals



## Important!

- Even if a signal is listed in the table below, it does not guarantee that you will be able to display its images correctly.

## RGB Signal

	Signal Name	Resolution	Horizontal Frequency (kHz)	Vertical Frequency (Hz)
VESA	640 × 480/60	640 × 480	31.5	60
	640 × 480/72	640 × 480	37.9	73
	640 × 480/75	640 × 480	37.5	75
	640 × 480/85	640 × 480	43.3	85
	800 × 600/56	800 × 600	35.2	56
	800 × 600/60	800 × 600	37.9	60
	800 × 600/72	800 × 600	48.1	72
	800 × 600/75	800 × 600	46.9	75
	800 × 600/85	800 × 600	53.7	85
	1024 × 768/60	1024 × 768	48.4	60
	1024 × 768/70	1024 × 768	56.5	70
	1024 × 768/75	1024 × 768	60.0	75
	1024 × 768/85	1024 × 768	68.7	85
	1152 × 864/75	1152 × 864	67.5	75
	1280 × 720/60	1280 × 720	45.0	60
	1280 × 768/60	1280 × 768	47.8	60
	1280 × 800/60	1280 × 800	49.7	60
	1280 × 960/60	1280 × 960	60.0	60
	1280 × 1024/60	1280 × 1024	64.0	60
	1280 × 1024/75	1280 × 1024	80.0	75
	1280 × 1024/85	1280 × 1024	91.1	85
	1366 × 768/60	1366 × 768	47.7	60
	1400 × 1050/60	1400 × 1050	65.3	60
	1440 × 900/60	1440 × 900	55.9	60
1600 × 1200/60	1600 × 1200	75.0	60	
1680 × 1050/60	1680 × 1050	65.3	60	
1920 × 1080/60	1920 × 1080	67.5	60	
1920 × 1200RB/60	1920 × 1200	74.0	60	



## Component Signal

	Signal Name	Horizontal Frequency (kHz)	Vertical Frequency (Hz)
<b>HDTV</b>	1080p/50	56.3	50
	1080p/60	67.5	60
	720p/50	37.5	50
	720p/60	45.0	60
	1080i/50	28.1	50
	1080i/60	33.7	60
<b>SDTV</b>	576p/50	31.3	50
	576i/50	16.6	50
	480p/60	31.5	60
	480i/60	15.7	60

## Video Signal (XJ-F Series only)

Signal Name	Horizontal Frequency (kHz)	Vertical Frequency (Hz)
NTSC	15.7	60
NTSC4.43	15.7	60
PAL	15.6	50
PAL-M	15.7	60
PAL-N	15.6	50
PAL60	15.7	60
SECAM	15.6	50

## HDMI Signal

Signal Name	Horizontal Frequency (kHz)	Vertical Frequency (Hz)
640 × 480/60	31.5	60
800 × 600/60	37.9	60
1024 × 768/60	48.4	60
1280 × 720/60	45.0	60
1280 × 768/60	47.8	60
1280 × 800/60	49.7	60
1280 × 960/60	60	60
1280 × 1024/60	64	60
1400 × 1050/60	65.3	60
1920 × 1080/60	67.5	60
1920 × 1200RB/60	74.0	60
SDTV (480p)	31.5	60
SDTV (576p)	31.25	50
HDTV (720p) (50)	37.5	50
HDTV (720p) (60)	45	60
HDTV (1080i) (50)	28.13	50
HDTV (1080i) (60)	33.75	60
HDTV (1080p) (50)	56.25	50
HDTV (1080p) (60)	67.5	60

# Projector RS-232C Control

When there is a serial connection between the projector and a computer, you can control the projector using RS-232C commands sent from the computer.

## To establish a serial connection between the projector and a computer

Connect the projector and computer as shown in the illustration below.

### XJ-V Series

#### Projector

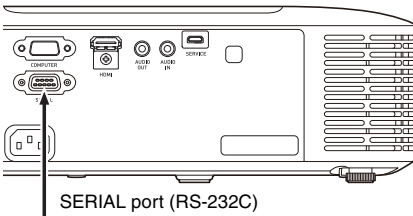

SERIAL port (RS-232C)

D-Sub 9-pin (female)

D-Sub 9-pin (female)

Commercially available serial cable (cross)

#### Computer

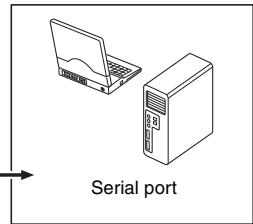

Serial port

### XJ-F Series

#### Projector

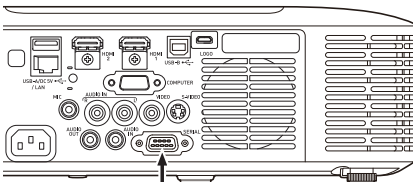

SERIAL port (RS-232C)

D-Sub 9-pin (female)

D-Sub 9-pin (female)

Commercially available serial cable (cross)

#### Computer

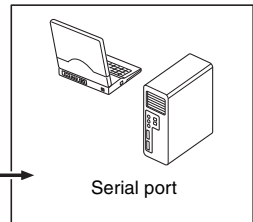

Serial port

## Using Control Commands

This section explains the commands that are used to control the projector from a computer.

### Command Send Format

<b>Communication Protocol</b>	Configure your computer's serial port with the following settings.	
	Data Rate	19200 bps
	Data Bit	8 bit
	Parity	None
	Stop Bit	1 bit
	Flow Control	None
<b>Read Command</b>	Send this command when you want information about the current setup of the data projector.	
	Send Format	(<command name>?)
	Receive Format	(<applicable command setting range>,<current setting>)
	Command Send Example	<p>[[VCL?]] sent from the computer to the projector.</p> <p style="text-align: center;">↓</p> <p>[[0-30.15]] returned from the projector to the computer.</p>
<b>Write Command</b>	Send this command to control the data projector (power on/off, etc.) and to write data to it.	
	Send Format	(<command name><setting value>)
	Command Send Example	<p>[[VCL0]] sent from the computer to the projector.</p> <p style="text-align: center;">↓</p> <p>Projector volume setting becomes 0.</p>

- See the “Command List” for details about command names and settings.
- All commands use ASCII characters and decimal format integers.
- The projector will return a question mark (?) when it is sent a command it cannot recognize. Also, any command that attempts to set a value that is outside the applicable allowable range will be ignored.
- If the projector is performing a process initiated by a previously sent command, a projector key operation, or a remote controller key operation, send of the next command must wait until the projector completes the previous process.

## Command List

- Only the following functions are supported while the projector is turned off. Do not try to send any other command to the projector.
  - Power on/off: Read
  - Power on: Write
  - Get light time: Read
- Input of a valid signal must be in progress in order to use a command to turn on blank screen or change the aspect ratio.

R: Read enabled W: Write enabled

Function	Command Name	RW	Settings
<b>Power On/Off:</b>	PWR	RW	0: Off, 1: On
<b>Input Switching:</b> <b>0:</b> Switches the input source to the COMPUTER terminal and changes the COMPUTER terminal setting to RGB. <b>1:</b> Switches the input source to COMPUTER terminal and changes the COMPUTER terminal setting to component. <b>2:</b> Switches the input source to Video. <b>6:</b> Switches the input source to COMPUTER terminal and changes the COMPUTER terminal setting to Auto. <b>7:</b> Switches the input source to "HDMI". <b>8:</b> Switches the input source to "Network". <b>9:</b> Switches the input source to "S-Video". <b>11:</b> Switches the input source to "File Viewer". <b>12:</b> Switches the input source to "USB Display". <b>13:</b> Switches the input source to "CASIO USB Tool". <b>14:</b> Switches the input source to "HDMI2". Settings 2, 9, and 14 are valid for XJ-F Series projectors only. Settings 8, 11, 12, and 13 are valid for network model projectors only.	SRC	RW	0: RGB, 1: Component 2: Video 6: Auto (RGB/Component) 7: HDMI, 8: Network 9: S-Video, 11: File Viewer 12: USB Display 13: CASIO USB Tool 14: HDMI2
<b>Blank Screen:</b> Switches the blank screen on or off.	BLK	RW	0: Off, 1: On
<b>Volume:</b> Specifies a value to adjust the volume level. This setting is applied to the input source signal that is currently being projected by the projector.	VOL	RW	0 to 30
<b>Color Mode:</b> Selects the color mode.	PST	RW	1: Graphics, 2: Theater 3: Standard, 4: Blackboard 5: Natural
<b>Aspect Ratio:</b> Specifies the aspect ratio. Setting 0 is the "Normal" setting when the input source is "RGB" or "HDMI(PC)", while setting 2 is the "Normal" setting when the input source is component, "HDMI(DTV)", "Video", or "S-Video".	ARZ	RW	0: Normal, 1: 16:9 2: Normal, 3: Letter Box 4: Full, 5: True, 6: 4:3 7: 16:10
<b>Get Light Time:</b> Gets the light time from the projector.	LMP	R	0- Unit: Hours

Function	Command Name	RW	Settings
<b>Light Control:</b> Configures the Light Control settings and Light Control Off Mode settings. Setting 2 is valid for XJ-F Series projectors only.	PMD	RW	0: Bright, 1: Normal 2: Light Sensor On 3: Light Output 7 4: Light Output 6 5: Light Output 5 6: Light Output 4 7: Light Output 3 8: Light Output 2 9: Light Output 1
<b>Freeze:</b> Switches freeze on or off.	FRZ	RW	0: Off, 1: On
<b>Keystone Correction:</b> Specifies the keystone correction setting as a value that corresponds to the typical Setup Menu "Keystone Correction" settings below. <b>0:</b> Keystone Correction -60 <b>60:</b> Keystone Correction 0 <b>120:</b> Keystone Correction +60 <b>Example:</b> 65 here, specifies a setting equivalent to Keystone Correction +5.	KST	RW	0 to 120
<b>Keystone Correction +/-:</b> Raises or lowers the current keystone correction setting by 1.	+ : KSP - : KSM	W	0 to 120
<b>Key:</b> Operation executed when a key is pressed. Settings 26 through 30 are valid for network model projectors only.	KEY	W	1: ▲, 2: ▼, 3: ◀, 4: ▶ 5: ENTER, 6: ESC, 10: FUNC 13: AUTO, 14: INPUT 15: TIMER, 16: ASPECT 17: BLANK, 18: FREEZE 19:  , 20: KEYSTONE + 21: KEYSTONE - 22: D-ZOOM + 23: D-ZOOM - 24: VOLUME + 25: VOLUME - 26: PLAY(▶▶▶) 27: REWIND(◀◀) 28: FORWARD(▶▶) 29: PREVIOUS(◀◀) 30: NEXT(▶▶)
<b>Setup Type:</b> Specifies how the projector is set up relative to screen for projection. <b>0:</b> Projection to a screen in front of the projector*1 <b>1:</b> Ceiling mounted projection from behind the screen*2 <b>2:</b> Projection from behind the screen*1 <b>3:</b> Ceiling mounted projection to a screen in front of the projector*2	POS	RW	0 to 3
<b>APO:</b> Used to change the Auto Power Off setting (trigger time setting or Auto Power Off disable).	APO	RW	0: Off, 1: 5 minutes 2: 10 minutes, 3: 15 minutes 4: 20 minutes, 5: 30 minutes
<b>Error:</b> Reads the projector error status.	STS	R	0: Normal, 1: Fan error 2: Temperature error 7: Light error, 16: Other error



### Note

- Each KEY command setting corresponds to a remote controller key. The projector operation that is performed in response to a KEY command is identical to the corresponding remote controller key operation. When sending KEY commands to the projector from an external device, make sure they are sent in the same sequence that the corresponding key operations are performed on the remote controller.

Function	Command Name	RW	Settings
<b>Volume +/-:</b> Raises or lowers the current volume setting by 1.	+: VLP -: VLM	W	0 to 30
<b>Mute:</b> Switches mute on or off.	MUT	RW	0: Off, 1: On
<b>Microphone Input Level:</b> Adjusts the volume level of audio input from the MIC terminal. This command is available only for network model projectors.	MIC	RW	0 to 3

\*1 Top of projector upwards

\*2 Top of projector downwards

**CASIO®**

**CASIO COMPUTER CO., LTD.**  
6-2, Hon-machi 1-chome  
Shibuya-ku, Tokyo 151-8543, Japan

MA1602-A

© 2016 CASIO COMPUTER CO., LTD.