

Table of Contents

Usage Notice

<i>Precautions</i>	2
--------------------------	---

Introduction

<i>Product Features</i>	4
<i>Package Overview</i>	5
<i>Product Overview</i>	6
<i>Main Unit</i>	6
<i>Panel Control</i>	7
<i>Connection Ports</i>	8
<i>Full Function Wireless Remote Controller</i>	9

Installation

<i>Connecting the Projector</i>	10
<i>Powering On/Off the Projector</i>	11
<i>Powering On the Projector</i>	11
<i>Powering Off the Projector</i>	12
<i>Adjusting the Projected Image</i>	13
<i>Adjusting the Projector Height</i>	13
<i>Adjusting the Projector Zoom/Focus</i>	14
<i>Adjusting Projection Image Size</i>	14

User Controls

<i>Panel Control & Remote Control</i>	15
<i>On-Screen Display Menus</i>	18
<i>How to Operate</i>	18
<i>Menu Tree</i>	19
<i>Picture</i>	20
<i>Image</i>	22
<i>System</i>	24
<i>Display</i>	25









Appendices

<i>Troubleshooting</i>	27
<i>Changing the Lamp</i>	30
<i>Specifications</i>	31
<i>Compatibility Modes</i>	32

Usage Notice

Precautions

Follow all warnings, precautions and maintenance as recommended in this user's guide to maximize the life of your unit.

-  **Warning-** Do not look into the lens. The bright light may hurt your eyes.
-  **Warning-** To reduce the risk of fire or electric shock, do not expose this product to rain or moisture.
-  **Warning-** Please do not open or disassemble the product as this may cause electric shock.
-  **Warning-** When changing the lamp, please allow unit to cool down, and follow all changing instructions.
-  **Warning-** This product will detect the life of the lamp itself. Please be sure to change the lamp when it shows warning messages.
-  **Warning-** After changing a new lamp, please reset the lamp life from OSD menu.
-  **Warning-** Before switching off the product, please keep the cooling fan running for a few minutes.
-  **Warning-** Turn on the projector first and then the signal sources.
-  **Warning-** When the lamp reaches the end of its life, it will burn out and may make a loud popping sound. If this happens, the projector will not turn back on until the lamp module has been replaced. To replace the lamp, follow the procedures listed under "Changing the Lamp".

Usage Notice

Do:

- ❖ Turn off the product before cleaning.
- ❖ Use a soft cloth moistened with mild detergent to clean the display housing.
- ❖ Disconnect the power plug from AC outlet if the product is not being used for a long period of time.

Don't:

- ❖ Block the slots and openings on the unit provided for ventilation.
- ❖ Use abrasive cleaners, waxes or solvents to clean the unit.
- ❖ Use under the following conditions:
 - Extremely hot, cold or humid environment.
 - In areas susceptible to excessive dust and dirt.
 - Near any appliance generating a strong magnetic field.
 - Place in direct sunlight.

Introduction

Product Features

This product is an XGA single chip 0.7" DLP™ projector. The outstanding features of it are listed as follows:

- ◆ True XGA, 1024 x 768 addressable pixels
- ◆ 6.4 lbs (2.9 kgs) compact design
- ◆ High contrast ratio 1800 : 1
- ◆ Single chip DLP™ technology
- ◆ PureProgressive™ processing technology for artifact-free film materials.
- ◆ HDTV compatible (480P/576P,1080i,720P)
- ◆ NTSC/NTSC4.43/PAL/PAL-M/PAL-N/SECAM and HDTV compatible
- ◆ High-tech DVI-I connection for digital and analog video connectivity
- ◆ Full function wireless remote controller
- ◆ User friendly multilingual on-screen display menu
- ◆ Advanced electronic keystone correction
- ◆ User friendly control panel
- ◆ Luxurious carrying case included
- ◆ SXGA compression and VGA, SVGA re-sizing
- ◆ 200 Watts replaceable UHP lamp
- ◆ Mac compatible

Introduction

Package Overview

This projector comes with all the items shown below. Check to make sure your unit is complete. Contact your dealer immediately if anything is missing.



Projector with lens cap



1
Power Cord



2
Composite Video Cable



3
D-15 to DVI Cable



4
S-Video Cable



5
RS232 Cable



6
D-15 to RCA Adapter
for YPbPr



7
Battery x 2



Wireless Remote
Controller



User's Guide



User's Manual



Carrying Case

Introduction

Product Overview

Main Unit



1. Panel Control
2. Power Connector & Power Switch
3. Connection Ports
4. Focus Ring
5. Zoom Lens
6. Zoom Ring
7. Remote Control Receiver
8. Elevator Button
9. Elevator Foot

Introduction

Panel Control

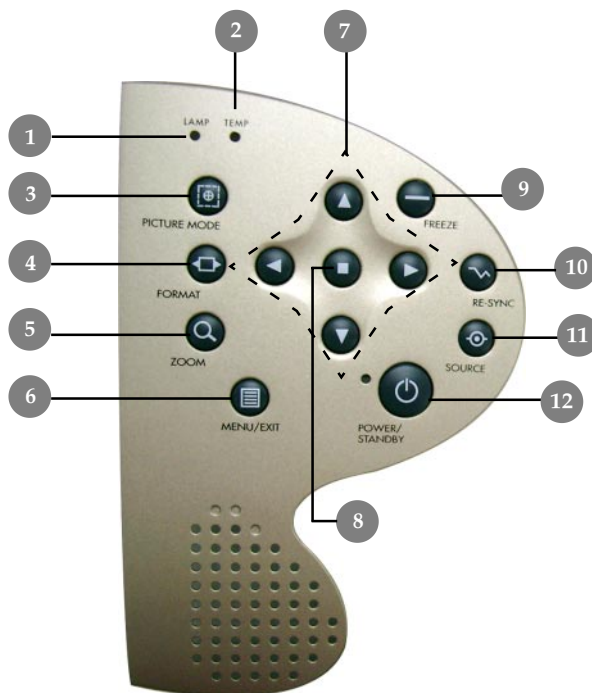

1. Lamp Warning LED
2. Temperature Warning LED
3. Picture Mode
4. Format
5. Zoom
6. Menu/Exit
7. Four Directional Select Keys
8. Enter
9. Freeze
10. Re-sync
11. Source
12. Power /Standby

Introduction

Connection Ports

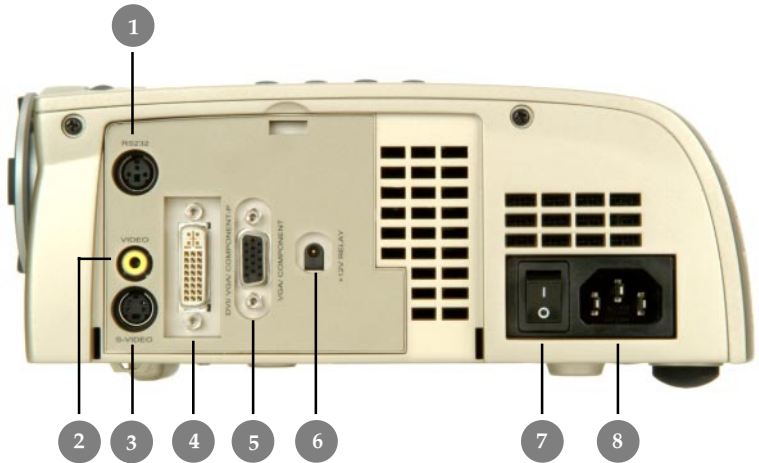

1. RS232 Input Connector
2. Composite Video Input Connector
3. S-Video Input Connector
4. DVI Input Connector
5. PC Analog Signal/HDTV/Component Video Connector
6. 12V Relay Connector
7. Power Switch
8. Power Connector

Introduction

Full Function Wireless Remote Controller

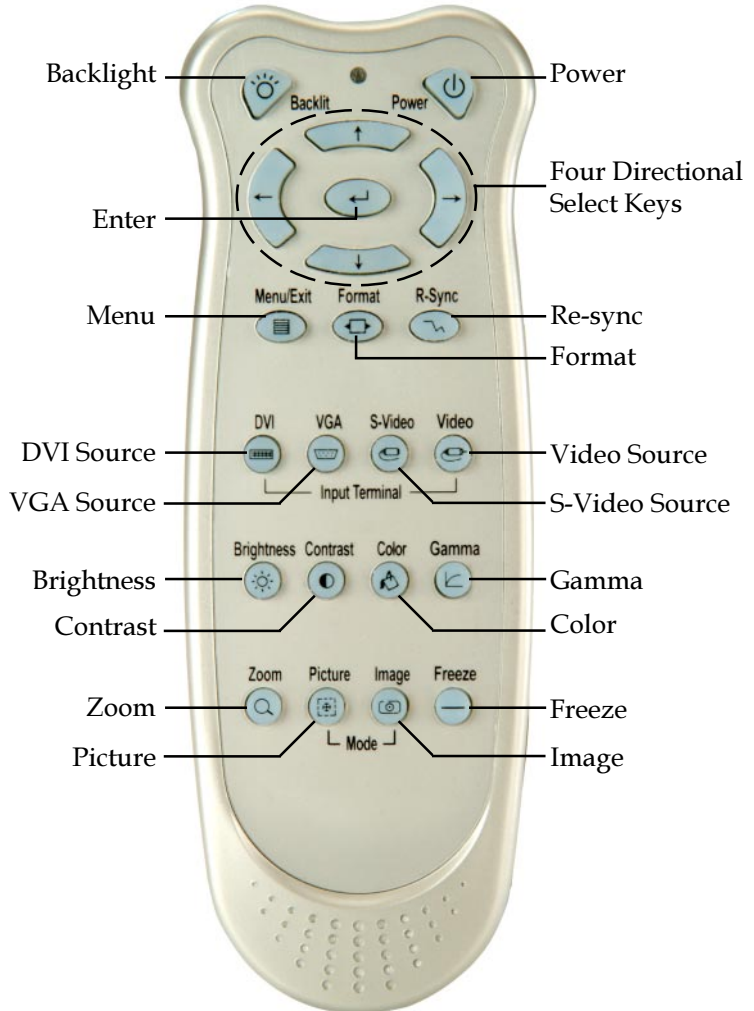

Installation

Connecting the Projector

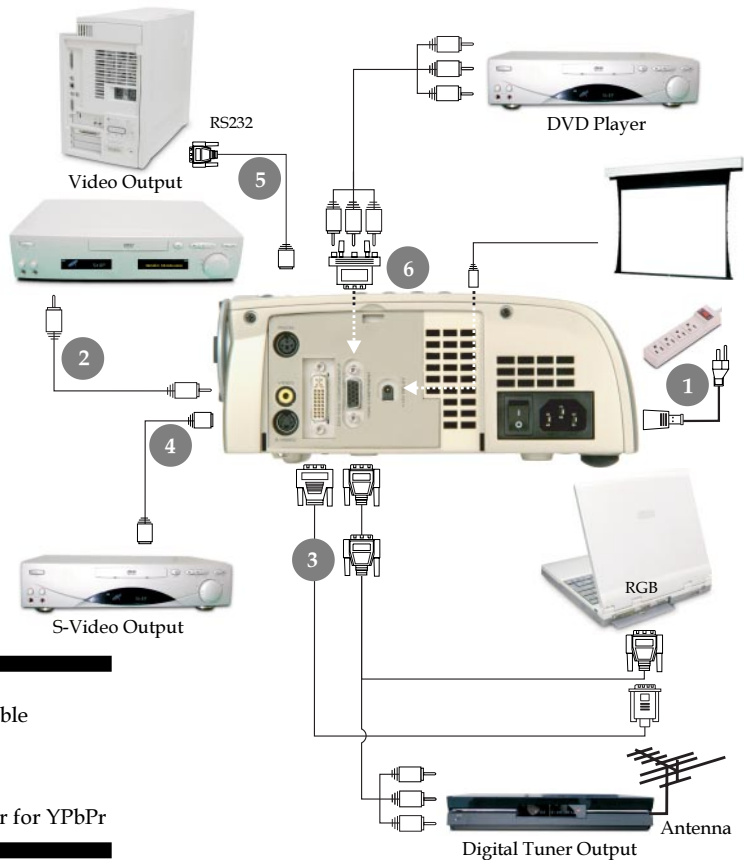

1. Power Cord
2. Composite Video Cable
3. D-15 to DVI Cable
4. S-Video Cable
5. RS232 Cable
6. D-15 to RCA Adapter for YPbPr

❖ *To ensure the projector works well with your computer, please configure the display mode of your graphic card to make it less than or equal to 1024 X 768 resolution. Make sure timing of the display mode is compatible with the projector. Refer to the "Compatibility Modes" section on page 32.*

Installation

Powering On/Off the Projector

Powering On the Projector

1. Remove the lens cap. ❶
2. Ensure that the power cord and signal cable are securely connected.
3. Turn on the main power switch on the side of the projector and allow the projector to warm up for 1-2 minutes. ❷
4. Turn on the lamp by pressing "Power/Standby" button on the control panel. ❸

The startup screen will display and count down for 20 seconds and the Power/Standby indicator will light solid amber.

The "LAMP" LED indicator will light solid green.

5. Turn on your source (computer, notebook, or video player, etc...) The projector will detect your source automatically.

- ❖ If the screen displays "No Signal", please make sure the signal cables are securely connected.
- ❖ If you connect multiple sources at the same time, use the "Source" button on the Remote Control or Panel Control to switch.



❖ Turn on the projector first and then the signal sources.



Installation

Powering Off the Projector

1. Press the “Power/Standby” button to turn off the projector lamp.
2. After pressing the “Power/Standby” button, you will see a message “Power off the lamp?” on the on-screen display. Press the “Power/Standby” button again to confirm. Otherwise the message will disappear after 5 seconds.
3. “Power/Standby” LED indicator will light solid amber for about 30 seconds. After the “Power/Standby” indicator starts flashing, you can turn off the main power switch on the side of the projector.

If you want to turn on the projector, you must press the “Power/Standby” button within 90 seconds of the start of the indicator flashing.

4. Do not turn on the projector immediately following a power off procedure.
- ❖ *When the “LAMP” indicator flashes green for about 10 seconds, you will see a message “Fan Fail” on the on-screen display. Please contact your local reseller or service center.*
 - ❖ *When the “TEMP” indicator lights solid orange, it indicates the projector has been overheated. You will see a message “Over Temperature” on the on-screen display. The projector will automatically shut itself down. Under normal conditions, the projector can be switched on again for your presentation. If the problem persists, you should contact your local reseller or service center.*

Installation

Adjusting the Projected Image

Adjusting the Projector Height

The projector is equipped with an elevator foot for adjusting the projector height.

To raise the projector:

1. Press the elevator button **1**.
2. Raise the projector to the desired display angle **2**, then release the button to lock the elevator foot into position.
3. Use **3** to fine-tune tilt-adjustment.

To lower the projector:

1. Press the elevator button.
2. Lower down the projector, then release the button to lock the elevator foot into position.
3. Use **3** to fine-tune tilt-adjustment.

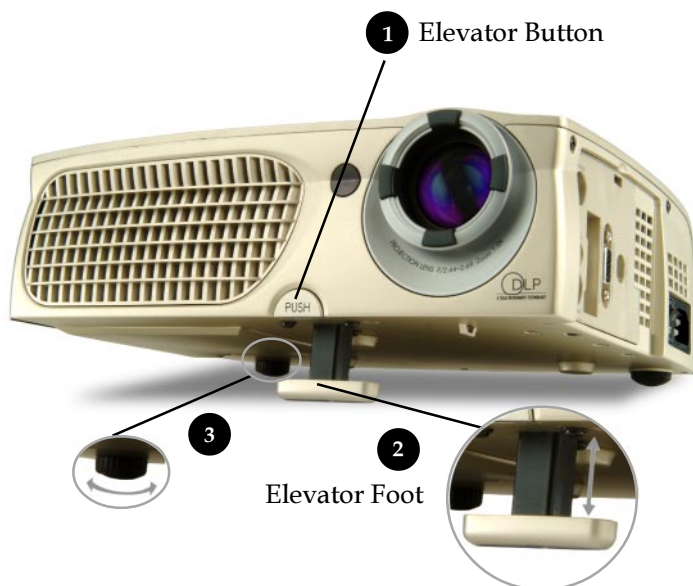

Installation

Adjusting the Projector Zoom / Focus

You may adjust zoom ring to zoom in / out. Rotate the zoom ring counter-clockwise to zoom in and clockwise to zoom out. To focus the image, rotate the focus ring until the image is clear. The projector will focus at distances from 3.74 feet to 40.68 feet (1.14m to 12.4m).



Adjusting Projection Image Size

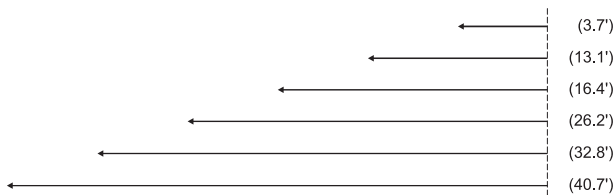
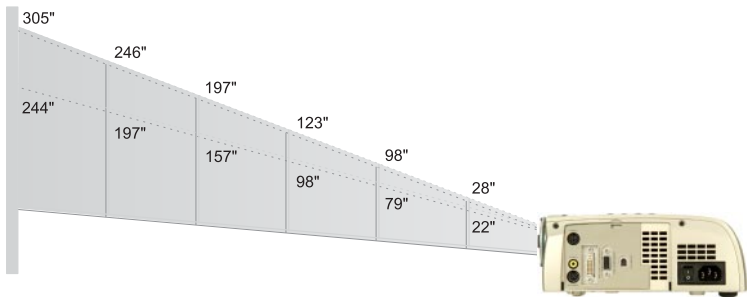

Screen (Diagonal)	Max.	28"	98"	123"	197"	246"	305"
	Min.	22"	79"	98"	157"	197"	244"
Screen Size	Max.(WxH)	22.4" x 16.8"	78.4" x 58.8"	98.4" x 73.8"	157.6" x 118.2"	196.8" x 147.6"	244.0" x 183.0"
	Min.(WxH)	17.6" x 13.2"	62.4" x 46.8"	78.4" x 58.8"	125.6" x 94.2"	157.6" x 118.2"	195.2" x 146.4"
Distance		3.7'	13.1'	16.4'	26.2'	32.8'	40.7'

❖ This graph is for user's reference only.

User Controls

Panel Control & Remote Control

There are two ways for you to control the functions: Remote Control and Panel Control.

Panel Control



Remote Control



Use the Remote Control





Backlit

- ▶ When you press "Backlit" button, all buttons on remote controller will flash fluorescent yellow. Return to normal mode, press "Backlit" button again.

Power

- ▶ Refer to the "Power On/Off the Projector" section on page 11~12.

Four Directional Select Keys

- ▶ Use     to select items or make adjustments for your selection.

Enter

- ▶ Confirm your selection of items.

User Controls

Menu

- ▶ Displays or exit the on-screen display (OSD) menus.

Format

- ▶ Displays the format item of the on-screen display (OSD) menu and selects your desired aspect ratio.

Re-Sync

- ▶ Automatically synchronizes the projector to the input source.

DVI

- ▶ Press "DVI" to choose Analog RGB, Analog DVI, Digital DVI, Digital RGB, Component-p and HDTV sources.

VGA

- ▶ Press "VGA" to choose Analog RGB, Analog YPbPr, Component and HDTV sources.

S-Video

- ▶ Press "S-Video" to choose S-Video source.

Video

- ▶ Press "Video" to choose Composite video source.

Brightness

- ▶ Adjusting the brightness of the image.

Contrast

- ▶ The contrast controls the degree of difference between the lightest and darkest parts of the picture.



Color

- ▶ The color setting adjusts a video image from black and white to fully saturated color.

Gamma

- ▶ Press the "Gamma" button to adjust scale.

Zoom

- ▶ When you press "Zoom" button, the zoom icon appears on the screen. Press  or  button to zoom in or zoom out of the image.

Picture Mode

- ▶ Displays the picture menu of the on-screen display (OSD) menu.

User Controls

Image Mode

- ▶ Displays the image menu of the on-screen display (OSD) menu.

Freeze

- ▶ Press the “Freeze” button to still the screen image.

Use the Panel Control

Power / Standby

- ▶ Refer to the “Power On/Off the Projector” section on page 11~12.



Source

- ▶ Press “Source” to choose RGB, DVI-Digital, DVI-Analog, S-Video, Composite, Component and HDTV sources.





Re-Sync

- ▶ Automatically synchronizes the projector to the input source.

Zoom

- ▶ When you press “Zoom” button, the zoom icon appears on the screen. Press  or  button to zoom in or zoom out of the image.

Four Directional Select Keys

- ▶ Use     to select items or make adjustments for your selection.

Enter

- ▶ Confirm your selection of items.

Menu/Exit

- ▶ Displays or exit the the on-screen display (OSD) menus.

Picture Mode

- ▶ Displays the picture menu of the on-screen display (OSD) menu.

Format

- ▶ Displays the format item of the on-screen display (OSD) menu and selects your desired aspect ratio.

Freeze

- ▶ Press the “Freeze” button to still the screen image.

User Controls

On-Screen Display Menus

How to operate

- ▶ The Projector has multilingual On-Screen Display(OSD) menus that allow you to make image adjustments and change a variety of settings. The projector will detect the source automatically.
- ▶ To open the OSD menu, press the “Menu” button on the Remote Control or Panel Control.
- ▶ When OSD is displayed, press ◀ ▶ key to select main menu. While making selection on a particular icon, press “Enter” key to go into sub-menu.
 - ◆ To exit the OSD, press the “Menu” button.
- ▶ When sub-menu is displayed, press ▲ ▼ key to select the required item and adjust the settings by ◀ ▶ key.
 - ◆ To go to main menu, press the “Menu” button.
- ▶ After using ◀ ▶ key to adjust the parameter or required function in the items of the sub-menu, press “Enter” button to confirm your change and the screen will be back to the sub-menu at once.
 - ◆ Press the “Menu” button to go back sub-menu. If you don’t press “Enter” button to confirm your change and exit the screen at once, the items will not to be modified.

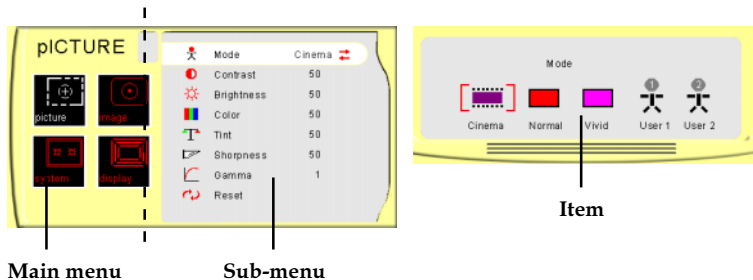

User Controls

Menu tree

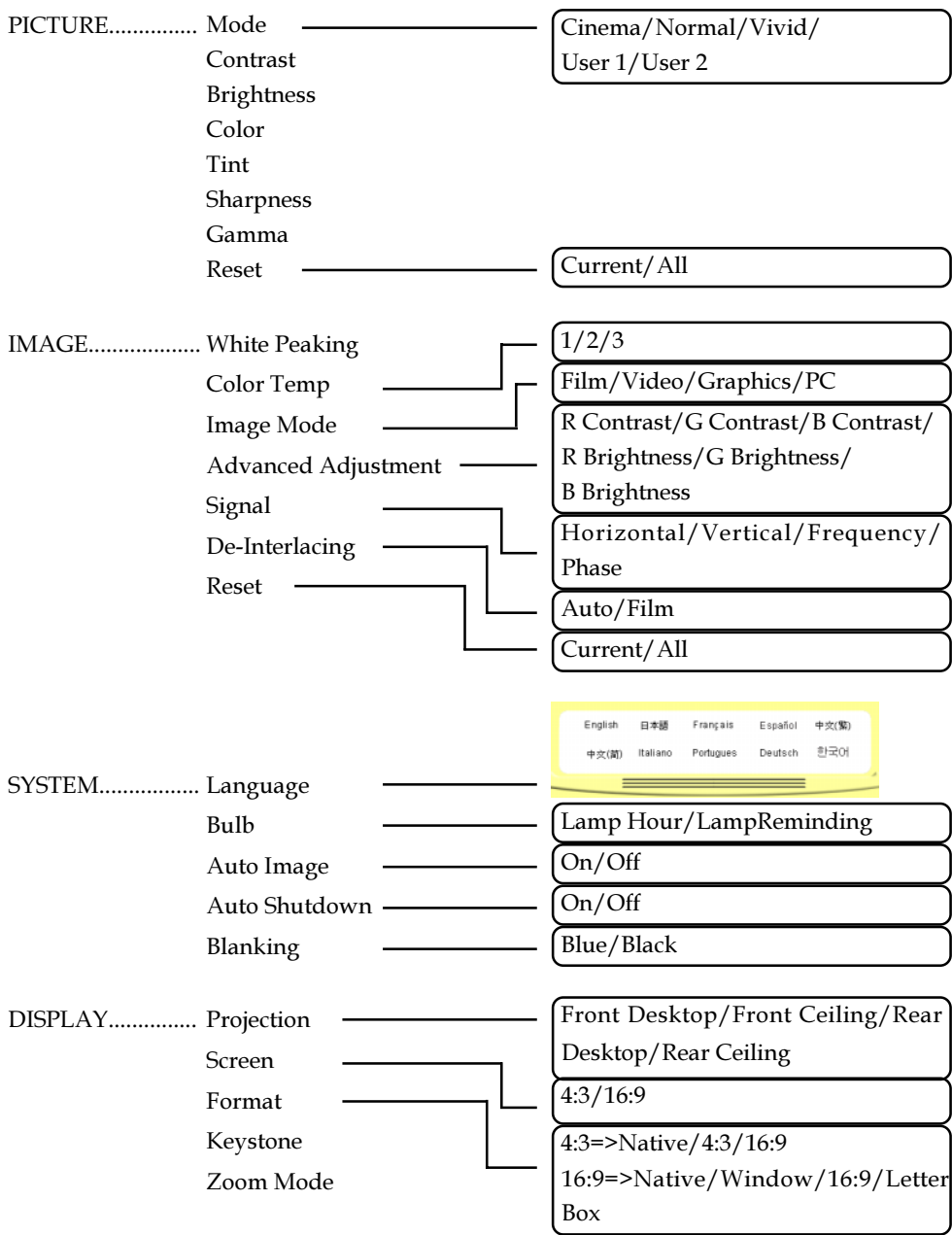

User Controls

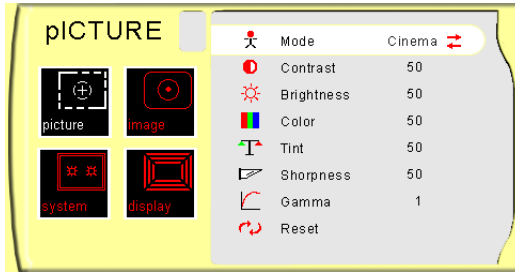

PICTURE

Mode

There are 3 factory presets optimized for various types of pictures, or you can set 2 user adjustable settings. When selecting User 1 or 2, the submenu below will be displayed. You can customize each contrast, brightness, intensity, color, tine, sharpness, and gamma.

Contrast

The contrast controls the degree of difference between the lightest and darkest parts of the picture. Adjusting the contrast changes the amount of black and white in the image.

- ▶ Press the ◀ to decrease the contrast.
- ▶ Press the ▶ to increase the contrast.

Brightness

Adjusting the brightness of the image.

- ▶ Press the ◀ to darken image.
- ▶ Press the ▶ to lighten the image.

Color

The color setting adjusts a video image from black and white to fully saturated color.

- ▶ Press the ◀ to decrease the amount of color in the image.
- ▶ Press the ▶ to increase the amount of color in the image.

Tint

The tint adjusts the color balance of red and green.

- ▶ Press the ◀ to increase the amount of green in the image.
- ▶ Press the ▶ to increase the amount of red in the image.

Sharpness

Adjusting the sharpness of the image.

- ▶ Press the ◀ to decrease the sharpness.
- ▶ Press the ▶ to increase the sharpness.



❖ The “Color” submenu is not supported under the Digital RGB input source.

❖ The “Tint” submenu is not supported under the Digital RGB, Component Video and Analog RGB input sources.

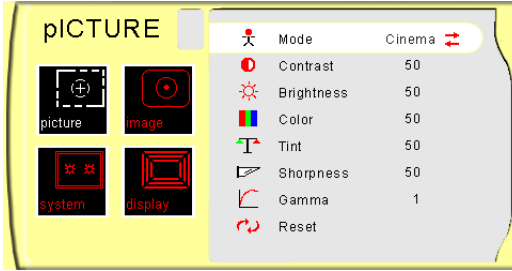

PICTURE

Gamma

Effects the represent of dark scenery. With greater gamma value, dark scenery will look brighter.

Reset

Changes the adjustments and settings to the factory default value.

- ▶ Current : Reset the adjustments for the current settings to the factory default value.
- ▶ All : Reset the adjustments and setting for all menu to the factory default value.

User Controls

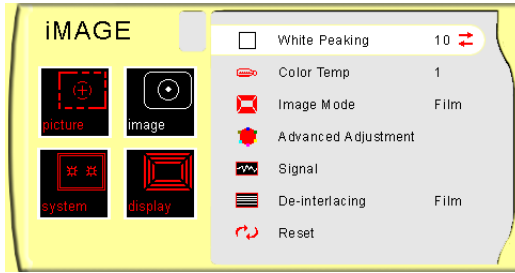

IMAGE

White Peaking

Use the white segment control to set the white peaking level of DMD chip. 0 stands for minimal peaking, and 10 stands for maximum peaking. If you prefer a stronger image, adjust toward the maximum setting. For a smooth and more natural image, adjust toward the minimum setting.

Color Temp

Adjust the color temperature. The range is from “1” to “3”. With the higher temperature, the screen looks colder; with the lower temperature, the screen looks warmer.

Image Mode

There are 4 factory presets optimized for various types of images.

- ▶ Film : For home theater.
- ▶ Video : For video mode.
- ▶ Graphics : For graphics.
- ▶ PC : For computer or notebook.

Advanced Adjustment

Use the ◀ or ▶ to select R (Red), G (Green), or B (Blue) for brightness and the contrast.

Signal

- ▶ Horizontal : Adjusting the horizontal position.
- ▶ Vertical : Adjusting the Vertical position.
- ▶ Frequency : Changes the display data frequency to match the frequency of your computer’s graphic card. When you experience a vertical flickering bar, use this function to make an adjustment.
- ▶ Phase : Synchronizes the signal timing of the display with that of the graphic card. When you experience an unstable or flickering image, use this function to correct it.



❖ The “Signal” sub-menu is supported under the Analog RGB and Analog YPbPr input sources.

User Controls

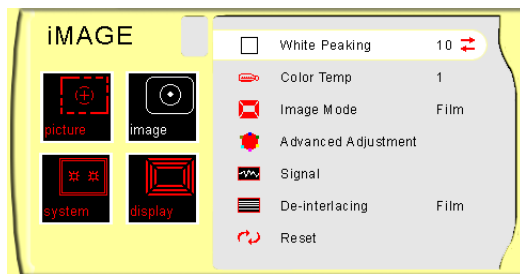

IMAGE



❖ The “De-interlacing” sub-menu is supported under the S-video, Composite video and Component video input sources.

De-Interlacing

Reduces interlacing the image from video source.

- ▶ Film : For home theater.
- ▶ Auto : automation.

Reset

Changes the adjustments and settings to the factory default value.

- ▶ Current : Reset the adjustments for the current settings to the factory default value.
- ▶ All : Reset the adjustments and setting for all menu to the factory default value.

User Controls

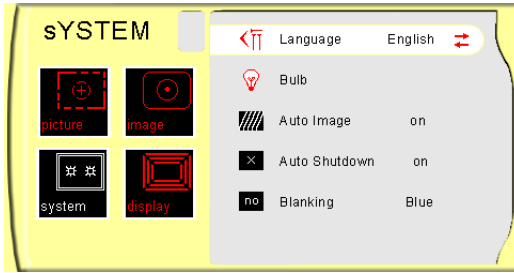

SYSTEM

Language

You can display the multilingual OSD menu . Use the ◀ and ▶ key to select your preferred language.

Bulb

- ▶ Lamp Hour : Displays the cumulative lamp operating time.
- ▶ Lamp Reminding : Choose this function to show or to hide warning message when the changing lamp message is displayed. The message will show up when the lamp reaches to 2000 hours.

Auto Image

When select “On”, the projector will search other signals when current input signal is lost. Otherwise, it will keep searching for the “lost signal”, after “Source” button is pressed.

Auto Shutdown

Decides the time interval to shutdown the system, if there is no signal input. Choose “On” to turns the projector off automatically.

Blanking

Use this feature to display a black or blue screen when no signal is available.

User Controls

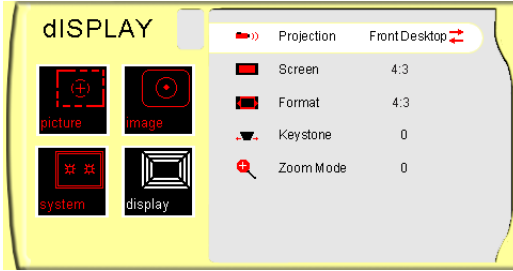

DISPLAY

Projection

- ▶  **Front-Desktop**

The factory default setting.

- ▶  **Rear-Desktop**

When you select this function, the projector reverses the image so you can project behind a translucent screen.

- ▶  **Front-Ceiling**

When you select this function, the projector turns the image upside down for ceiling-mounted projection.

- ▶  **Rear-Ceiling**

When you select this function, the projector reverses and turns the image upside down at same time. You can project from behind a translucent screen with ceiling mounted projection.

Screen

Select which type screen you are using : 4:3 or 16:9.

Format

When 4:3 screen type is selected, the OSD will display →



When 16:9 screen type is selected, the OSD will display →

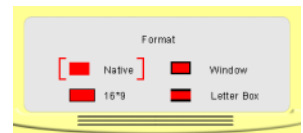

User Controls

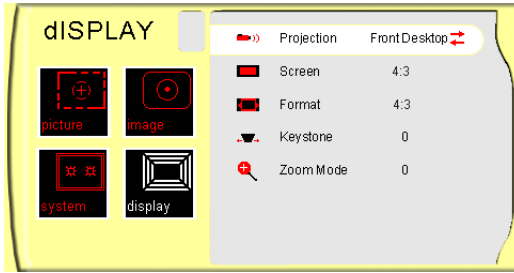

DISPLAY

- ▶ Native : Original image size.
- ▶ Letter Box : When a 4:3 DVD title is projected on the 16:9 screen, there will be a very “Small” image displayed. Letter box mode will let image full of the screen.



Original

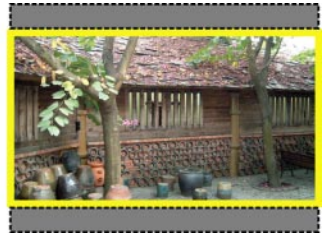

Letter-Box

- ▶ Window : When a 4:3 image is bigger than user’s 16:9, you may choose “Window” mode to shrink image to fit the screen without changing projection distance.



Original



Window

Keystone

Adjust image distortion caused by tilting the projector.

Zoom Mode

Provides different magnification ratios to zoom an image. Image will be centered after zooming.

Appendices

Troubleshooting

If you are experiencing trouble with the projector, refer to the following. If the problem persists, please contact your local reseller or service center.

Problem : No image appears on screen.

- ▶ Ensure all the cables and power connections are correctly and securely connected as described in the “Installation” section.
- ▶ Ensure the pins of connectors are not crooked or broken.
- ▶ Check if the projection lamp has been securely installed. Please refer to the “Changing the lamp” section.
- ▶ Make sure you have removed the lens cap and the projector is switched on.

Problem : Partial, scrolling or incorrectly displayed image.

- ▶ Press the “Re-Sync” button on the Remote Control or Panel Control.
- ▶ If you use a PC:

If the resolution of your computer is higher than 1024 x 768. Follow the steps outlined below to reset the resolution.

For Windows 3.x:

1. In the Windows Program Manager, click the “Windows Setup” icon in the Main group.
2. Verify that your display resolution setting is less than or equal to 1024 x 768.

For Windows 95,98,2K,XP:

1. Open “My Computer” icon, the “Control Panel” folder, and then double click the “Display” icon.
2. Select the “Setting” tab.
3. In the “Desktop Area” you will find the resolution setting. Verify that the resolution setting is less than or equal to 1024 x 768 resolution.

If the projector is still not projecting the whole image, you will also need to change the monitor display you are using. Refer to the following steps.

Appendices

4. Follow above steps 1~2. Click on the “Advanced Properties” button.
 5. Select the “Change” button under the “Monitor” tab .
 6. Click on “Show all devices” . Then select “Standard monitor types” under the “Manufactures” box ; choose the resolution mode you need under the “Models” box.
 7. Verify that the resolution setting of the monitor display is less than or equal to 1024 x 768.
- ▶ If you are using a Notebook PC:
 1. You are required to implement above steps of resolution setting of computer first.
 2. Switch the Notebook PC display to the “external display only” or “CRT only” mode.
 - ▶ If you are experiencing difficulty in changing resolutions or your monitor freezes, restart all the equipment and the projector.

Problem : The screen of the Notebook or PowerBook computer is not displaying your presentation.

- ▶ If you are using Notebook PC:
Some Notebook PCs may deactivate their own computers’ screen when a second display device is in use. Each of them has a different way to be reactivated. Refer to your computer’s documentation for detailed information.
- ▶ If you are using an Apple PowerBook:
In Control Panels, open the PowerBook Display to select Video Mirroring “On”.

Problem : Image is unstable or flickering

- ▶ Use “Phase” to correct it.
- ▶ Change the monitor color setting from your computer.

Problem : Image has vertical flickering bar

- ▶ Use “Frequency” to make an adjustment.
- ▶ Check and reconfigure the display mode of your graphic card to make it compatible with the product.

Appendices

Problem : Image is out of focus

- ▶ Adjust the Focus Ring on the projector lens.
- ▶ Make sure the projection screen is between the required distance 3.74ft.(1.14m)~ 40.68ft.(12.4m) from the projector.

Problem : The screen is outstretched when displaying 16:9 DVD.

The projector itself will automatically detect 16:9 DVD and adjust the aspect ratio by digitization to full screen with 4:3 default setting.

If the projector is still outstretched, you will also need to adjust the aspect ratio by referring to the following:

- ▶ Please select 4:3 aspect ratio type on your DVD player if you are playing a 16:9 DVD.
- ▶ If you can't select 4:3 aspect ratio type on your DVD player, please select 4:3 On Screen-Display(OSD) function of the projector for your display.

Problem : Image is reversed.

- ▶ To open "Menu" then select "Display" to adjust the projection.

Problem : Lamp burns out or makes a popping sound

- ▶ When the lamp reaches its end of life, it will burn out and may make a loud popping sound. If this happens, the projector will not turn back on until the lamp module has been replaced. To replace the lamp, follow the procedures in the "Changing the Lamp".

Appendices

Changing the Lamp

The projector will detect the lamp life itself. It will show you a warning message "Lamp may fail soon ! Replacement Suggested !" When you see this message, please contact your local reseller or service center to change the lamp as soon as possible.



Warning : Lamp compartment is hot! Allow it to cool down before changing lamp!

Make sure the projector has been cooled down for at least 30 minutes before changing the lamp.

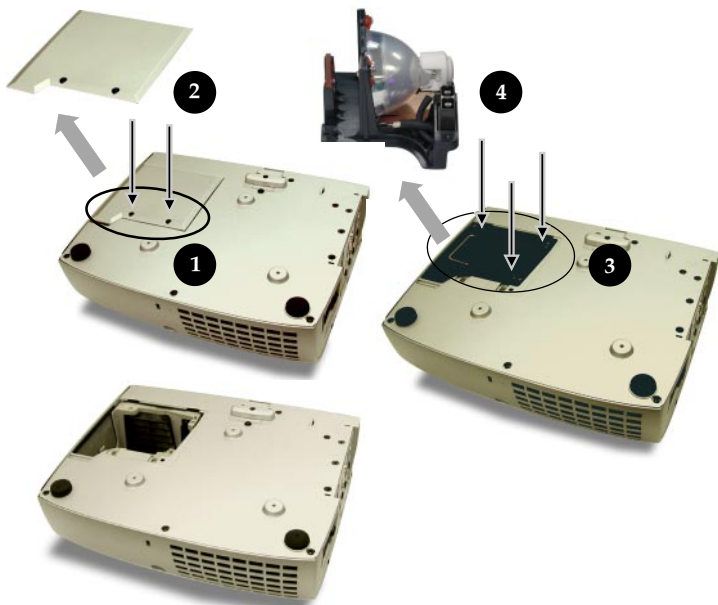

Warning : To reduce the risk of personal injury, do not drop the lamp module or touch the lamp bulb. The bulb may shatter and cause injury if it is dropped.

Lamp Changing Procedure:

1. Turn off the power to the projector by pressing the Power/ Standby button.
2. Allow the projector to cool down : at least 30 minutes.
3. Turn off the main power switch.
4. Disconnect the power cord.
5. Use screwdriver to remove the screw from the cover. ❶
6. Remove the cover. ❷
7. Remove the 3 screws from the lamp module. ❸
8. Pull out the lamp module. ❹

To replace the lamp module, reverse the previous steps.

Appendices

Specifications

Light Valve	- Single Chip DLP™ Technology
Contrast Ratio	- 1800:1 (Full On / Full Off)
Lamp	- 200W Replaceable UHP Lamp
Number of Pixels	- 1024 pixels(H) X 768 lines(V)
Displayable Color	- 16.7M colors
Projection Lens	- F/2.44~2.69 f=28.8~34.5mm with 1.2 x zoom & focus
Projection Screen Size	- 22"~305" Diagonal
Projection Distance	- 3.74~40.68 ft (1.14m~12.4m)
Video Compatibility	- NTSC/NTSC 4.43/PAL/PAL-M/PAL-N/SECAM and HDTV compatible
H. Frequency	- 15kHz~100kHz horizontal scan
V. Frequency	- 43Hz~120Hz vertical refresh
Power Supply	- Universal AC input 100~240V ; Input Frequency 50-60Hz
Power Consumption	- 320 watts at normal operation
Uniformity	- 90 %
I/O Connectors	- Power: AC power input socket - DVI Terminal: Digital RGB, Analog RGB and Analog YPbPr - VGA Terminal: Analog RGB, Analog YPbPr and YCbCr - S-Video Terminal - Composite Video Terminal
Weight	- 6.4 lbs / 2.9 kgs
Dimensions (W x H x D)	- 10.9 x 3.3 x 8.9 inches / 277 x 85 x 225 mm
Environmental	- Operating Temperature: 0°C~ 40°C/32°F~104°F Humidity: 80% maximum - Storage Temperature: -10°C~60°C/14°F~140°F Humidity: 80% maximum
Safety Regulation	- FCC Class B, CE Class B, VCCI-II, UL, cUL, TÜV, CCC, PSE

Appendices

Compatibility Modes

Mode	Resolution	(ANALOG)	
		V.Frequency (Hz)	H.Frequency (kHz)
VESA VGA	640 X 350	85	37.9
VESA VGA	640 X 400	85	37.9
VESA VGA	640 X 480	60	31.5
VESA VGA	640 X 480	72	37.9
VESA VGA	640 X 480	75	37.5
VESA VGA	640 X 480	85	43.3
VESA VGA	720 X 400	85	37.9
SVGA	800 X 600	56	35.2
SVGA	800 X 600	60	37.9
SVGA	800 X 600	72	48.1
SVGA	800 X 600	75	46.9
SVGA	800 X 600	85	53.7
VESA XGA	1024 X 768	43	35.5
VESA XGA	1024 X 768	60	48.4
VESA XGA	1024 X 768	70	56.5
VESA XGA	1024 X 768	75	60.0
VESA XGA	1024 X 768	85	68.7
* VESA SXGA	1280 X 1024	60	63.98
* VESA SXGA	1280 X 1024	75	79.98
MAC LC13"	640 X 480	66.66	34.98
MAC II 13"	640 X 480	66.68	35
MAC 16"	832 X 624	74.55	49.725
MAC 19"	1024 X 768	75	60.24
* MAC	1152 X 870	75.06	68.68
MAC G4	640 X 480	60	31.35
MAC G4	640 X 480	120	68.03
MAC G4	1024 X 768	120	97.09
I MAC DV	640 X 480	117	60
I MAC DV	800 X 600	95	60
I MAC DV	1024 X 768	75	60
* IMAC DV	1152 X 870	75	68.94
* IMAC DV	1280 X 1024	75	75



Remark : "*" compression computer image.