

# EIKI

## Owner's Manual

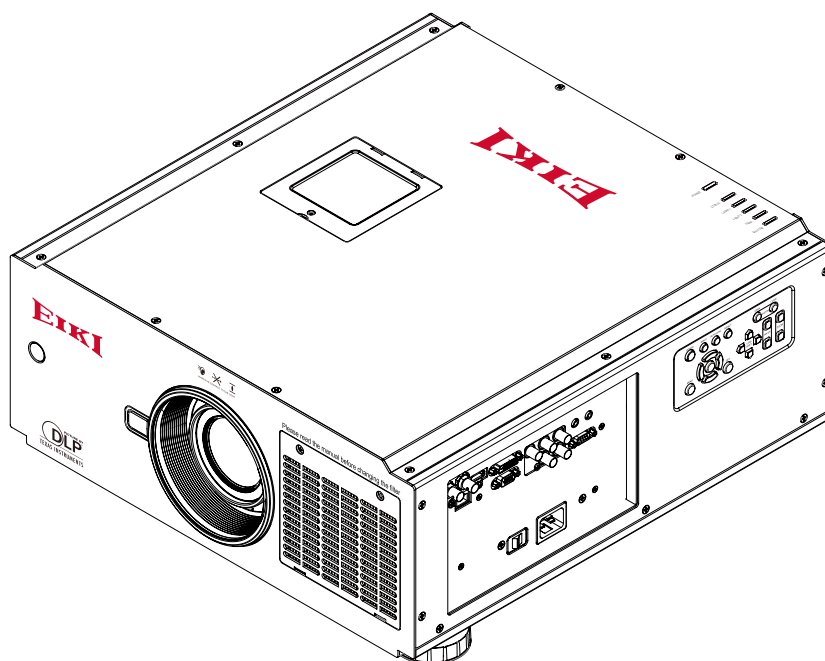

## Multimedia Projector

Model EIP-UHS100

EIP-XHS100

(Projection lens is optional.)

**ProSelecta**

View :: Compare :: Select - [www.ProSelecta.com](http://www.ProSelecta.com)

## **Feature and Design**

### **DLP™ Projector with High Resolution**

The Projector with the high performance Digital Micromirror Device (DMD) in conjunction with the advanced Liquid Cooling technology to provide the excellent projecting performance and reliability.

### **Motor-driven Lens Control**

Projection lens can be moved up, down, right and left with the motor-driven lens shift function. This function makes it easy to provide projected image where you want. Zoom and focus can also be adjusted with a motor-driven operation.

### **Complete projection lens options**

Seven types of motorized projection lens can be an option for EIP-UHS100/EIP-XHS100, the projection lenses can cover the throw ratio range from 0.75:1 to 8.56:1 and is suitable to be used in most of applications.

### **Quick Lens Change design**

The interchangeable lens design allows the user to easily and quickly change the suitable lens by pressing the Lens Release button on front cover.

### **Built-in Lens Memory functions**

Lens memory function allows you to store and recall the lens control setting up to 10 sets. The lens position, focus and zoom settings can be saved in the projector and recall for quick projector setup.

### **User Changeable Color Wheel**

The projector is equipped with smart color wheel detection and modulized color wheel. Plug in the color wheel, the projector can automatically detect and switch the parameter of corresponding color wheel for high brightness or rich color reproduction projection.

### **Built-in e-Warping Engine**

The projector is equipped with built-in e-warping engine to support to geometry correction like keystone, four corners,

pincushion/barrel correction and image rotation.

### **Built-in Edge Blending and Blending Function**

The projector has built in edge blending and blank function. Using edge blending function of the projector can create seamless displays by overlapping projector images and blending the edges.

### **Various Lamp Power Options**

The advanced dual-lamp optical engine as well as the single-lamp, dual-lamp, Normal, Eco (energy-saving) and Custom Power Level mode offer the convenience for installation and maintenance. Custom Power Level option allows you to adjust the lamp power from 100% to 80.4% to fine-tune the brightness of projectors.

### **Shutter Function**

The projector is equipped with the shutter that provides complete blackness for a while the projected image is not needed with keeping the projector on.

### **Wired LAN Function**

This projector is loaded with a wired LAN function to control and set-up the projector remotely via network including general projector setup, lens control... etc.

### **High-Density Filter**

The projector is designed with a higher density filter to limit the amount of dust that can settle on the internal components and reduce the lamp life or dull the image. It's easy to vacuum the dust off or replace the filter when the time comes to clean or replace the filter.

### **Picture-In-Picture**

This projector is capable of projecting two images simultaneously by using Picture In Picture function. The function offers various options to select main/submenu position and input source. For details, refer to the section.

## Index

Feature and Design .....	2
To the Owner.....	5
Safety Instructions .....	6
Installing the Projector in Proper Directions .....	7
Positioning Precautions .....	7
Compliance .....	8
Standard Accessories.....	9
Optional Accessories.....	10
Optional Lenses and Projection Size .....	10
Complete projection lens series as below table .....	10
Projection Size v.s Distance.....	11
<b>Overview.....</b>	<b>12</b>
Projector contents .....	12
Part Names and Functions .....	12
Terminals and Connectors .....	13
Control Keys and Indicators .....	14
Control Keys .....	14
LED Indicator .....	15
Remote Control .....	16
Remote Control Battery Installation .....	17
Remote Control Receivers and Operation Range .....	17
Wired Remote Control .....	18
Installation .....	19
Lens Installation.....	19
Lens replacement.....	20
To replace the projector Lens .....	20
Positioning Projector .....	21
Picture Level and Pitch Adjustment .....	21
Adjusting the Picture Orientation .....	21
Lens Shift Adjustment .....	22
Vertical / Horizontal Lens Shift.....	22
Connecting to Computer .....	23
Connecting to Video Equipment.....	24
Cable used for connection .....	24
Trigger connection .....	25
RS-232 Connection .....	26
LAN Connection .....	26
Connecting to wired remote controller .....	27
Connecting the AC Power Cord.....	28





<b>Basic Operation .....</b>	<b>29</b>
Turning On the Projector .....	29
Turn Off the Projector .....	29
Selecting an Input Source .....	30
Selecting a Aspect Ratio .....	30
How to Operate the On-Screen Menu.....	31
OSD Operation.....	31
Changing the OSD Language.....	32
OSD Tree .....	33
OSD Operation-INPUT.....	37
OSD Introduction – PICTURE.....	40
OSD Introduction – LAMPS .....	43
OSD Introduction - ALIGNMENT .....	44
OSD Introduction – CONTROL.....	48
OSD Introduction – SERVICE.....	49
<b>Maintenance and Care .....</b>	<b>51</b>
Lamp Replacement .....	51
<b>Maintenance and Care .....</b>	<b>53</b>
Change Filters .....	53
Change the color wheel .....	55
Warning Indicators .....	57
<b>Apendix .....</b>	<b>58</b>
Technical Specification.....	58
<b>Product Outline Dimension.....</b>	<b>59</b>
<b>Support Timing List .....</b>	<b>60</b>
Serial Control Interface.....	61
Projector Control via LAN .....	62
Configurations of Terminals.....	68

---

## To the Owner

Before installing and operating the projector, read this manual thoroughly. The projector provides many convenient features and functions. Operating the projector properly enables you to manage those features and maintains it in good condition for many years to come. Improper operation may result in not only shortening the product life, but also malfunctions, fire hazard, or other accidents.

If the projector seems to operate improperly, read this manual again, check operations and cable connections and go to “Troubleshooting” section in the later part of this manual. If the problem still persists, contact the dealer where you purchased the projector or the service center.

	<b>CAUTION</b> <b>RISK OF ELECTRIC SHOCK</b> <b>DO NOT OPEN</b>	
<b>CAUTION: TO REDUCE THE RISK OF ELECTRIC SHOCK, DO NOT REMOVE COVER (OR BACK). NO USER-SERVICEABLE PARTS INSIDE EXCEPT LAMP REPLACEMENT. REFER SERVICING TO QUALIFIED SERVICE PERSONNEL.</b>		
	THIS SYMBOL INDICATES THAT DANGEROUS VOLTAGE CONSTITUTING A RISK OF ELECTRIC SHOCK IS PRESENT WITHIN THIS UNIT.	
	THIS SYMBOL INDICATES THAT THERE ARE IMPORTANT OPERATING AND MAINTENANCE INSTRUCTIONS IN THE OWNER'S MANUAL WITH THIS UNIT.	
<b>FOR EU USERS</b> The symbol mark and recycling systems described below apply to EU countries and do not apply to countries in other areas of the world. Your product is designed and manufactured with high quality materials and components which can be recycled and/or reused. The symbol mark means that electrical and electronic equipment, batteries and accumulators, at their end-of-life, should be disposed of separately from your household waste. Note: If a chemical symbol is printed beneath the symbol mark, this chemical symbol means that the battery or accumulator contains a heavy metal at a certain concentration. This will be indicated as follows: Hg: mercury, Cd: cadmium, Pb: lead. In the European Union there are separate collection systems for used electrical and electronic equipment, batteries and accumulators. Please, dispose of them correctly at your local community waste collection/recycling centre. Please, help us to conserve the environment we live in!		



## Safety Precaution

**WARNING:** • THIS APPARATUS MUST BE EARTHED.

• TO REDUCE THE RISK OF FIRE OR ELECTRIC SHOCK, DO NOT EXPOSE THIS APPLIANCE TO RAIN OR MOISTURE.

This projector produces intense light from the projection lens. Do not stare directly into the lens, otherwise eye damage could result. Be especially careful that children do not stare directly into the beam.

Install the projector in a proper position. Otherwise it may result in a fire hazard.

Allowing the proper amount of space on the top, sides, and rear of the projector cabinet is critical for proper air circulation and cooling of the unit. The illustrations indicates the

required distance from the ceiling. If the projector is to be built into a compartment or similarly enclosed, these minimum distances must be maintained.

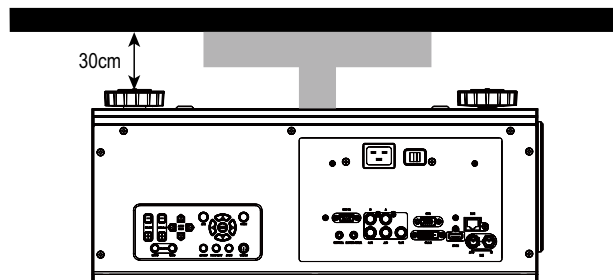
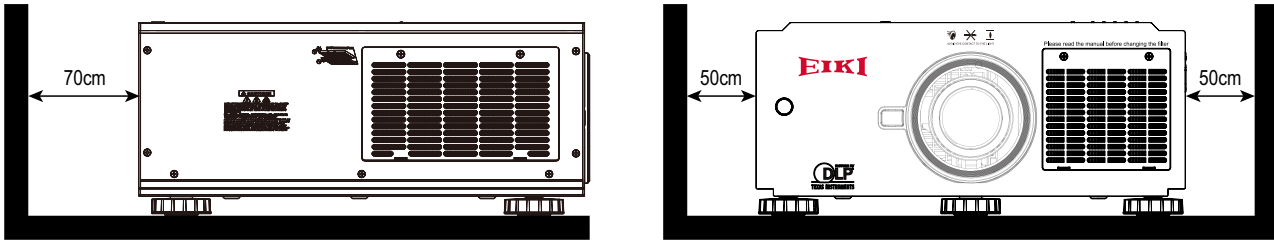

Do not cover the ventilation slots on the projector. Heat buildup can reduce the service life of your projector, and can also be dangerous.

If the projector is unused for an extended time, unplug the projector from the power outlet.



#### CAUTION ON HANGING FROM THE CEILING

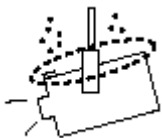

When hanging the projector from the ceiling, keep the air intake vents and the top clean. If you leave the projector unclean for a long time, the cooling fans can be clogged with dust, and it may cause a breakdown or a disaster.

DO NOT SET THE PROJECTOR IN GREASE, WET, OR SMOKY CONDITIONS SUCH AS IN A KITCHEN TO PREVENT A BREAKDOWN OR A DISASTER. IF THE PROJECTOR COMES IN CONTACT WITH OIL OR CHEMICALS, IT MAY BECOME DETERIORATED.

## Safety Instructions

All the safety and operating instructions should be read before the product is operated, and retain the owner's manual for later use.

Do not use the equipment near water.

The projector should never be covered with cloth or other materials, and the openings should not be blocked by placing the projector on unstable surface like a bed, sofa and rug.

Do not install the equipment near the thermal source, such as the heater, radiator, furnace or other equipment that will generate heat (including the amplifier).

Do not install the projector near the ventilation duct of air conditioner.

This projector should be operated only from the type of power source indicated on the marking label. If you are not sure of the type of power supplied, consult an authorized dealer or local power company. Do not allow anything to rest on the power cord.

Do not overload wall outlets and extension cords as this can result in fire or electric shock.

Do not destroy the safety protection function of polarized or grounding plugs as this can result in fire electric shock or causing projector damaged. If the provided plug does not match the outlet, contact an electrician to change the old one.

Prevent the power cord from being treaded or pressed, especially the power cord near the plug, outlet and the connection between the power cord and the equipment. Unplug the power cord during a lighting or when the equipment is not used for long periods.

Do not stare directly at the lens when the projector is running.

Do not attempt to service this projector yourself as opening or removing covers may expose you to dangerous voltage or other hazards. Refer all servicing to qualified service personnel.

When replacement parts are required, be sure the service technician has used replacement parts specified by the manufacturer that have the same characteristics as the original part. Unauthorized substitutions may result in fire, electric shock, injury to persons or projector damaged.

The +12V trigger only outputs 12V DC trigger signal. Do not connect to other power input or output. Otherwise, the equipment may be damaged.

Blocking the air vents by dust and leaving the projector uncleaned for a long time may cause a breakdown, damage the projector or accidents. Please clean or change the filters regularly. The packaging materials should be kept properly for the use of transportation.





## Installing the Projector in Proper Directions

Use the projector properly in specified positions. Improper positioning may shorten the lamp life and result in severe accident or fire hazard.

This projector can project the picture in upward, downward, or inclined position in perpendicular direction to the horizontal plane.

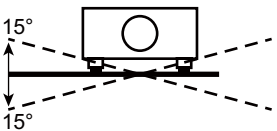
## Positioning Precautions

Avoid positioning the projector as described below.

	<p>Do not tilt the projector more than 15 degree from side to side.</p>		<p>Do not put the projector on either side to project an image.</p>
	<p>In upward projection, do not tilt the projector over 10 degree right and left.</p>		<p>In downward projection, do not tilt the projector over 10 degree right and left.</p>



### CAUTION ON CEILING MOUNTING

For Ceiling mounting, you need the ceiling mount kit designed for the projector. When the projector is not mounted properly, it may fail, causing hazards or injury. For details, please consult you dealer. The warranty dose not cover any damage caused by use of any non-recommended ceiling mount kit or installation of the ceiling mount kit in an improper location.

## **Compliance**

### **Federal Communications Commission Notice**

This equipment has been tested and found to comply with the limits for a Class A digital device, pursuant to Part 15 of FCC Rules. These limits are designed to provide reasonable protection against harmful interference when the equipment is operated in a commercial environment. This equipment generates, uses, and can radiate radio frequency energy and, if not installed and used in accordance with the instruction manual, may cause harmful interference to radio communications. Operation of this equipment in a residential area is likely to cause harmful interference in which case the user will be required to correct the interference at his own expense.

Do not make any changes or modifications to the equipment unless otherwise specified in the instructions. If such changes or modifications should be made, you could be required to stop operation of the equipment.

### **Canadian Radio Interference Regulations**



This Class A digital apparatus meets all requirements of the Canadian ICES-003

### **WARNING**

This is a Class A product. In a domestic environment this product may cause radio interference in which case the user may be required to take adequate measures.

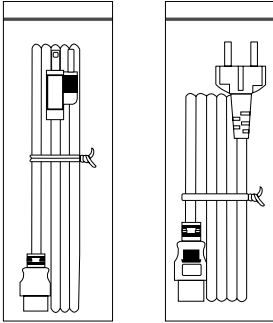
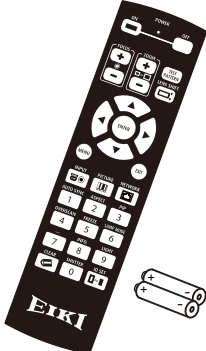
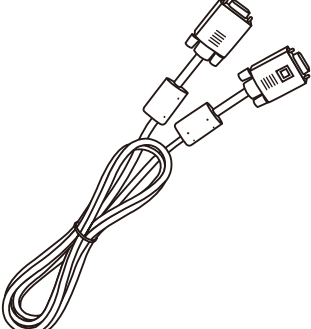
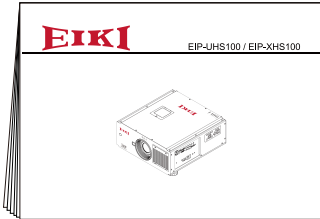
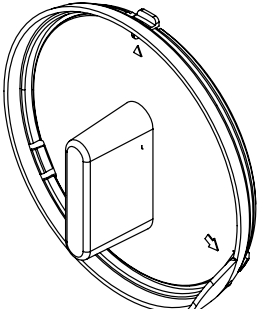

# Standard Accessories

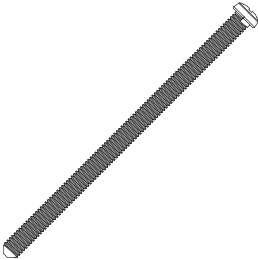
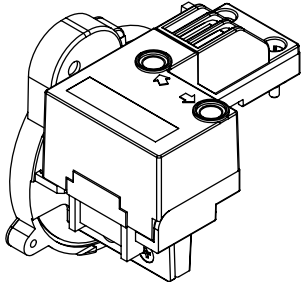
<p>Owner's Manual (CD)</p>	<p>AC Power cord US Type*1 ; Euro Type*1</p>	<p>Remote control with batteries (AA or LR6)</p>
		
<p>VGA cable</p>	<p>Quick start guide</p>	<p>Lens cap</p>
		
<p>Wired remote Cable</p>	<p>Lens lock screw (M4*1)</p>	<p>Color type Color Wheel Module</p>
		

# Optional Accessories

## Optional Lenses and Projection Size

Seven types of motor-powered projection lens can be an option for EIP-UHS100/EIP-XHS100, the projection lenses can cover the throw ratio range from 0.75:1 to 8.56:1. These lenses support to Lens Memory features to EIP-UHS100/EIP-XHS100, lens memory function offers ten memory set for storing. For accurate lens memory and recall functions, make sure to calibrate the projection lens by Center Lens function when you install the projection lens in EIP-UHS100/EIP-XHS100 each time.

### Complete projection lens series as below table

Lens Type	Zoom Ratio	F#	Focus Length f (mm)	Lens Shift Range		Throw Ratio	
				Vertical	Horizontal	EIP-XHS100	EIP-UHS100
AH-CD20203	1.25	1.96-2.3	11.3-14.1	40%	±10%	0.77-0.97:1	0.75-0.93:1
AH-CD20201	-	1.85	11.6	0%	0%	0.79:1	0.76:1
AH-CD20202	1.41	1.85-2.5	18.7-26.5	50%	±10%	1.3-1.85:1	1.25-1.79:1
AH-CD20101	1.3	1.7 - 1.9	26.0 - 34.0	50%	±10%	1.79-2.35:1	1.73-2.27:1
AH-CD20401	1.65	1.86-2.48	32.9 - 54.2	50%	±10%	2.3-3.81:1	2.22-3.67:1
AH-CD20301	1.5	1.85-2.41	52.8 - 79.1	50%	±10%	3.71-5.57:1	3.58-5.38:1
AH-CD20302	1.55	1.85-2.48	78.5 - 121.9	50%	±10%	5.5-8.56:1	5.31-8.26:1

*AH-CD20201 is a fixed focus lens and support to limited lens memory function. The vertical and horizontal shift range is 0%, the corners of the projected image may appear shadows or distortion if lens is shifted horizontally or vertically. Please consult EIKI service center for more details.*

*To ensure that the projector can recall the lens memory setting precisely, make sure to perform the Center Lens function whenever a lens is mounted.*

# Projection Size v.s Distance

## EIP-UHS100

Distance unit : m

Lens Type				Short Throw		Fixed Short Throw	Short Throw		Standard		Long Throw		Long Throw		Long Throw	
Model Name				AH-CD20203		AH-CD20201	AH-CD20202		AH-CD20101		AH-CD20401		AH-CD20301		AH-CD20302	
Inch	W x H (mm)			Wide	Tele	Fixed	Wide	Tele	Wide	Tele	Wide	Tele	Wide	Tele	Wide	Tele
40	861	x	538	0.62	0.79	0.64	1.05	1.52	1.45	1.93	1.87	3.15	3.01	4.60	4.42	7.05
80	1723	x	1077	1.29	1.63	1.32	2.16	3.09	2.97	3.92	3.82	6.39	6.16	9.33	9.13	14.40
100	2154	x	1346	1.62	2.05	1.66	2.71	3.88	3.73	4.92	4.80	8.00	7.74	11.70	11.48	18.07
120	2584	x	1615	1.96	2.46	2.01	3.26	4.66	4.49	5.91	5.77	9.62	9.31	14.06	13.84	21.75
150	3231	x	2019	2.46	3.09	2.52	4.09	5.84	5.63	7.41	7.24	12.04	11.68	17.61	17.37	27.26
200	4307	x	2692	3.29	4.14	3.37	5.47	7.81	7.53	9.90	9.68	16.08	15.61	23.52	23.26	36.44
250	5384	x	3365	4.13	5.18	4.23	6.85	9.77	9.43	12.39	12.12	20.12	19.55	29.44	29.15	45.62
300	6461	x	4038	4.96	6.23	5.08	8.23	11.73	11.34	14.88	14.56	24.16	23.49	35.35	35.04	54.81
350	7538	x	4711	5.80	7.27	5.94	9.61	13.70	13.24	17.37	17.00	28.20	27.42	41.27	40.93	63.99
400	8615	x	5384	6.63	8.32	6.79	10.99	15.66	15.14	19.86	19.44	32.24	31.36	47.18	46.82	73.18
450	9692	x	6057	7.47	9.36	7.65	12.37	17.62	17.04	22.36	21.88	36.28	35.30	53.10	52.71	82.36
500	10768	x	6730	8.30	10.41	8.50	13.75	19.59	18.94	24.85	24.32	40.32	39.24	59.01	58.60	91.54

## EIP-XHS100

Lens Type				Short Throw		Fixed Short Throw	Short Throw		Standard		Long Throw		Long Throw		Long Throw	
Model Name				AH-CD20203		AH-CD20201	AH-CD20202		AH-CD20101		AH-CD20401		AH-CD20301		AH-CD20302	
Inch	W x H (mm)			Wide	Tele	Fixed	Wide	Tele	Wide	Tele	Wide	Tele	Wide	Tele	Wide	Tele
40	813	x	610	0.61	0.77	0.62	1.03	1.49	1.42	1.88	1.83	3.08	2.94	4.49	4.31	6.89
80	1626	x	1219	1.26	1.59	1.29	2.11	3.02	2.90	3.83	3.73	6.24	6.02	6.12	8.91	14.07
100	2032	x	1524	1.58	2.00	1.62	2.65	3.79	3.65	4.80	4.69	7.82	7.56	11.43	11.22	17.66
120	2438	x	1829	1.91	2.40	1.96	3.18	4.56	4.39	5.78	5.64	9.40	9.10	13.74	13.52	21.25
150	3048	x	2286	2.40	3.02	2.46	3.99	5.71	5.50	7.24	7.07	11.77	11.41	17.21	16.97	26.64
200	4064	x	3048	3.21	4.04	3.29	5.34	7.63	7.36	9.67	9.46	15.72	15.25	22.99	22.73	35.62
250	5080	x	3810	4.03	5.06	4.13	6.69	9.55	9.22	12.11	11.84	19.67	19.10	28.78	28.48	44.59
300	6096	x	4572	4.84	6.08	4.96	8.04	11.47	11.07	14.54	14.23	23.62	22.95	34.56	34.24	53.57
350	7112	x	5334	5.66	7.10	5.80	9.39	13.39	12.93	16.98	16.61	27.57	26.80	40.34	39.99	62.55
400	8128	x	6096	6.47	8.12	6.63	10.74	15.31	14.79	19.41	19.00	31.52	30.64	46.12	45.75	71.53
450	9144	x	6858	7.29	9.14	7.47	12.09	17.23	16.64	21.85	21.38	35.47	34.49	51.90	51.50	80.50
500	10160	x	7620	8.10	10.16	8.30	13.44	19.14	18.50	24.28	23.77	39.42	38.34	57.69	57.26	89.48

**Note:**

The values in the tables are approximate and may be slightly different from the actual measurements.

# Overview

## Projector contents

### Part Names and Functions

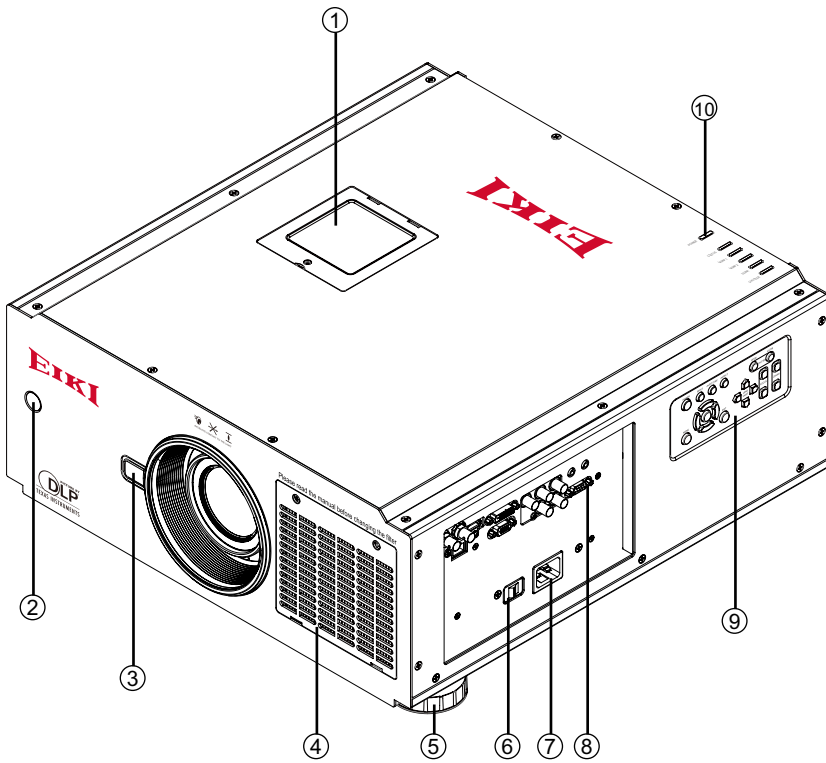

- ① Color Wheel Cover
- ② Infrared Remote Receiver(Front)
- ③ Lens Release Button
- ④ Air Intake Vent and Filter Cover
- ⑤ Adjustable Foot
- ⑥ AC Power Switch
- ⑦ Power Cord Connector
- ⑧ Terminals and Connectors
- ⑨ Control Panel
- ⑩ LED Indication
- ⑪ Exhaust Vent
- ⑫ Infrared Remote Receiver(Rear)
- ⑬ Exhaust Vent and Lamp 1 Cover
- ⑭ Exhaust Vent and Lamp 2 Cover

### Rear side

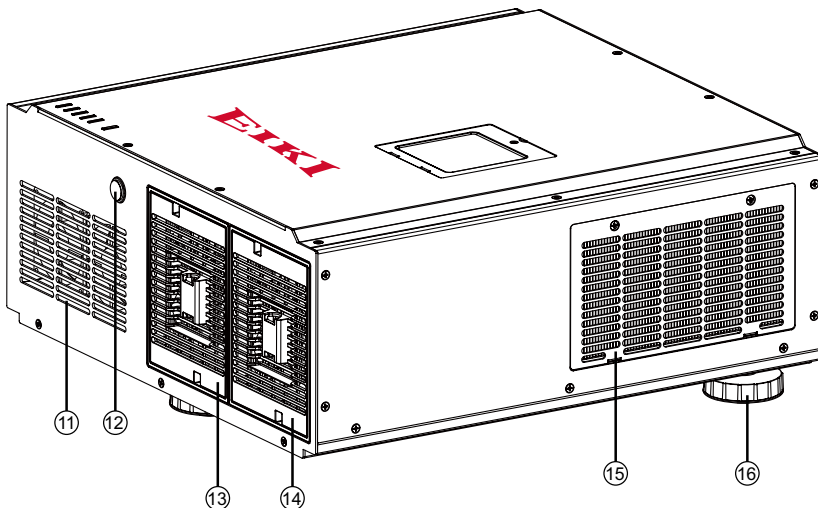

- ⑮ Air Intake Vent and Filter Cover
- ⑯ Adjustable Foot

# Terminals and Connectors

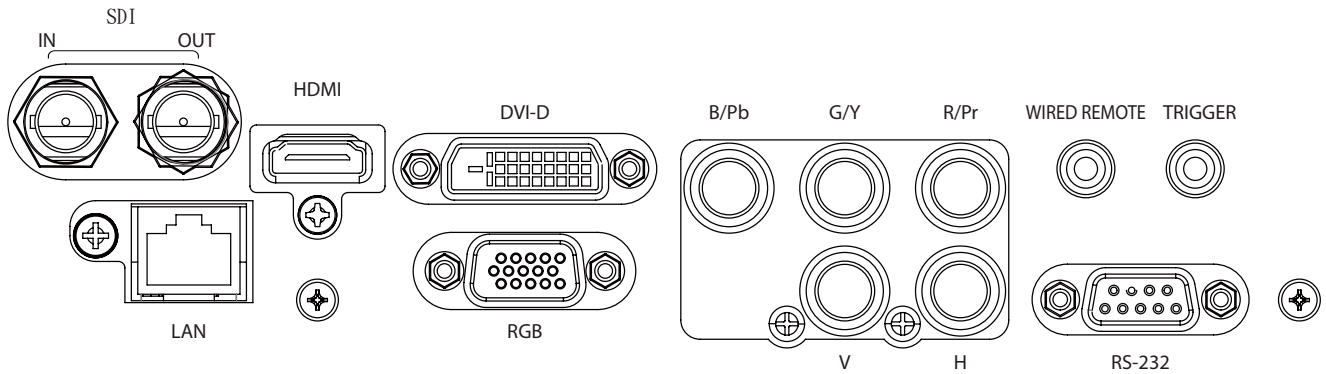

## **SDI**

Input SDI signals to IN and outputs the SDI signals from OUT.

## **HDMI**

Connect the HDMI signal from the video device to this terminal.

## **DVI-D**

Connect the DVI-D output on the computer to the terminal, the terminal can support to HDCP compatible signal.

## **5 BNC INPUT JACKS**

Connect the RGB signals or YPbPr signals.

## **WIRED REMOTE**

Connect the wired remote control to this jack with a remote control cable (supplied).

## **TRIGGER**

The TRIGGER terminal provides 12V (+/-1.5) output for screen control.

## **LAN**

Connect the Ethernet cable to the terminals for controlling the projector. (page 62)

## **RGB**

Connect a computer output (Analog D-sub 15-pin type) to this terminal.

## **RS-232**

Connect a RS-232(Not supplied) from the computer to the terminal for controlling the projector.

# Control Keys and Indicators

## Control Keys

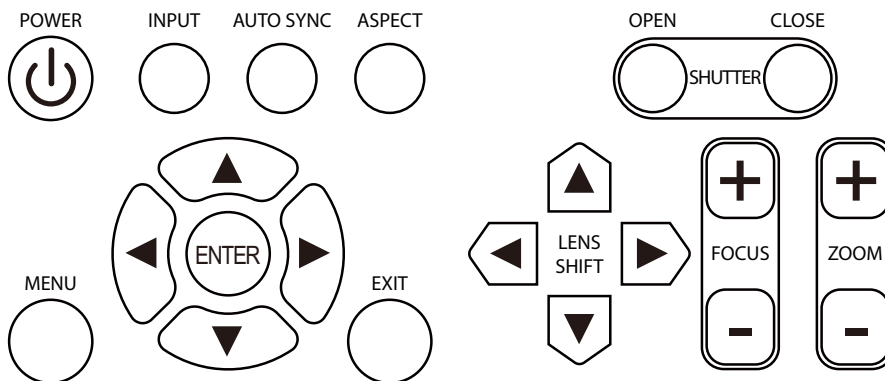

### POWER

Turn on/off the projector.

### INPUT

Select the input source, press the button once to select next source option, the sequence of the source is HDMI, DVI, VGA, Component/BNC, Composite, 3G-SDI.

### AUTO SYNC

Use the button to perform auto sync.

### ASPECT

Change aspect ratio, press the button once to the next aspect ratio setting.

### SHUTTER OPEN/CLOSE

Press OPEN button to open the shutter, CLOSE to close the shutter.

### MENU

Press the button to open or close the OSD menu.

### ARROW BUTTONS

Use the four button to move the cursor on OSD, select the item or adjust the setting.

### ENTER

Use the button to confirm the changes you made and to show ZOOM/FOCUS OSD. When you press the button again, LENS SHIFT OSD appears.

### EXIT

Use the button to close the OSD menu.

### LENS SHIFT

Press the four arrow buttons to open Lens control window.

### FOCUS +/-

Use FOCUS+ or FOCUS- to focus the projected image.

### ZOOM +/-

Use the two buttons to zoom in or zoom out the projected image.

## LED Indicator



This indicator flashes green when the projector is warming up and keep green when turning on.



Indicates the status of the projector.



The indicator lights green when the lamp 1 is on, the indicator is off when the lamp is off.



The indicator lights green when the lamp 2 is on, the indicator is off when the lamp is off.



Indicate the system temperature status. The indicator is flashing red if abnormal temperature is detected.



This indicator lights green when the shutter is closed, it lights off when the shutter is open.

# Remote Control

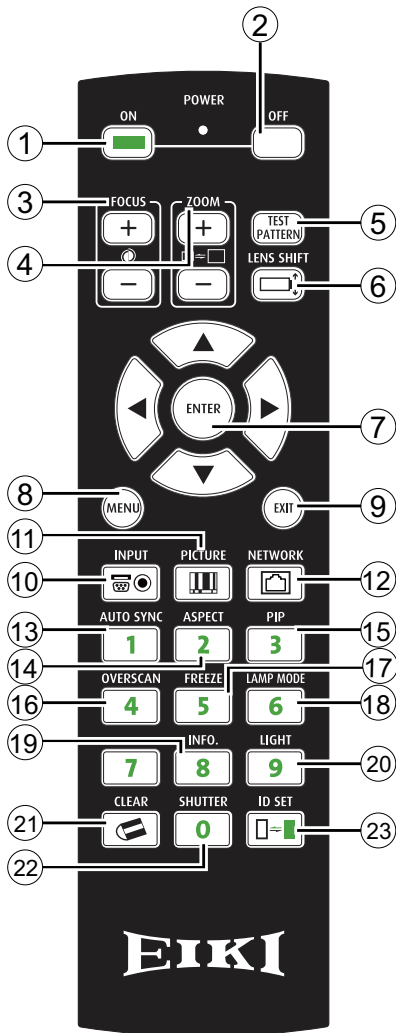

- 1. ON**  
Turn the projector on.
- 2. OFF**  
Turn the projector off.
- 3. FOCUS**  
Focuses the projected images.
- 4. ZOOM**  
Zoom in/out the projected image.
- 5. TEST PATTERN**  
Display test pattern.
- 6. LENS SHIFT**  
Shift the lens, up/down or left/right.
- 7. ENTER**  
Confirm the change. Open ZOOM/FOCUS OSD. Press again to open LENS SHIFT.
- 8. MENU**  
Open and close the OSD menu.
- 9. EXIT**  
Close the OSD menu.
- 10. INPUT**  
Select a input source.
- 11. PICTURE**  
Starts the PICTURE function.
- 12. NETWORK**  
Enter the Network (LAN) menu.
- 13. AUTO SYNC**  
Automatically adjust the computer image to its optimum setting.
- 14. ASPECT**  
Select the aspect ratio settings.
- 15. PIP**  
Display the picture-in-picture screen.
- 16. OVERSCAN**  
Select an overscan mode.
- 17. FREEZE**  
Freeze/unfreezes the on-screen picture.
- 18. LAMP MODE**  
Select a higher or lower brightness setting.
- 19. INFO.**  
Display projector information.
- 20. LIGHT**  
Turn on the remote control backlight.
- 21. CLEAR**  
Not available
- 22. SHUTTER**  
Open/close the shutter.
- 23. ID SET**  
Not available



### Notes on Remote Control Operation

In most situations, you can simply point the remote control at the screen which will reflect the IR signal from the remote back toward the IR receiver on the projector. In some cases, however, ambient light may prevent this. If so, try again.

If the effective range of the remote control decreases, or it stops working, replace the batteries with new ones.

The remote control may fail to operate if the infrared remote sensor is exposed to bright sunlight or fluorescent lighting.

## Remote Control Battery Installation

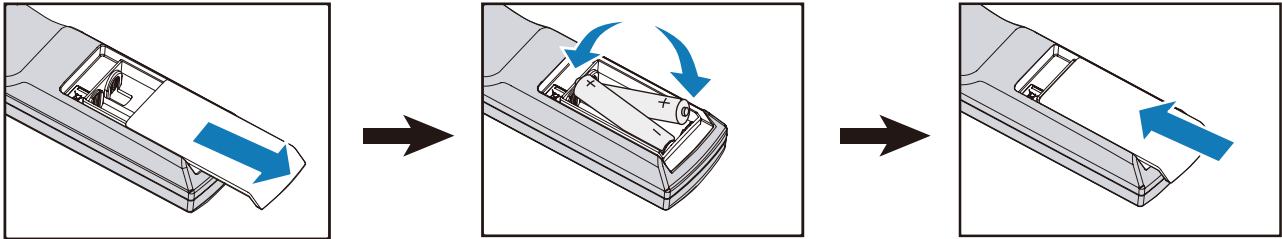

1. Slide the battery cover to remove it.
2. Install two AA(2) batteries with the correct polarity.
3. Put back the cover.

### Notes on Batteries

Make sure that the battery polarities are correct when installing the batteries.

Do not mix an old battery with a new one or different types of batteries.

Avoid contact with water or liquid.

Do not expose the remote control to moisture or heat.

Do not drop the remote control.

If you will not use the remote control for periods long time, remove the batteries to avoid damage from battery leakage. Please wipe the remote control clean and install new batteries if the battery is leaked.

Dispose of used batteries according to the instructions or your local disposal rule or guideline.

## Remote Control Receivers and Operation Range

Infrared Remote Receivers are provided on the front and rear cover. Point the remote control toward the projector, then press the buttons. Maximum operating range for the remote control is about 10 meters and  $\pm 30$  degrees.

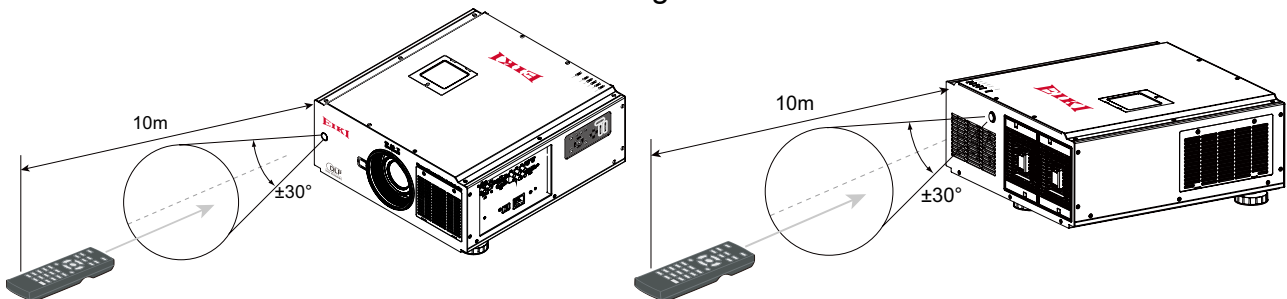

Note:

When hanging the projector from the ceiling, point toward the Infrared Remote Receiver which is located farther away from the fluorescent light.

## Wired Remote Control

The remote control can be used as a wired remote control. Wired remote control helps you use the remote control outside the operating range. Connect the remote control and the projector with the remote control cable (supplied). If the remote control is connected to the cable, the remote control does not emit signal.

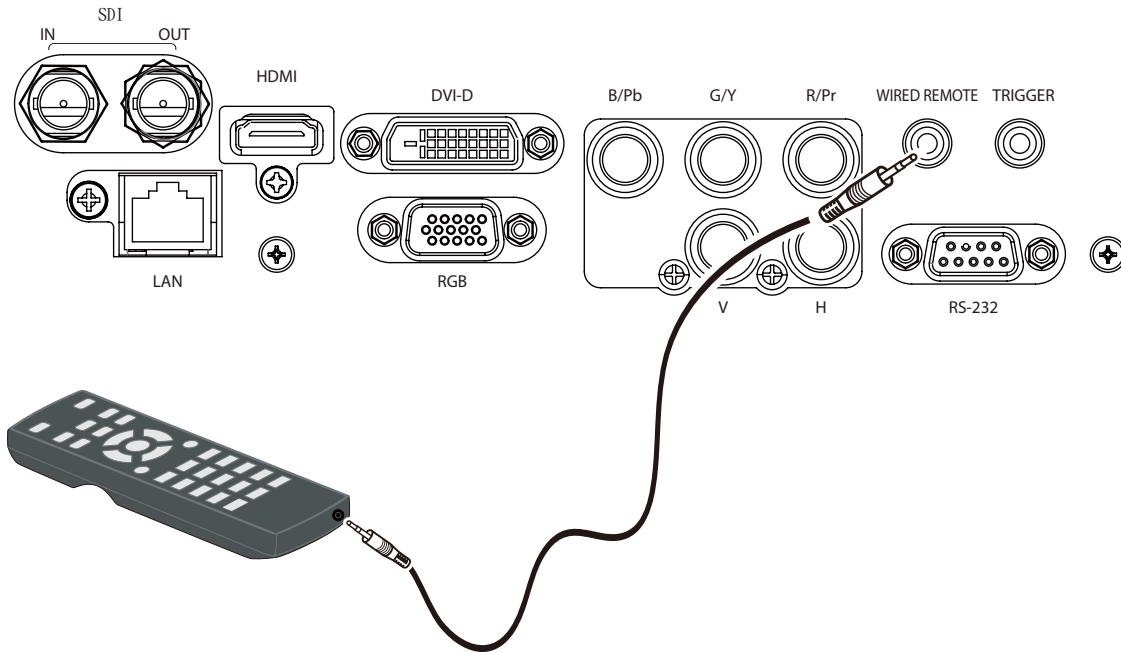

# Installation

## Lens Installation

Before setting up the projector, install Projection Lens on the projector.

Before installation, check where the projector is used and prepare a suitable lens. For the details, contact the sales dealer where you purchased the projector.

To install and change the projector Lens:

1. Remove the Lens cap.

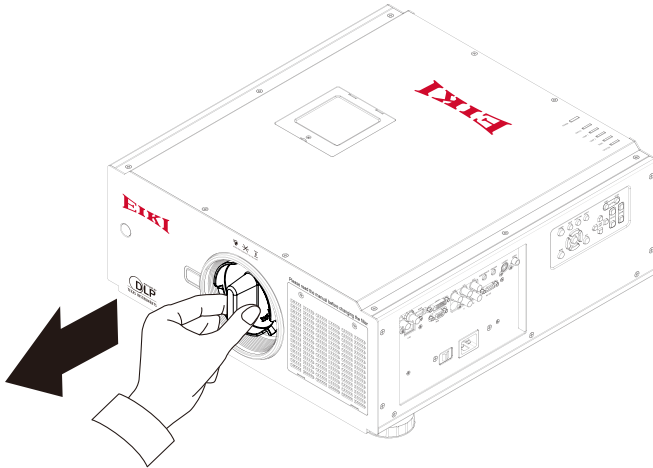

2. Insert the lens and ensure the lens touches the lens holder. Align the "▲" symbol on the lens label with the "✕" symbol on the top of the body (align to the center of the lens hole). Make sure the lens is pushed into the holder and turn it clockwise to the "Lock" position. When turning the lens, the "Click" sounds once to indicate that the lens is completely fixed.

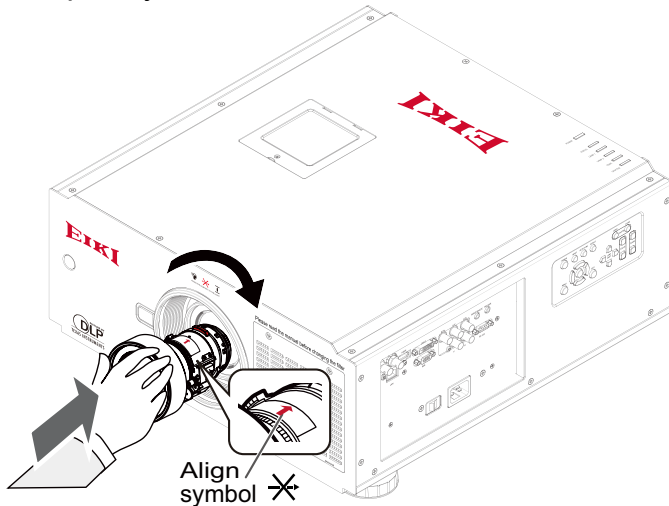

# Lens replacement

## To replace the projector Lens

1. Press and hold the lens lock button. Support the lens and turn counterclockwise to loosen the lens. Pull the lens backward and slide the lens out of the lens holder.

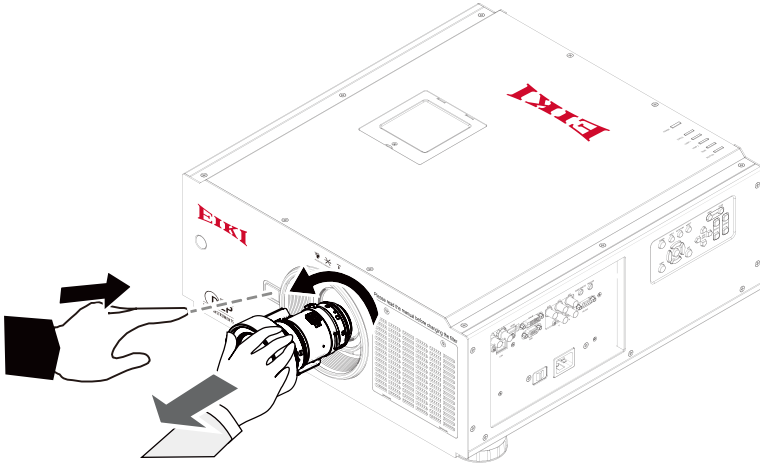

2. Insert the lens and ensure the lens touches the lens holder. Align the "▲" symbol on the lens label with the "⊠" symbol on the top of the body (align to the center of the lens hole).

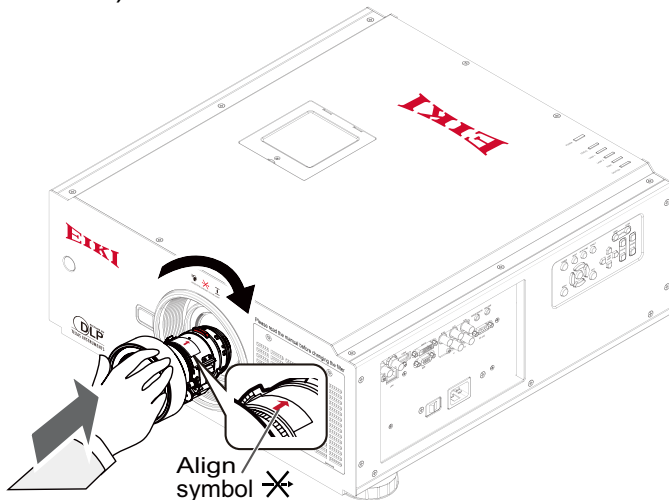

3. Make sure the lens is pushed into the holder and turn it clockwise to the "Lock" position. When turning the lens, the "Click" sounds once to indicate that the lens is completely fixed.
4. Check if the lens is really secured by trying to pull the lens out of the lens holder.

**Note:**

When removing the lens, make sure you press and hold the release button to loosen and unlock the lens. The projector supports the lens memory function. Perform the Center Lens function every time to calibrate the projection lens after you installed the lens.

# Positioning Projector

## Picture Level and Pitch Adjustment

The projection angle is adjustable up to 5 degrees upward and downward respectively by rotating front and rear. To raise the projector, rotate the front feet clockwise, rotate the rear foot clockwise to lower the projector.

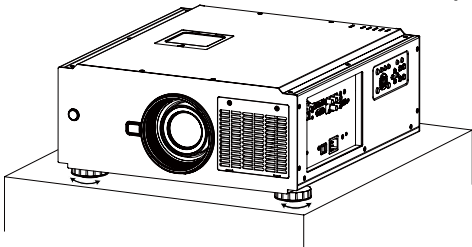

## Adjusting the Picture Orientation

This projector is designed to be installed in one of four possible installation locations. Take into consideration the size and position of the screen, the location of a suitable power outlet, rest of equipment. Open the Menu -> ALIGNMENT -> Projection Mode to the preferred projection setting.

### Front :

Select this location with the projector placed in front of the screen. This is the most common way to position the projector.

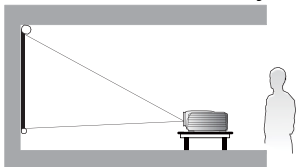

### Rear :

Select this location with the projector placed behind the screen. Note that a special rear projection screen is required.

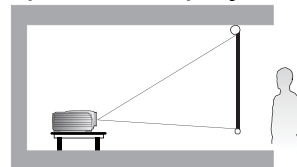

### Ceiling + Front :

Select this location with the projector mounted on the ceiling in front of the screen. Ceiling mount kit is required. Please consult your dealer for more details.

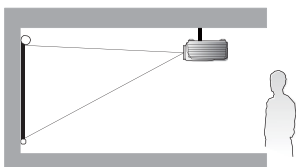

### Ceiling + Rear :

Select this location with the projector mounted on the ceiling behind the screen. Note that Ceiling mount kit and special rear projection screen are required.

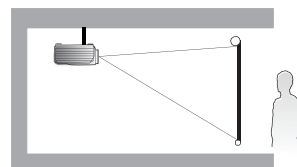

### Note:

*Ceiling installation must be done by a qualified professional, It is not recommended you install the projector yourself. For more information, please contact your dealer.*

*Only use the projector on a solid, level surface. Serious injury and damage can occur if the projector is dropped.*

*Do not cover the vents on the projector. Proper ventilation is required to dissipate heat. Damage to the projector will occur if the vents are covered.*

# Lens Shift Adjustment

Projection lens can be moved up, down, right and left with the motor-driven lens shift function. This function makes the positioning of images easy on the screen. Lens shift is generally expressed as a percentage of the image height or width, see below illustration.

## Vertical / Horizontal Lens Shift

For ceiling mounted projectors, the lens can be moved 50% (0.5V) downward, while the lens can be moved 50% (0.5V) up or down on a desktop mounted projector.

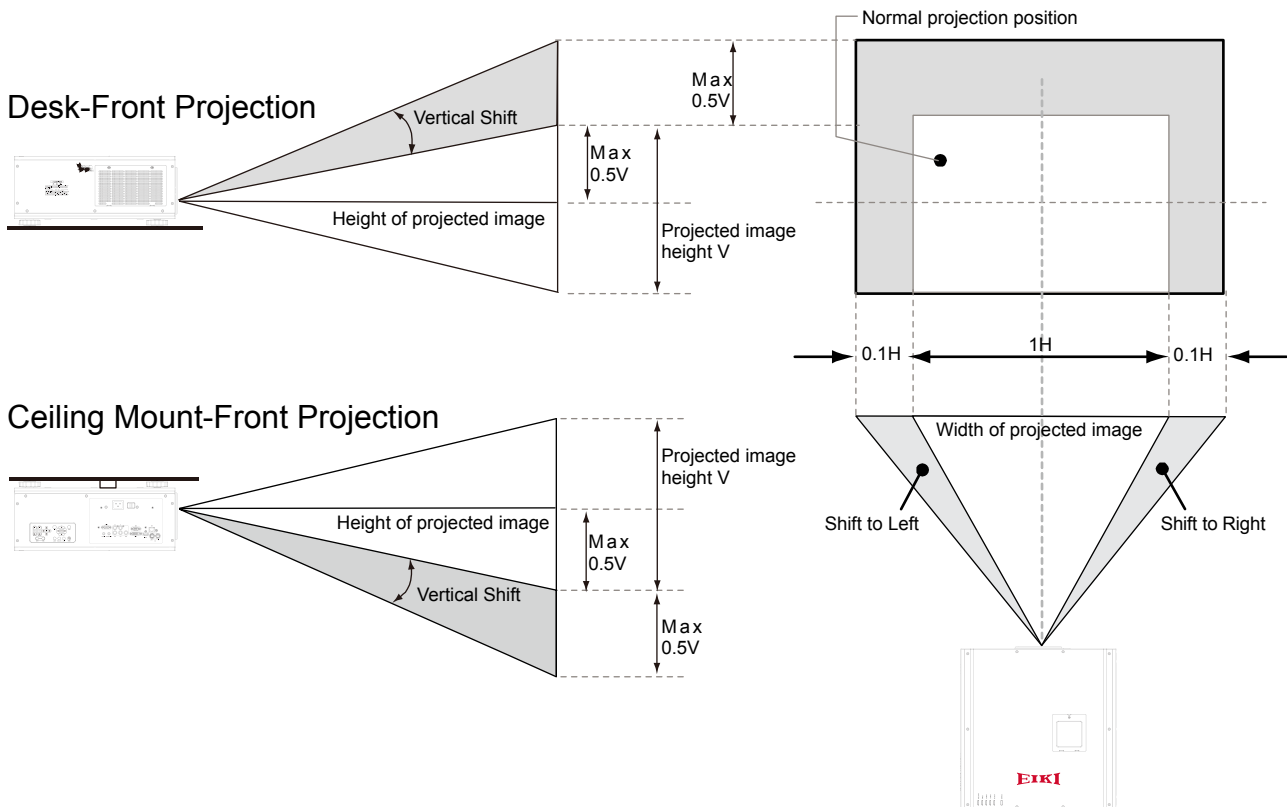

### Note:

*This is a general example of lens shift. Lenses vary in their shift capabilities. No particular lens or projector is used in this example.*

*When the lens is shifted beyond the described range of operation, the screen edges may become darker or the images may become out of focus.*

# Connecting to Computer

## Cables used for connection

- HDMI Cable

(One cable is supplied, Other cables are not supplied with this projector)

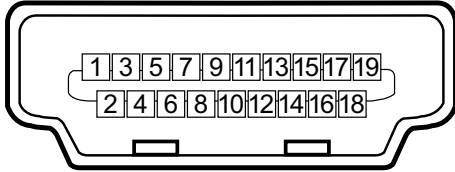

- DVI Cable
- BNC Cable(BNCx5)
- VGA Cable (D-Sub 15 pin)

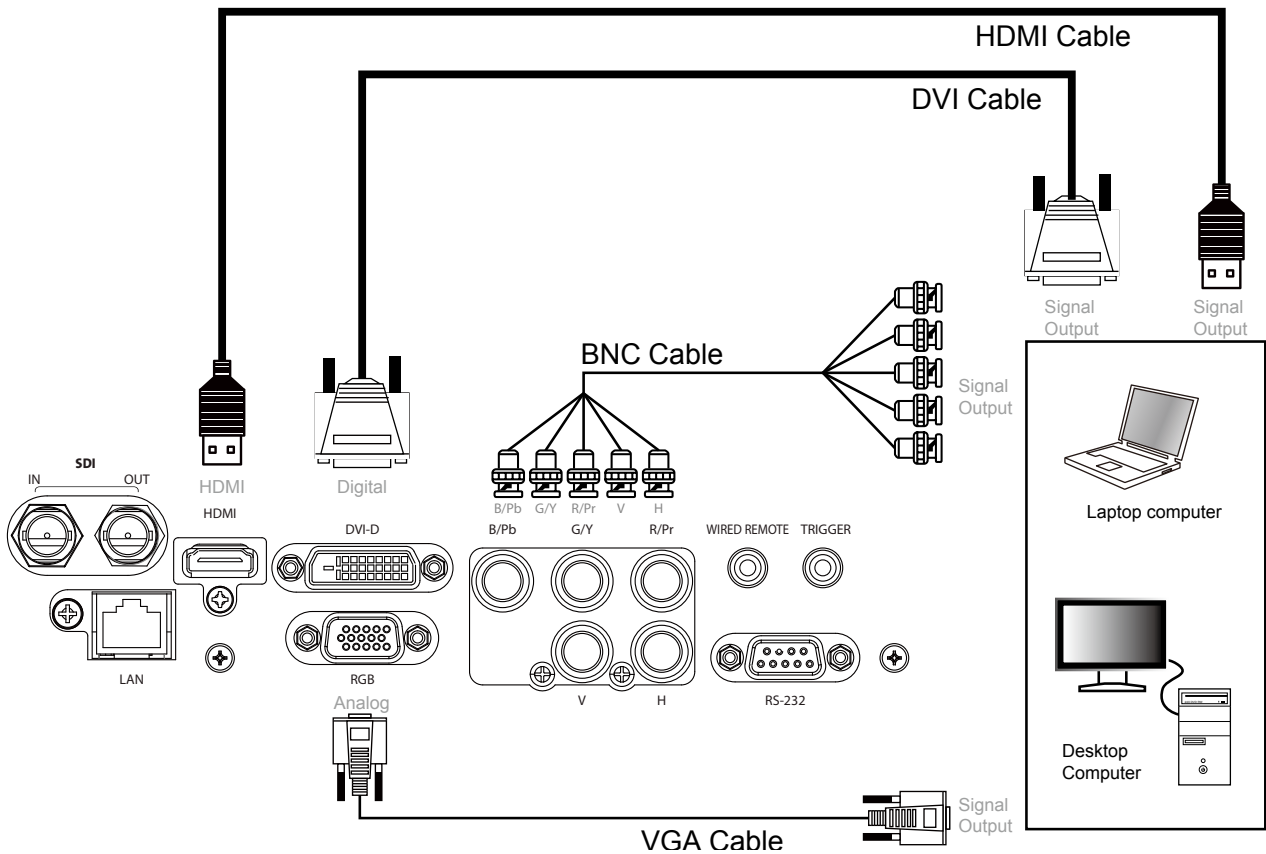

# Connecting to Video Equipment

## Cable used for connection

- Video Cable (BNCx3, BNCx1)
- DVI Cable
- SDI Cable
- HDMI Cable

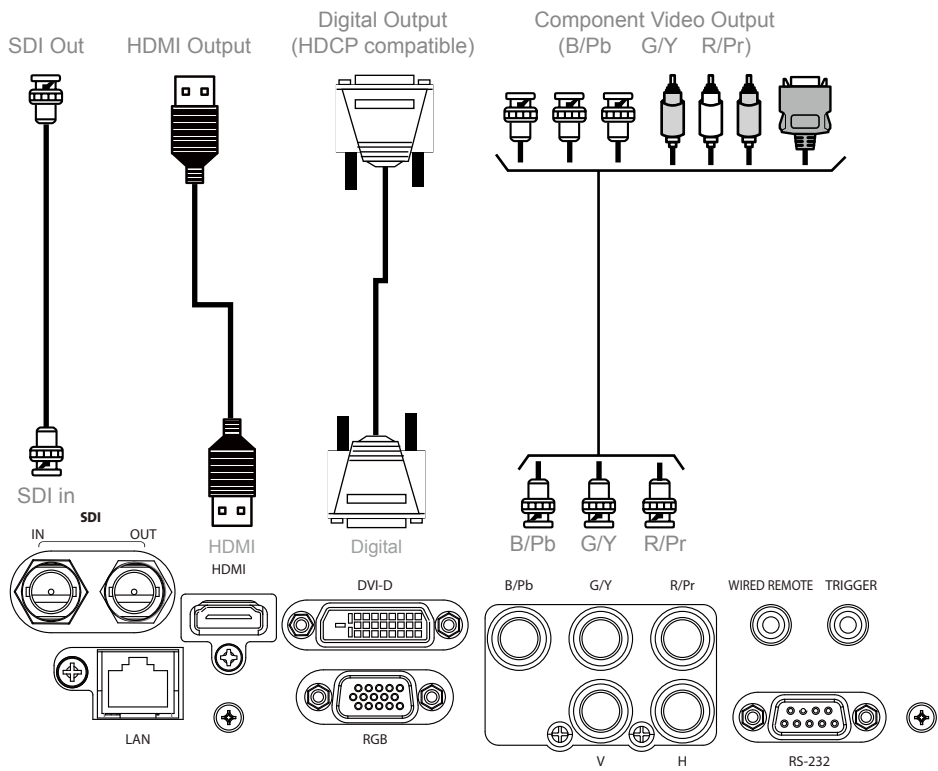



# Trigger connection

If your projection system includes a projector screen, screen cover or other 12V Trigger equipment, please connect such device/equipment to the projector's 12V Trigger output as illustrated. After you have done so, your screen will lower automatically whenever you turn on your projector for your convenience.

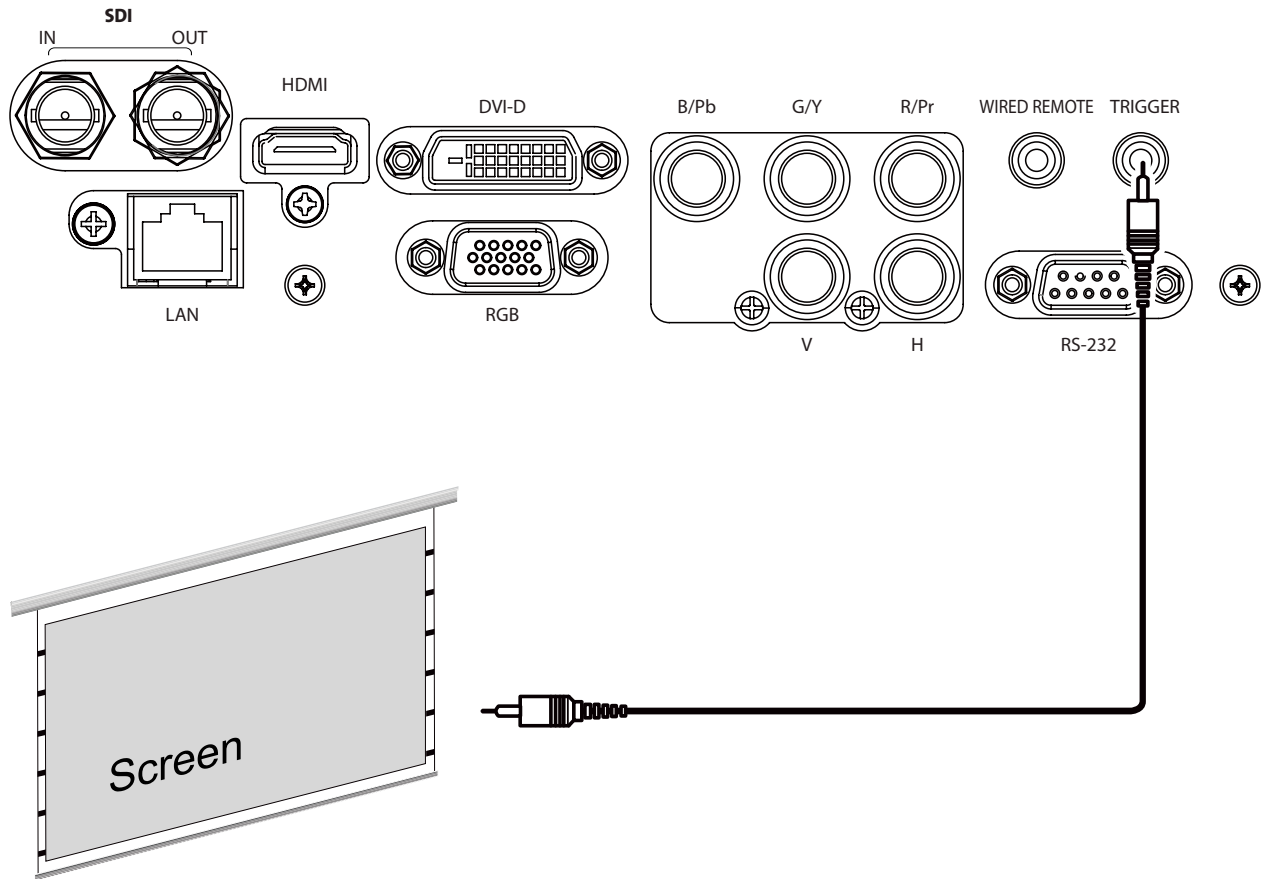

## RS-232 Connection

Connect a PC or home theater control/automation system (if present) to the RS-232 port on the projector. Use a standard, 9-pin serial cable, wired straight-through.

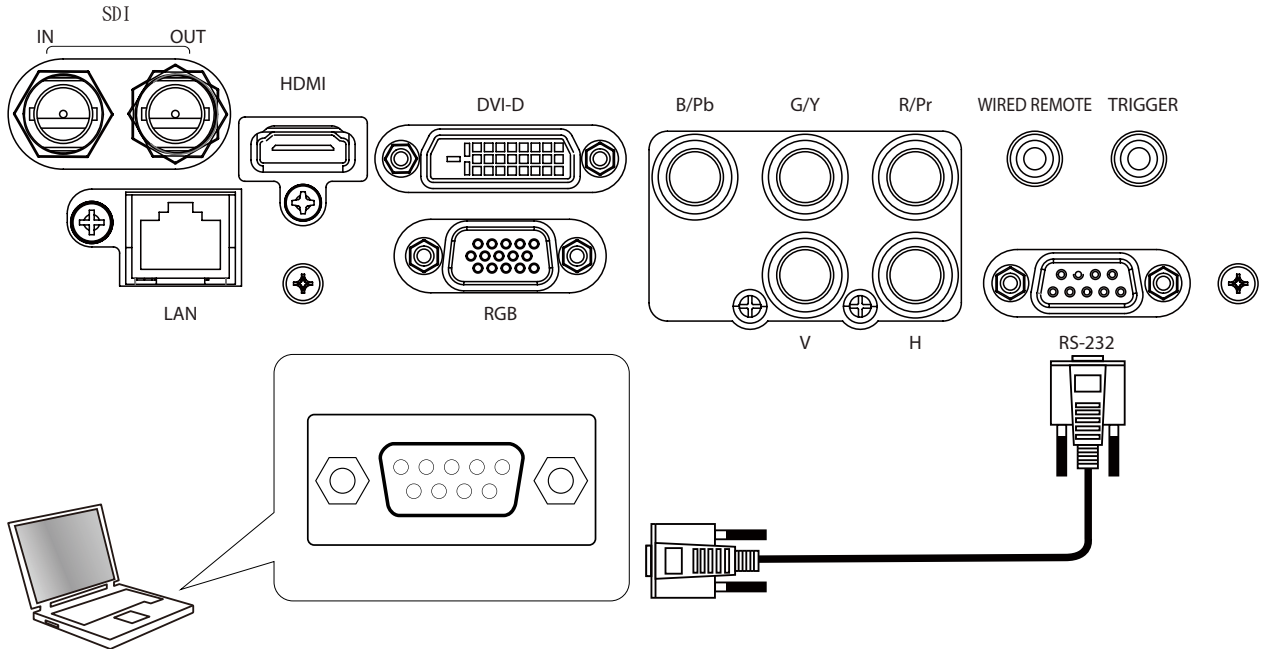

## LAN Connection

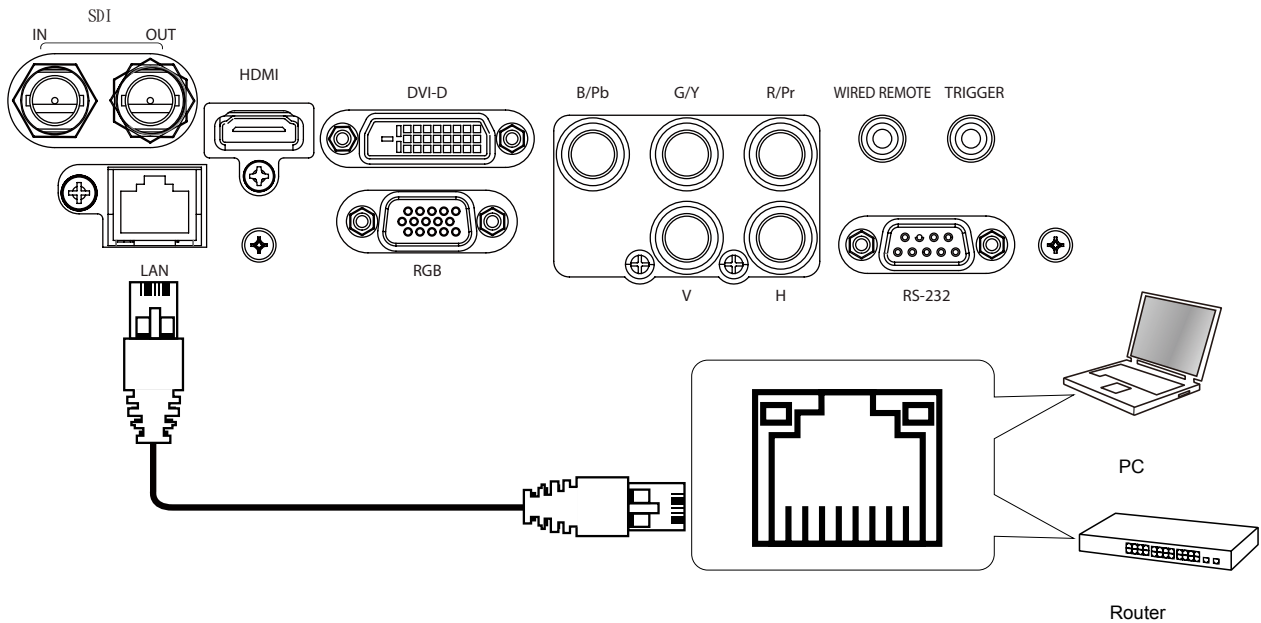

# Connecting to wired remote controller

If infrared remote signals cannot reach the projector due to obstructions, you can use the remote control as a wired remote control.

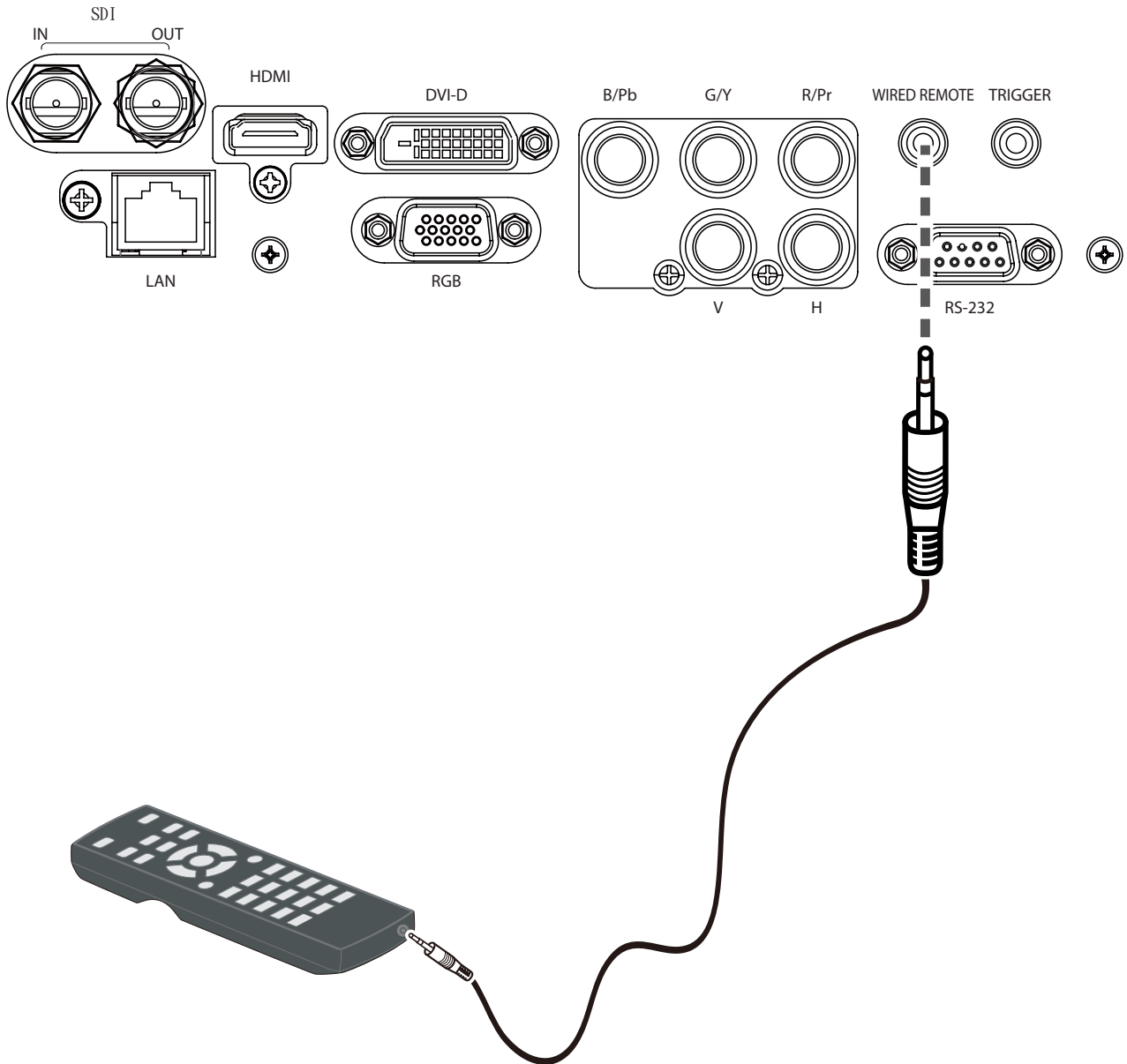

## Connecting the AC Power Cord

This projector uses nominal input voltages of 100-240 VAC. It is designed to work with single-phase power systems having a grounded neutral conductor.

To reduce the risk of electrical shock, do not plug into any other type of power system. If you are not sure of the type of power being supplied, consult your authorized dealer or service center. Connect the projector with all peripheral equipment before turning on the projector.

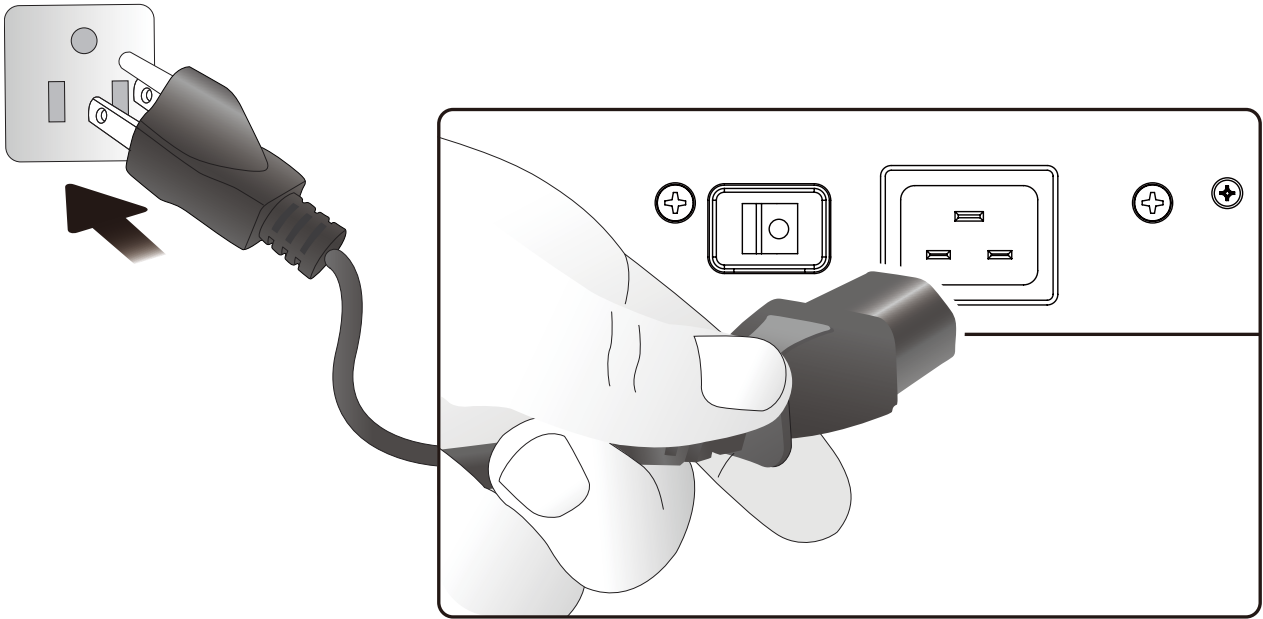

### Note

*Unplug the AC power cord or turn off the MAIN ON/OFF Switch when the projector is not in use. When the projector is in stand-by mode, it consumes a little electric power.*

# Basic Operation

## Turning On the Projector

① Complete peripheral connections (with a computer, VCR, etc.) before turning on the projector. ② Connect the projector's AC power cord into an AC outlet and turn on the MAIN ON/OFF Switch. ③ Press the "POWER" button on the side controller or On button on the remote control. The LAMP indicator flashes green and the cooling fans start to operate, it will take a few seconds to display the projected image on the screen.

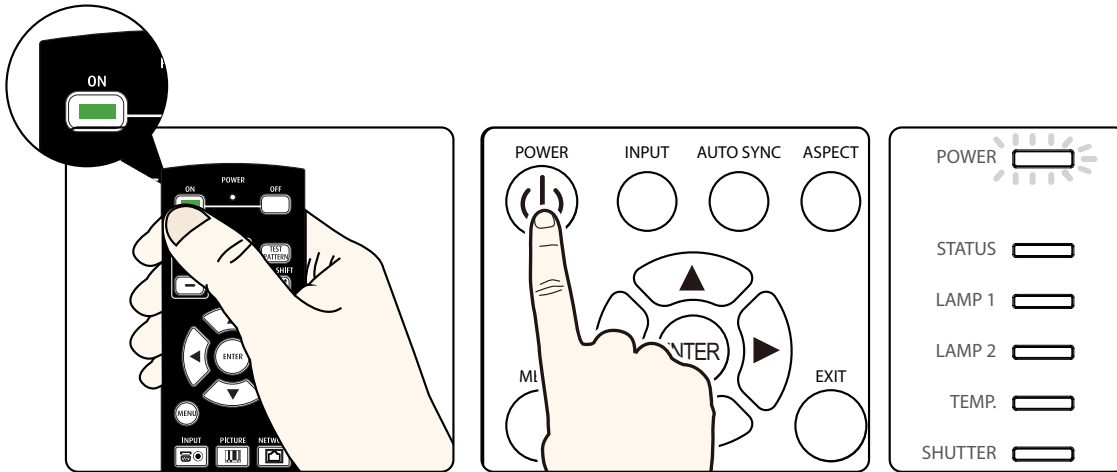

## Turn Off the Projector

1. Press the POWER button on the side control or OFF button the remote control, and "Enter Standby mode?" message appears on the screen.

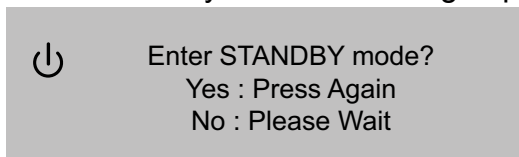

2. Press the POWER button or OFF button again to confirm, or wait a few seconds to cancel.
3. If the LAMP indicator lights bright and the POWER indicator turns off. After the projector is turned off, the cooling fans operate. You cannot turn on the projector during this cooling down period.
4. When the projector has cooled down enough, the POWER indicator lights green and then you can turn off the MAIN ON/OFF Switch, wait until the projector is completely cooled. Unplug the AC power cord from the AC outlet.

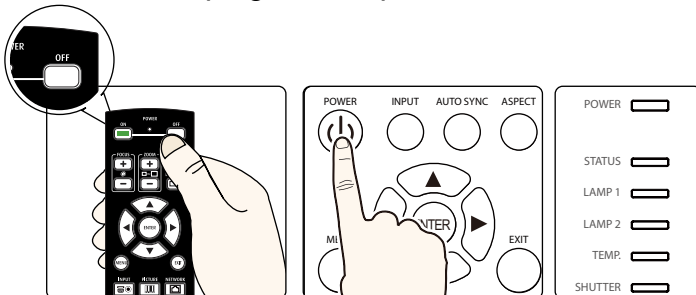

## Selecting an Input Source

When you turn on the projector, it switches to the last selected input and waits for a valid signal. Press INPUT on the remote control or control panel to switch an input source directly.

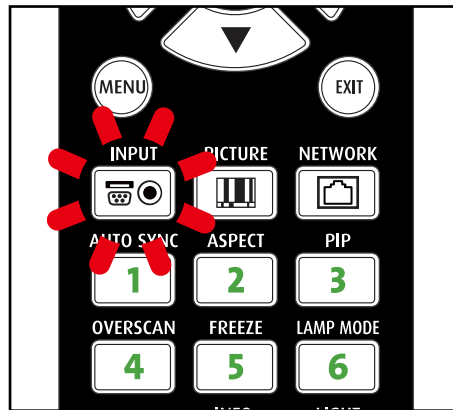
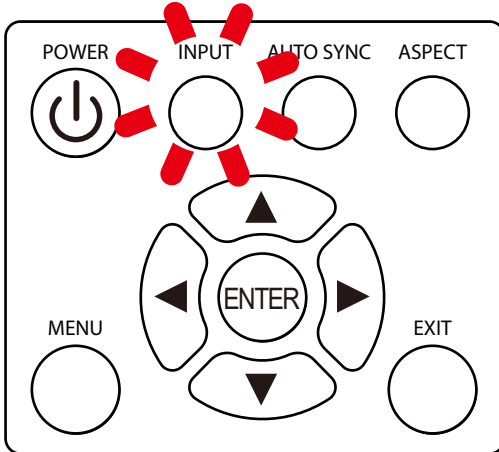

## Selecting a Aspect Ratio

Press ASPECT to adjust the aspect ratio of projected image.

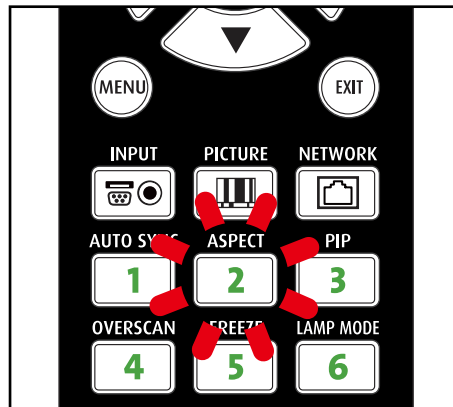
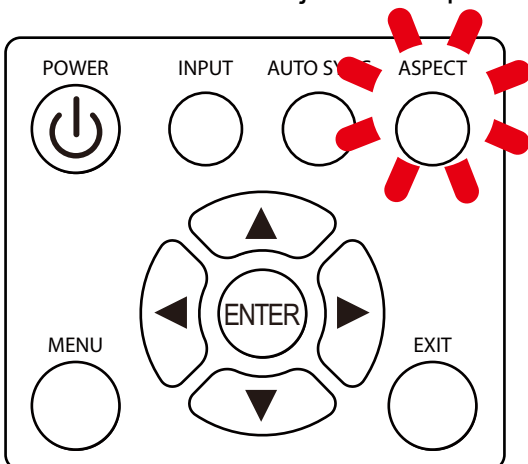

## How to Operate the On-Screen Menu

The projector has an On-Screen Display (OSD) that allows you to adjust image and change settings.

INPUT	PICTURE	LAMPS	ALIGNMENT	CONTROL	SERVICE
Picture Mode	<	Hight Bright	VGA Setup		
Contrast	<	100	H Total	< 100 >	
Brightness	<	100	H Start	< 100 :	
Adaptive Contrast	<	Off	H Phase	< 100 >	
Gamma	<	Video	V Start	< 100 :	
Color		Enter			
Sharpness	<	0			
Noise Reduction	<	0			
Aspect Ratio	<	16:10	>		
Overscan	<	Off	>		
VGA Setup		Enter			
Auto Sync		Enter			

## OSD Operation

Following steps are a basic way for operating the OSD.

1. Press the MENU button to open the OSD.
2. Press ◀ or ▶ to select a title menu.
3. Press ▲ or ▼ to select an item.  
The selected item will be highlighted.
4. Press the Enter, and ▲ or ▼ to change or adjust the selected item.
5. Press the MENU again or press the EXIT to close the OSD .

## Changing the OSD Language

The product can display the menus in English, French, Spanish, German, Portuguese, Simplify Chinese, Traditional Chinese, Japanese, Korean, Italian, Arabic or Russian.

Press MENU to open the OSD. Go to CONTROL and select Language then press the Enter. You can select a language there.

INPUT	PICTURE	LAMPS	ALIGNMENT	CONTROL	SERVICE
	Language		Eco Network Power	< Standard >	
	English	繁體中文	Auto Power Off	< Off >	
	Français	日本語	Auto Power On	< Off >	
	Español	한국어	Project Control	< Network >	
	Deutsch	italiano	Network	Enter	
	Português	الإنجليزية	Start Up Logo	< On >	
	简体中文	русский	Trigger	< Auto >	
			Auto Search	< Off >	
			Dynamic Black	< Off >	
			 Language	Enter	



# OSD Tree

Main Menu	Submenu		
INPUT	Input Selection	HDMI	
		DVI	
		VGA	
		Component / BNC	
		3G-SDI	
	PIP	PIP Option	Off/On
		PIP Input	HDMI
			DVI
			VGA
			Component / BNC
			3G-SDI
		PIP Swap	Execute
		Position	Top Left
			Top Right
			Bottom Left
	Bottom Right		
	Split L-R		
	Test Pattern	Color Bar	
		Crosshatch	
		Burst	
		Red	
		Green	
		Blue	
		White	
		Black	
		Uncorrected Red	
		Uncorrected Green	
		Uncorrected Blue	
		H Ramp	
		Off	
		Color Space	Auto
	YCbCr		
	YPbPr		
	RGB-PC		
	RGB-Video		
	Input Lock	Auto	
		48Hz	
		50Hz	
		60H	
	Background	Logo	
		Blue	
		Black	
White			
Auto Sync Adjust	Off		
	Auto		
	Always		

<b>PICTURE</b>	<b>Picture Mode</b>	<b>High Bright</b>		
		<b>Presentation</b>		
		<b>Video</b>		
	<b>Contrast</b>	<b>0-200</b>		
	<b>Brightness</b>	<b>0-200</b>		
<b>PICTURE</b>	<b>Adaptive Contrast</b>	<b>On</b>		
		<b>Off</b>		
	<b>Gamma</b>	<b>Film</b>		
		<b>Graphics</b>		
		<b>Video</b>		
		<b>Linear</b>		
	<b>Color</b>	<b>Color Temperature</b>	<b>5000K</b>	
			<b>6500K</b>	
			<b>7800K</b>	
			<b>9300K</b>	
			<b>Native</b>	
		<b>Trim</b>	<b>Red Lift</b>	
			<b>Green Lift</b>	
			<b>Blue Lift</b>	
			<b>Red Gain</b>	
			<b>Green Gain</b>	
			<b>Blue Gain</b>	
		<b>Sharpness</b>	<b>0-200</b>	
		<b>Noise Reduction</b>	<b>0-200</b>	
	<b>Aspect Ratio</b>	<b>5:4</b>		
		<b>4:3</b>		
<b>16:10</b>				
<b>16:9</b>				
<b>1.88</b>				
<b>2.35</b>				
<b>Letterbox</b>				
<b>Native</b>				
<b>Unscaled</b>				
<b>Overscan</b>	<b>Off</b>			
	<b>Crop</b>			
	<b>Zoom</b>			
<b>VGA Setup</b>	<b>H Total</b>	<b>0-200</b>		
	<b>H Start</b>	<b>0-200</b>		
	<b>H Phase</b>	<b>0-200</b>		
	<b>V Start</b>	<b>0-200</b>		
<b>Auto Sync</b>	<b>Execute</b>			
<b>LAMP</b>	<b>Mode</b>	<b>Single</b>		
		<b>Dual</b>		
	<b>Power</b>	<b>Eco</b>		
		<b>Normal</b>		
		<b>Custom Power Level</b>		
	<b>High Altitude</b>	<b>On</b>		
		<b>Off</b>		
	<b>Custom Power Level</b>	<b>80.4%-100% (26 steps)</b>		
	<b>Lamp 1 Status</b>	<b>On</b>		
		<b>Off</b>		
	<b>Lamp 1 Status</b>	<b>On</b>		
<b>Off</b>				

<b>ALIGNMENT</b>	<b>Projection Mode</b>	<b>Front</b>	
		<b>Rear</b>	
		<b>Ceiling + Front</b>	
		<b>Ceiling + Rear</b>	
	<b>Fan Mode</b>	<b>Normal</b>	
<b>Lens Control</b>	<b>Up</b>		
	<b>Down</b>		
<b>ALIGNMENT</b>	<b>Lens Memory</b>	<b>Load Memory</b>	<b>Memory set 1-10</b>
		<b>Save Memory</b>	<b>Memory set 1-10</b>
		<b>Clear Memory</b>	<b>Memory set 1-10</b>
	<b>Center Lens</b>	<b>Execute</b>	
	<b>Warp</b>	<b>Keystone</b>	
		<b>Rotation</b>	
		<b>Pincushion</b>	
		<b>Barrel</b>	
		<b>Top Left Corner</b>	
		<b>Top Right Corner</b>	
		<b>Bottom Left Corner</b>	
		<b>Bottom Right Corner</b>	
		<b>Reset</b>	
	<b>Blanking</b>	<b>Top</b>	
		<b>Bottom</b>	
		<b>Left</b>	
		<b>Right</b>	
		<b>Reset</b>	
	<b>Edge Blend</b>	<b>Edge Blend</b>	<b>On</b>
			<b>Off</b>
		<b>Blend Width</b>	<b>Top</b>
			<b>Bottom</b>
			<b>Left</b>
			<b>Right</b>
		<b>Black Level Uplift</b>	<b>All</b>
			<b>Red</b>
	<b>Green</b>		
<b>Blue</b>			
<b>Reset</b>			
<b>Align Pattern</b>	<b>On</b>		
	<b>Off</b>		
<b>Control</b>	<b>Eco Network Power</b>	<b>Standard</b>	
		<b>Eco</b>	
	<b>Auto Power Off</b>	<b>On</b>	
		<b>Off</b>	
	<b>Auto Power On</b>	<b>On</b>	
		<b>Off</b>	
	<b>Projector Control</b>	<b>RS232</b>	
		<b>Network</b>	
	<b>Network</b>	<b>IP Address</b>	
		<b>Subnet mask</b>	
		<b>Gateway</b>	
		<b>DHCP</b>	
	<b>Start Up Logo</b>	<b>On</b>	
		<b>Off</b>	
	<b>Trigger</b>	<b>5:4</b>	
<b>4:3</b>			
<b>16:10</b>			
<b>16:9</b>			

<b>Control</b>	<b>Trigger</b>	1.88	
		2.35	
		Letterbox	
		Native	
		Unscaled	
		Auto	
<b>Control</b>	<b>Auto Search</b>	On	
		Off	
	<b>Dynamic Black</b>	On	
		Off	
	<b>Language</b>	English	
		Français	
		Español	
		Deutsch	
		Português	
		简体中文	
		繁體中文	
		日本語	
한국어			
русский			
ةي زي لجن اإا			
<b>SERVICE</b>	<b>Model</b>		
	<b>Serial Number</b>		
	<b>Software Version</b>		
	<b>Active/PIP Source</b>		
	<b>Pixel Clock</b>		
	<b>Signal Format</b>		
	<b>H/V Refresh Rate</b>		
	<b>Lamp 1 Time</b>	x HRS	
	<b>Lamp 2 Time</b>	x HRS	
	<b>Power On Time</b>	x HRS	
	<b>Blue Only</b>	On	
		Off	
	<b>Factory Reset</b>		

## OSD Operation-INPUT

INPUT	PICTURE	LAMPS	ALIGNMENT	CONTROL	SERVICE
Input Selection		Enter			
Test Pattern		Enter			
Color Space	<	Auto	>		
Input Lock	<	Auto	>		
Background	<	Logo	>		
Auto Sync Adjust	<	Always	>		

### Input Selection

You can select the input source.

#### HDMI

HDMI input.

#### DVI

DVI input.

#### VGA

Analog RGB.

#### Component / BNC

Analog / serial digital interface.

#### 3G-SDI

Uncompressed digital video from a serial connection (coaxial)

Timing	SDI Link mode	Signal Standards	Color Encode	Sampling Structure	Bit depth	Cable Length Tested
NTSC	SD	SMPTE 259M-C 270Mbps SD	YCbCr	4:02:02	10	128m
PAL	SD	SMPTE 259M-C 270Mbps SD	YCbCr	4:02:02	10	128m
1035i 60Hz	HD-Single	SMPTE 292M292M 1.5Gbps HD	YCbCr	4:02:02	10	128m
1080i 59.94Hz	HD-Single	SMPTE 292M292M 1.5Gbps HD	YCbCr	4:02:02	10	128m
1080i 60Hz	HD-Single	SMPTE 292M292M 1.5Gbps HD	YCbCr	4:02:02	10	128m
1080P 30Hz	HD-Single	SMPTE 292M292M 1.5Gbps HD	YCbCr	4:02:02	10	128m
1080P 25Hz	HD-Single	SMPTE 292M292M 1.5Gbps HD	YCbCr	4:02:02	10	128m
1080P 50Hz	HD-Single	SMPTE 292M292M 1.5Gbps HD	YCbCr	4:02:02	10	128m
1080P 24Hz	HD-Single	SMPTE 292M292M 1.5Gbps HD	YCbCr	4:02:02	10	128m
720P 60Hz	HD-Single	SMPTE 292M292M 1.5Gbps HD	YCbCr	4:02:02	10	128m
720P 50Hz	HD-Single	SMPTE 292M292M 1.5Gbps HD	YCbCr	4:02:02	10	128m
1080Sf 25Hz	HD-Single	SMPTE 292M292M 1.5Gbps HD	YCbCr	4:02:02	10	128m
1080Sf 30Hz	HD-Single	SMPTE 292M292M 1.5Gbps HD	YCbCr	4:02:02	10	128m
1080P 50Hz	3G Level A	SMPTE 424M 3Gbps	YCbCr	4:02:02	10	128m
1080P 59.94Hz	3G Level A	SMPTE 424M 3Gbps	YCbCr	4:02:02	10	128m
1080P 60Hz	3G Level A	SMPTE 424M 3Gbps	YCbCr	4:02:02	10	128m
1080P 50Hz	3G Level B	SMPTE 424M 3Gbps	YCbCr	4:02:02	10	128m
1080P 59.94Hz	3G Level B	SMPTE 424M 3Gbps	YCbCr	4:02:02	10	128m
1080P 60Hz	3G Level B	SMPTE 424M 3Gbps	YCbCr	4:02:02	10	128m

*note:*

Signals are not supported for EIP-UHS100/XHS100, if it is not in the table.

## PIP

Use this function to display multiple windows each containing an image.

## PIP Option

Use this to enable or disable the Picture In Picture function.

## PIP Input

Press ENTER to display available sources for the sub picture then select a source. Note that unavailable input source of submenu are gray out and can not be selected. The available input source of sub picture is as below combination list.

INPUT	PICTURE	LAMPS	ALIGNMENT	CONTROL	SERVICE
Input Selection		Enter			
Test Pattern		Enter			
Color Space	<	Auto	>		
Input Lock	<	Auto	>		
Background	<	Logo	>		
Auto Sync Adjust	<	Always	>		

Source	HDMI	DVI	VGA	Component/BNC	3G-SDI
HDMI	X	X	O	O	X
DVI	X	X	O	O	X
VGA	O	O	X	X	O
BNC	O	O	X	X	O
3G-SDI	X	X	O	O	X

## PIP Swap

Use the function to swap between the main screen and sub screen, below shows the illustration of PIP SWAP.

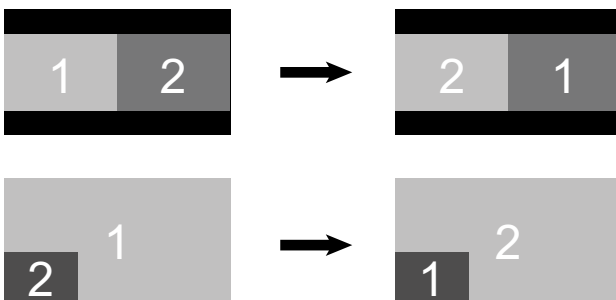

## Position

Use this function to select the location of the PIP window to Top left, Top Right, Bottom Left, Bottom Right, or Split L-R.

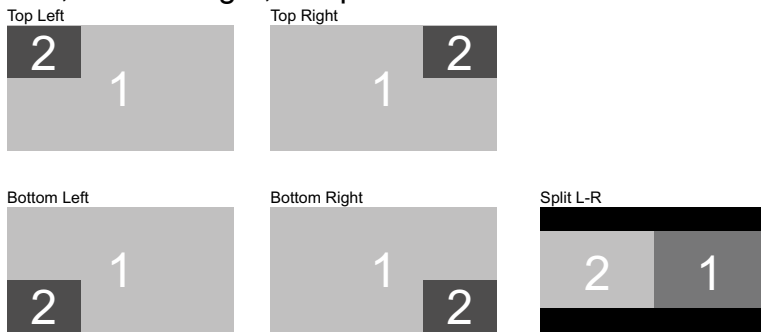

## Test Pattern

Select this function to display test pattern, press ◀ or ▶ once to display the last or next pattern, press EXIT to exit test pattern.

## Color Space

This function allows you to change component and RGB input sources. You can select different color space for different color performance.

**Auto:** The default setting is Auto.

**HDMI:** If the Auxiliary Video Information (AVI) contains color space and/or range data, the EIP-UHS100/XHS100 uses that information to switch to corresponding color space.

**RGB:** If Hsync or Vsync signals are present, the projector will switch to RGB-PC color space.

**Component:** For SDTV and EDTV resolutions, the EIP-UHS100/XHS100 uses the REC601 color space. For all other resolutions REC709 is used.

In most cases, the Auto setting determines the correct color space. If it does not, you can use a specific color space. Choose one of the following:

**YCbCr:** uses component color space and sets black at 0,0,0 and white at 255,255,255.

**YPbPr:** uses composite color space and sets black at 0,0,0 and white at 255,255,255.

**RGB-PC:** uses RGB color space and sets black at 0,0,0 RGB and white at 255,255,255 RGB, assuming an 8-bit image.

**RGB-Video:** uses RGB color space and sets black at 16,16,16 RGB and white at 235,235,235, assuming an 8-bit image, to correspond to the luminance values defined in digital component standards.

## Input Lock

Use this function to lock a source to an internal sync signal (Auto, 48Hz, 50Hz, or 60Hz). Auto setting locks the sync signal to the current source.

## Background

Use this function to set the background screen with no signal. You can select from Logo, Blue, Black and White. The default setting is Logo.

## Auto Sync Adjust

Use the function to adjust the setting automatically for the incoming signal by the black level, gain, and reference (Always, Off, Auto).

## OSD Introduction – PICTURE

INPUT	PICTURE	LAMPS	ALIGNMENT	CONTROL	SERVICE
Picture Mode	< High Bright >				
Contrast	< 100				
Brightness	< 100	:			
Adaptive Contrast	< Off	:			
Gamma	< Video >				
Color	Enter				
Sharpness	< 0 >				
Noise Reduction	< 0 >				
Aspect Ratio	< 16:10 >				
Overscan	< Off >				
VGA Setup	Enter				
Auto Sync	Execute				

### Picture Mode

Use ◀ or ▶ to select the High Bright, Presentation and Video mode.

### Contrast

Use ◀ or ▶ to adjust the contrast of the projected image.

*Note:*

*Brightness and Contrast controls are interactive. The screen change to one may require a subtle change to the other in order to achieve the optimum setting*

### Brightness

Use ◀ or ▶ to adjust the level of black in the image to increase or decrease image brightness.

### Adaptive Contrast

Use ◀ or ▶ to adjust the light and dark aspects of the contrast curve.

### Gamma

Use ◀ or ▶ to select Video, Film or Graphics.

### Color

Use ◀ or ▶ to adjust the color temperature of the projected image.

This refers to the control of color imbalance in the darker areas of the projected image. It is recommended that you use an external test image with many areas of dark and gray colors (i.e. an image of 30IRE-window). If you notice minimal amount of red, green or blue in the gray areas, adjust the offset of the corresponding color accordingly. This function will shift the entire color spectrum for the whole image and change its brightness.



## Sharpness

The adjustment of sharpness primarily changes the value of high frequency detail. Use ◀ or ▶ to adjust it.

## Noise Reduction

Use ◀ or ▶ to adjust the noise of the projected image. This function is suitable for the elimination of image noise from interleaving SD input. Generally speaking, reducing image noise will lower the value of high frequency detail and make the image appear more mellow.

## Aspect Ratio

This function allows user to adjust the picture's Aspect ratio.

When Native input is 16:10, the images as following is the result of picture's aspect ratio for your preference.

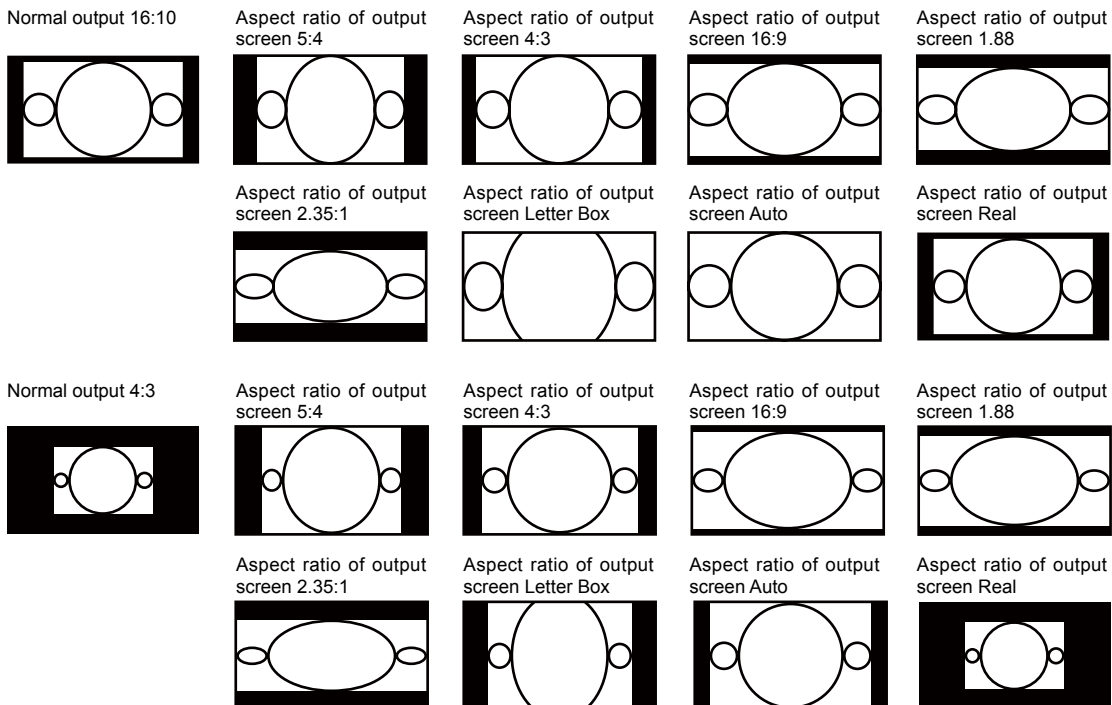

## Overscan

Some programs may display the edges of the image. Use this function to hide the edge by choosing one of the following three options.

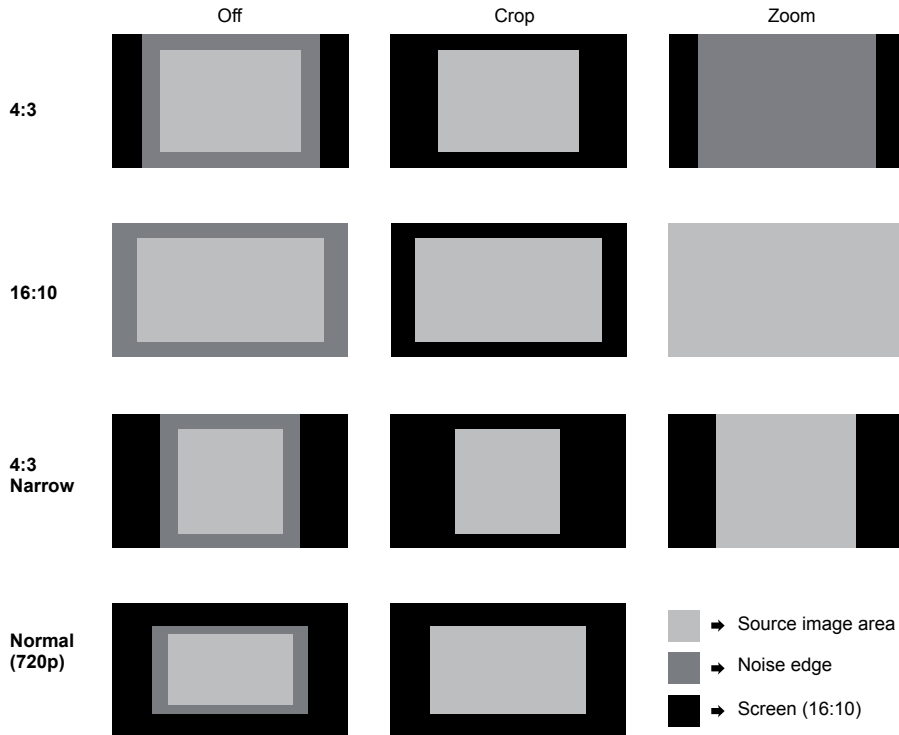

## VGA Setup

Use this function to set up H-Total, H-Start, V-Phase and V-Start of VGA input.

## Auto Sync

Use this function to EXECUTE the automatic adjust setting of black level, gain for the incoming signal.

## OSD Introduction – LAMPS

INPUT	PICTURE	LAMPS	ALIGNMENT	CONTROL	SERVICE
Mode			Enter		
Power		<	Normal	>	
High Altitude		<	Off	>	
Custom Power Level		<	100.0 %	>	
Lamp 1 Status			Off		
Lamp 2 Status			Off		

### Mode

Use ◀ or ▶ function to select single or dual lamp mode.

### Power

Use ◀ or ▶ function to select Eco, Normal, or Custom Power Level.

### High Altitude

Use this function to switch the projector's cooling fan for high-altitude circumstances. You can set it to Off or On. The default setting is Off.

Under normal circumstances, the projector will operate normally with this function set to Off. If you were to operate the projector in environment of excessive heat or in areas of high altitude, the projector may automatically shut down due to overheat. When this happens, you can enable this function by setting it to On to force the cooling fan to work at a higher speed to regulate the temperature inside the projector.

*Note:*

*High altitude region refers to area with elevation over 5000 feet*

### Custom Power Level

Use this function to fine-tune the brightness. You can set power range from 80.4% to 100%.

### Lamp 1 Status

Displays the Lamp 1 status.

### Lamp 2 Status

Displays the Lamp 2 status.

# OSD Introduction - ALIGNMENT

INPUT	PICTURE	LAMPS	ALIGNMENT	CONTROL	SERVICE
	Lens Memory		Projection Mode	<	Front >
	Load Memory	Enter	Fan Mode	<	Normal >
	Save Memory	Enter	Lens Control		Enter
	Clear Memory	Enter	Lens Memory		Enter
			Center Lens		Excute
			Warp		Enter
			Blanking		Enter
			Edge Blend		Enter

## Projection Mode

Use ◀ or ▶ function to select the projection mode (Front, Rear, Ceiling + Front, Ceiling + Rear).

## Fan Mode

Use ◀ or ▶ to set the fan mode to Normal, Up or Down.

**Normal:** Normal fan speed.

**Up** : Increase the fan speed.

**Down** : Decrease the fan speed.

## Lens Control

Use this function to display Lens Control window, press ◀, ▶, ▲ or ▼ to adjust lens shift, Zoom or Focus. Press Enter button to switch window for Zoom & Focus adjustment or Lens Shift adjustment.

Lens Control		Lens Control	
Shift V	▲ ▼	Zoom	▲ ▼
Shift H	◀ ▶	Focus	◀ ▶
Enter to Zoom/Focus		Enter to Shift	

## Lens Memory

Load Memory: Select this item to load the lens settings.

Save setting: You can save the lens settings.

Clear Memory: Select this item to clear the lens settings.

### Center Lens

Execute to center the lens.

### Warp

Use this function to correct image distortion.

### Keystone

Use ◀ or ▶ to correct horizontal distortion. Press ▲ or ▼ to correct vertical distortion.

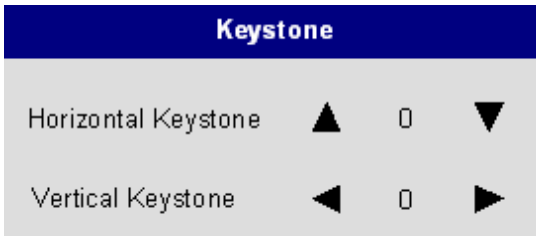

### Rotation

Press ◀ or ▶ to rotate the projected image.

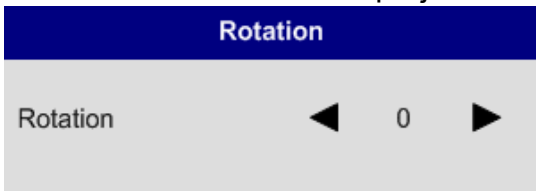

The adjustable value is from -20 to 20 steps.

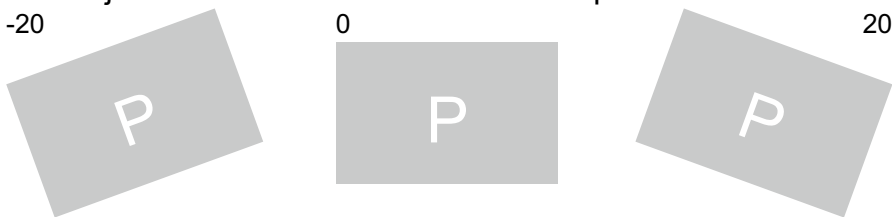

### Pincushion / Barrel

Use this function to correct pincushion or barrel distortion. The adjustable range is from -100 to 100 steps. Press ◀ to correct pincushion distortion, ▶ to correct barrel distortion.

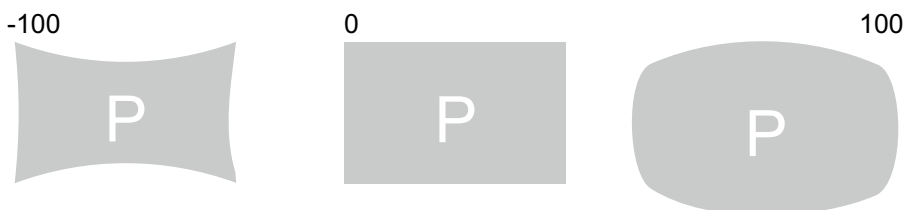

### Top Left Corner



Press ◀▶ to correct top left corner image distortion.



### Top Right Corner



Press ◀▶ to correct top right corner image distortion.



### Bottom Right Corner



Press ◀▶ to correct bottom right corner image distortion.



### Bottom Left Corner



Press ◀▶ to correct bottom left corner image distortion.



### Reset

Set all values to factory defaults.

### Blanking

Use this function to adjust the edges of the image and hide unwanted sections of the screen.

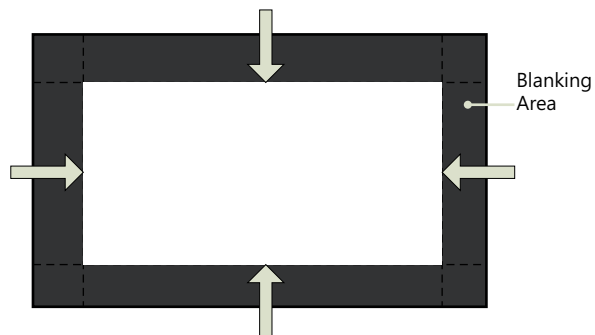
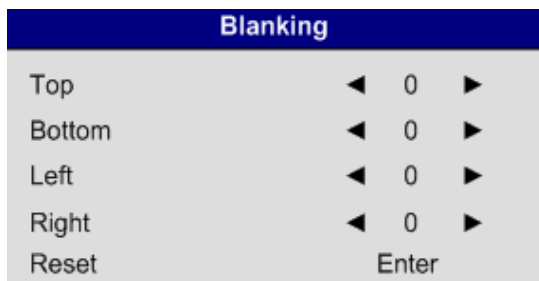

### Top

Use ◀▶ to adjust the top blanking area on the projected image.

### Bottom

Use ◀▶ to adjust the bottom blanking area on the projected image.

### Left

Use ◀▶ to adjust the left blanking area on the projected image.

### Right

Use ◀▶ to adjust the right blanking area on the projected image.

## Reset

Reset all the blanking functions to the default settings.

## Edge Blend

Edge blend function allows multiple projector images to be seamlessly overlapped. To use this function, Edge Blend must be enabled on both projectors.

## Blend Width

Press Enter to display Blend Width window, use ◀▶ to adjust white level for, bottom, left and right blending zone. If the Alignment Pattern is enabled, the green alignment line is moved according the setting value you made. Below is an example of setting blend width.

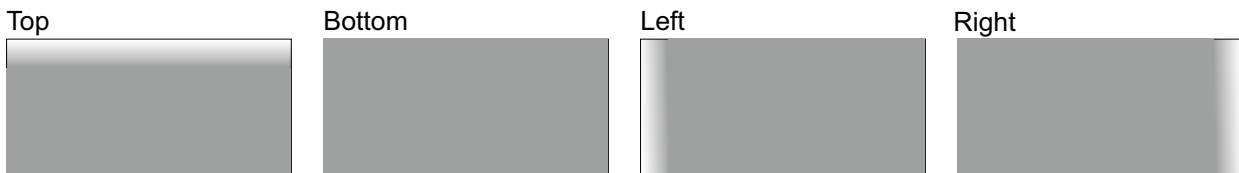

Note:

Notice the green lines appear to indicate the edge of the screen and the start/end of the blend zone.

## Black Level Uplift

Black Level Uplift is used to compensate for the lack of pure black output from projectors, due to light leaking to the projection screen. When projecting black, the overlapping area where the two images overlap project twice the projectors' black output levels. The solution is to adjust the Black Level Uplift.

Input signal is black, then increase the Black Level Uplift (Top, Bottom, Left, Right) until the non-overlap area's brightness matches the overlap area.

Adjust the black level by setting the Selected Area (Top, Bottom, Left, Right) to match the black levels. You can adjust all colors at the same time or adjust Red, Green or Blue respectively.

Note:

Four corners, black level uplift adjustment function is not available.

Corner blending, black level uplift adjustment function is not available.

Black balance			
	Select		
Up	◀	0	▶
Down	◀	0	▶
Left	◀	0	▶
Right	◀	0	▶
	Adjustment		
All	◀	0	▶
Red	◀	0	▶
Green	◀	0	▶

## Reset

This function resets Edge Blend to the factory default settings.

## Align Pattern

Set to ON to Enable this function to use a test pattern to align and adjust multiple images, the alignment line is moved according to Blend Width setting.

## OSD Introduction – CONTROL

INPUT	PICTURE	LAMPS	ALIGNMENT	CONTROL	SERVICE
	Network		Eco Network Power	< Standard >	
IP Address	192.168.00.100		Auto Power Off	< Off >	
Subnet Mask	255.255.255.00		Auto Power On	< Off >	
Gateway	192.168.00.254		Project Control	< Network >	
DHCP	< Off >		Network	Enter	
			Start Up Logo	< On >	
			Trigger	< Auto >	
			Auto Search	< Off >	
			Dynamic Black	< Off >	
			 Language	Enter	

### Eco Network Power

Press ◀▶ to set Standard or Eco network power.

### Auto Power Off

The default value is OFF. If you set it ON, the projector will automatically shut down after 20 minutes without input signal.

### Auto Power On

The default value is Off. If you set it to ON, the projector will automatically start up when it is connected to the AC power.

### Projector Control

Use ◀▶ to select RS232 or Network for the projector control.

### Network

Use this function to display the network configuration.

### Start Up Logo

Use ◀▶ select on or off of the start up logo.



## Trigger

The projector comes with one set of Trigger output. You can configure one devices connected to the projector via the trigger port to be automatically turned on when the projector is on. There will be a 2-3 second delay prior to activation to prevent operation of this function when the user is choosing an aspect ratio.

5:4: Outputs 12V of power on Trigger when Aspect Ratio is set to 5:4.

4:3: Outputs 12V of power on Trigger when Aspect Ratio is set to 4:3.

16:10: Outputs 12V of power on Trigger when Aspect Ratio is set to 16:10.

16:9: Outputs 12V of power on Trigger when Aspect Ratio is set to 16:9.

1.88: Outputs 12V of power on Trigger when Aspect Ratio is set to 1.88.

2.35: Outputs 12V of power on Trigger when Aspect Ratio is set to 2.35.

Letterbox: Outputs 12V of power on Trigger when Aspect Ratio is set to Letterbox.

Native: Outputs 12V of power on Trigger when Aspect Ratio is set to Native.

Unscaled: Outputs 12V of power on Trigger when Aspect Ratio is set to Unscaled.

Auto: Outputs 12V of power on Trigger automatically.

## Auto Search

Use ◀▶ to turn On/Off auto search.

## Dynamic Black

Use ◀▶ to turn On/Off dynamic black.

## Language

See page 32.

## OSD Introduction – SERVICE

INPUT	PICTURE	LAMPS	ALIGNMENT	CONTROL	SERVICE
	Model :		XXXXX XXXXX		
	Serial Number :		XXXXX XXXXX		
	Software Version :		ME10-GE04-Ub02-5050-39-IFNE08-P06-D04		
	Active/PIP Source :	VGA		/ Off	
	Pixel Clock		83.49MHz		
	Signal Format		1280x800@60Hz		
	H/V Refresh Rate :		H: 49.725 KHZ V: 60 HZ		
	Lamp 1 Time :		XXXX HRS		
	Lamp 2 Time :		XXXX HRS		
	Power On Time :		XXXX HRS		
	Blue Only	<	Off	>	
	Factory Reset		Enter		

The functions covered in this unit relate to the display of some basic information about the projector.

*Note:*

*Memory of the custom timing files will be erased in the Factory Reset operation.*

**Model**

The designated model number of the projector.

**Serial Number**

The designated serial number of the projector.

**Software Version**

The version of software installed on the projector.

**Active/PIP Source**

Displays the current Active/PIP sources.

**Pixel Clock**

Displays the pixel clock of the current input signal.

**Signal Format**

Displays the format of the current input signal.

**H/V Refresh Rate**

Displays the horizontal and vertical refresh rates for the current image.

**Lamp 1 Time**

Display the lamp 1 usage time. When you change the new lamp.

**Lamp 2 Time**

Display the lamp 2 usage time. When you change the new lamp.

**Power On Time**

Display the total On time for the projector.

**Blue Only**

This function displays only blue color to facilitate the process of image inspection for a service personnel.

**Factory Reset**

Restore the configurations in the OSD Menu back to the factory default. Note that this function will not apply to items including no signal, network, Projector control, startup Logo, language, High Altitude mode and lamp hours.

*Note:*

*When Factory Reset is executed, all source memories created by the projector (i.e. timings files) will be erased.*