

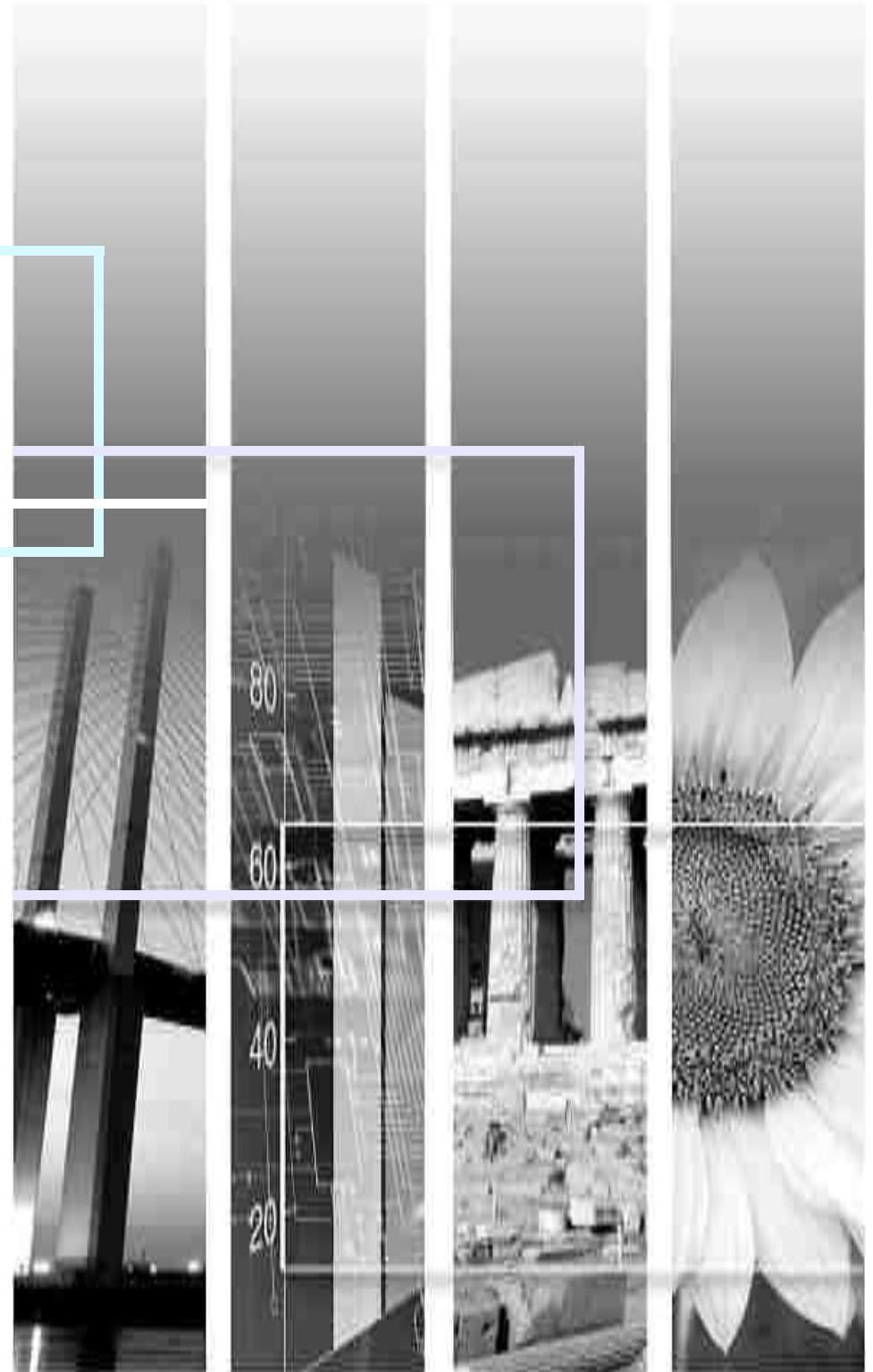





EPSON®

LCD Projector User's Guide

EMP-S1H



	Indicates the possibility that people may be injured or the equipment may be damaged if these symbols are ignored.
	Indicates important related information or useful information and things you should know.
	Indicates related topics and pages which contain more detailed information.
	Provides terminology definitions.  "Glossary" P.63

The terms "this unit" and "this projector" which appear in this manual may also refer to the accessories supplied with the projector and other optional products.

■ Auto setup (Computer connections)

The projector analyses the signal of the computer to which it is connected and automatically makes adjustments to ensure optimal projection results.

☛ "Auto setup (Computer connections)" P.27

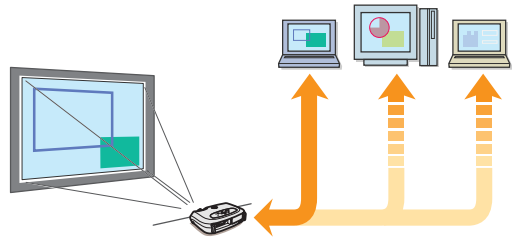

■ Colour mode

Image quality can be selected according to the type of scene.

☛ "Selecting a colour mode" P.27

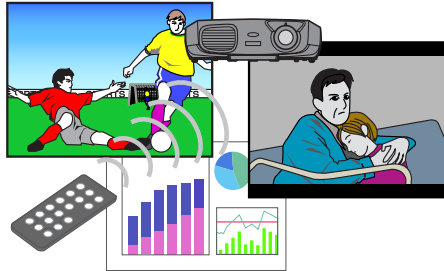

■ Compact and lightweight

The projector's compact body is easy to carry.

Dimensions: 26.5(d) × 37(w) × 10.6(h) cm

Weight: approx. 3kg

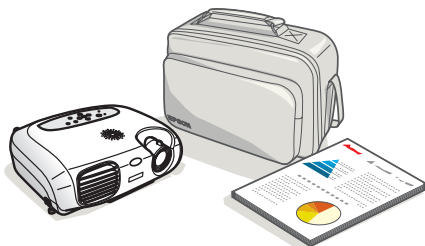

■ Clear, vivid, images

The projector's high resolution and high luminance achieves a legible display. Project sharp, detailed images, even in bright places.



■ Ease of use

Various projector operations can be easily performed using the included remote controls, as follows:

- pausing projection
- zooming in on important areas of an image

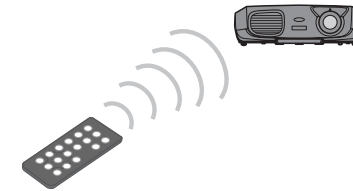

■ Unique presentation function

The mouse pointer can be moved around on the computer screen during projection using the included presentation remote control. (wireless mouse)

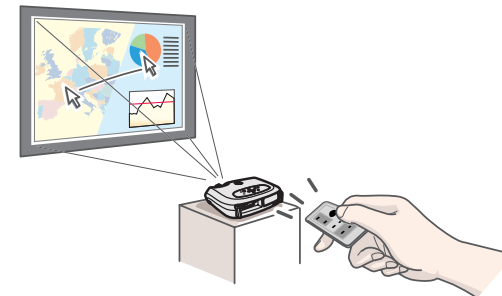

Meaning of Symbols.....	1
Features.....	2
Contents	3

Before Using the Projector

Part Names and Functions	4
Front/Top	4
Control panel	5
Rear	6
Base.....	7
Remote Control.....	8
Installation.....	10
Installation method.....	10
Projection distance and screen size	10
Other installation methods	11
Connecting to a Computer.....	12
Compatible computers	12
Projecting images from a computer	13
Playing sound from a computer	14
Connecting to an external monitor.....	14
Presentation Remote Controller	15
Connecting to Video Equipment	18
Projecting video images.....	18
Playing sound from video equipment.....	19

Basic Operation

Turning on the Projector.....	20
Turning off the Projector.....	22
Adjusting the Display	23
Adjusting the projection size	23
Setting the focus	23
Adjusting the projection angle.....	24
Keystone	25
Selecting the Input Source	26

Advanced Operation

Functions for Enhancing Projection	27
Adjusting computer generated images	27
Selecting a colour mode	27
A/V Mute.....	28
Freeze	28
Projecting in widescreen (changing aspect ratio).....	29
E-Zoom.....	30
Configuration Menus	31
Menu operation	32
Function list	35

Troubleshooting

When You Suspect a Problem	43
Power indicator.....	43
Warning indicator	44
When the indicators provide no help	46

Appendices







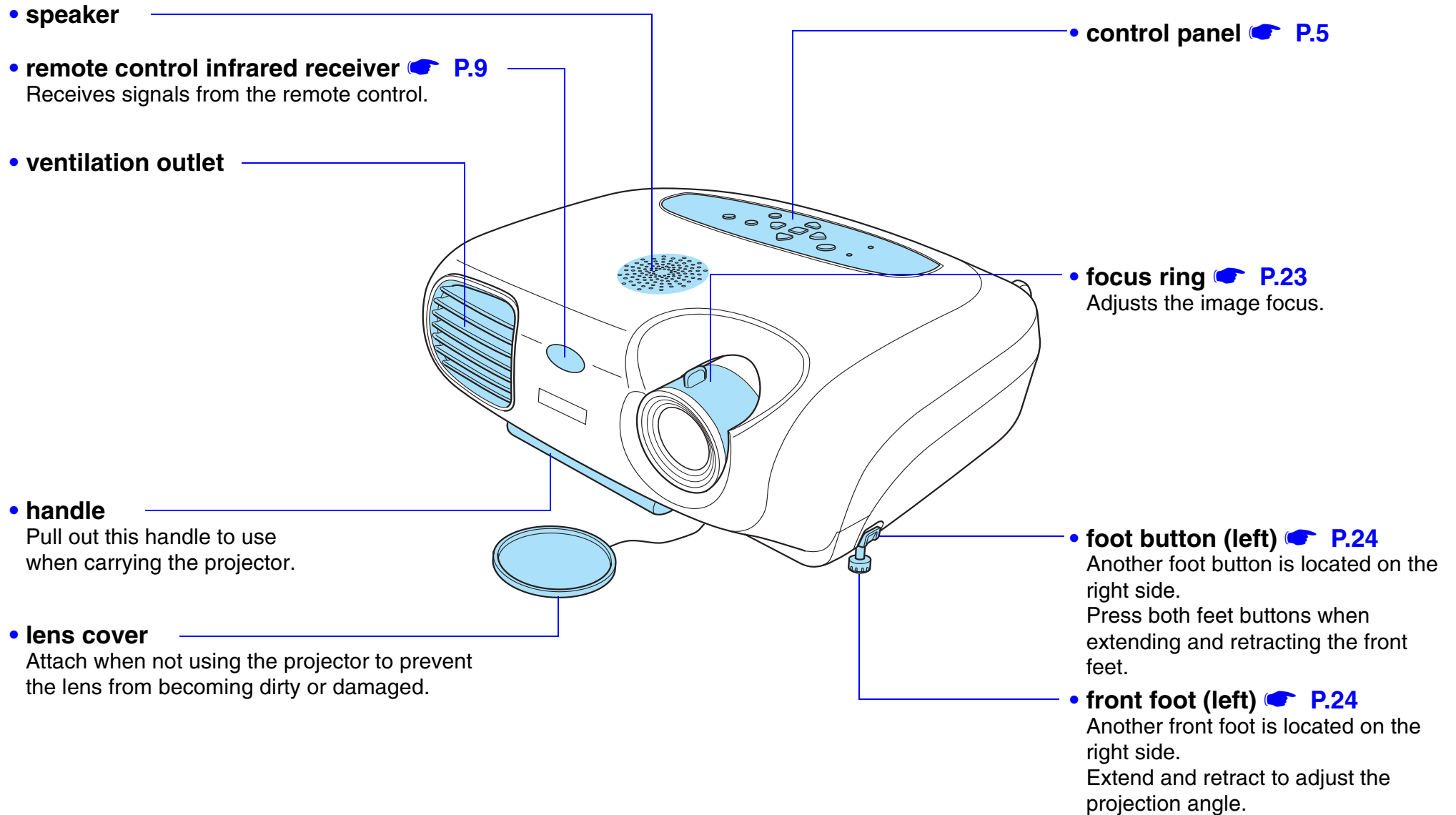

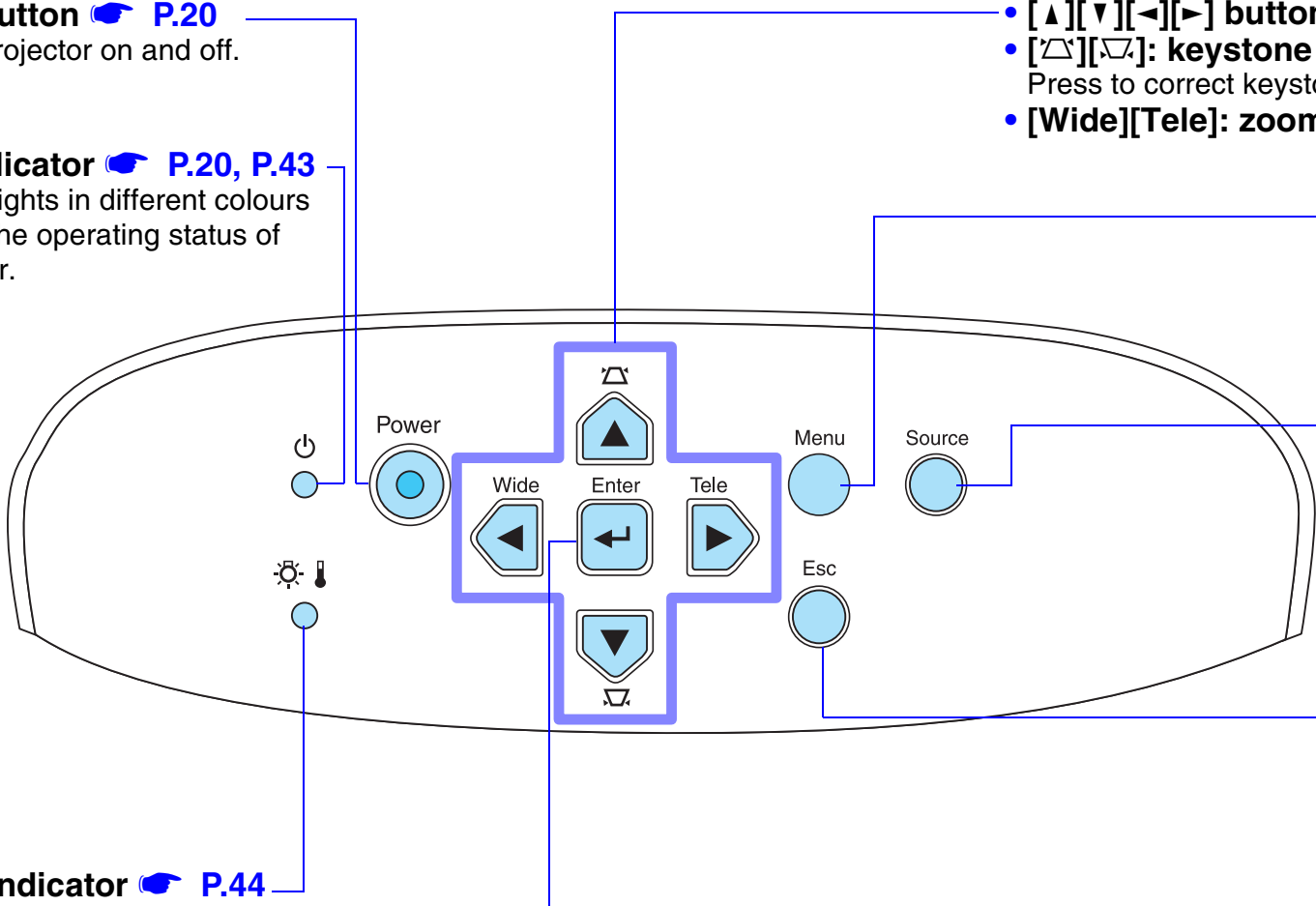

Projector Care.....	54
Cleaning	54
Replacing consumables	56
Optional Accessories.....	61
Glossary	63
Cable Format	66
Supported Display Resolutions	67
Specifications.....	68
Appearance.....	69
Index.....	70

Part Names and Functions

Front/Top



Control panel

- 
- The diagram shows the control panel of a projector with various buttons and indicators. A blue box highlights the central navigation cluster. Blue lines connect callout boxes to specific components on the panel.
- **[Power] button**  **P.20**
Turns the projector on and off.
 - **Power indicator**  **P.20, P.43**
Flashes or lights in different colours to indicate the operating status of the projector.
 - **Warning indicator**  **P.44**
Flashes or lights in different colours to alert you to problems with the projector.
 - **[▲][▼][◀][▶]** buttons  **P.32**
 - **[△][▽]: keystone correction buttons**  **P.25**
Press to correct keystone distortion in images.
 - **[Wide][Tele]: zoom buttons**  **P.23**
 - **[Menu] button**  **P.31**
Displays or hides the configuration menus.
 - **[Source] button**  **P.26**
Switches the input source between the Computer/Component Video port, S-Video port and Video port each time the button is pressed.
 - **[Esc] button**  **P.34**
Stops the current function. Displays the previous screen or menu when viewing configuration menus.
 - **[↵] button**  **P.33**
Accepts a menu item or advances to the next screen or menu when viewing configuration menus.

Rear

- **Computer/Component Video port**  **P.13, P.18**

Inputs analogue video signals from a computer and [Component Video](#) signals from other video sources.

- **Video port**  **P.18**

Inputs [Composite Video](#) signals to the projector.
Connect using an A/V cable.

- **S-Video port**  **P.18**

Inputs [S-Video](#) signals to the projector.
Connect using an S-Video cable.

- **Audio port**  **P.14, P.19**

Inputs audio signals to the projector.
Connect using an A/V cable, or a stereo RCA cable.
When using computer and video equipment alternately, swap the cable or use an audio switch.

- **Control (RS-232C) port**  **P.66**

Connects the projector to a computer using an RS-232C cable. This port is for control use and should not be used by the customer.

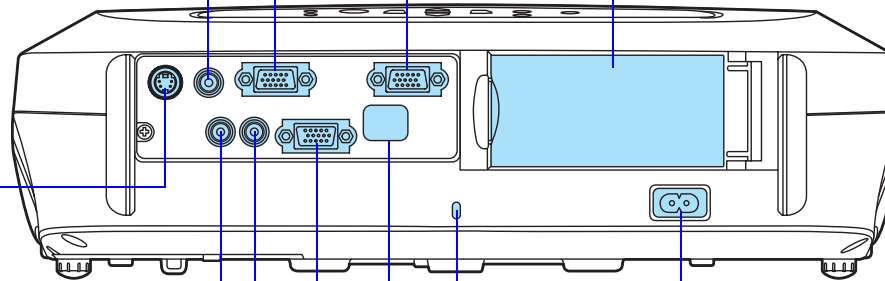

- **Monitor Out port**  **P.14**

Outputs the projected analogue computer signal to an external monitor. This feature is not available for video signals.

- **remote control holder**  **P.9**

Store the remote control in here when not in use.

- **power inlet**  **P.20**

Connects the power cable.

- **security lock**  **P.64**

- **remote control infrared receiver**  **P.9**

Receives signals from the remote control.

Base

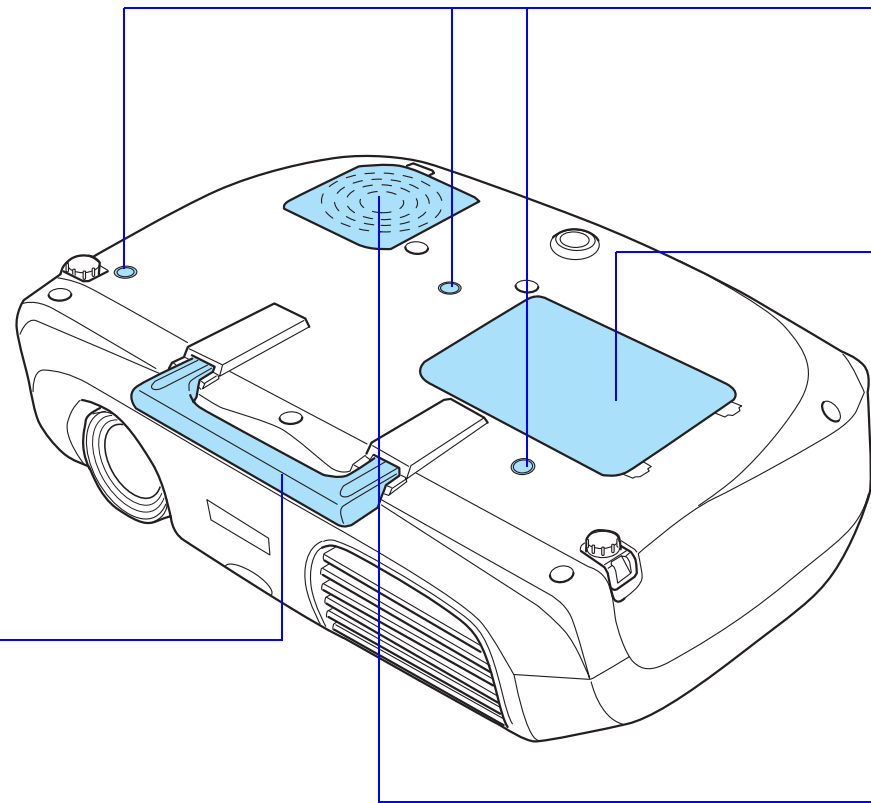

- **handle**
Pull out this handle to use when carrying the projector.

- **Ceiling mount fixing points (3 points)**
Install the optional ceiling mount here when suspending the projector from the ceiling.

- **lamp cover**  **P.57**
Open this cover when replacing the lamp inside the projector.

- **air filter (air intake vent)**  **P.55, P.60**
Prevents dust and other foreign particles from being drawn into the projector. When replacing the lamp, replace the air filter also.

- **remote control infrared transmitter**

Transmits remote control signals.

- **[E-Zoom] buttons**

⊕ : Enlarges part of the image without changing the size of the projection area.

⊖ : Reduces the part of the image that has been enlarged using the [⊕] button.

- **[Source] buttons**

[Computer]: Switches to the signal source being input to the Computer/Component Video port.

[S-Video/Video]: Switches between the signal source being input to the S-Video port and the Video port.

- **[Aspect] button**

Changes the aspect ratio of images from 4:3 to 16:9.

- **[▲][▼][←][→] buttons**

Selects menu items and setting values.

- **[🔊][🔇]: volume buttons**

Adjusts the volume.

- **[Menu] button**

Displays or hides the configuration menus.

- **[A/V Mute] button**

Momentarily turns off the audio and video.

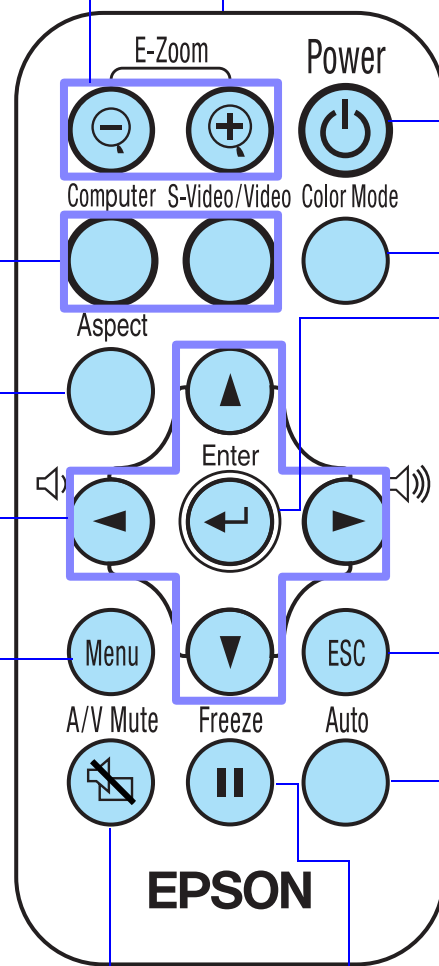

- **[Power] button**

Turns the projector on and off.

- **[Color Mode] button**

Selects the colour mode. The colour mode changes in the order of Dynamic, Presentation, Theatre, Living Room and **sRGB** each time the button is pressed.

- **[↵] button**

Accepts a menu item or advances to the next screen or menu when viewing configuration menus.

- **[Esc] button**

Stops the current function. Displays the previous screen or menu when viewing configuration menus.

- **[Auto] button**

Use this button to automatically adjust computer images to their optimum settings when automatic setup has been set to "OFF".

- **[Freeze] button**

Keeps the current computer or video image on the screen.

■ Before using the Remote Control

Remove the insulating tape.

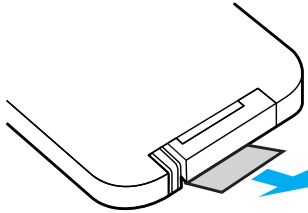

■ Using the Remote Control

Operate the remote control by aiming it at the remote control infrared receiver on the projector.

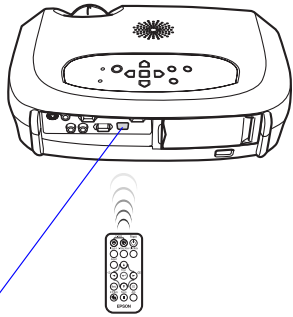

remote control infrared receiver

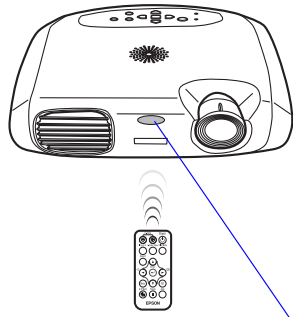

remote control infrared receiver

■ Operating range

Operable distance: Max. approx. 6m (20ft.)
(May be shorter depending on conditions.)

Operable angle: approx. 30° horizontally, 15° vertically

* The remote control infrared receiver on the back of the projector can also be used under the same conditions.

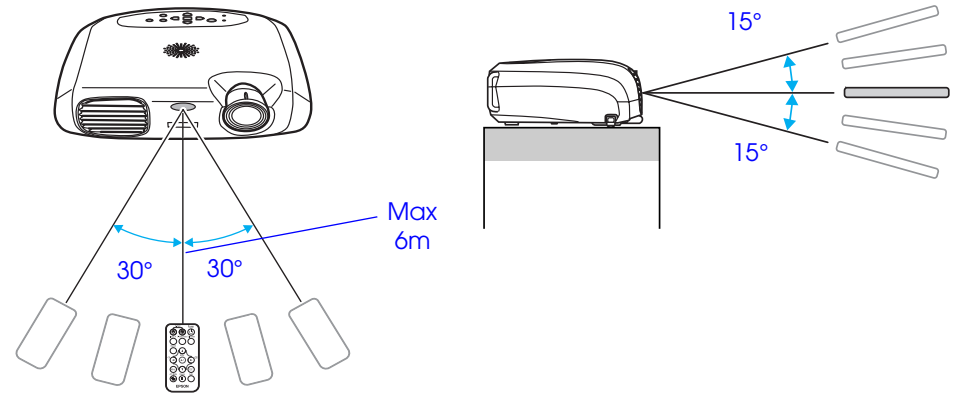

■ Storage

When not using the remote control, please store it in the remote control holder on the projector.

- 1 Open the remote control holder.
- 2 Place the remote control in the remote control holder.
- 3 Close the remote control holder until it clicks into place.

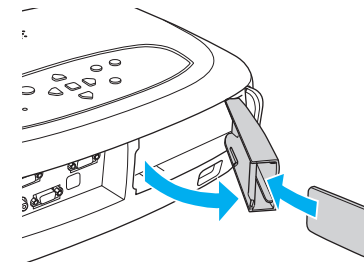

 ***If direct sunlight or fluorescent lighting hits the remote control infrared receiver, you may not be able to use the remote control.***

! *Be sure to read the "Safety Instructions / World-Wide Warranty Terms" guide before installation.*

Installation method

Set up the projector so that it is at right angles to a screen.

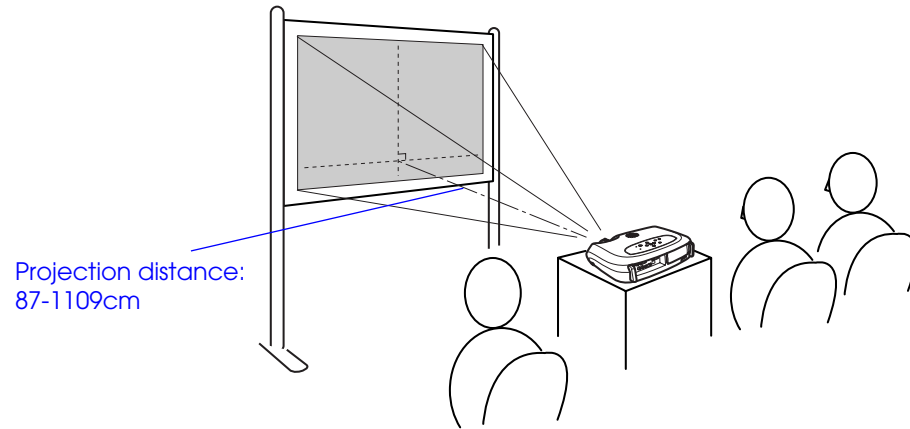

! *When setting up the projector against a wall, leave a space of at least 20cm between the projector and the wall.*

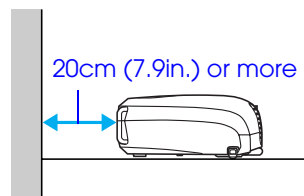

Projection distance and screen size

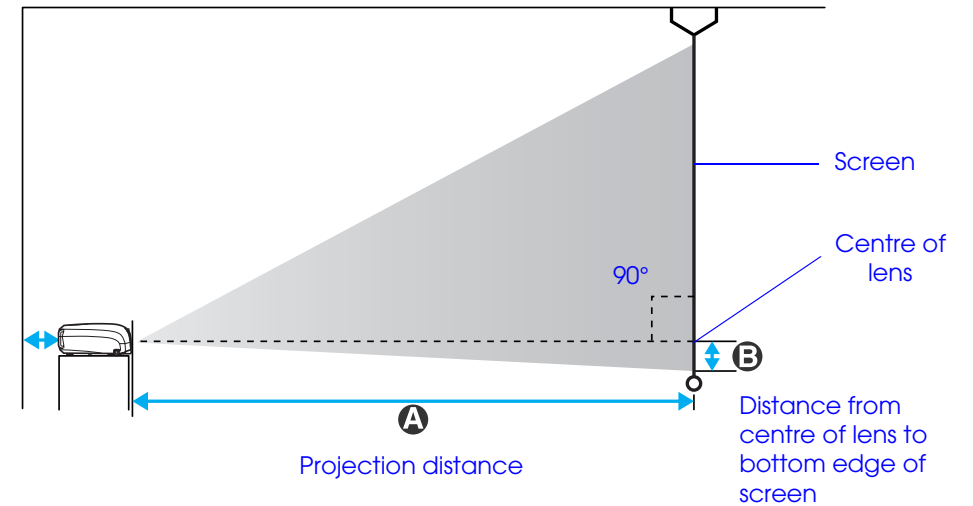

4:3 Screen size (cm/ft.)	A cm (ft.)	B cm (in.)*
30" (61 × 46 / 24.0 × 18.1)	87-108 (2.9 –3.5)	4 (2)
40" (81 × 61 / 31.9 × 24.0)	117-145 (3.8 –4.8)	6 (2)
60" (120 × 90 / 47.2 × 35.4)	177-219 (5.8 –7.2)	9 (3)
80" (160 × 120 / 63.0 × 47.2)	237-293 (7.8 –9.6)	12 (5)
100" (200 × 150 / 78.7 × 59.1)	297-367 (9.7 –12.1)	14 (6)
200" (410 × 300 / 161.4 × 118.1)	596-738 (19.6 –24.2)	29 (11)
300" (610 × 460 / 240.2 × 181.1)	895-1109 (29.4 –36.4)	43 (17)

*The value of B decreases when you reduce the image with the zoom.
(The minimum value is zero)

The values should be used as a guide for setting the projector.

Other installation methods

■ Rear projection

(Using a translucent screen)

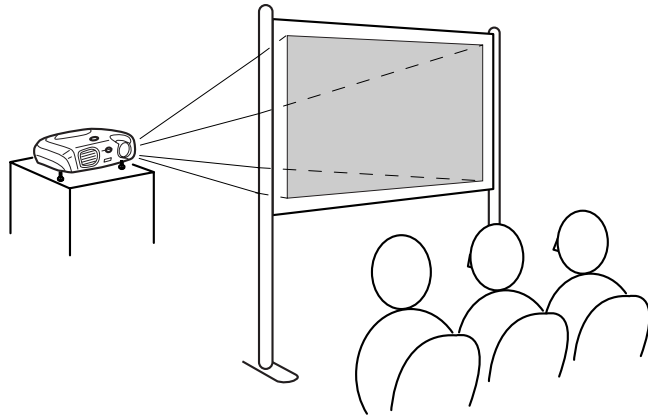

■ Ceiling projection

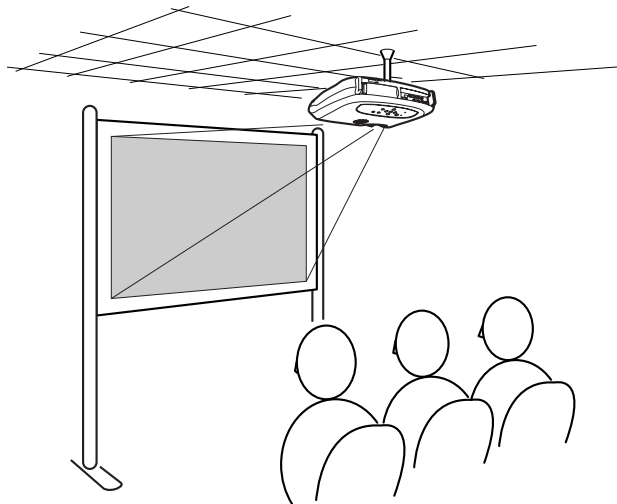

■ Ceiling/Rear projection

(Using a translucent screen)

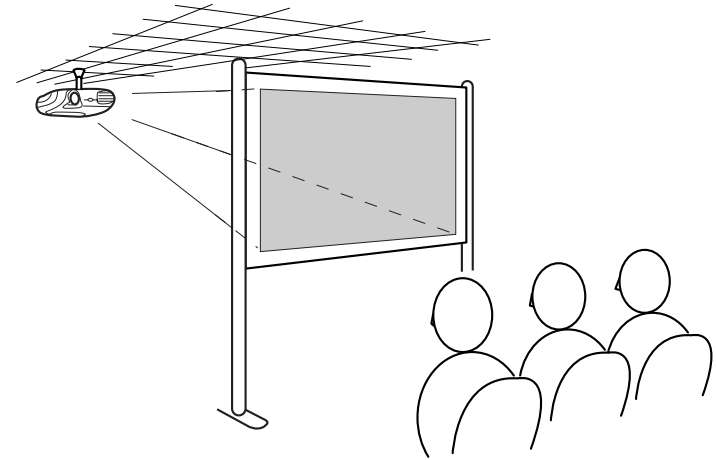

* The optional ceiling mount is required when installing the projector from a ceiling. Please contact your dealer if you wish to use this method, as special equipment is required for installation. ➡ ["Optional Accessories" P.61](#)

 **When using rear projection, or projecting from a ceiling, select the appropriate mode in the "Setting" → "Screen" → "Projection" configuration menu. ➡ ["Setting menu" P.38](#)**



When connecting, be sure to:

- **Turn off the power for both the projector and the computer.**
Damage may result if you try to make a connection when the power is switched on.
- **Check the connector types.**
Damage may result if you attempt to insert a connector into the incorrect port.

Compatible computers

Condition 1: Check that the computer has an image output port, such as an RGB port, monitor port or CRT port.

Some computers with an in-built monitor and some laptop computers may not be compatible. Please refer to your computer manual for further details.

Condition 2: The display frequency and resolution of the computer must correspond to that of the projector.  ["Supported Display Resolutions" P.67](#)



- **You may need to purchase a separate adapter depending on the shape of the computer's port. Refer to the documentation provided with the computer for further details.**
- **If the computer and projector are too far away from each other for the provided computer cable to reach, use the optional VGA-HD15 PC cable.**  ["Optional Accessories" P.61](#)

■ Laptop connection

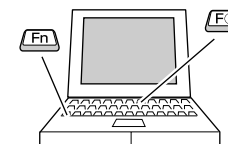

When using a laptop or a PC with an in-built monitor, select external video output on the computer.

Setup examples

Press and hold the [Fn] key, followed by the appropriate function number key.

NEC	[Fn]+[F3]
Panasonic	
Toshiba	[Fn]+[F5]
IBM	[Fn]+[F7]
SONY	
Fujitsu	[Fn]+[F10]
Macintosh	After start up enable "Mirroring" in the Monitors Control Panel.

Refer to your computer's documentation for further details.

- It may take a few moments until the computer image is projected.
- Depending on your version of Windows, a dialog box may appear to alert you that new display hardware has been found. Follow the on-screen instructions to proceed. If you have any problems, please contact the nearest address provided in the "International Warranty Conditions" section in the "Safety Instructions / World-Wide Warranty Terms" guide.
- Depending on the PC, the monitor may go blank when using the external video output on the computer.

Projecting images from a computer

Different cables are used depending on whether the monitor port of your computer is a Mini D-Sub 15Pin, [5BNC](#) or 13w3 port.

■ When using a Mini D-Sub 15 pin connector

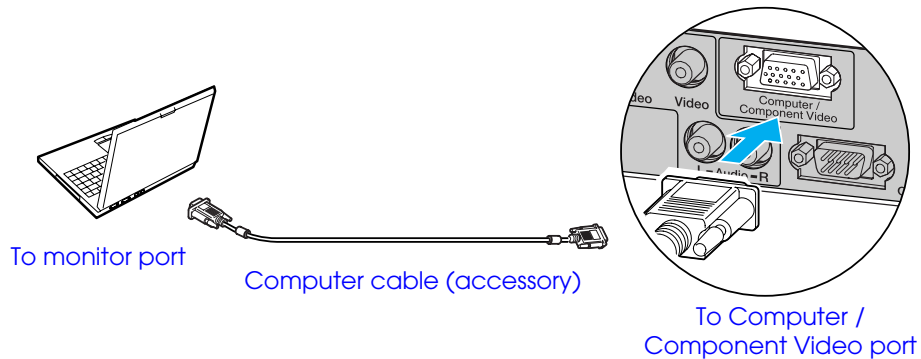

■ When using a 5BNC port

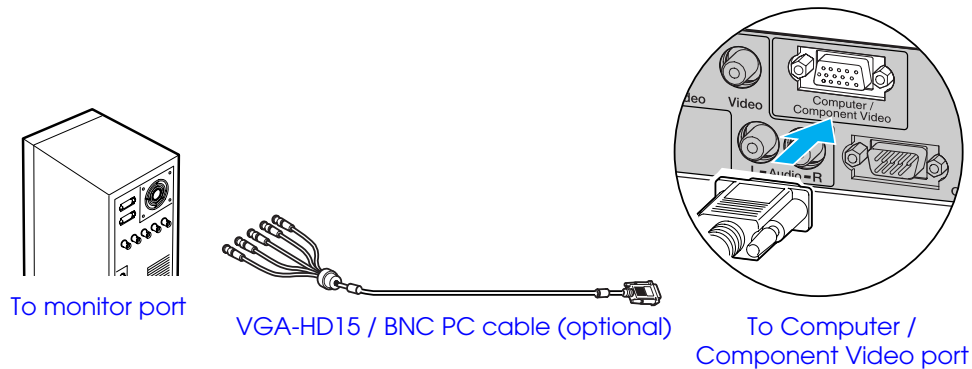

■ When using a 13w3 port

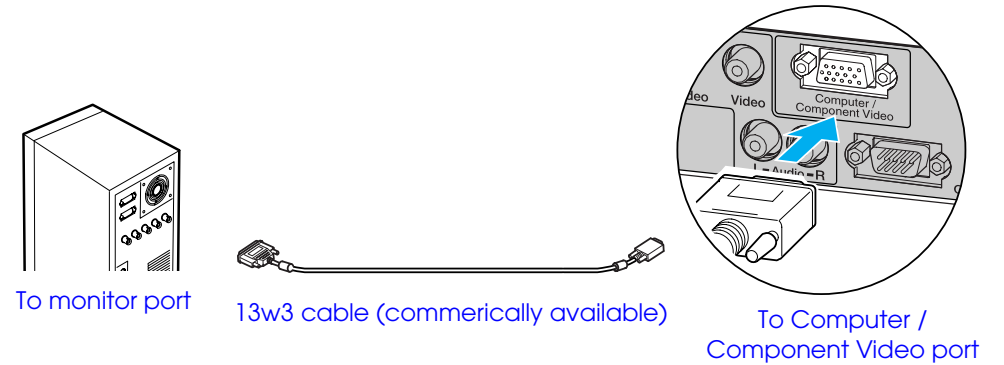

- Select "Computer" in the "Image" → "Input signal" configuration menu. "Image menu" P.35
- Do not bind the power cable and computer cables together. Interference or operational problems may result.
- A particular type of cable may be required for some workstations. Please check with the maker of your workstation.

Playing sound from a computer

You can play sound from a computer through the projector's in-built speaker.

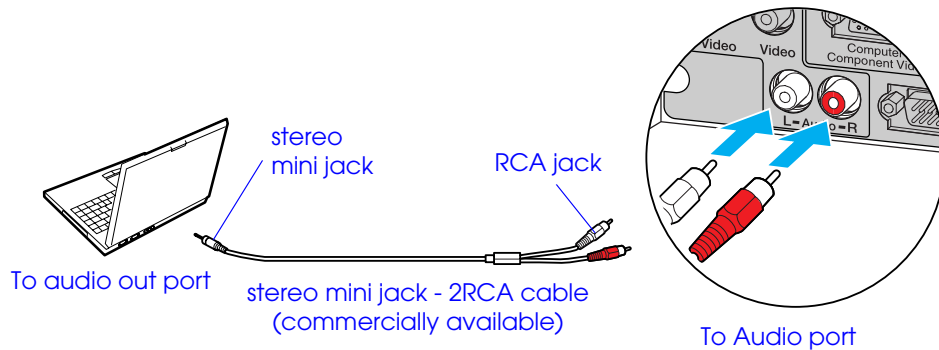

Connecting to an external monitor

The image being input into the projector can be displayed on a computer monitor.

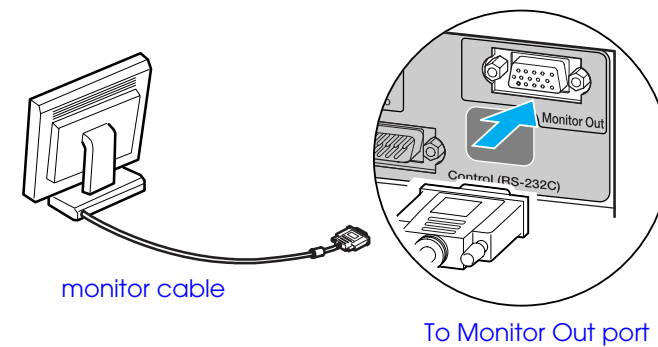

- *When using computer and video equipment alternately, swap the cable or use an audio switch.*
- *If using a commercially-available 2RCA (L/ R) / stereo mini-jack audio cable, use one that is marked as "No resistance".*

- *Video images cannot be output to an external monitor.*
- *Setting gauges (for keystone correction, etc.) and configuration menus will not be displayed on an external monitor.*

■ Volume adjustment

Press [↵] or [⏪] on the remote control.

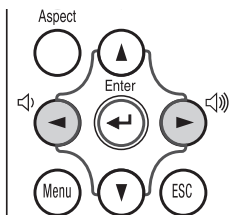

You can also adjust the volume from the configuration menu.
 [Menu] button → "Setting" → "Volume" ➡ "Setting menu" P.38

Presentation Remote Controller

You can use the Presentation Remote Controller as a wireless mouse to control the mouse pointer on the computer screen.



Before using the Presentation Remote Controller, remove the insulation tape.

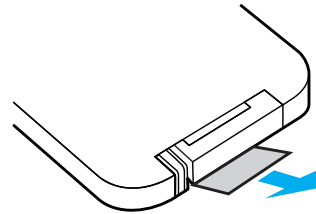

Compatible computers

Windows: Windows 98 / 2000 / Me / XP
(Only compatible with the full versions of Windows.
Upgraded versions cannot be used.)

Macintosh: Mac OS 9.1 or later



- *The Presentation Remote Receiver can only be connected to computers with a standard USB interface.*
- *Some computer settings may have to be changed in order for the mouse function to be used. Refer to your computer's documentation for further details.*

Installing the driver (Windows)

Screen contents will differ according to the version of Windows you are using. This explanation uses screenshots taken from Windows 98. Driver installation is not required for the Macintosh.

- 1 **Connect the accessory Presentation Remote Receiver to the USB port of the computer.**

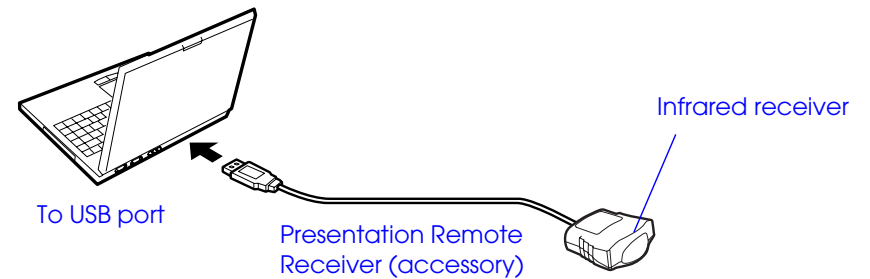

The "Add New Hardware" wizard is displayed. Under normal circumstances, maintain the default settings and click "Next" to proceed.

- 2 **Click "Next".**



3 Keeping the defaults, click "Next".



5 Click on "Next" to confirm the message which is displayed.



4 Click the check box next to "Specify a location" and type "C:\WINDOWS". Click "Next"



6 Click on "Finish".



The installation of the driver is complete.

-  • You may need to enter a different location to search for the OS files that you are using.
- Click on "Browse" if you want to change the default search location.

-  • The driver installation screen is displayed a second time. (The Presentation Remote Controller driver has two parts; the mouse driver and the keyboard driver.) Follow the on screen instructions to complete the installation.

■ Part Names and Functions

Operate the Presentation Remote Controller by aiming it at the Presentation Remote Receiver.

When using the Freeze or A/V Mute functions, aim the presentation remote control towards the remote control infrared receiver of the projector.

- **[Page Up] / [Page Down] buttons**

Press these buttons to scroll back and forth through pages when projecting a PowerPoint presentation.

- **[L Click] button**

Acts as a mouse left-click.

- **Double click:**

Push the [L Click] button twice.

- **Drag and drop:**

To drag, press and hold the [L Click] button and move the cursor with the joystick.

The item will be dropped when [L Click] is released.

- **[A/V Mute] button**

Momentarily turns off the audio and video.

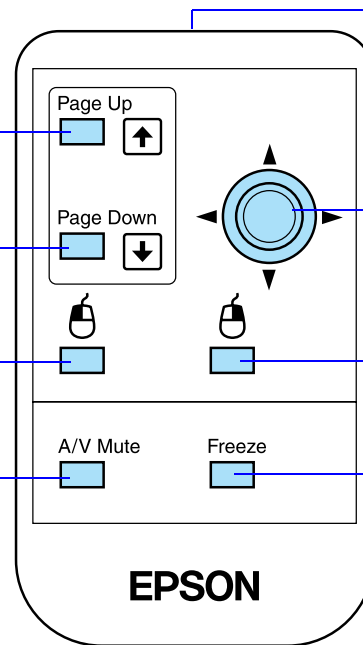

- **remote control infrared transmitter**

Transmits remote control signals.

- **joystick**

To move the mouse pointer, move the joystick in any of the following directions : up, down, left, right, diagonally.

- **[R Click] button**

Acts as a mouse right-click.

- **[Freeze] button**

Keeps the current computer or video image on the screen.

■ Operating range

Operable distance: Max. approx. 6m (20ft.)

(May be shorter depending on conditions.)

Operable angle: approx. 30° horizontally, 15° vertically

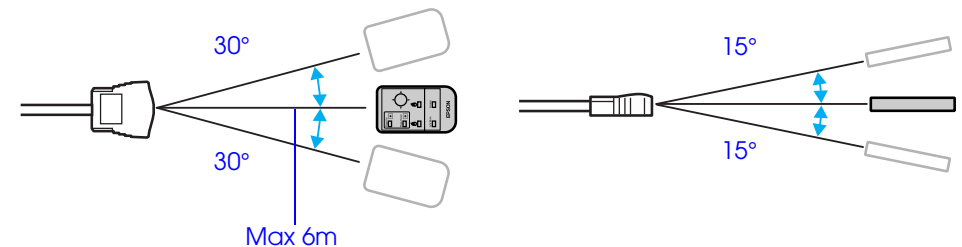

If the mouse button settings have been reversed at the computer, the operation of the remote control buttons will also be reversed.



When connecting, be sure to:

- **Turn off the power for both the projector and the video equipment.**
Damage may result if you try to make a connection when the power is switched on.
- **Check the connector types.**
Damage may result if you attempt to insert a connector into the incorrect port.

Projecting video images

■ For Composite Video (DVD, VHS, Video games)

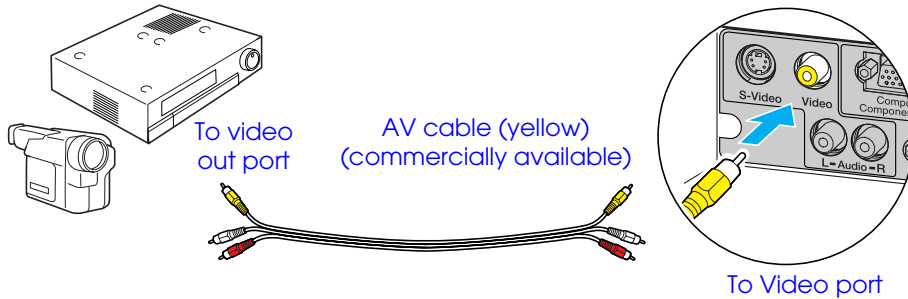

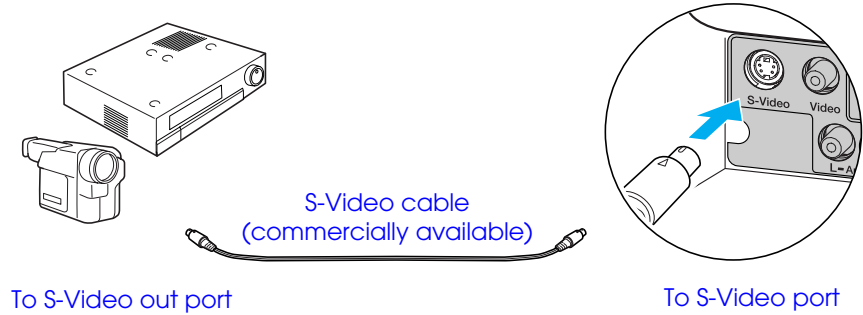

■ For S-Video (DVD, S-VHS, Video games)

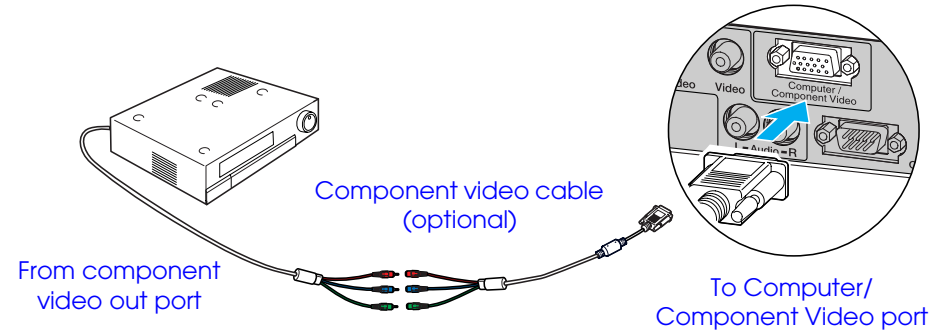

■ For Component Video (DVD, Video games)



 After projection starts, change the "Input Signal" setting in the "Image" menu to either "Component Video (YCbCr)" or "Component Video (YPbPr)" to match the signals from the video equipment.  P.35

■ For RGB Video

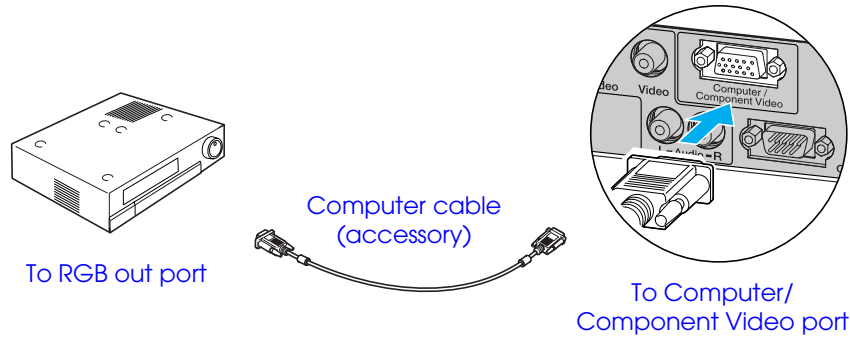

Playing sound from video equipment

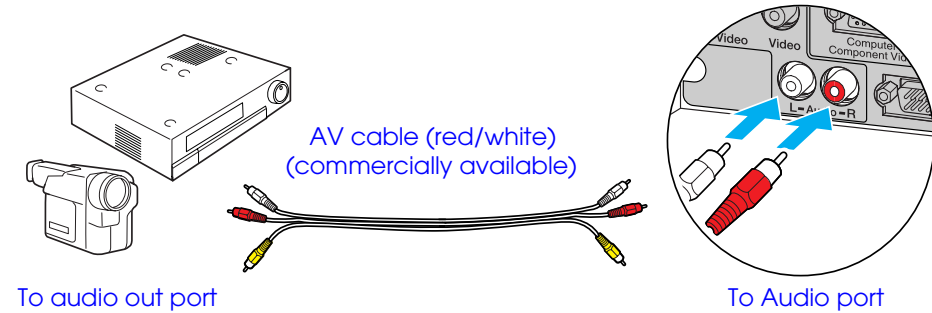

- After projection starts, change the "Input Signal" setting in the "Image" menu to "Computer". P.35
- For an RGB connection, a commercially available adapter or converter cable may be required.

- When using computer and video equipment alternately, swap the cable or use an audio switch.
- If using a commercially-available 2RCA (L/ R) / stereo mini-jack audio cable, use one that is marked as "No resistance".

■ Volume adjustment

Press [] or [] on the remote control.

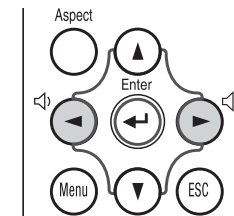

You can also adjust the volume with the configuration menu.
 [Menu] button → "Setting" → "Volume" "Setting menu" P.38

Turning on the Projector

! Turn off the power of the projector and the equipment you are connecting to.

1 Connect the computer/video.

☞ "Connecting to a Computer" P.12 , "Connecting to Video Equipment" P.18

2 Remove the lens cover.

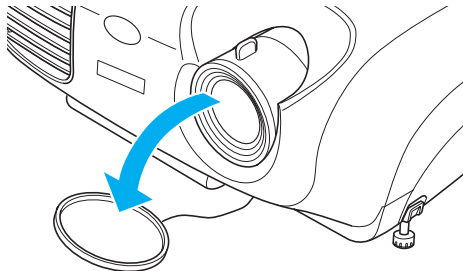

3 Attach the power cable to the projector.

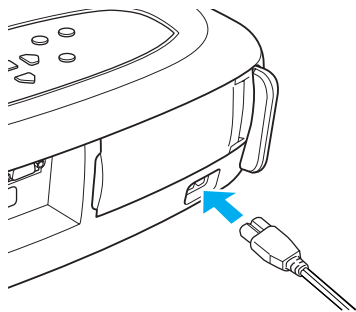

4 Insert the power plug into a wall socket.

The power indicator lights orange.

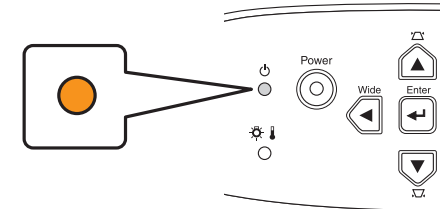

5 Turn on the power of the computer/video.

If connected to a video source, start playback.

☞ *When using a laptop or a PC with an in-built monitor, select external video output on the computer.* ☞ P.12



6 Press the [Power] button.

The projector beeps and the power supply indicator begins to blink green.

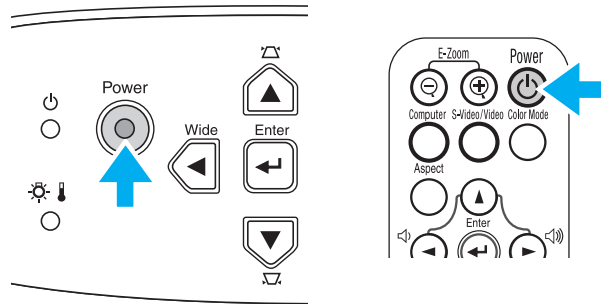
**7 Wait until the power indicator lights green.**

It takes about 40 seconds.

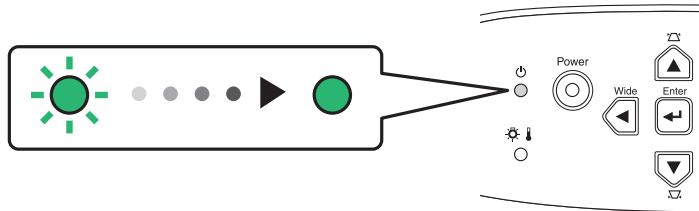

- 1 Turn off the power to the computer/video equipment.
- 2 Press the [Power] button.

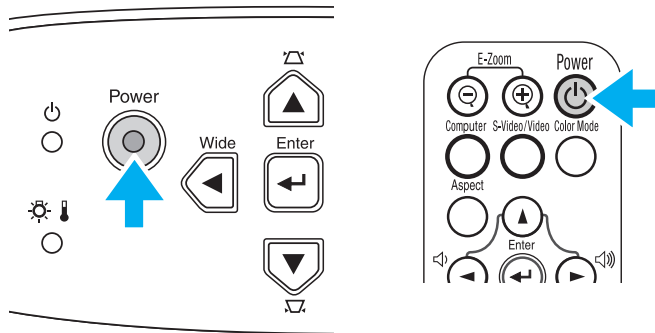

A confirmation screen is displayed.

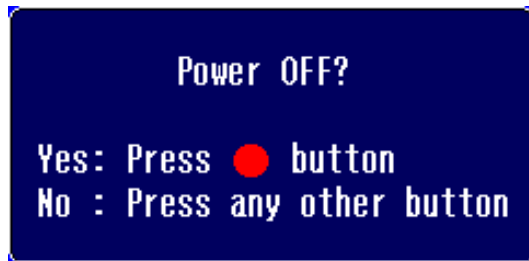

 *The confirmation screen disappears if anything other than the [Power] button is pressed, or if nothing is pressed for 7 seconds.*

- 3 Press the [Power] button again.
The power indicator begins to blink.

- 4 Wait until the power indicator lights orange and the projector beeps twice.
[Cool-down](#) takes place. It takes about 20 seconds.

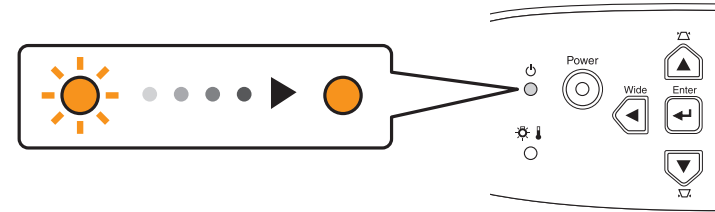

- 5 Unplug the projector from the outlet.

 ***Do not remove the plug while the power indicator is blinking, or this may damage the projector.***

- 6 Unplug the power cable at the projector.
- 7 Replace the lens cover.

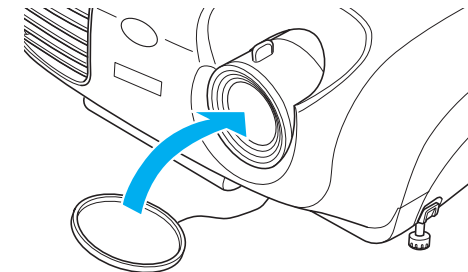

Adjusting the projection size

The size of the projected image is basically determined by the distance from the projector to the screen.  "Projection distance and screen size" P.10



- 1 Press the [Wide] or [Tele] buttons on the control panel to adjust the projection size.

[Wide] : increase the size

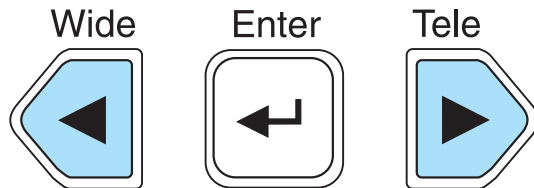
[Tele] : reduces the size





If you would like to enlarge the image further, move the projector further away from the screen.

-  • The default setting is wide.
- The E-Zoom function lets you enlarge parts of the image.  "E-Zoom" P.30

Setting the focus

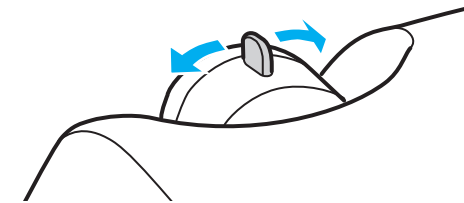
- 1 Turn the focus ring to adjust the image focus.



-  • If the surface of the lens is dirty, or misted over as a result of condensation, it may not be possible to adjust the focus correctly. If this happens, clean or de-mist the lens.  "Cleaning the lens" P.54
- If the projector is positioned outside the normal projecting range of 87-1109 cm (2.9-36.4 ft.), it may not be possible to obtain the correct focus. If you have trouble obtaining the correct focus, check the projection distance.

Adjusting the projection angle

Set up the projector so that it is at right angles to a screen.

Seen from the side

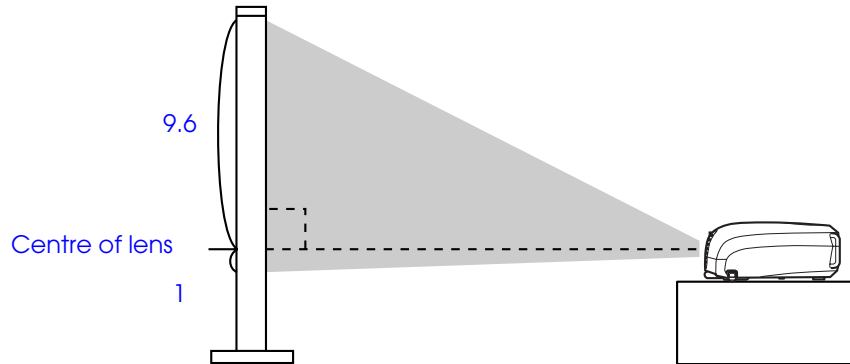

Seen from above

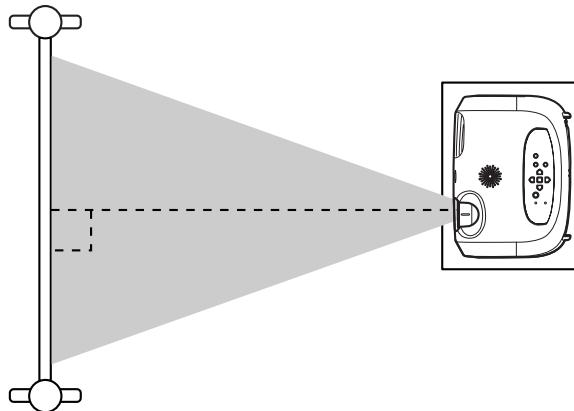

If it is not possible to set up the projector so that it is at right angles to a screen, it can be set up at a slight vertical angle instead. (Max 10°)

- 1 **Raise the front of the projector while pressing the feet buttons on both sides.**

Extend the front feet.

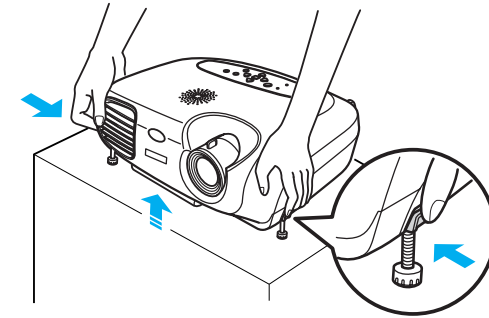

- *The height can be adjusted by turning the base of the front feet on either side.*

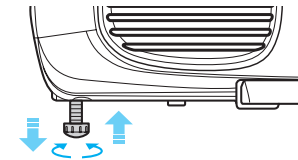



- *Press the front feet buttons on both sides and slowly lower the projector down to return to its normal position.*



Keystone

When the projector is not set at right angles to a screen, the display distorts in the shape of a trapezoid. This distortion can be corrected.

 **You can correct only vertical distortion with this function. Horizontal distortion cannot be corrected.**

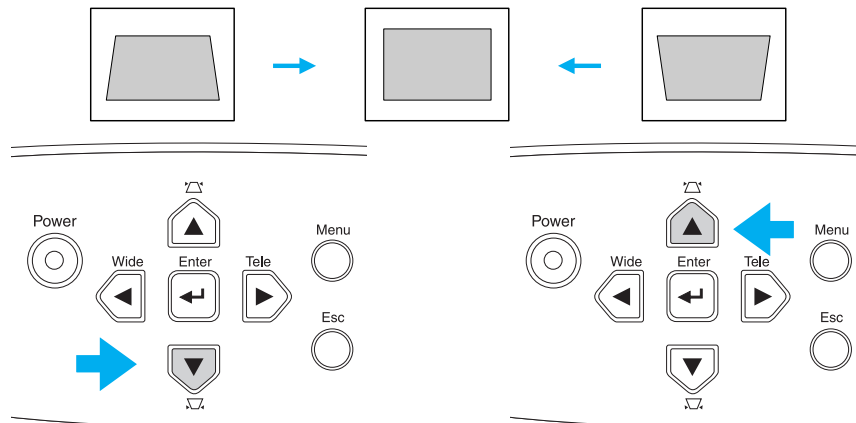
1 Press the [] or [] buttons.



-  • Screen size changes when keystone correction is performed.
- If the images become uneven in appearance after keystone correction is performed, decrease the sharpness setting. ([Menu] button → "Image" → "Picture Quality" → "Sharpness")  "Image menu" P.35

Images can be corrected without distortion when the projector is tilted to a maximum of $\pm 15^\circ$.

Approx. 15° above

Approx. 15° below

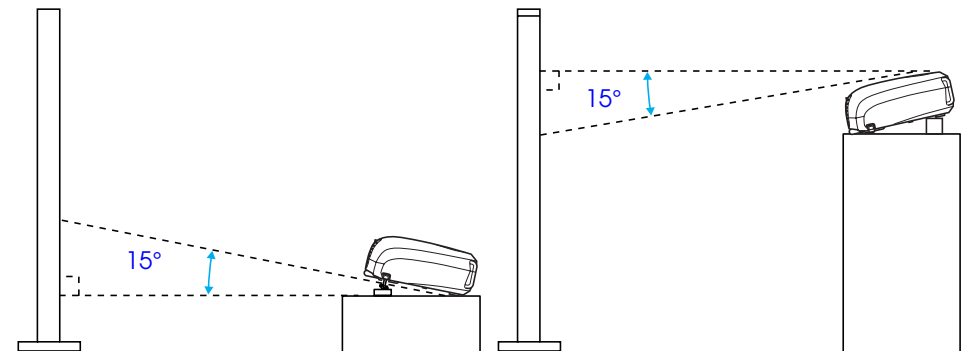

Selecting the Input Source

When a device is connected, projection commences automatically without having to select the input source, however when connected to two or more devices, select desired the input source.

Projector

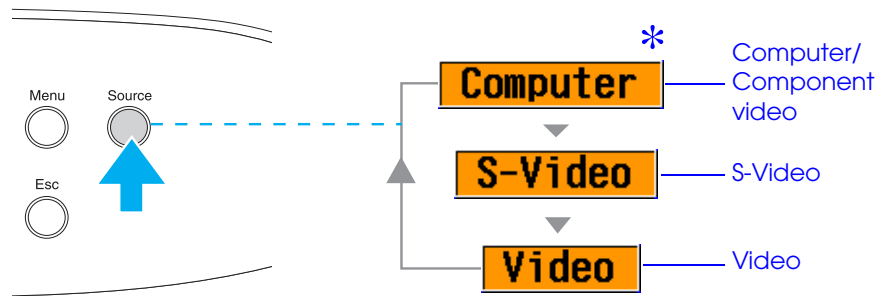

The input source changes each time [Source] is pressed.

* The items selected using the "Input signal" command in the "Image" menu are displayed. 🖱️ "Image menu" P.35

- Computer
- Component Video (YCbCr)
- Component Video (YPbPr)

Remote control

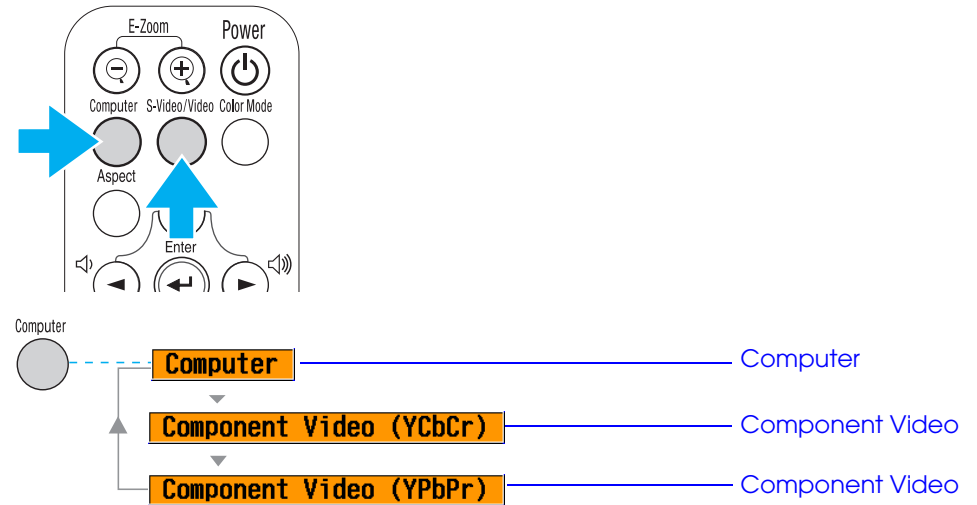

The input source switches between Computer and Component video whenever the [Computer] button is pressed, as shown above.

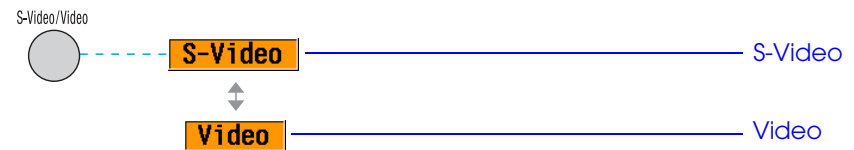

The input source switches between S-Video and Video whenever the [S-Video/Video] button is pressed, as shown above.

 ***If two or more sources are connected, be sure to swap the audio cables between the connected equipment, when necessary.***



Functions for Enhancing Projection

Adjusting computer generated images

■ Auto setup (Computer connections)

The computer signal is analysed and the following settings are adjusted to ensure the optimum image quality.

- [Tracking](#)»
- Position
- [Sync](#)»

 You can set Auto setup to off in the "Image" → "Auto Setup" configuration menu. (The default is ON)  "Image menu" P.35

When Auto setup is set to off, press the [Auto] button on the remote control to perform auto setup.

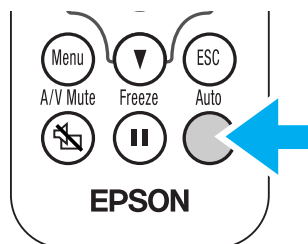

 If you press the [Auto] button during E-Zoom or Freeze operation, or when a configuration menu is being displayed, the display will be halted and auto setup will take place.

Adjust the Tracking and Sync settings manually if Auto setup cannot be performed. ([Menu] button → "Image" → "Picture Quality" → "Tracking", "Sync.")  "Image menu" P.35

Selecting a colour mode

There are five present colour modes available for use. Make a selection appropriate to the conditions in which you are projecting.

- **Dynamic**
Images are modulated and made fresher to emphasize brightness.
- **Presentation**
Brightness is emphasized. For presentations in bright rooms.
- **Theatre**
Best for watching movies in their natural tones.
- **Living Room**
Brightness is emphasized. Ideal for playing video games in bright rooms.
- **sRGB**»
Conforms to the sRGB colour standard. If the connected source has an sRGB mode, set both the projector and the connected source to sRGB.



The colour mode changes each time you press the [Color Mode] button on the remote control.

Dynamic → Presentation → Theatre → Living Room → sRGB

Default Value

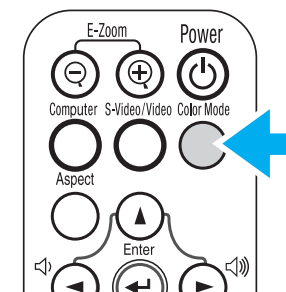
- Computer input : Presentation
- Other input: Dynamic



 You can set the colour mode in the "Image" → "Color Mode" configuration menu.  "Image menu" P.35

A/V Mute

Temporarily stops the image and sound.

- 1 Press the [A/V Mute] button on the remote control.

The sound and image disappear.

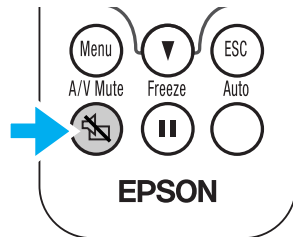

Projection is resumed when you press the [A/V Mute] button again or press the [Esc] button.



- *The screen colour during A/V Mute can be set to black or blue. The default setting is blue. ([Menu] button → "Setting" → "Display" → "Background Color")*  *"Setting menu" P.38*
- *When activated while projecting moving images, the sound and image will continue to be played back by the source, so it will not be possible to return to the point where A/V Mute was activated.*

Freeze

Pauses the projected images.

- 1 Press the [Freeze] button on the remote control.

The projected image freezes.

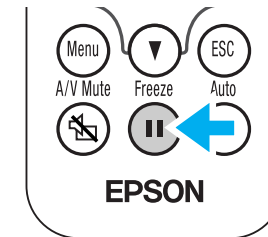

To cancel, press the [Freeze] button again, or press the [Esc] button.



- *During Freeze, moving images will continue to be played back by the source, so it will not be possible to return to the point where Freeze was activated.*
- *Pressing the [Freeze] button also clears configuration menus.*

Projecting in widescreen (changing aspect ratio)

This function changes the [Aspect ratio](#) of images from 4:3 to 16:9 when component video images (YCbCr and YPbPr) or video images (S-Video or composite video) are being projected. Images which have been recorded in digital video or onto DVDs can be viewed in 16:9 wide-screen format.

- 1 Press the [Aspect] button on the remote control to change the screen size as follows:

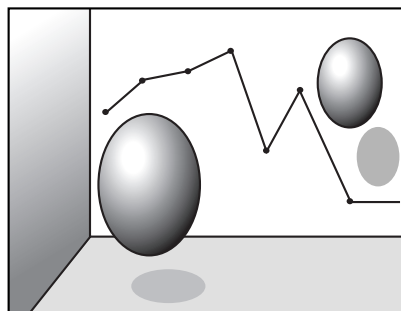
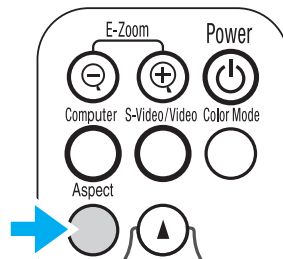

When images in [Squeeze mode](#) are projected at 4:3

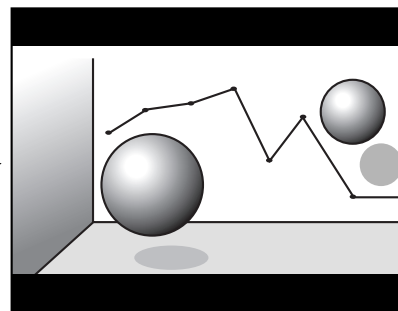

When images in Squeeze mode are projected at 16:9

E-Zoom

The image is enlarged or reduced.

- 1 Press the [E-Zoom \oplus] button on the remote control.

A target scope is displayed on the screen.

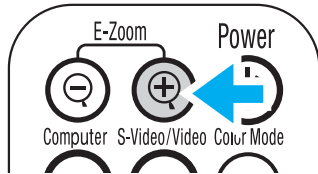

- 2 Press the [\blacktriangle][\blacktriangledown][\blacktriangleleft][\blacktriangleright] buttons to move the target scope to the centre of the part you wish to enlarge/reduce.

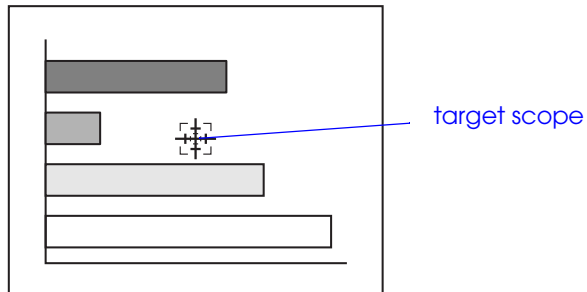

- 3 Press [E-Zoom \oplus] to enlarge the image. Press [E-Zoom \ominus] to reduce the enlarged image.

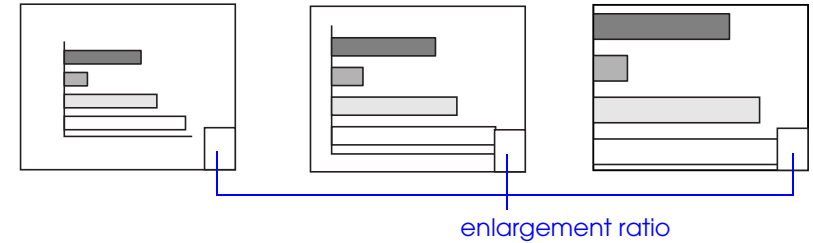

[E-Zoom \oplus]: Enlarges part of the image without changing the size of the projection area.

[E-Zoom \ominus]: Reduces the part of the image that has been enlarged using the [\oplus] button.

You can scroll with the [\blacktriangle][\blacktriangledown][\blacktriangleleft][\blacktriangleright] buttons.

Press [Esc] to cancel.

Various adjustments and settings can be made within the configuration menus.

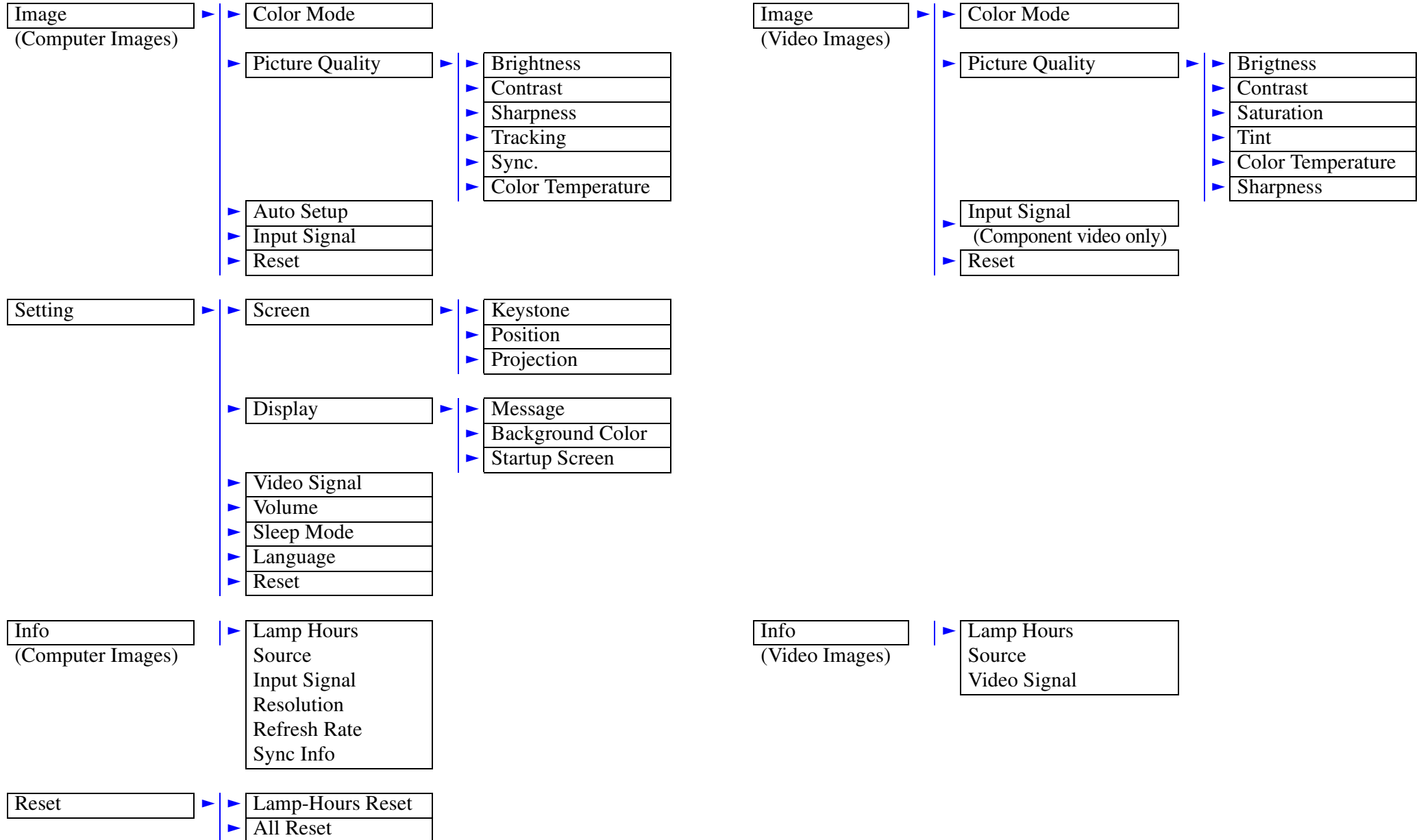

Menu operation

1 Press the [Menu] button

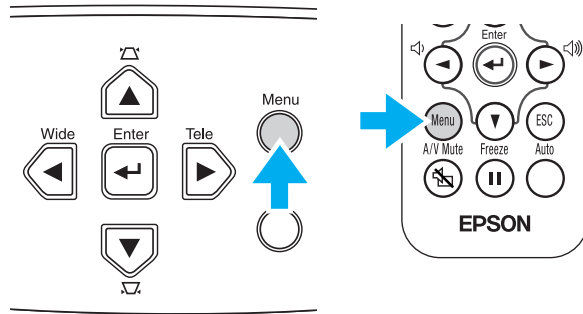

The top configuration menu is displayed.

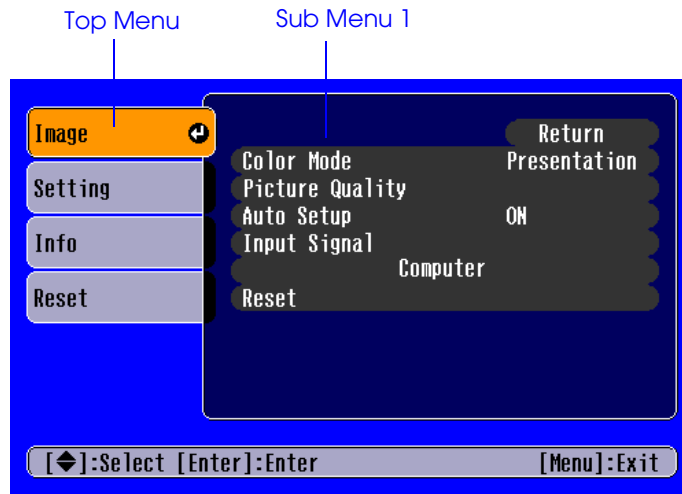

2 Press the [▲] or [▼] buttons to select the Top Menu item.

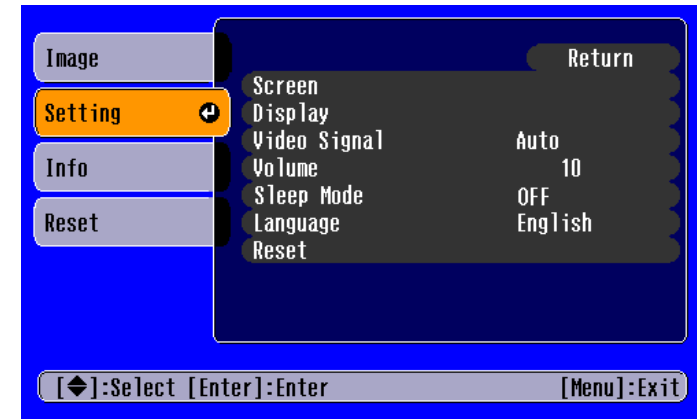
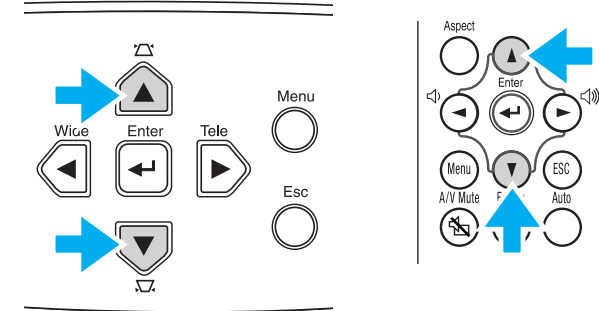

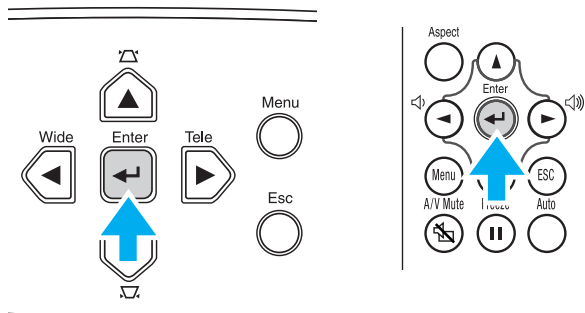
3 Press the [←] button.

Sub Menu 1 is displayed.

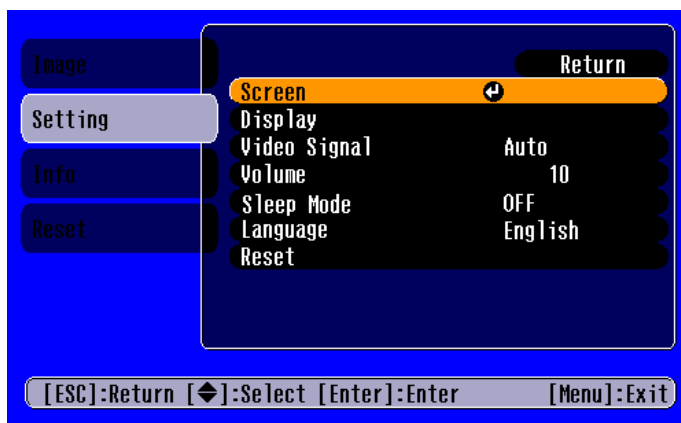
**4** Press the [▲] or [▼] buttons to select the Sub Menu 1 items, then press the [←] button.**5** For Sub Menu 2, press the [▲] or [▼] buttons in the same way, then press the [←] button.**6** Settings can be changed in the following ways:

(a) Press the [◀] or [▶] buttons to change the setting values.

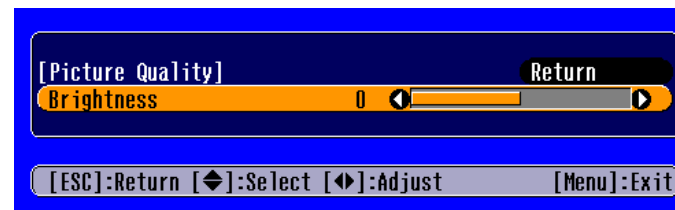



(b) Press the [▲] or [▼] buttons to select the menu item. Then press the [←] button.



 (Green): Item currently set.

 (Orange): Item currently selected.

Press the [←] button to confirm the selection.

 The  mark is displayed after items which perform a setting or lead to a sub menu.



- (c) Press the [◀] or [▶] buttons to select the value.
Then, press the [↵] button.

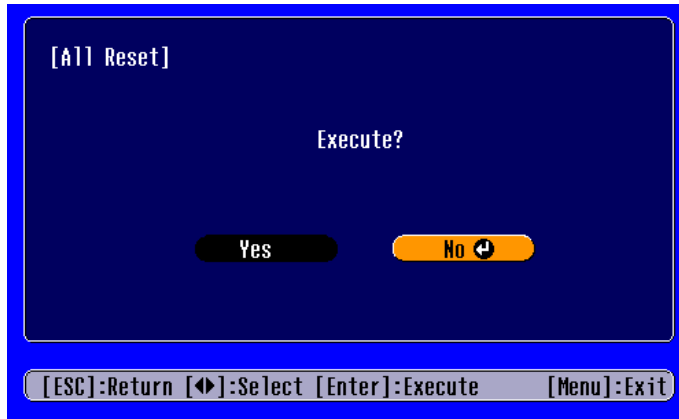

- (d) Press the [▲] [▼] [◀] [▶] buttons to move the image display position.

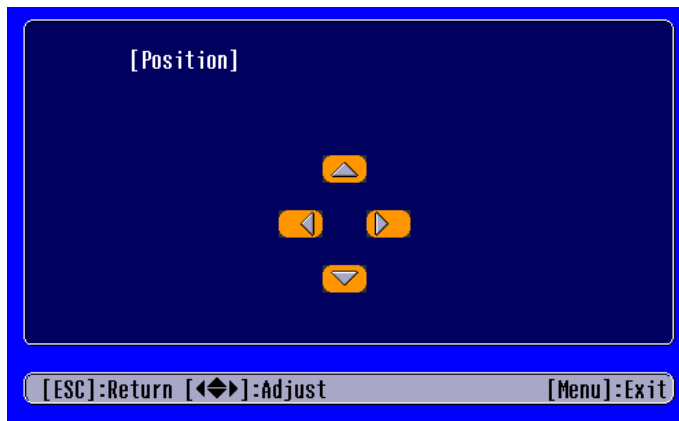

7 Set other items in the same way.

Press the [Esc] button to return to the previous item or menu, or select "Return".

8 Press the [Menu] button to finish.

Function list

■ Image menu

- When no signal is being input, only the settings for "Auto Setup" and "Input Signal" can be adjusted.
- The functions in the "Image" Menu will be different according to the type of signal which is being input.

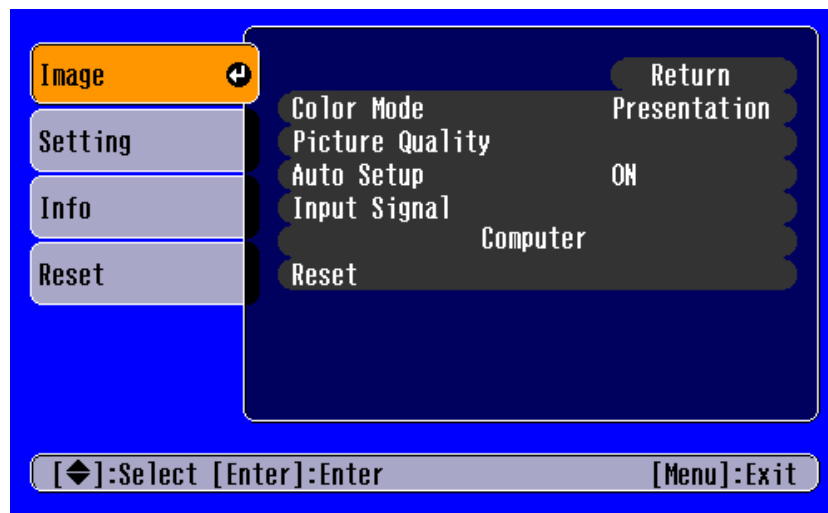

Computer images

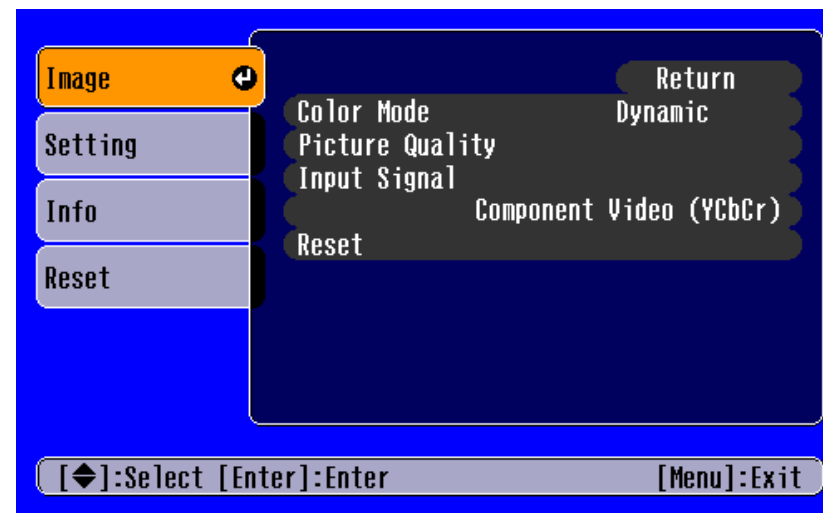

Video images

"Input Signal" only appears on menu screens when component video images are being projected.



Sub menu		Function
Color Mode		<p>Corrects the vividness of the image colour. The settings can be saved separately for each type of source (computer or video). Select from 5 different quality settings depending on the type of scene.</p> <ul style="list-style-type: none"> • Dynamic: Images are modulated and made fresher to emphasize brightness. • Presentation: Brightness is emphasized. For presentations in bright rooms. • Theatre: Best for watching movies in their natural tones. • Living Room: Brightness is emphasized. Ideal for playing video games in bright rooms. • sRGB▶▶: Conforms to the sRGB colour standard. If the connected source has an sRGB mode, set both the projector and connected source to sRGB.
Picture Quality	Brightness	Adjusts the brightness of the image.
	Contrast ▶▶	Adjusts the contrast of the image.
	Sharpness	Adjusts the sharpness of the image.
	Tracking ▶▶ (Computer images only)	Adjusts the image when vertical stripes appear in the image.



Sub menu		Function
Picture Quality	Sync.▶ (Computer images only)	Adjusts the image when flickering, fuzziness or interference occur in the image. Flickering and fuzziness may also occur when the brightness, contrast, sharpness or keystone correction settings are adjusted. Best results can be obtained by adjusting the tracking before the sync.
	Color Temperature▶	Adjusts bright colours from a reddish tinge to a bluish tinge. Lower colour temperature settings produce redder colours and softer colour tones. Higher colour temperature settings produce bluer colours and sharper colour tones. Press the [←] button and make a setting from the colour adjustment menu which is displayed.
	Saturation (Video images only)	Adjusts the colour depth
	Tint (Video images only)	(Adjustment is only possible when Component Video▶ or NTSC signals are being input) Adjusts the tint of the image.
Auto Setup (Computer images only)	ON: When the input source is switched to a computer signal, the projector automatically adjusts the image to its optimal state. OFF: Auto Setup is disabled.	
Input Signal (Computer/component video images only)	Select the type of image signal connected to the Computer/Component Video port. <ul style="list-style-type: none"> • Computer: computer images • Component Video (YCbCr): DVD images • Component Video (YPbPr): HDTV images 	
Reset	Resets all the adjustment values within the "Image" menu (except for "Input Signal") to their default settings. <ul style="list-style-type: none"> • Press the [←] button and select "Yes" on the confirmation screen which is displayed. • Select "All Reset" to restore all menu settings, such as image and sound, to their default settings.  "Reset menu" P.42	

■ Setting menu

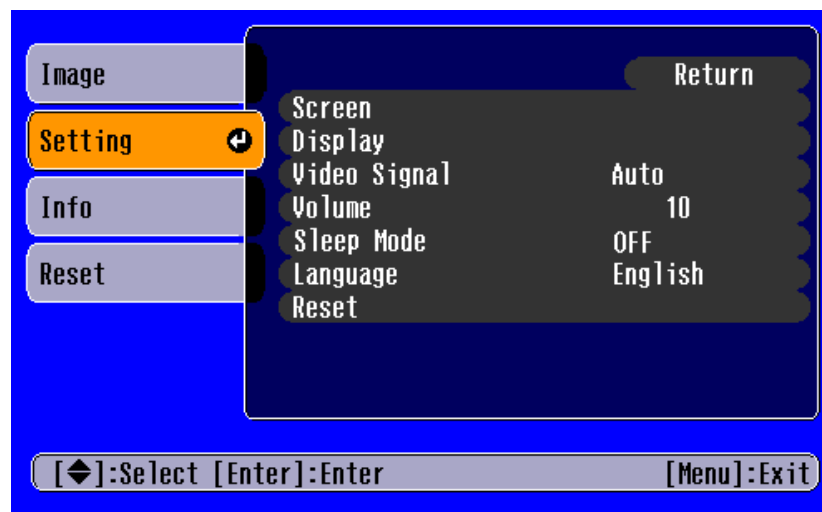

Sub menu		Function
Screen	Keystone	<p>Corrects vertical keystone distortion in the image.</p> <ul style="list-style-type: none"> • The projected image changes when keystone correction is carried out. • If the images become uneven in appearance after keystone correction has been carried out, decrease the sharpness setting.
	Position	<p>Moves the image display position vertically and horizontally.</p> <ul style="list-style-type: none"> • Press the [←] button and adjust the display area on the Position adjustment screen which is displayed.
	Projection	<ul style="list-style-type: none"> • Front Image is displayed, as is. No vertical/horizontal reversal performed. • Front/Ceiling The image is displayed vertically reversed. • Rear The image is displayed horizontally reversed. • Rear/Ceiling The image is displayed vertically and horizontally reversed.



Sub menu		Function
Display	Message	When set to "OFF", messages such as "No signal", and the name of the selected input source or colour mode will no longer be displayed. Warning messages such as "Replace the lamp" will continue to be displayed.
	Background Color	Sets the background colour to black or blue.
	Startup Screen	Sets whether or not the "EPSON" logo will be displayed during projector startup.
Video Signal		Selects the colour system of the video signal being input. (Changes in signal format will only be noticeable when the input source is Video/S-Video.)
Volume		Adjusts the volume setting
Sleep Mode		Sets the energy saving option for when no signal is being input. <ul style="list-style-type: none"> • When a Sleep Mode interval has been set, the projector will enter Sleep Mode when no operation has been carried out for the set time (5, 10 and 30 minutes). Projection will shut down and the projector enters a standby state after cooling down. (The power indicator lights orange). • Projection starts again when the [Power] button is pressed on the projector's control panel or the remote control.
Language		Selects the language in which on-screen messages are displayed. <ul style="list-style-type: none"> • Press the [←] button and select the desired language from the list which is displayed.
Reset		Resets all the adjustment values within the "Setting" menu (except for "Language") to their default settings. <ul style="list-style-type: none"> • Press the [←] button and select "Yes" on the confirmation screen which is displayed.

■ Info menu

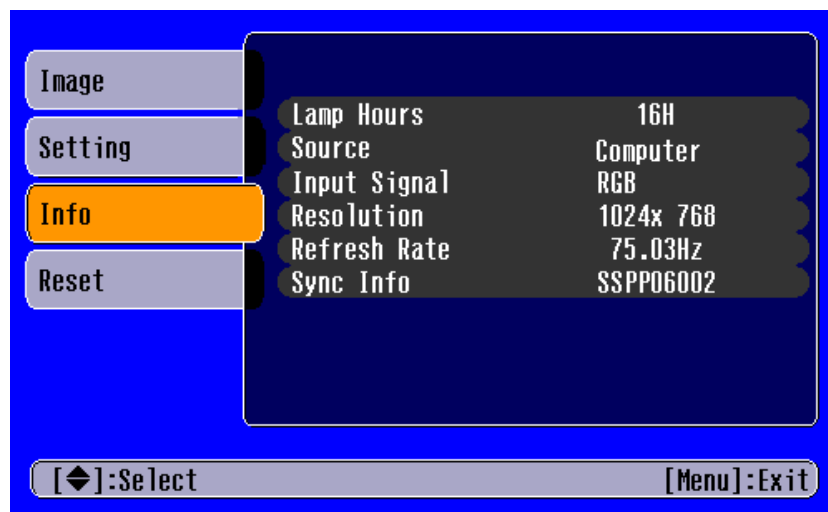

Computer images

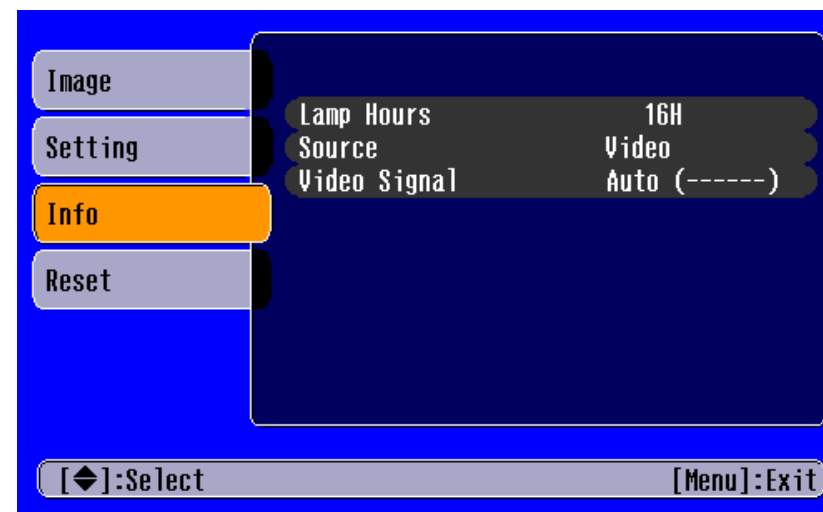

Video images

Sub menu	Function
Lamp Hours	Displays the cumulative lamp operating time. From 0 to 10 hours, 0H is displayed. After 10 hours, the usage time is displayed in hourly increments. • When the accumulated usage time of the lamp reaches about 1900hours, a warning will be displayed in red.
Source	Displays the input source being projected.
Input Signal (Computer images only)	Displays the input signal settings.
Video Signal (Video images only)	Displays the Video signal format.
Resolution (Computer images only)	Displays the input resolution. (Does not appear when the input source is composite video or S-Video.)
Refresh Rate (Computer images only)	Displays the refresh rate (Does not appear when the input source is composite video or S-Video.)

Sub menu	Function
Sync Info (Computer images only)	Displays picture signal information. In the event that you are having problems with your projector and need to contact an EPSON Service Centre, please quote the information displayed on this screen.

■ Reset menu

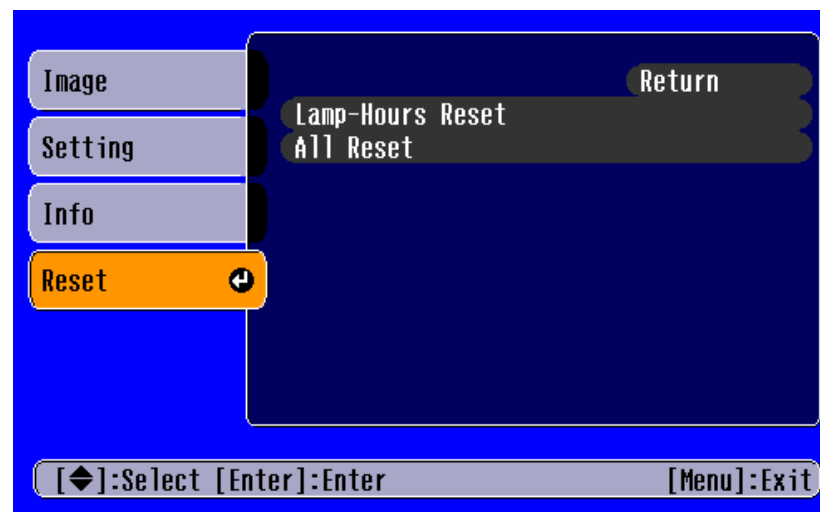

Sub menu	Function
Lamp-Hours Reset	Resets the lamp operating time. When this command is selected, the cumulative lamp operating time is reset to the default value.
All Reset	Resets all items in the configuration menus to their default settings. <ul style="list-style-type: none"> • Press the [←] button and select "Yes" on the confirmation screen which is displayed. • Select "Reset" in an individual menu to reset only the settings for the items in that sub menu. • "Input Signal", "Language" and "Lamp Hours" settings will not be reset.

When You Suspect a Problem



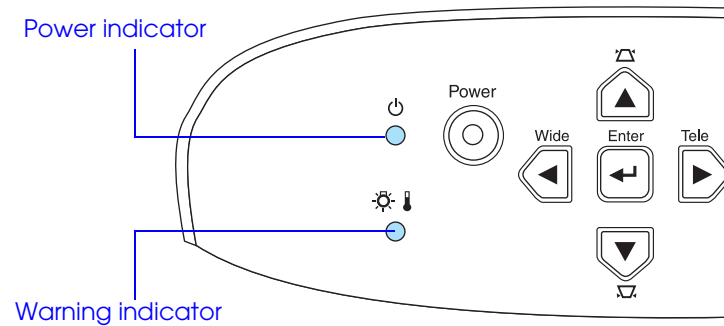

First, check the indicators on the projector.

There are two indicators on the projector unit which notify you of projector conditions.









Power indicator

- lit ● flashing
- If the indicator is not lit, the power supply is not on.

Condition	Cause/Remedy	
Orange 	Standby state (Not abnormal) The power cable should only be disconnected when the projector is in this state. Press the [Power] button to start projection.	 P.20
Orange 	Cool-down in progress (Not abnormal) <ul style="list-style-type: none"> • Please wait. The cool-down period lasts about 20 seconds. • You cannot operate the [Power] button during the cool-down period. Press the power button again after cool-down has finished. 	P.22
Green 	Projection in progress (Not abnormal)	P.20
Green 	Warming-up (Not abnormal) Please wait. Warming up takes about 40 seconds. When warming up is complete, the indicator changes to steady green.	P.20

Warning indicator

- lit  flashing
- Not lit under normal operating conditions.

Condition	Cause/Remedy	
<p>Red</p> <p></p>	<p>High internal temperature (overheating) The lamp turns off automatically and projection stops. Wait for about 5 minutes without operating the projector. After about 5 minutes have passed, unplug the power cable and check the following:</p> <ul style="list-style-type: none"> • Make sure the air filter and ventilation outlet are clear and that the projector is not positioned against a wall. • If the air filter is dirty, it should be cleaned. <p>When the power cable is plugged back in, the projector will return to its previous state. Press the [Power] button on the projector or on the remote control to turn it back on.</p>	<p>P.10 P.55</p>
<p>Red</p> <p></p> <p>(0.5 second interval)</p>	<p>Lamp problem</p> <ul style="list-style-type: none"> • Disconnect the power cable from the electrical outlet. Remove the lamp and check that it is not broken. If the lamp is not broken, re-install it. Reconnect the power cable and press the [Power] button on the projector or the remote control to turn it back on. • If the lamp is broken, please contact your dealer or the nearest address provided in the "International Warranty Conditions" in the "Safety Instructions/World-Wide Warranty Terms" guide. (You will not be able to use the projector until the lamp is replaced). • Check that the lamp and lamp cover are securely installed. If the lamp or lamp cover are not securely installed, the lamp will not switch on. 	<p>P.57</p>
<p>Red</p> <p></p> <p>(1 second interval)</p>	<p>Internal problem Stop using the projector, disconnect the power cable from the electrical outlet and contact your dealer or the nearest address provided in the "International Warranty Conditions" in the "Safety Instructions/World-Wide Warranty Terms" guide.</p>	
<p>Orange</p> <p></p>	<p>High-speed cooling in progress (This is not abnormal, but, if the temperature rises too high again, projection will stop automatically.) Set up the projector in a place which is well ventilated and ensure the air filter and ventilation outlet are clear. Clean the air filter.</p>	<p>P.10 P.55</p>



-
- 
- *If problems with projection do occur, but the indicators do not show any abnormal conditions, please refer to the section "When the indicators provide no help" on the next page.*
 - *If a condition occurs which is not listed in this table, please consult your dealer or contact the nearest address provided in the "International Warranty Conditions" in the "Safety Instructions/World-Wide Warranty Terms" guide.*
 - *If you follow the above steps and are still unable to correct the problem, please cease using the projector, unplug the projector from the electrical outlet and request repairs from your dealer or nearest address provided in the "International Warranty Conditions" in the "Safety Instructions/World-Wide Warranty Terms" guide.*
-

When the indicators provide no help

- No images appear (Nothing is displayed) [🔧 P.46](#)
- No images appear (Messages are displayed 1) [🔧 P.47](#)
- No images appear (Messages are displayed 2) [🔧 P.47](#)
- Image is out of focus (unclear) [🔧 P.48](#)
- Vertical stripes appear in the image [🔧 P.49](#)
- Image is distorted / Image contains interference [🔧 P.49](#)
- Only part of the image is displayed (large/small) [🔧 P.50](#)
- Image colours are poor, tinted green or tinted red/purple [🔧 P.51](#)
- Image is dark [🔧 P.52](#)
- No sound can be heard [🔧 P.52](#)
- The remote control does not work [🔧 P.53](#)
- The power does not turn off (after the [Power] button is pressed) [🔧 P.53](#)

■ No images appear (Nothing is displayed)

	• Was the power turned off and then straight back on again?	After the power has been switched off and the projector is in cool-down mode, the [Power] button will not work.
	• Has a Sleep Mode interval (5, 10 or 30 minutes) been set ?	When a Sleep Mode interval has been set, the lamp cuts out after no operations have been carried out for the set time (5, 10 or 30 minutes). The power indicator lights orange at this time. ([Menu] button →"Setting" →"Sleep Mode") 🔧 "Setting menu" P.38
	• Has the image brightness been adjusted correctly? ([Menu] button →"Image" → "Picture Quality" →"Brightness")	🔧 "Image menu" P.35
	• Is the projected image completely black?	Some images being displayed, including some screen savers, may be completely black.
	• Is A/V Mute activated?	🔧 "A/V Mute" P.28
	• Have you pressed the [Power] button?	🔧 "Turning on the Projector" P.20
	• Try resetting all of the current settings.	🔧 "Reset menu" P.42
	• Is an image signal being input?	Check if a picture signal is being input. Set the "Message" option to "ON" in the "Setting" →"Display" → "Message" configuration menu, in order to view the picture signal information. 🔧 "Setting menu" P.38

■ No images appear (Messages are displayed 1)

 <p>"Not supported"</p>	<ul style="list-style-type: none"> • Check the mode which corresponds to the frequency of the image signals being output from the computer. 	<p>Refer to the documentation provided with your computer for details on changing the resolution and frequency of the image signals being output from the computer. ☛ "Supported Display Resolutions" P.67</p>
--	--	--

■ No images appear (Messages are displayed 2)

 <p>"No signal"</p>	<ul style="list-style-type: none"> • Has external video output been selected on the computer? 	<p>When using a laptop or a PC with an in-built monitor, select external video output on the computer. ☛ "Laptop connection" P.12</p>
	<ul style="list-style-type: none"> • Is the input source properly selected? 	<p>Press the [Source] button on the Control panel until the correct input source is selected. For the remote control, press the [Computer] button or the [S-Video/Video] button. ☛ "Selecting the Input Source" P.26</p>
	<ul style="list-style-type: none"> • Are the cables connected properly? 	<p>☛ "Connecting to a Computer" P.12 , "Connecting to Video Equipment" P.18</p>
	<ul style="list-style-type: none"> • Is the power for the connected computer or video source switched on? 	<p>☛ "Turning on the Projector" P.20</p>

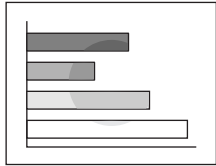

■ Image is out of focus (unclear)





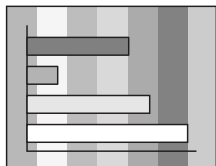

- The image is fuzzy
- Part of the image is out of focus
- The whole image is out of focus

<ul style="list-style-type: none"> • Have the "Sync.▶", "Tracking▶" and "Position" settings been adjusted correctly? 	<p>If the configuration menu "Image" →"Auto Setup" setting has been set to "OFF", press the [Auto] button on the remote control to adjust these settings. If the images have not been correctly adjusted after pressing the [Auto] button and using the auto setup function, adjust the settings manually in their respective menus. ([Menu] button →"Image" →"Picture Quality" →"Tracking", "Image" →"Picture Quality" →"Sync.", "Setting" →"Screen" →"Position") ▶ "Image menu" P.35 , ▶ "Setting menu" P.38</p>
<ul style="list-style-type: none"> • Are the image signal format settings correct? 	<ul style="list-style-type: none"> • When a computer or ▶ Component Video▶ equipment is connected, select the appropriate setting for the input source you are using, in the "Image" →"Input Signal" configuration menu. • When ▶ Composite Video▶ or ▶ S-Video▶ equipment is connected, select the appropriate setting for the video system you are using in the "Setting" →"Video Signal." configuration menu.
<ul style="list-style-type: none"> • Is the projector positioned at right angles to the screen? 	<p>▶ "Installation method" P.10</p>
<ul style="list-style-type: none"> • Is the projector at the correct distance from the screen? 	<p>The optimum range for projection is 87-1109cm (2.9-36.4ft.). Set the projector within this range. ▶ "Installation method" P.10</p>
<ul style="list-style-type: none"> • Are the front feet set so that the image angle is too big for the screen? 	<p>If the image angle is too big the image will be out of focus vertically. ▶ "Adjusting the projection angle" P.24</p>
<ul style="list-style-type: none"> • Is the lens dirty? 	<p>▶ "Cleaning the lens" P.54</p>
<ul style="list-style-type: none"> • Has condensation formed on the lens? 	<p>If the projector is suddenly taken from a cold environment to a warm environment, condensation may form on the surface of the lens, and this may cause the images to appear fuzzy. Set the projector up in the room in which it is to be used approximately one hour before use. If condensation forms on the lens, turn off the power and wait for the condensation to disappear.</p>
<ul style="list-style-type: none"> • Has the focus been correctly adjusted? 	<p>▶ "Adjusting the Display" P.23</p>
<ul style="list-style-type: none"> • Is the lens cover still in place? 	<p>▶ "Turning on the Projector" P.20</p>

■ Vertical stripes appear in the image

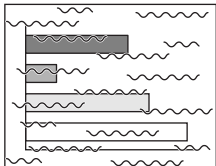
	<ul style="list-style-type: none"> Has the "Tracking▶" setting been adjusted? 	<p>Set the tracking value until the vertical stripes disappear. ([Menu] button "Image" →"Picture Quality" →"Tracking")  "Image menu" P.35</p>
---	--	--

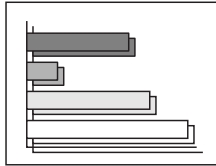
■ Image is distorted / Image contains interference

	<ul style="list-style-type: none"> Have the "Sync.▶", "Tracking▶" and "Position" settings been adjusted correctly? 	<p>If the configuration menu "Image" →"Auto Setup" setting has been set to "OFF", press the [Auto] button on the remote control to adjust these settings. If the images have not been correctly adjusted after pressing the [Auto] button and using the automatic setup function, adjust the settings manually in their respective menus. ([Menu] button →"Image" →"Picture Quality" →"Sync.")  "Image menu" P.35</p>
	<ul style="list-style-type: none"> Are the image signal format settings correct? 	<ul style="list-style-type: none"> When a computer or Component Video▶ equipment is connected, select the appropriate setting for the input source you are using, in the "Image" →"Input Signal" configuration menu. When Composite Video▶ or S-Video▶ equipment is connected, select the appropriate setting for the video system you are using in the "Setting" →"Video Signal." configuration menu.
	<ul style="list-style-type: none"> Has the correct resolution been selected? 	<p>Set the computer so that the signals that are output are compatible with this projector. Refer to your computer's documentation for further details.  "Supported Display Resolutions" P.67</p>
	<ul style="list-style-type: none"> Is an extension cable being used? 	<p>If using an extension cable, electrical interference may affect the signals. Confirm that you are using a shielded cable.</p>
	<ul style="list-style-type: none"> Are the cables connected correctly? 	<p> "Connecting to a Computer" P.12, "Connecting to Video Equipment" P.18</p>

■ Only part of the image is displayed (large/small)

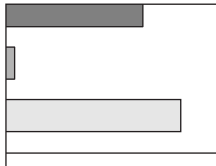
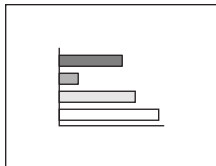
	<ul style="list-style-type: none"> • Change the resolution for the laptop computer or computer with a LCD screen. 	<p>Change the resolution so that the image is displayed in the whole of the projection area, or set the image signal to external output only.</p> <p>☛ "Selecting the Input Source" P.26</p>
	<ul style="list-style-type: none"> • Is the aspect ratio set correctly? 	<p>Press the [Aspect] button to set the aspect ratio to 4:3. ☛ "Projecting in widescreen (changing aspect ratio)" P.29</p>
	<ul style="list-style-type: none"> • Has the computer been set for dual display? 	<p>If dual display has been activated in the Display Properties of the connected computer's Control Panel, the projector will only display about half of the image on the computer screen. To display the whole of the image on the computer screen, turn off the dual display setting. Refer to the video driver manual for the computer's monitor for further details.</p>
	<ul style="list-style-type: none"> • Has the correct resolution been selected? 	<p>Set the computer so that the signals that are output are compatible with this projector. Please refer to your computer's documentation for further details. ☛ "Supported Display Resolutions" P.67</p>
	<ul style="list-style-type: none"> • Has the "Position" been adjusted correctly? 	<p>Use the "Setting" →"Screen" →"Position" configuration menu to correctly adjust the display position. ☛ "Setting menu" P.38</p>
	<ul style="list-style-type: none"> • Is the E-Zoom function being used to enlarge the image? 	<p>Press the [Esc] button on the remote control to cancel E-Zoom. ☛ "E-Zoom" P.30</p>

■ Image colours are poor, tinted green or tinted red/purple



<ul style="list-style-type: none"> • Are the image signal format settings correct? 	<p>If a component video device is connected and "Computer" is set as the "Image" →"Input Signal" configuration menu setting, the projected images will appear greenish. If a computer is connected and either "Component Video (YPbPr)" or "Component Video (YCbCr)" is set as the "Image" →"Input Signal" configuration menu setting, the projected images will appear red/purplish. Please select the appropriate setting for the equipment you are using. ([Menu] button →"Image" →"Input Signal")</p> <p>☛ "Image menu" P.35</p>
<ul style="list-style-type: none"> • Does the lamp need replacement? 	<p>When the lamp is due for replacement, colours will weaken and the image will become dark. Replace the lamp when this is the case. ☛ "Lamp replacement period" P.57</p>
<ul style="list-style-type: none"> • Has the image contrast been adjusted correctly? ([Menu] button →"Image" →"Picture Quality" →"Contrast") 	<p>☛ "Image menu" P.35</p>
<ul style="list-style-type: none"> • Has the colour been adjusted correctly? ([Menu] button →"Image" →"Picture Quality" →"Color Temperature") 	<p>☛ "Image menu" P.35</p>
<ul style="list-style-type: none"> • Has the saturation and tint been adjusted correctly? ([Menu] button →"Image" →"Picture Quality" →"Saturation", "Tint") 	<p>☛ "Image menu" P.35</p>
<ul style="list-style-type: none"> • Has the image brightness been adjusted correctly? ([Menu] button →"Image" →"Picture Quality" →"Brightness") 	<p>☛ "Image menu" P.35</p>
<ul style="list-style-type: none"> • Are the cables connected correctly? 	<p>☛ "Connecting to a Computer" P.12 , "Connecting to Video Equipment" P.18</p>
<ul style="list-style-type: none"> • When connecting to a computer 	<p>Colours may not exactly match those displayed on the computer screen or LCD screen, but this is normal and is not the sign of a problem.</p>

■ Image is dark

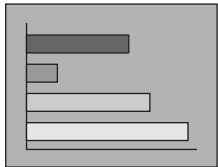
	<ul style="list-style-type: none"> Does the lamp need replacement? 	<p>When the lamp is due for replacement, colours will weaken and the image will become dark. Replace the lamp when this is the case. ☛ "Lamp replacement period" P.57</p>
	<ul style="list-style-type: none"> Has the image brightness been adjusted correctly? ([Menu] button →"Image" → "Picture Quality" →"Brightness") 	<p>☛ "Image menu" P.35</p>
	<ul style="list-style-type: none"> Has the image contrast been adjusted correctly? ([Menu] button →"Image" → "Picture Quality" →"Contrast") 	<p>☛ "Image menu" P.35</p>

■ No sound can be heard

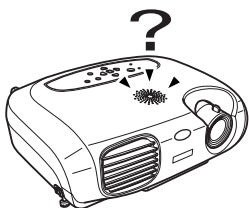
	<ul style="list-style-type: none"> Is A/V Mute activated? 	<p>The projector may be in A/V Mute mode. Press the [A/V Mute] button on the remote control to cancel A/V Mute. ☛ "A/V Mute" P.28</p>
	<ul style="list-style-type: none"> Is the volume turned down to the minimum setting? ([Menu] button →"Setting" → "Volume") 	<p>☛ "Setting menu" P.38</p>
	<ul style="list-style-type: none"> Is the audio source connected correctly? 	<p>☛ "Playing sound from a computer" P.14 , "Playing sound from video equipment" P.19</p>

■ The remote control does not work

	<ul style="list-style-type: none"> • Is direct sunlight or strong light from fluorescent lamps shining onto the remote control infrared receiver? 	<p>☞ "Using the Remote Control" P.9</p>
	<ul style="list-style-type: none"> • Is the remote control too far from the projector? 	<p>The operating distance for the remote control is approximately 6m (20ft.). ☞ "Operating range" P.9</p>
	<ul style="list-style-type: none"> • When in use, is the remote control infrared transmitter facing the remote control infrared receiver on the projector? 	<p>The operating angle for the remote control is approximately $\pm 30\frac{1}{2}^\circ$ horizontally and approximately $\pm 15\frac{1}{2}^\circ$ vertically. ☞ "Operating range" P.9</p>
	<ul style="list-style-type: none"> • Has the battery insulating tape been removed? 	<p>☞ "Before using the Remote Control" P.9</p>
	<ul style="list-style-type: none"> • Is the battery dead? 	<p>☞ "Changing the battery (Remote Control, Presentation Remote Controller)" P.56</p>
	<ul style="list-style-type: none"> • Is the battery inserted correctly? 	
	<ul style="list-style-type: none"> • Is the battery installed? 	

■ The power does not turn off (after the [Power] button is pressed)

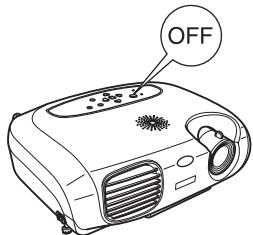
	<ul style="list-style-type: none"> • The power indicator remains orange. 	<p>This projector is designed so that the Power indicator remains lit even after the power has been turned off. The Power indicator will switch off when the power cable is disconnected from the electrical outlet.</p>
	<ul style="list-style-type: none"> • The cooling fan does not stop. 	<p>After the [Power] button has been pressed, the cool-down period begins. After this, the Power indicator changes to a steady orange, and you can then disconnect the power cable from the electrical outlet. Cool-down lasts for about 20 seconds.</p>

! *Be sure to read the separate "Safety Instructions/World-Wide Warranty Terms" before proceeding.*

Cleaning

You should clean the projector if it becomes dirty or if the projected image starts to deteriorate.

■ Cleaning the projector case

Clean the projector case by wiping it gently with a soft cloth.

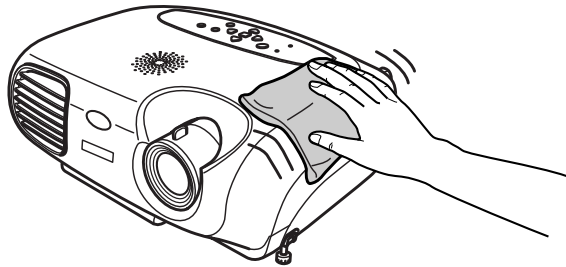

If the projector is particularly dirty, moisten the cloth with water containing a small amount of (pH) neutral detergent, and then firmly wring the cloth dry before using it to wipe the projector case. After you have done this, wipe the projector another time with a soft, dry cloth.

! *Do not use volatile substances such as wax, alcohol or thinner to clean the projector case. These can cause the case to warp and make the surface coating peel off.*

■ Cleaning the lens

Use a commercially-available air blower, or lens cleaning paper to gently wipe the lens.



! *As the lens can be easily damaged, do not rub the lens with harsh materials or subject the lens to shocks.*

■ Cleaning the air filter

If the air filter becomes clogged with dust, it can cause overheating and damage the projector.

Keeping the projector horizontal, use a vacuum cleaner to clean away the dust from the air filter.

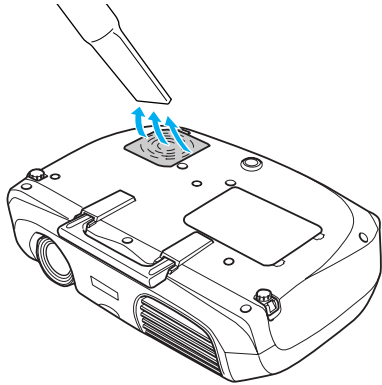

- *If the air filter is difficult to clean or if it is broken, it should be replaced. Contact your dealer for a new air filter.*
- *Spare lamps are provided with new air filters. When replacing the lamp, please replace the air filter at the same time.*

Replacing consumables

■ Changing the battery

(Remote Control, Presentation Remote Controller)

Replacement battery: 1 × CR2025 lithium battery

! *Keep batteries away from children to avoid the risk of accidents.
If a child swallows the battery, contact your doctor immediately.*

1 Remove the battery holder.

While pressing the catch of the battery holder inwards, pull the battery holder out.

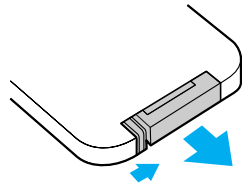

2 Remove the old battery and insert the new one.

Check the position of the (+) mark inside the battery holder to ensure that the battery is inserted the correct way.

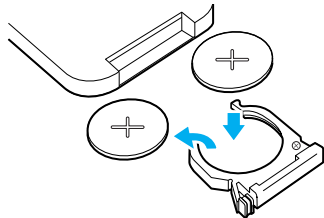

3 Replace the battery holder.

Press the battery holder in until it clicks.

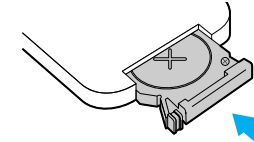

! *Please dispose of used batteries in accordance with local waste disposal regulations.*

■ Lamp replacement period

- It is time to change the lamp when the "Replace Lamp" message appears in the bottom left hand corner of the screen at the commencement of projection and remains for 30 seconds.
- It is also time to change the lamp when the Warning indicator flashes red at 0.5 second intervals.

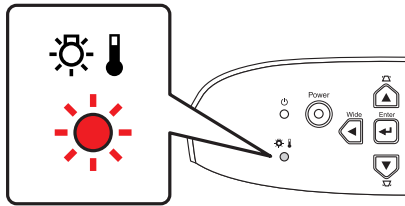

- *The replacement message will appear after about 1900 hours of use.*
- *When this message is displayed, please replace the lamp as quickly as possible.*
- *The lamp may explode if you continue to use it beyond the lamp replacement period.*
- *Some lamps may stop operating before the replacement message is displayed. It is recommended that you have a replacement lamp ready in case this happens.*
- *Replacement lamps can be purchased at your nearest dealer.*

■ Replacing the lamp



- *Wait until the lamp has cooled down sufficiently before opening the lamp cover. It takes a further one hour after the cool-down period has finished for the lamp to be cool enough.*
- *When the lamp is broken, replace it with a new lamp, or contact your dealer for further advice. If replacing the lamp yourself, be careful to avoid pieces of broken glass.*

1 Turn off the projector and wait for the cool-down period to end. (Approx. 20 seconds)

Remove the power cable and wait for the lamp to cool down. (Approx. 1 hour)

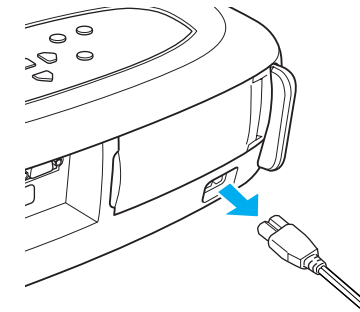

2 Open the lamp cover.

Lift the lamp cover by putting your fingers in the latches and lifting upwards.

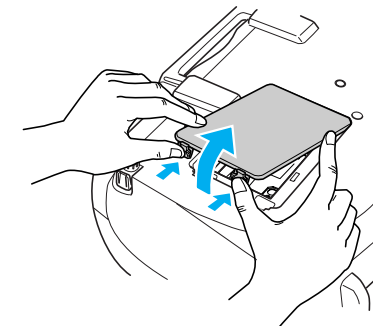

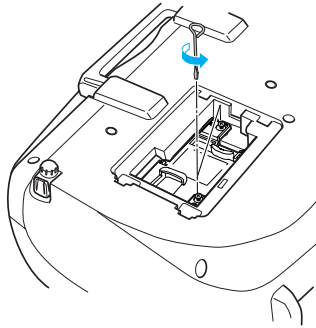
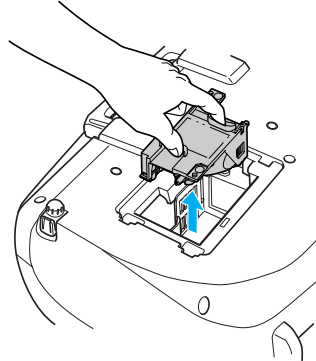

3 Loosen the fixing screws holding the lamp in place.**4** Remove the old lamp.**5** Install the new lamp.

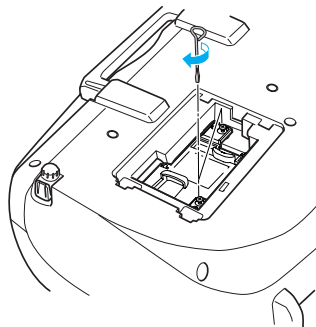
Press the lamp until it clicks into place, then tighten the two fixing screws.

**6** Replace the lamp cover.

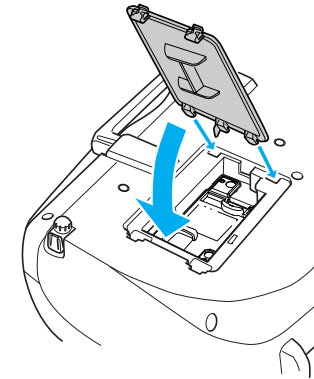
First insert the tabs, and then press down on the opposite side until it clicks into place.



- **Install the lamp securely. If the lamp cover is removed, the lamp turns off automatically as a safety precaution. The lamp will not turn on if the lamp or the lamp cover is not installed correctly.**
- **After replacing the lamp, be sure to reset the lamp operating time.**
- **New air filters are included with replacement lamps. The air filter should also be replaced when the lamp is replaced.**
 **"Lamp replacement period" P.57**
- **The lamp contains mercury. Dispose of used lamps properly in accordance with your local regulations.**

■ Resetting the lamp operating time

The projector has a built-in counter which keeps track of the lamp operating time and causes the replacement warning message to be displayed when the cumulative operating time reaches a certain point. Therefore, the counter needs to be reset from the configuration menu, after the lamp has been replaced with a new one.

 *Please do not reset the lamp operating time except when the lamp has been changed. Otherwise, the lamp operating time will not be displayed correctly.*

1 Turn on the power and press the [Menu] button.

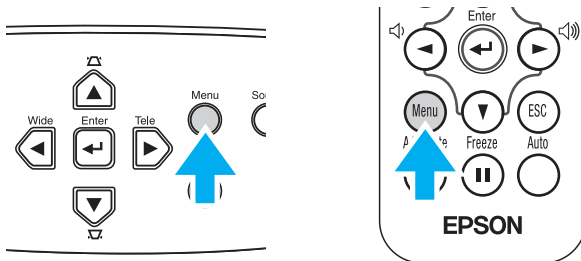

2 Select "Lamp Hours Reset" from the "Reset" menu, using the [▲][▼][←] buttons.

3 Use the [←][→] buttons to select "Yes", then press the [←] button.

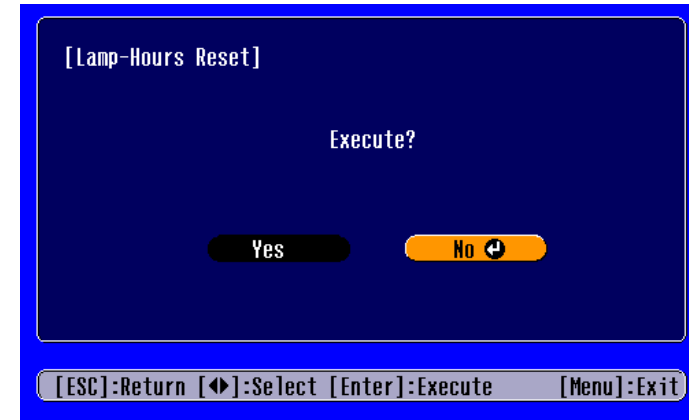

The lamp operating time will be reset.

■ Replacing the air filter

Replacing the air filter can also be performed when the projector is mounted to a ceiling.

- 1 Turn off the projector power, wait for the cool-down period to end, then disconnect the power cable.**

Cool-down takes about 20 seconds.

- 2 Put your finger into the recess in the air filter hook, and lift up the air filter to remove it.**

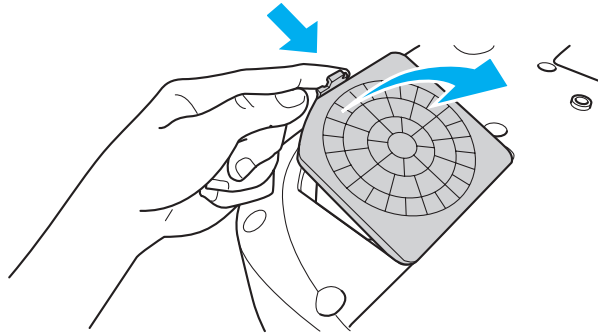

- 3 Replace the air filter with a new one.**

Take out the old air filter and install the new one. Please ensure there are no gaps between the air filter and the plastic grill.

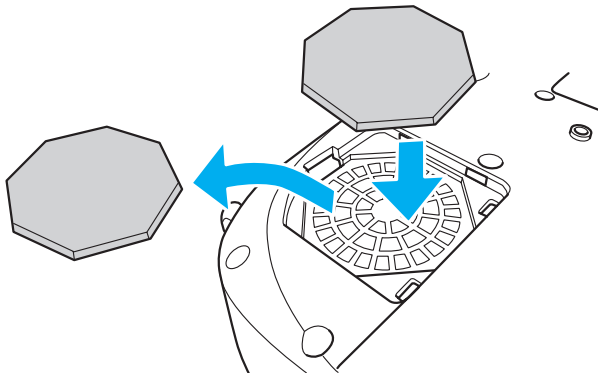

- 4 Replace the air filter cover.**

First insert the tabs, and then press down on the opposite side until it clicks into place.

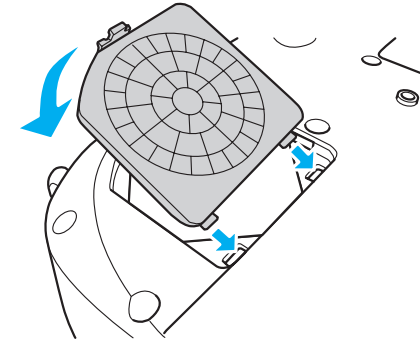

Dispose of used air filters properly in accordance with your local regulations.

The following optional accessories are available for purchase if required. This list of optional accessories is current as of August 2004. Details of accessories are subject to change without notice.

Part number	Part name	Use
ELPLP29	Spare lamp	Use as a replacement for spent lamps.
ELPAF03	Air filter (5 included)	Use as a replacement for spent air filters.
ELPST11	Remote controller	Identical to the remote control provided with the projector.
ELPST09	Presentation remote control kit	Optional Presentation remote control and remote control receiver set.
ELPSC06	50" Portable screen	A compact screen which can be carried easily. (4:3 aspect ratio)
ELPSC07	60" screen	A portable roll type screen. (4:3 aspect ratio)
ELPSC08	80" screen	
ELPSC10	100" screen	
ELPKC02	VGA-HD15 PC cable (1.8m/6ft.) (for mini D-Sub 15pin/mini D-Sub 15pin)	Use to connect the projector to a computer.
ELPKC09	VGA-HD15 PC cable (3m/9.8ft.) (for mini D-Sub 15pin/mini D-Sub 15pin)	Use these extension cables if the provided computer cable is too short.
ELPKC10	VGA-HD15 PC cable (20m/65.6ft.) (for mini D-Sub 15pin/mini D-Sub 15pin)	
ELPKC11	VGA-HD15 PC cable (1.8m/6ft.) (for mini D-Sub 15 pin/5BNC)	
ELPKC19	Component video cable (3m/9.8ft.) (for mini D-Sub 15pin/RCA×3 (male))	Use to connect the projector to a component video source.
ELPKC27	Component video cable (0.35m/1.15ft.) (for mini D-Sub 15pin/RCA×3 (female))	Use to connect the projector to a commercially available component video cable (RCAx3, male).



Part number	Part name	Use
ELPMB18	Ceiling mount*	Use when installing the projector to a ceiling.
ELPFC03	Ceiling plate*	Use when installing the projector to a high ceiling or a ceiling with veneer panels.
ELPFP04	Pipe 370 (370mm silver)*	
ELPFP05	Pipe 570 (570mm silver)*	
ELPFP06	Pipe 770 (770mm silver)*	
ELPDC02 ELPDC04	Image presentation camera	Use when projecting books, OHP films and slides.

* A special method of installation is required in order to suspend the projector from the ceiling. Please contact your dealer if you require this installation method.

Complex terms used in this book, or terms not explained in the body of the text, will be briefly explained here. For further explanation, please consult commercially available reference texts.

5BNC	A type of connector used to input analog video signals.
Aspect ratio	The ratio between an image's length and its height. Images which have an aspect ratio of 16:9 are called Widescreen. The aspect ratio for standard images is 4:3.
Color Temperature	The temperature of an object which is emitting light. When the colour temperature is high, colours tend to take on a bluish tinge; when the colour temperature is low, colours tend to take on a reddish tinge.
Component Video	A type of video signal which has the video brightness and colour signal information separated, in order to provide better image quality. In high-definition TV (HDTV), it refers to images which consist of three independent signals: Y (luminance signal), and Pb and Pr (colour difference signals).
Composite Video	The standard home video signal (NTSC, PAL, SECAM) which has the video brightness and colour signal information mixed together. Composite video consists of the carrier signal Y (luminance signal) and the chroma (colour) signal, combined within the colour bar signal.
Contrast	The relative brightness of the light and dark areas of an image can be increased or decreased in order to make text and graphics stand out, or appear softer. Adjusting this particular property of an image is called "contrast adjustment".

Cool-down	The process used to cool down a projector lamp that is hot from use. Cool-down happens automatically when the [Power] button is pressed on the projector or on the remote control to turn the projector off. Do not unplug the projector power cable whilst it is cooling down. If cool-down is interrupted, heat from the lamp gets trapped inside the projector, potentially shortening the life of the lamp and causing projector failure.
Dolby digital	An audio format developed by Dolby Laboratories. Normal stereo is a 2-channel format which uses two speakers, whereas Dolby Digital is a 6-channel (5.1-channel) system which adds a centre speaker, two rear speakers and a sub-woofer.
HDTV	An abbreviation for High-Definition Television, it refers to high definition systems which satisfy the following conditions. <ul style="list-style-type: none"> • Vertical resolution of 750p or 1125i or greater (p=Progressive scanning, i=Interlaced scanning) • Screen aspect ratio of 16:9 • Dolby digital audio reception and playback (or output)
Interlaced scanning	Each screen is divided into fine horizontal lines which are displayed in sequence starting from left to right and then from top to bottom. This method of image scanning, whereby even numbered lines and odd numbered lines are displayed alternately, is called Interlaced scanning.
Progressive scanning	A method of image scanning whereby the image data from a single image is scanned sequentially from top to bottom to create a single image.



Refresh Rate	The light-emitting element of a display maintains the same luminosity and colour for an extremely short time. For this reason, the image must be scanned many times per second in order to refresh the light-emitting element. The number of refresh operations per second is called the "refresh rate", and is expressed in hertz (Hz).
Resized display	This function is used to project computer images that have a resolution more than or less than the projector's panel resolution, so that they fill the whole of the projection area.
SDTV	An abbreviation for Standard Definition Television. It refers to standard television systems which do not satisfy the conditions for High-Definition Television.
Security lock	A device consisting of a projector case with a hole in it that a commercially-available theft-prevention cable can be passed through in order to secure the device to a table or pillar. This projector is compatible with the Microsaver Security System manufactured by Kensington.
Squeeze mode	The method of compressing 16:9 Widescreen images and recording them on video software as 4:3 images. When projecting with Squeeze mode on, the images will return to their original 16:9 format.
sRGB	An international standard for colour intervals that was formulated so that colours which are reproduced by video equipment can be handled easily by computer operating systems (OS) and the Internet.

SVGA	A type of video signal with a resolution of 800 (horizontal) × 600 (vertical) dots which is used by IBM PC/AT-compatible computers.
S-Video	A type of video signal which has the video brightness and colour signal information separated, in order to provide better image quality. It refers to images which consist of two independent signals: Y (luminance signal), and C (colour signal).
Sync. (Synchronisation)	The signals output from computers have a specific frequency. Image quality will suffer if the projector frequency and the computer frequency do not match. The process of matching the phases of these signals (the relative position of the crests and troughs in the signal) is called "synchronisation". If the signals are not synchronised, problems such as flickering, blurriness and horizontal interference can occur.
Tracking	The signals output from computers have a specific frequency. Image quality will suffer if the projector frequency and the computer frequency do not match. The process of matching the frequency of these signals (the number of crests in the signal) is called "tracking". If tracking is not carried out correctly, wide vertical stripes will appear in the projected images.
VGA	A type of video signal with a resolution of 640 (horizontal) × 480 (vertical) dots which is used by IBM PC/AT-compatible computers.
XGA	A type of video signal with a resolution of 1,024 (horizontal) × 768 (vertical) dots which is used by IBM PC/AT-compatible computers.



YCbCr	The carrier signal contained in the colour bar signal used in modern (NTSC) TV transmissions. The name comes from the Y (luminance) signal and the CbCr (chroma (colour)) signals.
YPbPr	The carrier signal contained in the colour bar signal used in high-definition TV (HDTV) transmissions. The name comes from the Y (luminance) signal and the PbPr (colour difference) signals.

Serial connection

- Connector type: D-Sub 9 pin(male)
- Projector input port type : RS-232C

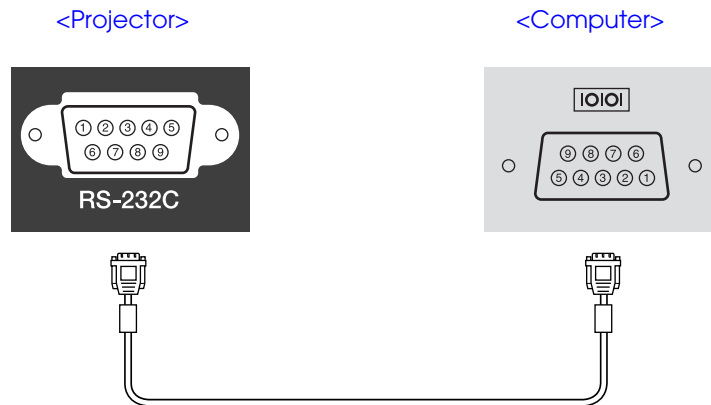

<Projector> (PC serial cable) <Computer>



Signal name	Function
GND	Signal line grounding
TD	Transmitting data
RD	Receiving data
DSR	Data set ready
DTR	Data terminal ready

■ Computer

Signal	Refresh Rate ^{▶▶} (Hz)	Resolution (dots)	Resolutions for Resized display ^{▶▶} (dots)	
			Aspect ratio 4:3	Aspect ratio 16:9
VGA ^{▶▶}	60	640 × 480	800 × 600	
VGAEGA		640 × 350	800 × 438	
VESA	72 / 75 / 85, iMac*	640 × 480	800 × 600	
SVGA ^{▶▶}	56 / 60 / 72 / 75 / 85, iMac*	800 × 600	800 × 600	
XGA ^{▶▶}	43i / 60 / 70 / 75 / 85, iMac*	1024 × 768	800 × 600	
MAC13"		640 × 480	800 × 600	
MAC16"		832 × 624	800 × 600	
MAC19"		1024 × 768	800 × 600	
MAC21"		1152 × 870	794 × 600	
SDTV ^{▶▶} (525i)	60	640 × 480	800 × 600	
SDTV (525p)	60	640 × 480	800 × 600	
HDTV ^{▶▶} (750p)	60	1280 × 720	800 × 450	
HDTV (1125i)	60	1920 × 1080	800 × 450	

* Connection is not possible if the equipment does not have a VGA output port.

■ Component Video

Signal	Refresh Rate (Hz)	Resolutions (dots)	
		Aspect ratio 4:3	Aspect ratio 16:9
SDTV(525i)(D1)	60	800 × 600	800 × 450
SDTV(625i)	50	800 × 600	800 × 450
SDTV(525p)(D2)	60	800 × 600	800 × 450
HDTV(750p) 16:9 (D4)	60	800 × 600	800 × 450
HDTV(1125i) 16:9 (D3)	60	800 × 600	800 × 450

■ Composite Video/S-Video

Signal	Refresh Rate (Hz)	Resolutions (dots)	
		Aspect ratio 4:3	Aspect ratio 16:9
TV(NTSC)		800 × 600	800 × 450
TV(PAL, SECAM)		800 × 600	800 × 450

It may be possible to project signals which are not listed in the above table. However, not all functions may be supported with such signals.

Product name	LCD Projector EMP-S1H		
Dimensions	370(W)×106(H)×265(D)mm (not including feet)		
Panel Size	0.5 inches		
Display method	Polysilicon TFT active matrix		
Resolution	SVGA ▶ 480,000 (800(W)×600(H)dots)×3		
Focus adjustment	Manual		
Zoom adjustment	Digital (Approx. 1:1.2)		
Lamp (light source)	UHE Lamp 130W, Model No.:ELPLP29		
Max. audio output	1W monaural		
Speaker	1		
Power supply	100-240VAC 50/60Hz 2.3-1.0A		
Operating temperature	+5°C to +35°C (41°-95°F) (No condensation)		
Storage temperature	-10°C to +60°C (14°-140°F) (No condensation)		
Weight	Approx. 3.2kg (7.0lbs)		
Connectors	Monitor Out port	1	Mini D-Sub 15pin(female)black
	Computer/Component Video port	1	Mini D-Sub 15pin(female)blue
	S-Video port	1	Mini DIN 4pin
	Video port	1	RCA pin jack
	Audio port	1	RCA pin jack×2(L,R)
	Control (RS-232C) port	1	D-Sub 9 pin(male)

Safety

USA (100-120VAC)
 UL1950 3rd Edition
 Canada (100-120VAC)
 CSA C22.2 No.950-95 (cUL)
 European Community (200-240VAC)
 The Low Voltage Directive (73/23/EEC)
 IEC60950 2nd Edition, +Amd.1, +Amd.2,
 +Amd.3, +Amd.4

EMC

USA (100-120VAC)
 FCC 47CFR Part15B Class B (DoC)
 Canada (100-120VAC)
 ICES-003 Class B

European Community (200-240VAC)
 The EMC Directive (89/336/EEC)
 EN55022, 1998 Class B
 EN55024, 1998
 IEC61000-4-2, IEC61000-4-3, IEC61000-4-4,
 IEC61000-4-5,
 IEC61000-4-6, IEC61000-4-8, IEC61000-4-11,
 IEC61000-3-2, IEC61000-3-3

Australia/New Zealand (200-240VAC)
 AS/NZS 3548:1995, A1:1997, A2:1997, Class B
 CISPR Pub.22:1993, A1:1995, A2:1996, Class B



Pixelworks DNX™ ICs are used in this Projector.

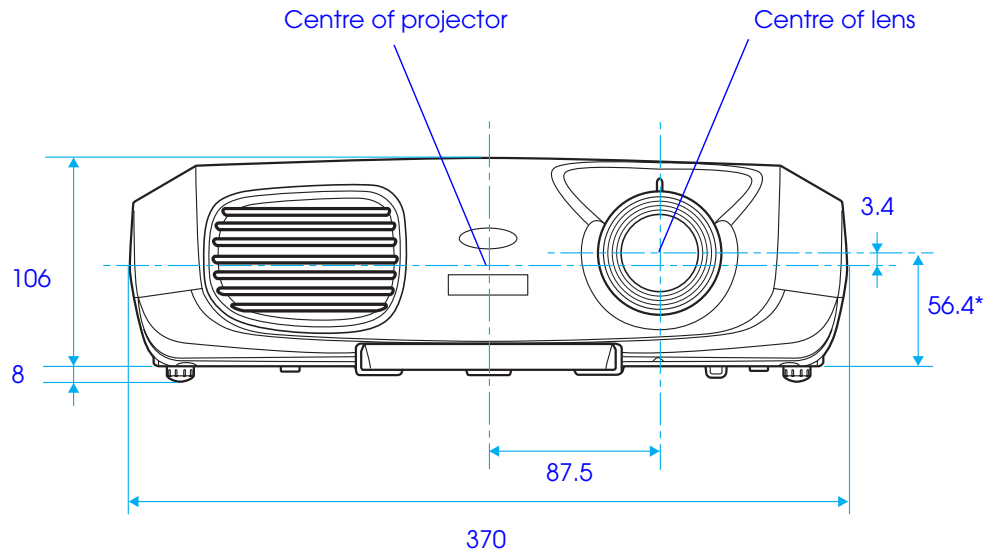

* Distance from centre of lens to ceiling mount

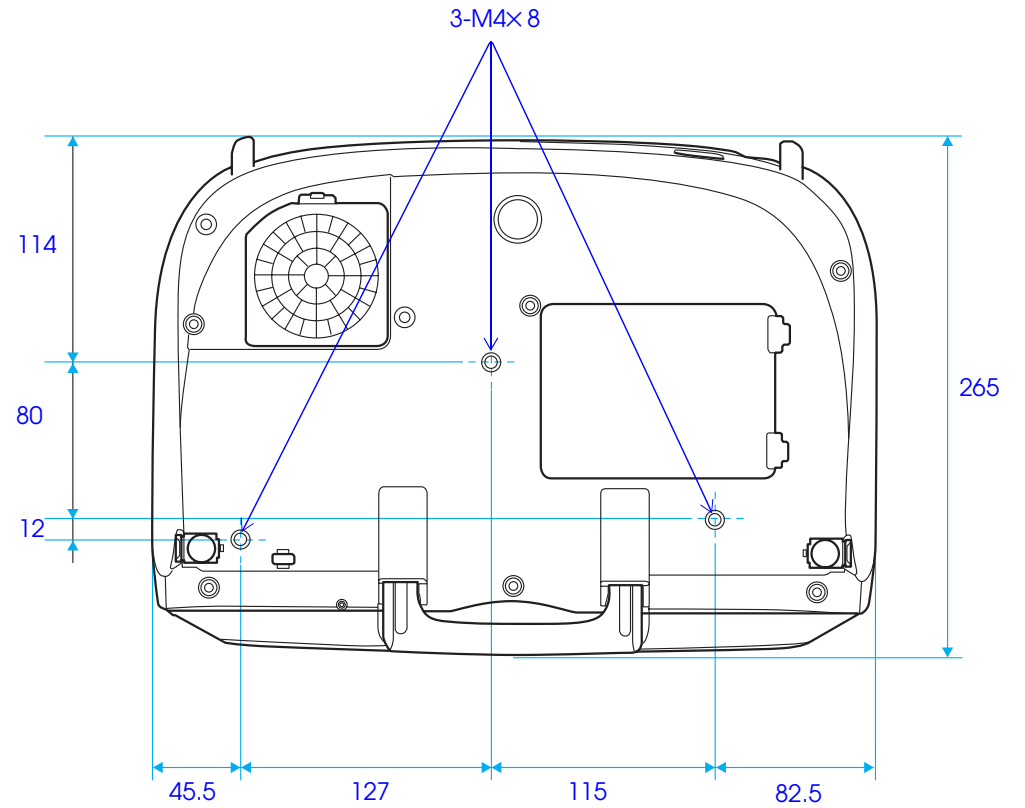

Numerics

13w3 port	13
5BNC port	13

A

A/V Mute	28
Air filter	7
Air intake vent	7
All Reset	42
Aspect ratio	8, 29
Audio port	6
Auto Setup	27, 37
AV cable	18

B

Background Color	39
Battery holder	56
Brightness	36

C

Cable Format	66
Ceiling	11, 38
Ceiling mount fixing points	7
Changing the battery	56
Cleaning the air filter	55
Cleaning the lens	54
Cleaning the projector case	54
Color Mode	36
Color Temperature	37
Component Video	18
Composite Video	18
Computer cable	13
Computer/Component Video port	6
Configuration Menus	31
Connecting to a Computer	12
Connecting to Video Equipment	18

Contrast	36
Control (RS-232C) port	6
Control panel	4, 5
Cool-down	22, 43

D

Display	39
---------------	----

E

E-Zoom	30
--------------	----

F

Focus	23
Focus ring	4, 23
Foot button	4
Freeze	28
Front foot	4

G

Glossary	63
----------------	----

H

Handle	4, 7
HDTV	63

I

Image menu	31, 35
Indicators	5, 43, 46
Info menu	40
Input Signal	37, 40
Installation	10



J

Joystick 17

K

Keystone 25, 38

L

Lamp cover 7
Lamp Hours 40
Lamp replacement period 57
Lamp-Hours Reset 42
Language 39
Lens cover 4

M

Message 39
Mini D-Sub 15 pin 13
Monitor Out port 6
Mouse pointer 15

O

Operating range
(Presentation remote controller) 17
(Remote control) 9
Operating temperature 68
Optional Accessories 61
Overheating 44

P

Part Names and Functions 4
Picture Quality 36
Port 6
Position 38
Power cable 20

Power indicator 5
Power inlet 6
Presentation remote controller 15
Projecting in widescreen 29
Projection 38
Projection angle 24
Projection distance 10

R

Remote Control 8
Remote control holder 6
Remote control infrared receiver 4, 6
Remote control infrared transmitter
(Presentation remote controller) 17
(Remote control) 8
Replacing the air filter 60
Replacing the lamp 57
Reset menu 42
Resized display 64
RGB 19

S

Saturation 37
Screen 38
Screen size 10
Security lock 6
Setting menu 38
Sharpness 36
Sleep Mode 39
Source 40
Speaker 4, 14
Specifications 68
sRGB 27, 36
Startup Screen 39
Storage temperature 68
Sub Menu 33
Supported Display 67
S-Video 18, 26



S-Video port	6
Sync Info	41
Sync.	27, 37

T

Target scope	30
Tint	37
Top Menu	32
Tracking	36
Translucent screen	11
Turning off the Projector	22
Turning on the Projector	20

V

Ventilation outlet	4
Video	40
Video port	6
Video Signal	
(displaying the Video signal)	40
(Selecting the Video signal)	39
Volume	39

W

Warning indicator	5
When You Suspect a Problem	43
Workstation	13

DECLARATION of CONFORMITY

According to 47CFR, Part 2 and 15
Class B Personal Computers and Peripherals; and/or
CPU Boards and Power Supplies used with Class B
Personal Computers

We :EPSON AMERICA, INC.
Located at :3840 Kilroy Airport Way
MS: 3-13
Long Beach, CA 90806
Tel :562-290-5254

Declare under sole responsibility that the product identified herein, complies with 47CFR Part 2 and 15 of the FCC rules as a Class B digital device. Each product marketed, is identical to the representative unit tested and found to be compliant with the standards. Records maintained continue to reflect the equipment being produced can be expected to be within the variation accepted, due to quantity production and testing on a statistical basis as required by 47CFR 2.909. Operation is subject to the following two conditions : (1) this device may not cause harmful interference, and (2) this device must accept any interference received, including interference that may cause undesired operation.

Trade Name :EPSON
Type of Product :Projector
Model :EMP-S1H

**FCC Compliance Statement
For United States Users**

This equipment has been tested and found to comply with the limits for a Class B digital device, pursuant to Part 15 of the FCC Rules. These limits are designed to provide reasonable protection against harmful interference in a residential installation. This equipment generates, uses, and can radiate radio frequency energy and, if not installed and used in accordance with the instructions, may cause harmful interference to radio or television reception. However, there is no guarantee that interference will not occur in a particular installation. If this equipment does cause interference to radio and television reception, which can be determined by turning the equipment off and on, the user is encouraged to try to correct the interference by one or more of the following measures.

- Reorient or relocate the receiving antenna.
- Increase the separation between the equipment and receiver.
- Connect the equipment into an outlet on a circuit different from that to which the receiver is connected.
- Consult the dealer or an experienced radio/TV technician for help.

WARNING

The connection of a non-shielded equipment interface cable to this equipment will invalidate the FCC Certification or Declaration of this device and may cause interference levels which exceed the limits established by the FCC for this equipment. It is the responsibility of the user to obtain and use a shielded equipment interface cable with this device. If this equipment has more than one interface connector, do not leave cables connected to unused interfaces. Changes or modifications not expressly approved by the manufacturer could void the user's authority to operate the equipment.

All rights reserved. No part of this publication may be reproduced, stored in a retrieval system, or transmitted in any form or by any means, electronic, mechanical, photocopying, recording, or otherwise, without the prior written permission of SEIKO EPSON CORPORATION. No patent liability is assumed with respect to the use of the information contained herein. Neither is any liability assumed for damages resulting from the use of the information contained herein.

Neither SEIKO EPSON CORPORATION nor its affiliates shall be liable to the purchaser of this product or third parties for damages, losses, costs, or expenses incurred by purchaser or third parties as a result of: accident, misuse, or abuse of this product or unauthorized modifications, repairs, or alterations to this product, or (excluding the U.S.) failure to strictly comply with SEIKO EPSON CORPORATION's operating and maintenance instructions.

SEIKO EPSON CORPORATION shall not be liable against any damages or problems arising from the use of any options or any consumable products other than those designated as Original EPSON Products or EPSON Approved Products by SEIKO EPSON CORPORATION.

General Notice:

EPSON is a registered trademark of SEIKO EPSON CORPORATION.

Macintosh, Mac, and iMac are registered trademarks of Apple Computer, Inc.

IBM is a registered trademark of International Business Machines Corporation.

Windows and Windows NT are trademarks of Microsoft Corporation in the United States of America.

Dolby is registered trademarks of Dolby Laboratories.

Pixelworks and DNX are trademarks of Pixelworks, Inc.

Other product names used herein are also for identification purposes only and may be trademarks of their respective owners. EPSON disclaims any and all rights in those marks.