

Acer Projector

X1120H/X1220H/X1320WH/P1120/
P1220/P1320W Series
User's Manual

© 2011. All Rights Reserved.
Original Issue: 07/2011

Acer Projector X1120H/X1220H/X1320WH/P1120/P1220/P1320W Series

Model number: _____
Serial number: _____
Date of purchase: _____
Place of purchase: _____

Information for your safety and comfort

Read these instructions carefully. Keep this document for future reference. Follow all warnings and instructions marked on the product.

Before cleaning

- Turn the product off and unplug it from the wall outlet before cleaning.
- Do not use liquid cleaners or aerosol cleaners. Use a damp cloth for cleaning.

Location precautions

Be sure that the power outlet you plug the power cord into is easily accessible and located as close to the equipment operator as possible. When you need to disconnect power to the equipment, be sure to unplug the power cord from the electrical outlet.

- Do not use this product near water.
- Do not place this product on an unstable cart, stand or table. If the product falls, it could be seriously damaged.
- Slots and openings are provided for ventilation to ensure reliable operation of the product and to protect it from overheating. These openings must not be blocked or covered. The openings should never be blocked by placing the product on a bed, sofa, rug or other similar surface.
- This product should never be placed near or over a radiator or heat register, or in a built-in installation unless proper ventilation is provided.
- Never push objects of any kind into this product through cabinet slots as they may touch dangerous voltage points or short-out parts that could result in a fire or electric shock. Never spill liquid of any kind onto or into the product.
- To avoid damage of internal components and to prevent battery leakage, do not place the product on a vibrating surface.
- Never use it under sporting, exercising, or any vibrating environment which will probably cause unexpected short circuits and may damage rotor devices or the lamp.

Using electrical power

- This product should be operated from the type of power indicated on the marking label. If you are not sure of the type of power available, consult your dealer or local power company.
- Do not allow anything to rest on the power cord. Do not locate this product where people will walk on the cord.
- If an extension cord is used with this product, make sure that the total ampere rating of the equipment plugged into the extension cord does not exceed the

extension cord ampere rating. Also, make sure that the total rating of all products plugged into the wall outlet does not exceed the fuse rating.

- Do not overload a power outlet, strip or receptacle by plugging in too many devices. The overall system load must not exceed 80% of the branch circuit rating. If power strips are used, the load should not exceed 80% of the power strip's input rating.
- This product's AC adapter is equipped with a three-wire grounded plug. The plug only fits in a grounded power outlet. Make sure the power outlet is properly grounded before inserting the AC adapter plug. Do not insert the plug into a non-grounded power outlet. Contact your electrician for details.



Warning! The grounding pin is a safety feature. Using a power outlet that is not properly grounded may result in electric shock and/or injury.



Note: The grounding pin also provides good protection from unexpected noise produced by other nearby electrical devices that may interfere with the performance of this product.

- Use the product only with the supplied power supply cord set. If you need to replace the power cord set, make sure that the new power cord meets the following requirements: detachable type, UL listed/CSA certified, VDE approved or its equivalent, 4.6 meters (15 feet) maximum length.

Product servicing

Do not attempt to service this product yourself, as opening or removing covers may expose you to dangerous voltage points or other risks. Refer all servicing to qualified service personnel.

Unplug this product from the wall outlet and refer servicing to qualified service personnel when:

- The power cord or plug is damaged, cut or frayed.
- Liquid was spilled into the product.
- The product was exposed to rain or water.
- The product has been dropped or the case has been damaged.
- The product exhibits a distinct change in performance, indicating a need for service.
- The product does not operate normally after following the operating instructions.



.....

Note: Adjust only those controls that are covered by the operating instructions, since improper adjustment of other controls may result in damage and will often require extensive work by a qualified technician to restore the product to normal condition.



.....

Warning! For safety reasons, do not use non-compliant parts when adding or changing components. Consult your reseller for purchase options.



.....

Warning! This device and its enhancements may contain small parts. Keep them out of the reach of small children.

Additional safety information

- Do not look into the projector's lens when the lamp is on. The light may hurt your eyes.
- Turn on the projector first and then signal sources
- Do not place the product in following environments:
 - Locations that are confined or poorly ventilated. The projector must have at least 50 cm clearance from walls and have free flowing air around it.
 - Locations where temperatures may become excessively high, such as inside of a car with all windows rolled up.
 - Locations where excessive humidity, dust, or cigarette smoke may contaminate optical components.

- Locations near fire alarms.
- Locations with an ambient temperature above 40° C/104° F.
- Locations where the altitudes are higher than 10,000 feet.
- Do not operate if smoke, a strange noise, or an odor are coming out of the projector. In this case, immediately unplug the projector and contact your dealer.
- Do not keep using the projector if it has been dropped or damaged. In this case, contact your dealer for inspection.
- Do not face the projector lens to the sun. It can lead to fire.
- Do not frequently turn off the main power abruptly or unplug the projector during operation. It is best to wait for the fan to turn off before turning off the projector's power.
- Do not touch the air outlet grille or bottom plate because they may be hot.
- If the projector has an air filter, clean it regularly. If left uncleaned, the temperature inside might rise and cause damage.
- Do not look into the air outlet grille when projector is operating. It may hurt your eyes.
- Do not block the projector lens with any object when the projector is under operation as this could cause the object to become heated and deformed or even cause a fire.
- The lamp becomes extremely hot during operation. Allow the projector to cool for approximately 45 minutes prior to removing the lamp assembly for replacement.
- Do not operate lamps beyond the rated lamp life.
- Never replace the lamp assembly or any electronic components unless the projector is unplugged.
- The product will detect the life of the lamp itself. Change the lamp when the warning message is displayed.
- Reset the **Lamp Hour Reset** function from the onscreen display *Management* menu after replacing the lamp module.
- Do not attempt to disassemble the projector, as opening or removing covers may expose you to dangerous voltage points or other risks. Refer all servicing to qualified service personnel.
- Do not stand the projector on its end vertically. The projector may fall over, causing injury or damage.
- This product is capable of displaying inverted images for ceiling-mounted installation. Only use an Acer ceiling mount kit and ensure it is securely installed.

Protect your hearing

To protect your hearing, follow these instructions.

- Increase the volume gradually until you can hear clearly and comfortably.

- Do not increase the volume level after your ears have adjusted.
- Do not listen to music at high volumes for extended periods.
- Do not increase the volume to block out noisy surroundings.
- Decrease the volume if you can't hear people speaking near you.

Disposal instructions

Do not throw this electronic device into the trash when discarding. To minimize pollution and ensure utmost protection of the global environment, please recycle. For more information on the Waste from Electrical and Electronics Equipment (WEEE) regulations, visit

www.acer-group.com/public/Sustainability/sustainability01.htm



Mercury advisory

For projectors or electronic products containing an LCD/CRT monitor or display:



“Lamp(s) contain Mercury,
Dispose Properly.”

Lamp(s) inside this product contain mercury and must be recycled or disposed of according to local, state or federal laws. For more information, contact the Electronic Industries Alliance at www.eiae.org. For lamp-specific disposal information, check www.lamprecycle.org

Information for your safety and comfort	iii
Introduction	1
Product features	1
Package contents	2
Projector overview	3
Front / top	3
Rear	3
Control panel	4
Remote control layout	5
Getting started	8
Connecting the projector	8
Turning the projector on/off	9
Turning the projector on	9
Turning the projector off	10
Adjusting the projected image	10
Adjusting the height of the projected image	10
Optimizing image size and distance	12
Adjusting distance and zoom to optimize image size	16
User controls	19
Installation menu	19
Acer Empowering Technology	20
Onscreen Display Menus	22
Color	23
Image	24
Setting	27
Management	31
Audio	31
3D	32
Language	33
3D projection	34
Using DLP 3D technology	34
Setting up a 3D environment	34

Contents

Using the stereoscopic player	36
Using 3D glasses (optional)	37
Watching 3D DVD content	37
Appendices	39
Troubleshooting	39
LED and alarm definitions	42
Replacing and cleaning the dust filter	43
Replacing the lamp	44
Ceiling mount installation	45
Specifications	48
Compatibility modes	50
Regulations and safety notices	54

Introduction

Product features

This product is a single-chip DLP projector, featuring:

- DLP technology.
- X1120H/P1120 series: Native 800 x 600 SVGA resolution.
- X1220H/P1220 series : Native 1024 x 768 XGA resolution.
- X1320WH/P1320W: Native 1280 X 800 resolution.
- Acer ColorSafe II technology ensures consistent color rendition over time.
- Smart detection delivers quick, intelligent source detection.
- Versatile display modes (Bright, Presentation, Standard, Video, Education, Picture, Game, User) for optimum performance in any situation.
- NTSC / PAL / SECAM compatible and HDTV (720p, 1080i, 1080p) supported.
- Lower power consumption and economy (ECO) mode extends lamp life.
- Acer EcoProjecton Technology delivers Intelligent power management approach and physical efficiency improvement.
- Empowering Key reveals Acer Empowering Technology utilities (Acer eView, eTimer, ePower Management, e3D Management) for easy adjustment of settings.
- Equipped with HDMI connection supporting HDCP.
- Advanced digital keystone correction optimizes presentations.
- Multi-language onscreen display.
- 0.8 to 1.85X digital zoom and pan move function.
- Microsoft Windows 2000, XP, Vista, Windows 7, and Macintosh OS compliant

Package contents

This projector comes with all the items shown below. Check to make sure your unit is complete. Contact your dealer immediately if anything is missing.

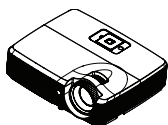

Projector

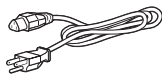

Power cord



VGA cable



Remote control



Batteries



User's Manual CD



Quick Start Guide



Carrying case (optional)

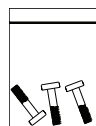

Screw pack



Dust filter
(optional)

Projector overview

Front / top

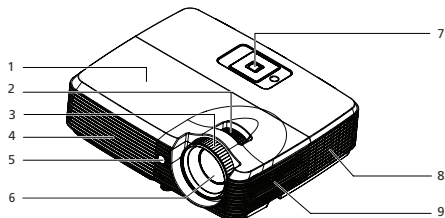

#	Description	#	Description
1	Lamp cover	6	Zoom lens
2	Zoom ring	7	Control panel
3	Focus ring	8	Ventilation (inlet)
4	Ventilation	9	Speaker
5	Remote control receivers		

Rear

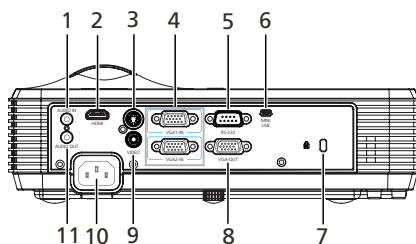

#	Description	#	Description
1	Audio input connector	7	Kensington lock port
2	HDMI input connector	8	Monitor loop-through output connector (VGA-OUT)
3	S-Video input connector	9	Composite video input connector
4	PC analog signal/HDTV/component video input connector (VGA 1-IN or VGA 2-IN)	10	Power socket
5	RS-232 connector	11	Audio output connector
6	Mini USB connector		

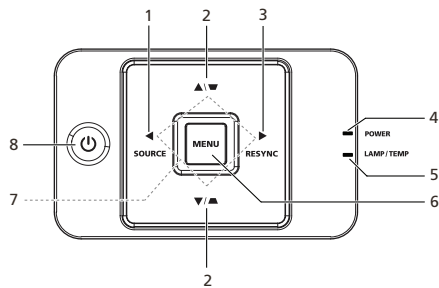

Control panel



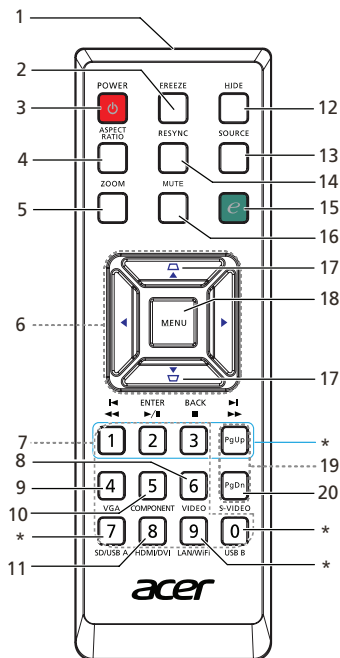

#	Icon	Function	Description
1		SOURCE	Changes the active source.
2	△ ▽	KEystone	Adjusts the image to compensate for distortion caused by tilting the projector (± 40 degrees).
3		RESYNC	Automatically synchronizes the projector to the input source.
4		POWER	Power indicator LED
5		LAMP/ TEMP	Lamp/Temp Indicator LED
6		MENU	<ul style="list-style-type: none"> Press MENU to launch the onscreen display (OSD) menu, back to the previous step for the OSD menu operation or exit the OSD menu. Confirm your selection of items.
7	← ↑ ↓ →	Four directional select keys	Use up, down, left, right buttons to select items or make adjustments to your selection.
8	⏻	POWER	Refer to "Turning the projector on/off" on page 9.

Remote control layout



#	Icon	Function	Description
1		Remote control transmitter	Sends signals to the projector.
2		FREEZE	Pauses the screen image.
3		POWER	Refer to "Turning the projector on/off" on page 9.
4		ASPECT RATIO	To choose the desired aspect ratio.
5		ZOOM	Zooms the projector display in or out.
6		Four directional select keys	Use up, down, left, right buttons to select items or make adjustments to your selection.

#	Icon	Function	Description
7		KeyPad 0 to 9	Press 0 to 9 to enter a password when required.
8		VIDEO	Press VIDEO to change source to composite video.
9		VGA	Press VGA to change source to the VGA1-IN/VGA2-IN connector. This connector supports analog RGB, YPbPr (480p/576p/720p/1080i), YCbCr (480i/576i) and RGBsync.
10		COMPONENT	Press COMPONENT to change source to the VGA1-IN/VGA2-IN connector. This connector supports analog RGB, YPbPr (480p/576p/720p/1080i), YCbCr (480i/576i) and RGBsync.
11		HDMI/DVI	Press HDMI/DVI to change source to HDMI/DVI.
12		HIDE	Momentarily turns off the video. Press HIDE to hide the image, press again to display the image.
13		SOURCE	Changes the active source.
14		RESYNC	Automatically synchronizes the projector to the input source.
15		Empowering Key	Launches Acer functions: eView, eTimer, ePower, e3D Management.
16		MUTE	Turns the sound on/off.
17		KEystone	Adjusts the image to compensate for distortion caused by tilting the projector (± 40 degrees).
18		MENU	<ul style="list-style-type: none"> Press MENU to launch the onscreen display (OSD) menu, back to the previous step for the OSD menu operation or exit the OSD menu. Confirm your selection of items.

#	Icon	Function	Description
19		Page	For computer mode only. Use this button to select the next or previous page. This function is only available when connected to a computer via a USB cable.
20		S-VIDEO	Press S-VIDEO to change source to S-Video. This function is only available when a USB cable is not connected to a computer.



.....

Note: Buttons marked with * are not operational on this projector.



X1120H/X1220H/P1120/P1220



X1320WH/P1320W

Getting started

Connecting the projector

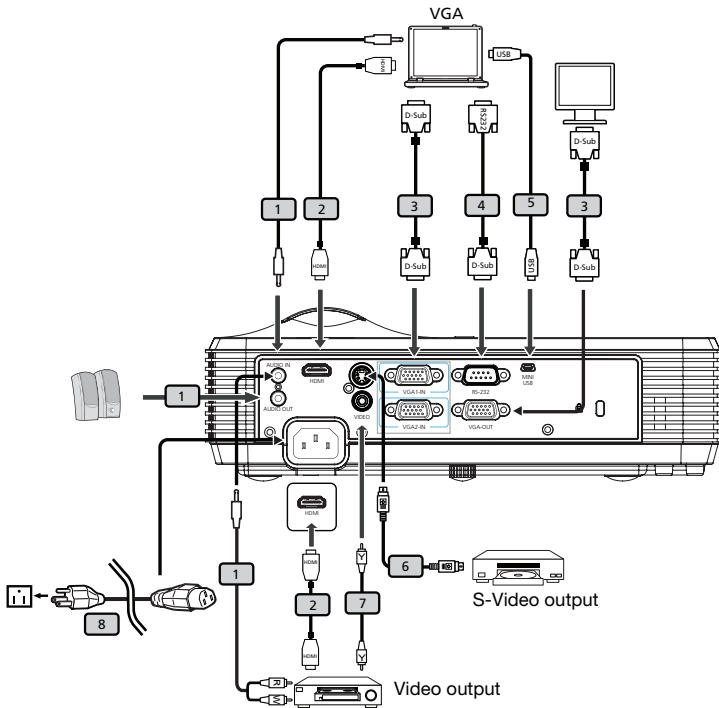

#	Description	#	Description
1*	Audio cable	5*	USB cable
2*	HDMI cable	6*	S-Video cable
3	VGA cable	7*	Composite video cable
4*	RS-232 cable	8	Power cord



Note: To ensure the projector works well with your computer, please make sure the timing of the display mode is compatible with the projector.

Note: * indicates an optional item.

Turning the projector on/off

Turning the projector on

- 1 Ensure that the power cord and signal cable are securely connected. The power indicator LED will light blue.
- 2 Turn on the projector by pressing the **POWER** button on the control panel. The power indicator LED will flash and then turn blue.
- 3 Turn on your source (computer, notebook, video player ,etc.). The projector will detect your source automatically.
 - If the screen displays the *Lock* and *Source* icons, it means the projector is locked onto a specific source type and that input signal type is not detected.
 - If the screen displays *No Signal*, please make sure the signal cables are securely connected.
 - If you connect to multiple sources at the same time, use the **SOURCE** button on the remote control to switch between inputs.

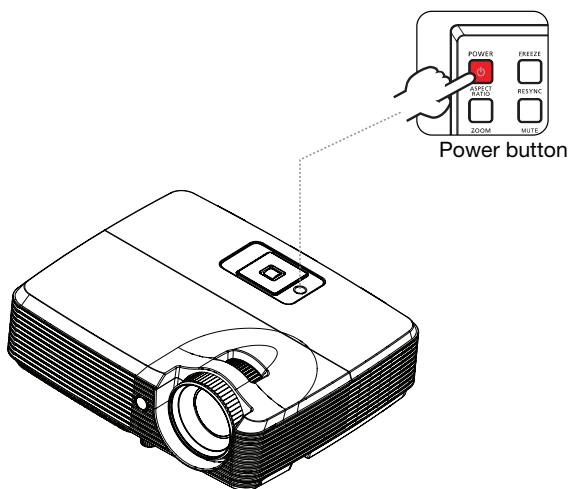

Turning the projector off

- 1 To turn the projector off, press the power button. This message appears: *Please press the power button again to complete the shutdown process.* Press the power button again.
- 2 The shutdown process will vary depending on the Turn Off Mode setting. Please refer to "Management" on page 31 for more details.
- 3 Once the shutdown process finishes, the power indicator LED becomes steady blue.
- 4 It is now safe to unplug the power cord.



Warning messages!

- **Projector Overheated. Lamp will automatically turn off soon.**
This onscreen message indicates that the projector has overheated. The lamp will automatically turn off, the projector will automatically shut down, and the LED temp indicator will blink. Contact your local dealer or service center.
- **Fan Fail. Lamp will automatically turn off soon.**
This onscreen message indicates that the fan has failed. The lamp will automatically turn off, the projector will automatically shut down, and the LED temp indicator will turn solid blue. Contact your local dealer or service center.



Note: Whenever the projector automatically shuts down and the LED power, temp and lamp indicators blink, contact your local reseller or service center.

Adjusting the projected image

Adjusting the height of the projected image

The projector is equipped with an elevator foot for adjusting the image height.

To raise/lower the image:

- 1 Use the elevator foot raise/lower the image to the desired height.

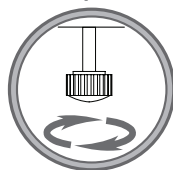
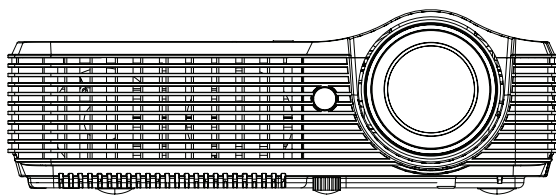

1

Elevator foot

Optimizing image size and distance

X1120H/X1220H/P1120/P1220 Series:

Consult the table below to find the optimal image sizes achievable when the projector is positioned at a desired distance from the screen. Example: If the projector is 3 m from the screen, good image quality is possible for image sizes between 68" and 75".



Note: The image will be 148 cm high when the projector is 3 m from the screen.

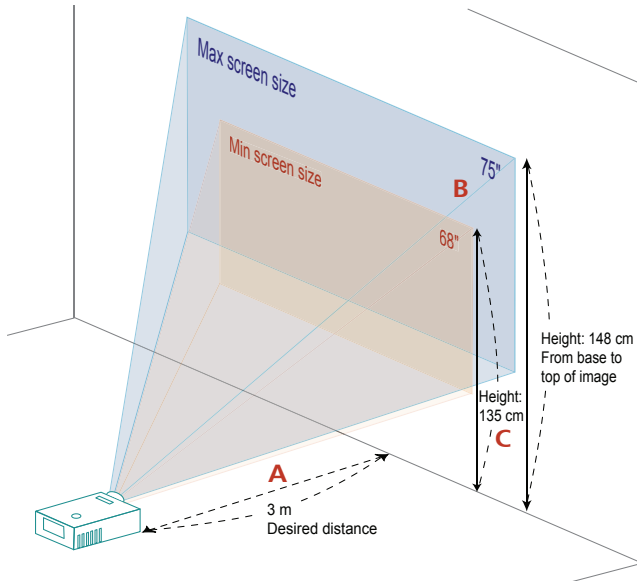

Desired distance (m) <A>	Screen size		Top	Screen size		Top
	(Min zoom)			(Max zoom)		
	Diagonal (inches) 	W (cm) x H (cm)	From base to top of image (cm) <C>	Diagonal (inches) 	W (cm) x H (cm)	From base to top of image (cm) <C>
1.5	34	69 x 52	68	37	76 x 57	74
2	46	93 x 69	90	50	102 x 76	99
2.5	57	116 x 87	113	62	127 x 95	124
3	68	139 x 104	135	75	152 x 114	148
3.5	80	162 x 122	158	87	178 x 133	173
4	91	185 x 139	181	100	203 x 152	198
4.5	103	208 x 156	203	112	228 x 171	223
5	114	231 x 174	226	125	254 x 190	247
6	137	278 x 208	271	150	305 x 228	297
7	159	324 x 243	316	175	355 x 266	346
8	182	370 x 278	361	200	406 x 305	396
9	205	417 x 313	406	225	457 x 343	445
10	228	463 x 347	451	250	508 x 381	495
11	251	509 x 382	497	275	558 x 419	544
12	273	556 x 417	542	300	609 x 457	594

Zoom Ratio: 1.1x

X1320WH/P1320W Series:

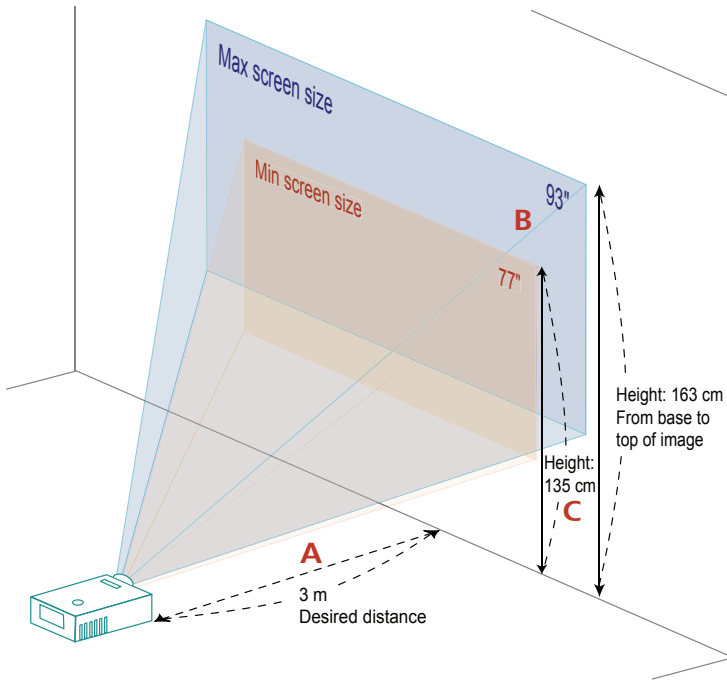

Desired distance (m) <A>	Screen size		Top	Screen size		Top
	(Min zoom)			(Max zoom)		
	Diagonal (inches) 	W (cm) x H (cm)	From base to top of image (cm) <C>	Diagonal (inches) 	W (cm) x H (cm)	From base to top of image (cm) <C>
1.5	39	83 x 52	68	46	100 x 63	81
2	52	111 x 69	90	62	133 x 83	108
2.5	64	139 x 87	113	77	167 x 104	135
3	77	167 x 104	135	93	200 x 125	163
3.5	90	194 x 122	158	108	233 x 146	190
4	103	222 x 139	181	124	267 x 167	217
4.5	116	250 x 156	203	139	300 x 188	244
5	129	278 x 174	226	155	333 x 208	271
6	155	333 x 208	271	186	400 x 250	325
7	181	389 x 243	316	217	467 x 292	379
8	206	444 x 278	361	248	533 x 333	433
9	232	500 x 313	406	279	600 x 375	488
10	258	556 x 347	451	310	667 x 417	542
11	284	611 x 382	497	340	733 x 458	596
12	310	667 x 417	542	371	800 x 500	650

Zoom Ratio: 1.2x

Adjusting distance and zoom to optimize image size

X1120H/X1220H/P1120/P1220 Series:

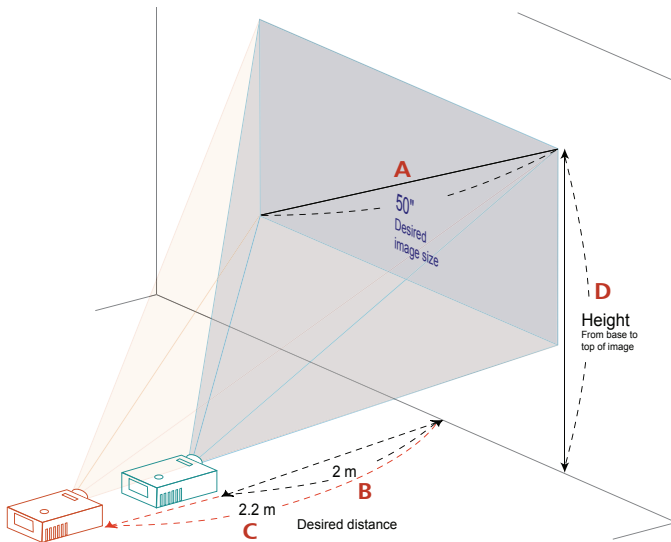

The table below shows how to achieve a desired image size by adjusting either the position or the zoom ring. Example: To obtain an image size of 50" set the projector at a distance between 2 m and 2.2 m from the screen and adjust the zoom level accordingly.

Desired image size		Distance (m)		Top (cm)
Diagonal (inches) <A>	W (cm) x H (cm)	Max zoom 	Min zoom <C>	From base to top of image <D>
30	61 x 46	1.2	1.3	59
40	81 x 61	1.6	1.8	79
50	102 x 76	2.0	2.2	99
60	122 x 91	2.4	2.6	119
70	142 x 107	2.8	3.1	139
80	163 x 122	3.2	3.5	158
90	183 x 137	3.6	4.0	178
100	203 x 152	4.0	4.4	198
120	244 x 183	4.8	5.3	238
150	305 x 229	6.0	6.6	297
180	366 x 274	7.2	7.9	357
200	406 x 305	8.0	8.8	396
250	508 x 381	10.0	11.0	495
300	610 x 457	12.0		594

Zoom Ratio: 1.1x

X1320WH/P1320W Series:

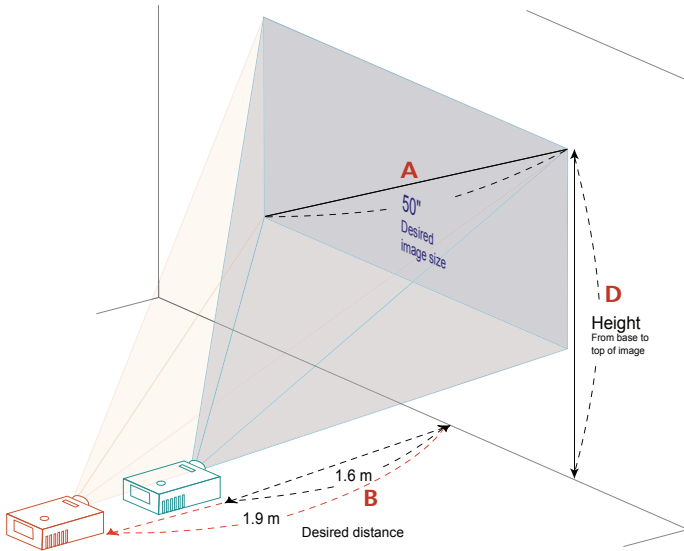

Desired image size		Distance (m)		Top (cm)
Diagonal (inches) <A>	W (cm) x H (cm)	Max zoom 	Min zoom <C>	From base to top of image <D>
30	65 x 40	1.0	1.2	53
40	86 x 54	1.3	1.6	70
50	108 x 67	1.6	1.9	88
60	129 x 81	1.9	2.3	105
70	151 x 94	2.3	2.7	123
80	172 x 108	2.6	3.1	140
90	194 x 121	2.9	3.5	158
100	215 x 135	3.2	3.9	175
120	258 x 162	3.9	4.7	210
150	323 x 202	4.8	5.8	263
180	388 x 242	5.8	7.0	315
200	431 x 269	6.5	7.8	350
250	538 x 337	8.1	9.7	438
300	646 x 404	9.7		525

Zoom Ratio: 1.2x

User controls

Installation menu

The installation menu provides an onscreen display (OSD) for projector installation and maintenance. Use this OSD only when the message *No signal input* is displayed on the screen.

The menu options include settings and adjustments for screen size and distance, focus, keystone correction and more.

- 1 Turn on the projector by pressing the **POWER** button on the control pad.
- 2 Press the **MENU** button on the control pad to launch the OSD for projector installation and maintenance.

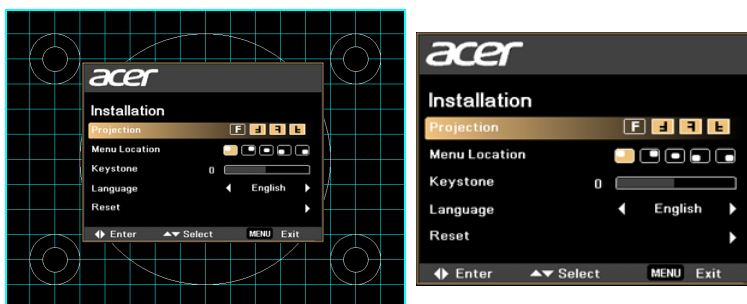

- 3 The background pattern acts as a guide for adjusting the calibration and alignment settings, such as screen size and distance, focus and more.
- 4 The Installation menu includes the following options:
 - Projection method
 - Menu location
 - Keystone settings
 - Language settings
 - Reset to factory defaults



Use the up and down arrow keys to select an option, the left and right arrow keys to adjust selected option settings, and the right arrow key to enter a feature settings submenu. The new settings will be saved automatically upon exiting the menu.

- 5 Push the **MENU** button anytime to exit the menu and return to the Acer welcome screen.

Acer Empowering Technology

Acer eView Management



The Acer Empowering  Key provides access to four Acer-specific functions: *Acer eView Management*, *Acer eTimer Management*, *Acer ePower Management*, and *Acer e3D Management*. Press the  key for more than one second to launch the onscreen display main menu to modify its function.

Press  to launch the *Acer eView Management* submenu.

Acer eView Management is for display mode selection. Please refer to "Onscreen Display Menus" on page 22 for more details.

Acer eTimer Management



Press  to launch *Acer eTimer Management* submenu.

Acer eTimer Management offers a reminder function for presentation time control. Please refer to "Onscreen Display Menus" on page 22 for more details.

Acer ePower Management



Press  to launch *Acer ePower Management*.

Acer ePower Management offers a shortcut to save lamp and projector life. Please refer to "Onscreen Display Menus" on page 22 for more details.

Acer e3D Management









Press  to launch *Acer e3D Management*. *Acer e3D Management* offers quick access to 3D functions. Please refer to "Onscreen Display Menu" on page 22 for more details.

Onscreen Display Menus

The projector has a multilingual OSD that allows you to make image adjustments and change a variety of settings.

Using the OSD menus

- To open the OSD menu, press **MENU** on the remote control.
- When the OSD is displayed, use the   keys to select any item in the main menu. After selecting the desired main menu item, press  to enter the feature settings submenu.
- Use the   keys to select the desired item and adjust the settings by using the   keys.
- Select the next item to be adjusted in the submenu and adjust as described above.
- Press **MENU** on the remote control to return to the main menu.
- To exit the OSD, press **MENU** on the remote control again. The OSD menu will close and the projector will automatically save the new settings.

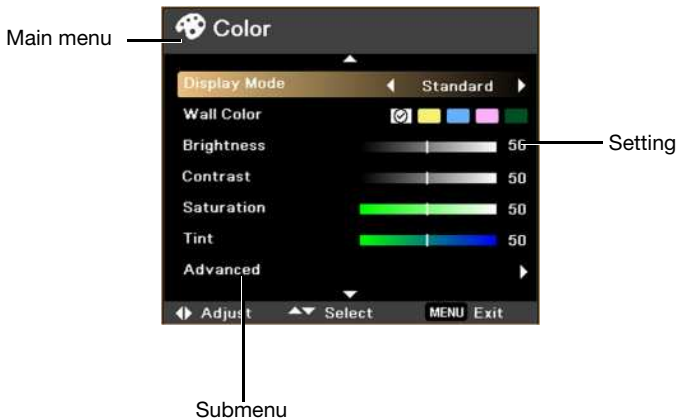

Color



Display Mode

There are many factory presets optimized for various types of image.

- Bright: For high brightness environments.
- Presentation: Higher brightness for meetings and presentations.
- Standard: For normal environments.
- Video: For playing video in a bright environment.
- Education: For education environment.
- Picture: For pictures.
- Game: For game content.
- User: User-adjustable to suit your environment.

Wall Color

Use this function to choose a proper color according to the wall. There are several choices, including white, light yellow, light blue, pink, dark green. The projector will compensate for color deviation due to the wall color to show the correct image tone.

Brightness

Adjust the brightness of the image.

- Press ◀ to darken image.
- Press ▶ to lighten the image.

Contrast

Contrast controls the difference between the lightest and darkest parts of the picture. Adjusting the contrast changes the amount of black and white in the image.

- Press ◀ to decrease the contrast.
- Press ▶ to increase the contrast.

Saturation

Adjusts a video image from black and white to fully saturated color.

- Press ◀ to decrease the amount of color in the image.
 - Press ▶ to increase the amount of color in the image.
-

Tint

Adjusts the color balance of red and green.

- Press ◀ to increase the amount of green in the image.
- Press ▶ to increase the amount of red in the image.

Advanced

Use this function to adjust advanced color settings.

- Color Temperature: Adjust the color temperature. At higher color temperatures, the screen looks colder; at lower color temperatures, the screen looks warmer.
- Degamma: Effects the representation of dark scenery. With greater gamma value, dark scenery will look brighter.
- Color R: Adjusts the red color.
- Color G: Adjusts the green color.
- Color B: Adjusts the blue color.
- Color C: Adjusts the cyan color.
- Color Y: Adjusts the yellow color.
- Color M: Adjusts the magenta color.



Note: *Saturation* and *Tint* are not supported under computer mode.

Image

**Projection**

- Front: The factory default setting.



- Ceiling: When you select this function, the projector inverts the image for ceiling-mounted projection.



- **Rear:** When you select this function, the projector reverses the image so you can project from behind a translucent screen.



- **Rear-Ceiling:** When you select this function, the projector reverses and inverts the image at same time. You can project from behind a translucent screen with ceiling mounted projection.

Aspect Ratio



Use this function to choose your desired aspect ratio.

- **Auto:** Keep the image with original width-high ratio and maximize the image to fit native horizontal or vertical pixels.
- **Full:** Keep the image with its original resolution, and resized to fit within the display area.
- **4:3:** The image will be scaled to fit the screen and displayed using a 4:3 ratio.
- **16:9:** The image will be scaled to fit the width of the screen and the height adjusted to display the image using a 16:9 ratio.
- **L.Box:** Keep original signal aspect ratio and zoom in by 1.333 times.



Keystone

Adjust image distortion caused by tilting the projector (± 40 degrees).





Sharpness



Adjusts the sharpness of the image.

- Press  to decrease the sharpness.
- Press  to increase the sharpness.

H. Position (horizontal position)

- Press  to move the image left.
- Press  to to move the image right.

V. Position (vertical position)

- Press  to move the image down.
- Press  to move the image up.

Frequency

Frequency changes the projector's refresh rate to match the frequency of your computer's graphics card. If you can see a vertical flickering bar in the projected image, use this function to make the necessary adjustments.

Tracking

Synchronizes the signal timing of the projector with the graphics card. If you experience an unstable or flickering image, use this function to correct it.

HDMI Color Range	<p>Adjust the color range of the HDMI image data to correct color display errors.</p> <ul style="list-style-type: none"> • Auto: Automatically adjust using information from the player. • Limited Range: Process the input image as limited color range data. • Full Range: Process the input image as full color range data.
HDMI Scan Info	<p>Adjust the overscan ratio of the HDMI image on screen.</p> <ul style="list-style-type: none"> • Auto: Automatically adjust using information from the player. • Underscan: Disable overscan on HDMI images. • Overscan: Enable overscan on HDMI images.



.....

Note: *L.Box* function is supported for X1320WH/P1320W series only.

Note: *H. Position*, *V. Position* and *Frequency* functions are not supported under Component video, Video, S-Video and HDMI modes.

Note: *Tracking* function is not supported under HDMI, Video and S-Video modes.

Note: The unsupported functions will be grayed out.

Setting



Menu Location Choose the menu location on the display screen.

Source Lock When source lock is turned **Off**, the projector will still lock the current source channel unless you press the **SOURCE** button on the remote control or control panel, it will search the input signal one cycle. When source lock is turned **On**, it will lock the current source channel unless you press the **SOURCE** button on the remote control or control panel to change the source, and it will only search the next source.

Startup Screen Use this function to select your desired startup screen. If you change the setting, the changes will take effect when you exit the OSD menu.

- Acer: The default Acer projector startup screen.
- User: Use a customized picture from the screen capture function.

Screen Capture

Use this function to customize the startup screen. To capture the image that you want to use as the startup screen, follow the instructions below.



Note: Before proceeding with the following steps, make sure that the Keystone is set to the default value 0 and the aspect ratio is set to 4:3. For details, refer to "Image" on page 24.

- Change the Startup Screen from the default setting (Acer) to User.
- Press **Screen Capture** to customize the startup screen.
- A message appears, stating that the screen capture is in progress.
- When the screen capture is finished, the message disappears and the original display is shown.
- The customized startup screen will take effect when there is a new input signal or when you restart the projector.

Screen capture in progress
Please wait



Note: This screen capture function is limited to the 4:3 aspect ratio only.

Note: For XGA models, to get best quality for your desired image, set the PC resolution to 1024 x 768 before you use this function.

Note: For SVGA models, to get best quality for your desired image, set the PC resolution to 800 x 600 before you use this function.

Note: For WXGA models, to get best quality for your desired image, set the PC resolution to 1280 x 800 before you use this function.

Closed Caption

Selects a preferred closed captioning mode from CC1, CC2, CC3, CC4, (CC1 displays captions in the primary language in your area). Select Off to turn off the captioning feature. This function is only available when a composite video or S-Video input signal is selected and its system format is NTSC.



Note: Set your screen aspect ratio to 4:3. This function is not available when the aspect ratio is 16:9, Auto, Full or L.Box.

Reset

Press the  button and choose **YES** to return the parameters on all menus to the factory default settings.

Security

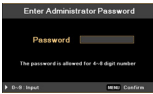

Security

This projector is equipped with a useful security function for the administrator to manage projector use.

Press **▶** to change the *Security* setting. If the security function is enabled, you must enter the Administrator Password first before changing the security settings.

- Select **On** to enable the security function. The user has to enter a password to operate the projector. Please refer to the User Password section for details.
- If **Off** is selected, then the user can turn on the projector without password.

Once the security function is enabled, the projector will request user to enter password when switch on the projector. Both User Password and Administrator Password can be used.



Timeout(Min.)

Once *Security* is activated, the administrator can set the timeout function.

- Press **◀** or **▶** to select the timeout interval.
- The range is from 10 minutes to 990 minutes.
- When the time is up, the projector will prompt the user to enter the password again.
- The factory default setting of *Timeout(Min.)* is **Off**.



User Password

- Press **▶** to set up or change the User Password.
- Use the number keys to set your password on the remote control and press **MENU** to confirm.
- Press **◀** to delete a character.
- Enter the password again when you see *Confirm Password* displayed.
- The password should be between four and eight characters long.
- If you select *Request password only after plugging power cord*, the projector will prompt the user to enter the password every time the power cord is plugged in.
- If you select *Always request password while projector turns on*, the user has to enter the password every time the projector is turned on.



Administrator Password

The Administrator Password can be used in both the *Enter Administrator Password* and *Enter Password* dialog boxes.



- Press  to change the Administrator Password.

- The default Administrator Password is 1234.

If you forgot your administrator password, do the following to retrieve the administrator password:

- Press **MENU** for more than four seconds when the *Enter Password* or *Enter Administrator Password* dialog box is currently displayed.
- Write down the Unlock ID and contact with Acer service center. They will give you a new Administrator Password according to the Unlock ID.

Lock User Startup Screen

- By default *Lock User Startup Screen* is **Off**. If *Lock User Startup Screen* is **On**, users cannot change the startup screen anymore.
 - Choose **Off** to unlock startup screen.
-

Management



ECO Mode Choose **On** to dim the projector lamp which will lower power consumption, extend the lamp life and reduce noise. Choose **Off** to return normal mode.

High Altitude Choose **On** to turn on *High Altitude* mode. Operate the fans at full speed continuously to allow for proper cooling of the projector.

Turn Off Mode

- **Instant Off:** Enables you to turn off the projector immediately, without fan cooling process, by pressing the power button twice.
- **Instant Resume:** Enables you to restart the projector immediately, without a two minute cool-down period.

Auto Shutdown The projector will automatically shutdown when there is no signal input after the allocated time (in minutes).

Lamp Hour Elapse Displays the lamp's elapsed operating time (in hours).

Lamp Reminding Activate this function to display a reminder to change the lamp 30 hours before its expected end-of-life.

Lamp Hour Reset Press the  button and choose **Yes** to reset the lamp hour counter to 0 hours.

Audio

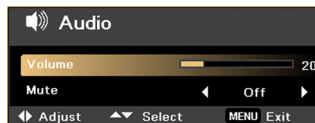

Volume

- Press  to decrease the volume.
- Press  to increase the volume.

- Mute
- Choose **On** to mute the volume.
 - Choose **Off** to restore the volume.

3D



- 3D
- Choose **On** to enable the 3D functions supported by TI DLP 3D technology. Choose this item when using DLP 3D glasses, a quad buffer (NVIDIA or ATI) graphics card and HQFS format file or DVD with corresponding SW player. Choose **Off** to turn off 3D mode.

- 3D Sync Invert
- If you see an blurred or overlapping image while wearing DLP 3D glasses, you may need to turn **On** *3D Sync Invert* to get the best match for left/right image sequencing to get a clear image. This function is only available while 3D is set to **On**.

- 3D Warning Message
- Choose **On** to display 3D warning message.
 - Choose **Off** to turn off 3D warning message.



Note: The correct settings on the graphics card 3D application program are needed for correct 3D display.

Note: Some software players, such as Stereoscopic Player and DDD TriDef Media Player can support 3D format files. You can download these three players from the pages below:

- NVIDIA Stereoscopic 3D Video Player:
www.nvidia.com/object/3D_Drivers_Downloads.html
- Stereoscopic Player (Trial): www.3dtv.at/Downloads/Index_en.aspx
- DDD TriDef Media Player (Trial):
www.tridef.com/download/latest.html

Note: There is a reminder screen if 3D is still enabled when the projector is turned on. Please adjust the setting depending on your purpose.



Note: 3D display is now enabled.

1. Please make sure you have the correct 3D signals and glasses.
2. Please remember to turn off 3D if you don't want to see 3D images.
3. If the 3D display isn't correct, please try to enable 3D Sync Invert.
4. Display mode options will be disabled while in 3D mode.

Language



Language

Choose the language for your OSD menu. Use the  or  key to select your preferred language.

Press  to confirm the selection.

3D projection

The Acer projector you have bought has integrated DLP 3D technology.



Important: When you turn the 3D technology on, you will be shown a reminder that 3D is enabled. If you do not wish to view 3D content, you should turn it off, otherwise the image may not be projected at full brightness.

Note: 3D display is now enabled.
 1. Please make sure you have the correct 3D signals and glasses.
 2. Please remember to turn off 3D if you don't want to see 3D images.
 3. If the 3D display isn't correct, please try to enable 3D Sync Invert.
 4. Display mode options will be disabled while in 3D mode.

Using DLP 3D technology

Before you can enjoy the benefits of the DLP 3D technology, you will need to do the following.

- 1 Ensure your graphics card supports 3D playback.



Note: Please refer to your graphics card's documentation.

- 2 Download and install the latest drivers for your graphics card.



Note: Please refer to your graphics card vendor's website for the latest driver version.

- 3 You should also download a suitable 3D player such as the one available from www.3dtv.at.



Note: You may need to purchase additional software.

- 4 Ensure you have the correct DLP-compatible 3D glasses.

Setting up a 3D environment

Once you have installed the drivers, you will need to set up the environment.

- 1 Set the refresh rate to **120 Hz** on your graphics card.
- 2 Press the menu button on the projector remote control to open the OSD.

- 3 Set 3D to **On**.



- 4 Alternatively, press  on your projector's remote control to open Acer e3D Management. From the 3D options, select **On**.



- 5 If you find that the 3D content is not displaying properly, try selecting **3D Sync Invert** from the projector OSD or Acer e3D Management.

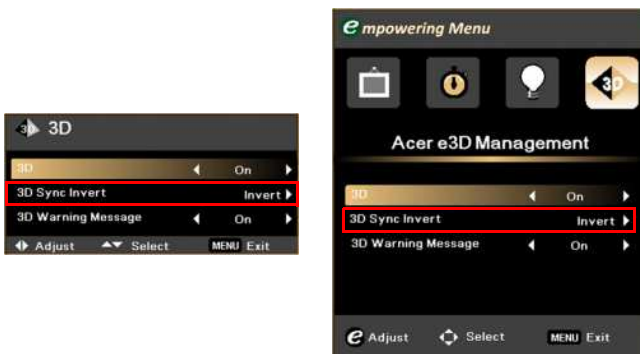



Important: If you have an NVIDIA graphics card and the NVIDIA 3D Vision drivers installed, you may need to disable the Stereoscopic feature to use the DLP 3D technology.

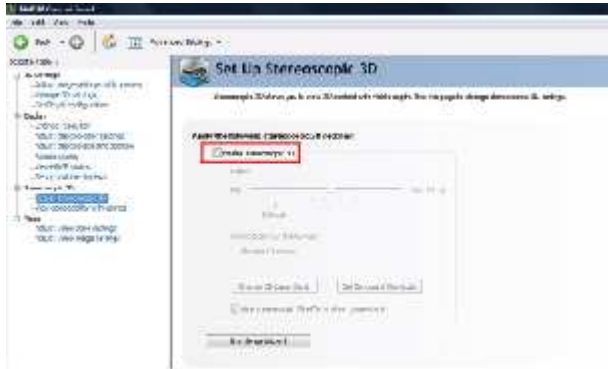

Using the stereoscopic player

You need to have a stereoscopic player in order to view 3D content. The instructions below explain how to view 3D content using the stereoscopic player that is available at www.3dTV.at. Other players may have different procedures.

- 1 Open the stereoscopic player and set the viewing method by going to **View > Viewing Method > Software pageflipping**.

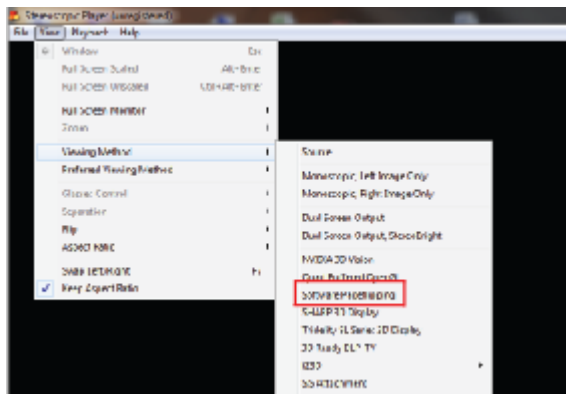

- 2 Open the 3D content in the player.



Note: You need to view content at fullscreen resolution in order to get the 3D effects.

Using 3D glasses (optional)

DLP 3D glasses are powered. In order to enhance battery life, they turn off after a few minutes of inactivity. Before you can view 3D content, you need to ensure the glasses are turned on. In many cases, there is a power switch on one of the arms that you can press, and an LED that indicates if the glasses are turned on or not.



Note: Refer to the documentation that came with your glasses for instructions how to turn them on and how to change the battery.

Watching 3D DVD content

If you have a DVD player that supports 3D playback, you can watch 3D DVD content using your Acer 3D-enabled projector. Connect your DVD player to the projector using any of the available input formats.

- 1 Press the **MENU** button on the projector remote control to open the OSD.
- 2 Set 3D to **On**.



- 3 Alternatively, press  on your projector's remote control to open Acer e3D Management. From the 3D options, select **On**.

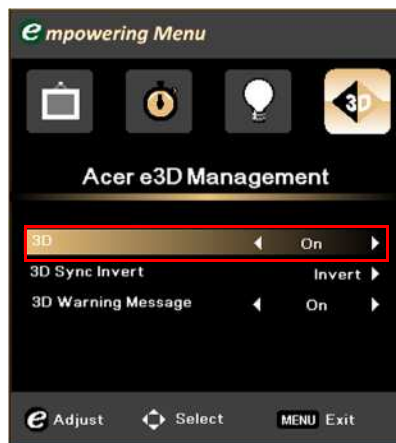

- 4 If you find that the 3D content is not displaying properly, try selecting **3D Sync Invert** from the projector OSD or Acer e3D Management.



Appendices

Troubleshooting

If you experience a problem with your Acer projector, refer to the following troubleshooting guide. If the problem persists, please contact your local reseller or service center.

Image problems and solutions

#	Problem	Solution
1	No image appears onscreen	<ul style="list-style-type: none"> • Ensure the projector is properly connected as described in "Getting started" on page 8. • Ensure none of the connector pins is bent or broken. • Check if the projector lamp has been securely installed. Please refer to "Replacing the lamp" on page 44.
2	Partial, scrolling or incorrectly displayed image [For PC (Windows 95/98/2000/XP)]	<ul style="list-style-type: none"> • Press RESYNC on the remote control. • For an incorrectly displayed image: <ul style="list-style-type: none"> • Open My Computer > Control Panel, and then double-click the Display icon. • Select the Settings tab. • Verify that your display resolution setting is lower than or equal to UXGA (1600 x 1200). <p>If the problem still appears, change the monitor display you are using and follow the steps below:</p> <ul style="list-style-type: none"> • Verify that the resolution setting is lower than or equal to UXGA (1600 x 1200). • Click the Change button under the Monitor tab. • Click Show all devices. Next, select Standard monitor types under the SP box, and choose the resolution mode you need under the Models box. • Verify that the resolution setting of the monitor display is lower than or equal to UXGA (1600 x 1200).
4	The screen of the notebook computer is not displaying your presentation	<ul style="list-style-type: none"> • If you are using a Microsoft Windows based notebook: Some notebook PCs may deactivate their own screens when a second display device is in use. Each has a different way to be reactivated. Refer to your computer's manual for detailed information. • If you are using an Apple Mac OS based notebook: In System Preferences, open Display and select Video Mirroring On.

4	Image is unstable or flickering	<ul style="list-style-type: none"> Adjust the Tracking to correct it. Refer to "Image" on page 24 for more information. Change the display color depth settings on your computer.
5	Image has vertical flickering bar	<ul style="list-style-type: none"> Use Frequency to make an adjustment. Refer to "Image" on page 24 for more information. Check and reconfigure the display mode of your graphics card to make it compatible with the projector.
6	Image is out of focus	<ul style="list-style-type: none"> Adjusts the focus ring on the projector lens. Make sure the projection screen is within the required distance from the projector. Refer to "Optimizing image size and distance" on page 12 for more information.
7	Image is stretched when displaying a widescreen DVD title	<p>When you play a DVD encoded in anamorphic or 16:9 aspect ratio you may need to adjust the following settings:</p> <ul style="list-style-type: none"> If you play a 4:3 format DVD title, please change the format to 4:3 in the projector OSD. If the image is still stretched, you will also need to adjust the aspect ratio. Set up the display format to 16:9 (wide) aspect ratio on your DVD player.
8	Image is too small or too large	<ul style="list-style-type: none"> Adjust the zoom ring on the front of the projector. Move the projector closer to or further from the screen. Press MENU on the remote control. Go to Image > Aspect Ratio and try different settings or press Aspect Ratio on the remote control to adjust directly.
9	Image has slanted sides	<ul style="list-style-type: none"> If possible, reposition the projector so that it is centered on the screen. Press the Keystone Δ / ∇ button on the remote control until the sides are vertical.
10	Image is reversed	<ul style="list-style-type: none"> Select Image > Projection on the OSD and adjust the projection direction.

Problems with the projector

#	Condition	Solution
1	The projector stops responding to all controls	If possible, turn off the projector, then unplug the power cord and wait at least 30 seconds before reconnecting power.

2	Lamp burns out or makes a popping sound	<ul style="list-style-type: none"> When the lamp reaches the end of its useful life, it will burn out and may make a loud popping sound. If this happens, the projector will not turn on until the lamp module has been replaced. To replace the lamp, please refer to "Replacing the lamp" on page 44.
---	---	---

OSD messages

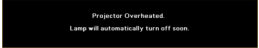
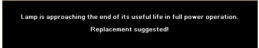
#	Condition	Message
1	Message	<p>Fan Fail - the system fan is not working.</p>  <p>Projector Overheated - the projector has exceeded its recommended operating temperature and must be allowed to cool down before it may be used.</p>  <p>Replace the lamp - the lamp is about to reach its maximum lifetime. Prepare to replace it soon.</p> 

LED and alarm definitions

LED indicators

Indicator	Power LED	Temp LED	Lamp LED
	Blue	Blue	Red
Power events			
Standby	V	--	--
Normal turn on mode	Flashing for 30 seconds after power on then steady blue	--	--
Download mode	V	Flashing	Flashing
Normal turn off mode	V	Solid on for 1 second	Solid on for 1 second
Turn on mode with cooling	Flashing for 15 seconds then steady blue	After 15 seconds then solid on for 45 seconds	After 15 seconds then solid on for 45 seconds
Lamp events			
Lamp ignition fail	V	--	Flashing
End of lamp lifetime	V	--	V
Thermal events			
Temperature error	V	Flashing	--
Fan error	V	V	--
Color wheel or DMD error	V	Flashing	Flashing

Replacing and cleaning the dust filter

- 1 Turn the projector off then unplug the power cord.
- 2 Pull the dust filter out (Illustration #1).
- 3 Clean or replace the dust filter.
- 4 To put the dust filter back, reverse the previous steps.

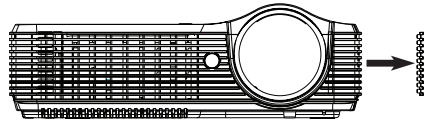

(Illustration #1)

Cleaning the dust filter

Clean the dust filter after every 1000 hours of use. If it is not cleaned periodically, it can become clogged with dust, preventing proper ventilation. This can cause overheating and damage the projector. (Normally 1000 hours is recommended, however the period will vary depending on actual environment.)

Please follow these steps for cleaning procedure:

- 1 To clean the dust filter, use a small vacuum cleaner designed for computers and other office equipment. It also can be cleaned using water. (Illustration #2)
- 2 If the dirt is difficult to remove or the filter is broken, please contact your local dealer or service center to obtain a new filter.

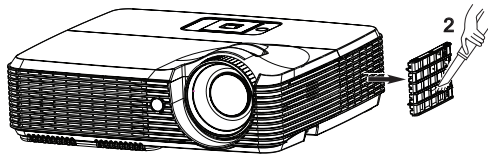

Dust Filter

(Illustration #2)

Replacing the lamp

The projector will detect the lamp life. You will be shown a warning message: **Lamp is approaching the end of its useful life in full power operation. Replacement Suggested!** When you see this message, change the lamp as soon as possible. Make sure the projector has cooled down for at least 45 minutes before changing the lamp.



.....

Warning! Do not attempt to replace the lamp yourself. Contact the qualified service personnel for replacement.

Warning! The lamp compartment is hot! Allow it to cool down before changing the lamp.

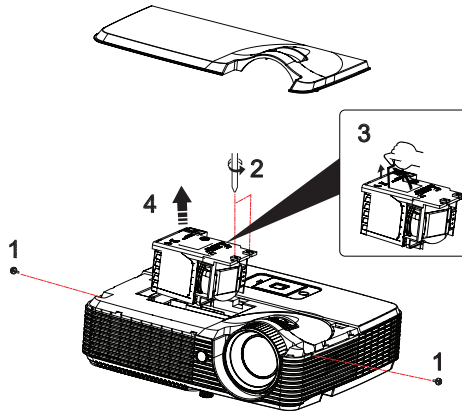

To change the lamp:

- 1 Turn off the projector by pressing the **Power** button.
- 2 Allow the projector at least 45 mins to cool down.
- 3 Disconnect the power cord.
- 4 Use a screwdriver to remove the screws on the two sides of the cover (Illustration #1).
- 5 Push up and remove the cover.
- 6 Remove the two screws that secure the lamp module (Illustration #2) and pull up the lamp bar (Illustration #3).
- 7 Pull out the lamp module (Illustration #4).

To replace the lamp module, reverse the previous steps.



.....

Warning! To reduce the risk of personal injury, do not drop the lamp module or touch the lamp bulb. The bulb may shatter and cause injury if it is dropped.

Ceiling mount installation

If you wish to install the projector using a ceiling mount, please refer to the steps below:

- 1 Drill four holes into a solid, structurally sound part of the ceiling, and secure the mount base.

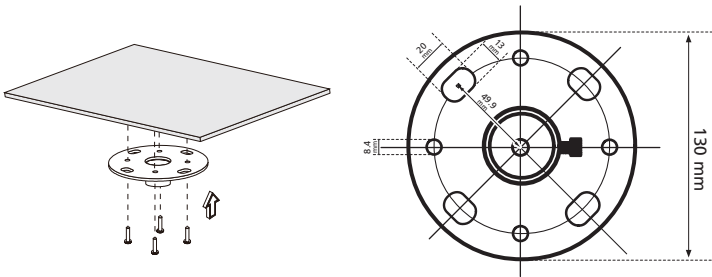

Note: Screws are not included. Please obtain the appropriate screws for your type of ceiling.

- 2 Secure the ceiling rod using the appropriate type of four-cylinder screws.

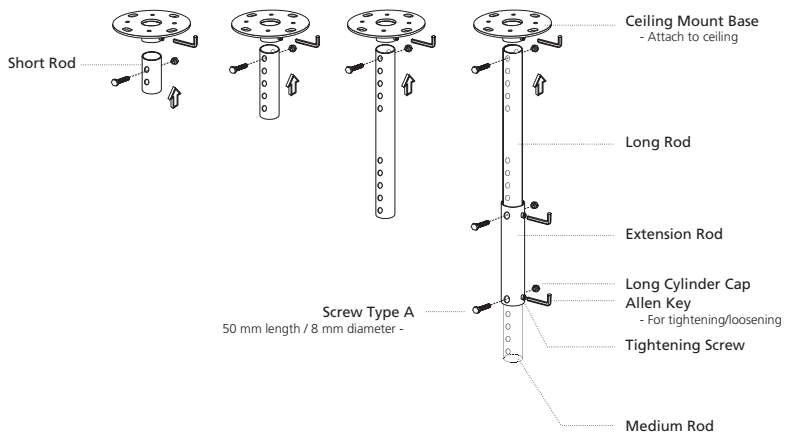

- 3 Use the appropriate number of screws for the projector size to attach the projector to the ceiling mount bracket.

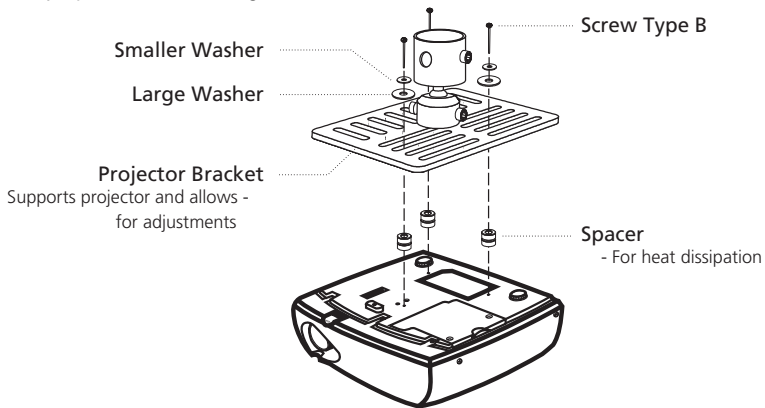

Note: It is recommended that you keep a reasonable space between the bracket and the projector to allow for proper heat distribution. Use two washers for extra support, if deemed necessary.

- 4 Attach the ceiling bracket to the ceiling rod.

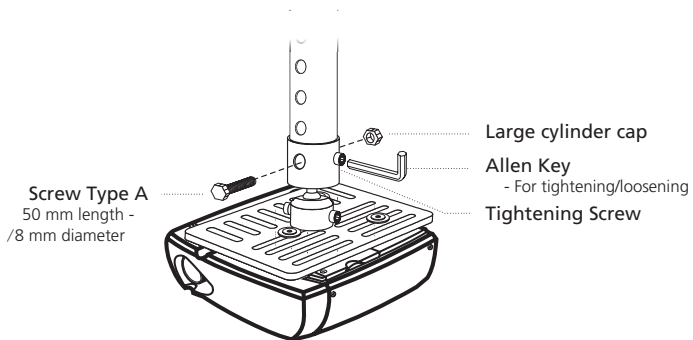

- 5 Adjust the angle and positioning as necessary.

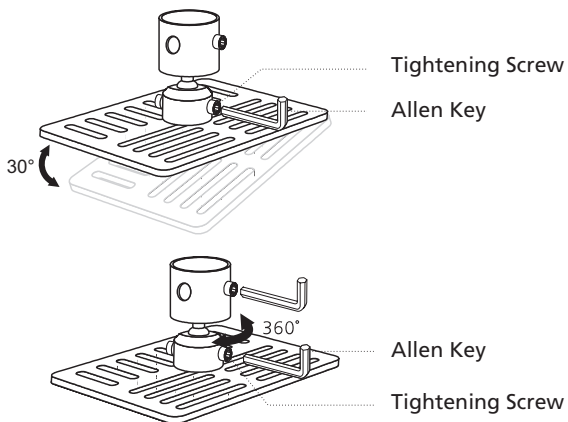

Note: The appropriate type of screw and washer for each model is listed in the table below. 3 mm diameter screws are enclosed in the screw pack.

Models	Screw Type B		Washer Type	
	Diameter (mm)	Length (mm)	Large	Small
X1120H/ X1220H/ X1320WH/ P1120/P1220/ P1320W	4	8	V	V

SCREW SPEC. M4 x 8 mm

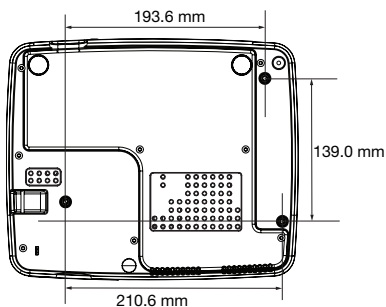

Specifications

The specifications listed below are subject to change without notice. For final specs, please refer to Acer's published marketing specifications.

Projection system	DLP®
Resolution	X1120H/P1120: Native SVGA (800 x 600), Maximum: UXGA (1,600 x 1,200), 1080p (1920 x 1080) X1220H/P1220: Native: XGA (1024 x 768), Maximum: UXGA (1,600 x 1,200), 1080p (1920 x 1080) X1320WH/P1320W: Native: WXGA (1280 x 800), Maximum: UXGA (1,600 x 1,200), 1080p (1920 x 1080)
Computer compatibility	IBM PC and compatibles, Apple Macintosh, iMac and VESA standards: SXGA, XGA, VGA, SVGA, SXGA+, WXGA, WXGA+, WSXGA +
Video compatibility	NTSC, PAL, SECAM Component 720p 1080i 1080p
Aspect ratio	X1120H/X1220H/P1120/P1220: Native 4:3 X1320WH/P1320W: Native 16:10
Displayable colors	16.7 million colors
Projection lens	X1120H/X1220H/P1120/P1220: F/ 1.97 - 2.17, 1.1X manual zoom lens X1320WH/P1320W: F/ 1.47 - 1.83, 1.2X manual zoom lens
Projection screen size (diagonal)	X1120H/X1220H/P1120/P1220: 27" - 250" X1320WH/P1320W: 30" - 315"
Projection distance	X1120H/X1220H/P1120/P1220: 1.2 m - 10 m X1320WH/P1320W: 1.2 m - 10 m
Throw ratio	X1120H/X1220H/P1120/P1220: 1.97 - 2.17 X1320WH/P1320W: 1.47 - 1.83
Horizontal scan rate	30k - 100 kHz
Vertical refresh scan rate	50 - 120 Hz
Lamp type	180 W user-replaceable lamp
Keystone correction	± 40 degrees
Audio	Internal speaker with 2 W output
Weight	2.3 kg (5.0 lbs.)
Dimensions (W x D x H)	289.3 x 234.5 x 92.3 mm (11.4" x 9.2" x 3.6")
Digital zoom	2X
Power supply	AC input 100 - 240 V auto-switching power supply
Power consumption	245 W (max.)
Operating temperature	5° C to 35° C / 41° F to 95° F

I/O connectors	<ul style="list-style-type: none">• Power socket• VGA input x2• Mini-B USB• RS-232• Composite video• S-Video• VGA output• 3.5 mm audio jack input• 3.5 mm audio jack output• HDMI
Standard package contents	<ul style="list-style-type: none">• Power cord• VGA cable• Remote control• Batteries (for remote control)• User's Manual CD• Quick Start Guide• Carrying case (optional)• Screw pack• Dust filter (optional)

* Design and specifications are subject to change without notice.

Compatibility modes

A. VGA analog

1 VGA analog - PC signal

Modes	Resolution	V. Frequency [Hz]	H. Frequency [kHz]
VGA	640 x 480	60	31.47
	640 x 480	72	37.86
	640 x 480	75	37.50
	640 x 480	85	43.27
	640 x 480	119.51	61.60
SVGA	800 x 600	56	35.20
	800 x 600	60	37.88
	800 x 600	72	48.08
	800 x 600	75	46.88
	800 x 600	85	53.67
XGA	800 x 600	119.85	77.20
	1024 x 768	60	48.36
	1024 x 768	70	56.48
	1024 x 768	75	60.02
	1024 x 768	85	68.67
SXGA	1024 x 768	119.804	98.80
	1152 x 864	70	63.80
	1152 x 864	75	67.50
	1152 x 864	85	77.10
	1280 x 1024	60	63.98
QuadVGA	1280 x 1024	72	77.90
	1280 x 1024	75	79.98
	1280 x 1024	85	91.15
	1280 x 960	60	60.00
SXGA+	1280 x 960	75	75.00
	1400 x 1050	60	65.32
UXGA	1400 x 1050	75	82.00
	1600 x 1200	60	75.00
PowerBook G4	640 x 480	60	31.50
	640 x 480	66.6 (67)	35.00
	800 x 600	60	37.88
	1024 x 768	60	48.36
	1152 x 870	75	68.68
	1280 x 960	75	75.20
i Mac DV (G3)	1024 x 768	75	60.30

2 VGA analog - Extended wide timing

Modes	Resolution	V. Frequency [Hz]	H. Frequency [kHz]
WXGA	1280 x 768	60	47.78
	1280 x 768	75	60.29
	1280 x 768	85	68.63
	1280 x 720	60	44.80
	1280 x 720	75	56.00
	1280 x 720	85	64.00
	1280 x 800	60	49.60
	1280 x 800	75	62.00
	1440 x 900	60	55.90
	1680 x 1050	60	65.30
	1366 x 768	60	47.71
	1920 x 1080-RB	60	66.60
	1024 x 600	60	37.30

3 VGA analog - Component signal

Modes	Resolution	V. Frequency [Hz]	H. Frequency [kHz]
480i	720 x 480	59.94 (29.97)	27.00
480p	720 x 480	59.94	31.47
576i	720 x 576	50 (25)	27.00
576p	720 x 576	50	31.25
720p	1280 x 720	60	45.00
720p	1280 x 720	50	37.50
1080i	1920 x 1080	60 (30)	33.75
1080i	1920 x 1080	50 (25)	33.75
1080p	1920 x 1080	60	67.50
1080p	1920 x 1080	50	56.26
Horizontal scan rate:		30k-100 kHz	
Vertical scan rate:		50-120 Hz	

B. HDMI digital

1 HDMI - PC signal

Modes	Resolution	V. Frequency [Hz]	H. Frequency [kHz]
VGA	640 x 480	60	31.47
	640 x 480	72	37.86
	640 x 480	75	37.50
	640 x 480	85	43.27
	640 x 480	119.51	61.60
SVGA	800 x 600	56	35.20
	800 x 600	60	37.88

	800 x 600	72	48.08
	800 x 600	75	46.88
	800 x 600	85	53.67
	800 x 600	119.85	77.20
XGA	1024 x 768	60	48.36
	1024 x 768	70	56.48
	1024 x 768	75	60.02
	1024 x 768	85	68.67
	1024 x 768	119.804	98.80
SXGA	1152 x 864	70	63.80
	1152 x 864	75	67.50
	1152 x 864	85	77.10
	1280 x 1024	60	63.98
	1280 x 1024	72	77.90
	1280 x 1024	75	79.98
	1280 x 1024	85	91.15
QuadVGA	1280 x 960	60	60.00
	1280 x 960	75	75.00
	1280 x 960	85	86.00
SXGA+	1400 x 1050	50	54.00
	1400 x 1050	60	65.32
	1400 x 1050	75	82.00
UXGA	1600 x 1200	60	75.00

2 HDMI - Extended wide timing

Modes	Resolution	V. Frequency [Hz]	H. Frequency [kHz]
WXGA	1280 x 768	60	47.78
	1280 x 768	75	60.29
	1280 x 768	85	68.63
	1280 x 720	60	44.80
	1280 x 720	75	56.00
	1280 x 720	85	64.00
	1280 x 800	60	49.60
	1280 x 800	75	62.00
	1440 x 900	60	55.90
	1680 x 1050	60	65.30
	1366 x 768	60	47.71
	1920 x 1080-RB	60	66.60
	1024 x 600	60	37.30

3 HDMI - Video signal

Modes	Resolution	V. Frequency [Hz]	H. Frequency [kHz]
480i	720 x 480	59.94 (29.97)	27.00
480p	720 x 480	59.94	31.47
576i	720 x 576	50 (25)	27.00
576p	720 x 576	50	31.25
720p	1280 x 720	60	45.00
720p	1280 x 720	50	37.50
1080i	1920 x 1080	60 (30)	33.75
1080i	1920 x 1080	50 (25)	33.75
1080p	1920 x 1080	60	67.50
1080p	1920 x 1080	50	56.26
Horizontal scan rate:		30k-100 kHz	
Vertical scan rate:		50-120 Hz	

Regulations and safety notices

FCC notice

This device has been tested and found to comply with the limits for a Class B digital device pursuant to Part 15 of the FCC rules. These limits are designed to provide reasonable protection against harmful interference in a residential installation. This device generates, uses, and can radiate radio frequency energy and, if not installed and used in accordance with the instructions, may cause harmful interference to radio communications.

However, there is no guarantee that interference will not occur in a particular installation. If this device does cause harmful interference to radio or television reception, which can be determined by turning the device off and on, the user is encouraged to try to correct the interference by one or more of the following measures:

- Reorient or relocate the receiving antenna.
- Increase the separation between the device and receiver.
- Connect the device into an outlet on a circuit different from that to which the receiver is connected.
- Consult the dealer or an experienced radio/television technician for help.

Notice: Shielded cables

All connections to other computing devices must be made using shielded cables to maintain compliance with FCC regulations.

Notice: Peripheral devices

Only peripherals (input/output devices, terminals, printers, etc.) certified to comply with the Class B limits may be attached to this equipment. Operation with non-certified peripherals is likely to result in interference to radio and TV reception.

Caution

Changes or modifications not expressly approved by the manufacturer could void the user's authority, which is granted by the Federal Communications Commission, to operate this device.

Operation conditions

This device complies with Part 15 of the FCC Rules. Operation is subject to the following two conditions: (1) this device may not cause harmful interference, and (2) this device must accept any interference received, including interference that may cause undesired operation.

Notice: Canadian users

This Class B digital apparatus complies with Canadian ICES-003.

Remarque à l'intention des utilisateurs canadiens

Cet appareil numérique de la classe B est conforme à la norme NMB-003 du Canada.

Declaration of Conformity for EU countries

Acer hereby declares that this projector series is in compliance with the essential requirements and other relevant provisions of Directive 1999/5/EC.

Compliant with Russian regulatory certification



ME61

Radio device regulatory notice



.....

Note: The regulatory information below is for models with wireless LAN and/or Bluetooth only.

General

This product complies with the radio frequency and safety standards of any country or region in which it has been approved for wireless use. Depending on configurations, this product may or may not contain wireless radio devices (such as wireless LAN and/or Bluetooth modules).

Canada — Low-power license-exempt radio communication devices (RSS-210)

- a Common information
 - Operation is subject to the following two conditions:
 1. This device may not cause interference, and
 2. This device must accept any interference, including interference that may cause undesired operation of the device.
- b Operation in 2.4 GHz band
 - To prevent radio interference to the licensed service, this device is intended to be operated indoors and installation outdoors is subject to licensing.

List of applicable countries

This device must be used in strict accordance with the regulations and constraints in the country of use. For further information, please contact the local office in the country of use. Please see <http://ec.europa.eu/enterprise/rtte/implem.htm> for the latest country list.



Acer Incorporated
8F, 88, Sec. 1, Xintai 5th Rd. Xizhi, New
Taipei City 221, Taiwan



Declaration of Conformity

We,

Acer Incorporated

8F, 88, Sec. 1, Xintai 5th Rd. Xizhi, New Taipei City 221, Taiwan, R.O.C.

Contact Person: Mr. Easy Lai, e-mail:easy_lai@acer.com.tw

And,

Acer Italy s.r.l.

Via Lepetit, 40, 20020 Lainate (MI) Italy

Tel: +39-02-939-921, Fax: +39-02 9399-2913, www.acer.it

Hereby declare that:

Trade Name:
Model Number:
Machine Type:

Product: Projector
Acer
FSV1101/FNX1102/FWX1103
X1120H/X1220H/X1320WH
P1120/P1220/P1320W
D401D/D411D/D421D
EV-S32H/EV-X32H/EV-W32H series

Is compliant with the essential requirements and other relevant provisions of the following EC directives, and that all the necessary steps have been taken and are in force to assure that production units of the same product will continue comply with the requirements.

EMC Directive 2004/108/EC as attested by conformity with the following harmonized standards:

- EN55022, AS/NZS CISPR22, Class B
- EN55024
- EN61000-3-2 Class A
- EN61000-3-3

Low Voltage Directive 2006/95/EC as attested by conformity with the following harmonized standard:

- EN60950-1

RoHS Directive 2002/95/EC on the Restriction of the Use of certain Hazardous Substances in Electrical and Electronic Equipment

- The maximum concentration values of the restricted substances by weight in homogenous material are:

Lead	0.1%	Polybrominated Biphenyls (PBB's)	0.1%
Mercury	0.1%	Polybrominated Diphenyl Ethers (PBDE's)	0.1%
Hexavalent Chromium	0.1%	Cadmium	0.01%

Directive 2005/32/EC of the European Parliament and of the Council with regard to Eco-design Requirements.

acer

Acer Incorporated
8F, 88, Sec. 1, Xintai 5th Rd. Xizhi, New
Taipei City 221, Taiwan

The standards listed below are applied to the product if built with WLAN module or wireless keyboard and mouse.



R&TTE Directive 1999/5/EC as attested by conformity with the following harmonized standard:

● **Article 3.1(a) Health and Safety**

- EN60950-1
- EN62311

● **Article 3.1(b) EMC**

- EN301 489-1
- EN301 489-17

● **Article 3.2 Spectrum Usages**

- EN300 328
- EN301 893 (Applicable to 5GHz high performance RLAN).

Year to begin affixing CE marking 2011.

Easy Lai

Easy Lai / Manager
Regulation Center, Acer Inc.

Jun. 30, 2011 -

Date



Acer America Corporation

333 West San Carlos St., San Jose
CA 95110, U. S. A.
Tel : 254-298-4000
Fax : 254-298-4147
www.acer.com



Federal Communications Commission Declaration of Conformity

This device complies with Part 15 of the FCC Rules. Operation is subject to the following two conditions: (1) this device may not cause harmful interference, and (2) this device must accept any interference received, including interference that may cause undesired operation.

The following local Manufacturer / Importer is responsible for this declaration:

Product:	DLP Projector
Model Number:	FSV1101/FNX1102/FWX1103
Machine Type:	X1120H/X1220H/X1320WH P1120/P1220/P1320W D401D/D411D/D421D EV-S32H/EV-X32H/EV-W32H series
Name of Responsible Party:	Acer America Corporation
Address of Responsible Party:	333 West San Carlos St. San Jose, CA 95110 U. S. A.
Contact Person:	Acer Representative
Phone No.:	254-298-4000
Fax No.:	254-298-4147