



LG

Life's Good

OWNER'S MANUAL DLP PROJECTOR

Please read this manual carefully before operating your set and retain it for future reference.

HS200
HS200G
HS201
HS201G

DLP PROJECTOR

Warning

This is a class B product. In a domestic environment this product may cause radio interference, in which case the user may be required to take adequate measures.

CE 0983 ⓘ

This projector complies with EMC Directive and R&TTE Directive.

AT	DE	DK	ES	FI
FR	GB	IT	NL	PL
PT	SE			

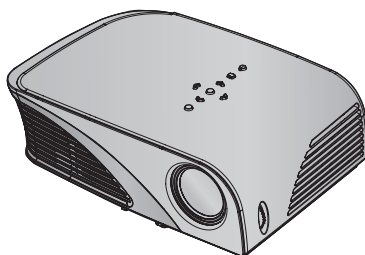

Contents

Safety Instructions	4
Names of parts	
Main Body	7
Control Panel.....	7
Connecting Part.....	8
Remote Control	9
Installing Batteries	9
Accessories	10
Optional Extras	10
Installing and Composition	
Installation Precautions	11
Basic Operation of the Projector	12
How to install the projector using the tripod.....	13
Kensington Security System	13
Turning on the Projector.....	14
Turning off the Projector.....	14
Focus and Position of the Screen Image	14
Selecting input mode.....	14
Connection	
Connecting to a Desktop PC.....	15
Connecting to a Video Source	15
Connecting to a DVD Player	16
Connecting to a D-TV Set-Top Box.....	16
Function	
PICTURE Menu Options	
Picture mode	17
Adjusting Picture Mode	17
Picture Reset Function	18
Advanced Control Function.....	18
SCREEN Menu Options	
To Change PJT Mode	20
Using Aspect Ratio Function	20
Using Keystone Function	20
Auto Configure Function.....	21
RGB Config. Function	21
Using the Still Function	21
AUDIO Menu Options	
What is FM Wireless Audio? (HS200/HS200G only)	22
Installing Instructions (HS200/HS200G Only).....	23
What do I do if the FM receiving signal is not good? (HS200/HS200G Only).....	23
To listen through the FM receiver speaker (HS200/HS200G Only).....	24
Adjusting Volume.....	24
Adjusting Speaker Balance	25
Adjusting Treble.....	25
TIME Menu Options	
Sleep time Function.....	26
Auto Off Function	26
OPTION Menu Options	
Selecting Language.....	26
Using Blank Function	27
Selecting Blank image.....	27
Screen Capture Function	27
To adjust the brightness of the screen	28
To set the button light.....	28
To make the power of the projector turn on automatically when power is in	28
INFORMATION Menu Options	
To See The Projector Information	29
Demo Mode Function.....	29
Initial Setting Function	29
USB	
To use the USB device	
Connecting the USB device	30
Eject USB	30
Precautions when using the USB device	30
PHOTO List	
Screen Components.....	31
Photo Selection and Popup Menu.....	31
Full Screen Menu	32
MUSIC List	
Screen Components.....	33
Music Selection and Popup Menu.....	34
MOVIE List	
Supported Movie File	35
Precautions when playing the DivX	35
Screen Components.....	36
Movie Selection and Popup Menu	36
Playing the Movie	37
Option Menu Selection.....	37
To See The DivX Registration Code	38
Deactivation Function.....	38
Information	
Supported Monitor Display	39
Maintenance	40
How To Attach The Lens Cap To The Projector	40
Memo.....	41
Specifications	43





Disposal of your old appliance

1. When this crossed-out wheeled bin symbol is attached to a product it means the product is covered by the European Directive 2002/96/EC.
2. All electrical and electronic products should be disposed of separately from the municipal waste stream via designated collection facilities appointed by your government or your local authorities.
3. The correct disposal of your old appliance will help prevent potential negative consequences for the environment and human health.
4. For more detailed information about disposal of your old appliance, please contact your city office, waste disposal service or the shop where you purchased the product.

Safety Instructions

Please take note of the safety instructions to prevent any potential accident or misuse of the projector.

- Safety Instructions are given in two forms as detailed below.
-  **WARNING** : The violation of this instruction may cause serious injuries and even death.
-  **NOTES** : The violation of this instruction may cause injuries or damage to the projector.
- After reading this manual, keep it in the place that you can access easily.

Indoor Installation **WARNING**

<p>Do not place the Projector in direct sunlight or near heat sources such as radiators, fires, stove etc.</p> <p>This may cause a fire hazard !</p>	<p>Do not place flammable materials in, on or near the projector</p> <p>This may cause a fire hazard!</p>	<p>Do not hang on the installed projector.</p> <p>It may cause the projector to fall, causing injury or death.</p>
--	---	--

<p>Do not block the vents of the projector or restrict air-flow in any way.</p> <p>This would cause the internal temperature to increase and could cause a fire hazard or damage to the unit!</p>	<p>Do not place the projector close to sources of steam or oil such as a humidifier.</p> <p>This may create a fire hazard or an electric shock hazard!</p>	<p>Do not place the projector where it might be exposed to dust.</p> <p>This may cause a fire hazard or damage to the unit!</p>
---	--	---

<p>Do not use the projector in a damp place such as a bathroom where it is likely to get wet.</p> <p>This may cause a fire or an electric shock hazard !</p>	<p>Do not place the projector directly on a carpet, rug or place where ventilation is restricted.</p> <p>This would cause its internal temperature to increase and might create a fire hazard or damage the unit.</p>	<p>Ensure good ventilation around the projector. The distance between the projector and the wall should be more than 30cm/12 inches.</p> <p>An excessive increase in its internal temperature may cause a fire hazard or damage to the unit!</p>
--	---	--

Indoor Installation **NOTES**

<p>When installing the projector on a table, be careful not to place it near the edge.</p> <p>The projector could fall causing injury and damage to the projector. Only use a suitable stand.</p>	<p>Disconnect from the power supply and remove all connections before moving, or cleaning.</p>	<p>Only use the projector on a level and stable surface.</p> <p>It may fall and cause injury and/or damage to the unit.</p>
--	--	---

Power **WARNING**

<p>Earth wire should be connected.</p> <p>Ensure that you connect the earth ground wire to prevent possible electric shock (i.e. a Projector with a three-prong grounded AC plug must be connected to a three-prong grounded AC outlet). If grounding methods are not possible, have a qualified electrician install a separate circuit breaker. Do not try to ground the unit by connecting it to telephone wires, lightening rods, or gas pipes.</p>	<p>The power cord should be inserted fully into the power outlet to avoid a fire hazard!</p> <p>This may cause a fire hazard or damage the unit.</p>	<p>Do not place heavy objects on the power cord.</p> <p>This may cause a fire or an electric shock hazard !</p>
--	--	---

Power	⚠ WARNING	
<p>Never touch the power plug with a wet hand.</p> <p>This may cause an electric shock hazard!</p>	<p>Do not plug-in too many items into one power outlet.</p> <p>It may result in overheating of the outlet and create a fire hazard!</p>	<p>Prevent dust from collecting on the power plug pins or outlet.</p> <p>This may cause a fire hazard!</p>

Power	⚠ NOTES	
<p>Hold the plug firmly when unplugging. If you pull the cord, it may be damaged.</p> <p>This may cause a fire hazard!</p>	<p>Do not use if the power cord or the plug is damaged or any part of the power outlet is loose.</p> <p>This may cause a fire or an electric shock hazard or damage to the unit!</p>	<p>Ensure the power cord does not come into contact with sharp or hot objects.</p> <p>This may cause a fire or an electric shock hazard or damage to the unit!</p>
<p>Place the projector where people will not trip or tread on the power cord.</p> <p>This may cause a fire or an electric shock hazard or damage to the unit!</p>	<p>Do not turn the projector On/Off by plugging-in or unplugging the power plug to the wall outlet. (Allow the unit to cool before removing power.)</p> <p>It may cause mechanical failure or could cause an electric shock.</p>	

Using	⚠ WARNING	
<p>Do not place anything containing liquid on top of the projector such as flowerpot, cup, cosmetics or candle.</p> <p>This may cause a fire hazard or damage to the unit!</p>	<p>In case of impact shock or damage to the projector switch it off and unplug it from the power outlet and contact an authorized service center.</p> <p>This may cause a fire or an electric shock hazard or damage to the unit!</p>	<p>Do not allow any objects to fall into the projector.</p> <p>This may cause an electric shock hazard or damage to the unit!</p>
<p>If water is spilt into the projector unplug it from the power supply immediately and consult your Service Agent.</p> <p>This may cause an electric shock hazard or damage to the unit!</p>	<p>Dispose of used batteries carefully and safely.</p> <p>In the case of a battery being swallowed by a child please consult a doctor immediately.</p>	
<p>Do not remove any covers. High risk of Electric Shock!</p>	<p>Don't look directly into the lens when the projector is in use. Eye damage may occur!</p>	<p>Do not touch metal parts during or soon after operation since the vents will remain very hot!</p>

CAUTION concerning the Power Cord

It is recommend that most appliances be placed on a dedicated circuit; that is, a single outlet circuit which powers only that appliance and has no additional outlets or branch circuits. Check the specification page of this owner's manual to be certain.

Do not overload wall outlets. Overloaded wall outlets, loose or damaged wall outlets, extension cords, frayed power cords, or damaged or cracked wire insulation are dangerous. Any of these conditions could result in electric shock or fire. Periodically examine the cord of your appliance, and if its appearance indicates damage or deterioration, unplug it, discontinue use of the appliance, and have the cord replaced with an exact replacement part by authorized service personnel.

Protect the power cord from physical or mechanical abuse, such as being twisted, kinked, pinched, closed in a door, or walked upon. Pay particular attention to plugs, wall outlets, and the point where the cord exits the appliance.

Using	⚠ WARNING	
<p>If the projector is in a room that experiences a gas leak, do not touch the projector.</p> <p>It can cause a fire or a burn by a spark.</p>	<p>Don't look at the laser beam directly as it can cause eye damage!</p>	<p>Always open the lens door or remove the lens cap when the projector lamp is on.</p>

Using	⚠ NOTES	
<p>Do not place heavy objects on top of projector.</p> <p>This may cause mechanical failure or personal injury!</p>	<p>Take care not to impact the lens particularly when moving the projector.</p>	<p>Do not touch the lens of the projector. It is delicate and easily damaged.</p>
<p>Do not use any sharp tools on the projector as this will damage the casing.</p>	<p>In the event that an image does not appear on the screen please switch it off and unplug it from the power outlet and contact your Service Agent.</p> <p>This may cause a fire or an electric shock hazard or damage to the unit!</p>	<p>Do not drop the projector or allow impact shock.</p> <p>This may cause mechanical failure or personal injury!</p>

Cleaning	⚠ WARNING	
<p>Do not use water while cleaning the projector.</p> <p>This may cause damage to the projector or an electric shock hazard.</p>	<p>In the unlikely event of smoke or a strange smell from the projector, switch it off, unplug it from the wall outlet and contact your dealer or service center.</p> <p>This may cause a fire or an electric shock hazard or damage to the unit!</p>	<p>Use an air spray or soft cloth that is moist with a neutral detergent and water for removing dust or stains on the projection lens.</p>

Cleaning	⚠ NOTES	
<p>Contact the Service Center once a year to clean the internal parts of the projector.</p> <p>Accumulated dust can cause mechanical failure.</p>	<p>When cleaning the plastic parts such as projector case, unplug the power and wipe it with a soft cloth. Do not use cleanser, spray water or wipe with a wet cloth. Especially, never use cleanser (glass cleaner), automobile or industrial shiner, abrasive or wax, benzene, alcohol etc., which can damage the product. Use an air spray or soft cloth that is moist with a neutral detergent and water for removing dust or stains on the projection lens.</p> <p>It can cause fire, electric shock or product damage (deformation, corrosion and damage).</p>	

Others	⚠ WARNING	
<p>Do not attempt to service the projector yourself. Contact your dealer or service center.</p> <p>This may cause damage to the projector and could give an electric Shock as well as invalidating the warranty!</p>		

Others	⚠ NOTES	
<p>Be sure to unplug if the projector is not to be used for a long period.</p> <p>Accumulated dust may cause a fire hazard or damage to the unit!</p>	<p>Only use the specified type of battery.</p> <p>This could cause damage to the remote control.</p>	

Names of parts

Main Body

* The projector is manufactured using high-precision technology. You may, however, see on the Projector screen tiny black points and/or bright points (red, blue, or green). This can be a normal result of the manufacturing process and does not always indicate a malfunction.

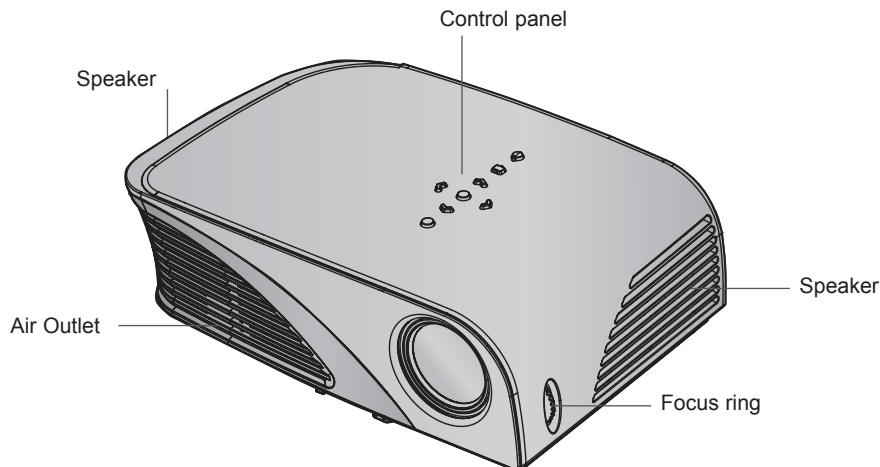

Control Panel

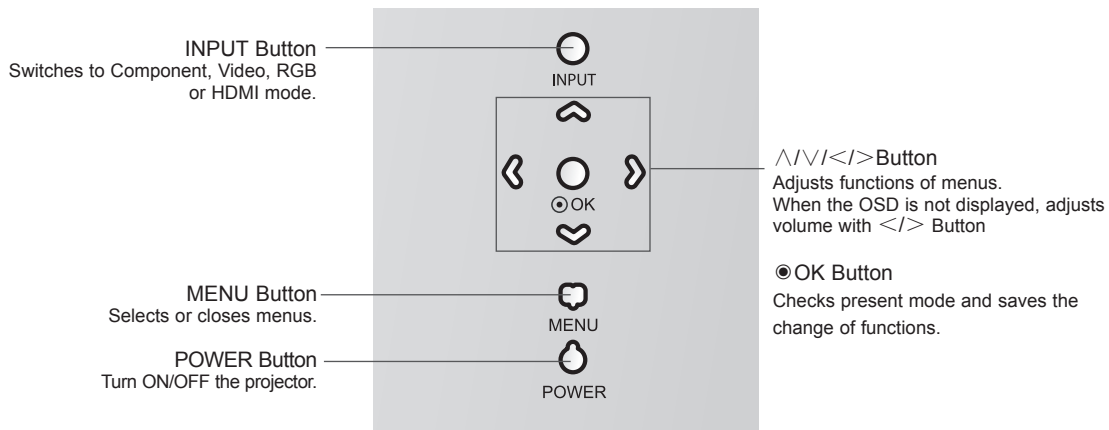

Connecting Part

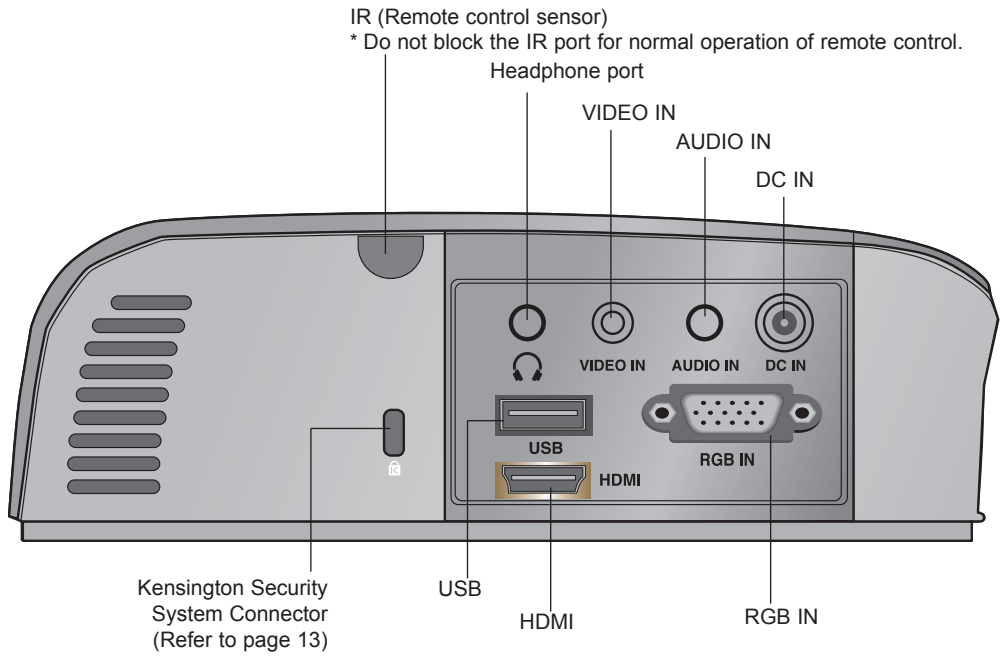

*When using HDMI/USB connector at the same time, if the size of the jack connecting to the connector is too big, they may not be connected together. Please use standard size jack.

Remote Control

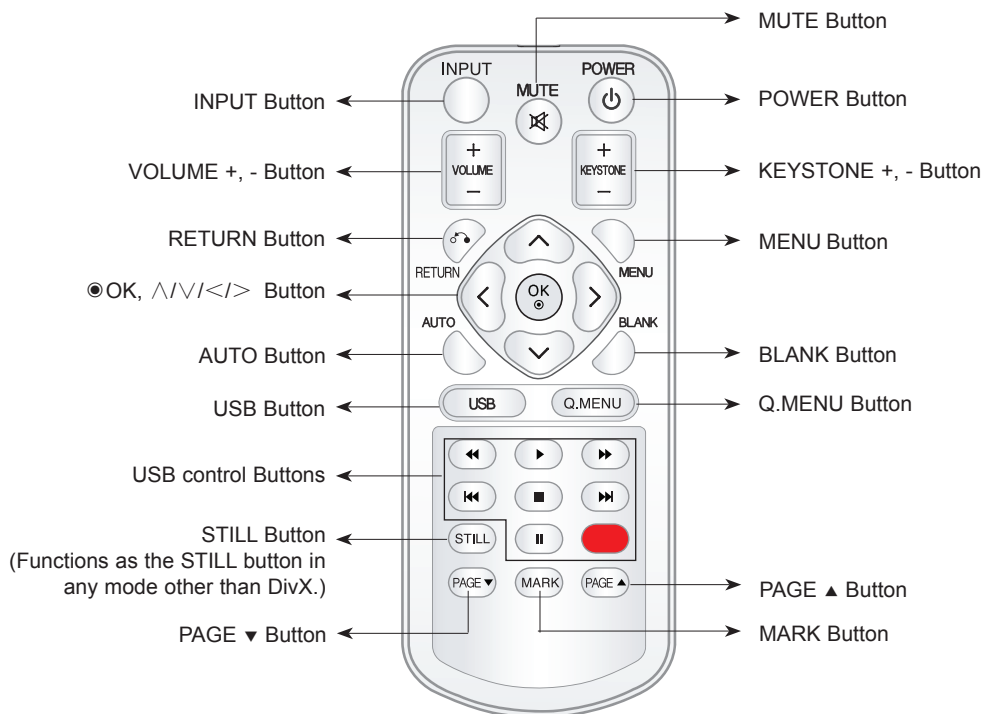

Installing Batteries

CAUTION

RISK OF EXPLOSION IF BATTERY IS REPLACED WITH AN INCORRECT TYPE.
DISPOSE OF USED BATTERIES ACCORDING TO THE INSTRUCTIONS.

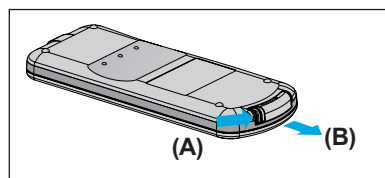

1. Remove the battery compartment cover by sliding the cover in the direction of the arrow (A). Pull out the cover in the direction of the arrow (B).

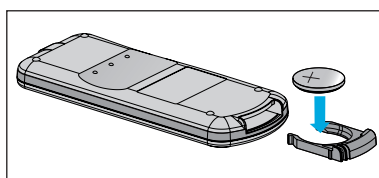

2. Insert the battery with the positive side facing up.

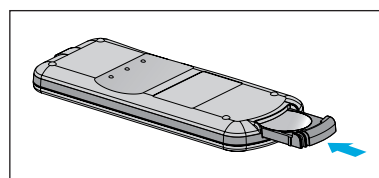

3. Replace the cover.

Note!

- Only use a 3V lithium battery (CR2032).
- Dispose of used batteries according to local ordinance regulations.
- Remove the battery when not using the projector for prolonged periods.

Accessories



Remote Control



3V Battery

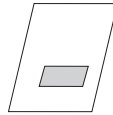

Owner's manual



CD Owner's manual



Power Cord



Computer Cable



Adapter



RGB to Component Cable

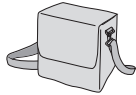

Portable bag
(*Only for HS200G/HS201G model)



Lens cap and Strap



Polishing Cloth

Note!

- Use a remote control up to 6 meters distance and 30 degree (left/right) within the receiving unit scope.
- We recommend you to use the remote control under 3 meters distance and 30 degree (left/right) when the cables are connected in the back outputs.
- When you carry the remote control in the portable bag, make sure that the buttons on the remote control are not pressed by the projector, cables, documents or any other accessories in the bag. Otherwise, it may reduce the battery life significantly.

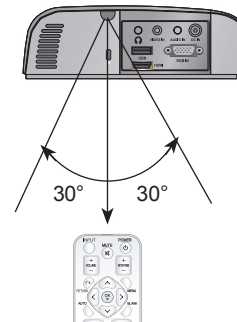

Optional Extras

* Contact your dealer to purchase these items.

* Optional parts can be changed without notice to improve the quality of the product, and new optional parts can be added.



Projection Screen



Tripod



HDMI Cable

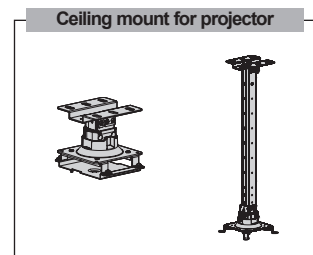

Video Cable



Audio Cable



Component Cable

Installing and Composition

Installation Precautions

Provide proper ventilation for this projector.

- The projector is equipped with ventilation holes(intake) on the bottom and ventilation holes(exhaust) on the front. Do not block or place anything near these holes. Internal heat build-up may occur, causing picture degradation or damage to the projector.
- Do not place the projector on a carpet, rug or other similar surface. It may prevent a adequate ventilation of the projector bottom. This product should be mounted to a wall or ceiling only.

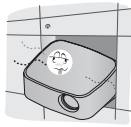

- Never push projector or spill any kind of liquid into the projector.



- Leave an adequate distance(30cm/12 inches or more) around the projector.



Place this projector in adequate temperature and humidity conditions.

- Install this projector only in a location where adequate temperature and humidity is available. (refer page 41)

Don't place the projector where it can be covered with dust.

- This may cause overheating of the projector.

Do not obstruct the slots and openings of the projector. This may cause overheating and create a fire hazard.

This projector is manufactured using high-precision technology. You may, however, see tiny black points and/or bright points (red, blue or green) that continuously appear on the projector Screen. This is a normal result of the manufacturing process and does not indicate a malfunction.

To display DTV programs, it is necessary to purchase a DTV receiver (Set-top Box) and connect it to the projector.

The remote control may not work when a lamp equipped with electronic ballast or a three-wavelength lamp is installed. Replace those lamps with international standard products to use the remote control normally.

Basic Operation of the Projector

1. Place the projector on a sturdy and horizontal surface with the PC or AV source.
2. Place the projector with the desired distance from the screen. The distance between the projector and the screen determines the actual size of the image.
3. Position the projector so that the lens is set at a right angle to the screen. If the projector is not set at a right angle, the screen image will be crooked. Although, slight angles can be counteracted using the Keystone adjustment. (Refer to page 20.)
4. Connect the power cable to the projector and the wall outlet after placing the projector in its desired location.

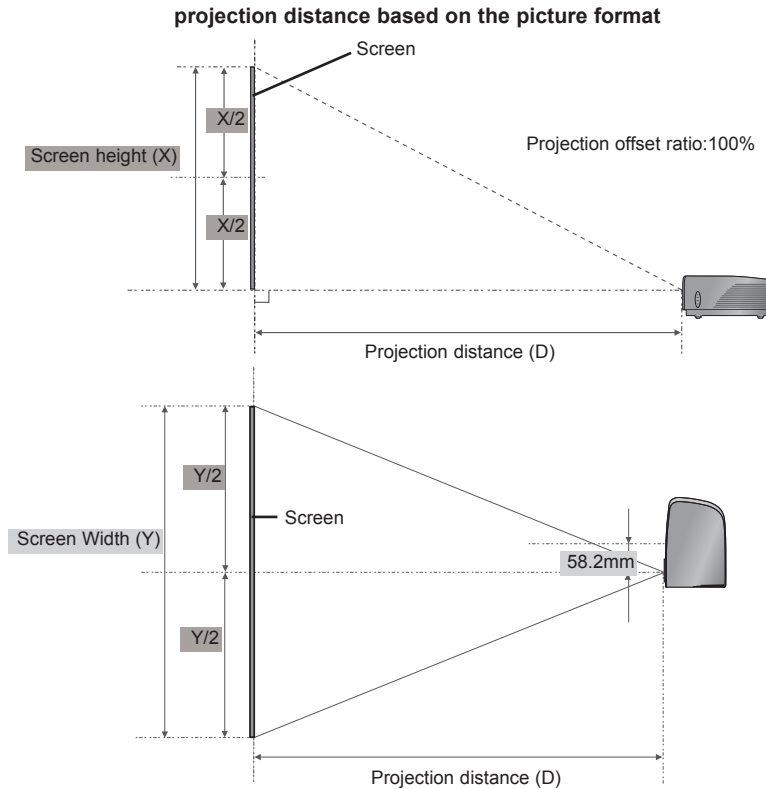

4 : 3 Scale				
Diagonal Size (inch)	Diagonal Size (mm)	Horizontal Size (mm)	Vertical Size (mm)	Projection Distance(D) (mm)
15	381	305	229	439
20	508	406	305	590
25	635	508	381	742
30	762	610	457	893
35	889	711	533	1046
40	1016	813	610	1200
45	1143	914	686	1349
50	1270	1016	762	1501
55	1397	1118	838	1652
60	1524	1219	914	1805
65	1651	1321	991	1957
70	1778	1422	1067	2108
75	1905	1524	1143	2260
80	2032	1626	1219	2411

How to install the projector using the tripod

- * You can install this projector using a tripod for the camera. You can assemble the projector instead of the camera on camera tripod.
- * When stabilizing the tripod, we recommend using the locking bolt of the standard size 4.5mm or less. The maximum size allowed for the locking bolt is 6.5mm. (If it is longer than the maximum allowed size, it may damage the projector.)

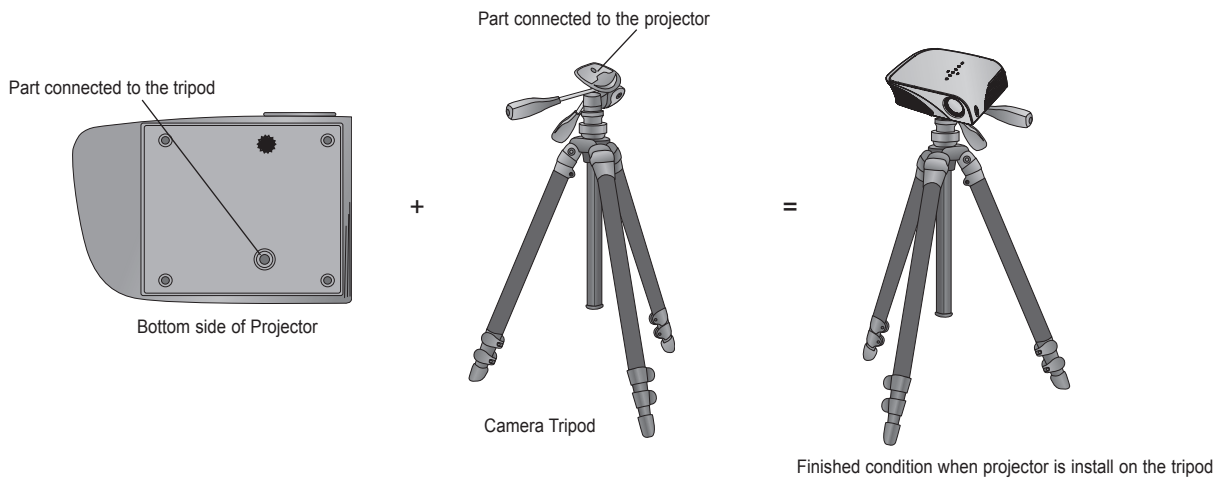

Kensington Security System

- This projector has a Kensington Security System Connector on the side panel. Connect the Kensington Security System cable as below.
- For the detailed installation and use of the Kensington Security System, refer to the user's guide included with the Kensington Security System set. And for further information, contact <http://www.kensington.com>, the internet homepage of the Kensington company that deals with expensive electronic equipment such as notebook PCs or projectors.
- The Kensington Security System is an optional item.

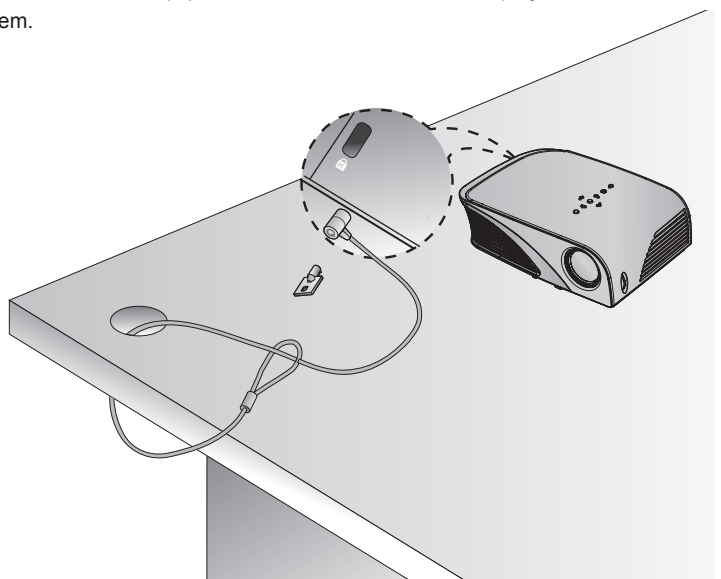

Turning on the Projector

1. Make sure the power cord is connected correctly.
2. Press the **POWER** button on the top cover or the **POWER** button on the remote control. (The light on the control panel will be turned on.)
 - Press the **INPUT** button on the remote control or the **INPUT** button on the control panel to select the input signal you want.
 - When you press the **POWER** button on the remote control or the **POWER** button on the control panel when you turn on the projector, the lights for all buttons on the control panel will be turned on.

Turning off the Projector

Press the **POWER** button on the top cover or the **POWER** button on the remote control.

Focus and Position of the Screen Image

When an image appears on the screen, check if it is in focus and fits the screen properly.

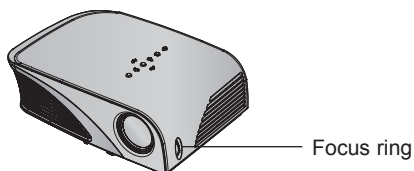

- To adjust the focus of the image, rotate the focus ring.

Selecting input mode

1. Press the **INPUT** button on the top cover or the **INPUT** button on the remote control.
2. Selecting an input signal with the **INPUT** button will only change the projector only to connected inputs. You can change it to any inputs with the <, > button.

Input List

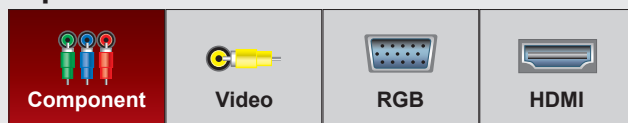

- The component input is always active, and it does not support plug &play function.

Connection

Connecting to a Desktop PC

* You can connect the projector to a computer with VGA, SVGA, XGA, SXGA output.
 * Refer to page 39 for resolutions the projector supports.

< How to connect >

1. Connect the **RGB IN** of the projector and the computer output port with a computer cable.
2. Connect the **AUDIO IN** of the projector and the computer audio output port with an audio cable.

* You may have to change the resolution that your PC exports to one supported by the projector. Refer to page 39. This projector may not support output from laptops when the laptop screen is on.

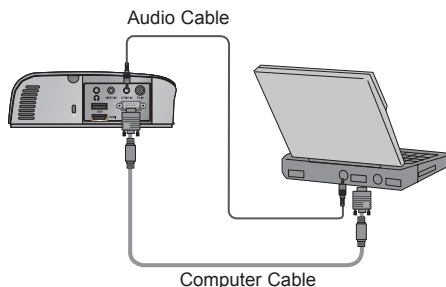
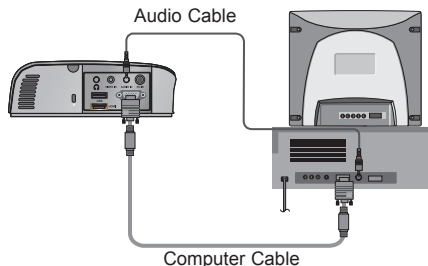

Connecting to a Video Source

* You can connect a VCR, a camcorder or any other compatible video image source to the projector.

< How to connect >

1. Connect the **VIDEO IN** of the projector to the output jack of the video source with a video cable.
2. Connect the **AUDIO IN** of the projector to the output jack of the audio source with an audio cable.

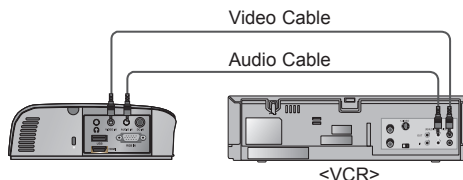

Connecting to a DVD Player

* Depending on the equipment, the component output jacks (Y, PB, PR) of the DVD Player may be labeled as Y, Pb, Pr/Y, B-Y, R-Y/Y, Cb, Cr.

< How to connect a HDMI source >

1. Connect the **HDMI** in of the projector and the HDMI output port of the DVD Player with an HDMI cable.
2. Set the DVD Player's resolution to one of the following:
480p(576p)/720p/1080i/1080p mode.

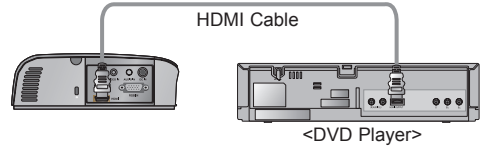

< How to connect a Component source >

1. After connecting the Component cable of DVD Player to the RGB to Component cable, connect it to the **RGB IN** terminal of the projector.
* When connecting the component cable, match the jack colors with the component cable.(Y=green, PB=blue, PR =red)
2. Connect the **AUDIO IN** of the projector to the output jacks of the audio source with an audio cable.

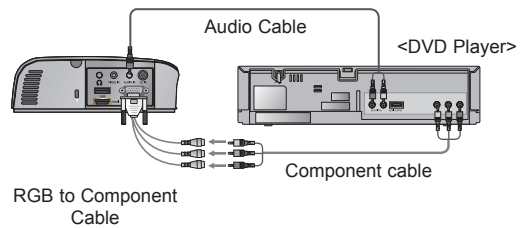

Connecting to a D-TV Set-Top Box

* To receive Digital TV (D-TV) programs, it is necessary to purchase a D-TV receiver (Set-Top Box) and connect it to the projector.
* Please refer to the owner's manual of the D-TV Set-Top Box for the connection between the projector and D-TV Set-Top Box.

< How to connect a HDMI source >

1. Connect the **HDMI** in of the projector and the HDMI output port of the DTV set-top box with an HDMI cable.
2. Set the DTV receiver's resolution to one of the following:
480p(576p)/720p/1080i/1080p mode.

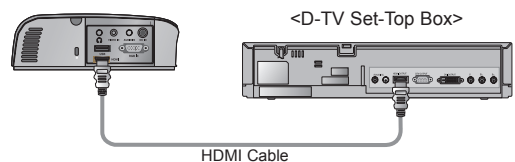

< How to connect a Component source >

1. Connect the D-TV Set-Top Box Component cable with RGB to Component cable and then connect it to **RGB IN** of the projector.
* When connecting the component cable, match the jack colors with the component cable.(Y=green, PB=blue, PR =red)
2. Connect the **AUDIO IN** of the projector to the output jacks of the audio source with an audio cable.

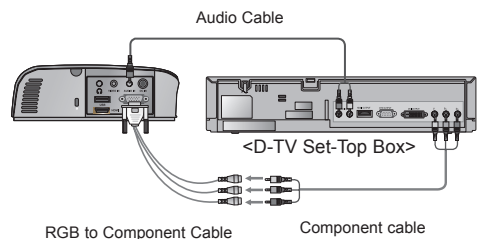

Function

* The On-Screen Display (OSD) in this manual may be slightly different from your projector.

* This operating guide explains operation of RGB(PC) mode mainly.

PICTURE Menu Options

Picture mode

* Use the Picture mode function to set the projector for the best picture appearance.

1. Press the **Q.MENU** button on the remote control.
2. Press the **▲**, **▼** buttons to move to **Picture mode**.
3. Press the **<**, **>** button to toggle through the preset picture settings.

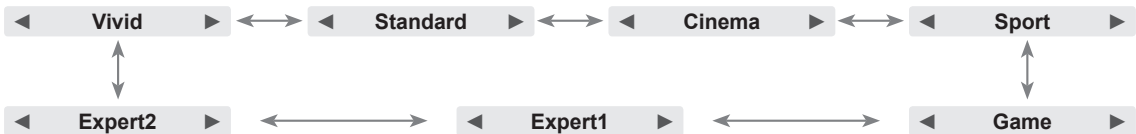
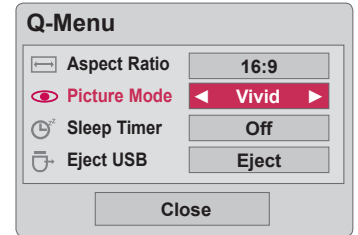

- You can use this function through the **MENU** button.
- To exit the menu display, press the **RETURN** button.

Adjusting Picture Mode

1. Press the **MENU** button. Then, move to **PICTURE** with the **▲**, **▼**, **<**, **>** buttons and press the **OK** button.
2. Press the **▲**, **▼** buttons to move to a desired function and press the **OK** button.
3. Press the **<**, **>** buttons to make a desired adjustment and then press the **OK** button.
 - You can set image values differently for each input and **Picture Mode**.
 - Saving after making adjustments will display **(User)** in adjusted **Picture Mode**. (except **Expert 1/2**)
 - Execute **Reset** for **Picture Mode** to restore back to default factory settings.
 - Press the **MENU** or **RETURN** button to exit the menu screen.

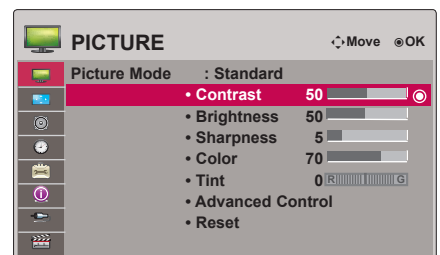

Picture Reset Function

* Settings of the selected **PICTURE** function for each input and **Picture Mode** return to the default factory settings.

1. Press the **MENU** button. Then, move to **PICTURE** with the \wedge , \vee , \lt , \gt buttons and press the **OK** button.
2. Press the \wedge , \vee buttons to move to **Reset** and press the **OK** button.
 - Press the **MENU** or **RETURN** button to exit the menu screen.

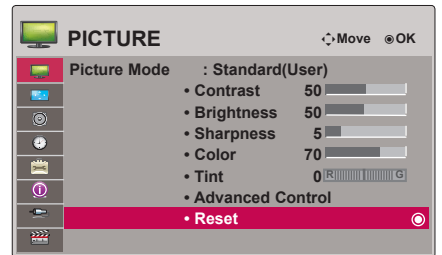

Advanced Control Function

1. Press the **MENU** button. Then, move to **PICTURE** with the \wedge , \vee , \lt , \gt buttons and press the **OK** button.
2. Press the \wedge , \vee buttons to move to **Advanced Control** and press the **OK** button.
3. Move to a desired item with the \wedge , \vee buttons.
4. Press the \lt , \gt buttons to make a desired adjustment and then press the **OK** button.
 - You can set image values differently for each input and **Picture Mode**.
 - Execute **Reset** for **Picture Mode** to restore back to default factory settings.
 - Press the **MENU** or **RETURN** button to exit the menu screen.

< When Picture Mode is Vivid/Standard/Cinema/ Sport/Game >

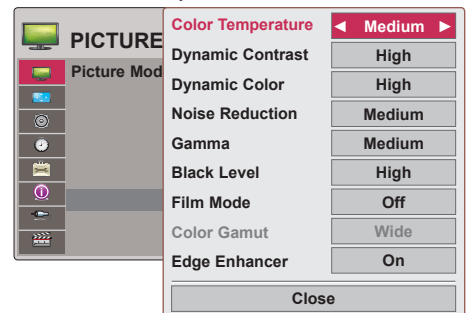

< When Picture Mode is Expert 1/2 >

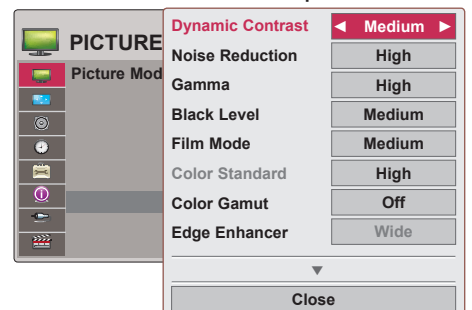

Color Temperature	<ul style="list-style-type: none"> • Set to warm to enhance hotter colors such as red, or set to cool to make picture bluish.
Dynamic Contrast	<ul style="list-style-type: none"> • Adjusts the contrast to keep it at the best level according to the brightness of the screen. The picture is improved by making bright parts brighter and dark parts darker.
Dynamic Color	<ul style="list-style-type: none"> • Adjusts screen colors so that they look livelier, richer and clearer. This feature enhances hue, saturation and luminance so that red, blue, green and white look more vivid.
Noise Reduction	<ul style="list-style-type: none"> • Reduces screen noise without compromising video quality.
Gamma	<ul style="list-style-type: none"> • Low : Make dark and middle gray level area of the picture brighter. • Medium: Express original picture levels. • High: Make dark and middle gray level area of the picture darker. • You can adjust brightness of dark area and middle gray level area of the picture.
Black Level	<ul style="list-style-type: none"> • Low: The reflection of the screen gets darker. • High: The reflection of the screen gets brighter. • Auto: Realizing the black level of the screen and set it to High or Low automatically. • Set black level of the screen to proper level. • This feather is disables in RGB mode.
Film Mode	<ul style="list-style-type: none"> • Makes video clips recorded in film look more natural by eliminating judger effect. • DVD and Blu-ray movies are filmed at 24 frames per second.
Color Gamut	<ul style="list-style-type: none"> • Standard: Displays standard color area. • Wide: Mode to use and set the rich color area of the display. • Maximize the utilization of color to increase color quality. • In Advanced Control mode, this feature is enabled in Color Temperature - Warm.
Edge Enhancer	<ul style="list-style-type: none"> • Show clearer and distinctive yet natural corners of the video.
Color Standard	<ul style="list-style-type: none"> • Convert the color of a different video to HD color.
White Balance	<ul style="list-style-type: none"> - This function enables Expert 1/2. • This is the function to adjust the overall color of the screen to the feeling you want. <ul style="list-style-type: none"> a. Method : 2 Points <ul style="list-style-type: none"> - Pattern: Inner, Outer - Red/Green/Blue Contrast, Red/Green/Blue Brightness: The adjustment range is -50 ~ +50. b. Method : 20 Points IRE <ul style="list-style-type: none"> - Pattern: Inner, Outer - IRE (Institute of Radio Engineers) is the unit to display the size of the video signal and can be set among 5, 10, 15 - 95, 100. You can adjust Red, Green or Blue according to each setting. - Red/Green/Blue: The adjustment range is -50 - +50.
Color Management System	<ul style="list-style-type: none"> - This function enables Expert 1/2. • As the tool used by the experts to make adjustments by using the test patterns, this does not affect other colors but can be used to selectively adjust the 6 color areas (Red/Green/Blue/Cyan/Mgt/ Yellow). Color difference may not be distinctive even when you make the adjustments for the general video. Adjusts Red/Green/Blue/Yellow/Cyan, Magenta. - Red/Green/Blue/Yellow/Cyan, Magenta Color: The adjustment range is -30 ~ +30. - Red/Green/Blue/Yellow/Cyan, Magenta Tint: The adjustment range is -30 ~ +30. - This feature is disable in PC mode.

SCREEN Menu Options

To Change PJT Mode

* This function turns the projected image upside down or flips horizontal.

1. Press the **MENU** button. Then, move to **SCREEN** with the \wedge , \vee , $<$, $>$ buttons and press the **OK** button.
2. Press the \wedge , \vee buttons to move to **PJT Mode** and press the **OK** button.
3. Move to a desired item with the \wedge , \vee buttons and then press the **OK** button.
 - Select **Rear** when projecting from the back of the transparent screen purchased separately.
 - Select **Ceiling** when installing the product on the ceiling.
 - When **PJT Mode** is **Rear/Ceiling**, the left/right of the speaker changes automatically.
 - Press the **MENU** or **RETURN** button to exit the menu screen.

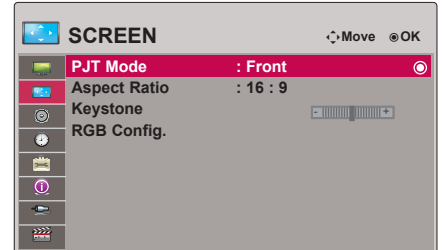

Using Aspect Ratio Function

* Use Picture mode function to set the projector for the best picture appearance.

1. Press the **Q.MENU** button on the remote control.
2. Press the \wedge , \vee buttons to move to **Aspect Ratio**.
3. Press the $<$, $>$ buttons to select a desired screen size.

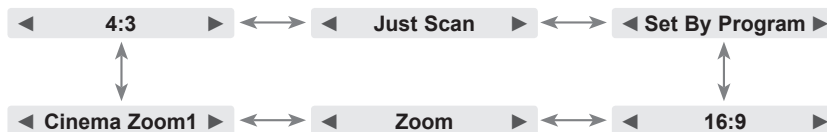

- Some options may not be available depending on input signals.
- You can use this function through the **MENU** button.
- To exit the menu display, press the **RETURN** button.

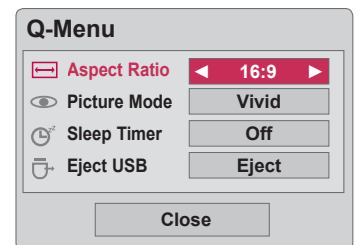

Using Keystone Function

* Use this function when the screen is not at a right angle to the projector and the image is a trapezoid shape.

* Only use the **Keystone** function when you can't get the best angle of projection.

1. Press the **KEYSTONE +, -** button of remote control.
2. Press the **KEYSTONE +, -** button to adjust the screen condition as you want.



- **Keystone** can be adjusted from -40 to 40.
- You can use this function through the **MENU** button.
- To exit the menu display, press the **RETURN** button.

Auto Configure Function

* This function assures you of getting the best video quality by automatically adjusting the horizontal size and synchronization of the image.

* Auto Tracking function works in RGB PC input only.

Press the **AUTO** button of the remote control.

- If you execute screen adjustment for a video from PC graphic signal, optimal state may not be found. Execute the **Auto Configure** function for a still image.
- You can use this function through the **MENU** button.

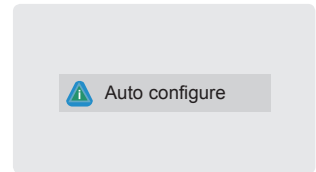

RGB Config. Function

1. Press the **MENU** button. Then, move to **SCREEN** with the \wedge , \vee , $<$, $>$ buttons and press the **OK** button.
2. Press the \wedge , \vee buttons to move to **RGB Config.** and press the **OK** button.
3. Move to a desired item with the \wedge , \vee buttons and then press the $>$ button.
4. Press the \wedge , \vee , $<$, $>$ button to adjust the screen condition as you want and then press the **OK** button.

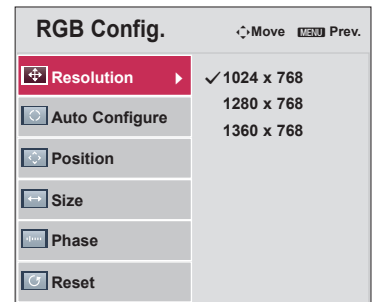

- **Resolution** can be chosen between 768 resolution (1024x768/1280x768/1360x768, 60Hz) and 1050 resolution (1400x1050/1680x1050, 60Hz).
- To exit the menu display, press the **RETURN** button.

Using the Still Function

1. Press the **STILL** button on the remote control.
* You can freeze the moving image.

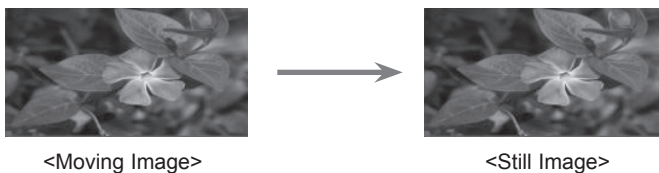

2. To exit STILL, press any button.
* The STILL function will release automatically after approximately 10 minutes.

AUDIO Menu Options

What is FM Wireless Audio? (HS200/HS200G only)

FM Wireless Audio is a function to send out audio signals from the projector using FM frequency (88.5 ~95.5 MHz). The frequency of Projector and FM receiver should be same in order to output the sound from FM receiver normally. The signal can be received by using FM receiver within 3m of distance.

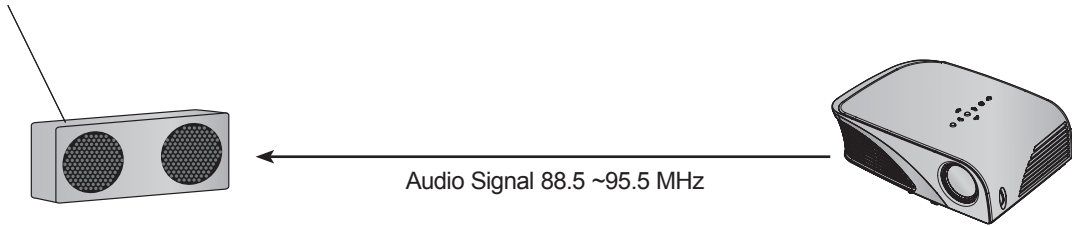

< The recommended use range of FM receiver >

Install projector and FM receiver without any abstacles as shown on the figure below. A FM receiver can be reached 5 m when the antenna length and direction are good.

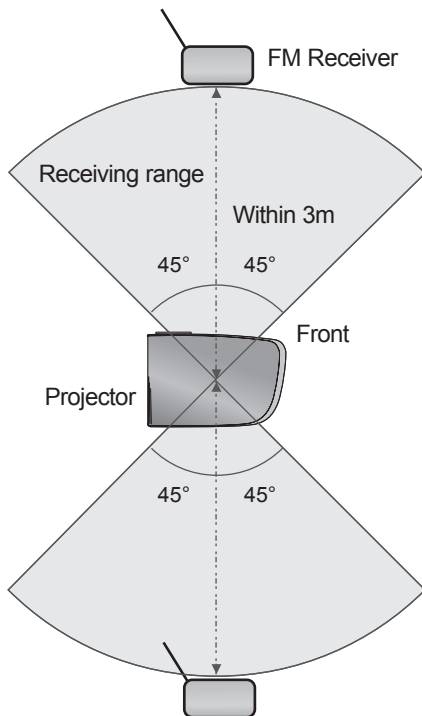

< The recommended length of FM receiver Antenna >

We recommend to use a rod antenna 0.8 ~ 1.5 m for better sound quality since audio noise can be detected when using under 0.8m rod antenna.

Installing Instructions (HS200/HS200G Only)

- This product is for domestic use.
- If used in a medical institution, it may cause an error for medical equipments. Please do not use in a medical establishment.
- Please maintain the distance between the projector and FM receiver within 3m.
- The sound from FM receiver may not come out in the desired quality if the distance is more than 3m.
- Please adjust the location of FM receiver and its antenna and install them to where it shows a good condition of receiving reception.
- According to the installed location and environment, the receiving distance may become shorter and the sound may be interrupted due to:
 - If an obstacle is located near the projector and FM receiver.
 - If an obstacle passes near by the projector and FM receiver.
 - If the FM receiver is installed Left, Right, or diagonal line of projector
 - If the Projector or the FM receiver is located inside of a rack made of metal.
 - If other FM transmitter equipment is working near at the same frequency.
 - If there is a radio broadcast on air at the same frequency.
 - If working in the dusty, humid, or high temperature environment.

What do I do if the FM receiving signal is not good? (HS200/HS200G Only)

- Please adjust the antenna of FM receiver or move the location of FM receiver.
- If there is no Audio signal or low reception, within 55 seconds the FM Wireless Audio function will shut down automatically.
- Please check the incoming audio signal.
- Please check if the power of projector or FM receiver is on.
- Please check if there is any obstacle between the projector and FM receiver.
- Please check if there is any metallic hardware or electronic product near by.
- Please check if there is any radio broadcasting channel using the same frequency.
- If there is a radio broadcasting channel using the same frequency, please change to a different frequency on the projector.

To listen through the FM receiver speaker (HS200/HS200G Only)

1. Press the **MENU** button. Then, move to **AUDIO** with the \wedge , \vee , $<$, $>$ buttons and press the **OK** button.
2. Press the \wedge , \vee buttons to move to **FM Wireless Audio** and press the **OK** button.
3. Press the \wedge , \vee buttons to move to **On** and press the **OK** button.
4. Press the \wedge , \vee buttons to move to **Frequency** and press the **OK** button.
5. Press the $<$, $>$ buttons to adjusting frequency and press the **OK** button.
6. Set the frequency of FM receiver to the frequency of the set projector.
 - Setting **FM Wireless Audio** as **on** disables **mute/volume/balance/ treble** functions.
 - There may be differences in the reception distance and the audio quality according to the type of FM receiver and installation locations.
 - FM frequency can be set between 88.5 ~95.5 MHz.
 - If you don't use the FM receiver or audio signals from the projector, **off** should be selected.
 - When power is back on, it is changed to **off** status.
 - Press the **MENU** or **RETURN** button to exit the menu screen.

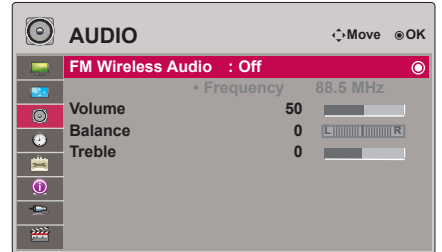

Adjusting Volume

Press the **VOLUME +, -** button on the remote control.

- If **FM Wireless Audio** is **on**, it does not function. Adjust with FM receiver.
- You can use this function through the **MENU** button.

Adjusting Speaker Balance

* Adjust the left/right sound of speaker to suit your taste and room situations.

1. Press the **MENU** button. Then, move to **AUDIO** with the \wedge , \vee , \lt , \gt buttons and press the **OK** button.
2. Press the \wedge , \vee buttons to move to **Balance** and press the **OK** button.
3. Press the \lt , \gt buttons to adjusting audio balance and press the **OK** button.

- If **FM Wireless Audio** is **on**, it does not function. Adjust with FM receiver.
- Press the **MENU** or **RETURN** button to exit the menu screen.

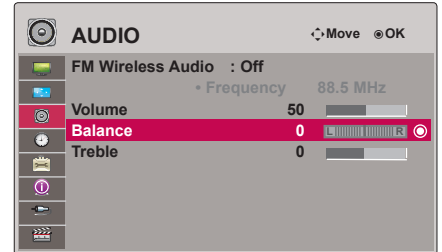

Adjusting Treble

* Adjust the treble your taste and room situations.

1. Press the **MENU** button. Then, move to **AUDIO** with the \wedge , \vee , \lt , \gt buttons and press the **OK** button.
2. Press the \wedge , \vee buttons to move to **Treble** and press the **OK** button.
3. Press the \lt , \gt buttons to adjusting audio treble and press the **OK** button.

- If **FM Wireless Audio** is **on**, it does not function. Adjust with FM receiver.
- Press the **MENU** or **RETURN** button to exit the menu screen.

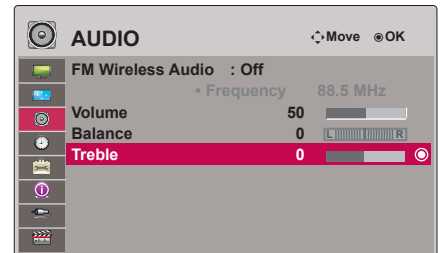

TIME Menu Options

Sleep time Function

* The sleep timer turns the projector off at the preset time.

1. Press the **Q.MENU** button on the remote control.
2. Press the \wedge , \vee buttons to move to **Sleep Timer**.
3. Press the \leftarrow , \rightarrow buttons to select a desired preset time.

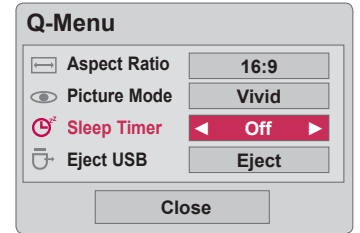

- You can use this function through the **MENU** button.
- To exit the menu display, press the **RETURN** button.

Auto Off Function

* This function turns the projector off automatically after 10 minutes is passed when there is no signal.

1. Press the **MENU** button. Then, move to **TIME** with the \wedge , \vee , \leftarrow , \rightarrow buttons and press the **OK** button.
2. Press the \wedge , \vee buttons to move to **Auto Off** and press the **OK** button.
3. Move to **On** with the \wedge , \vee buttons and then press the **OK** button.
 - Press the **MENU** or **RETURN** button to exit the menu screen.

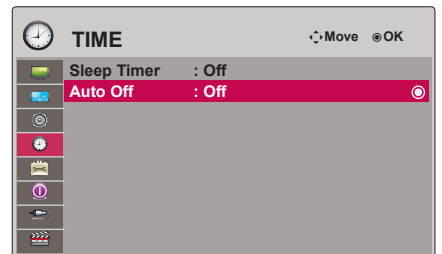

OPTION Menu Options

Selecting Language

1. Press the **MENU** button. Then, move to **OPTION** with the \wedge , \vee , \leftarrow , \rightarrow buttons and press the **OK** button.
2. Press the \wedge , \vee buttons to move to **Menu Language** and press the **OK** button.
3. Move to a desired item with the \wedge , \vee , \leftarrow , \rightarrow buttons and then press the **OK** button.
 - On-Screen-Display (OSD) is displayed in the selected language.
 - Press the **MENU** or **RETURN** button to exit the menu screen.

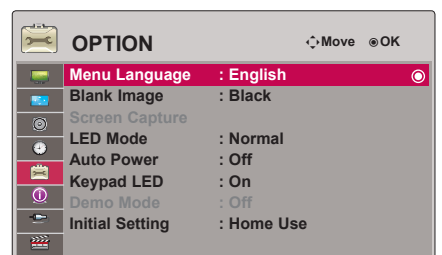

Using Blank Function

* This function may be effective if you need to get the attention of the audience during presentations, meetings or briefings.

1. Press the **BLANK** button on the remote control.
 - The screen turns off to a background color.
 - You can choose the background color.
(Refer to 'Selecting Blank image')
2. Press any button to cancel the blank function.
 - To temporarily turn off the lamp, press **BLANK** on the remote control. Do not block the projection lens with any objects when the projector is under operation as this could cause the objects to become heated and deformed or even cause a fire.

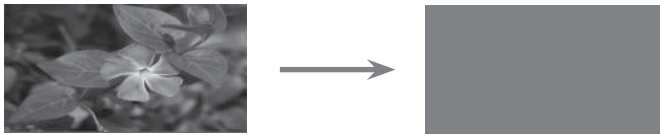

Selecting Blank image

1. Press the **MENU** button. Then, move to **OPTION** with the \wedge , \vee , \lt , \gt buttons and press the **OK** button.
2. Press the \wedge , \vee buttons to move to **Blank Image** and press the **OK** button.
3. Move to a desired item with the \lt , \gt buttons and then press the **OK** button.
 - Background image will be altered to the selected Blank function image.
 - Press the **MENU** or **RETURN** button to exit the menu screen.

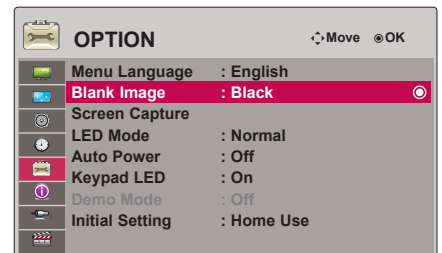

Screen Capture Function

1. Press the **MENU** button. Then, move to **OPTION** with the \wedge , \vee , \lt , \gt buttons and press the **OK** button.
2. Press the \wedge , \vee buttons to move to **Screen Capture** and press the **OK** button.
 - It can only be elected when there is an input signal.
 - It takes up to 2 minutes when capturing screen.
 - Press the **MENU** or **RETURN** button to exit the menu screen.

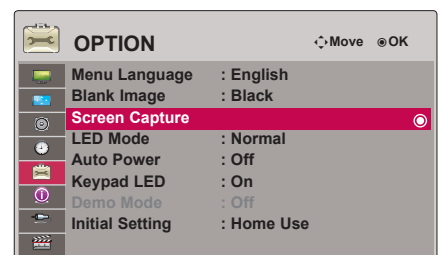

To adjust the brightness of the screen

1. Press the **MENU** button. Then, move to **OPTION** with the \wedge , \vee , \lt , \gt buttons and press the **OK** button.
2. Press the \wedge , \vee buttons to move to **LED Mode** and press the **OK** button.
3. Move to a desired item with the \wedge , \vee buttons and then press the **OK** button.
 - LED Mode changes into Dimming mode automatically at specific temperatures (95°F (35°C) or higher).
 - Dimming mode gets about 90% brightness of original led mode.
 - Press the **MENU** or **RETURN** button to exit the menu screen.

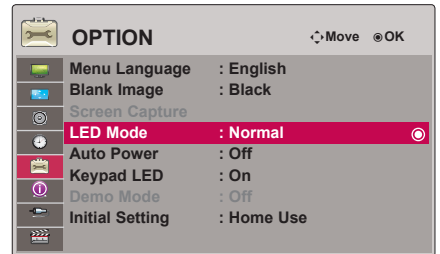

To make the power of the projector turn on automatically when power is in

1. Press the **MENU** button. Then, move to **OPTION** with the \wedge , \vee , \lt , \gt buttons and press the **OK** button.
2. Press the \wedge , \vee buttons to move to **Auto Power** and press the **OK** button.
3. Press the \wedge , \vee buttons to move to **On** and press the **OK** button.
 - **On**: Connecting DC cable to the projector turns on the projector.
 - **Off**: Connecting DC cable to the projector makes the projector in standby state.
 - Press the **MENU** or **RETURN** button to exit the menu screen.

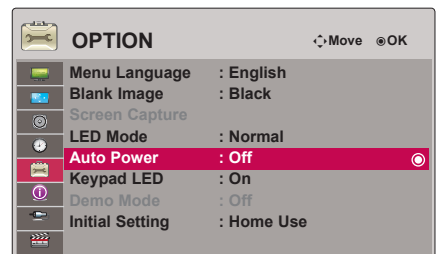

To set the button light

1. Press the **MENU** button. Then, move to **OPTION** with the \wedge , \vee , \lt , \gt buttons and press the **OK** button.
2. Press the \wedge , \vee buttons to move to **Keypad LED** and press the **OK** button.
3. Press the \wedge , \vee buttons to move to **On** and press the **OK** button.
 - **On**: When button is pressed, it lights for 5 seconds before turning off.
 - **Off**: The lights on the buttons do not turn on.
 - Press the **MENU** or **RETURN** button to exit the menu screen.

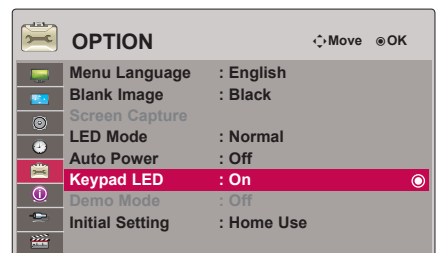

Demo Mode Function

1. Press the **MENU** button. Then, move to **OPTION** with the \wedge , \vee , \lt , \gt buttons and press the **OK** button.
2. Press the \wedge , \vee buttons to move to **Demo Mode** and press the **OK** button.
3. Press the \wedge , \vee buttons to move to **On** and press the **OK** button.
 - It can be selected when **Initial Setting** is set as **Store Demo**.
 - Press the **MENU** or **RETURN** button to exit the menu screen.

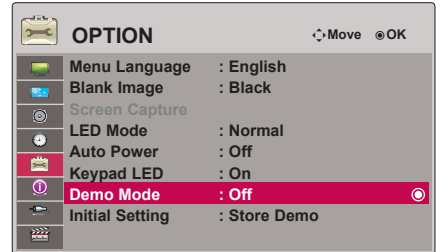

Initial Setting Function

1. Press the **MENU** button. Then, move to **OPTION** with the \wedge , \vee , \lt , \gt buttons and press the **OK** button.
2. Press the \wedge , \vee buttons to move to **Initial Setting** and press the **OK** button.
3. Move to a desired item with the \wedge , \vee buttons and then press the **OK** button.
 - Set as **Home Use** when used in homes.
 - Press the **MENU** or **RETURN** button to exit the menu screen.

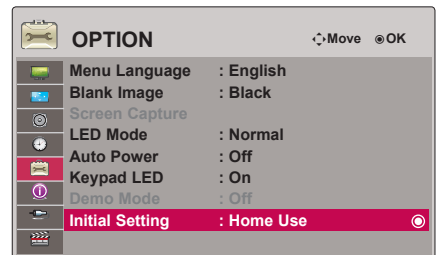

INFORMATION Menu Options

To See The Projector Information

1. Press the **MENU** button. Then, move to **INFORMATION** with the \wedge , \vee , \lt , \gt buttons and press the **OK** button.
2. You can see the current information of the projector.
 - Press the **MENU** or **RETURN** button to exit the menu screen.

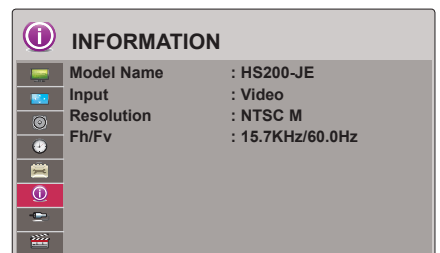

USB

* Image shown may differ from your projector.

To use the USB device

Connecting the USB device

* When you connect a USB device, this screen is displayed, automatically.
In USB device, you can not add a new folder or delete the existing folder.

1. Connect the USB device to the USB jack on the back of the set.
2. It turns automatically to DivX Home Menu.

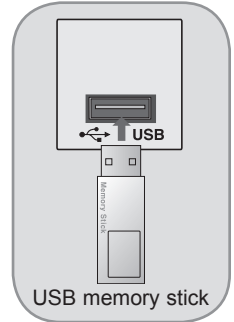
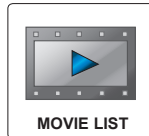
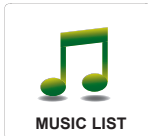

Eject USB

* Select "Eject" in order to eject a USB device.

1. Press the **Q.MENU** button on the remote control.
2. Press the \wedge , \vee buttons to move to **Eject USB**.
3. Press the **OK** button on the remote control.

- After **Eject USB**, USB memory cannot be read. Remove USB memory, and connect again.
- To exit the menu display, press the **RETURN** button.

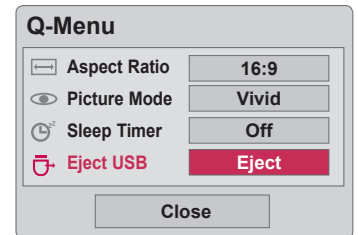

Precautions when using the USB device

- ▶ Only a USB storage device is recognizable. Digital camera and mobile phone are not supported.
- ▶ If the USB storage device is connected through a USB hub, the device is not recognizable.
- ▶ A USB storage device using an automatic recognition program may not be recognized.
- ▶ A USB storage device which uses its own driver may not be recognized.
- ▶ The recognition speed of a USB storage device may depend on each device.
- ▶ Please do not turn off the projector or unplug the USB device when the connected USB storage device is working. When such device is suddenly separated or unplugged, the stored files or the USB storage device may be damaged.
- ▶ Please do not connect the USB storage device which was artificially maneuvered on the PC. The device may cause the product to malfunction or fail to be played. Never forget to use only a USB storage device which has normal music files or image files.
- ▶ Please use only a USB storage device which was formatted as a FAT16, FAT32 and NTFS file system provided with the Windows operating system. In case of a storage device formatted as a different utility programmed which is not supported by Windows, it may not be recognized.
- ▶ Please connect power to a USB storage device which requires an external power supply. If not, the device may not be recognized.
- ▶ Please connect a USB storage device with cable is offered by USB maker. If connected with cable is not offered by USB maker or an excessively long cable, the device may not be recognized.
- ▶ Some USB storage devices may not be supported or operated smoothly.
- ▶ If the name of a folder or file is too long, it will not be displayed or recognized.
- ▶ File alignment method is based on storage order in USB storage device.
- ▶ Please backup the important file because a data of USB device may be damaged. Data management is consumer's responsibility and in consequence the manufactures does not cover the product bearing data damage.
- ▶ If the quantity of folders and files is over 1,000, it will not be displayed or recognized about exceeded files and folders.
- ▶ It is supported for only primary partition. If there is an extended partition, it is not displayed or recognized.
- ▶ The recommended capacity is 1TB or less for a USB external hard disk and 32GB or less for USB memory. Any device with more than the recommended capacity may not work properly.
- ▶ Data in a USB storage device cannot be deleted in the NTFS file system.
- ▶ If the USB memory device does not work properly, disconnect and reconnect it.
- ▶ If a USB external hard disk with a "Energy Saving" function does not work, turn the hard disk off and on again to make it work properly.
- ▶ USB storage devices below USB 2.0 are supported as well. But they may not work properly in the movie list.

PHOTO List

* It is available to playback the photo file(*.jpg) in the USB device.

The On Screen Display may be different from your set. Images are an example to assist with the projector operation.

Supported photo file: *.JPG

- You can play JPG files only.
- Only baseline scan is supported among JPG.
- This Projector will not be able to decode most JPEG images saved using the Progressive option.
- The supported size of the picture are minimum 64 pixel (horizontal) x 64 pixel (vertical) to maximum 4,000 pixel (horizontal) x 8,640 pixel (vertical).
- Unsupported file may appear as bitmap format.

Screen Components

1. Moves to upper level file
2. Preview: Display the thumbnail/folder name of the photo in the selected folder
3. Current page/Total pages
4. Total number of marked photos
5. Corresponding buttons on the remote control

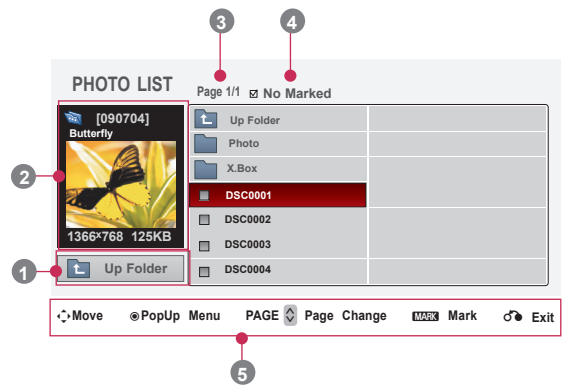
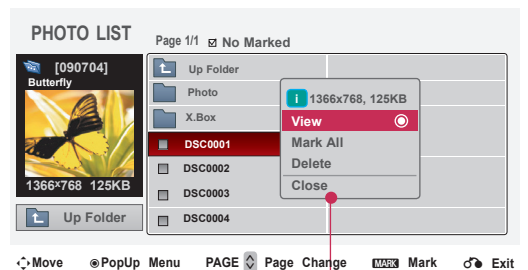

Photo Selection and Popup Menu

1. Press the **USB** button. Then, move to **PHOTO LIST** with the **<**, **>** buttons and press the **OK** button.
2. Press the **^**, **v**, **<**, **>** buttons to move to a desired photo file and press the **OK** button.
3. Move to a desired item with the **^**, **v** buttons and then press the **OK** button.



- **View:** Display the selected item.
- **Mark All:** Mark all photos on the screen.
- **Delete:** Delete the selected photo item.
- **Close:** Close the pop-up menu.

- If the picture file is damaged, it may not be displayed properly.
- High resolution pictures may take longer time to display on the entire screen.

Full Screen Menu

1. Press the **USB** button. Then, move to **PHOTO LIST** with the **<**, **>** buttons and press the **OK** button.
2. Press the **^**, **v**, **<**, **>** buttons to move to desired photo and press the **OK** button.
3. Press the **^**, **v** buttons to move to **View** and press the **OK** button.
4. The selected photo is displayed in full size and show up the menu.
5. Use **^**, **v**, **<**, **>** button to select and control the menu on the full-sized screen.

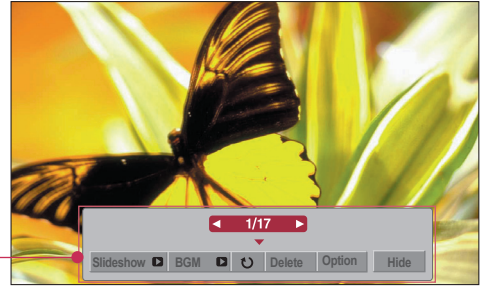

- Use **<**, **>** button to select the previous or next photo.
- **Slideshow**: Selected photos are displayed during the slide show. If no photo is selected, all photos in the current folder are displayed during slide show.
 - Set the time interval of the slide show in **Option**.
- **BGM**: Listen to music while viewing photos in full size.
 - Set the BGM device and album in **Option**.
- **Rotate** (Rotate): Rotate photos.
- **Delete**: Delete photos.
- **Option**: Set values for **Slide Speed** and **Music Folder**.
 - You cannot change **Music Folder** while BGM is playing.
- **Hide**: Hide the menu on the full-sized screen.
 - To see the menu again on the full-sized screen, press **OK** button to display.

MUSIC List

* You can use the Music List menu to play MP3 files from a USB storage device.
The On Screen Display on your model may be slightly different.

Supported music file: *.MP3

Bit rate range 8Kbps ~ 320Kbps

- Sampling rate (Sampling Frequency): MPEG1Layer 3 : 8KHz ~ 48KHz
- Music Max Length: 999.59 Sec.
- This Projector can not play music files less than 16 Kbytes.
- This Projector cannot play back copy-protected files.

Screen Components

1. Moves to upper level file
2. Preview: Display the title/folder name of the music in the selected folder
3. Current page/Total pages
4. Total number of marked music
5. Corresponding buttons on the remote control

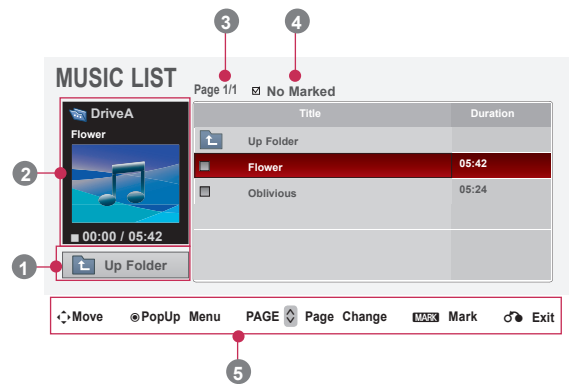

Music Selection and Popup Menu

1. Press the **USB** button. Then, move to **MUSIC LIST** with the **<**, **>** buttons and press the **OK** button.
2. Press the **^**, **v**, **<**, **>** buttons to move to a desired music file and press the **OK** button.
3. Move to a desired item with the **^**, **v** buttons and then press the **OK** button.

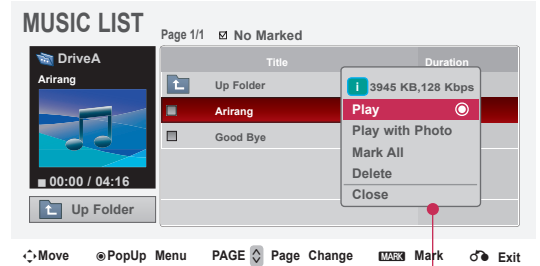

- **Play:** Once a song finishes playing, the next selected one will be played. When there are no selected music to play, the next one in the current folder will be played. If you go to a different folder and press the **OK** button, the current music in playback will stop. When music is playing,  is displayed in front of the music play time. After certain time elapsed, the full music list screen disappears and the playback information screen which is on the top of the music list runs as a screen saver. Press **OK**, **■**, or **RETURN** button to stop the screen saver. A damaged or corrupted music file that does not play displays 00:00 as the play time. Music files with copy-protection will not play.
- **Play with Photo:** Start playing the selected music and then move to the Photo List.
- **Mark All:** Mark all music in the folder.
- **Delete:** Delete the selected music.
- **Close:** Close the pop-up menu.

MOVIE List

* The movie list is activated once USB is detected. It is used when playing movie files on projector.

Supported Movie File

Extension name	Video Codec	Maximum Resolution supported	Frame	Audio Codec	Explanation
AVI m4v Divx	MPEG4	720X480 800X432	30P	AC3 • Bit rate range 32Kbps ~ 640Kbps • Sampling rate 32KHz, 44.1KHz, 48KHz MPEG • Bit rate range 32Kbps ~ 448Kbps • Sampling rate 32KHz ~ 48KHz LPCM MP3 • Bit rate range 32Kbps ~ 320Kbps • Sampling rate 32KHz ~ 48KHz	Microsoft MPEG4 is not supported. WMV series are not supported. Playing a video only support the Playback.
	DivX 3.XX DivX 4.XX DivX 5.XX DivX 6.XX				
	Xvid 1.00 Xvid 1.01 Xvid 1.02 Xvid 1.03 Xvid 1.10 Beta1/2				
DAT MPG MPEG MPE VOB	MPEG1				
	MPEG2				

Subtitle format : *.ass/ *.smi/ *.srt/ *.ssa

Precautions when playing the DivX

- ▶ A DivX movie file and its subtitle file must be located in the same folder.
- ▶ At this time, a movie file name and its subtitle file name must be identical for it to be displayed.
- ▶ Specific subtitles created by the user may not be operated normally.
- ▶ Some special characters are not supported in subtitles.
- ▶ HTML tags are not supported in subtitles.
- ▶ Subtitles in languages other than the supported languages are not available.
- ▶ Time information in an external subtitle file should be arranged in ascending order to be played.
- ▶ Damaged movie files may not be played, and certain functions could be limited during the playback.
- ▶ Certain video files created with an encoder may not be played.
- ▶ If the video and audio structure of recorded file is not interleaved, either video or audio is outputted.
- ▶ Video with resolution higher than maximum resolution supported for each frame, cannot be guaranteed for smooth playback.
- ▶ DTS Audio codec is not supported.
- ▶ Playback for movie file exceeding 4GB (Giga Byte) is not supported.
- ▶ Playing a video via a USB connection that doesn't support high speed may not work properly.
- ▶ When watching a video using **MOVIE LIST**, the function to adjust screen does not work.



- **ABOUT DIVX VIDEO:** DivX® is a digital video format created by DivX, Inc. This is an official DivX Certified device that plays DivX video. Visit www.divx.com for more information and software tools to convert your files into DivX video.
- **ABOUT DIVX VIDEO-ON-DEMAND:** This DivX Certified® device must be registered in order to play DivX Video-on-Demand (VOD) content. To generate the registration code, locate the DivX VOD section in the device setup menu. Go to vod.divx.com with this code to complete the registration process and learn more about DivX VOD.
- "Certifié DivX pour lire des vidéos DivX, y compris le contenu premium."
- "Pat. 7,295,673; 7,460,688; 7,519,274"



Manufactured under license from Dolby Laboratories. "Dolby" and the double-D symbol are trademarks of Dolby Laboratories.

Screen Components

1. Moves to upper level folder
2. Preview: Display the title/folder name of the movie in the selected folder
3. Current page/Total pages
4. Total number of marked movies
5. Corresponding buttons on the remote control

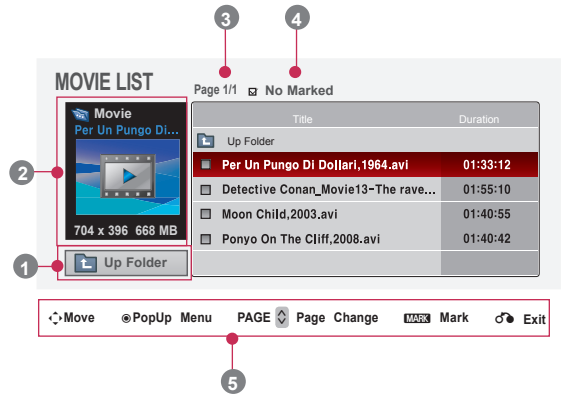

Movie Selection and Popup Menu

1. Press the **USB** button. Then, move to **MOVIE LIST** with the <, > buttons and press the **OK** button.
2. Press the ^, v, <, > move to a desired movie file and press the **OK** button.
3. Move to a desired item with the ^, v buttons and then press the **OK** button.

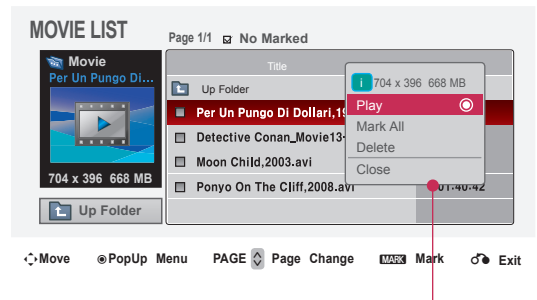

- **Play:** Play the selected movie titles.
 - In the case of files not supported, a message regarding non-supported file is displayed.
- i** This file is invalid.
- The screen is played, but when the audio file is not supported, the following message shows.
- i** Unsupported Audio.
- **Mark All:** Mark all movies in the folder.
 - **Delete:** Delete the selected movie.
 - **Close:** Close the pop-up menu.

Playing the Movie

* You can adjust various method during the movie play.

1. Press the **USB** button. Then, move to **MOVIE LIST** with the <, > buttons and press the **OK** button.
2. Press the ^, v, <, > move to a desired movie file and press the **OK** button.
3. Press the ^, v buttons to move to **Play** and press the **OK** button.

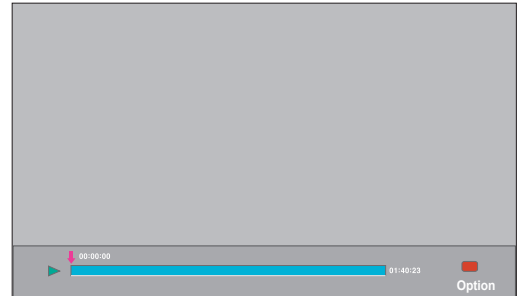

◆ Use of remote control

- Press the **◀ (REW)** button to rewind.
- Press the **▶ (FF)** button to forward fast.
- Press the **⏸ (Pause)** button to pause the screen.
- Press the **■ (Stop)** button to stop.
- Press the **◀◀ (Skip -)** button to play the previous movie.
- Press the **▶▶ (Skip +)** button to play the next movie.

Option Menu Selection

On **MOVIE LIST** play mode.

Press the **RED** button on the remote control.

- **Picture Size:** Select the **Full** or **Original** screen size.
- **Picture Mode:** Select the **Vivid, Standard, Cinema, Sport** or **Game**.
- **Subtitle Language & Audio Language:** Select Language Group of the audio/subtitle during movie play.

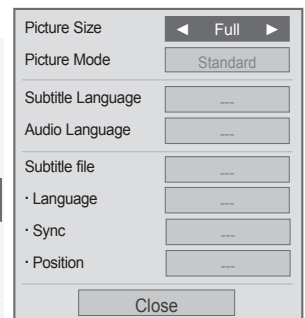

Subtitle Language Group	Supported Language
Latin1	French, Spanish, Catalan Basque, Portuguese, Italian, Albanian, Rhaeto-Romanic, Dutch, German, Danish, Swedish, Norwegian, Finnish, Faeroese, Icelandic, Irish, Scottish, English
Latin2	Czech, Hungarian, Polish, Romanian, Croatian, Slovak, Slovenian, Sorbian
Latin4	Estonian, the Baltic languages Latvian(Lettish)and Lithuanian, Greenlandic and Lappish
Latin5	English, Turkish
Cyrillic	Bulgarian, Byelorussian, Macedonian, Russian, Serbian and pre-1990 (no ghe with upturn)Ukrainian
Greek	English, modern Greek
Hebrew	English, modern Hebrew
Chinese	Chinese
Korean	English, Korean
Arabic	English, Arabic

- **Subtitle file:** The subtitle can be turned on or off.
 - **Language:** If there are two or more subtitles, you can select one of them.
 - **Sync:** When the video is not synchronized with the caption, it can be adjusted by the unit of 0.5 second.
 - **Position:** Move the location of the subtitle.

To See The DivX Registration Code

* Confirm the DivX registration code number of the projector.
Using the registration number, movies can be rented or purchased at www.divx.com/vod.

1. Press the **MENU** button. Then, move to **USB** with the \wedge , \vee , \lt , \gt buttons and press the **OK** button.
2. Press the \wedge , \vee buttons to move to **DivX Reg. Code** and press the **OK** button.
3. You can see the DivX registration code of the projector.
 - With a DivX registration code from other projector, playback of rented or purchased DivX file is not allowed. (Only DivX files matched with the registration code of the purchased projector are playable.)
 - The video or audio of a file converted based on a standard other than the DivX codec standard may be corrupted or unable to be played.
 - Press the **MENU** or **RETURN** button to exit the menu screen.

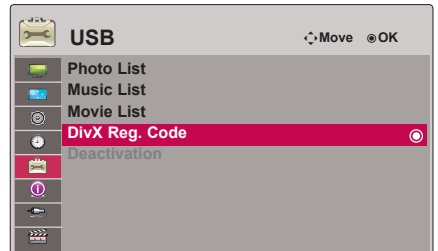

Deactivation Function

* Delete the existing authentication information to receive a new DivX user authentication for projector. Once this function is executed, a DivX user authentication is required again to see DivX DRM files.

1. Press the **MENU** button. Then, move to **USB** with the \wedge , \vee , \lt , \gt buttons and press the **OK** button.
2. Press the \wedge , \vee buttons to move to **Deactivation** and press the **OK** button.
3. Move to a desired item with the \lt , \gt buttons and then press the **OK** button.
 - DRM (Digital Rights Management) function:
These are the technology and the service that prevents the illegal use of digital contents to protect the copyrights owners' benefits and rights. File can be played after the license is cleared through the methods of online, etc.
 - Press the **MENU** or **RETURN** button to exit the menu screen.

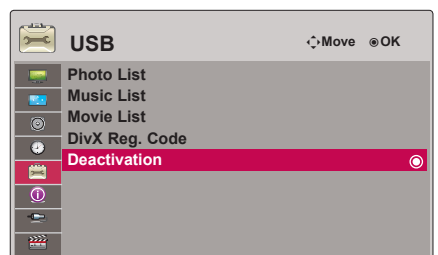

Supported Monitor Display

* The following table lists the display formats supported by the projector.

Format	Vertical Freq.(Hz)	Horizontal Freq.(kHz)
640X350	70.090	31.468
720X400	70.080	31.469
640X480	59.940	31.469
640X480	72.800	37.861
640X480	75.000	37.500
800X600	56.250	35.156
800X600	60.310	37.879
800X600	72.180	48.077
800X600	75.000	46.875
1024X768	60.000	48.363
1024X768	70.060	56.476
1024X768	75.020	60.023
1152X864	60.053	54.348
1280X768	59.870	47.776
1360X768	60.015	47.712
1280X960	60.000	60.000
1280X1024	60.020	63.981
1400X1050	59.979	65.317
1680X1050	60.000	65.300

* If the projector does not support the input signal, "Out of Range" message appears on the screen.

* The projector supports DDC1/2B type as Plug & Play function. (Auto recognition of PC monitor)

* PC synchronization signal types supported :Separate type synchronization.

<DVD/DTV Input>

Signal	Component-*1	HDMI-*2
NTSC(60Hz)	480i	O
	480p	O
	720p	O
	1080i	O
	1080p	O
PAL(50Hz)	576i	X
	576p	O
	720p	O
	1080i	O
	1080p	O
24 / 30 Hz	1080p	O

* Cable type
 1- RGB to Component Cable
 2- HDMI Cable

Maintenance

*The projector needs little maintenance. You should keep the lens clean because any dirt or stains may appear on the screen. If any parts need to be replaced, contact your dealer. When cleaning any part of the projector, always turn the power off and unplug the projector first.

Cleaning the lens

If there is any dust or stain on the surface of the lens, you must always clean the lens. Use an air spray or cleaning cloth for product exterior, provided with the product, to lightly clean the product. Please use a recommended air spray or lens cleaning product. To clean lens, small amount of cleaning agent on a swab or a soft cloth and rub on the lens. Please be aware that liquid may flow pass through the lens if the product is sprayed on lens directly.

Cleaning the Projector Case

To clean the projector case, first unplug the power cable. To remove dirt or dust, wipe the casing with polish cloth provided. When you want to remove the dust or stain on the lens, use the cloth for product exterior, provided with the product. Do not use alcohol, benzene, thinners or other chemical detergents as these can cause the casing to be warped or discolored.

How To Attach The Lens Cap To The Projector

- 1 Find the lens cap and the strap that were supplied as accessories.

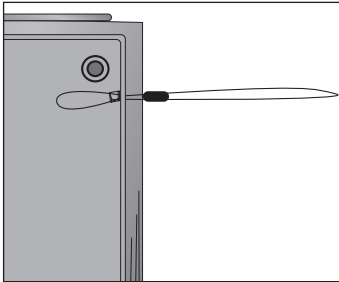

- 2 Insert the non-knot end of the strap into the hole at the bottom of the lens section of the projector.

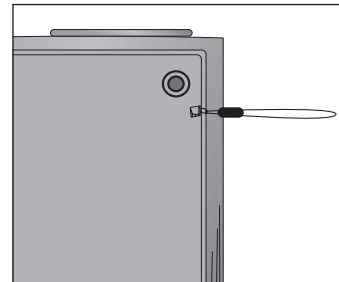

- 3 Attach the strap at the hole of the projector into the hole of the lens cap, and then pass the lens cap through the strap lasso.

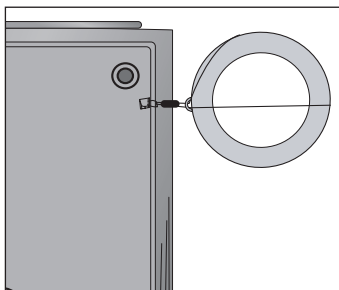

- 4 The strap and cap should look like the picture below.

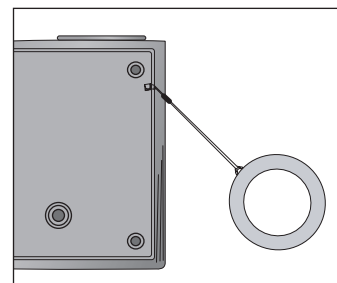

Specifications

MODEL	HS200 (HS200-JE) / HS200G (HS200G-JE) HS201 (HS201-JE) / HS201G (HS201G-JE)
Resolution	800(Horizontal) x 600(Vertical)pixel
Horizontal / Vertical Ratio	4:3(horizontal:vertical)
Panel size	0.55 inches
Screen size (Projection distance)	0.44 ~ 2.41m(15 ~ 80 inches)
Projection Offset	100%
Remote control distance	6m
Video compatibility	NTSC/PAL/SECAM/NTSC4.43/PAL-M/PAL-N/PAL-60
Power	19V $\overline{\text{---}}$, 4.74A
AC-DC Adapter	LG, PA-1900-08
Audio Output	1W + 1W
Height(mm/inches)	60/2.4 (without leg), 63/2.5 (with leg)
Width(mm/inches)	183/7.2
Length(mm/inches)	122/4.8
Weight(g/pound)	800/1.76
USB Device	5V, 0.5A (max)

Operating Condition

Temperature

In operation : 32~104°F(0°C~40°C)
In storage and transit : -4~140°F(-20°C~60°C)

Humidity

In operation : 0~ 80% relative humidity
Not in operation : 0 ~ 85% relative humidity

FM Transmitter Spec (HS200/HS200G only)

Frequency Band : 88.5~95.5 MHz
Channel Spacing : 200KHz
Transmission Power : Under 250uV



LG

Life's Good